

VOLUME

3

Sambrook  
Russell

*Molecular Cloning*  
THIRD EDITION



VOLUME

2

Sambrook  
Russell

*Molecular Cloning*  
THIRD EDITION



VOLUME

1

Sambrook  
Russell

*Molecular Cloning*  
THIRD EDITION

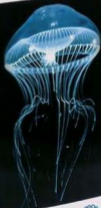


VOLUME 1

# Molecular Cloning

A LABORATORY MANUAL

THIRD EDITION



[www.MolecularCloning.com](http://www.MolecularCloning.com)

Sambrook and Russell



VOLUME 1

# Molecular Cloning

A LABORATORY MANUAL

THIRD EDITION



Sambrook and Russell





# Molecular Cloning

A LABORATORY MANUAL

---

THIRD EDITION

---

## Associate Authors

**Nina Irwin**

HARVARD MEDICAL SCHOOL AND CHILDREN'S HOSPITAL, BOSTON

**Kaaren A. Janssen**

COLD SPRING HARBOR LABORATORY

Managing Editor: Jan Argentine

Science Editor: Nina Irwin

Senior Developmental Editor: Kaaren A. Janssen

Developmental Editors: Sián Curtis and Michael Zierler

Project Coordinators: Maryliz Dickerson and Inez Sialiano

Permissions Editor: Nora McInerney

Production Editor: Dorothy Brown

Desktop Editor: Susan Schaefer

Prepress Technician: Danny deBruin

Interior Book Design: Ed Atkeson (Berg Design) and Denise Weiss

Cover Design: Ed Atkeson (Berg Design)

Original and Redrawn Illustrations: Mark D. Curtis

VOLUME 1

# Molecular Cloning

A LABORATORY MANUAL

---

THIRD EDITION

[www.MolecularCloning.com](http://www.MolecularCloning.com)

**Joseph Sambrook**

PETER MACCALLUM CANCER INSTITUTE AND THE UNIVERSITY OF MELBOURNE, AUSTRALIA

**David W. Russell**

UNIVERSITY OF TEXAS SOUTHWESTERN MEDICAL CENTER, DALLAS



COLD SPRING HARBOR LABORATORY PRESS  
Cold Spring Harbor, New York

# Molecular Cloning

A LABORATORY MANUAL

THIRD EDITION

©2001 by Cold Spring Harbor Laboratory Press, Cold Spring Harbor, New York

All rights reserved

Printed in the United States of America

**Front cover (paperback):** The gene encoding green fluorescent protein was cloned from *Aequorea victoria*, a jellyfish found in abundance in Puget Sound, Washington State. This picture of a 50-mm medusa was taken on color film by flash photography and shows light reflected from various morphological features of the animal. The small bright roundish blobs in the photograph are symbiotic amphipods living on or in the medusa. The bright ragged area in the center is the jellyfish's mouth.

Bioluminescence from *Aequorea* is emitted only from the margins of the medusae and cannot be seen in this image. Bioluminescence of *Aequorea*, as in most species of jellyfish, does not look like a soft overall glow, but occurs only at the rim of the bell and, given the right viewing conditions, would appear as a string of nearly microscopic fusiform green lights. The primary luminescence produced by *Aequorea* is actually bluish in color and is emitted by the protein aequorin. In a living jellyfish, light is emitted via the coupled green fluorescent protein, which causes the luminescence to appear green to the observer.

The figure and legend were kindly provided by Claudia Mills of the University of Washington, Friday Harbor. For further information, please see Mills, C.E. 1999–2000. Bioluminescence of *Aequorea*, a hydromedusa. Electronic Internet document available at <http://faculty.washington.edu/cemills/Aequorea.html>. Published by the author, web page established June 1999, last updated 23 August 2000.

**Back cover (paperback):** A portion of a human cDNA array hybridized with a red fluor-tagged experimental sample and a green fluor-tagged reference sample. Please see Appendix 10 for details. (Image provided by Vivek Mittal and Michael Wigler, Cold Spring Harbor Laboratory.)

Library of Congress Cataloging-in-Publication Data

Sambrook, Joseph.

Molecular cloning : a laboratory manual / Joseph Sambrook, David W.

Russell.-- 3rd ed.

p. ; cm.

Includes bibliographical references and index.

ISBN 0-87969-576-5 (cloth) -- ISBN 0-87969-577-3 (pbk)

I. Molecular cloning--Laboratory manuals.

[DNLM: 1. Cloning, Molecular--Laboratory Manuals. QH 440.5 S187m

2001] I. Russell, David W. (David William), 1954- . II. Title.

QH442.2 .S26 2001

572.8--dc21

00-064380

10 9 8 7 6 5 4 3 2 1

People using the procedures in this manual do so at their own risk. Cold Spring Harbor Laboratory makes no representations or warranties with respect to the material set forth in this manual and has no liability in connection with the use of these materials.

All World Wide Web addresses are accurate to the best of our knowledge at the time of printing.

Certain experimental procedures in this manual may be the subject of national or local legislation or agency restrictions. Users of this manual are responsible for obtaining the relevant permissions, certificates, or licenses in these cases. Neither the authors of this manual nor Cold Spring Harbor Laboratory assume any responsibility for failure of a user to do so.

The polymerase chain reaction process and other techniques in this manual may be or are covered by certain patent and proprietary rights. Users of this manual are responsible for obtaining any licenses necessary to practice PCR and other techniques or to commercialize the results of such use. COLD SPRING HARBOR LABORATORY MAKES NO REPRESENTATION THAT USE OF THE INFORMATION IN THIS MANUAL WILL NOT INFRINGE ANY PATENT OR OTHER PROPRIETARY RIGHT.

Authorization to photocopy items for internal or personal use, or the internal or personal use of specific clients, is granted by Cold Spring Harbor Laboratory Press, provided that the appropriate fee is paid directly to the Copyright Clearance Center (CCC). Write or call CCC at 222 Rosewood Drive, Danvers, MA 01923 (508-750-8400) for information about fees and regulations. Prior to photocopying items for educational classroom use, contact CCC at the above address. Additional information on CCC can be obtained at CCC Online at <http://www.copyright.com/>

All Cold Spring Harbor Laboratory Press publications may be ordered directly from Cold Spring Harbor Laboratory Press, 10 Skyline Drive, Plainville, New York 11803-2500. Phone: 1-800-843-4388 in Continental U.S. and Canada. All other locations: (516) 349-1930. FAX: (516) 349-1946. E-mail: [cshpress@cshl.org](mailto:cshpress@cshl.org). For a complete catalog of all Cold Spring Harbor Laboratory Press publications, visit our World Wide Web Site <http://www.cshl.org/>

For orders from Europe, the Middle East, and Africa, British pound pricing is provided. Orders are fulfilled and shipped from Cold Spring Harbor Laboratory Press-Europe c/o Lavis Marketing, 73 Lime Walk, Headington, Oxford OX3 2AD, U.K. Phone: +44 (0) 1865 741541. FAX: +044 (0)1865 750079. E-mail: [cshpress.europe@cshl.org](mailto:cshpress.europe@cshl.org). World Wide Web Site: <http://www.cshlpress.co.uk>

# Contents

---

Preface	xxi
Acknowledgments	xxiii
On-line Edition	xxv
Quotation Credits	xxvii

## Volume 1

### Chapter 1

### Plasmids and Their Usefulness in Molecular Cloning

---

1.1

#### INTRODUCTION

#### PROTOCOLS

Introduction to Preparation of Plasmid DNA by Alkaline Lysis with SDS (Protocols 1–3)	1.31
1 Preparation of Plasmid DNA by Alkaline Lysis with SDS: Minipreparation	1.32
2 Preparation of Plasmid DNA by Alkaline Lysis with SDS: Midipreparation	1.35
3 Preparation of Plasmid DNA by Alkaline Lysis with SDS: Maxipreparation	1.38
Introduction to Preparation of Plasmid DNA by Boiling Lysis (Protocols 4 and 5)	1.43
4 Preparation of Plasmid DNA by Small-scale Boiling Lysis	1.44
5 Preparation of Plasmid DNA by Large-scale Boiling Lysis	1.47
6 Preparation of Plasmid DNA: Toothpick Minipreparation	1.51
7 Preparation of Plasmid DNA by Lysis with SDS	1.55
8 Purification of Plasmid DNA by Precipitation with Polyethylene Glycol	1.59
9 Purification of Plasmid DNA by Chromatography	1.62
10 Purification of Closed Circular DNA by Equilibrium Centrifugation in CsCl-Ethidium Bromide Gradients: Continuous Gradients	1.65
11 Purification of Closed Circular DNA by Equilibrium Centrifugation in CsCl-Ethidium Bromide Gradients: Discontinuous Gradients	1.69
12 Removal of Ethidium Bromide from DNA by Extraction with Organic Solvents	1.72
13 Removal of Ethidium Bromide from DNA by Ion-exchange Chromatography	1.75
14 Removal of Small Fragments of Nucleic Acid from Preparations of Plasmid DNA by Centrifugation through NaCl	1.78
15 Removal of Small Fragments of Nucleic Acid from Preparations of Plasmid DNA by Chromatography through Sephacryl S-1000	1.80
16 Removal of Small Fragments of Nucleic Acid from Preparations of Plasmid DNA by Precipitation with Lithium Chloride	1.82
17 Directional Cloning into Plasmid Vectors	1.84

18	Attaching Adaptors to Protruding Termini	1.88
19	Blunt-ended Cloning into Plasmid Vectors	1.90
20	Dephosphorylation of Plasmid DNA	1.93
21	Addition of Synthetic Linkers to Blunt-ended DNA	1.98
22	Ligating Plasmid and Target DNAs in Low-melting-temperature Agarose	1.103
23	The Hanahan Method for Preparation and Transformation of Competent <i>E. coli</i> : High-efficiency Transformation	1.105
24	The Inoue Method for Preparation and Transformation of Competent <i>E. coli</i> : "Ultra-competent" Cells	1.112
25	Preparation and Transformation of Competent <i>E. coli</i> using Calcium Chloride	1.116
26	Transformation of <i>E. coli</i> by Electroporation	1.119
27	Screening Bacterial Colonies Using X-gal and IPTG; $\alpha$ -Complementation <ul style="list-style-type: none"> <li>• Alternative Protocol: Direct Application of X-gal and IPTG to Agar Plates</li> </ul>	1.123 1.125
28	Screening Bacterial Colonies by Hybridization: Small Numbers	1.126
29	Screening Bacterial Colonies by Hybridization: Intermediate Numbers <ul style="list-style-type: none"> <li>• Alternative Protocol: Rapid Lysis of Colonies and Binding of DNA to Nylon Filters</li> </ul>	1.129 1.131
30	Screening Bacterial Colonies by Hybridization: Large Numbers	1.132
31	Lysing Colonies and Binding of DNA to Filters	1.135
32	Hybridization of Bacterial DNA on Filters	1.138

#### INFORMATION PANELS

Chloramphenicol	1.143
Kanamycin	1.145
pBR322	1.146
Tetracycline	1.147
Ampicillin and Carbenicillin	1.148
X-gal	1.149
$\alpha$ -Complementation	1.149
Ethidium Bromide	1.150
Condensing and Crowding Reagents	1.152
Purification of Plasmid DNA by PEG Precipitation	1.152
Lysozymes	1.153
Polyethylene Glycol	1.154
Cesium Chloride and Cesium Chloride Equilibrium Density Gradients	1.154
DNA Ligases	1.157
Adaptors	1.160
Electroporation	1.162

## Chapter 2 Bacteriophage $\lambda$ and Its Vectors

2.1

#### INTRODUCTION

#### PROTOCOLS

1	Plating Bacteriophage $\lambda$	2.25
	• Additional Protocol: Plaque-Assay of Bacteriophages That Express $\beta$ -Galactosidase	2.30
	• Additional Protocol: Macroplaques	2.31



2	Picking Bacteriophage $\lambda$ Plaques	2.32
3	Preparing Stocks of Bacteriophage $\lambda$ by Plate Lysis and Elution	2.34
	• Alternative Protocol: Preparing Stocks of Bacteriophage $\lambda$ by Plate Lysis and Scraping	2.37
4	Preparing Stocks of Bacteriophage $\lambda$ by Small-scale Liquid Culture	2.38
5	Large-scale Growth of Bacteriophage $\lambda$ : Infection at Low Multiplicity	2.40
	• Alternative Protocol: Large-scale Growth of Bacteriophage $\lambda$ : Infection at High Multiplicity	2.42
6	Precipitation of Bacteriophage $\lambda$ Particles from Large-scale Lysates	2.43
7	Assaying the DNA Content of Bacteriophage $\lambda$ Stocks and Lysates by Gel Electrophoresis	2.45
8	Purification of Bacteriophage $\lambda$ Particles by Isopycnic Centrifugation through CsCl Gradients	2.47
	• Alternative Protocol: Purification of Bacteriophage $\lambda$ Particles by Isopycnic Centrifugation through CsCl Equilibration Gradients	2.51
9	Purification of Bacteriophage $\lambda$ Particles by Centrifugation through a Glycerol Step Gradient	2.52
10	Purification of Bacteriophage $\lambda$ Particles by Pelleting/Centrifugation	2.54
11	Extraction of Bacteriophage $\lambda$ DNA from Large-scale Cultures Using Proteinase K and SDS	2.56
12	Extraction of Bacteriophage $\lambda$ DNA from Large-scale Cultures Using Formamide	2.59
13	Preparation of Bacteriophage $\lambda$ DNA Cleaved with a Single Restriction Enzyme for Use as a Cloning Vector	2.61
14	Preparation of Bacteriophage $\lambda$ DNA Cleaved with Two Restriction Enzymes for Use as a Cloning Vector	2.64
15	Alkaline Phosphatase Treatment of Bacteriophage $\lambda$ Vector DNA	2.68
16	Purification of Bacteriophage $\lambda$ Arms: Centrifugation through Sucrose Density Gradients	2.71
17	Partial Digestion of Eukaryotic DNA for Use in Genomic Libraries: Pilot Reactions	2.76
18	Partial Digestion of Eukaryotic DNA for Use in Genomic Libraries: Preparative Reactions	2.80
19	Ligation of Bacteriophage $\lambda$ Arms to Fragments of Foreign Genomic DNA	2.84
20	Amplification of Genomic Libraries	2.87
21	Transfer of Bacteriophage DNA from Plaques to Filters	2.90
	• Alternative Protocol: Rapid Transfer of Plaques to Filters	2.95
22	Hybridization of Bacteriophage DNA on Filters	2.96
23	Rapid Analysis of Bacteriophage $\lambda$ Isolates: Purification of $\lambda$ DNA from Plate Lysates	2.101
	• Additional Protocol: Removing Polysaccharides by Precipitation with CTAB	2.105
24	Rapid Analysis of Bacteriophage $\lambda$ Isolates: Purification of $\lambda$ DNA from Liquid Cultures	2.106

## INFORMATION PANELS

Bacteriophages: Historical Perspective	2.109
Minimizing Damage to Large DNA Molecules	2.110
In Vitro Packaging	2.110

## Chapter 3 Working with Bacteriophage M13 Vectors 3.1

---

### INTRODUCTION

#### PROTOCOLS

- |   |  |      |
|---|--|------|
| 1 | Plating Bacteriophage M13  | 3.17 |
| 2 | Growing Bacteriophage M13 in Liquid Culture  | 3.20 |
| 3 | Preparation of Double-stranded (Replicative Form) Bacteriophage M13 DNA              | 3.23 |
| 4 | Preparation of Single-stranded Bacteriophage M13 DNA                                 | 3.26 |
| 5 | Large-scale Preparation of Single-stranded and Double-stranded Bacteriophage M13 DNA | 3.30 |
| 6 | Cloning into Bacteriophage M13 Vectors   | 3.33 |
| 7 | Analysis of Recombinant Bacteriophage M13 Clones                                     | 3.39 |
|   | • Alternative Protocol: Screening Bacteriophage M13 Plaques by Hybridization         | 3.41 |
| 8 | Producing Single-stranded DNA with Phagemid Vectors                                  | 3.42 |

#### INFORMATION PANELS

- |  |                     |      |
|--|---------------------|------|
|  | Growth Times        | 3.49 |
|  | Polyethylene Glycol | 3.49 |

## Chapter 4 Working with High-capacity Vectors 4.1

---

### INTRODUCTION

#### PROTOCOLS

- |    |  |      |
|----|--|------|
| 1  | Construction of Genomic DNA Libraries in Cosmid Vectors  | 4.11 |
| 2  | Screening an Unamplified Cosmid Library by Hybridization: Plating the Library onto Filters                   | 4.24 |
|    | • Additional Protocol: Reducing Cross-hybridization  | 4.27 |
| 3  | Amplification and Storage of a Cosmid Library: Amplification in Liquid Culture                               | 4.28 |
| 4  | Amplification and Storage of a Cosmid Library: Amplification on Filters                                      | 4.31 |
|    | • Alternative Protocol: Amplification on Plates  | 4.34 |
| 5  | Working with Bacteriophage P1 and Its Cloning Systems  | 4.35 |
|    | • Additional Protocol: Purification of High-molecular-weight DNA by Drop Analysis                            | 4.44 |
|    | • Alternative Protocol: Purification of High-molecular-weight Circular DNA by Chromatography on Qiagen Resin | 4.45 |
| 6  | Transferring P1 Clones between <i>E. coli</i> Hosts  | 4.46 |
| 7  | Working with Bacterial Artificial Chromosomes  | 4.48 |
| 8  | Isolation of BAC DNA from Small-scale Cultures   | 4.53 |
| 9  | Isolation of BAC DNA from Large-scale Cultures   | 4.55 |
| 10 | Working with Yeast Artificial Chromosomes  | 4.58 |
| 11 | Growth of <i>S. cerevisiae</i> and Preparation of DNA  | 4.67 |
| 12 | Small-scale Preparations of Yeast DNA  | 4.70 |
| 13 | Analyzing Yeast Colonies by PCR  | 4.72 |



- 14** Isolating the Ends of Genomic DNA Fragments Cloned in High-capacity Vectors: Vectors  
 Vectorette Polymerase Chain Reactions 4.74

### INFORMATION PANELS

- Cre-loxP*  
 Large-fragment Cloning Products and Services 4.82  
 4.86

## Chapter 5

# Gel Electrophoresis of DNA and Pulsed-field Agarose Gel Electrophoresis 5.1

---

### INTRODUCTION

#### PROTOCOLS

- 1** Agarose Gel Electrophoresis 5.4
  - 2** Detection of DNA in Agarose Gels 5.14
  - 3** Recovery of DNA from Agarose Gels: Electrophoresis onto DEAE-cellulose Membranes 5.18
  - 4** Recovery of DNA from Agarose and Polyacrylamide Gels: Electroelution into Dialysis Bags 5.23
  - 5** Purification of DNA Recovered from Agarose and Polyacrylamide Gels by Anion-exchange Chromatography 5.26
  - 6** Recovery of DNA from Low-melting-temperature Agarose Gels: Organic Extraction
    - Alternative Protocol: Recovery of DNA from Agarose Gels Using Glass Beads 5.29
  - 7** Recovery of DNA from Low-melting-temperature Agarose Gels: Enzymatic Digestion with Agarase 5.32  
 5.33
  - 8** Alkaline Agarose Gel Electrophoresis 5.36
    - Additional Protocol: Autoradiography of Alkaline Agarose Gels 5.39
  - 9** Neutral Polyacrylamide Gel Electrophoresis 5.40
  - 10** Detection of DNA in Polyacrylamide Gels by Staining 5.47
  - 11** Detection of DNA in Polyacrylamide Gels by Autoradiography 5.49
  - 12** Isolation of DNA Fragments from Polyacrylamide Gels by the Crush and Soak Method 5.51
- Introduction to Pulsed-field Gel Electrophoresis (Protocols 13–20) 5.55
- 13** Preparation of DNA for Pulsed-field Gel Electrophoresis: Isolation of DNA from Mammalian Cells and Tissues 5.61
  - 14** Preparation of DNA for Pulsed-field Gel Electrophoresis: Isolation of Intact DNA from Yeast 5.65
  - 15** Restriction Endonuclease Digestion of DNA in Agarose Plugs 5.68
  - 16** Markers for Pulsed-field Gel Electrophoresis 5.71
  - 17** Pulsed-field Gel Electrophoresis via Transverse Alternating Field Electrophoresis Gels
    - Alternative Protocol: Silver Staining PFGE Gels 5.74  
 5.77
  - 18** Pulsed-field Gel Electrophoresis via Contour-clamped Homogeneous Electric Field Gels 5.79
  - 19** Direct Retrieval of DNA Fragments from Pulsed-field Gels 5.83
  - 20** Retrieval of DNA Fragments from Pulsed-field Gels following DNA Concentration 5.86

## Chapter 6 Preparation and Analysis of Eukaryotic Genomic DNA 6.1

---

### INTRODUCTION

#### PROTOCOLS

- |    |  |      |
|----|--|------|
| 1  | Isolation of High-molecular-weight DNA from Mammalian Cells Using Proteinase K and Phenol        | 6.4  |
|    | • Additional Protocol: Estimating the Concentration of DNA by Fluorometry                        | 6.12 |
| 2  | Isolation of High-molecular-weight DNA from Mammalian Cells Using Formamide                      | 6.13 |
| 3  | Isolation of DNA from Mammalian Cells by Spooling  | 6.16 |
| 4  | Isolation of DNA from Mammalian Cells Grown in 96-well Microtiter Plates                         | 6.19 |
|    | • Additional Protocol: Optimizing Genomic DNA Isolation for PCR                                  | 6.22 |
| 5  | Preparation of Genomic DNA from Mouse Tails and Other Small Samples                              | 6.23 |
|    | • Alternative Protocol: Isolation of DNA from Mouse Tails without Extraction by Organic Solvents | 6.26 |
|    | • Alternative Protocol: One-tube Isolation of DNA from Mouse Tails                               | 6.26 |
|    | • Alternative Protocol: DNA Extraction from Paraffin Blocks                                      | 6.27 |
| 6  | Rapid Isolation of Mammalian DNA   | 6.28 |
| 7  | Rapid Isolation of Yeast DNA   | 6.31 |
|    | Introduction to Southern Hybridization (Protocols 8–10)  | 6.33 |
| 8  | Southern Blotting: Capillary Transfer of DNA to Membranes  | 6.39 |
| 9  | Southern Blotting: Simultaneous Transfer of DNA from a Single Agarose Gel to Two Membranes       | 6.47 |
| 10 | Southern Hybridization of Radiolabeled Probes to Nucleic Acids Immobilized on Membranes          | 6.50 |
|    | • Additional Protocol: Stripping Probes from Membranes   | 6.57 |
|    | • Additional Protocol: Hybridization at Low Stringency   | 6.58 |

#### INFORMATION PANELS

- |  |   |      |
|--|---|------|
|  | Formamide and Its Uses in Molecular Cloning | 6.59 |
|  | Spooling DNA (Historical Footnote)          | 6.61 |
|  | Rapid Hybridization Buffers                 | 6.61 |
|  | CTAB  | 6.62 |

## Chapter 7 Extraction, Purification, and Analysis of mRNA from Eukaryotic Cells 7.1

---

### INTRODUCTION

#### PROTOCOLS

- |   |   |     |
|---|---|-----|
| 1 | Purification of RNA from Cells and Tissues by Acid Phenol–Guanidinium Thiocyanate–Chloroform Extraction | 7.4 |
| 2 | A Single-step Method for the Simultaneous Preparation of DNA, RNA, and Protein from Cells and Tissues   | 7.9 |

- 3 Selection of Poly(A)<sup>+</sup> RNA by Oligo(dT)-Cellulose Chromatography 7.13
- 4 Selection of Poly(A)<sup>+</sup> RNA by Batch Chromatography 7.18
- Introduction to Northern Hybridization (Protocols 5–9) 7.21
- 5 Separation of RNA According to Size: Electrophoresis of Glyoxylated RNA through Agarose Gels 7.27
- 6 Separation of RNA According to Size: Electrophoresis of RNA through Agarose Gels Containing Formaldehyde 7.31
- 7 Transfer and Fixation of Denatured RNA to Membranes 7.35
  - Alternative Protocol: Capillary Transfer by Downward Flow 7.41
- 8 Northern Hybridization 7.42
- 9 Dot and Slot Hybridization of Purified RNA 7.46
- 10 Mapping RNA with Nuclease S1 7.51
- 11 Ribonuclease Protection: Mapping RNA with Ribonuclease and Radiolabeled RNA Probes 7.63
- 12 Analysis of RNA by Primer Extension 7.75

### INFORMATION PANELS

- How to Win the Battle with RNase 7.82
- Inhibitors of RNases 7.83
- Diethylpyrocarbonate 7.84
- Guanidinium Salts 7.85
- Nuclease S1 7.86
- Exonuclease VII 7.86
- Mung Bean Nuclease 7.87
- Promoter Sequences Recognized by Bacteriophage-encoded RNA Polymerases 7.87
- Actinomycin D 7.88

### INDEX, I.1

## Volume 2

### Chapter 8

## In Vitro Amplification of DNA by the Polymerase Chain Reaction

8.1

### INTRODUCTION PROTOCOLS

- 1 The Basic Polymerase Chain Reaction 8.18
- 2 Purification of PCR Products in Preparation for Cloning 8.25
- 3 Removal of Oligonucleotides and Excess dNTPs from Amplified DNA by Ultrafiltration 8.27
- Introduction to Cloning PCR Products (Protocols 4–7) 8.30
- 4 Blunt-end Cloning of PCR Products 8.32
- 5 Cloning PCR Products into T Vectors 8.35
- 6 Cloning PCR Products by Addition of Restriction Sites to the Termini of Amplified DNA 8.37
- 7 Genetic Engineering with PCR 8.42
- 8 Amplification of cDNA Generated by Reverse Transcription of mRNA (RT-PCR) 8.46

9	Rapid Amplification of 5' cDNA Ends (5'-RACE)	8.54
10	Rapid Amplification of 3' cDNA Ends (3'-RACE)	8.61
11	Mixed Oligonucleotide-primed Amplification of cDNA (MOPAC)	8.66
12	Rapid Characterization of DNAs Cloned in Prokaryotic Vectors	8.72
	• Additional Protocol: Screening Yeast Colonies by PCR	8.75
	• Additional Protocol: Screening Bacteriophage $\lambda$ Libraries	8.76
13	Long PCR	8.77
14	Inverse PCR	8.81
15	Quantitative PCR	8.86
16	Differential Display-PCR (DD-PCR)	8.96

### INFORMATION PANELS

Multiplex PCR	8.107
Taq DNA Polymerase	8.108
Hot Start PCR	8.110
Ribonuclease H	8.111
Terminal Transferase	8.111
Touchdown PCR	8.112
Use of Inosine in Degenerate Pools of Oligonucleotides Used for PCR	8.113
Universal Primers	8.113

## Chapter 9

### Preparation of Radiolabeled DNA and RNA Probes 9.1

#### INTRODUCTION

#### PROTOCOLS

1	Random Priming: Radiolabeling of Purified DNA Fragments by Extension of Random Oligonucleotides	9.4
2	Random Priming: Radiolabeling of DNA by Extension of Random Oligonucleotides in the Presence of Melted Agarose	9.9
	• Nick Translation: An Historical Note	9.12
3	Radiolabeling of DNA Probes by the Polymerase Chain Reaction	9.14
	• Additional Protocol: Asymmetric Probes	9.18
4	Synthesis of Single-stranded DNA Probes of Defined Length from Bacteriophage M13 Templates	9.19
5	Synthesis of Single-stranded DNA Probes of Heterogeneous Length from Bacteriophage M13 Templates	9.25
6	Synthesis of Single-stranded RNA Probes by In Vitro Transcription	9.29
	• Additional Protocol: Using PCR to Add Promoters for Bacteriophage-encoded RNA Polymerases to Fragments of DNA	9.36
7	Synthesis of cDNA Probes from mRNA Using Random Oligonucleotide Primers	9.38
8	Synthesis of Radiolabeled, Subtracted cDNA Probes Using Oligo(dT) as a Primer	9.41
9	Radiolabeling of Subtracted cDNA Probes by Random Oligonucleotide Extension	9.46
10	Labeling 3' Termini of Double-stranded DNA Using the Klenow Fragment of <i>E. coli</i> DNA Polymerase I	9.51
11	Labeling 3' Termini of Double-stranded DNA with Bacteriophage T4 DNA Polymerase	9.57
12	End Labeling Protruding 3' Termini of Double-stranded DNA with [ $\alpha$ - $^{32}$ P]Cordycepin 5' Triphosphate or [ $\alpha$ - $^{32}$ P]dideoxy ATP	9.60

- |           |  |      |
|-----------|--|------|
| <b>13</b> | Dephosphorylation of DNA Fragments with Alkaline Phosphatase                             | 9.62 |
| <b>14</b> | Phosphorylation of DNA Molecules with Protruding 5'-Hydroxyl Termini                     | 9.66 |
| <b>15</b> | Phosphorylation of DNA Molecules with Dephosphorylated Blunt Ends or Recessed 5' Termini | 9.70 |
| <b>16</b> | Phosphorylation of DNA Molecules with Protruding 5' Termini by the Exchange Reaction     | 9.73 |

**INFORMATION PANELS**

- |  |  |      |
|--|--|------|
|  | Nonradioactive Labeling of Nucleic Acids                                       | 9.76 |
|  | <i>E. coli</i> DNA Polymerase I and the Klenow Fragment                        | 9.82 |
|  | In Vitro Transcription Systems   | 9.87 |
|  | Isolating Differentially Expressed cDNAs by Differential Screening and Cloning | 9.89 |
|  | Alkaline Phosphatase   | 9.92 |

**Chapter 10****Working with Synthetic Oligonucleotide Probes** **10.1****INTRODUCTION****PROTOCOLS**

- |          |   |       |
|----------|---|-------|
| <b>1</b> | Purification of Synthetic Oligonucleotides by Polyacrylamide Gel Electrophoresis                                      | 10.11 |
| <b>2</b> | Phosphorylating the 5' Termini of Oligonucleotides  | 10.17 |
| <b>3</b> | Purification of Radiolabeled Oligonucleotides by Precipitation with Ethanol   | 10.20 |
| <b>4</b> | Purification of Radiolabeled Oligonucleotides by Precipitation with Cetylpyridinium Bromide                           | 10.22 |
| <b>5</b> | Purification of Radiolabeled Oligonucleotides by Size-exclusion Chromatography  | 10.25 |
| <b>6</b> | Purification of Radiolabeled Oligonucleotides by Chromatography on a Sep-Pak C <sub>18</sub> Column                   | 10.28 |
| <b>7</b> | Labeling of Synthetic Oligonucleotides Using the Klenow Fragment of <i>E. coli</i> DNA Polymerase I                   | 10.30 |
| <b>8</b> | Hybridization of Oligonucleotide Probes in Aqueous Solutions: Washing in Buffers Containing Quaternary Ammonium Salts | 10.35 |
| <b>9</b> | Empirical Measurement of Melting Temperature  | 10.38 |

**INFORMATION PANELS**

- |  |   |       |
|--|---|-------|
|  | Oligonucleotide Synthesis                         | 10.42 |
|  | Melting Temperatures                              | 10.47 |
|  | Methods Used to Purify Synthetic Oligonucleotides | 10.48 |

**Chapter 11****Preparation of cDNA Libraries and Gene Identification** **11.1****INTRODUCTION****PROTOCOLS**

- |          |  |       |
|----------|--|-------|
| <b>1</b> | Construction of cDNA Libraries   | 11.38 |
|          | Stage 1: Synthesis of First-strand cDNA Catalyzed by Reverse Transcriptase | 11.39 |
|          | Stage 2: Second-strand Synthesis   | 11.44 |



Stage 3: Methylation of cDNA	11.49
Stage 4: Attachment of Linkers or Adaptors	11.52
Stage 5: Fractionation of cDNA by Gel Filtration through Sepharose CL-4B	11.57
Stage 6: Ligation of cDNA to Bacteriophage $\lambda$ Arms	11.60
• Alternative Protocol: Ligation of cDNA into a Plasmid Vector	11.64
• Additional Protocol: Amplification of cDNA Libraries	11.65
<b>2 Construction and Screening of Eukaryotic Expression Libraries</b>	11.68
Stage 1: Construction of cDNA Libraries in Eukaryotic Expression Vectors	11.69
Stage 2: Screening cDNA Libraries Constructed in Eukaryotic Expression Vectors	11.75
<b>3 Exon Trapping and Amplification</b>	11.80
Stage 1: Construction of the Library	11.82
Stage 2: Electroporation of the Library into COS-7 Cells	11.87
Stage 3: Harvesting the mRNA	11.89
Stage 4: Reverse Transcriptase-PCR	11.91
Stage 5: Analysis of Clones	11.96
<b>4 Direct Selection of cDNAs with Large Genomic DNA Clones</b>	11.98

### INFORMATION PANELS

Commercial Kits for cDNA Synthesis and Library Construction	11.109
Mo-MLV Reverse Transcriptase	11.111
Homopolymeric Tailing	11.112
$\lambda$ gt10 and $\lambda$ gt11	11.113
Constructing cDNA Libraries from Small Numbers of Cells	11.114
In Vitro Packaging	11.115
COS Cells	11.116
Biotin	11.117
Magnetic Beads	11.120
Ligation-independent Cloning	11.123

## Chapter 12

### DNA Sequencing

### 12.1

#### INTRODUCTION

#### PROTOCOLS

<b>1 Generation of a Library of Randomly Overlapping DNA Inserts</b>	12.10
• Alternative Protocol: Preparation of Small Numbers of Single-stranded DNA Templates from Bacteriophage M13	12.23
• Additional Protocol: Preparation of Dephosphorylated Blunt-ended Bacteriophage M13 Vector DNA for Shotgun Cloning	12.24
<b>2 Preparing Denatured Double-stranded DNA Templates for Sequencing by Dideoxy-mediated Chain Termination</b>	12.26
• Additional Protocol: Rapid Denaturation of Double-stranded DNA	12.30
• Additional Protocol: Purification of Plasmid DNA from Small-scale Cultures by Precipitation with PEG	12.31
<b>3 Dideoxy-mediated Sequencing Reactions Using Bacteriophage T7 DNA Polymerase (Sequenase)</b>	12.32

4	Dideoxy-mediated Sequencing Reactions Using the Klenow Fragment of <i>E. coli</i> DNA Polymerase I and Single-stranded DNA Templates	12.40
5	Dideoxy-mediated Sequencing of DNA Using <i>Taq</i> DNA Polymerase	12.45
6	Cycle Sequencing: Dideoxy-mediated Sequencing Reactions Using PCR and End-labeled Primers	12.51
	• Additional Protocol: Cycle Sequencing Reactions Using PCR and Internal Labeling with [ $\alpha$ - $^{32}$ P]dNTPs	12.60
7	Chemical Sequencing	12.61
	• Alternative Protocol: Rapid Maxam-Gilbert Sequencing	12.70
	• Additional Protocol: Preparation of End-labeled DNA for Chemical Sequencing	12.73
8	Preparation of Denaturing Polyacrylamide Gels	12.74
9	Preparation of Denaturing Polyacrylamide Gels Containing Formamide	12.81
10	Preparation of Electrolyte Gradient Gels	12.83
11	Loading and Running DNA-sequencing Gels	12.85
12	Autoradiography and Reading of Sequencing Gels	12.90

### INFORMATION PANELS

Automated DNA Sequencing	12.94
Microtiter Plates	12.100
The Klenow Fragment of <i>E. coli</i> DNA Polymerase I	12.101
Preparation of Stock Solutions of Oligonucleotide Primers for DNA Sequencing	12.103
Sequenase	12.104
Conventional Chain-termination Sequencing of PCR-amplified DNA	12.106
Preparation of Stock Solutions of dNTPs and ddNTPs for DNA Sequencing	12.107
Glycerol in DNA Sequencing Reactions	12.108
Compressions in DNA Sequencing Gels	12.109
7-deaza-dGTP	12.111
Dichlorodimethylsilane	12.112
Reading an Autoradiograph	12.113
Electrical Mobility of DNA	12.114

## Chapter 13 Mutagenesis

13.1

### INTRODUCTION

#### PROTOCOLS

1	Preparation of Uracil-containing Single-stranded Bacteriophage M13 DNA	13.11
2	Oligonucleotide-directed Mutagenesis of Single-stranded DNA	13.15
3	In Vitro Mutagenesis Using Double-stranded DNA Templates: Selection of Mutants with <i>DpnI</i>	13.19
4	Oligonucleotide-directed Mutagenesis by Elimination of a Unique Restriction Site (USE Mutagenesis)	13.26
5	Rapid and Efficient Site-directed Mutagenesis by the Single-tube Megaprimer PCR Method	13.31
6	Site-specific Mutagenesis by Overlap Extension	13.36

- 7 Screening Recombinant Clones for Site-directed Mutagenesis by Hybridization to Radiolabeled Oligonucleotides 13.40
- Alternative Protocol: Screening Phagemid-containing Bacterial Colonies by Hybridization to Radiolabeled Oligonucleotides 13.47
  - Alternative Protocol: Detection of Defined Mutants by PCR 13.48
- 8 Detection of Mutations by Single-strand Conformational Polymorphism and Heteroduplex Analysis 13.49
- 9 Generation of Sets of Nested Deletion Mutants with Exonuclease III 13.57
- 10 Generation of Bidirectional Sets of Deletion Mutants by Digestion with BAL 31 Nuclease 13.62

#### INFORMATION PANELS

- BAL 31 13.68
- Exonuclease III 13.72
- Linker-scanning Mutagenesis 13.75
- Random Mutagenesis 13.78
- Alanine-scanning Mutagenesis 13.81
- Mutagenic Oligonucleotides 13.82
- Selecting against Wild-type DNA in Site-directed Mutagenesis 13.84
- N<sup>6</sup>-methyladenine, Dam Methylase, and Methylation-sensitive Restriction Enzymes 13.87
- Commercial Kits for Site-directed Mutagenesis 13.89
- Glycerol 13.90
- Mutation Detection 13.91

## Chapter 14

### Screening Expression Libraries

14.1

#### INTRODUCTION

#### PROTOCOLS

- 1 Screening Expression Libraries Constructed in Bacteriophage  $\lambda$  Vectors 14.4
- 2 Screening Expression Libraries Constructed in Plasmid Vectors 14.14
- 3 Removal of Cross-reactive Antibodies from Antiserum: Pseudoscreening 14.23
- Alternative Protocol: Adsorbing Antibodies with Lysates of Bacteriophage-infected Cells 14.25
- 4 Removal of Cross-reactive Antibodies from Antiserum: Incubation with *E. coli* Lysate 14.26
- 5 Removal of Cross-reactive Antibodies from Antiserum: Affinity Chromatography 14.28
- 6 Identifying DNA-binding Proteins in Bacteriophage  $\lambda$  Expression Libraries 14.31
- 7 Preparation of Lysates Containing Fusion Proteins Encoded by Bacteriophage  $\lambda$ : Lysogens: lysis of Bacterial Colonies 14.37
- 8 Preparation of Lysates Containing Fusion Proteins Encoded by Bacteriophage  $\lambda$ : Lytic Infections on Agar Plates 14.41
- 9 Preparation of Lysates Containing Fusion Proteins Encoded by Bacteriophage  $\lambda$ : Lytic Infections in Liquid Medium 14.44

#### INFORMATION PANELS

- Plasmid and Bacteriophage  $\lambda$  Expression Vectors 14.47
- Using Antibodies in Immunological Screening 14.50

#### INDEX, I.1



## Volume 3

## Chapter 15

Expression of Cloned Genes in *Escherichia coli*

15.1

**INTRODUCTION****PROTOCOLS**

- 1 Expression of Cloned Genes in *E. coli* Using IPTG-inducible Promoters 15.14
- 2 Expression of Cloned Genes in *E. coli* Using the Bacteriophage T7 Promoter 15.20
- 3 Expression of Cloned Genes in *E. coli* Using the Bacteriophage  $\lambda$   $p_L$  Promoter 15.25
- 4 Expression of Secreted Foreign Proteins Using the Alkaline Phosphatase Promoter (*phoA*) and Signal Sequence 15.30
  - Additional Protocol: Subcellular Localization of PhoA Fusion Proteins 15.35
- 5 Purification of Fusion Proteins by Affinity Chromatography on Glutathione Agarose 15.36
- 6 Purification of Maltose-binding Fusion Proteins by Affinity Chromatography on Amylose Resin 15.40
- 7 Purification of Histidine-tagged Proteins by Immobilized  $\text{Ni}^{2+}$  Absorption Chromatography 15.44
  - Alternative Protocol: Elution of Polyhistidine-tagged Proteins from Metal Affinity Columns Using Decreasing pH 15.47
  - Additional Protocol: Regeneration of NTA- $\text{Ni}^{2+}$ -Agarose 15.48
- 8 Purification of Expressed Proteins from Inclusion Bodies 15.49
  - Additional Protocol: Refolding Solubilized Proteins Recovered from Inclusion Bodies 15.53

**INFORMATION PANELS**

- Expression of Cloned Genes 15.55
- E. coli* Expression Systems 15.56
- LacZ Fusions 15.57
- Chaotropic Agents 15.60

## Chapter 16

## Introducing Cloned Genes into Cultured Mammalian Cells

16.1

**INTRODUCTION****PROTOCOLS**

- 1 DNA Transfection Mediated by Lipofection 16.7
  - Additional Protocol: Histochemical Staining of Cell Monolayers for  $\beta$ -Galactosidase 16.13
- 2 Calcium-phosphate-mediated Transfection of Eukaryotic Cells with Plasmid DNAs 16.14
  - Alternative Protocol: High-efficiency Calcium-phosphate-mediated Transfection of Eukaryotic Cells with Plasmid DNAs 16.19
- 3 Calcium-phosphate-mediated Transfection of Cells with High-molecular-weight Genomic DNA 16.21

- Alternative Protocol: Calcium-phosphate-mediated Transfection of Adherent Cells 16.25
- Alternative Protocol: Calcium-phosphate-mediated Transfection of Cells Growing in Suspension 16.26
- 4 Transfection Mediated by DEAE-Dextran: High-efficiency Method 16.27
  - Alternative Protocol: Transfection Mediated by DEAE-Dextran: Increased Cell Viability 16.32
- 5 DNA Transfection by Electroporation 16.33
- 6 DNA Transfection by Biolistics 16.37
  - Additional Protocol: Histochemical Staining of Cell Monolayers or Tissue for  $\beta$ -Glucuronidase 16.42
- 7 DNA Transfection Using Polybrene 16.43

### INFORMATION PANELS

- Cotransformation 16.47
- Selective Agents for Stable Transformation 16.48
- Lipofection 16.50
- Transfection of Mammalian Cells with Calcium Phosphate–DNA Coprecipitates 16.52
- Chloroquine Diphosphate 16.53
- Electroporation 16.54

## Chapter 17

### Analysis of Gene Expression in Cultured Mammalian Cells 17.1

#### INTRODUCTION PROTOCOLS

##### *Cis-acting Regions and Trans-acting Factors*

- 1 Mapping Protein-binding Sites on DNA by DNase I Footprinting 17.14
  - Alternative Protocol: Mapping Protein-binding Sites on DNA by Hydroxyl Radical Footprinting 17.12
- 2 Gel Retardation Assays for DNA-binding Proteins 17.13
  - Additional Protocol: Supershift Assays 17.17
  - Additional Protocol: Competition Assays 17.17
- 3 Mapping DNase-I-hypersensitive Sites 17.18

##### **Analysis of Primary Transcripts**

- 4 Transcriptional Run-on Assays 17.23

##### **Reporter Assays**

- Introduction to Reporter Assays: CAT, Luciferase, and  $\beta$ -galactosidase (Protocols 5–7) 17.30
- 5 Measurement of Chloramphenicol Acetyltransferase in Extracts of Mammalian Cells Using Thin-layer Chromatography 17.33
  - Alternative Protocol: Measurement of CAT by Extraction with Organic Solvents 17.40
  - Alternative Protocol: Measurement of CAT following Diffusion of Reaction Products into Scintillation Fluid 17.41
- 6 Assay for Luciferase in Extracts of Mammalian Cells 17.42

- Alternative Protocol: Using a Scintillation Counter to Measure Luciferase 17.46
- Alternative Protocol: Assay for Luciferase in Cells Growing in 96-well Plates 17.47
- 7 Assay for  $\beta$ -galactosidase in Extracts of Mammalian Cells 17.48

#### Inducible Systems

- 8 Tetracycline as Regulator of Inducible Gene Expression in Mammalian Cells 17.52
  - Stage 1: Stable Transfection of Fibroblasts with pTet-tTAk 17.60
  - Stage 2: Stable Transfection of Inducible tTA-expressing NIH-3T3 Cells with Tetracycline-regulated Target Genes 17.65
  - Stage 3: Analysis of Protein Expression in Transfected Cells 17.68
    - Alternative Protocol: Tetracycline-regulated Induction of Gene Expression in Transiently Transfected Cells Using the Autoregulatory tTA System 17.70
- 9 Ecdysone as Regulator of Inducible Gene Expression in Mammalian Cells 17.71

### INFORMATION PANELS

- Footprinting DNA 17.75
- Gel Retardation Assays 17.78
- Baculoviruses and Baculovirus Expression Systems 17.81
- Green Fluorescent Proteins 17.84
- Epitope Tagging 17.90
- Chloramphenicol Acetyltransferase Luciferase 17.94
- $\beta$ -galactosidase 17.96
- 17.97

## Chapter 18

### Protein Interaction Technologies

18.1

#### INTRODUCTION PROTOCOLS

- 1 Two-hybrid and Other Two-component Systems 18.6
  - Stage 1: Characterization of a Bait-LexA Fusion Protein 18.17
  - Alternative Protocol: Assay of  $\beta$ -galactosidase Activity by Chloroform Overlay 18.28
  - Stage 2: Selecting an Interactor 18.30
  - Stage 3: Second Confirmation of Positive Interactions 18.38
    - Alternative Protocol: Rapid Screen for Interaction Trap Positives 18.46
- 2 Detection of Protein-Protein Interactions Using Far Western with GST Fusion Proteins 18.48
  - Additional Protocol: Refolding of Membrane-bound Proteins 18.53
  - Alternative Protocol: Detection of Protein-Protein Interactions with Anti-GST Antibodies 18.54
- 3 Detection of Protein-Protein Interactions Using the GST Fusion Protein Pulldown Technique 18.55
- 4 Identification of Associated Proteins by Coimmunoprecipitation 18.60
- 5 Probing Protein Interactions Using GFP and Fluorescence Resonance Energy Transfer 18.69
  - Stage 1: Labeling Proteins with Fluorescent Dyes 18.80

Stage 2: Cell Preparation for FLIM-FRET Analysis	18.84
• Alternative Protocol: Preparation of Fixed Cells for FLIM-FRET Analysis	18.87
• Alternative Protocol: Microinjection of Live Cells	18.88
Stage 3: FLIM-FRET Measurements	18.90
6 Analysis of Interacting Proteins with Surface Plasmon Resonance Spectroscopy Using BIAcore	18.96
Stage 1: Preparation of the Capture Surface and Test Binding	18.104
Stage 2: Kinetic Analysis of the Antibody-Antigen Interaction	18.108

### INFORMATION PANELS

Filamentous Phage Display	18.115
Genomics and the Interaction Trap	18.123
Interaction Trap and Related Technologies	18.125

## Appendices

---

1 Preparation of Reagents and Buffers Used in Molecular Cloning, A1.1
2 Media, A2.1
3 Vectors and Bacterial Strains, A3.1
4 Enzymes Used in Molecular Cloning, A4.1
5 Inhibitors of Enzymes, A5.1
6 Nucleic Acids, A6.1
7 Codons and Amino Acids, A7.1
8 Commonly Used Techniques in Molecular Cloning, A8.1
9 Detection Systems, A9.1
10 DNA Array Technology, A10.1
11 Bioinformatics, A11.1
12 Cautions, A12.1
13 Suppliers, A13.1
14 Trademarks, A14.1
Appendix References, R1

### INDEX, I.1

# The *Molecular Cloning* Web Site: Access to the On-line Laboratory Manual

---

**T**HIS PRINT EDITION OF *MOLECULAR CLONING* is associated with a Web Site ([www.MolecularCloning.com](http://www.MolecularCloning.com)) that is evolving into an on-line laboratory manual.

When the site is launched, registered purchasers of the book will be able to:

- **Print Protocols:** Print the step-by-step instructions needed for each procedure, in an easy-to-read format for convenient use at the bench.
- **Search Protocols:** Search by title or by keyword to ensure comprehensive access to all relevant information.
- **Receive Announcements about Updates and Additions:** Receive e-mail alerts about peer-reviewed, new, and updated information that extends the scope of the manual and enhances the value of the existing protocols.
- **Share Experience:** Communicate with other protocol users through a moderated bulletin board.
- **Access Other On-line Resources:** Link with Medline and other databases of value to working scientists.

Other valuable functions and content will be added after the site is launched.

To register at [www.MolecularCloning.com](http://www.MolecularCloning.com):

1. Open the home page of the site.
2. Follow the registration procedure that begins on that page.
3. When prompted, enter the unique access code that is printed on the inside front cover of Volume 1 of *Molecular Cloning: A Laboratory Manual*.
4. When prompted, enter your e-mail address as your user name and a password of your choice.
5. Complete the registration procedure as requested.

The public pages of the site contain answers to FAQs about the registration procedure and a demonstration of the functions available to registered users. For additional assistance with registration, and for all other inquiries about the *Molecular Cloning* Web Site, please e-mail [molecular.cloning@cshl.org](mailto:molecular.cloning@cshl.org) or call 1-800-843-4388 (in the continental U.S. and Canada) or 516-349-1930 (all other locations) between 8:00 A.M. and 5:00 P.M. Eastern U.S. time.

# Chapter 1

---

## Plasmids and Their Usefulness in Molecular Cloning

### INTRODUCTION

### PROTOCOLS

Introduction to Preparation of Plasmid DNA by Alkaline Lysis with SDS (Protocols 1–3)	1.31
1 Preparation of Plasmid DNA by Alkaline Lysis with SDS: Minipreparation	1.32
2 Preparation of Plasmid DNA by Alkaline Lysis with SDS: Midipreparation	1.35
3 Preparation of Plasmid DNA by Alkaline Lysis with SDS: Maxipreparation	1.38
Introduction to Preparation of Plasmid DNA by Boiling Lysis (Protocols 4 and 5)	1.43
4 Preparation of Plasmid DNA by Small-scale Boiling Lysis	1.44
5 Preparation of Plasmid DNA by Large-scale Boiling Lysis	1.47
6 Preparation of Plasmid DNA: Toothpick Minipreparation	1.51
7 Preparation of Plasmid DNA by Lysis with SDS	1.55
8 Purification of Plasmid DNA by Precipitation with Polyethylene Glycol	1.59
9 Purification of Plasmid DNA by Chromatography	1.62
10 Purification of Closed Circular DNA by Equilibrium Centrifugation in CsCl-Ethidium Bromide Gradients: Continuous Gradients	1.65
11 Purification of Closed Circular DNA by Equilibrium Centrifugation in CsCl-Ethidium Bromide Gradients: Discontinuous Gradients	1.69
12 Removal of Ethidium Bromide from DNA by Extraction with Organic Solvents	1.72
13 Removal of Ethidium Bromide from DNA by Ion-exchange Chromatography	1.75
14 Removal of Small Fragments of Nucleic Acid from Preparations of Plasmid DNA by Centrifugation through NaCl	1.78
15 Removal of Small Fragments of Nucleic Acid from Preparations of Plasmid DNA by Chromatography through Sephacryl S-1000	1.80
16 Removal of Small Fragments of Nucleic Acid from Preparations of Plasmid DNA by Precipitation with Lithium Chloride	1.82
17 Directional Cloning into Plasmid Vectors	1.84
18 Attaching Adaptors to Protruding Termini	1.88
19 Blunt-ended Cloning into Plasmid Vectors	1.90
20 Dephosphorylation of Plasmid DNA	1.93
21 Addition of Synthetic Linkers to Blunt-ended DNA	1.98
22 Ligating Plasmid and Target DNAs in Low-melting-temperature Agarose	1.103
23 The Hanahan Method for Preparation and Transformation of Competent <i>E. coli</i> : High-efficiency Transformation	1.105



24	The Inoue Method for Preparation and Transformation of Competent <i>E. coli</i> : "Ultra-competent" Cells	1.112
25	Preparation and Transformation of Competent <i>E. coli</i> using Calcium Chloride	1.116
26	Transformation of <i>E. coli</i> by Electroporation	1.119
27	Screening Bacterial Colonies Using X-gal and IPTG: $\alpha$ -Complementation	1.123
	• Alternative Protocol: Direct Application of X-gal and IPTG to Agar Plates	1.125
28	Screening Bacterial Colonies by Hybridization: Small Numbers	1.126
29	Screening Bacterial Colonies by Hybridization: Intermediate Numbers	1.129
	• Alternative Protocol: Rapid Lysis of Colonies and Binding of DNA to Nylon Filters	1.131
30	Screening Bacterial Colonies by Hybridization: Large Numbers	1.132
31	Lysing Colonies and Binding of DNA to Filters	1.135
32	Hybridization of Bacterial DNA on Filters	1.138

### INFORMATION PANELS

Chloramphenicol	1.143
Kanamycins	1.145
pBR322	1.146
Tetracycline	1.147
Ampicillin and Carbenicillin	1.148
X-gal	1.149
$\alpha$ -Complementation	1.149
Ethidium Bromide	1.150
Condensing and Crowding Reagents	1.152
Purification of Plasmid DNA by PEG Precipitation	1.152
Lysozymes	1.153
Polyethylene Glycol	1.154
Cesium Chloride and Cesium Chloride Equilibrium Density Gradients	1.154
DNA Ligases	1.157
Adaptors	1.160
Electroporation	1.162

**P**LASMIDS ARE EXTRACHROMOSOMAL MOLECULES OF DNA that vary in size from 1 kb to more than 200 kb. Most of them are double-stranded, covalently closed, circular molecules that can be isolated from bacterial cells in a superhelical form. Plasmids:

- are found in a wide variety of bacterial species; most plasmids have a narrow host range and can be maintained only in a limited set of closely related species.
- are extrachromosomal elements that behave as accessory genetic units that replicate and are inherited independently of the bacterial chromosome.
- have evolved a variety of mechanisms to maintain a stable copy number of the plasmid in their bacterial hosts and to partition plasmid molecules accurately to daughter cells.
- are dependent, to a greater or lesser extent, on the enzymes and proteins encoded by their host for their replication and transcription.

- frequently contain genes coding for enzymes that are advantageous to the bacterial host. These genes specify a remarkably diverse set of traits, many of which are of great medical and commercial significance. Among the phenotypes conferred by plasmids are resistance to and production of antibiotics, degradation of complex organic compounds, and production of colicins, enterotoxins, and restriction and modification enzymes.

The word "plasmid," introduced by Joshua Lederberg in 1952, was defined as an extrachromosomal genetic element. It was supplanted for a while by "episome," a term proposed by Jacob and Wollman (1958) to describe an accessory genetic element that is transmissible from cell to cell and may be propagated either in the cytoplasm or, after insertion, as part of the bacterial chromosome. However, operational difficulties soon arose in deciding whether some extrachromosomal elements were plasmids, because they were never seen to insert into the host chromosome, or episomes that inserted at very low frequency. Hayes (1969) therefore suggested that the term episome "should be thanked for its services and sent into honourable retirement." This has not happened: Both words are now in common use, and the distinction between them has become blurred. However, most of the vectors discussed in this chapter are plasmids as defined by Lederberg and not episomes as defined by Jacob and Wollman. So, for readers who desire firm guidance in this matter, we say that "plasmid" is more correct than "episome" most of the time, but there are of course always exceptions.

## THE REPLICONS OF PLASMIDS DEFINE THEIR COPY NUMBER

A replicon is a genetic unit consisting of an origin of DNA replication and its associated control elements. In plasmids, the origin of replication is a defined segment of DNA several hundred base pairs in length: Its set of associated *cis*-acting controlling elements contains sites for diffusible plasmid- and host-encoded factors involved in initiation of DNA synthesis. A plasmid replicon can therefore be defined as the smallest piece of plasmid DNA that is able to replicate autonomously and maintain normal copy number.

The term "replicon" was first used at the 1963 Cold Spring Harbor Symposium (Jacob et al. 1964) in a theoretical paper explaining how circular, extrachromosomal DNA molecules in bacteria might replicate. Since then, many of the predictions of the original prokaryotic model have been validated by biochemical and genetic experiments, and the definition of replicon has expanded to include chromosomal and extrachromosomal replication units in both prokaryotes and eukaryotes.

More than 30 different replicons have been identified in plasmids. However, almost all plasmids used routinely in molecular cloning carry a replicon derived from pMB1, a plasmid originally isolated from a clinical specimen (Hershfield et al. 1974). Plasmids carrying the primeval pMB1 replicon (or its close relative, the colicin E1 [*colE1*] replicon [Balbas et al. 1986]) maintain between 15 and 20 copies in each bacterial cell. However, over the years, the pMB1/*colE1* replicon has been extensively modified to increase the copy number, and hence the yield, of plasmid DNA. High-copy-number plasmid vectors are available in huge variety, are the workhorses of molecular cloning, and are used for almost all routine manipulation of small segments of recombinant DNAs (<15 kb in size). By contrast, low-copy-number vectors, which carry replicons from sources other than pMB1/*colE1* (Table 1-1), are required for special purposes. These include (1) cloning of DNA sequences that are unstable and genes that are lethal when propagated in high-copy-number plasmids and (2) constructing bacterial artificial chromosomes (BACs), which are vectors used to propagate large (~100 kb) segments of foreign DNA as plasmids in *Escherichia coli* (please see Chapter 2).



**TABLE 1-1 Replicons Carried by Plasmid Vectors**

PLASMID	REPLICON	COPY NUMBER	REFERENCES
pBR322	pMB1	15–20	Bolivar et al. (1977b)
pUC	modified form of pMB1	500–700	Vieira and Messing (1982, 1987); Messing (1983); Lin-Chao et al. (1992)
pMOB45	pKN402	15–118	Bittner and Vapnek (1981)
pACYC	p15A	18–22	Chang and Cohen (1978)
pSC101	pSC101	~5	Stoker et al. (1982)
colE1	colE1	15–20	Kahn et al. (1979)

## REPLICATION OF PLASMIDS

### Stringent and Relaxed Replication

The copy number of a plasmid is defined as the average number of plasmids per bacterial cell or per chromosome under normal growth conditions. Controlled by the plasmid replicon, the copy number can increase or decrease within a narrow range in response to changes in the growth conditions of the bacterial culture. At steady state, the population of plasmid doubles at exactly the same rate as the population of host cells, and the copy number remains constant.

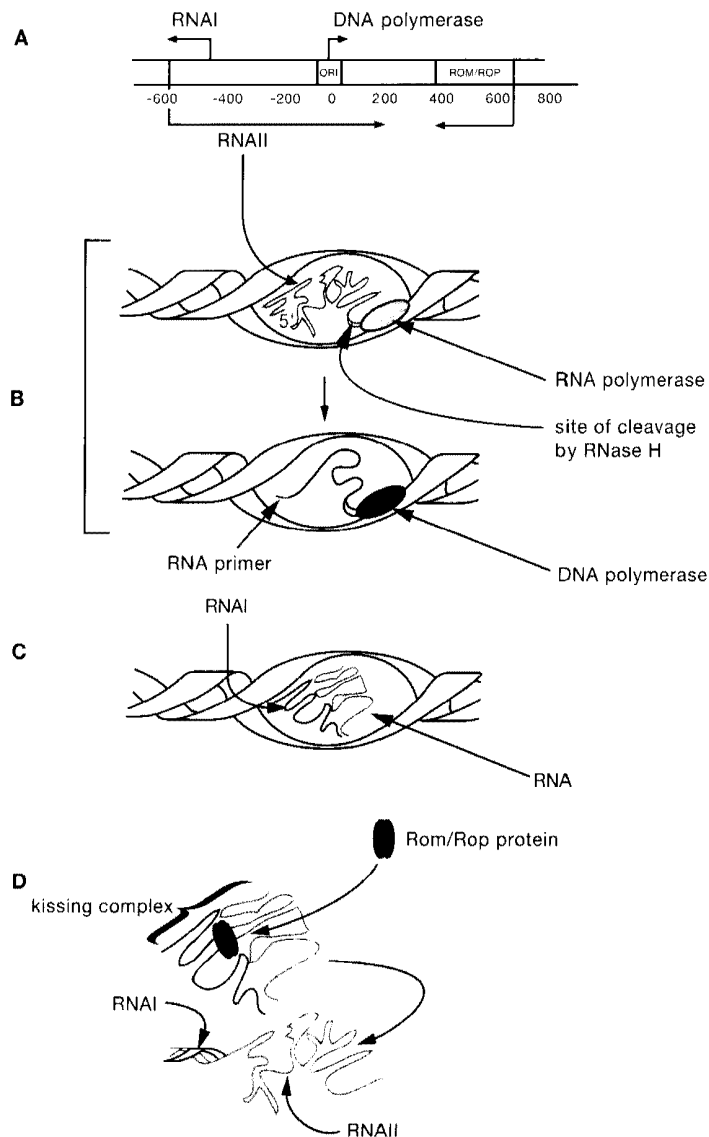
Plasmids, whatever their replicon, maintain harmony between their rate of replication and that of the host by rationing the supply of a molecule that affects the frequency of initiation of plasmid DNA synthesis. In plasmids carrying the pMB1/colE1 replicon, this positive regulatory molecule is an RNA, known as RNII, which is used to prime initiation of leading-strand DNA synthesis. However, the regulatory molecule of other replicons (e.g., pSC101) is a *cis*-acting protein (RepA) that acts positively on the origin of replication and negatively regulates the transcription of its own gene (Linder et al. 1985; for reviews, please see Nordström 1990; Nordström and Wagner 1994; Helinski et al. 1996). In all cases, the synthesis and activity of positive regulatory RNA and protein molecules are modulated by ancillary *trans*-acting products whose concentration is responsive to plasmid copy number or to alterations in the physiology of the host bacterium.

Plasmids whose positive regulatory molecule is an RNA molecule generally have high copy numbers and do not require any plasmid-encoded proteins for replication. Instead, they rely entirely on long-lived enzymes and proteins supplied by the host, including chaperones, DNA polymerases I and III, DNA-dependent RNA polymerase, ribonuclease H (RNase H), DNA gyrase, and topoisomerase I (for review, please see Helinski et al. 1996). These plasmids, which are said to replicate in a “relaxed” fashion, continue to duplicate when protein synthesis is inhibited by amino acid starvation (Bazaraal and Helinski 1968) or by addition of an antibiotic such as chloramphenicol (Clewell and Helinski 1969) (please see the information panel on **CHLORAMPHENICOL**). Because protein synthesis is required for initiation of each round of host DNA synthesis but not for plasmid replication, the content of plasmid DNA in cells exposed to chloramphenicol increases relative to the amount of chromosomal DNA (Clewell 1972). Over the course of several hours of amplification, thousands of copies of a relaxed plasmid may accumulate in the cell; at the end of the process, plasmid DNA may account for 50% or more of the total cellular DNA. By contrast, plasmids such as pSC101 require ongoing synthesis of the RepA protein for replication, and their copy number cannot be amplified, nor their yield increased, by inhibiting cellular protein synthesis. Such plasmids are said to replicate under “stringent” control.

## Initiation of DNA Synthesis at *colE1* Origins Is Primed by RNAII

Initiation occurs within a 600-nucleotide region that contains all of the *cis*-acting elements required for replication. Synthesis of leading-strand DNA is primed by RNAII (Figure 1-1) (for review, please see Eguchi et al. 1991).

Synthesis of the precursor to RNAII is initiated at a promoter 550 bp upstream of the origin, proceeds through the origin, and terminates at one of a number of closely spaced sites locat-



**FIGURE 1-1 DNA Synthesis at the *colE1* Replicon: Interaction between RNAI and RNAII**

(A) Genetic map of the *colE1* replicon with transcription patterns of this region. (B) RNAII serves as the primer for DNA synthesis at the *colE1* replicon. During synthesis of RNAII, the 5' region of the nascent molecule folds into a specific conformation that allows the growing 3' end to form a persistent DNA-RNA hybrid with the DNA template at the origin of replication. The 3' region of RNAII is processed by RNase H to generate a primer that is used for synthesis of the leading strand by DNA polymerase I. (C) The "kissing complex" between RNAI and RNAII is stabilized by binding of dimeric Rom/Rop protein. (D) Blow up of the "kissing complex" between RNAI and RNAII. The stable complex between RNAI and RNAII prevents DNA synthesis by suppressing the formation of the stable hybrid between RNAII and DNA.

ed ~150 nucleotides downstream. The 5' end of the ~750-nucleotide primary transcript folds into a complex secondary structure that brings a G-rich loop in RNAI into alignment with a C-rich stretch of plasmid DNA located 20 nucleotides upstream of the origin on the template strand. The RNAI transcript is then processed into mature primer by RNase H, which cleaves the RNA within a sequence of five A residues at the origin. The resulting 555-nucleotide mature RNAI is used as a primer by DNA polymerase I to initiate synthesis of the leading strand (for reviews and references, please see Kües and Stahl 1989; Cesareni et al. 1991; Helinski et al. 1996). Extension of the stable DNA-RNA hybrid exposes sites on the complementary strand of DNA at which discontinuous synthesis of the lagging strand is initiated. Because lagging-strand synthesis is blocked ~20 nucleotides upstream of the origin by the unhybridized segments of RNAI, replication progresses unidirectionally in Cairns or  $\theta$  structures in plasmids carrying pMB1/colE1 replicons.

### RNAI Is a Negative Regulator of Replication

The colE1 replicon is unable to influence the activity of the host enzymes required for plasmid replication and, therefore, is unable to alter the speed or course of events that occur after DNA synthesis has been initiated. Consequently, control of copy number must be exerted at or before initiation of DNA replication. Synthesis of plasmid DNA depends on the formation of a persistent DNA-RNAI hybrid at the origin of replication. Under normal circumstances, initiation is controlled by altering the equilibrium between correctly folded RNAI, which can form the persistent hybrid, and inappropriately folded structures of RNAI, which cannot.

Sway over this equilibrium lies chiefly in the hands of RNAI, a small transcript of 108 bases encoded by the antisense strand of the RNAI gene. RNAI folds into a cloverleaf structure that binds to the nascent RNAI precursor and thereby prevents its folding into the secondary structure required for formation of the persistent hybrid (Lacatena and Cesareni 1981).

The mechanism by which RNAI and RNAI interact has been described in great detail by Tomizawa and his colleagues (e.g., please see Tomizawa 1990a). The picture that emerges is one of dynamic interactions between RNAI and short-lived folding intermediates of RNAI. The folding of RNAI is particularly vulnerable to interference by RNAI when the nascent RNAI transcript is between 80 and 360 nucleotides in length. The initial contacts occur between stem-loops in the two RNA molecules and lead to formation of a segment of double-stranded RNA that involves the 5' sequences of RNAI and the entire length of RNAI. RNAI therefore controls plasmid copy number by acting as a negative regulator of initiation of plasmid DNA synthesis.

The copy number of the pUC family of plasmids is much higher than that of other plasmids carrying a pMB1 or colE1 replicon. This is because pUC plasmids carry a point mutation that alters the secondary structure of the positive regulatory molecule (RNAI) in a temperature-dependent fashion. At 37°C or 42°C, RNAI appears to fold into a conformation that is resistant to inhibition by RNAI. Initiation of DNA synthesis is enhanced, resulting in abnormally high copy number. When the bacterial culture is grown at 30°C, the copy number of pUC plasmids is restored to normal (Lin-Chao et al. 1992).

The simplest hypothesis to explain the maintenance of plasmid copy number is that the steady-state concentration of cytoplasmic RNAI is determined by gene dosage (Tomizawa 1987; Chiang and Bremer 1991). Thus, if the copy number of the plasmid increases above normal, the concentration of RNAI will rise and plasmid DNA replication will be inhibited. However, this coupling between plasmid copy number and fluctuations in inhibitor concentration can work only if the half-life of RNAI is short (Pritchard 1984) and if the rate of degradation of RNAI is proportional to the rate of growth of the culture. These two conditions both appear to be fulfilled

under normal conditions of cell growth, where the half-life of RNAI is 1–2 minutes. Kinetic calculations show that this period is sufficiently short for the molecule to act as a real-time sensor of plasmid copy number (Brendel and Perelson 1993).

Degradation of RNAI proceeds in two stages. First, the five 5′-terminal nucleotides are removed by endonucleolytic cleavage by RNase E. The truncated molecule can still bind to RNAII but is now susceptible to degradation by a ribonuclease whose activity is responsive to growth rate (Lin-Chao and Cohen 1991). This regulation provides a mechanism to maintain a constant number of plasmids even when the growth rate of cells is fitful.

### The Rom/Rop Protein Empowers the Negative Regulatory Activity of RNAI

The efficiency of binding of RNAI to RNAII is improved by a plasmid-encoded protein known as Rom (RNAI modulator) or Rop (repressor of primer). By improving the efficiency of hybrid formation between RNAI and RNAII, Rom enhances the negative regulatory action of RNAI. Accordingly, deletion of the *rom/rop* gene increases the copy number of *colE1* plasmids by at least two orders of magnitude (Twigg and Sherratt 1980). For example, deletion of the *rom/rop* genes raises the copy number of the old war horse pBR322 from 15–20 copies to more than 500 copies per bacterial cell, whereas insertion of a segment of foreign DNA into the *rom/rop* gene causes lethal runaway plasmid DNA replication (Giza and Huang 1989).

Rom is a homodimer of a 63-amino-acid polypeptide encoded by a gene lying 400 nucleotides downstream from the *colE1* origin of replication (Twigg and Sherratt 1980; Tomizawa and Som 1984). Each subunit of the dimer consists of two  $\alpha$  helices connected by a sharp bend; therefore, the dimer is a tight bundle of four  $\alpha$  helices exhibiting twofold symmetry (Banner et al. 1987). Rom binds to RNAI and RNAII with similar affinities (Helmer-Citterich et al. 1988) and drives unstable intermediates formed between the two complementary RNAs into a more stable structure (Lacatena et al. 1984; Tomizawa and Som 1984; Tomizawa 1990b). Most probably, each of the two subunits of Rom recognizes sequence and structural elements in both RNAI and RNAII. Rom binds to a stem on the interacting RNAs, stabilizing the “kissing” complex (Tomizawa 1985) and initiating formation of a perfect RNAI-RNAII hybrid (Eguchi and Tomizawa 1990).

## INCOMPATIBILITY OF PLASMIDS

When two plasmids share elements of the same replication machinery, they compete with each other during both replication and the subsequent step of partitioning into daughter cells. Such plasmids are unable to coexist without selection in bacterial cultures. This phenomenon is known as incompatibility (for reviews, please see Davison 1984; Novick 1987).

Plasmids carrying the same replicon belong to the same incompatibility group and are unable to be maintained within the same bacterium. Plasmids carrying replicons whose components are not interchangeable belong to different incompatibility groups and can be maintained in the same bacterium. Examples of plasmids that are compatible with *colE1*-type plasmids are p15A, R6K, and F.

Plasmids carrying the same replicon are selected at random from the intracellular pool for replication. However, this does not guarantee that the copy numbers of two plasmids will remain constant in a bacterial population. Larger plasmids, for example, require more time to replicate than do smaller plasmids and are at a selective disadvantage in every cell of the bacterial population. Plasmids of similar size may also be incompatible because of imbalances in the efficiency of initiation resulting from stochastic processes within individual bacterial cells. Such turns of

TABLE 1-2 Control Elements That Regulate Replication

INCOMPATIBILITY GROUPS	NEGATIVE CONTROL ELEMENT	COMMENT
colE1, pMB1	RNAI	controls processing of pre-RNAI into primer
IncFII, pT181	RNA	controls synthesis of RepA protein
P1, F, R6K, pSC101, p15A	iterons	sequesters RepA protein

chance can lead rapidly to drastic differences in the copy number of the two plasmids. In some cells, one plasmid might dominate, whereas in other cells, its incompatible partner might prosper. Over the course of a few generations of bacterial growth in the absence of selection, the minority plasmid may be completely eliminated from some cells of the population. Descendants of the original cell may contain one plasmid or the other, but very rarely both.

The regions of plasmid DNA that confer incompatibility can be identified by introducing segments of the DNA into an unrelated multicopy replicon and determining the ability of a test plasmid to coexist with the hybrid. For example, the incompatibility locus of the stringent, low-copy-number plasmid pSC101 maps to a series of directly repeated ~20-bp sequences known as iterons, located at the origin of replication. The iterons, in conjunction with the nearby *cis*-acting *par* locus, appear to “handcuff” plasmid DNA molecules by sequestering the plasmid-encoded RepA protein so that it can no longer facilitate binding of host-encoded proteins to the origin (for review, please see Nordström 1990). By contrast, in the case of colE1 described above, incompatibility is defined by the inhibitory activity of RNAI (for review, please see Novick 1987). Any two plasmids that are isogenic for RNAI and use it for regulation are incompatible, whether or not they share any other functions (Tomizawa and Itoh 1981).

As discussed earlier, most vectors in current use carry a replicon derived from the plasmid pMB1. These vectors are incompatible with all other plasmids carrying the colE1 replicon but are fully compatible with iteron-binding replicons such as those in pSC101 and its derivatives. Table 1-2 lists several well-known plasmids and negative control elements involved in regulating their replication.

## PLASMID VECTORS

### Selectable Markers

Plasmid vectors contain genetic markers that confer strong growth advantages upon plasmid-bearing bacteria under selective conditions. In molecular cloning, these markers are used:

- **To select clones of plasmid-bearing bacteria:** In the laboratory, plasmid DNA can be introduced into bacteria by the artificial process of transformation. However, even under the best conditions, transformation is generally inefficient, and plasmids become stably established in only a small minority of the bacterial population. Selectable markers carried by the plasmid allow these rare transformants to be selected with ease. These plasmid-encoded markers provide specific resistance to (i.e., the ability to grow in the presence of) antibiotics such as the kanamycins, ampicillin and carbenicillin, and the tetracyclines. The properties and modes of action of these antibiotics are discussed in information panels at the end of this chapter.
- **To indemnify transformed bacteria against the risks imposed by their burden of plasmid DNA or plasmid-encoded proteins:** Plasmids present at low copy numbers (<20 copies/cell) do not

appear to unduly handicap their host cells. However, much evidence shows that high-copy-number plasmids and large quantities of recombinant proteins can severely hamper the growth, and even the survival, of transformed cells (Murray and Kelley 1979; Beck and Bremer 1980). To prevent the emergence of bacteria from which the plasmid has been eliminated, it is important to sustain selective pressure by including the appropriate antibiotic in the culture medium at all times.

### 1973–1978

In the early 1970s, selectable markers, typically *kan<sup>r</sup>* or *amp<sup>r</sup>* or *tet<sup>r</sup>*, were introduced into plasmids carrying the pMB1 (or *colE1*) replicon (please see the information panels on **KANAMYCINS**, **TETRACYCLINE**, and **AMPICILLIN AND CARBENICILLIN**). The first plasmids used as cloning vectors — pSC101 (Cohen et al. 1973), *colE1* (Hershfield et al. 1974), and pCR1 (Covey et al. 1976) — were limited in their versatility: Either they replicated poorly or they carried unsuitable selectable markers, and none of them contained more than two restriction sites that could be used for cloning. The first plasmid to combine all of the then-available desirable features was pBR313 (Bolivar et al. 1977a,b; please see the information panel on **pBR322**). It replicated in a relaxed fashion, contained two selectable markers (*tet<sup>r</sup>* and *amp<sup>r</sup>*), and carried a number of useful restriction sites. However, pBR313 was unnecessarily large; more than half of its DNA was not essential for its role as a vector. The first phase of plasmid vector development ended with the construction of pBR322 (Bolivar et al. 1977b), a plasmid of 4.36 kb from which most of these unnecessary sequences had been eliminated. pBR322 was the most widely used cloning vehicle of its day, and many of the plasmid vectors in current use are its distant descendants (for review, please see Balbas et al. 1986).

### 1978–1983

This period saw the evolution of clunky plasmids such as pBR322 into vectors that were smaller in size, higher in copy number, and able to accept fragments of foreign DNA generated by cleavage with a wider range of restriction enzymes. There is no strict upper limit to the size of DNA fragments that can be cloned in plasmids. However, there are advantages in reducing the size of plasmid vectors to a minimum. Plasmid copy number, stability, and transforming efficiency all increase as the size of their DNA is reduced. Smaller plasmids can accommodate larger segments of foreign DNA before their efficiency begins to deteriorate. In addition, because smaller *colE1* plasmids replicate to higher copy numbers, the yield of foreign DNA is increased and hybridization signals are fortified when transformed colonies containing cloned foreign DNA sequences are screened with radiolabeled probes.

In the late 1970s and early 1980s, the problems of unwieldiness and inefficiency were addressed when streamlined derivatives of pBR322 were constructed. These plasmids lacked ancillary sequences involved in the control of copy number and mobilization. Unfortunately, the first-generation high-copy-number plasmids, of which pXf3 (Hanahan 1983) and pAT53 (Twiggs and Sherratt 1980) were the best known, suffered from a major defect: Foreign DNA sequences could be inserted only at a limited number of restriction sites located within the “natural” sequences used to construct the plasmid. Within a year or two, these plasmids had been replaced by a revolutionary series of vectors (pUC vectors), in which the number of restriction enzyme cleavage sites was expanded and their distribution within the vector was rationalized (Messing

1983; Norrander et al. 1983; Yanisch-Perron et al. 1985; Vieira and Messing 1987). The pUC vectors were the first plasmids to contain a closely arranged series of synthetic cloning sites, termed polylinkers, multiple cloning sites, or polycloning sites, that consist of banks of sequences recognized by restriction enzymes. In most cases, these restriction sites are unique; i.e., they are not found elsewhere in the plasmid vector. For example, the polycloning site from the vector pUC19 consists of a tandem array of unique cleavage sites for 13 restriction enzymes: *Hind*III, *Sph*I, *Pst*I, *Sal*I, *Acl*I, *Hinc*II, *Xba*I, *Bam*HI, *Sma*I, *Xma*I, *Kpn*I, *Sac*I, and *Eco*RI.

Such arrays of recognition sequences provide a vast variety of targets that can be used singly or in combination to clone DNA fragments generated by cleavage with a large number of restriction enzymes. Furthermore, fragments inserted at one restriction site can often be excised by cleavage of the recombinant plasmid with restriction enzymes that cleave at flanking sites. Insertion of a segment of DNA into a polycloning site is therefore equivalent to adding synthetic linkers to its termini. The availability of these flanking sites greatly simplifies the task of mapping the segment of foreign DNA.

A potential disadvantage of drawing together all cloning sites into one location in a plasmid is the inability to use inactivation of a selectable marker to screen for recombinants. This method had been used extensively with first-generation plasmids, such as pBR322, that carry two or more different selectable markers, e.g., *tet*<sup>r</sup> and *amp*<sup>r</sup>, each containing a “natural” restriction site. Insertion of foreign DNA sequences into one of these sites inactivated one of the two markers. Bacteria containing recombinant plasmids could therefore be distinguished from those carrying the empty parental vector by virtue of their ability to grow in only one of the two sets of selective conditions (please see the information panel on **AMPICILLIN AND CARBENICILLIN**).

Insertional inactivation is not possible with pUC vectors, which carry only one antibiotic resistance gene (typically *amp*<sup>r</sup>) and an aggregated set of cloning sites. However, recombinant plasmids can be readily distinguished from parental pUC plasmids by screening the color of bacterial colonies. pUC vectors and many of their derivatives carry a short segment of *E. coli* DNA that contains the regulatory sequences of the *lacZ* gene and the coding information for the amino-terminal 146 amino acids of  $\beta$ -galactosidase. Embedded in the coding information, just downstream from the initiating ATG, is a multiple cloning site. The small amino-terminal fragment of  $\beta$ -galactosidase expressed by pUC vectors in transformed bacteria has no endogenous  $\beta$ -galactosidase activity. However, the amino-terminal fragment, known as the  $\alpha$ -fragment, can complement certain mutants of  $\beta$ -galactosidase, which are themselves inactive, producing an enzyme that has abundant catalytic activity.  $\alpha$ -complementation occurs when pUC plasmids are introduced into strains of *E. coli* that express an inactive carboxy-terminal fragment (the  $\omega$ -fragment) of  $\beta$ -galactosidase.

When a segment of foreign DNA is cloned into the multiple cloning site of pUC vectors, the sequence encoding the  $\alpha$ -fragment is disrupted, and  $\alpha$ -complementation is either greatly suppressed or abolished altogether. Bacterial colonies containing recombinant plasmids are therefore *amp*<sup>r</sup> and contain little or no  $\beta$ -galactosidase activity. By contrast, bacterial colonies containing empty plasmids are *amp*<sup>r</sup> and are able to hydrolyze nonfermentable, chromogenic substrates such as 5-bromo-4-chloro-3-indole- $\beta$ -D-galactoside (X-gal) (Horwitz et al. 1964; Davies and Jacob 1968; please see the information panels on **X-GAL** and on  **$\alpha$ -COMPLEMENTATION**). The two types of colonies can therefore be distinguished by a simple, nondestructive histochemical test (Miller 1972). When X-gal is included in the agar medium, colonies carrying parental nonrecombinant plasmids become deep blue, whereas those containing recombinant plasmids either remain an ordinary creamy white or become tinted in pale egg-shell blue (for more details, please see the information panel on  **$\alpha$ -COMPLEMENTATION**).

## 1983–Present

The latest phase of construction of plasmid vectors has involved the incorporation of ancillary sequences that are used for a variety of purposes, including generation of single-stranded DNA templates for DNA sequencing, transcription of foreign DNA sequences *in vitro*, direct selection of recombinant clones, and expression of large amounts of foreign proteins. These specialized functions are discussed briefly here and in more detail in later chapters.

### *Plasmid Vectors Carrying Origins of Replication Derived from Single-stranded Bacteriophages*

Many plasmid vectors in current use carry the origin of DNA replication from the genome of a single-stranded filamentous bacteriophage such as M13 or f1 (please see Chapter 3). Such vectors, which are sometimes called phagemids, combine the best features of plasmid and single-stranded bacteriophage vectors and have the advantage of two separate modes of replication: as a conventional double-stranded DNA plasmid and as a template to produce single-stranded copies of one of the phagemid strands. A phagemid can therefore be used in the same way as an orthodox plasmid vector, or it can be used to produce filamentous bacteriophage particles that contain single-stranded copies of cloned segments of DNA. Since their introduction in the early 1980s, phagemids have eliminated much of the need to subclone segments of foreign DNA from plasmids into conventional single-stranded bacteriophage vectors.

Production of single-stranded DNA is induced when bacteria carrying a phagemid are infected with a helper bacteriophage that carries the genes required to (1) generate single-stranded DNA from a double-stranded template and (2) package the single-stranded DNA into filamentous virus particles. The defective filamentous virions secreted from a small-scale culture of infected bacteria contain sufficient single-stranded DNA for sequencing (please see Chapter 12; for preparation of radiolabeled single-stranded probes, please see Chapter 9 or for site-directed mutagenesis, please see Chapter 13).

In most cases, pairs of plasmid vectors are available that differ in the orientation of the bacteriophage origin of replication. The orientation of the origin determines which of the two DNA strands will be encapsidated into bacteriophage particles. By convention, a plus sign (+) indicates that the origin in the plasmid and that in the bacteriophage particle are in the same orientation. For more details on the design and use of phagemids, please see Chapter 3.

### *Plasmid Vectors Carrying Bacteriophage Promoters*

Many plasmid vectors carry promoters derived from bacteriophages T3, T7, and/or SP6 adjacent to the multiple cloning site (MCS). Foreign DNAs inserted at restriction sites within the MCS can therefore be transcribed *in vitro* when the linearized recombinant plasmid DNA is incubated with the appropriate DNA-dependent RNA polymerase and ribonucleotide precursors (please see Chapter 9). These promoters are so specific that RNA polymerase from SP6, for example, will not synthesize RNA from any other bacteriophage promoter located elsewhere in the plasmid.

Many commercial vectors (e.g., vectors of the pGEM series or the Bluescript series) carry two bacteriophage promoters in opposite orientations, located on each side of the multiple cloning site (Short et al. 1988). This organization allows RNA to be synthesized *in vitro* from either end and either strand of the foreign DNA, depending on the type of RNA polymerase used in the transcription reaction. The RNAs generated in this way can be used as hybridization probes or can be translated in cell-free protein-synthesizing systems. In addition, vectors carrying the T7



promoter can be used to express cloned DNA sequences in bacteria expressing T7 RNA polymerase (please see Chapter 9, Protocol 8) (Tabor and Richardson 1985).

### **Positive Selection Vectors**

Identifying plasmids with DNA inserts can be frustrating and time-consuming. However, a variety of cloning vectors have been developed that allow growth only of bacterial colonies carrying recombinant plasmids (for reviews, please see Burns and Beacham 1984; Hengen 1997). Bacteria containing the empty parental plasmid are unable to form colonies under selective conditions. Typically, the plasmids used in these systems express a gene product that is lethal for certain bacterial hosts; cloning a segment of foreign DNA into the plasmid inactivates the gene and relieves the toxicity. For example, Bochner et al. (1980), Maloy and Nunn (1981), and Craine (1982) describe conditions under which transformed bacteria carrying plasmid vectors coding for *tet<sup>r</sup>* will die, whereas recombinant plasmids carrying a segment of foreign DNA within the *tet<sup>r</sup>* gene will grow. Other conditionally lethal genes used in various positive selection vectors include those encoding the bacteriophage  $\lambda$  repressor (Nilsson et al. 1983; Mongolsuk et al. 1994), *EcoRI* methylase (Cheng and Modrich 1983), *EcoRI* endonuclease (Kuhn et al. 1986), galactokinase (Ahmed 1984), colicin E3 (Vernet et al. 1985), transcription factor GATA-1 (Trudel et al. 1996), the lysis protein of  $\phi$ X174 (Henrich and Plapp 1986), the *ccdB* gene of *E. coli* (Bernard 1995, 1996), and barnase (Yazynin et al. 1996). Ingenious as these positive selection systems may be, few of them have found wide use. In many cases, the number of potential cloning sites is limited, the efficiency of the selection may be variable, special host cells may be required, and the plasmids may be devoid of desirable features (e.g., bacteriophage promoters and bacteriophage M13 origin of DNA replication). In consequence, most investigators prefer to reduce the background of empty plasmids by other means, for example, by optimizing the ratio of vector DNA to insert in the ligation reaction, dephosphorylating the vector, or using directional cloning. Colonies containing the desired recombinant are then identified by hybridization in situ to radiolabeled probes, restriction analysis of small-scale preparations of plasmids, and/or polymerase chain reaction (PCR) amplification of inserts.

### **Low-copy-number Plasmid Vectors**

By contrast to conventional high-copy-number plasmid vectors, which carry souped-up versions of the *colE1* replicon, low-copy-number plasmid vectors are built around replicons such as R1 that keep plasmid DNA synthesis under a very tight rein.

The first generation of low-copy vectors — rather bulky and fairly rough-hewn by today's standards — was designed to solve problems of toxicity that arose when particular types of foreign genes and DNA sequences were cloned in plasmid vectors. Many genes coding for membrane and DNA-binding proteins fall into this class, as do certain promoters and regulatory sequences (e.g., please see Fiil et al. 1979; Hansen and von Meyenberg 1979; Little 1979; Murray and Kelley 1979; Beck and Bremer 1980; Spratt et al. 1980; Claverie-Martin et al. 1989). Sometimes, these DNA sequences and gene products are so toxic to the host bacteria that it is simply impossible to isolate transformed strains using high-copy-number vectors. If transformants are obtained, their growth rate is often frustratingly slow, and the cloned foreign DNA sequences are often unstable. To solve these problems, multipurpose low-copy-number vectors have been developed that carry tightly regulated prokaryotic promoters with a low level of basal expression, for example, the pET series of vectors, and prokaryotic transcription terminators to prevent spurious transcription of foreign DNA sequences from upstream plasmid promoters. These low-copy-number vectors now come equipped with multiple cloning sites, origins of replication of single-stranded bacterio-

phages, T3 and T7 promoters, and other useful modular conveniences of proven worth. Most modern low-copy-number vectors also carry *par* loci that promote accurate partitioning of plasmid molecules into daughter cells during cell division. Problems of plasmid instability may also be solved by using an *E. coli* strain that suppresses replication of *colE1* plasmids. Most strains of *E. coli* used as hosts for *colE1* plasmids carry a wild-type version of a gene known as *pcnB*, which codes for poly(A) polymerase. Wild-type *pcnB* promotes the decay of RNAI, the negative regulator of copy number of *colE1* plasmids, by adding adenylate residues to the 3' terminus of RNAI. In its polyadenylated form, RNAI is highly unstable and is therefore unable to prevent formation of RNAII, the primer for plasmid DNA synthesis. In strains of *E. coli* bearing a mutant *pcnB* allele, RNAI remains unadenylated and its half-life is extended. Processing of RNAII is suppressed and the copy number of *colE1* plasmids is thereby reduced by a factor of ~10. Many recombinant *colE1* plasmids that are unstable in conventional *E. coli* hosts can be grown successfully in *pcnB* mutant strains (He et al. 1993; Ellis et al. 1995; Podkovryov and Larson 1995; Pierson and Barcak 1999).

### **Runaway-replication Plasmid Vectors**

Runaway vectors replicate in a normal fashion at temperatures up to 34°C. However, their copy number increases as the temperature of the culture is raised until, at 39°C, plasmid replication becomes uncontrolled. Vectors based on the low-copy-number IncFII plasmid R1 have been converted to runaway-replication vectors by artificially increasing the rate of synthesis of *repA* mRNA, for example, by placing the *repA* gene under the control of the bacteriophage  $\lambda$   $p_R$  or  $p_L$  promoter. The activity of this promoter is in turn controlled by the temperature-sensitive  $\lambda$  repressor *cI857* (for review, please see Nordström and Uhlin 1992). Because runaway amplification occurs in the presence of protein synthesis, the expressed product of a foreign DNA cloned in a runaway plasmid may eventually constitute 50% of the protein in a bacterial cell in which plasmid replication has gone amok (e.g., please see Remaut et al. 1983).

Runaway plasmid replication and associated production of plasmid-encoded proteins place the cell under severe metabolic strain that is reflected in a decreased growth rate and, sometimes, cell death (Uhlin and Nordström 1978; Uhlin et al. 1979; Remaut et al. 1983). For this reason, it is important to ascertain the time of induction required to obtain maximal yields of the intact target protein.

### **Plasmid Expression Vectors**

A large number of plasmid vectors have been constructed that contain powerful promoters capable of generating large amounts of mRNA *in vivo* from cloned foreign genes. Nowadays, the activity of many of these promoters can be stringently regulated so that there is (1) minimal basal expression of the target gene under repressed conditions and (2) fast and dramatic induction of expression of the cloned gene in response to simple changes in the conditions of culture. For native proteins to be produced in large quantities, the vector must contain an efficient Shine-Dalgarno sequence upstream of the initiating ATG codon. The distance between the Shine-Dalgarno sequence and the ATG codon is crucial (Shine and Dalgarno 1975) if maximal expression of the foreign protein is to be achieved.

In many cases, plasmid expression vectors are designed to express foreign proteins that are not linked to any prokaryotic sequences; more commonly, however, expression vectors generate fusion proteins that are encoded partly by the vector and partly by an open reading frame in the cloned segment of foreign DNA. The foreign protein is therefore synthesized as a fused polypep-

tide containing a tract of amino acids that are not normally part of the native protein. In the early days of cloning, the tract of foreign amino acids was often large enough to produce dramatic changes in the physical and biological properties of the protein under study. Solubility and stability could be altered for better or worse, and there was a good chance that the biological properties of the protein would be compromised, at least to some extent.

During the last few years, the sequences contributed by the vector have shrunk dramatically in size. In most cases, they are less than a dozen residues in length and generally do not affect the function of the protein under study. Frequently, these “tags” are antigenic determinants (epitopes) that are recognized by specific antibodies. Epitope-tagged proteins can be purified with an existing epitope-specific antibody (for reviews, please see Kolodziej and Young 1991; Keesey 1996). The same antibody can be used to detect the epitope tag in a variety of expressed proteins.

The virtues and limitations of expressing proteins in these three forms — as native proteins, as fusion proteins, and as epitope-tagged proteins — are discussed in more detail in Chapter 18.

### Finding Plasmid Vectors Appropriate for Specific Tasks

When looking for common or garden-variety plasmids that can be used for a wide range of general purposes, the first port of call should be the catalogs of commercial suppliers. Often, these companies will have something with a suitable combination of markers, modules, cloning sites, and epitopes that can be used without extensive engineering. These off-the-shelf vectors have been tested under a wide variety of conditions in many laboratories. It does not take a rocket scientist to make them work well.

Unfortunately, there is no easy and certain way to search the literature for descriptions of plasmid vectors with unusual properties that are suited to particular purposes. Obviously, the ability to carry out Boolean searches of databases such as Medline, Entrez, and PubMed with the logic operators AND, OR, and NOT is a great advantage. For example, trawling most Medline-based databases with the string (p15A or IncFII)[TW] AND T7[TW] AND low-copy-number should generate a list of references to papers whose title includes “low-copy-number” and whose text contains the words “T7” and either “p15A” or “IncFII.” In addition, papers describing specialized or novel plasmid vectors are still published regularly in archival journals such as *Gene* and *BioTechnology*. Once one or two promising papers have been identified — either from the scientific literature or by Boolean searching — they can be used as starting points for an expanded search of databases for additional papers on the same or closely related topics. The PubMed system, which can be accessed via the Internet, is very good at assembling clusters of papers on topics related to a particular keyword. The address of PubMed is <http://www.ncbi.nlm.nih.gov/PubMed/>.

One never knows whether a vector unearthed from the literature will work as advertised and if it is actually the best currently available. The authors of the paper are usually able to offer sensible advice in this regard. However, beware if they start talking about making improvements to the published vector. This is a sure sign that the original vector did not work as well as advertised; the chances are that the improved version will not be much better. If possible, find out the names of other investigators who have used the vector and who may have found ways to identify and solve the problems.

### Choosing an Appropriate Strain of *E. coli*

Most investigators want to use strains of *E. coli* that are easy to transform with plasmid DNA (e.g., DH1 or MM294; for a full list of useful strains, please see Appendix 3). The vast majority of colE1-type plasmids introduced into these strains replicate to high copy number and can be iso-

lated in high yield. However, a significant minority of recombinant plasmids transform strains of *E. coli* such as DH1 and MM294 with low efficiency, generate transformed colonies that are smaller than usual, and produce low yields of plasmid DNA. Most of these "difficult" plasmids can be shown to encode a protein that is toxic to *E. coli* or to contain inverted or repeated DNA sequences.

The problem of toxic proteins can be alleviated by switching to an amplifiable low-copy-number vector or to a high-copy-number vector containing prokaryotic transcription termination signals that suppress readthrough transcription of foreign DNA sequences. Another possibility, however, is to use strains of *E. coli* that suppress the copy number of *colE1*-based plasmids. Several commercially available strains of *E. coli* (e.g., ABLE C and ABLE K strains from Stratagene) reduce the copy number of *colE1* plasmids (and hence the level of plasmid-encoded toxic proteins) by four- to tenfold. The yield of plasmid DNA from such strains, albeit reduced, is sufficient for most purposes in molecular cloning.

If there is reason to suspect that a plasmid may carry repeated DNA sequences that are substrates for the general recombination systems of *E. coli*, consider the possibility of switching to a recombination-deficient strain. For example, strains carrying a *recA* mutation have almost no recombination capacity (Weinstock 1987) and are the preferred hosts for many targeting vectors used in gene knock-out experiments in mice, such as vectors that contain two copies of a viral thymidine kinase gene. Wayward inserts can also be stabilized in strains carrying *recB* mutations, which inactivate exonuclease V and reduce general recombination to a few percent of normal. Finally, improved yields of certain plasmids have been reported in strains deficient in SOS repair or DNA repair that carry mutations in the *umuC* and *uvrC* genes (Doherty et al. 1993).

Inverted repeat sequences are often lethal to their carrier plasmid. Thus, recombinant plasmids containing perfect or near-perfect inverted repeats longer than ~300 bp fail to transform conventional host strains of *E. coli* or do so with very low efficiency. In many cases, the forced propagation of such clones provokes internal deletions or other rearrangements that remove the center of symmetry of the palindrome (e.g., please see Hagan and Warren 1983). Sequences containing head-to-head palindromes are lethal, perhaps because they inhibit DNA replication by interfering with the passage of replication forks or because they deleteriously affect the state of supercoiling of the plasmid, leaving it open to attack by nucleases (Collins and Hohn 1978; Lilley 1980; Collins 1981; Mizuuchi et al. 1982; Hagan and Warren 1983).

No strain of *E. coli* exists that is guaranteed to propagate all recombinant clones containing palindromic sequences. *E. coli* strains carrying mutations in *recBC* and *sbcBC* genes will support growth of plasmids containing certain palindromic sequences of a variety of sizes and sources. However, plasmids with a *colE1* origin are unstable in *recBC*, *sbcBC* hosts because they form linear multimers (e.g., please see Cohen and Clark 1986), which apparently interfere with replication and partition of chromosomal DNA (Kusano et al. 1989). Multimer formation is dependent on a subset of proteins involved in the RecF recombination pathway and does not occur in cells that are deficient in RecF, RecJ, RecA, RecO, or RecQ function.

Only a few strains deficient in *recBC* and *sbcBC* genes also contain mutations that eliminate all known restriction systems. These include PMC128, which is *mcrAΔ(mcrBC-hsd-mrr)recBC sbcBC* (Doherty et al. 1993), and SURE, and SRB (Stratagene), which carry similar mutations.

Finally, if plasmid vectors are used to propagate methylated DNA (e.g., mammalian genomic DNA or DNA synthesized *in vitro* using methylated analogs of deoxynucleoside triphosphates), then it is essential to use a strain that is deficient in the McrA, McrBC, and Mrr/Mcf restriction systems. The McrA and McrBC systems recognize and restrict certain DNA sequences containing methylated cytosine residues (Raleigh and Wilson 1986), whereas the Mrr/Mcf system recognizes

and restricts certain DNA sequences containing methylated adenine DNA residues (Heitman and Model 1987), as well as additional DNA sequences that contain methylated cytosine residues.

Further information on restriction modification systems can be obtained from REBASE, the Restriction Enzyme Database at <http://www.neb.com/rebase>. For more details on the properties of useful *E. coli* strains, see Appendix 3.

## EXTRACTION AND PURIFICATION OF PLASMID DNA

---

Many methods have been developed to purify plasmids from bacteria. These methods invariably involve three steps:

- growth of the bacterial culture
- harvesting and lysis of the bacteria
- purification of the plasmid DNA

### Growth of the Bacterial Culture

Wherever possible, plasmids should be purified from bacterial cultures that have been inoculated with a single transformed colony picked from an agar plate. Usually, the colony is transferred to a small starter culture, which is grown to late log phase. Aliquots of this culture can be used to prepare small amounts of the plasmid DNA (minipreparation) for analysis and/or as the inoculum for a large-scale culture. The conditions of growth of the large-scale culture depend chiefly on the copy number of the plasmid and whether it replicates in a stringent or relaxed fashion (please see Table 1-3). At all times, the transformed bacteria should be grown in selective conditions, i.e., in the presence of the appropriate antibiotic.

### Harvesting and Lysis of the Culture

Bacteria are recovered by centrifugation and lysed by any one of a large number of methods, including treatment with nonionic or ionic detergents, organic solvents, alkali, and heat. The choice among these methods is dictated by three factors: the size of the plasmid, the strain of *E. coli*, and the technique used subsequently to purify the plasmid DNA. Although it is impractical to give precise conditions for all possible combinations of plasmid and host, the following general guidelines can be used to choose a method that will give satisfactory results.

#### ***Large Plasmids (> 15 kb in Size) Must Be Handled with Care***

Plasmids >15 kb in size are susceptible to damage during both cell lysis and subsequent handling. Gentle lysis is best accomplished by suspending the bacteria in an isosmotic solution of sucrose and treating them with lysozyme and EDTA (ethylenediaminetetraacetic acid), which removes much of the cell wall. The resulting spheroplasts are lysed by adding an anionic detergent such as SDS. For methods for tender handling of large DNAs, please see the information panel on **MINIMIZING DAMAGE TO DNA MOLECULES** in Chapter 2.

#### ***Smaller Plasmids (< 15 kb in Size) Are More Durable***

When handling smaller plasmids, more severe methods of lysis can be used, and no special care need be taken to minimize shearing forces. Typically, bacterial suspensions are exposed to deter-

TABLE 1-3 Plasmid Growth and Replication

REPLICON (EXAMPLE)	COPY NUMBER	STRINGENT OR RELAXED	COMMENTS
Modified pMB1 (pUC)	several hundred	relaxed	pUC plasmids contain a modified pMB1 replicon and replicate to a very high copy number. Further amplification of the copy number by addition of chloramphenicol to the growing bacterial culture is unnecessary; instead, the culture should be grown to late log phase with vigorous shaking.
colE1 (pBR322)	15–20	relaxed	The yield of pBR322 and other relaxed plasmids that maintain a low-moderate copy number in transformed cells can be dramatically increased by adding chloramphenicol (final concentration 170 µg/ml) to mid-log phase cultures and continuing incubation for a further 8 hours. Chloramphenicol inhibits host protein synthesis and, as a result, prevents replication of the host chromosome. However, replication of relaxed plasmids continues, and their copy number increases progressively for several hours.
pSC101 (pSC101)	~5	stringent	Stringently replicating, low-copy-number plasmids can be a challenge to grow. Obviously, adding chloramphenicol to the culture is not an option and the only available variable is the culture medium. For example, "Terrific Broth," which has been reported to increase the yield of difficult plasmids (Tartof and Hobbs 1987) might be a better option than standard Luria Broth (LB).

As discussed above, the copy numbers of the current generation of plasmids are now so high that selective amplification in the presence of chloramphenicol is no longer required to achieve high yields of plasmid DNA. However, some investigators continue to use chloramphenicol, not necessarily to increase the yield of plasmid DNA but to reduce the bulk of bacterial cells in large-scale preparations. Handling large quantities of viscous lysates of concentrated suspensions of bacteria is a frustrating and messy business that can be avoided if chloramphenicol is added to the culture at mid-log phase. Because some amplification of copy number — even of such feverishly replicating plasmids as pUC — occurs in the presence of chloramphenicol, equivalent yields of plasmid DNA are obtained from smaller numbers of cells that have been exposed to the drug as from larger number of cells that have not.

gent and lysed by boiling or treatment with alkali. This disrupts base pairing and causes the linear stretches of sheared or disrupted chromosomal DNA of the host to denature. However, the strands of closed circular plasmid DNA are unable to separate from each other because they are topologically intertwined. When conditions are returned to normal, the strands of plasmid DNA fall into perfect register and native superhelical molecules are re-formed.

Prolonged exposure to denaturing conditions causes closed circular DNA to enter an irreversibly denatured state (Vinograd and Lebowitz 1966). The resulting collapsed coil, which cannot be cleaved with restriction enzymes, migrates through agarose gels at about twice the rate of native superhelical closed circular DNA and stains poorly with intercalating dyes such as ethidium bromide. Varying amounts of this collapsed form of DNA can usually be seen in plasmids prepared by alkaline or thermal lysis of bacteria.

### ***Some Strains of E. coli Should Not Be Lysed by Heat***

Some strains of *E. coli*, particularly those derived from HB101, release relatively large amounts of carbohydrate when they are lysed by detergent and heat. This can be a nuisance when the plasmid DNA is subsequently purified by equilibrium centrifugation in cesium chloride (CsCl)-ethidium bromide gradients. The carbohydrate forms a dense fuzzy band close to the place in the

gradient ( $\rho = 1.59$ ) occupied by the superhelical plasmid DNA. It is therefore difficult to avoid contaminating the plasmid DNA with carbohydrate, which inhibits the activity of many restriction enzymes and polymerases. Boiling should therefore not be used when making large-scale preparations of plasmids from strains of *E. coli* such as HB101 and TG1.

The boiling method also is not recommended when making small-scale plasmid preparations from strains of *E. coli* that express endonuclease A (*endA*<sup>+</sup> strains), which include HB101. Because endonuclease A is not completely inactivated by the boiling procedure, the plasmid DNA is degraded during subsequent incubation in the presence of Mg<sup>2+</sup> (e.g., during incubation with restriction enzymes). This problem can be avoided by including an extra step — extraction with phenol:chloroform — in the purification protocol.

## Purification of the Plasmid DNA

All three methods of lysis yield preparations of plasmid DNA that are always contaminated with considerable quantities of RNA and variable amounts of *E. coli* chromosomal DNA. Crude preparations of plasmid DNA can be readily visualized in agarose gels and can be used as templates and substrates for most restriction enzymes and DNA polymerases. However, contaminants must be removed — or at least reduced to manageable levels — whenever purified plasmids are necessary or desirable, for example, when transfecting mammalian cells.

For the last 20 years, descriptions of “new” purification schemes have appeared in the scientific literature at an average rate of one a week. Notwithstanding the virtues claimed by their inventors, very few of these methods have found widespread acceptance. Many of them, in fact, are but minor variations or questionable embellishments of much older methods. By and large, these original older methods are entirely satisfactory and they continue to find widespread use.

Old or new, all schemes for purification of plasmids take advantage of the relatively small size and covalently closed structure of plasmid DNA. The most venerable method for separating closed circular plasmid DNA from contaminating fragments of bacterial DNA is buoyant density centrifugation in gradients of CsCl-ethidium bromide (Clewell and Helinski 1969). This technique is still regarded as the standard against which all others should be judged. Separation depends on differences in the amounts of ethidium bromide that can be bound to linear and closed circular DNA molecules. Ethidium bromide binds very tightly to DNA in concentrated salt solutions. The dye intercalates between the bases, causing the double helix to unwind and leading to an increase in length of double-stranded linear or relaxed circular DNA molecules (for review, please see Vinograd and Lebowitz 1966). Closed circular DNA molecules have no free ends and can unwind only by twisting. As more and more ethidium bromide molecules intercalate into the DNA, the density of superhelical twists becomes so great that the addition of further ethidium bromide is prevented. Linear molecules, which are not constrained, continue to bind ethidium bromide until saturation is reached (an average of one ethidium bromide molecule for every 2.5 bp; Cantor and Schimmel 1980). Binding of ethidium bromide causes a decrease in the buoyant density of both linear and closed circular DNAs. However, because linear DNAs bind more ethidium bromide, they have a lower buoyant density than closed circular DNAs in CsCl gradients containing saturating amounts of ethidium bromide (linear double-stranded DNAs, 1.54 g/cm<sup>3</sup>; closed circular DNAs, 1.59 g/cm<sup>3</sup>). Closed circular DNAs therefore come to equilibrium at a lower position than linear DNAs in CsCl gradients containing saturating amounts of ethidium bromide (for a more detailed discussion, please see the information panel on **ETHIDIUM BROMIDE**).

For many years, equilibrium centrifugation in CsCl-ethidium bromide gradients was the method of choice to prepare large amounts of plasmid DNA. However, this process is time-consuming (3–5 days) and requires expensive equipment and reagents. Today, equilibrium centrifuga-



gation is used chiefly for the purification of (1) very large plasmids that are vulnerable to nicking, (2) closed circular DNAs that are to be microinjected into mammalian cell, and (3) plasmids that are used for biophysical measurements. Nowadays, less expensive and faster methods are available to purify smaller plasmids (<15 kb) for use as substrates and templates in all enzymatic reactions and procedures commonly undertaken in molecular cloning. The great majority of these purification schemes rely on differential precipitation, ion-exchange chromatography, or gel filtration to separate plasmid DNA from cellular nucleic acids.

A variety of kits for plasmid purification are available from commercial vendors. These kits consist of disposable chromatography columns that are used for batch absorption and elution of plasmid DNA. Many different matrices are available, including glass, diatomaceous earth, and, most popular of all, anionic resins such as DEAE (diethylaminoethyl) or QAE (diethyl[2-hydroxypropyl]aminoethyl). It is certainly a convenience to have the necessary buffers, resins, and disposable columns ready for use. However, this convenience comes at a price and one must wonder whether it is worthwhile to use on a routine basis expensive kits that do not perform significantly better than standard reagents which can easily be prepared in bulk by any competent laboratory worker. Certainly, kits are unnecessary for minipreparations of plasmid DNA to be used for routine analysis. Of the hundreds of methods to purify plasmid DNA described in the literature, the alkaline lysis method (Birnboim and Doly 1979; Ish-Horowicz and Burke 1981) is by far the most popular because of its simplicity, relatively low cost, and reproducibility. Alkaline lysis has been used successfully for more than 20 years in hundreds of laboratories to generate millions of minipreparations. For larger-scale preparations, the method of choice is alkaline lysis followed by differential precipitation of plasmid DNA with polyethylene glycol (Lis 1980; R. Treisman, unpubl.), which yields DNAs that are clean enough for transfection of mammalian cells and all enzymatic reactions, including DNA sequencing. In those rare circumstances where ultrapure closed circular DNA is required (e.g., for microinjection into mammalian cells), there is a choice between using centrifugation to equilibrium in CsCl-ethidium bromide gradients or a commercial kit. If choosing to use a kit, follow the manufacturer's instructions precisely as their protocol has presumably been tested extensively and optimized.

## CLONING IN PLASMID VECTORS

---

In principle, cloning in plasmid vectors is very straightforward. Closed circular plasmid DNA is cleaved with one or more restriction enzymes and ligated *in vitro* to foreign DNA bearing compatible termini. The products of the ligation reaction are then used to transform an appropriate strain of *E. coli*. The resulting transformed colonies are screened by hybridization, by PCR, or by digestion with restriction enzymes to identify those that carry the desired DNA sequences.

This sounds easy enough. However, planning and thought are required if cloning in plasmid vectors is to be as smooth in practice as in prospect. Before a pipette is lifted, decisions must be made about:

- the choice of a plasmid vector suitable for the task at hand
- the choice of restriction sites within vector
- the optimal conditions for the ligation reaction
- the strain of *E. coli* best suited to propagate a plasmid carrying the foreign DNA of interest
- the methods used to screen transformants and the techniques used to validate clones of interest

- whether special steps are required to decrease the background of transformed colonies that contain “empty” parental plasmid
- the controls that are necessary at each stage

After these matters have been settled, the next step is to make a detailed plan and a timetable so that fragments, plasmids, competent cells, and probes can be prepared in the correct order and in good time. In most cases, several different strategies can be used to create a particular recombinant in a plasmid vector. It is important to have a backup scheme in case the original plan proves to be unexpectedly difficult.

## Cloning DNA Fragments with Protruding Ends

The easiest DNA fragments to clone are those with 5′ or 3′ protruding ends. These single-strand termini, 1–6 bp in length, are most easily created by digesting the vector and the target DNA with restriction enzymes that cleave asymmetrically within the recognition sequence (please see Figure 1-2). When the ends protruding from the DNA fragment and the vector are compatible, they can anneal to form a linear hybrid molecule whose two parts are held together by pairing between the bases in the protruding termini. Formation of a circular recombinant plasmid capable of transforming *E. coli*, therefore, occurs in a two-step reaction (please see Figure 1-3):

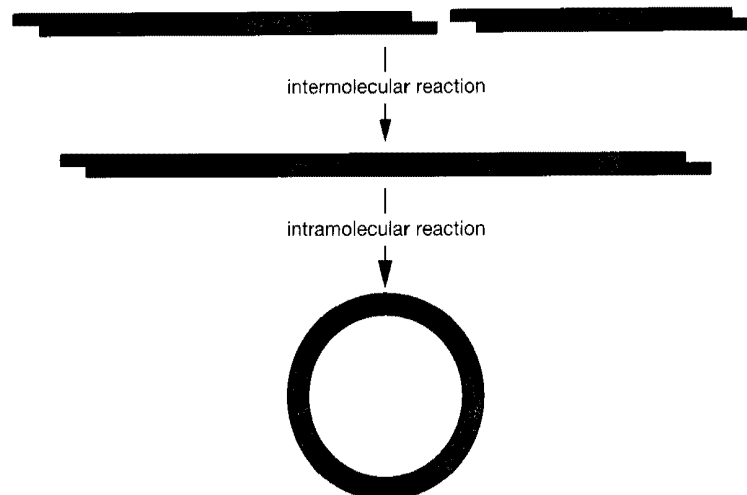
- an *intermolecular* reaction between linear plasmid and incoming DNA, which generates a non-covalently bonded, linear hybrid
- an *intramolecular* reaction, in which the protruding termini of the linear hybrid are joined together, forming a noncovalently bonded, circular recombinant molecule

Annealing brings the 5′-phosphate and 3′-hydroxyl residues on vector and target DNAs into close alignment, which allows DNA ligase to catalyze the formation of phosphodiester bonds.

The circular monomeric plasmids can have the foreign DNA fragment inserted in either orientation (please see Figure 1-4). Monomeric circular recombinant plasmids are, however, only one of a large number of potential products formed in ligation reactions between DNA molecules with compatible protruding termini. Other, less desirable products include linear and circular homo- and heteropolymers of varying sizes, orientations, and compositions. Ligation reactions should be designed with care so as to maximize the yield of circular monomeric recombinants. This is not a simple task. The first, intermolecular stage of the reaction requires high concentra-



FIGURE 1-2 Cloning 5′ and 3′ Protruding Ends



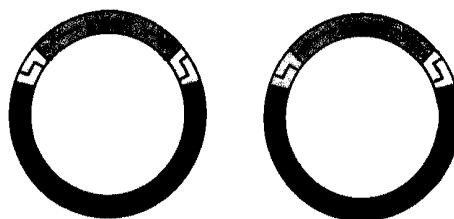
**FIGURE 1-3 Inter- and Intramolecular Reactions**

Vector sequences are represented by darker shading, and insert sequences by lighter shading.

tions of DNA, whereas the second intramolecular reaction works most efficiently when the concentration of DNA is low. However, as a general rule, acceptable yields of monomeric circular recombinants can usually be obtained from ligation reactions containing equimolar amounts of plasmid and target DNA, with the total DNA concentration  $<10 \mu\text{g/ml}$  (Bercovich et al. 1992). For a discussion of the reason why this should be so, please see Sambrook et al. (1989). If the molar ratio of plasmid vector to target DNA is incorrect, then the ligation reaction may generate an undesirably high proportion of empty plasmids (containing no insert at all) or plasmids carrying tandem inserts of foreign DNA. The number of inserts in each recombinant clone must always be validated by restriction endonuclease mapping or by some other means. The orientation of the foreign DNA insert must also be ascertained.

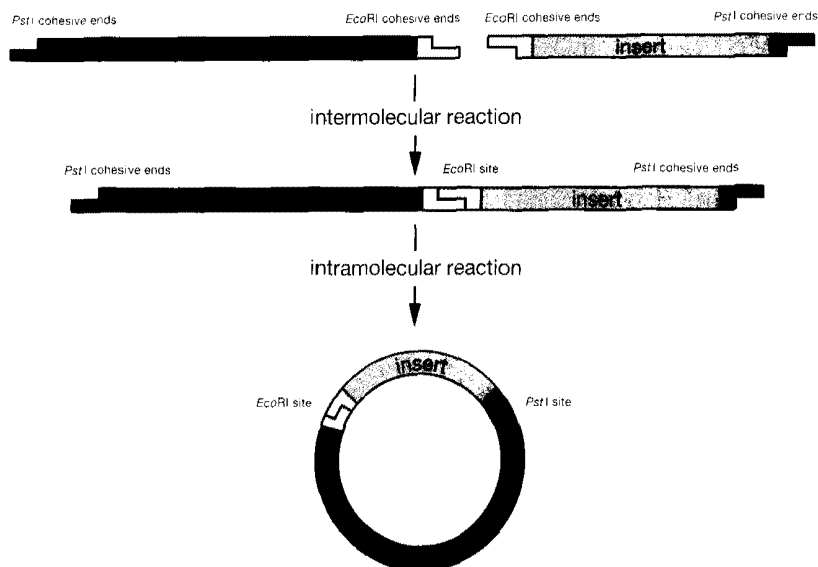
### Directional Cloning

So far, we have been dealing with ligations in which all DNA termini are equivalent, as is the case when both plasmid and foreign DNAs are prepared by cleavage with a single restriction enzyme.



**FIGURE 1-4 Cloning Bidirectional Insert DNA into a Single Site**

Vector sequences are represented by darker shading, and insert sequences by lighter shading.



**FIGURE 1-5 Directional (Forced) Cloning in Plasmid Vectors**

Vector sequences are represented by darker shading, and insert sequences by lighter shading.

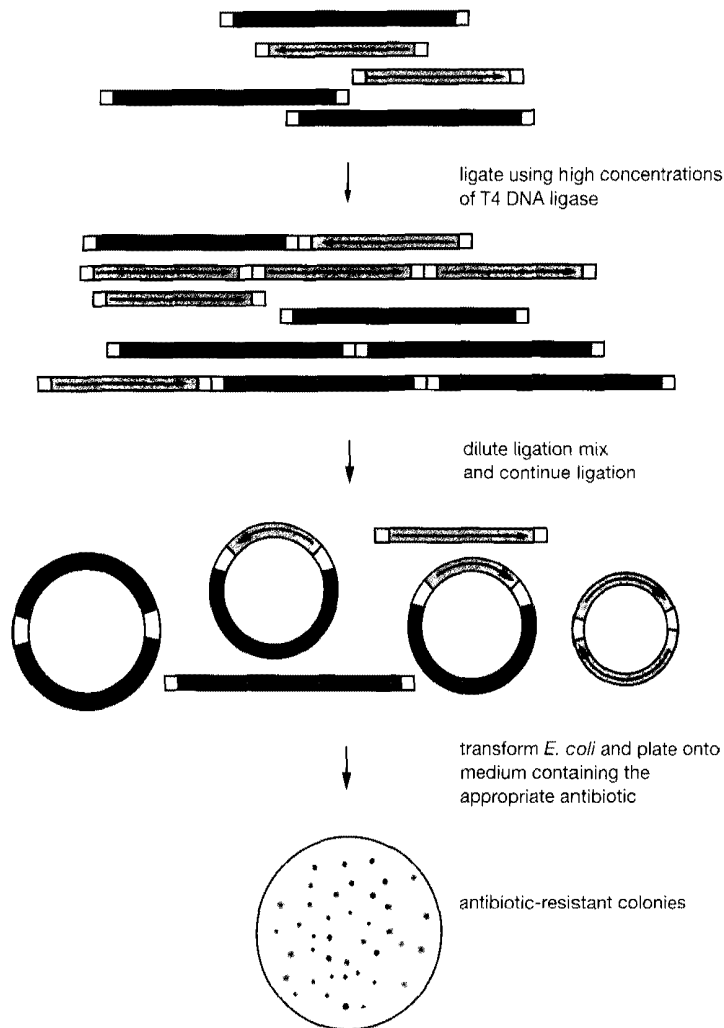
One way to increase the yield of circular monomeric recombinants is to use a cloning strategy in which the termini in the ligation reaction are not all equivalent; for example, when the foreign DNA fragment is produced by digestion with two restriction enzymes with different recognition sequences. In this case, the termini of the foreign DNA fragment will be noncomplementary and unable to ligate to each other. However, the foreign DNA will ligate eagerly to a plasmid vector that has been prepared by cleavage with the same two enzymes, generating a high yield of circular recombinants containing a single insert in a predefined orientation. This process is known as forced ligation or directional cloning (please see Figure 1-5).

### Cloning Blunt-ended DNA Fragments

Fragments of foreign DNA carrying blunt-ended termini may be cloned into a linearized plasmid vector bearing blunt ends (please see Figure 1-6). Ligation of blunt-ended termini is a comparatively inefficient reaction. The following are optimal conditions for cloning blunt-ended DNA fragments (Sgaramella and Khorana 1972; Sgaramella and Ehrlich 1978):

- low concentrations (0.5 mM) of ATP
- the absence of polyamines such as spermidine
- very high concentrations of ligase (50 Weiss units/ml)
- high concentrations of blunt-ended termini

The last condition is the main key to success. At high concentrations, blunt-ended DNA molecules form fruitful, if temporary, liaisons that bring their 5'-phosphate and 3'-hydroxyl residues into close alignment. DNA ligase seizes upon these short-lived substrates and forges per-



**FIGURE 1-6 Cloning Blunt-ended Molecules**

Antibiotic-resistant colonies arise due to the presence of vector reclosing, vector dimers, and vector-insert recombinants. These colonies are screened for those carrying vector-insert recombinants. Vector sequences are represented by darker shading, and insert sequences by lighter shading.

manent phosphodiester bonds between residues on different molecules. The resulting linear, covalently joined hybrids may be converted to circular recombinant plasmids capable of transforming *E. coli* by an intramolecular ligation reaction between the blunt termini. Ideally, the first reaction contains high concentrations of DNA, whereas the second works most efficiently when the concentration of DNA is low. Some investigators therefore carry out the first stage of the ligation reaction at high DNA concentrations. After incubating for 1 hour, the reaction is diluted 20-fold with ligase buffer, supplemented with fresh ligase, and incubated for a further 4 hours (Bercovich et al. 1992; Damak and Bullock 1993).

When DNA is in short supply, the problem of attaining adequate concentrations of blunt ends can be ameliorated by including in the reaction mixture substances that increase macromolecular crowding (e.g., 5% polyethylene glycol 8000 [PEG 8000]) (Pheiffer and Zimmerman 1983; Zimmerman and Pheiffer 1983; Upcroft and Healey 1987) or substances that cause DNA

molecules to condense into aggregates (e.g., 1.0 mM hexamminecobalt chloride) (Rusche and Howard-Flanders 1985). These crowding and condensing agents accelerate the rate of ligation of blunt-ended DNA by one to three orders of magnitude, promote intermolecular ligation, and suppress intramolecular ligation (please see the information panel on **CONDENSING AND CROWDING REAGENTS**).

Despite its power and usefulness, cloning in plasmid vectors is based on a remarkably small number of basic methods, which are easy to master. Protocols 17 and 19 describe fundamental techniques for joining plasmid vectors to DNA fragments with protruding ends and blunt ends. Protocols 18, 20, 21, and 22 describe various strategies for optimizing the recovery of the appropriate recombinant. These techniques, each one simple in itself, can be woven together to build recombinant plasmids of complex beauty and high sophistication.

## PREPARATION AND TRANSFORMATION OF COMPETENT *E. COLI*

---

Nucleic acids do not enter bacteria under their own power, but require assistance traversing the outer and inner cell membranes and in reaching an intracellular site where they can be expressed and replicated. The methods that have been devised to achieve these goals fall into two classes: chemical and physical.

### Chemical Methods

*E. coli* cells washed in cocktails of simple salt solutions achieve a state of competence during which DNA molecules may be admitted to the cell. Most of the chemical methods currently used for bacterial transformation are based on the observations of Mandel and Higa (1970), who showed that bacteria treated with ice-cold solutions of  $\text{CaCl}_2$  and then briefly heated to 37°C or 42°C could be transfected with bacteriophage  $\lambda$  DNA. The same method was subsequently used to transform bacteria with plasmid DNA (Cohen et al. 1972) and *E. coli* chromosomal DNA (Oishi and Cosloy 1972).

This simple and robust procedure regularly generates between  $10^5$  and  $10^6$  transformed colonies of *E. coli* per  $\mu\text{g}$  of supercoiled plasmid DNA. This is more than enough for routine tasks such as propagating a plasmid or transferring a plasmid from one strain of *E. coli* to another. However, higher efficiencies of transformation are required when recovery of every possible clone is of paramount importance, for example, when constructing cDNA libraries or when only minute amounts of foreign DNA are available. Starting in the 1970s and continuing to this day, many variations on the basic technique have been described in the literature, all directed toward optimizing the efficiency of transformation of different bacterial strains by plasmids. The variations include using complex cocktails of divalent cations in different buffers, treating cells with reducing agents, adjusting the ingredients of the cocktail to the genetic constitution of particular strains of *E. coli*, harvesting cells at specific stages of the growth cycle, altering the temperature of growth of the culture before exposure to chemicals, optimizing the extent and temperature of heat shock, freezing and thawing cells, and exposing cells to organic solvents after washing in divalent cations. By all these treatments and more, it is now possible on a routine basis to achieve transformation frequencies ranging from  $10^6$  to  $10^9$  transformants/ $\mu\text{g}$  of superhelical plasmid DNA (for reviews, please see Hanahan 1987; Hanahan et al. 1995; Hanahan and Bloom 1996; Hengen 1996).

The improvements in transformation frequency are a tribute to the power of empirical experimentation. How these combinations of chemical agents and physical treatments induce a state of competence remains as obscure today as in Mandel and Higa's time, as does the mecha-

nism by which plasmid DNA enters and establishes itself in competent *E. coli*. Nevertheless, the improvements made since the late 1970s have eliminated the efficiency of transformation as a potential limiting factor in molecular cloning.

There are two ways to obtain stocks of chemically induced competent *E. coli*. The first option is to purchase frozen competent bacteria from a commercial source. These products are very reliable and generally yield transformants at frequencies  $>10^8$  colonies/ $\mu\text{g}$  of supercoiled plasmid DNA. However, they are many times more expensive than competent cells prepared in the laboratory. Commercially produced competent cells are nevertheless an excellent yardstick to measure the efficiency of locally generated stocks of competent cells — and they are a godsend to investigators who carry out transformations so infrequently that it is not economical for them to expend the effort required to produce their own competent cultures. In addition, several companies sell competent stocks of strains of *E. coli* that carry specific genetic markers and are used for particular purposes in molecular cloning. Examples of these include (1) SURE strains, which carry disabling mutations in DNA-repair pathways responsible for the high rate of rearrangement of certain eukaryotic genomic sequences, and (2) strains deficient in methylases such as Dam and Dcm. Plasmids propagated in these strains can be cleaved by restriction enzymes whose activity is normally blocked by methylation of overlapping Dam or Dcm sites. It is cost-effective and far less aggravating to purchase competent stocks of strains such as these, which are tricky to grow and difficult to transform.

For laboratories using standard strains of *E. coli*, it makes sense to prepare stocks of competent bacteria in-house. The procedure for high-efficiency transformation (Hanahan 1983), described in Protocol 23, works well with K-12 strains of *E. coli* such as DH1, DH5, and MM294 and yields competent cultures that can be either used immediately or stored in small aliquots at  $-70^\circ\text{C}$  until required. If prepared carefully, these competent bacteria can yield up to  $10^9$  transformed colonies/ $\mu\text{g}$  of supercoiled plasmid DNA. Similar efficiencies can be achieved with the method using “ultra-competent” bacteria (Inoue et al. 1990), described in Protocol 24, in which the bacterial culture is grown at room temperature. However, as discussed above, such high frequencies of transformation are required only rarely; for most routine cloning tasks, competent bacteria prepared by simpler procedures are more than adequate. As a general rule, the more sophisticated the method used to prepare competent cells, the more inconsistent the results. The final method in the series of transformation protocols (Protocol 25) (Cohen et al. 1972) is both robust and durable and yields competent cells that generate  $10^6$  to  $10^7$  transformed colonies/ $\mu\text{g}$  of supercoiled plasmid DNA.

## Physical Methods

Exposure to an electrical charge destabilizes the membranes of *E. coli* and induces the formation of transient membrane pores through which DNA molecules can pass (Neumann and Rosenheck 1972; for reviews, please see Zimmerman 1982; Tsong 1991; Weaver 1993). This method, which is known as electroporation, was originally developed to introduce DNA into eukaryotic cells (Neumann et al. 1982) and was subsequently adapted for transformation of *E. coli* (Dower et al. 1988; Taketo 1988) and other bacteria by plasmids (Chassy and Flickinger 1987; Fiedler and Wirth 1988; Miller et al. 1988). It is the easiest, fastest, most efficient, and most reproducible method for transformation of bacterial cells with DNA.

- Transformation efficiencies in excess of  $10^{10}$  transformants/ $\mu\text{g}$  of DNA have been achieved by optimizing various parameters, including the strength of the electrical field, the length of the electrical pulse, the concentration of DNA, and the composition of the electroporation buffer (Dower et al. 1988; Tung and Chow 1995).



- More than 80% of the cells in a culture can be transformed to ampicillin resistance by electroporation, and efficiencies approaching the theoretical maximum of one transformant per molecule of plasmid DNA have been reported (Smith et al. 1990).
- Plasmids ranging in size from 2.6 kb to 85 kb can be introduced with efficiencies ranging from  $6 \times 10^{10}$  transformants/ $\mu\text{g}$  of DNA to  $1 \times 10^7$  transformants/ $\mu\text{g}$  DNA, respectively. This is 10–20 times higher than can be achieved with competent cells prepared by chemical methods. Transformation frequencies of this magnitude are especially useful when constructing large and highly complex cDNA libraries (please see Chapter 11).
- Electroporation works well with most commonly used laboratory strains of *E. coli* (Dower et al. 1988; Tung and Chow 1995).

Unlike chemical transformation, the number of transformants generated by electroporation is marker-dependent. For example, when pBR322, which carries genes conferring resistance to two antibiotics (ampicillin and tetracycline), is introduced into *E. coli* by electroporation, the number of tetracycline-resistant transformants is ~100-fold less than the number of ampicillin-resistant transformants (Steele et al. 1994). This effect is not seen when the plasmid is introduced into the bacteria by chemical transformation. A likely explanation is that damage or depolarization caused by the pulse of electrical current prevents or delays insertion into the inner cell membrane of the antiporter protein responsible for tetracycline resistance.

Of course, the ease and efficiency of electroporation come at a price. Electroporation is an expensive business, requiring costly electrical equipment and highly priced specially designed cuvettes. Nevertheless, for many investigators, electroporation, because of its reproducibility and lack of mumbo-jumbo, is the preferred option. For a method for the electroporation of bacterial cells, see Protocol 26. For more details, please see the information panel on **ELECTROPORATION**

## SCREENING FOR RECOMBINANT PLASMIDS

---

Only rarely is it possible to determine by looking whether a colony of transformed bacteria carries a recombinant plasmid or an empty vector. In a few exceptional cases, colonies containing a recombinant plasmid may be smaller than normal because the plasmid expresses a foreign protein that retards growth of the host cells. This situation can arise when foreign DNA sequences encoding regulatory or membrane proteins, for example, are cloned in plasmid expression vectors. However, foreign proteins are normally not expressed to significant levels in plasmid vectors commonly used for cloning.

Over the years, many methods have been devised to distinguish bacteria transformed by recombinant plasmids from those carrying empty wild-type plasmids. The most durable and general of these methods uses a nondestructive histochemical procedure to detect  $\beta$ -galactosidase activity in transformed bacteria. This procedure is commonly used as a test to distinguish colonies of bacterial cells that carry recombinant plasmids from those that do not. Alternatively, in situ hybridization methods may be used to identify with certainty bacterial colonies that have been transformed with recombinant plasmids which carry specific sequences of foreign DNA. Other generally useful methods are available to analyze the size of recombinant plasmids and to screen transformed colonies by PCR.

We have not included here any protocols dealing with the use of any of the “positive-selection systems” that allow bacteria transformed by recombinant plasmids to grow while suppressing the growth of bacteria transformed by nonrecombinant plasmids. These positive selection systems are rarely used, and, indeed, it is possible to spend an entire lifetime working with recom-

binant DNA without ever needing them. Investigators who have an appetite for esoterica of this type should read the discussion on page 1.12 of the introduction to this chapter and the papers cited therein.

### Identifying Recombinant Plasmids by $\alpha$ -Complementation

Many plasmid vectors (e.g., the pUC series, Bluescript, pGem, and their derivatives) carry a short segment of *E. coli* DNA containing the regulatory sequences and the coding information for the first 146 amino acids of  $\beta$ -galactosidase. Embedded in the coding region is a polycloning site that maintains the reading frame and results in the harmless interpolation of a small number of amino acids into the amino-terminal fragment of  $\beta$ -galactosidase. Vectors of this type are used in host cells that express the carboxy-terminal portion of  $\beta$ -galactosidase. Although neither the host-encoded fragments nor the plasmid-encoded fragments of  $\beta$ -galactosidase are themselves active, they can associate to form an enzymatically active protein. This type of complementation, in which deletion mutants of the operator-proximal segment of the *lacZ* gene are complemented by  $\beta$ -galactosidase-negative mutants that have the operator-proximal region intact, is called  $\alpha$ -complementation (Ullmann et al. 1967) (for more information, please see the information panel on  $\alpha$ -COMPLEMENTATION). The *lac*<sup>+</sup> bacteria that result from  $\alpha$ -complementation are easily recognized because they form blue colonies in the presence of the chromogenic substrate X-gal (Horwitz et al. 1964; Davies and Jacob 1968) (please see the information panel on X-GAL). However, insertion of a fragment of foreign DNA into the polycloning site of the plasmid almost invariably results in production of an amino-terminal fragment that is no longer capable of  $\alpha$ -complementation. Bacteria carrying recombinant plasmids therefore form white colonies. The development of this simple color test has greatly simplified the identification of recombinants constructed in plasmid vectors. It is easy to screen many thousands of transformed colonies and to recognize from their white appearance those that carry putative recombinant plasmids. The structure of these recombinants can then be verified by restriction analysis of minipreparations of vector DNA or by other diagnostic criteria. For procedures for screening recombinants using  $\alpha$ -complementation, please see Protocol 27. Screening by  $\alpha$ -complementation is highly dependable but not completely infallible:

- Insertion of foreign DNA does not always inactivate the complementing activity of the  $\alpha$ -fragment of  $\beta$ -galactosidase. If the foreign DNA is small (<100 bp) and if the insertion neither disrupts the reading frame nor affects the structure of the  $\alpha$ -fragment,  $\alpha$ -complementation may not be seriously affected. Examples of this phenomenon have been documented, but they are very rare and of significance only to the investigator who encounters this problem.
- Not all white colonies carry recombinant plasmids. Mutation or loss of *lac* sequences may purge the plasmid of its ability to express the  $\alpha$ -fragment. However, this is not a problem in practice because the frequency of *lac*<sup>-</sup> mutants in the plasmid population is usually far lower than the number of recombinants generated in a ligation reaction.

### Identifying Recombinant Plasmids by Hybridization

In the mid-1960s, after Nygaard and Hall (1963) had shown that single-stranded DNA could be immobilized on nitrocellulose filters, Denhardt (1966) and Gillespie and Spiegelman (1965) demonstrated that nucleic acids fixed in this way could be detected with exquisite sensitivity by hybridization to radiolabeled probes. The method quickly became a mainstay of molecular biology and was used in an essentially unchanged form for an entire decade.

In the mid 1970s, radical extensions to the technique came from two different continents. In Scotland, Ed Southern (1975) showed that hybridization could be used to detect specific sequences in complex populations of DNA fragments. In this method, DNA fragments generated by digestion with restriction enzymes were separated by electrophoresis through agarose gels and then transferred onto nitrocellulose filters for hybridization with specific probes. In the same year, Grunstein and Hogness (1975) in California adapted the method to screen large numbers of bacterial colonies for plasmids that carry specific sequences of foreign DNA. Bacterial colonies growing on the surfaces of nitrocellulose filters were lysed in situ, and the released denatured single-stranded DNA was fixed to the filter and hybridized to radiolabeled nucleic acid probes, essentially as described by Denhardt (1966). Although minor modifications have been introduced over the years, the protocol originally described by Grunstein and Hogness has proven to be remarkably durable. It remains the most commonly used technique to identify individual bacterial colonies carrying cosmids or plasmids that contain DNA sequences of interest.

The last protocols in this chapter describe methods used to transfer bacterial colonies from plates to filters (Protocols 28, 29, and 30); to release, denature, and immobilize the bacterial and plasmid DNA (Protocol 31); and to hybridize the fixed DNA with radiolabeled probes and to recover from a master plate the colonies that hybridize specifically to the probe (Protocol 32). These techniques are designed to be used with probes that are on average longer than 100 nucleotides in length. For methods for screening bacterial colonies with shorter radiolabeled oligonucleotides, see Chapter 10. No matter whether the probes are long or short, the techniques described here and in Chapter 10 can be used to screen many hundreds of thousands of colonies simultaneously and to identify colonies that carry recombinant plasmids. The structure of these plasmids is then verified by restriction analysis and Southern hybridization of minipreparations of plasmid DNA.

*Louis Pasteur's theory of germs is ridiculous fiction.*

Pierre Pacht, Professor of Physiology at Toulouse, 1872

### A NEW PLASMID ARRIVES IN THE LABORATORY

In our laboratories at least, more plasmids arrive by mail than by the work of our own hands. All plasmids, whether supplied by a commercial vendor or an academic scientist, must be validated as soon as they enter the laboratory, before they are used in experiments. The following procedure, which protects both senders and recipients, should be used no matter how well the senders are known and trusted, no matter whether they work in the next laboratory or on the other side of the world.

1. Send a written letter of thanks acknowledging that the plasmids/strains have arrived. In the letter, list the material in the package using the names on the labels. Explain that the plasmid/strains are currently being validated.
2. Photocopy any written material sent with the plasmid. The original written material should be stored in a logbook recording details of the shipment.

### Bacterial Strains

- Bacterial strains (either untransformed or transformed with a plasmid) are usually mailed as agar stab cultures. Transfer a loopful of the stab culture into 3 ml of liquid medium containing appropriate antibiotics and any necessary supplements. Incubate the liquid culture at the appropriate temperature for 18–24 hours with vigorous shaking.
- When the liquid cultures have grown, streak them onto agar plates containing appropriate antibiotics and any necessary supplements. Incubate the plates overnight at the appropriate temperature.
- Check that all colonies on the plates are identical in appearance and look and smell like *E. coli*. Streak individual colonies onto the appropriate selective media to verify the genotype of the strain. Establish small-scale (3 ml) liquid cultures from isolated colonies. If the bacteria have been transformed with a plasmid, use ~2 ml of the cultures to produce small-scale preparations of plasmid DNA. Digest several aliquots of the DNA, each with a different restriction enzyme, and analyze by agarose gel electrophoresis. Compare the sizes of the observed bands with the sizes predicted from maps provided by the sender or published in the literature.

### Plasmid DNA

- If a plasmid arrives as a DNA precipitate in 70% ethanol, recover the DNA by centrifugation and dissolve it in TE (pH 8.0) at a concentration of 100 µg/ml.
- Digest several aliquots of the DNA each with a different restriction enzyme and analyze by agarose gel electrophoresis. Compare the sizes of the observed bands with the sizes predicted from maps provided by the sender or published in the literature.
- At the same time, use an aliquot of the plasmid DNA to transform an appropriate strain of *E. coli*.
- Establish small-scale (3 ml) liquid cultures from several independent transformants. Use ~2 ml of the cultures to produce small-scale preparations of plasmid DNA. Digest an aliquot of the DNA with a number of restriction enzymes and analyze the products by agarose gel electrophoresis. Compare the sizes of the observed bands with the sizes predicted from maps provided by the sender or published in the literature.
- If the structure of the plasmid appears to be correct, grow a large-scale culture from one of the transformants. Prepare a batch of plasmid DNA, verify its identity by several restriction endonuclease digestions, and store it in aliquots in TE at –20°C.
- If viable cultures cannot be established from the material provided, or if the genetic markers of the bacteria do not seem to be correct, or if the structure of the plasmid seems to be incorrect, contact the senders immediately, telling them exactly what has been done and asking for suggestions.
- If, as is usually the case, everything is satisfactory, follow the protocol on storage of bacterial strains and plasmids in Appendix 8 and place aliquots of the liquid cultures of bacteria into long-term storage at –70°C.



## Preparation of Plasmid DNA by Alkaline Lysis with SDS

**A**LKALINE LYSIS, IN COMBINATION WITH THE DETERGENT SDS, has been used for more than 20 years to isolate plasmid DNA from *E. coli* (Birnboim and Doly 1979). Exposure of bacterial suspensions to the strongly anionic detergent at high pH opens the cell wall, denatures chromosomal DNA and proteins, and releases plasmid DNA into the supernatant. Although the alkaline solution completely disrupts base pairing, the strands of closed circular plasmid DNA are unable to separate from each other because they are topologically intertwined. As long as the intensity and duration of exposure to OH<sup>-</sup> is not too great, the two strands of plasmid DNA fall once again into register when the pH is returned to neutral.

During lysis, bacterial proteins, broken cell walls, and denatured chromosomal DNA become enmeshed in large complexes that are coated with dodecyl sulfate. These complexes are efficiently precipitated from solution when sodium ions are replaced by potassium ions (Ish-Horowitz and Burke 1981). After the denatured material has been removed by centrifugation, native plasmid DNA can be recovered from the supernatant.

Alkaline lysis in the presence of SDS is a flexible technique that works well with all strains of *E. coli* and with bacterial cultures ranging in size from 1 ml to >500 ml. The closed circular plasmid DNA recovered from the lysate can be purified in many different ways and to different extents, according to the needs of the experiment (please see Table 1-4).

**TABLE 1-4 Small-, Medium-, and Large-scale Preparations of Plasmid DNA**

<b>PROTOCOL 1</b> <b>MINIPREPARATIONS (1–2 ML)</b>	<b>PROTOCOL 2</b> <b>MIDIPREPARATIONS (10 ML)</b>	<b>PROTOCOL 3</b> <b>MAXIPREPARATIONS (500 ML)</b>
<p>Many minipreparations can be processed simultaneously.</p> <p>Yields vary between 100 ng and 5 µg of DNA, depending on the copy number of the plasmid.</p> <p>DNA is a suitable substrate for restriction enzymes, but the yields are generally too low for transfection of mammalian cells. Further purification is required for DNA sequencing (please see the information panel on <b>PURIFICATION OF PLASMID DNA BY PEG PRECIPITATION</b>).</p>	<p>The rate-limiting step in this protocol is column chromatography, which limits the number of preparations that can be processed simultaneously.</p> <p>Yields of high-copy-number plasmids range from 20 to 50 µg of DNA.</p> <p>After purification by column chromatography, the plasmid DNA may be used to transfect cultured mammalian cells.</p>	<p>This method is slow and very expensive if CsCl-ethidium bromide equilibrium density gradients are used for purification (Protocols 10 and 11).</p> <p>Alternative purification procedures include PEG precipitation (Protocol 8) and column chromatography (Protocol 9).</p> <p>Yields of high-copy-number plasmids range from 1 to 3 mg per large-scale culture. As the efficiency of growing, purifying, and analyzing plasmid DNA has improved, the need for large-scale preparations has greatly diminished. Maxipreparations are now almost an extinct species.</p>

# Protocol 1

---

## Preparation of Plasmid DNA by Alkaline Lysis with SDS: Minipreparation

**P** LASMID DNA MAY BE ISOLATED FROM SMALL-SCALE (1–2 ml) bacterial cultures by treatment with alkali and SDS. The resulting DNA preparation may be screened by electrophoresis or restriction endonuclease digestion. With further purification by treatment with PEG, the preparations may be used as templates in DNA sequencing reactions (please see the information panel on **PURIFICATION OF PLASMA DNA BY PEG PRECIPITATION**).

### MATERIALS

---

**CAUTION:** Please see Appendix 12 for appropriate handling of materials marked with <!>.

#### Buffers and Solutions

Please see Appendix 1 for components of stock solutions, buffers, and reagents. Dilute stock solutions to the appropriate concentrations.

*Alkaline lysis solution I*

*Alkaline lysis solution II*

Solution II should be freshly prepared and used at room temperature.

*Alkaline lysis solution III*

*Antibiotic for plasmid selection*

*Ethanol*

*Phenol:chloroform (1:1, v/v) <!>*

Optional, please see Step 8.

*STE*

Optional, please see Step 3.

*TE (pH 8.0) containing 20 µg/ml RNase A*

#### Media

*LB, YT, or Terrific Broth*

### METHOD

---

#### Preparation of Cells

1. Inoculate 2 ml of rich medium (LB, YT, or Terrific Broth) containing the appropriate antibiotic with a single colony of transformed bacteria. Incubate the culture overnight at 37°C with vigorous shaking.



To ensure that the culture is adequately aerated:

- The volume of the culture tube should be at least four times greater than the volume of the bacterial culture.
  - The tube should be loosely capped.
  - The culture should be incubated with vigorous agitation.
2. Pour 1.5 ml of the culture into a microfuge tube. Centrifuge at maximum speed for 30 seconds at 4°C in a microfuge. Store the unused portion of the original culture at 4°C.
  3. When centrifugation is complete, remove the medium by aspiration, leaving the bacterial pellet as dry as possible.

This step can be conveniently accomplished with a disposable pipette tip or Pasteur pipette attached to a vacuum line and a side arm flask (please see Figure 1-7). Use a gentle vacuum and touch the tip to the surface of the liquid. Keep the tip as far away from the bacterial pellet as possible as the fluid is withdrawn from the tube. This minimizes the risk that the pellet will be sucked into the side arm flask. Alternatively, remove the supernatant using a pipettor or Pasteur pipette and bulb. Use the pipette tip to vacuum the walls of the tube to remove any adherent droplets of fluid.

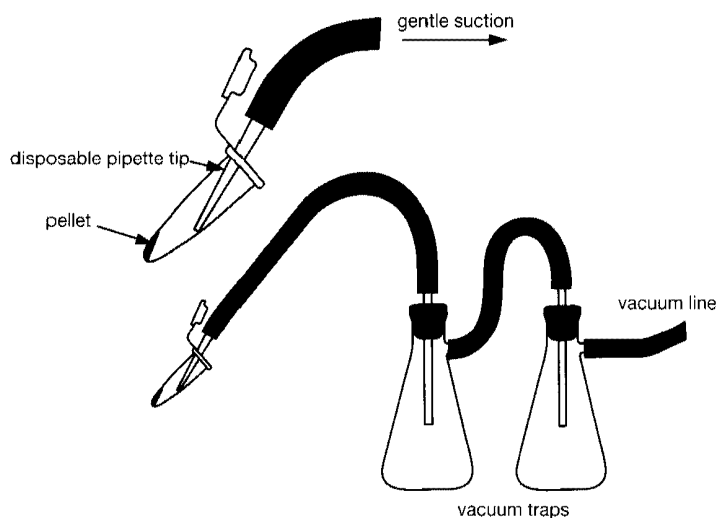
The penalty for failing to remove all traces of medium from the bacterial pellet is a preparation of plasmid DNA that is resistant to cleavage by restriction enzymes. This is because cell-wall components in the medium inhibit the action of many restriction enzymes. This problem can be avoided by resuspending the bacterial pellet in ice-cold STE (0.25x volume of the original bacterial culture) and centrifuging again.

## Lysis of Cells

4. Resuspend the bacterial pellet in 100  $\mu$ l of ice-cold Alkaline lysis solution I by vigorous vortexing.

Make sure that the bacterial pellet is completely dispersed in Alkaline lysis solution I. Vortexing two microfuge tubes simultaneously with their bases touching increases the rate and efficiency with which the bacterial pellets are resuspended.

The original protocol (Birnboim and Doly 1979) called for the use of lysozyme at this point to assist in dissolution of the bacterial cell walls. This step can be safely omitted when dealing with bacterial cultures of less than 10 ml in volume.



**FIGURE 1-7** Aspiration of Supernatants

Hold the open microfuge tube at an angle, with the pellet on the upper side. Use a disposable pipette tip attached to a vacuum line to withdraw fluid from the tube. Insert the tip just beneath the meniscus on the lower side of the tube. Move the tip toward the base of the tube as the fluid is withdrawn. Use gentle suction to avoid drawing the pellet into the pipette tip. Keep the end of the tip away from the pellet. Finally, vacuum the walls of the tube to remove any adherent drops of fluid.

5. Add 200  $\mu$ l of freshly prepared Alkaline lysis solution II to each bacterial suspension. Close the tube tightly, and mix the contents by inverting the tube rapidly five times. *Do not vortex!* Store the tube on ice.

Make sure that the entire surface of the tube comes in contact with Alkaline lysis solution II.

6. Add 150  $\mu$ l of ice-cold Alkaline lysis solution III. Close the tube and disperse Alkaline lysis solution III through the viscous bacterial lysate by inverting the tube several times. Store the tube on ice for 3–5 minutes.
7. Centrifuge the bacterial lysate at maximum speed for 5 minutes at 4°C in a microfuge. Transfer the supernatant to a fresh tube.
8. (*Optional*) Add an equal volume of phenol:chloroform. Mix the organic and aqueous phases by vortexing and then centrifuge the emulsion at maximum speed for 2 minutes at 4°C in a microfuge. Transfer the aqueous upper layer to a fresh tube.

Some investigators find the extraction with phenol:chloroform to be unnecessary. However, the elimination of this step sometimes results in DNA that is resistant to cleavage by restriction enzymes.

The purpose of extracting with chloroform is to remove residual phenol from the aqueous phase. Phenol is slightly soluble in H<sub>2</sub>O, but it can be displaced into the organic phase by chloroform. Years ago, it was common practice in some laboratories to detect residual phenol in DNA preparations by smell. This practice is no longer recommended.

## Recovery of Plasmid DNA

9. Precipitate nucleic acids from the supernatant by adding 2 volumes of ethanol at room temperature. Mix the solution by vortexing and then allow the mixture to stand for 2 minutes at room temperature.
10. Collect the precipitated nucleic acids by centrifugation at maximum speed for 5 minutes at 4°C in a microfuge.

It is best to get into the habit of always arranging the microfuge tubes in the same way in the microfuge rotor, i.e., in order, with their plastic hinges always pointing outward. The precipitate will collect on the inside surface furthest from the center of rotation. Knowing where to look makes it easier to find visible precipitates and to dissolve “invisible” precipitates efficiently. Labeling both the sides and tops of tubes provides clear identification of each tube, even if the ink smudges.

11. Remove the supernatant by gentle aspiration as described in Step 3 above. Stand the tube in an inverted position on a paper towel to allow all of the fluid to drain away. Use a Kimwipe or disposable pipette tip to remove any drops of fluid adhering to the walls of the tube.
12. Add 1 ml of 70% ethanol to the pellet and invert the closed tube several times. Recover the DNA by centrifugation at maximum speed for 2 minutes at 4°C in a microfuge.
13. Again remove all of the supernatant by gentle aspiration as described in Step 3.

Take care with this step, as the pellet sometimes does not adhere tightly to the tube.

14. Remove any beads of ethanol that form on the sides of the tube. Store the open tube at room temperature until the ethanol has evaporated and no fluid is visible in the tube (5–10 minutes).

If the pellet of DNA is dried in a desiccator or under vacuum, it becomes difficult to dissolve under some circumstances and may denature (Svaren et al. 1987). Drying the pellet for 10–15 minutes at room temperature is usually sufficient for the ethanol to evaporate without the DNA becoming dehydrated.

15. Dissolve the nucleic acids in 50  $\mu$ l of TE (pH 8.0) containing 20  $\mu$ g/ml DNase-free RNase A (pancreatic RNase). Vortex the solution gently for a few seconds. Store the DNA solution at –20°C.

For recommendations on troubleshooting, please see Table 1-5 in Protocol 3.

# Protocol 2

---

## Preparation of Plasmid DNA by Alkaline Lysis with SDS: Midipreparation

**P**LASMID DNA MAY BE ISOLATED FROM INTERMEDIATE-SCALE (20–50 ml) bacterial cultures by treatment with alkali and SDS. The resulting DNA preparation is suitable for analysis by electrophoresis or restriction endonuclease digestion. After further purification by column chromatography, the preparations may be used to transfect mammalian cells.

### MATERIALS

---

**CAUTION:** Please see Appendix 12 for appropriate handling of materials marked with <!.>.

#### Buffers and Solutions

Please see Appendix 1 for components of stock solutions, buffers, and reagents. Dilute stock solutions to the appropriate concentrations.

##### *Alkaline lysis solution I*

For preparations of plasmid DNA that are to be subjected to further purification by chromatography (please see Protocol 9), sterile Alkaline lysis solution I may be supplemented just before use with the appropriate volume of 20 mg/ml DNase-free RNase A (pancreatic RNase) to give a final concentration of 100 µg/ml. Addition of RNase is not recommended at this stage if the DNA is to be further purified by other methods (please see Protocols 10 and 11).

##### *Alkaline lysis solution II*

Solution II should be freshly prepared and used at room temperature.

##### *Alkaline lysis solution III*

##### *Antibiotic for plasmid selection*

##### *Ethanol*

##### *Isopropanol*

##### *Phenol:chloroform (1:1, v/v) <!.>*

##### *STE*

Optional, please see Step 3.

##### *TE (pH 8.0) containing 20 µg/ml RNase A*

#### Media

*LB, YT, or Terrific Broth*

#### Centrifuges and Rotors

*Sorvall SS-34 rotor or equivalent*

## METHOD

---

### Preparation of Cells

1. Inoculate 10 ml of rich medium (LB, YT, or Terrific Broth) containing the appropriate antibiotic with a single colony of transformed bacteria. Incubate the culture overnight at 37°C with vigorous shaking.

To ensure that the culture is adequately aerated:

- The volume of the culture tube should be at least four times greater than the volume of the bacterial culture.
- The tube should be loosely capped.
- The culture should be incubated with vigorous agitation.

2. Transfer the culture into a 15-ml tube and recover the bacteria by centrifugation at 2000g (4000 rpm in a Sorvall SS-34 rotor) for 10 minutes at 4°C.

3. Remove the medium by gentle aspiration, leaving the bacterial pellet as dry as possible.

This step can be conveniently accomplished with a disposable pipette tip or Pasteur pipette attached to a vacuum line and a side arm flask (please see Figure 1-7). Use a gentle vacuum and touch the tip to the surface of the liquid. Keep the tip as far away from the bacterial pellet as possible as the fluid is withdrawn from the tube. This minimizes the risk that the pellet will be sucked into the side arm flask. Alternatively, remove the supernatant using a pipettor or Pasteur pipette and bulb. Use the pipette tip to vacuum the walls of the tube to remove any adherent droplets of fluid.

The penalty for failing to remove all traces of medium from the bacterial pellet is a preparation of plasmid DNA that is resistant to cleavage by restriction enzymes. This is because cell-wall components in the medium inhibit the action of many restriction enzymes. This problem can be avoided by resuspending the bacterial pellet in ice-cold STE (0.25x volume of the original bacterial culture) and centrifuging again.

### Lysis of Cells

4. Resuspend the bacterial pellet in 200  $\mu$ l of ice-cold Alkaline lysis solution I by vigorous vortexing, and transfer the suspension to a microfuge tube.

Make sure that the bacterial pellet is completely dispersed in Alkaline lysis solution I. Vortexing two microfuge tubes simultaneously with their bases touching increases the rate and efficiency with which the bacterial pellets are resuspended.

The original protocol (Birnboim and Doly 1979) called for the use of lysozyme at this point to assist in dissolution of the bacterial cell walls. This step can be safely omitted when dealing with bacterial cultures of less than 10 ml in volume.

5. Add 400  $\mu$ l of freshly prepared Alkaline lysis solution II to each bacterial suspension. Close the tube tightly, and mix the contents by inverting the tube rapidly five times. *Do not vortex!* Store the tube on ice.

Make sure that the entire surface of the tube comes in contact with Alkaline lysis solution II.

6. Add 300  $\mu$ l of ice-cold Alkaline lysis solution III. Close the tube and disperse Alkaline lysis solution III through the viscous bacterial lysate by inverting the tube several times. Store the tube on ice for 3–5 minutes.

7. Centrifuge the bacterial lysate at maximum speed for 5 minutes at 4°C in a microfuge. Transfer 600  $\mu$ l of the supernatant to a fresh tube.

8. Add an equal volume of phenol:chloroform. Mix the organic and aqueous phases by vortexing and then centrifuge the emulsion at maximum speed for 2 minutes at 4°C in a microfuge. Transfer the aqueous upper layer to a fresh tube.

### Recovery of Plasmid DNA

9. Precipitate nucleic acids from the supernatant by adding 600 µl of isopropanol at room temperature. Mix the solution by vortexing and then allow the mixture to stand for 2 minutes at room temperature.
10. Collect the precipitated nucleic acids by centrifugation at maximum speed for 5 minutes at room temperature in a microfuge.
11. Remove the supernatant by gentle aspiration as described in Step 3 above. Stand the tube in an inverted position on a paper towel to allow all of the fluid to drain away. Remove any drops of fluid adhering to the walls of the tube.
12. Add 1 ml of 70% ethanol to the pellet and recover the DNA by centrifugation at maximum speed for 2 minutes at room temperature in a microfuge.
13. Again remove all of the supernatant by gentle aspiration as described in Step 3.  
Take care with this step, as the pellet sometimes does not adhere tightly to the tube.
14. Remove any beads of ethanol that form on the sides of the tube. Store the open tube at room temperature until the ethanol has evaporated and no fluid is visible in the tube (2–5 minutes).  
If the pellet of DNA is dried in a desiccator or under vacuum, it becomes difficult to dissolve under some circumstances and may denature (Svaren et al. 1987). Drying the pellet for 10–15 minutes at room temperature is usually sufficient for the ethanol to evaporate without the DNA becoming dehydrated.
15. Dissolve the nucleic acids in 100 µl of TE (pH 8.0) containing 20 µg/ml DNase-free RNase A (pancreatic RNase). Vortex the solution gently for a few seconds. Store the DNA solution at –20°C.

For recommendations on troubleshooting, please see Table 1-5 in Protocol 3.

# Protocol 3

---

## Preparation of Plasmid DNA by Alkaline Lysis with SDS: Maxipreparation

**P**LASMID DNA MAY BE ISOLATED FROM LARGE-SCALE (500 ml) bacterial cultures by treatment with alkali and SDS. The resulting DNA preparation may be further purified by column chromatography or centrifugation through CsCl-ethidium bromide gradients.

### MATERIALS

---

**CAUTION:** Please see Appendix 12 for appropriate handling of materials marked with <!.>.

#### Buffers and Solutions

Please see Appendix 1 for components of stock solutions, buffers, and reagents. Dilute stock solutions to the appropriate concentrations.

##### *Alkaline lysis solution I*

For preparations of plasmid DNA that are to be subjected to further purification by chromatography (please see Protocol 9), sterile Alkaline lysis solution I may be supplemented just before use with the appropriate volume of 20 mg/ml DNase-free RNase A (pancreatic RNase) to give a final concentration of 100 µg/ml. Addition of RNase is not recommended at this stage if the DNA is to be further purified by other methods (please see Protocols 10 and 11).

##### *Alkaline lysis solution II*

Solution II should be freshly prepared and used at room temperature.

##### *Alkaline lysis solution III*

##### *Antibiotic for plasmid selection*

##### *Chloramphenicol (34 mg/ml) <!.>*

Optional, please see Step 4.

##### *Ethanol*

##### *Isopropanol*

##### *STE*

##### *TE (pH 8.0)*

#### Enzymes and Buffers

##### *Lysozyme (10 mg/ml)*

Please see the information panel on **LYSOZYMES**.

##### *Restriction endonucleases*

#### Gels

##### *Agarose gels*

Please see Steps 8 and 19.

## Media

*LB, YT, or Terrific Broth*

## Centrifuges and Rotors

*Sorvall GSA rotor or equivalent*

*Sorvall SS-34 rotor or equivalent*

## Additional Reagents

*Steps 8 and 19 of this protocol require reagents listed in Chapter 5, Protocol 1.*

*Step 18 of this protocol requires reagents listed in Protocol 8, 9, 10, or 11 of this chapter.*

## METHOD

---

### Preparation of Cell Culture

1. Inoculate 30 ml of rich medium (LB, YT, or Terrific Broth) containing the appropriate antibiotic either with a single colony of transformed bacteria or with 0.1–1.0 ml of a small-scale liquid culture grown from a single colony.

To ensure that the culture is adequately aerated:

- The volume of the culture flask should be at least four times greater than the volume of the bacterial culture.
- The culture flask should be loosely capped.
- The culture should be incubated with vigorous agitation.

2. Incubate the culture at the appropriate temperature with vigorous shaking until the bacteria reach late log phase ( $OD_{600} = \sim 0.6$ ).
3. Inoculate 500 ml of LB, YT, or Terrific Broth medium (prewarmed to 37°C) containing the appropriate antibiotic in a 2-liter flask with 25 ml of the late-log-phase culture. Incubate the culture for ~2.5 hours at 37°C with vigorous shaking (300 cycles/minute on a rotary shaker).

The  $OD_{600}$  of the resulting culture should be ~0.4. Because the growth rates of different bacterial strains will vary, the culture may have to be incubated slightly longer or shorter than 2.5 hours to reach an OD of 0.4.

4. For relaxed plasmids with low or moderate copy numbers, add 2.5 ml of 34 mg/ml chloramphenicol solution. The final concentration of chloramphenicol in the culture should be 170  $\mu\text{g/ml}$ .

▲ **IMPORTANT** For high-copy-number plasmids, do not add chloramphenicol.

5. Incubate the culture for a further 12–16 hours at 37°C with vigorous shaking (300 cycles/minute on a rotary shaker).
6. Remove an aliquot (1–2 ml) of the bacterial culture to a fresh microfuge tube and store it at 4°C. Harvest the remainder of the bacterial cells from the 500-ml culture by centrifugation at 2700g (4100 rpm in a Sorvall GSA rotor) for 15 minutes at 4°C. Discard the supernatant. Stand the open centrifuge bottle in an inverted position to allow all of the supernatant to drain away.
7. Resuspend the bacterial pellet in 200 ml of ice-cold STE. Collect the bacterial cells by centrifugation as described in Step 6. Store the pellet of bacteria in the centrifuge bottle at –20°C.
8. Use one of the methods described in Protocol 1 or Protocol 4 to prepare plasmid DNA from the 1–2-ml aliquot of bacterial culture set aside in Step 6. Analyze the minipreparation plas-



mid DNA by digestion with the appropriate restriction enzyme(s) and agarose gel electrophoresis to ensure that the correct plasmid has been propagated in the large-scale culture.

This kind of control may seem a little overly compulsive. However, it provides valuable insurance against errors that may be difficult to retrieve and may cause considerable loss of time.

## Lysis of Cells

9. Allow the frozen bacterial cell pellet from Step 7 to thaw at room temperature for 5–10 minutes. Resuspend the pellet in 18 ml (10 ml) of Alkaline lysis solution I.

The volumes given in parentheses in the remainder of this protocol should be used only with cultures that have been treated with chloramphenicol at Step 4.

10. Add 2 ml (1 ml) of a freshly prepared solution of 10 mg/ml lysozyme.
11. Add 40 ml (20 ml) of freshly prepared Alkaline lysis solution II. Close the top of the centrifuge bottle and mix the contents thoroughly by gently inverting the bottle several times. Incubate the bottle for 5–10 minutes at room temperature.

Prolonged exposure of superhelical DNA to alkali results in irreversible denaturation (Vinograd and Lebowitz 1966). The resulting cyclic coiled DNA cannot be cleaved with restriction enzymes, and it migrates through agarose gels at about twice the rate of superhelical DNA and stains poorly with ethidium bromide. Traces of this form of DNA can be seen in plasmids prepared by alkaline lysis of bacteria.

12. Add 20 ml (15 ml) of ice-cold Alkaline lysis solution III. Close the top of the centrifuge bottle and mix the contents gently but well by swirling the bottle several times (there should no longer be two distinguishable liquid phases). Place the bottle on ice for 10 minutes.

A flocculent white precipitate consisting of chromosomal DNA, high-molecular-weight RNA, and potassium/SDS/protein/cell wall complexes will form during this incubation.

Potassium acetate is used in preference to sodium acetate in Alkaline lysis solution III because the potassium salt of dodecyl sulfate is far less soluble than the sodium salt.

13. Centrifuge the bacterial lysate at  $\geq 20,000g$  (11,000 rpm in a Sorvall GSA rotor) for 30 minutes at 4°C in a medium-speed centrifuge. Allow the rotor to stop without braking. At the end of the centrifugation step, decant the clear supernatant into a graduated cylinder. Discard the pellet remaining in the centrifuge bottle.

The failure to form a compact pellet after centrifugation is usually a consequence of inadequate mixing of the bacterial lysate with Alkaline lysis solution II (Step 11). If the bacterial debris does not form a tightly packed pellet, centrifuge again at 20,000g (11,000 rpm in a Sorvall GSA rotor) for a further 15 minutes, and then transfer as much of the supernatant as possible to a fresh tube. Decanting the supernatant through four-ply gauze at this step helps to remove traces of viscous genomic DNA and protein precipitate.

## Recovery of Plasmid DNA

14. Measure the volume of the supernatant. Transfer the supernatant together with 0.6 volume of isopropanol to a fresh centrifuge bottle. Mix the contents well and store the bottle for 10 minutes at room temperature.
15. Recover the precipitated nucleic acids by centrifugation at 12,000g (8000 rpm in a Sorvall GSA rotor) for 15 minutes at *room temperature*.  
Salt may precipitate if centrifugation is carried out at 4°C.
16. Decant the supernatant carefully, and invert the open bottle on a paper towel to allow the last drops of supernatant to drain away. Rinse the pellet and the walls of the bottle with 70% ethanol at room temperature. Drain off the ethanol, and use a Pasteur pipette attached to a

vacuum line to remove any beads of liquid that adhere to the walls of the bottle. Place the inverted, open bottle on a pad of paper towels for a few minutes at room temperature to allow the ethanol to evaporate.

If the pellet of DNA is dried in a desiccator or under vacuum, it becomes difficult to dissolve under some circumstances and may denature (Svaren et al. 1987). Drying the pellet for 10–15 minutes at room temperature is usually sufficient for the ethanol to evaporate without DNA becoming dehydrated.

17. Dissolve the damp pellet of nucleic acid in 3 ml of TE (pH 8.0).
18. Purify the crude plasmid DNA either by column chromatography (Protocol 9), precipitation with polyethylene glycol (Protocol 8), or equilibrium centrifugation in CsCl-ethidium bromide gradients (Protocols 10 and 11).
19. Check the structure of the plasmid by restriction enzyme digestion followed by gel electrophoresis.

For recommendations on troubleshooting, please see Table 1-5.

The typical yield of high-copy-number plasmid vectors or of amplified low-copy-number vectors prepared by this method is ~3–5  $\mu\text{g}$  of DNA/ml of original bacterial culture. The yield of recombinant plasmids containing inserts of foreign DNA is usually slightly lower, depending on the size and nature of the cloned DNA fragment. Yields of  $\leq 1.0$   $\mu\text{g}/\text{ml}$  indicate that the plasmid DNA is toxic to *E. coli*; the complete absence of DNA indicates that the plasmid has been lost during extraction and purification. The first problem can often be solved by switching to a low-copy-number vector and/or to a vector that carries prokaryotic transcriptional termination signals. The second problem is often the result of accidental loss of the plasmid DNA pellet after ethanol precipitation. It also occurs when the recombinant plasmid is large enough to be precipitated together with the chromosomal DNA after addition of potassium acetate. Such a large plasmid will also be susceptible to breakage during extraction and purification. This difficulty can be solved by using a more gentle procedure of cell lysis, such as that described in Protocol 7.

TABLE 1-5 Troubleshooting

PROBLEM	POSSIBLE CAUSES	REMEDIES
DNA is resistant to cleavage with restriction enzymes.	Insufficient care was taken to remove all of the fluid at Step 3 or Step 11 of small-scale or Steps 6 and 7 or Step 16 of large-scale preparation.	Extract the final DNA preparation with phenol:chloroform; recover by standard ethanol precipitation and subsequent washing in 70% ethanol. Alternatively, carry out the restriction digest in a larger volume (100–200 $\mu$ l), using fivefold more enzyme. At the end of the digestion, recover the DNA by standard ethanol precipitation.
	Some strains of <i>E. coli</i> (e.g., HB101 and its derivatives) shed cell-wall components that persist through purification of the plasmid DNA and inhibit the action of restriction enzymes.	Resuspend the bacterial pellet in ice-cold STE (0.25x volume of the original bacterial culture) and recentrifuge. Discard every last drop of the STE, and resuspend the bacterial pellet in Alkaline lysis solution I as described above.
Very little or no DNA is visible on gel either before or after restriction digestion.	Pellet of nucleic acid was inadvertently discarded after ethanol precipitation.	Remove the ethanol by gentle aspiration (Figure 1-7, p. 1.33) as soon as possible after the centrifugation step. If the centrifuge tube is left to stand for too long, the pellet of DNA will become detached from the wall.
Plasmid DNA is present before digestion with restriction enzymes but is converted into a smear during digestion.	The DNA is most likely tainted with a bacterial DNase (e.g., <i>endA</i> ), which is activated upon exposure to $Mg^{2+}$ present in the restriction buffer. The most likely source of the DNase is the stock of TE used to dissolve the plasmid DNA. Unless care is taken, TE can become contaminated by bacteria. Restriction buffers are a less likely possibility.	Sterilize each batch of TE by autoclaving and dispense 1-ml aliquots into sterile microfuge tubes (or sterilize TE in small aliquots). Use a fresh aliquot every day. Try to maintain sterile technique when using stock solutions. If bacterial DNase copurifies with the plasmid DNA, extract the DNA with phenol:chloroform, recover by standard ethanol precipitation, and resuspend in fresh TE.

## Preparation of Plasmid DNA by Boiling Lysis

**I**N THIS METHOD, ADAPTED FROM HOLMES AND QUIGLEY (1981), bacteria are suspended in buffer containing Triton X-100 and lysozyme, which weakens the cell walls, and are then lysed by heating to 100°C (please see the information panel on **LYSOZYMES**). In addition to cracking open the outer shell, the heating step disrupts base pairing of DNA strands and denatures the proteins and chromosomal DNA of the host. However, the strands of closed circular plasmid DNA are unable to separate from each other because their phosphodiester backbones are topologically intertwined. When the temperature is lowered, the bases of the closed circular molecules of DNA fall once again into register, forming superhelical molecules. After denatured chromosomal DNA and proteins have been removed by centrifugation, native plasmid DNA can be recovered from the supernatant.

The boiling procedure works well with smaller plasmids (<15 kb in size) and can be used to prepare plasmid DNA from bacterial cultures ranging in volume from 1 ml (minipreparations) to 250 ml (large-scale preparations). The method works well with most strains of *E. coli*. However, the boiling method is not recommended for strains of *E. coli* that release large quantities of carbohydrate on exposure to detergent, lysozyme, and heat. The carbohydrate, which is difficult to remove from the plasmid preparation, may inhibit restriction enzymes and polymerases and, when present in excess, may obscure the band of superhelical plasmid DNA in CsCl-ethidium bromide gradients. *E. coli* strain HB101 and its derivatives (which include TG1) are prolific producers of carbohydrate and are therefore unsuitable for lysis by the boiling method.

The boiling method is also not recommended when preparing plasmid DNA from strains of *E. coli* that express endonuclease A (*endA*<sup>+</sup> strains). Because endonuclease A is not completely inactivated during the boiling procedure, the plasmid DNA is degraded during subsequent incubation in the presence of Mg<sup>2+</sup> (e.g., during digestion with restriction enzymes). Plasmid DNA from the *endA*<sup>+</sup> strains should therefore be prepared by the alkaline lysis method (Protocols 1, 2, and 3).

The protocol for small-scale boiling lysis (described in Protocol 4) may be scaled up for isolation of plasmid DNA from large-volume cultures. This method is used in conjunction with a subsequent purification step such as precipitation with polyethylene glycol (Protocol 8), purification by column chromatography (Protocol 9), or equilibrium centrifugation in CsCl-ethidium bromide gradients (Protocols 10 and 11). It is recommended *only* for bacterial cultures that have been treated with chloramphenicol. Untreated cultures yield lysates that are too viscous to be manageable.

# Protocol 4

---

## Preparation of Plasmid DNA by Small-scale Boiling Lysis

**P** LASMID DNA MAY BE ISOLATED FROM SMALL-SCALE (1–2 ml) bacterial cultures by treatment with Triton-X-100 and lysozyme, followed by heating. The resulting DNA preparation may be screened by electrophoresis or restriction endonuclease digestion. With further purification by treatment with PEG, the preparations may be used as templates in DNA sequencing reactions (please see the information panel on **PURIFICATION OF PLASMID DNA BY PEG PRECIPITATION**).

---

### MATERIALS

---

#### Buffers and Solutions

Please see Appendix 1 for components of stock solutions, buffers, and reagents.  
Dilute stock solutions to the appropriate concentrations.

*Antibiotic for plasmid selection*

*Ethanol*

*Isopropanol*

*Sodium acetate (3.0 M, pH 5.2)*

*STET*

*TE (pH 8.0) containing 20 µg/ml RNase A*

#### Enzymes and Buffers

*Lysozyme (10 mg/ml)*

Please see the information panel on **LYSOZYMES**

#### Media

*LB, YT, or Terrific Broth*

#### Special Equipment

*Boiling water bath*

## METHOD

---

### Preparation of Cells

1. Inoculate 2 ml of rich medium (LB, YT, or Terrific Broth) containing the appropriate antibiotic with a single colony of transformed bacteria. Incubate the culture overnight at 37°C with vigorous shaking.

To ensure that the culture is adequately aerated:

- The volume of the culture tube should be at least four times greater than the volume of the bacterial culture.
- The tube should be loosely capped.
- The culture should be incubated with vigorous agitation.

2. Pour 1.5 ml of the culture into a microfuge tube. Centrifuge the tube at maximum speed for 30 seconds at 4°C in a microfuge. Store the unused portion of the culture at 4°C.
3. When centrifugation is complete, remove the medium by gentle aspiration, leaving the bacterial pellet as dry as possible.

This step can be conveniently accomplished with a disposable pipette tip or Pasteur pipette attached to a vacuum line and a side arm flask (please see Figure 1-7). Use a gentle vacuum and touch the tip to the surface of the liquid. Keep the tip as far from the bacterial pellet as possible as the fluid is withdrawn from the tube. This minimizes the risk that the pellet will be sucked into the side arm flask. Alternatively, remove the supernatant using a pipettor or Pasteur pipette and bulb. Use the pipette tip to vacuum the walls of the tube to remove any adherent droplets of fluid.

The penalty for failing to remove all traces of medium from the bacterial pellet is a preparation of plasmid DNA that is resistant to cleavage by restriction enzymes. This is because cell-wall components in the medium inhibit the action of many restriction enzymes.

4. Resuspend the bacterial pellet in 350 µl of STET.

Make sure that the bacterial pellet is dispersed completely and quickly in STET. Vortexing two microfuge tubes simultaneously with their bases touching works well.

### Lysis of Cells

5. Add 25 µl of a freshly prepared solution of lysozyme. Close the top of the tube and mix the contents by gently vortexing for 3 seconds.
6. Place the tube in a boiling water bath for *exactly* 40 seconds.

Prolonged exposure of superhelical DNA to heat results in irreversible denaturation (Vinograd and Lebowitz 1966). The resulting cyclic coiled DNA cannot be cleaved with restriction enzymes, and it migrates through agarose gels at about twice the rate of superhelical DNA and stains poorly with ethidium bromide. Traces of this collapsed coiled form of DNA can usually be seen in plasmids prepared by thermal lysis of bacteria. However, the quantity of cyclic coiled DNA can be kept to a minimum by ensuring that the lysate is kept at 100°C for exactly the recommended time.

7. Centrifuge the bacterial lysate at maximum speed for 15 minutes at room temperature in a microfuge. Pour the supernatant into a fresh microfuge tube.

### Recovery of Plasmid DNA

8. Precipitate the nucleic acids from the supernatant by adding 40 µl of 2.5 M sodium acetate (pH 5.2) and 420 µl of isopropanol. Mix the solution by vortexing, and then allow the mixture to stand for 5 minutes at room temperature.

9. Recover the precipitated nucleic acids by centrifugation at maximum speed for 10 minutes at 4°C in a microfuge.

It is best to get into the habit of always arranging the microfuge tubes in the same way in the microfuge rotor, i.e., in order, with their plastic hinges always pointing outward. The precipitate will collect on the inside surface furthest from the center of rotation. Knowing where to look makes it easier to find visible precipitates and to dissolve "invisible" precipitates efficiently.

When preparing plasmid DNA from an *endA*<sup>-</sup> strain of *E. coli*, an extraction with phenol:chloroform should be included at this point. In brief:

- Resuspend the isopropanol-precipitated DNA pellet in 100 µl of TE (pH 8.0).
- Add 100 µl of phenol:chloroform (1:1, v/v), and vortex the mixture for 15–30 seconds.
- Separate the aqueous and organic phases by centrifugation at maximum speed for 2 minutes at room temperature in a microfuge.
- Transfer the aqueous layer to a fresh microfuge tube, and add 0.1 volume of 3 M sodium acetate (pH 5.2) and 2.5 volumes of ethanol. Recover the precipitated nucleic acids by centrifugation at maximum speed for 10 minutes in a microfuge, and rejoin the protocol at Step 10.

10. Remove the supernatant by gentle aspiration as described in Step 3 above. Stand the tube in an inverted position on a paper towel to allow all of the fluid to drain away. Use a Kimwipe or disposable pipette tip to remove any drops of fluid adhering to the walls of the tube.

The pellet of nucleic acid is usually visible as a smudge on the wall of the centrifuge tube, near the base.

11. Rinse the pellet of nucleic acid with 1 ml of 70% ethanol at 4°C. Again remove all of the supernatant by gentle aspiration as described in Step 3.

Take care with this step, as the pellet sometimes does not adhere tightly to the tube.

12. Remove any beads of ethanol that form on the sides of the tube. Store the open tube at room temperature until the ethanol has evaporated and no fluid is visible in the tube (2–5 minutes).

If the pellet of DNA is dried in a desiccator or under vacuum, it becomes difficult to dissolve under some circumstances and may denature (Svaren et al. 1987). Drying the pellet for 10–15 minutes at room temperature is usually sufficient for the ethanol to evaporate without the DNA becoming dehydrated.

13. Dissolve the nucleic acids in 50 µl of TE (pH 8.0) containing DNase-free RNase A (pancreatic RNase). Vortex the solution gently for a brief period. Store the DNA at –20°C.

# Protocol 5

---

## Preparation of Plasmid DNA by Large-scale Boiling Lysis

**P** LASMID DNA MAY BE ISOLATED FROM LARGE-SCALE (500 ml) bacterial cultures by treatment with Triton X-100 and lysozyme, followed by heating. The resulting DNA preparation may be further purified by column chromatography or centrifugation through CsCl-ethidium bromide gradients.

### MATERIALS

---

**CAUTION:** Please see Appendix 12 for appropriate handling of materials marked with <!>.

#### Buffers and Solutions

Please see Appendix 1 for components of stock solutions, buffers, and reagents. Dilute stock solutions to the appropriate concentrations.

*Antibiotic for plasmid selection*

*Chloramphenicol (34 mg/ml) <!>*

Please see the information panel on **CHLORAMPHENICOL**.

*Ethanol*

*Isopropanol*

*STE*

*STET*

*TE (pH 8.0)*

#### Enzymes and Buffers

*Lysozyme (10 mg/ml)*

Please see the information panel on **LYSOZYMES**.

*Restriction endonucleases*

#### Gels

*Agarose gel*

Please see Step 21.

#### Media

*LB, YT, or Terrific Broth*



## Centrifuges and Rotors

*Beckman SW41Ti rotor or equivalent*

*Sorvall GSA rotor or equivalent*

*Sorvall SS-34 rotor or equivalent*

## Special Equipment

*Boiling water bath*

*Bunsen burner*

*Gauze (4-ply)*

Optional, please see Step 15.

## Additional Reagents

*Step 7 of this protocol requires the reagents listed in Protocol 1 or 4 of this chapter.*

*Step 20 of this protocol requires reagents listed in Protocol 8, 9, 10, or 11 of this chapter.*

## METHOD

---

### Preparation of Cells

1. Inoculate 30 ml of rich medium (LB, YT, or Terrific Broth) containing the appropriate antibiotic either with a single colony of transformed bacteria or with 0.1–1.0 ml of a small-scale liquid culture grown from a single colony.

To ensure that the culture is adequately aerated:

- The volume of the culture flask should be at least four times greater than the volume of the bacterial culture.
- The culture flask should be loosely capped.
- The culture should be incubated in a rotary shaker set at 250 rpm.

2. Incubate the culture at the appropriate temperature with vigorous shaking (250 cycles/minute in a rotary shaker) until the bacteria reach the late log phase of growth (i.e., an  $OD_{600}$  of ~0.6).

3. Inoculate 500 ml of LB, YT, or Terrific Broth (prewarmed to 37°C) containing the appropriate antibiotic in a 2-liter flask with 25 ml of the late-log-phase culture. Incubate the culture for 2.5 hours at 37°C with vigorous shaking (250 cycles/minute on a rotary shaker).

The  $OD_{600}$  of the resulting culture should be ~0.4. The growth rates of various bacterial strains or of a single strain containing different plasmids will vary. Thus, in some cases, the culture may have to be incubated slightly longer or shorter than 2.5 hours to reach the desired optical density.

4. Add 2.5 ml of 34 mg/ml chloramphenicol. The final concentration of chloramphenicol in the culture should be 170 µg/ml. Incubate the culture for a further 12–16 hours at 37°C with vigorous shaking (250 cycles/minute on a rotary shaker).

Please see the information panel on **CHLORAMPHENICOL**.

5. Remove an aliquot (1–2 ml) of the bacterial culture to a fresh microfuge tube and store at 4°C. Harvest the remainder of the bacterial cells from the 500-ml culture by centrifugation at 2700g (4100 rpm in a Sorvall GSA rotor) for 15 minutes at 4°C. Discard the supernatant. Stand the open centrifuge bottle in an inverted position to allow all of the supernatant to drain away.

6. Resuspend the bacterial pellet in 200 ml of ice-cold STE. Collect the bacterial cells by centrifugation as described in Step 5. Store the pellet of bacteria in the centrifuge bottle at  $-20^{\circ}\text{C}$ .
7. Prepare plasmid DNA from the 1–2-ml aliquot of bacteria set aside in Step 5 by the minipreparation protocol (either Protocol 1 or 4). Analyze the minipreparation plasmid DNA by digestion with the appropriate restriction enzyme(s) to ensure that the correct plasmid has been propagated in the large-scale culture.
 

This kind of control may seem overly compulsive. However, it provides valuable insurance against errors that may be difficult to retrieve and may cause considerable loss of time.
8. Allow the frozen bacterial cell pellet from Step 6 to thaw for 5–10 minutes at room temperature. Resuspend the pellet in 10 ml of ice-cold STET. Transfer the suspension to a 50-ml Erlenmeyer flask.

## Lysis of Cells

9. Add 1 ml of a freshly prepared solution of 10 mg/ml lysozyme.
10. Use a clamp to hold the Erlenmeyer flask over the open flame of a Bunsen burner until the liquid *just* starts to boil. Shake the flask constantly during the heating procedure.
 

▲ **WARNING** During heating, keep the open neck of the flask pointing away from you and everyone else working in the lab.
11. Immediately immerse the bottom half of the flask in a large (2-liter) beaker of boiling water. Hold the flask in the boiling water for exactly 40 seconds.
 

Prolonged exposure of superhelical DNA to heat causes irreversible denaturation (Vinograd and Lebowitz 1966). The resulting cyclic coiled DNA cannot be cleaved with restriction enzymes, and it migrates through agarose gels at about twice the rate of superhelical DNA and stains poorly with ethidium bromide. Variable amounts of this form of DNA are always present in plasmids prepared by thermal lysis of bacteria. However, the quantity of cyclic coiled DNA can be kept to a minimum by ensuring that the bacterial lysate is heated *uniformly* to boiling and that the lysate is kept at  $100^{\circ}\text{C}$  for exactly the recommended time.
12. Cool the flask in ice-cold water for 5 minutes.
13. Transfer the viscous contents of the flask to an ultracentrifuge tube (Beckman SW41 or its equivalent). Centrifuge the lysate at 150,000g (30,000 rpm in a Beckman SW41Ti rotor) for 30 minutes at  $4^{\circ}\text{C}$ .
 

The denser the growth of the original bacterial culture, the more difficult it is to transfer the viscous lysate to the centrifuge tube. If absolutely necessary, the lysate can be chopped into chunks of manageable size with a pair of long-blade scissors, or it can be partially sheared by drawing it into the barrel of a 10-ml syringe. This problem generally does not arise when isolating plasmid DNA from bacterial cultures that have been treated with chloramphenicol.
14. Transfer as much of the supernatant as possible to a new tube. Discard the viscous liquid remaining in the centrifuge tube.
 

If the bacterial debris does not form a tightly packed pellet, centrifuge again at 210,000g (35,000 rpm in a Beckman SW41Ti rotor) for a further 20 minutes, and then transfer the supernatant as described above.
15. (Optional) If the supernatant contains visible strings of genomic chromatin or flocculent precipitate of proteins, filter it through 4-ply gauze before proceeding (Huang and Campbell 1993).

## Recovery of Plasmid DNA

16. Measure the volume of the supernatant. Transfer the supernatant, together with 0.6 volume of isopropanol, to a fresh centrifuge tube(s). Store the tube(s) for 10 minutes at room temperature, after mixing the contents well.
17. Recover the precipitated nucleic acids by centrifugation at 12,000g (10,000 rpm in a Sorvall SS-34 rotor) for 15 minutes at *room temperature*.  
Salt may precipitate if centrifugation is carried out at 4°C.
18. Decant the supernatant carefully, and invert the open tube(s) on a paper towel to allow the last drops of supernatant to drain away. Rinse the pellet and the walls of the tube(s) with 70% ethanol at room temperature. Drain off the ethanol, and use a Pasteur pipette attached to a vacuum line to remove any beads of liquid that adhere to the walls of the tube(s). Place the inverted, open tube(s) on a pad of paper towels for a few minutes at room temperature until no trace of ethanol is visible. At this stage, the pellet should still be damp.
19. Dissolve the pellet of nucleic acid in 3 ml of TE (pH 8.0).
20. Purify the crude plasmid DNA either by chromatography on commercial resins (please see Protocol 9), precipitation with polyethylene glycol (Protocol 8), or equilibrium centrifugation in CsCl-ethidium bromide gradients (Protocols 10 and 11).
21. Check the structure of the plasmid by restriction enzyme digestion followed by gel electrophoresis.

The typical yield of high-copy-number plasmid vectors or of amplified low-copy-number vectors prepared by this method is ~3–5 µg of DNA/ml of original bacterial culture. The yield of recombinant plasmids containing inserts of foreign DNA is usually slightly lower, depending on the size and nature of the cloned DNA fragment. Yields of ≤1.0 µg/ml indicate that the plasmid DNA is toxic to *E. coli*; the complete absence of DNA indicates that the plasmid has been lost during extraction and purification. The first problem can often be solved by switching to a low-copy-number vector and/or to a vector that carries prokaryotic transcriptional termination signals. The second problem is often the result of accidental loss of the plasmid DNA pellet after ethanol precipitation. It also occurs when the recombinant plasmid is large enough to be precipitated together with the chromosomal DNA after boiling. Such a large plasmid will also be susceptible to breakage during extraction and purification. This difficulty can be solved by using a more gentle procedure of cell lysis, such as that described in Protocol 7.

# Protocol 6

---

## Preparation of Plasmid DNA: Toothpick Minipreparations

**P**LASMID DNA CAN BE PREPARED DIRECTLY FROM BACTERIAL COLONIES plucked from the surface of agar media with toothpicks. The closed circular DNA is too dirty to be used as a substrate for most restriction enzymes. However, the toothpick method can be used to identify bacterial colonies containing recombinant plasmids after transformation, to estimate the size of the plasmids in individual transformants by agarose gel electrophoresis, and to compare the copy number of different plasmids in the same host. The nature of the insert in putative recombinant plasmids can be confirmed by Southern hybridization (please see Chapter 6, Protocol 10) and by polymerase chain reaction (PCR) (please see Chapter 8, Protocol 12).

The simple procedure described below, a modification of the method of Barnes (1977), works best with large colonies (2–3 mm diameter) and yields enough DNA to load on a single lane of an agarose gel.

In addition to Wayne Barnes' "toothpick assay," the January 28, 1977 issue of *Science* printed an apocryphal warning to would-be gene spicers of the time. On page 378, Nicholas Wade, in his best sensational style, tells of three "near disasters" in molecular cloning in which, horror of horrors, an *E. coli* with a plasmid containing a cellulase gene, a hybrid adenovirus-SV40, and an *E. coli* with a plasmid containing the SV40 genome were, or almost were, constructed. Looking back, we observe that all of these "potentially grave hazards" were later constructed in the laboratory without incident, and each provided unique insight into biotechnology, virology, oncology, and molecular cloning. It seems entirely appropriate that Barnes' assay continues to be useful while Wade's imaginary monsters have been long since laid to rest.

### MATERIALS

---

**CAUTION:** Please see Appendix 12 for appropriate handling of materials marked with <!>.

#### Buffers and Solutions

Please see Appendix 1 for components of stock solutions, buffers, and reagents. Dilute stock solutions to the appropriate concentrations.

*Antibiotic for plasmid selection*

*Bromophenol blue solution (0.4% w/v)*

or

*Cresol red solution (10 mM)*

Please see Step 10.

*EDTA (0.5 M, pH 8.0)*

*Ethidium bromide (10 mg/ml) <!>*

or

*SYBR Gold <!>*

*KCl (4 M)*

*NSS solution*

0.2 N NaOH

0.5% SDS

20% sucrose

This solution should be made fresh for each use. Store the solution at room temperature until it is required. Discard any NSS solution that remains unused.

## Gels

*Agarose gel (0.7%, 5-mm thick), cast in Tris-borate buffer or in Tris-acetate buffer without ethidium bromide*

When only a small difference in size is anticipated among plasmids, the agarose gel should be cast and run in Tris-acetate electrophoresis buffer (TAE; please see Chapter 5, Protocol 1), because of its superior ability to resolve superhelical DNAs of different sizes. Otherwise, Tris-borate-EDTA (TBE) is the better choice because of its higher buffering capacity.

*Agarose gel*

Please see Step 14.

## Media

*LB, YT, or SOB (rich broth for growing E. coli)*

*LB, YT, or SOB agar plates containing the appropriate antibiotic*

## Special Equipment

*Thermal cycler*

*Water bath preset to 70°C*

*Wooden toothpicks*

## Additional Reagents

*Step 12 of this protocol requires the reagents listed in Chapter 8, Protocol 1.*

*Step 14 of this protocol requires the reagents listed in Protocol 1 or 4 of this chapter.*

## METHOD

---

### Preparation of Cells

1. Grow bacterial colonies, transformed with recombinant plasmid, on rich agar medium (LB, YT, or SOB) containing the appropriate antibiotic until they are ~2–3 mm in diameter (~18–24 hours at 37°C for most bacterial strains).
2. Use a sterile toothpick or disposable loop to transfer a small segment of a bacterial colony to a streak or patch on a master agar plate containing the appropriate antibiotic. Transfer the remainder of the colony to a numbered microfuge tube containing 50  $\mu$ l of sterile 10 mM EDTA (pH 8.0).

In addition to the colonies under test, transfer a number of colonies containing the “empty,” non-recombinant plasmid vector. These samples are used as markers in gel electrophoresis (please see Step 11).
3. Repeat Step 2 until the desired number of colonies has been harvested.
4. When all of the colonies have been replicated and transferred, incubate the master plate for several hours at 37°C and then store it at 4°C until the results of the gel electrophoresis (Step

11 of this protocol) are available. Colonies containing plasmids of the desired size can then be recovered from the master plate.

5. While the master plate is incubating, process the bacterial suspensions as follows: To each microfuge tube in turn, add 50  $\mu$ l of a freshly made solution of NSS. Close the top of the tubes and then mix their contents by vortexing for 30 seconds.
6. Transfer the tubes to a 70°C water bath. Incubate the tubes for 5 minutes and then allow them to cool to room temperature.
7. To each tube, add 1.5  $\mu$ l of a solution of 4 M KCl. Vortex the tubes for 30 seconds.
8. Incubate the tubes for 5 minutes on ice.
9. Remove bacterial debris by centrifugation at maximum speed for 3 minutes at 4°C in a microfuge.

### Analysis of Plasmids by Gel Electrophoresis

10. Transfer each of the supernatants in turn to fresh microfuge tubes. Add to each tube 0.5  $\mu$ l of a solution containing 0.4% bromophenol blue if the samples are to be analyzed only by agarose gel electrophoresis or 2  $\mu$ l of 10 mM cresol red if the samples are to be analyzed both by PCR and by agarose gel electrophoresis. Load 50  $\mu$ l of the supernatant into a slot (5 mm in length  $\times$  2.5 mm in width) cast in a 0.7% agarose gel (5 mm thick).

The agarose gel is poured and run in the absence of ethidium bromide because the rate of migration of superhelical DNA in the absence of ethidium bromide reflects its molecular weight more faithfully than its rate of migration in the presence of the intercalating dye. This simplifies the task of distinguishing among plasmids of different sizes.

11. After the bromophenol blue dye has migrated two-thirds to three-fourths the length of the gel, or the cresol red dye about one-half the length of the gel, stain the gel by soaking it for 30–45 minutes in a solution of ethidium bromide (0.5  $\mu$ g/ml in H<sub>2</sub>O) at room temperature. Examine and photograph the gel under UV illumination.

More sensitive dyes such as SYBR Gold (Molecular Probes) can be used to stain the agarose gel after electrophoresis when working with low-copy-number plasmids (please see Chapter 5, Protocol 1). For more information, please see the discussion on SYBR dyes in Appendix 9.

Colonies that contain a recombinant plasmid will yield bands of DNA that migrate through the agarose gel more slowly than the empty vector DNA. It is important to use as controls plasmids of known size that have been prepared by the toothpick method. Plasmids prepared by other methods are not reliable as controls because they will be dissolved in buffers of different ionic strengths and constitutions. The rate of migration of superhelical DNAs can be markedly affected by the ionic strength of the solution loaded into the wells of the gel.

The pattern of bands can be quite complicated, consisting of superhelical, open circular, and linear forms of plasmid DNAs, in addition, perhaps, to traces of bacterial chromosomal DNA.

12. If cresol red has been used at Step 10, analyze the supernatants by performing PCR as described in Chapter 8, Protocol 1, using the remainder of each sample as a template.

Cresol red (Merck Index) is orange to amber in acidic solutions (pH 2–3), yellow in solutions of pH 7.2, and red in alkaline solutions. In contrast to bromophenol blue and xylene cyanol, cresol red does not inhibit the thermostable DNA polymerase from *Thermus aquaticus* (*Taq* polymerase) (Hoppe et al. 1992). Thus, DNA solutions containing cresol red are viable templates in most amplification reactions. The dye migrates between xylene cyanol and bromophenol blue during agarose gel electrophoresis, with a size of ~300 bp in a 2% agarose gel (Hoppe et al. 1992). Cresol red does not produce a shadow on photographs of agarose gels stained with ethidium bromide.

13. Prepare small-scale cultures of the putative recombinant clones by inoculating 2 ml of liquid medium (LB, YT, or SOB) containing the appropriate antibiotic with bacteria growing on the master plate.

It is not necessary to wait for florid growth of bacteria on the master plate. Even a faint opaque film of bacteria is sufficient to locate the desired isolates and to inoculate liquid cultures.

14. Use the small-scale bacterial cultures to generate minipreparations (please see Protocol 1 or 4) of the putative recombinant plasmids. Analyze the plasmid DNAs by digestion with restriction enzymes and agarose gel electrophoresis to confirm that they have the desired size and structure.

# Protocol 7

---

## Preparation of Plasmid DNA by Lysis with SDS

**T**HIS GENTLE METHOD (ADAPTED FROM GODSON AND VAPNEK 1973) has advantages over the alkaline lysis and boiling methods when dealing with large plasmids (>15 kb). However, the price of lenity in this case is low yield: A significant fraction of the plasmid DNA becomes enmeshed in the cell debris and is lost at an early stage of the protocol.

### MATERIALS

---

**CAUTION:** Please see Appendix 12 for appropriate handling of materials marked with <!.>.

#### Buffers and Solutions

Please see Appendix 1 for components of stock solutions, buffers, and reagents. Dilute stock solutions to the appropriate concentrations.

*Antibiotic for plasmid selection*

*Chloramphenicol (34 mg/ml) <!.>*

Optional, please see Step 4. Please see the information panel on **CHLORAMPHENICOL**.

*Chloroform <!.>*

*EDTA (0.5 M, pH 8.0)*

*Ethanol*

*NaCl (5 M)*

*Phenol:chloroform (1:1, v/v) <!.>*

*SDS (10% w/v)*

*STE, ice cold*

*TE (pH 8.0)*

*Tris-sucrose*

#### Enzymes and Buffers

*Lysozyme (10 mg/ml)*

Please see the information panel on **LYSOZYMES**.

*Restriction endonucleases*

#### Gels

*Agarose gels*

Please see Steps 8 and 22.



## Media

*LB, YT, or Terrific Broth*

## Centrifuges and Rotors

*Beckman type-50 ultracentrifuge rotor or equivalent with Oak Ridge plastic centrifuge tubes (30-ml screw cap, Nalgene)*

*Sorvall GSA rotor or equivalent*

## Special Equipment

*Sturdy glass rod*

## Additional Reagents

*Step 8 of this protocol requires the reagents listed in Protocol 1 or 4 of this chapter.*

*Step 21 of this protocol requires the reagents listed in Protocol 9 or 10 of this chapter.*

## METHOD

---

### Preparation of Cells

1. Inoculate 30 ml of rich medium (LB, YT, or Terrific Broth) containing the appropriate antibiotic with a single transformed bacterial colony or with 0.1–1.0 ml of a late-log-phase culture grown from a single transformed colony.
2. Incubate the culture with vigorous shaking until the bacteria enters the late log phase of growth (i.e., an  $OD_{600}$  of  $\sim 0.6$ ).

To ensure that the culture is adequately aerated:

  - The volume of the culture flask should be at least four times greater than the volume of the bacterial culture.
  - The flask should be loosely capped.
  - The culture should be incubated with vigorous agitation.
3. Inoculate 500 ml of LB, YT, or Terrific Broth (prewarmed to 37°C) containing the appropriate antibiotic in a 2-liter flask with 25 ml of the late-log-phase culture. Incubate the culture for  $\sim 2.5$  hours at 37°C with vigorous shaking (250 cycles/minute on a rotary shaker).

The  $OD_{600}$  of the resulting culture should be  $\sim 0.4$ . The growth rates of various bacterial strains or of a single strain containing different plasmids will vary. Thus, in some cases, the culture may have to be incubated slightly longer or shorter than 2.5 hours to reach the desired optical density.
4. For relaxed plasmids with low or moderate copy numbers, add 2.5 ml of 34 mg/ml chloramphenicol. The final concentration of chloramphenicol in the culture should be 170  $\mu\text{g/ml}$ .

▲ **IMPORTANT** For high-copy-number plasmids, do not add chloramphenicol.
5. Incubate the culture for a further 12–16 hours at 37°C with vigorous shaking (250 cycles/minute on a rotary shaker)
6. Remove an aliquot (1–2 ml) of the bacterial culture to a fresh microfuge tube and store it at 4°C. Harvest the remainder of the bacterial cells from the 500-ml culture by centrifugation at 2700g (4100 rpm in a Sorvall GSA rotor) for 15 minutes at 4°C. Discard the supernatant. Stand the open centrifuge bottle in an inverted position to allow all of the supernatant to drain away.

7. Resuspend the bacterial pellet in 200 ml of ice-cold STE. Collect the bacterial cells by centrifugation as described in Step 6. Store the pellet of bacteria in the centrifuge bottle at  $-20^{\circ}\text{C}$ .
8. Use one of the methods described in Protocol 1 or 4 to prepare plasmid DNA from the 1–2-ml aliquot of bacterial culture set aside in Step 6. Analyze the miniprep plasmid DNA by digestion with the appropriate restriction enzyme(s) and agarose gel electrophoresis to ensure that the correct plasmid has been propagated in the large-scale culture.

This kind of control may seem a little overly compulsive. However, it provides valuable insurance against errors that may be difficult to retrieve and may cause considerable loss of time.

## Lysis of Cells

9. Allow the frozen bacterial cell pellet from Step 7 to thaw at room temperature for 5–10 minutes. Resuspend the pellet in 10 ml of ice-cold Tris-sucrose solution. Transfer the suspension to a 30-ml plastic screw-cap tube.
10. Add 2 ml of a freshly prepared lysozyme solution (10 mg/ml) followed by 8 ml of 0.25 M EDTA (pH 8.0).
11. Mix the suspension by gently inverting the tube several times. Store the tube on ice for 10 minutes.

The combination of lysozyme and EDTA breaks down the bacterial cell walls and punctures the outer membrane. The resulting spheroplasts, although leaky, are stabilized by the isosmotic sucrose solution.
12. Add 4 ml of 10% SDS. Immediately mix the contents of the tube with a glass rod so as to disperse the solution of SDS evenly throughout the bacterial suspension. Be as gentle as possible to minimize shearing of the liberated chromosomal DNA.
13. As soon as mixing is completed, add 6 ml of 5 M NaCl (final concentration = 1 M). Again, use a glass rod to mix the contents of the tube gently but thoroughly. Place the tube on ice for at least 1 hour.

## Recovery of Plasmid DNA

14. Remove high-molecular-weight DNA and bacterial debris by centrifugation at 71,000g (30,000 rpm in a Beckman Type 50 rotor) for 30 minutes at  $4^{\circ}\text{C}$ . Carefully transfer the supernatant to a 50-ml disposable plastic centrifuge tube. Discard the pellet.

If the bacterial debris does not form a tightly packed pellet, centrifuge again at 96,000g (35,000 rpm in a Beckman Type 50 rotor) for a further 20 minutes, and transfer as much of the supernatant as possible to a fresh tube. Discard the viscous liquid remaining in the centrifuge tube.
15. Extract the supernatant once with phenol:chloroform and once with chloroform.
16. Transfer the aqueous phase to a 250-ml centrifuge bottle. Add 2 volumes (~60 ml) of ethanol at room temperature. Mix the solution well. Store the solution for 1–2 hours at room temperature.
17. Recover the nucleic acids by centrifugation at 5000g (5500 rpm in a Sorvall GSA rotor or 5100 rpm in a Sorvall HS4 swing-out rotor) for 20 minutes at  $4^{\circ}\text{C}$ .

Swing-out (horizontal) rotors are better than angle rotors for this step, since they concentrate the nucleic acids on the bottom of the bottle rather than smearing them on the walls.
18. Discard the supernatant. Wash the pellet and sides of the centrifuge tube with 70% ethanol at room temperature and then centrifuge as in Step 17.

19. Discard as much of the ethanol as possible, and then invert the centrifuge bottle on a pad of paper towels to allow the last of the ethanol to drain away. Use a vacuum aspirator to remove droplets of ethanol from the walls of the centrifuge bottle. Stand the bottle in an inverted position until no trace of ethanol is visible. At this stage, the pellet should still be damp.
20. Dissolve the damp pellet of nucleic acid in 3 ml of TE (pH 8.0).
21. Purify the crude plasmid DNA either by chromatography on commercial resins (please see Protocol 9) or isopycnic centrifugation in CsCl-ethidium bromide gradients (please see Protocols 10 and 11).
  - Large plasmids (>15 kb) are vulnerable to nicking during the several precipitation steps that are used in purification of plasmid DNA by polyethylene glycol.
22. Check the structure of the plasmid by restriction enzyme digestion followed by gel electrophoresis.

# Protocol 8

---

## Purification of Plasmid DNA by Precipitation with Polyethylene Glycol

**T**HIS METHOD WAS ORIGINALLY DEvised BY RICHARD TREISMAN (ICRF, London, United Kingdom) following the work of Lis (1980), who pioneered the use of polyethylene glycol (PEG) to fractionate DNAs of different sizes. Treisman's method is widely used to purify plasmid DNA prepared by the alkaline lysis method (Protocol 3). Crude preparations of plasmid DNA are first treated with lithium chloride to precipitate large RNAs and with RNase to digest smaller contaminating RNAs. A solution of PEG in high salt is then used to precipitate the large plasmid DNA selectively, leaving short RNA and DNA fragments in the supernatant. The precipitated plasmid DNA is purified by extraction with phenol:chloroform and ethanol precipitation. A modification of the Treisman procedure is described here in which a solution of PEG and  $MgCl_2$  is used to precipitate the plasmid DNA (Nicoletti and Condorelli 1993). For further information, please see the information panel on **POLYETHYLENE GLYCOL**.

Precipitation with PEG/ $MgCl_2$  differs from purification of plasmid DNAs by column chromatography (Protocol 9) and equilibrium centrifugation in CsCl-ethidium bromide gradients (Protocol 10) in one major respect: It does not efficiently separate nicked circular molecules from the closed circular form of plasmid DNA. The latter two protocols are the methods of choice for the purification of very large plasmids (>15 kb) that are vulnerable to nicking and closed circular plasmids that are to be used for biophysical measurements. However, plasmid DNA purified by PEG/ $MgCl_2$  precipitation is suitable for all enzymatic reactions commonly used in molecular cloning (including DNA sequencing) and can also be used to transfect mammalian cells with high efficiency.

### **LITHIUM CHLORIDE**

LiCl is a strong dehydrating reagent that lowers the solubility of RNA (Hearst and Vinograd 1961a,b) and strips proteins from chromatin (Kondo et al. 1979). Contaminating high-molecular-weight RNA and proteins can therefore be precipitated from crude plasmid preparations by high concentrations of LiCl and removed by low-speed centrifugation (e.g., please see Kondo et al. 1991). The use of LiCl as a selective precipitator of high-molecular-weight RNA was first reported in 1963 by Bob Williamson and colleagues (Barlow et al. 1963).

## MATERIALS

---

**CAUTION:** Please see Appendix 12 for appropriate handling of materials marked with <!.>.

### Buffers and Solutions

Please see Appendix 1 for components of stock solutions, buffers, and reagents. Dilute stock solutions to the appropriate concentrations.

*Chloroform* <!.>

*Ethanol*

*Isopropanol*

*LiCl* (5 M)

Please see the panel on **LITHIUM CHLORIDE**.

*PEG-MgCl<sub>2</sub> solution* <!.>

*Phenol:chloroform* (1:1, v/v) <!.>

*Sodium acetate* (3 M, pH 5.2)

*TE* (pH 8.0)

*TE* (pH 8.0) containing 20 µg/ml RNase A

### Nucleic Acids and Oligonucleotides

*Crude plasmid preparation*

Use material from either Step 17 of Protocol 3 or Step 19 of Protocol 5 of this chapter.

### Centrifuges and Rotors

*Sorvall SS-34 or equivalent*

### Special Equipment

*Ice water bath*

## METHOD

---

1. Transfer 3 ml of the crude large-scale plasmid preparation to a 15-ml Corex tube and chill the solution to 0°C in an ice bath.
2. Add 3 ml of an ice-cold solution of 5 M LiCl to the crude plasmid preparation, mix well, and centrifuge the solution at 12,000g (10,000 rpm in a Sorvall SS-34 rotor) for 10 minutes at 4°C.
3. Transfer the supernatant to a fresh 30-ml Corex tube. Add an equal volume of isopropanol. Mix well. Recover the precipitated nucleic acids by centrifugation at 12,000g (10,000 rpm in a Sorvall SS-34 rotor) for 10 minutes at room temperature.
4. Decant the supernatant carefully, and invert the open tube to allow the last drops of supernatant to drain away. Rinse the pellet and the walls of the tube with 70% ethanol at room temperature. Carefully discard the bulk of the ethanol, and then use a vacuum aspirator to remove any beads of liquid that adhere to the walls of the tube. Place the inverted, open tube on a pad of paper towels for a few minutes until no trace of ethanol is visible. At this stage, the pellet should still be damp.
5. Dissolve the damp pellet of nucleic acid in 500 µl of TE (pH 8.0) containing RNase A. Transfer the solution to a microfuge tube and store it for 30 minutes at room temperature.

6. Extract the plasmid-RNase mixture once with phenol:chloroform and once with chloroform.
7. Recover the DNA by standard ethanol precipitation.
8. Dissolve the pellet of plasmid DNA in 1 ml of sterile H<sub>2</sub>O, and then add 0.5 ml of PEG-MgCl<sub>2</sub> solution.
9. Store the solution for ≥10 minutes at room temperature, and then collect the precipitated plasmid DNA by centrifugation at maximum speed for 20 minutes at room temperature in a microfuge.
10. Remove traces of PEG by resuspending the pellet of nucleic acid in 0.5 ml of 70% ethanol. Collect the nucleic acid by centrifugation at maximum speed for 5 minutes in a microfuge.
11. Remove the ethanol by aspiration and repeat Step 10. Following the second rinse, store the open tube on the bench for 10–20 minutes to allow the ethanol to evaporate.
12. Dissolve the damp pellet in 500 μl of TE (pH 8.0). Measure the OD<sub>260</sub> of a 1:100 dilution in TE (pH 8.0) of the solution, and calculate the concentration of the plasmid DNA assuming that 1 OD<sub>260</sub> = 50 μg of plasmid DNA/ml.  
For information on absorption spectroscopy of DNA, please see Appendix 8.
13. Store the DNA in aliquots at –20°C.

# Protocol 9

---

## Purification of Plasmid DNA by Chromatography

**D**URING THE 1990S, MANY CLONERS — ESPECIALLY THE YOUNG — became addicted to commercially available chromatography resins used to purify plasmid DNA to near homogeneity. Their dependence on these resins, most of which come in the form of a kit, is a remarkable phenomenon. After all, isolation and purification of plasmid DNAs by conventional techniques are hardly intellectual challenges, and there is no convincing evidence that old-fashioned plasmid preparations are inferior to those emerging from the backend of a kit. Why, then, have cloners turned to expensive kits, whose components are largely unknown to them, in preference to well-tried, published methods that use simple ingredients? A small part of the answer must lie in the incessant advertising by manufacturers, whose aim is to persuade the gullible that they will become better scientists by using kits to purify their plasmids. These kits also play on the fear of failure. No one wants to screw up a routine plasmid preparation — so much better to avoid embarrassment by buying a kit and blaming the manufacturer if something goes wrong.

On the positive side, kits have changed for the better the way cloning in plasmids is done. In the old days, when dirty minipreparations of plasmids were the norm, vectors were routinely purified by buoyant density centrifugation in CsCl-ethidium bromide gradients; when enzymes to manipulate DNA were less reliable than they now are, the ability to generate fragments of DNA with desired termini and to join them accurately to plasmid vectors was an uncertain business; when the preparation of highly competent populations of *E. coli* was a form of alchemy, it was an achievement to generate even a modest number of putative recombinants. All too frequently, there was little difference between the numbers of transformed colonies generated by the vector alone and those obtained from ligation reactions. Transformants containing putative recombinant plasmids were routinely screened either by hybridization or by laborious manual analysis of many individual minipreparations. It was not uncommon in those days to process and analyze

*There is never too great a distinction made between those who have paid for the tiniest step forward and those, incomparably more numerous, who have received a convenient, indifferent knowledge, a knowledge without ordeals.*

*The Trouble with Being Born*  
by E.M. Cioran

upward of 100 minipreparations before finding a transformant containing the clone of interest. At Cold Spring Harbor Laboratory, the record, established in 1981, stood at 168 minipreparations completed by one person in the course of a single day. Today, however, with the widespread use of kits, this is not a particularly impressive number.

Effort on this scale is no longer required or expected. Cloning — even of “difficult” constructs in plasmid vectors — goes much faster and is much more efficient. The development of high-copy-number vectors has eliminated much of the need to grow and process large-scale cultures. And because of the advent of kits, the quality of the DNA in minipreparations is so high that routine purification of plasmids by buoyant density centrifugation is no longer necessary or desirable. We describe here a general method for purifying plasmid DNA using chromatographic methods. The way to carry out this protocol is to buy a kit and use it according to the manufacturer’s directions. For a further explanation of how these kits work, please read on.

The chromatography resins supplied in kits come in two general types: those that yield plasmid DNA sufficiently pure for enzymatic manipulation (e.g., PCR, restriction, and ligation) and prokaryotic cell transformation but not necessarily eukaryotic cell transfection, and those that yield quite pure plasmid DNA suitable for all of these purposes. Both types of resins can be used to purify DNA from crude lysates of bacteria prepared by methods described in Protocols 1 through 5 and in Protocol 7.

The chemical structures of most of the commercial resins are largely proprietary, which means that wily chemist colleagues cannot cheaply synthesize a large batch of resin for laboratory use (but please see Carter and Milton 1993; Boyle and Lew 1995). In general, the resins fall into two classes: those that use hydrophobic interactions to purify the nucleic acids and those that rely on mixed ion-exchange/adsorption interactions for purification (Table 1-6). The most popular resins for the generation of plasmid DNA for eukaryotic cell transfection utilize ion-exchange/adsorption interaction chromatography. The development of this class of resins is an interesting story.

It has been known since the 1950s that DNA binds in a reversible manner to silica in the presence of chaotropic salts. The interaction between double-stranded DNA and the silicate matrix is thought to be due to the dehydration of the phosphodiester backbone by chaotropic salts, which allows the exposed phosphate residues to adsorb to the silica. Once adsorbed, the double-stranded DNA remains in either a native or partially denatured (single-stranded) state and cannot be eluted from the matrix by solvents (e.g., 50% ethanol) that displace other biopolymers such as RNA and carbohydrate. However, when the immobilized DNA is rehydrated by washing with aqueous buffers (typically TE or H<sub>2</sub>O), it can be quantitatively recovered in the column effluent. This body of basic research was exploited in the 1980s by chemists such as Chuck York at Promega, and by others at different molecular biology reagent companies, to develop the resins now commercially available.

The adsorption of double-stranded DNA to silica is independent of base composition and topology. These features of the resin make it ideal for the purification of circular plasmid DNAs and long linear DNA fragments. However, the interaction is length-dependent, and DNAs that are less than 100–200 bp in length adsorb poorly to the resin. For this reason, currently available silica-based chromatography reagents are not used for purifying small DNA fragments.

The amount of resin required for purification of plasmids depends on the amount of bacterial lysate. Thus, different kits are purchased for purification of plasmid DNA from small (1–10 ml), medium (10–100 ml), or large cultures (>100 ml). The resins are supplied either in bulk, from which they may be placed in a column or syringe for use in DNA purification, or prepacked into columns for immediate use. The chemical composition of the binding, washing, and elution buffers for a particular resin is supplied by the manufacturer. A money-saving alternative is to



**TABLE 1-6 Commercially Available Resins and Their Uses**

RESIN	MANUFACTURER	CHEMISTRY	USE	NOTES
Qiagen	Qiagen	macroporous silica gel, anion-exchange (DEAE)	transfection of eukaryotic cells <sup>a</sup>	some batch-to-batch variation; pH-sensitive
QIAprep	Qiagen	silica gel	enzymic manipulation <sup>b</sup>	different columns available for purification of double- or single-stranded DNAs
Wizard	Promega	silica particle	additional ethanol precipitation required for transfection of eukaryotic cells <sup>a</sup>	inexpensive, reproducible
FlexiPrep	Pharmacia	anion exchange	enzymic manipulation <sup>b</sup>	transfection requires further purification
Glass-Max	Life Technologies	silica matrix	enzymic manipulation <sup>b</sup>	minipreps only
GeniePrep	Ambion	hydrophobic interactions, glass fiber	enzymic manipulation <sup>b</sup>	miniprep only; made in Texas
Perfect Prep	Eppendorf 5 Prime	silica matrix	transfection of eukaryotic cells <sup>a</sup>	very fast; miniprep only
ClearCut Miniprep Kit	Stratagene	silica resin, hydrophobic interaction	enzymic manipulation <sup>b</sup>	can be used for miniprep plasmid or DNA fragment purification
Concert, rapid and high purity systems	Life Technologies	silica gel	enzymic manipulation <sup>b</sup> and transfection of eukaryotic cells <sup>a</sup>	mini- and maxipreps
NucleoBond AX	Nest Group, Inc.	macroporous silica gel anion exchange	transfection of eukaryotic cells <sup>a</sup>	five column sizes; resin good for large DNA purification, including cosmids and P1 DNAs

<sup>a</sup>Plasmid DNA prepared using this resin is suitable for transfection of eukaryotic cells by one or more of the methods described in Chapter 16, for restriction enzyme digestion, for bacterial transformation, and for use as a template in PCR and DNA sequencing reactions. For transformation of less robust cell lines, such as B or T cells, or where problems are encountered, the use of endotoxin-free DNA is recommended. Endotoxin-free DNA purification kits are commercially available (e.g., Wizard PureFectin from Promega).

<sup>b</sup>Plasmid DNA prepared using this resin is suitable for restriction enzyme digestion, for bacterial transformation, or for use as a template in PCR and DNA sequencing reactions. Transfection of cultured mammalian cells with this plasmid DNA usually requires additional purification steps.

purchase a resin in bulk, followed by preparation of the column buffers. Vacuum manifolds for use with prepacked columns that allow the simultaneous preparation of miniprep plasmid DNA from as many as 96 bacterial cultures are available from several companies.

Individual manufacturers supply detailed protocols for use with a particular resin. Because the binding and elution of plasmid DNA depend on the structure and derivatization of the resin, the manufacturers' instructions should be followed to the letter.

Table 1-6 summarizes some of the salient features of the commercial resins currently available for plasmid purification.

# Protocol 10

---

## Purification of Closed Circular DNA by Equilibrium Centrifugation in CsCl-Ethidium Bromide Gradients: Continuous Gradients

**S**EPARATION OF PLASMID AND CHROMOSOMAL DNAs by buoyant density centrifugation gradients containing cesium chloride and ethidium bromide depends on differences between the amounts of ethidium bromide that can be bound to linear and closed circular DNA molecules (please see the information panel on **CESIUM CHLORIDE**).

For many years, equilibrium centrifugation in CsCl-ethidium bromide gradients was the method of choice to prepare large amounts of plasmid DNA. However, this process is expensive and time-consuming, and many alternative methods have been developed, including differential precipitation (Protocol 8) and column chromatography (Protocol 9). Nevertheless, traditionalists, of whom there are many, still believe that plasmids purified by banding in CsCl-ethidium bromide gradients are the purest and best DNAs for molecular biological experiments. Closed circular DNAs prepared by isopycnic centrifugation in CsCl-ethidium bromide gradients are contaminated by small fragments of DNA and RNA derived from the host bacteria. These small fragments take far longer to reach equilibrium in CsCl-ethidium bromide gradients than the larger plasmid DNAs. Hence, when molecules of closed circular DNA are at equilibrium, small fragments are still fairly evenly distributed throughout the gradient. This problem can be solved by abandoning CsCl-ethidium gradients and purifying plasmids by chromatography on commercial resins (Schleef and Heimann 1993), or it can be alleviated by subjecting closed circular plasmid DNA recovered from one CsCl-ethidium gradient to a second cycle of equilibrium centrifugation.

In another method, known as discontinuous CsCl gradient centrifugation (please see Protocol 11), three solutions containing different concentrations of CsCl are layered into the centrifuge tube. During subsequent centrifugation, the CsCl gradient forms more quickly, which allows the centrifugation time to be reduced to 6 hours. The resolution of closed circular plasmid DNAs from chromosomal and open circular plasmid DNAs is not quite as good in discontinuous CsCl gradients as in continuous gradients.

In the procedure for continuous gradients, described below, ethidium bromide and crude plasmid DNA are mixed with a CsCl solution of density  $\rho = \sim 1.55$ . When the mixture is centrifuged at high speed, the centrifugal force is sufficient to generate and maintain a gradient of cesium atoms. During formation of the gradient, DNAs of different buoyant densities migrate to positions in the tube at which the density of the surrounding CsCl solution equals that of the DNA itself. In earlier technology, long (24–48 hours) centrifuge times were required to bring the gradient to equilibrium. However, in modern vertical-tube rotors with their high  $g$  forces and small radii, self-forming gradients develop much more quickly than in older and slower fixed-angle rotors.

## MATERIALS

---

**CAUTION:** Please see Appendix 12 for appropriate handling of materials marked with <!>.

### Buffers and Solutions

Please see Appendix 1 for components of stock solutions, buffers, and reagents. Dilute stock solutions to the appropriate concentrations.

*CsCl (solid)*

*CsCl rebanding solution*

Optional, please see Steps 4 and 8.

*Ethanol*

*Ethidium bromide (10 mg/ml) <!>*

*Paraffin oil*

### Nucleic Acids and Oligonucleotides

*Crude plasmid preparation*

Use material from either Step 17 of Protocol 3, Step 19 of Protocol 5, or Step 20 of Protocol 7 of this chapter.

### Centrifuges and Rotors

*Sorvall SS-34 rotor or equivalent*

*Ultracentrifuge rotor (vertical rotors are preferred) and tubes*

For example, Beckman VTi65; angle Ti50, Ti65, or Ti70 rotors or their Sorvall equivalents are acceptable if centrifuge time is not a limiting factor. Use a Quick-seal polyallomer tube or equivalent.

### Special Equipment

*Hypodermic needle (21 gauge)*

*Pasteur pipette or a disposable syringe fitted with a large-gauge needle*

*Refractometer (optional)*

Although not essential, a refractometer is extremely useful for estimating the density of CsCl solutions.

*Syringe (5–10 cc) disposable, fitted with a sterile 18-gauge hypodermic needle*

### Additional Reagents

*Step 8 of this protocol requires the reagents listed in Protocol 12 or 13 of this chapter.*

## METHOD

---

1. Measure the mass of the crude plasmid DNA preparation. Measurement is best done by transferring the solution into a fresh tube that has been tared on a top-loading balance. For every gram of plasmid DNA solution, add exactly 1.01 g of solid CsCl. Close the top of the tube to prevent evaporation and then warm the solution to 30°C to facilitate the dissolution of the CsCl salt. Mix the solution gently until the salt is dissolved.

As a rule of thumb, the crude plasmid preparation from no more than 50 ml of an overnight culture should be used per gradient. As vertical tubes for the Beckman VTi65.2 rotor can accommodate ~5 ml of CsCl-ethidium bromide solution, the crude plasmid preparation from 50-ml cultures should be reconstituted in ~3 ml of TE (pH 8.0).

2. Add 100  $\mu$ l of 10 mg/ml ethidium bromide for each 5 g of original DNA solution.

The final density of the solution should be ~1.55 g/ml (refractive index = 1.3860), and the concentration of ethidium bromide should be ~200  $\mu$ g/ml. In the past, much larger amounts of ethidium bromide were used (Radloff et al. 1967). These were thought to be necessary to achieve saturating

binding of the drug to closed circular DNA and linear DNAs. However, high concentrations of unbound ethidium bromide may obscure faint bands of DNA to such an extent that UV illumination is required for visualization. Recently, lower concentrations of ethidium bromide have been used successfully, allowing bands of DNA to be seen in visible light (e.g., please see Good and Nazar 1995). However, problems can arise if gradients containing lower concentrations of ethidium bromide are overloaded with nucleic acids. In this case, there may not be sufficient drug to achieve saturation binding to closed circular DNA and linear DNAs. Because most of the ethidium bromide in CsCl-ethidium bromide gradients binds not to DNA but to bacterial RNA present in the crude preparation of plasmid DNA, this problem can be solved by treating the preparation with DNase-free RNase before ultracentrifugation. This treatment is not usually necessary if the crude plasmid preparation from a 50-ml bacterial culture is reconstituted in ~3 ml of TE (pH 8.0) and used to prepare a single 5-ml CsCl-ethidium bromide gradient.

3. If Corex glass tubes are used, centrifuge the solution at 7700g (8000 rpm in a Sorvall SS-34 rotor) for 5 minutes at room temperature. If disposable polypropylene tubes are used, centrifuge at 1100g (3000 rpm in a Sorvall SS-34 rotor) for 10 minutes.

The dark red scummy precipitate that floats to the top of the centrifuge tube consists of complexes formed between the ethidium bromide and bacterial proteins. The pellet at the bottom of the tube consists of larger chunks of bacterial debris, resulting from the lysis of the host bacteria by SDS and/or heat. These unappetizing delicacies are commonly encountered when the host bacteria are lysed by SDS or by the boiling procedure. Smaller amounts of debris are visible in alkaline lysates.

4. Use a Pasteur pipette or a disposable syringe fitted with a large-gauge needle to transfer the clear, red solution under the scum and above the pellet to a tube suitable for centrifugation in an ultracentrifuge rotor. Top off the partially filled centrifuge tubes with light paraffin oil or rebanding solution. Make sure that the weights of tubes opposite each other in the rotor are equal. Seal the tubes according to the manufacturer's instructions.

Make a note of the DNA samples loaded into each numbered place in the rotor.

5. Centrifuge the density gradients at 20°C as appropriate for the rotor:

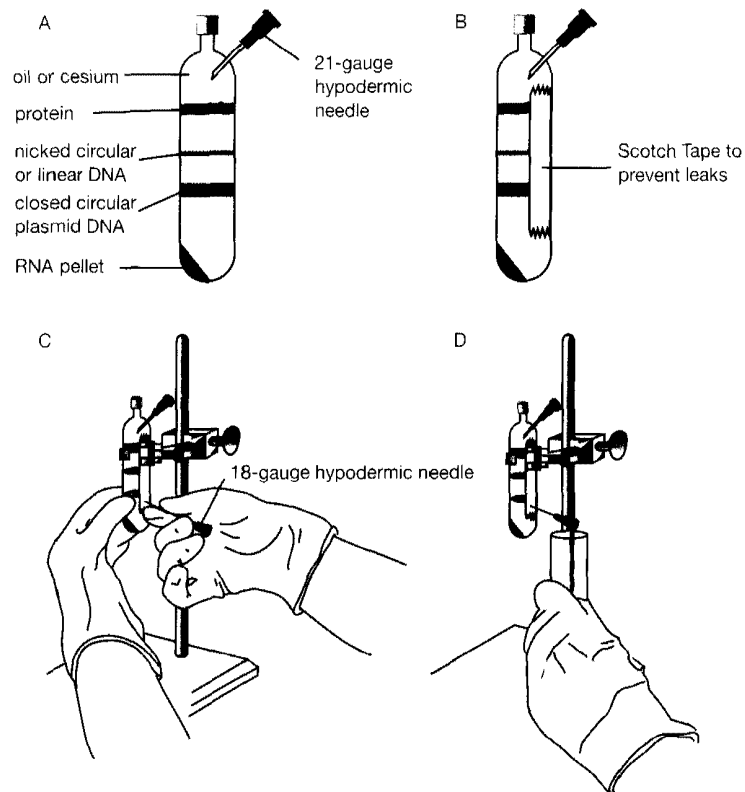
Beckman NVT 65 rotor	366,000g (62,000 rpm)	for 6 hours
Beckman VTi65 rotor	194,000g (45,000 rpm)	for 16 hours
Beckman Type 50Ti rotor	180,000g (45,000 rpm)	for 48 hours
Beckman Type 65Ti rotor	314,000g (60,000 rpm)	for 24 hours
Beckman Type 70.1Ti rotor	331,000g (60,000 rpm)	for 24 hours

6. At the end of the centrifuge run, gently remove the rotor from the centrifuge and place it on a flat surface. Carefully remove each tube and place it in a test tube rack covered with tin foil. In a dimly lit room (i.e., with the overhead fluorescent lights turned off), mount one tube in a clamp attached to a ring stand as shown in Figure 1-8.

Two bands of DNA, located in the center of the gradient, should be visible in ordinary light (please see Figure 1-8). The upper band, which usually contains less material, consists of linear bacterial (chromosomal) DNA and nicked circular plasmid DNA; the lower band consists of closed circular plasmid DNA. The deep-red pellet on the bottom of the tube consists of ethidium bromide/RNA complexes. The material between the CsCl solution and the paraffin oil is protein.

In cases where the yield of plasmid DNA is low, a hand-held, long-wavelength UV lamp can be used to visualize the DNA after centrifugation. The lamp is mounted with a clamp on the same ring stand used to support the centrifuge tube containing the separated DNAs. Shining UV light on the tube will cause the ethidium bromide-DNA complexes to fluoresce a bright orange, thereby facilitating their withdrawal with the needle/syringe. If a lamp is used, then the plasmid DNA should be retrieved as quickly as possible since excess exposure of the plasmid DNA to UV light will damage the DNA. In addition, wear a face shield to protect the eyes from damage by UV light. Whereas long-wavelength UV irradiation causes less damage to DNA than shorter wavelength, it is potent enough to still cause injury to the eyes.

7. Collect the band of closed circular DNA (please see Figure 1-8).
  - a. Use a 21-gauge hypodermic needle to make a small hole in the top of the tube to allow air to enter when fluid is withdrawn (Figure 1-8A).



**FIGURE 1-8** Collection of Superhelical Plasmid DNA from CsCl Gradients Containing Ethidium Bromide

Please see Step 7 for details.

- b.** Carefully wipe the outside of the tube with ethanol to remove any grease or oil, and then attach a piece of Scotch Tape or Time tape to the outside of the tube (Figure 1-8B)  
 The tape will act as a seal to reduce leaks after needle puncture.
  - c.** Attach a 5–10-cc disposable syringe to a sterile 18-gauge hypodermic needle and insert the needle (beveled side up) into the tube through the tape so that the open, beveled side of the needle is positioned just below the lower DNA band (closed circular plasmid DNA; Figure 1-8C).
  - d.** Slowly withdraw the plasmid DNA, taking care not to disturb the upper viscous band of chromosomal DNA (Figure 1-8D)  
 To avoid contamination with the chromosomal DNA, do not attempt to remove every visible trace of closed circular plasmid DNA from the gradient.  
 Some investigators prefer to remove the upper DNA band before removing the lower closed circular plasmid DNA band. This can be tricky, as the viscous, high-molecular-weight chromosomal DNA in the upper band can enmesh the closed circular plasmid DNA and drag it from the tube.
- 8.** Remove ethidium bromide from the DNA as described in one of the methods presented in Protocols 12 and 13.
- Some diehards reband their closed circular DNA in an effort to reduce contamination of the band of closed circular DNA with fragments of chromosomal DNA and RNA. To reband the plasmid DNA, slowly transfer the contents of the syringe to a fresh Quick-seal polyallomer centrifugation tube and fill the tube with CsCl rebanding solution. Seal the tube, repeat the centrifugation, and recover the closed circular plasmid DNA as described in Steps 5 through 7 above. Remove ethidium bromide from the DNA as described in Protocol 12 or 13.

# Protocol 11

---

## Purification of Closed Circular DNA by Equilibrium Centrifugation in CsCl-Ethidium Bromide Gradients: Discontinuous Gradients

**F**OR CENTRIFUGATION THROUGH DISCONTINUOUS OR PREFORMED CsCl gradients, solutions containing different concentrations of CsCl are layered into the centrifuge tube. The sample can be in the middle layer (three-step gradient) or the bottom layer (two-step gradient). During subsequent centrifugation, the DNA finds its isopycnic point during formation of the gradient, which allows the centrifugation time to be greatly reduced. For further information on cesium chloride, please see the information panel on **CESIUM CHLORIDE**.

Because discontinuous gradients do not come to true equilibrium, the resolution of closed circular plasmid DNAs from chromosomal DNA is not as high as in self-forming gradients (please see Protocol 10). In general, three-step gradients give better results in a shorter time than two-step gradients (Dorin and Bornecque 1995).

---

### MATERIALS

---

**CAUTION:** Please see Appendix 12 for appropriate handling of materials marked with <!>.

#### Buffers and Solutions

Please see Appendix 1 for components of stock solutions, buffers, and reagents. Dilute stock solutions to the appropriate concentrations.

*CsCl (solid)*

*CsCl layers for a three-step discontinuous gradient*

Prepare the layers for a three-step gradient as described in Table 1-7.

*Ethidium bromide (10 mg/ml) <!>*

*TE (pH 8.0)*

#### Nucleic Acids and Oligonucleotides

##### *Crude plasmid preparation*

Use material from either Step 16 of Protocol 3, Step 18 of Protocol 5, or Step 19 of Protocol 7 of this chapter.

As a rule of thumb, the crude plasmid DNA prepared from no more than 50 ml of an overnight culture should be used per gradient. The crude plasmid preparation from a 100-ml culture should be reconstituted in ~0.9 ml of TE (pH 8.0), which is enough to form the middle layer of two discontinuous gradients.

**TABLE 1-7 Three-step Discontinuous Gradient Layers**

LAYER	MOLARITY CSCL (W/W)	REFRACTIVE INDEX	PREPARATION <sup>a</sup>
Top layer	2.806 (35%)	1.3670	Dissolve 4.720 g of CsCl in 8 ml of TE (pH 8.0). Adjust the volume to exactly 10 ml. Then add 120 $\mu$ l of 10 mg/ml ethidium bromide.
Middle layer	3.870 (44%)	1.3792	Dissolve 0.8 g of CsCl in exactly 1 ml of the crude DNA preparation. Then add 30 $\mu$ l of 10 mg/ml ethidium bromide.
Bottom layer	6.180 (59%)	1.4052	Dissolve 10.4 g of CsCl in 7 ml of TE. Adjust the volume to exactly 10 ml. Then add 120 $\mu$ l of 10 mg/ml ethidium bromide.

<sup>a</sup>Molecular biology grade CsCl is available in solid form from several commercial manufacturers.

## Special Equipment

*Hypodermic needle (21 gauge)*

*Refractometer (optional)*

Although not essential, a refractometer is extremely useful for estimating the density of CsCl solutions.

*Syringes (3 cc, 5 cc, and 5–10 cc) fitted with 18-gauge bone marrow (10 cm) needles*

*Tuberculin syringe (1 cc) fitted with an 18-gauge bone marrow (10 cm) needle*

## Centrifuges and Rotors

*Ultracentrifuge rotor and tubes*

Beckman Type 70.1Ti or Sorvall 65.13 with 5-ml or 10-ml polyallomer ultracentrifuge tubes (Beckman Quick-Seal or equivalent).

## Additional Reagents

*Step 6 of this protocol requires the reagents listed in Protocol 12 or 13 of this chapter.*

## METHOD

1. Use a 3-cc hypodermic syringe equipped with an 18-gauge bone marrow (10 cm) needle to transfer 1.5 ml of the top layer (35%) CsCl solution to a 5-ml polyallomer ultracentrifuge tube (Beckman Quick-Seal or equivalent).
2. Use a 1-cc tuberculin syringe equipped with an 18-gauge bone marrow (10 cm) needle to layer 0.5 ml of the middle layer (44%) CsCl solution, containing the plasmid DNA, into the bottom of the tube *under* the top layer solution.
3. Use a 5-cc hypodermic syringe equipped with an 18-gauge bone marrow (10 cm) needle to fill the tube by layering the bottom layer (59%) CsCl solution *under* the middle layer CsCl solution.
4. Centrifuge the sealed tubes at 330,000g (60,000 rpm in a Beckman Type 70.1Ti rotor) for 5 hours. Make sure that the weights of tubes opposite each other in the rotor are equal. Seal the tubes according to the manufacturer's instructions.

The use of a centrifuge and rotor capable of higher speeds can reduce the centrifugation time still further. For example, in a VTi90 rotor in a Beckman XL-90, only 20 minutes of centrifugation is needed.

5. Collect the band of closed circular DNA (Figure 1-8, p. 1.68):
  - a. Use a 21-gauge hypodermic needle to make a small hole in the top of the tube to allow air to enter when fluid is withdrawn.
  - b. Carefully wipe the outside of the tube with ethanol to remove any grease or oil, and then attach a piece of Scotch Tape or Time tape to the outside of the tube.

The tape will act as a seal to reduce leaks after needle puncture.
  - c. Attach a 5–10-cc disposable syringe to a sterile 18-gauge hypodermic needle and insert the needle (beveled side up) into the tube through the tape so that the open, beveled side of the needle is positioned just below the lower DNA band (closed circular plasmid DNA).
  - d. Slowly withdraw the plasmid DNA, taking care not to disturb the upper viscous band of chromosomal DNA.

To avoid contamination with the chromosomal DNA, do not attempt to remove every visible trace of closed circular plasmid DNA from the gradient.

Some investigators prefer to remove the upper DNA band before removing the lower closed circular plasmid DNA band. This can be tricky, as the viscous high-molecular-weight chromosomal DNA in the upper band can enmesh the closed circular plasmid DNA and drag it from the tube.
6. Remove ethidium bromide from the DNA as described in one of the methods presented in Protocol 12 or 13.



# Protocol 12

---

## Removal of Ethidium Bromide from DNA by Extraction with Organic Solvents

**E**THIDIUM BROMIDE IS USUALLY REMOVED FROM DNA purified through a CsCl gradient by repeated extraction with organic solvents. The CsCl is subsequently removed by dialysis or by precipitation. Protocol 13 describes an alternative method for removal of CsCl by ion-exchange chromatography. The two methods are both highly effective in removing ethidium bromide from DNA purified by equilibrium centrifugation in CsCl-ethidium bromide gradients. For further information, please see the information panel on **ETHIDIUM BROMIDE**

### MATERIALS

---

**CAUTION:** Please see Appendix 12 for appropriate handling of materials marked with <!.>.

#### Buffers and Solutions

Please see Appendix 1 for components of stock solutions, buffers, and reagents. Dilute stock solutions to the appropriate concentrations.

*Ethanol*

*Isoamyl alcohol or n-butanol, saturated with H<sub>2</sub>O <!.>*

One or the other of these organic solvents is required to remove ethidium bromide from the DNA preparation after centrifugation.

*Phenol <!.>*

Optional, please see Step 13.

*Phenol:chloroform (1:1 v/v) <!.>*

Optional, please see Step 13.

*TE (pH 8.0)*

#### Nucleic Acids and Oligonucleotides

*DNA sample, purified through CsCl gradient*

Use material from either Step 7 of Protocol 10 or Step 5 of Protocol 11 of this chapter.

#### Centrifuges and Rotors

*Sorvall RT-6000 centrifuge with an HL-4 rotor and 50-ml buckets or equivalent*

*Sorvall SS-34 rotor or equivalent*

#### Special Equipment

*Dialysis tubing and clips*

or

*Equipment for spin dialysis through a microconcentrator (Amicon)*

Optional, please see Step 6. For preparation of dialysis tubing, please see Appendix 8.

## METHOD

---

### Extraction of DNA Solution to Remove Ethidium Bromide

1. To the solution of DNA in a glass or polypropylene tube, add an equal volume of either water-saturated *n*-butanol or isoamyl alcohol. Close the cap of the tube tightly.
2. Mix the organic and aqueous phases by vortexing.
3. Centrifuge the mixture at 450g (1500 rpm in a Sorvall RT-6000 centrifuge with an HL-4 rotor and 50-ml buckets) for 3 minutes at room temperature or stand the solution at room temperature until the organic and aqueous phases have separated.
4. Use a Pasteur pipette to transfer the upper (organic) phase, which is now a beautiful deep pink color, to an appropriate waste container.
5. Repeat the extraction (Steps 1–4) four to six times until all the pink color disappears from both the aqueous phase and organic phases.

### Removal of CsCl from the DNA Solution

6. Remove the CsCl from the DNA solution by ethanol precipitation (please follow Steps 7 through 12), by spin dialysis through a microconcentrator (Amicon), or by dialysis overnight (16 hours) against 2 liters of TE (pH 8.0) (change buffer frequently). If one of the latter two methods is used, then proceed to Step 13.
7. To precipitate the DNA from the CsCl-DNA solution, measure the volume of the CsCl solution, add three volumes of H<sub>2</sub>O, and mix the solution well.

This addition dilutes the CsCl and prevents precipitation of the salt by ethanol.
8. Add 8 volumes of ethanol (1 volume is equal to that of the CsCl-DNA solution prior to dilution with H<sub>2</sub>O in Step 7) to the DNA solution and mix well. Store the mixture for at least 15 minutes at 4°C.

Higher recoveries of DNA can be realized if the precipitation reaction is allowed to occur overnight at 4°C.

▲ **IMPORTANT** CsCl precipitates if the ethanolic solution of DNA is stored at –20°C.
9. Collect the precipitate of DNA by centrifugation at 20,000g (13,000 rpm in a Sorvall SS-34 rotor) for 15 minutes at 4°C.
10. Decant the supernatant to a fresh centrifuge tube. Add an equal volume of absolute ethanol to the supernatant. Store the mixture for at least 15 minutes at 4°C and then collect the precipitate of DNA by centrifugation at 20,000g (13,000 rpm in a Sorvall SS-34 rotor) for 15 minutes.

Not all of the plasmid DNA is recovered in the first precipitation, hence the addition of a second batch of ethanol (Hildeman and Muller 1997).
11. Wash the two DNA precipitates with 70% ethanol. Remove as much of the 70% ethanol as possible and then allow any remaining fluid to evaporate at room temperature.
12. Dissolve the precipitated DNA in 2 ml of H<sub>2</sub>O or TE (pH 8.0).

For DNA sequencing, the DNA should be dissolved in H<sub>2</sub>O. TE (pH 8.0) is a better option if the DNA is to be stored for a long period of time.

13. If the resuspended DNA contains significant quantities of ethidium bromide, as judged from its color or its emission of fluorescence when illuminated by UV light, extract the solution once with phenol and once with phenol:chloroform, and then again precipitate the DNA with ethanol.
14. Measure the  $OD_{260}$  of the final solution of DNA, and calculate the concentration of DNA. Store the DNA in aliquots at  $-20^{\circ}\text{C}$ .

# Protocol 13

---

## Removal of Ethidium Bromide from DNA by Ion-exchange Chromatography

**E**THIDIUM BROMIDE MAY BE REMOVED FROM DNA PURIFIED through a CsCl gradient by ion-exchange chromatography. The CsCl is subsequently removed by precipitation with ethanol. For an alternative method for removal of CsCl by repeated extraction with organic solvents, please see Protocol 12.

### MATERIALS

---

**CAUTION:** Please see Appendix 12 for appropriate handling of materials marked with <!.>.

#### Buffers and Solutions

Please see Appendix 1 for components of stock solutions, buffers, and reagents. Dilute stock solutions to the appropriate concentrations.

*Ethanol*

*HCl (1 N) <!.>*

*NaCl (5 M)*

*Phenol <!.>*

Optional, please see Step 9.

*Phenol:chloroform (1:1, v/v) <!.>*

Optional, please see Step 9.

*TE (pH 8.0)*

*TEN buffer*

*TEN buffer containing 0.2% sodium azide <!.>*

#### Nucleic Acids and Oligonucleotides

*DNA sample, purified through CsCl gradient*

Use material from either Step 7 of Protocol 10 or Step 5 of Protocol 11 of this chapter.

#### Centrifuges and Rotors

*Sorvall SS-34 rotor or equivalent*

#### Special Equipment

*Dowex AG50W-X8 (100–200 dry mesh size)*

Dowex AG50W-X8, a cation exchange resin, is available from Bio-Rad.

Glass wool

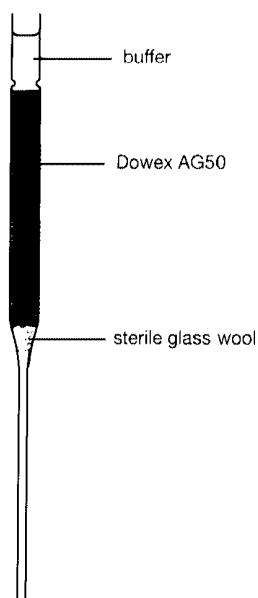
Refractometer (optional)

Although not essential, a refractometer is extremely useful for estimating the density of CsCl solutions.

## METHOD

---

1. Before using, equilibrate the Dowex AG50 resin:
  - a. Stir ~20 g of Dowex AG50 in ~100 ml of 1 M NaCl for 5 minutes. Allow the resin to settle, and remove the supernatant by aspiration.
  - b. Add ~100 ml of 1 N HCl, and stir the slurry for a further 5 minutes. Again allow the resin to settle, and remove the supernatant by aspiration.
  - c. Continue the process with two washes with H<sub>2</sub>O (100 ml each), followed by one wash with 100 ml of TEN buffer.
  - d. Store the equilibrated resin at 4°C in TEN buffer containing 0.2% sodium azide.
2. Construct a 1-ml column of Dowex AG50 in a Pasteur pipette as shown in Figure 1-9.
3. Remove the buffer above the resin, and rinse the column with 2 column volumes of TE (pH 8.0). Apply the solution of DNA containing ethidium bromide and CsCl directly to the resin.
4. Immediately begin collecting the effluent from the column. After all of the DNA solution has entered the column, wash the resin with 1.2 column volumes of TE (pH 8.0) and continue to collect the eluate into a 30-ml Corex tube.
5. After the column has run dry, dilute the eluate with 2.5 column volumes of H<sub>2</sub>O.



**FIGURE 1-9** Removal of Ethidium Bromide from DNA by Chromatography through Dowex AG50

Please see Step 1 for details.

6. Precipitate the DNA by adding eight volumes of ethanol followed by incubation for 15 minutes at 4°C. Collect the DNA by centrifugation at 17,000g (12,000 rpm in a Sorvall SS-34 rotor) for 15 minutes at 4°C.
7. Decant the supernatant to a fresh centrifuge tube. Add an equal volume of absolute ethanol to the supernatant. Store the mixture for at least 15 minutes at 4°C and then collect the precipitate of DNA by centrifugation at 20,000g (13,000 rpm in a Sorvall SS-34 rotor) for 15 minutes.

Not all of the plasmid DNA is recovered in the first precipitation, hence the addition of a second batch of ethanol (Hildeman and Muller 1997).
8. Wash the two DNA precipitates with 70% ethanol. Remove as much as possible of the 70% ethanol and then allow any remaining fluid to evaporate at room temperature.
9. Dissolve the precipitated DNA in 2 ml of H<sub>2</sub>O or TE (pH 8.0).

For DNA sequencing, the DNA should be dissolved in H<sub>2</sub>O. TE (pH 8.0) is a better option if the DNA is to be stored for a long period of time.
10. If the resuspended DNA contains significant quantities of ethidium bromide, as judged from its color or its emission of fluorescence when illuminated by UV light, extract the solution once with phenol and once with phenol:chloroform, and then again precipitate the DNA with ethanol.
11. Measure the OD<sub>260</sub> of the final solution of DNA, and calculate the concentration of DNA. Store the DNA in aliquots at -20°C.

# Protocol 14

---

## Removal of Small Fragments of Nucleic Acid from Preparations of Plasmid DNA by Centrifugation through NaCl

**R**OUTINE PREPARATIONS OF PLASMID DNA ARE CONTAMINATED to varying degrees by small fragments of RNA and DNA, derived either from the bacterial chromosome or from broken plasmid molecules. Although the weight of these contaminants is usually low, their number can be large and can contribute significantly to the total number of 5' and 3' termini in the preparation. For some purposes (e.g., digestion with BAL 31, labeling the 5' termini of restriction enzyme fragments of plasmid DNA with bacteriophage T4 polynucleotide kinase, and adding tails to the 3' termini with terminal transferase), it is essential to obtain DNA preparations that are free of low-molecular-weight contaminants. The absence of these components is also desirable when the DNA is to be used for sequencing and amplification by PCR. Plasmids purified by chromatography on commercial resins are usually contaminated to a lesser extent than plasmids prepared by the alkaline or boiling methods (e.g., please see Schleef and Heimann 1993).

Contamination by fragments of nucleic acids can be reduced to an acceptable level by centrifugation through 1 M sodium chloride. This method, designed to remove small fragments of RNA from plasmid preparations, was devised by Brian Seed when he was a student at Harvard University. For other methods to achieve these ends, please see Protocols 15 and 16.

---

### MATERIALS

#### Buffers and Solutions

Please see Appendix 1 for components of stock solutions, buffers, and reagents. Dilute stock solutions to the appropriate concentrations.

*Ethanol*

*NaCl (1 M) in TE (pH 8.0)*

*Sodium acetate (3 M, pH 5.2)*

*TE (pH 8.0)*

#### Enzymes and Buffers

*DNase-free Pancreatic RNase*

## Nucleic Acids and Oligonucleotides

*DNA sample, purified through CsCl gradient*

Use material from either Step 14 of Protocol 12 or Step 11 of Protocol 13 of this chapter.

## Centrifuges and Rotors

*Beckman SW50.1 rotor or equivalent with appropriate tubes*

*Sorvall SS-34 rotor or equivalent*

## METHOD

---

1. Measure the volume of the plasmid preparation. Add 0.1 volume of 3 M sodium acetate (pH 5.2) and 2 volumes of ethanol. Store the mixture for 30 minutes at 4°C.
2. Recover the precipitate of nucleic acids by centrifugation at >10,000g (>9100 rpm in a Sorvall SS-34 rotor) for 15 minutes at 4°C. Decant as much of the supernatant as possible, and then store the open tube on the bench for a few minutes to allow the ethanol to evaporate.
3. Dissolve the damp pellet in 0.5–1.0 ml of TE (pH 8.0).  
The concentration of the plasmid DNA should be  $\geq 100$   $\mu\text{g/ml}$ .
4. Add DNase-free RNase to a final concentration of 10  $\mu\text{g/ml}$ . Incubate the mixture for 1 hour at room temperature.
5. Add 4 ml of 1 M NaCl in TE (pH 8.0) to a Beckman SW50.1 centrifuge tube (or its equivalent). Use an automatic pipette with a disposable tip to layer up to 1 ml of the plasmid preparation on top of the 1 M NaCl solution. If necessary, fill the tube with TE (pH 8.0).
6. Centrifuge the solution at 150,000g (40,000 rpm in a Beckman SW50.1 rotor) for 6 hours at 20°C. Carefully discard the supernatant.  
The plasmid DNA sediments to the bottom of the tube while the oligonucleotides and small fragments of DNA remain in the supernatant.
7. Dissolve the pellet of plasmid DNA in 0.5 ml of TE (pH 8.0). Add 50  $\mu\text{l}$  of 3 M sodium acetate (pH 5.2), and transfer the DNA solution to a microfuge tube.
8. Precipitate the DNA by addition of 2 volumes of ethanol, and store the ethanolic solution for 10 minutes at 4°C. Recover the DNA by centrifugation at maximum speed for 15 minutes at 4°C in a microfuge. Decant as much of the supernatant as possible and then store the open tube on the bench for a few minutes to allow the ethanol to evaporate.
9. Dissolve the damp pellet of DNA in TE (pH 8.0).



# Protocol 15

---

## Removal of Small Fragments of Nucleic Acid from Preparations of Plasmid DNA by Chromatography through Sephacryl S-1000

**C**HROMATOGRAPHY THROUGH SEPHACRYL S-1000 is the method of choice to separate plasmid DNA from smaller species of nucleic acid (both DNA and RNA). This procedure for removal of small nucleic acids, originally obtained from F. DeNoto and H. Goodman at the Massachusetts General Hospital in Boston, is incorporated into a paper published by Gómez-Márquez et al. (1987). Because it is impossible to remove all traces of plasmid DNA from the column of Sephacryl S-1000, particularly in PCR, discard each column after use.

### MATERIALS

---

**CAUTION:** Please see Appendix 12 for appropriate handling of materials marked with <!>.

#### Buffers and Solutions

Please see Appendix 1 for components of stock solutions, buffers, and reagents. Dilute stock solutions to the appropriate concentrations.

*Bromophenol blue sucrose solution*  
*Ethanol*  
*Phenol <!>*  
*Sephacryl equilibration buffer*  
*Sodium acetate (3 M, pH 5.2)*  
*TE (pH 8.0) containing 20 µg/ml RNase A*

#### Gels

*Agarose gel (0.7%) cast in TBE*

#### Nucleic Acids and Oligonucleotides

*DNA sample, purified through CsCl gradient*  
Use material from either Step 14 of Protocol 12 or Step 11 of Protocol 13 of this chapter.

#### Centrifuges and Rotors

*Sorvall SS-34 rotor or equivalent*

## Special Equipment

Column (1 × 10 cm) for Sephacryl resin  
Sephacryl S-1000 gel filtration resin (Pharmacia)

## METHOD

---

1. Prepare a 1 × 10-cm column of Sephacryl S-1000, equilibrated in Sephacryl equilibration buffer.  
A column of this size can accommodate >2 mg of plasmid DNA in a volume of 0.5 ml.
2. Measure the volume of the plasmid preparation. Add 0.1 volume of 3 M sodium acetate (pH 5.2) and 2 volumes of ethanol. Store the mixture for 30 minutes at 4°C.
3. Recover the precipitate of nucleic acids by centrifugation at >10,000g (>9100 rpm in a Sorvall SS-34 rotor) for 15 minutes at 4°C. Drain off as much of the supernatant as possible, and then store the open tube on the bench for a few minutes to allow the ethanol to evaporate.
4. Dissolve the damp pellet of nucleic acids in a small volume (<400 µl) of TE (pH 8.0) containing RNase A at a final DNA concentration of at least 100 µg/ml.
5. Incubate the mixture for 1 hour at room temperature.
6. Extract the solution once with an equal volume of phenol equilibrated in TE (pH 8.0).
7. Recover the aqueous layer, and add 100 µl of bromophenol blue dye sucrose solution. Layer the blue aqueous phase on the column of Sephacryl S-1000.
8. Wash the DNA into the column, and apply a reservoir of Sephacryl equilibration buffer. Immediately begin collecting 0.5-ml fractions.
9. When 15 fractions have been collected, clamp off the bottom of the column. At this stage, the blue dye should have traveled about half the length of the column.
10. Analyze 10 µl of each fraction by electrophoresis through a 0.7% agarose gel or by ethidium bromide fluorescence (please see Appendix 9) to identify the fractions containing plasmid DNA.
11. Pool the fractions containing plasmid DNA, and recover the DNA by precipitation with 2 volumes of ethanol for 10 minutes at 4°C and centrifugation at 10,000g (9200 rpm in a Sorvall SS-34 rotor) for 15 minutes at 4°C.
12. Decant as much of the supernatant as possible, and then store the open tube on the bench for a few minutes to allow the ethanol to evaporate.
13. Dissolve the damp pellet in TE (pH 8.0).

# Protocol 16

---

## Removal of Small Fragments of Nucleic Acid from Preparations of Plasmid DNA by Precipitation with Lithium Chloride

**I**N THIS PROTOCOL, THE SEPARATION OF PLASMID DNA from smaller species of nucleic acid (both DNA and RNA) is based on the differential solubility of the two nucleic acids in solutions of lithium chloride (LiCl). LiCl is a strong dehydrating reagent that lowers the solubility of RNA (Hearst and Vinograd 1961a,b) and strips proteins from chromatin (Kondo et al. 1979). Contaminating high-molecular-weight RNA and proteins can therefore be precipitated from crude plasmid preparations by high concentrations of LiCl and removed by low-speed centrifugation (e.g., please see Kondo et al. 1991). The use of LiCl as a selective precipitator of high-molecular-weight RNA was first reported in 1963 by Bob Williamson and colleagues (Barlow et al. 1963).

### MATERIALS

---

#### Buffers and Solutions

Please see Appendix 1 for components of stock solutions, buffers, and reagents. Dilute stock solutions to the appropriate concentrations.

*Ethanol*

*Isopropanol*

*LiCl (4 M)*

*Sodium acetate (3 M, pH 5.2)*

*TE (pH 8.0)*

*TE (pH 8.0) containing 20 µg/ml RNase A*

#### Nucleic Acids and Oligonucleotides

*DNA sample, purified through CsCl gradient*

Use material from either Step 14 of Protocol 12 or Step 11 of Protocol 13 of this chapter.

#### Centrifuges and Rotors

*Sorvall SS-34 rotor or equivalent*

## METHOD

---

1. Measure the volume of the plasmid preparation. Add 0.1 volume of 3 M sodium acetate (pH 5.2) and 2 volumes of ethanol. Store the mixture for 30 minutes at 4°C.
2. Recover the precipitate of nucleic acids by centrifugation at >10,000g (>9100 rpm in a Sorvall SS-34 rotor) for 15 minutes at 4°C. Drain off as much of the supernatant as possible, and then store the open tube on the bench for a few minutes to allow the ethanol to evaporate.
3. Dissolve the damp pellet in 1 ml of TE (pH 8.0) containing RNase A at a concentration of  $\geq 100$   $\mu\text{g/ml}$ .
4. Add 3 ml of 4 M LiCl solution. Incubate the mixture on ice for 30 minutes.
5. Separate the plasmid DNA from the precipitated nucleic acids by centrifugation at 12,000g (10,000 rpm in a Sorvall SS-34 rotor) for 15 minutes at 4°C.
6. Transfer the supernatant to a fresh centrifuge tube and add 6 ml of isopropanol. Allow the plasmid DNA to precipitate for 30 minutes at room temperature.
7. Recover the precipitated plasmid DNA by centrifugation at 12,000g (10,000 rpm in a Sorvall SS-34 rotor) for 15 minutes at 4°C.
8. Carefully remove the supernatant and add 5–10 ml of 70% ethanol to the tube. Vortex the tube briefly, and then recentrifuge at 12,000g for 10 minutes at 4°C.
9. Carefully remove the supernatant, and store the open tube on the bench top for a few minutes until the ethanol has evaporated.
10. Dissolve the damp pellet of DNA in TE (pH 8.0).

# Protocol 17

---

## Directional Cloning into Plasmid Vectors

**M**OST PLASMID VECTORS IN COMMON USE CONTAIN multiple cloning sites that have recognition sequences for many different restriction enzymes. Given the large variety of multiple cloning sites currently available (as many as 46 unique sites are present in some polylinkers, e.g., pSE280 from Invitrogen; and still longer polylinkers have been assembled; Brosius 1992), it is almost always possible to find a vector carrying restriction sites that are compatible with the termini of a particular fragment of foreign DNA.

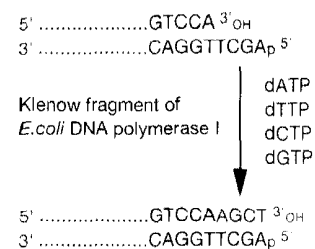
Directional cloning usually requires incompatible termini at the opposite ends of both vector and target DNAs. However, in certain circumstances, directional cloning can be achieved when both the target and plasmid DNAs carry identical termini at both ends. For example, the restriction enzymes *Bam*HI and *Bgl*II, which recognize different hexanucleotide sequences (GGATCC and AGATCT, respectively), generate restriction fragments with identical 3' protruding termini. If a DNA fragment carrying *Bam*HI and *Bgl*II termini is ligated into a vector that has been cleaved with the same two enzymes, then the foreign DNA can be inserted in either orientation. However, if one of the two restriction enzymes is included in the ligation mixture, or if the enzyme is used to digest the ligated DNA before transformation, then only those ligation events in which the *Bam*HI end is joined to the *Bgl*II end and vice versa (which destroys the recognition sites of both enzymes) will give rise to recombinant products in *E. coli*. This strategy takes advantage of the observation that closed circular DNAs transform bacterial cells with a much higher frequency than linear DNAs. Variations on this theme can also be used to improve the efficiency of cloning blunt-ended DNAs (please see Protocol 19).

Occasionally, it is impossible to find a suitable combination of vector, target DNA, and restriction enzymes that will allow directional cloning. There are several solutions to this problem:

- Synthetic linkers or adaptors can be ligated to the termini of the linearized plasmid and/or fragment of foreign DNA (for further details, please see Protocols 18 and 21 and the information panel on **ADAPTORS**).
- The fragment of foreign DNA can be amplified by PCR using oligonucleotide primers that add the desired restriction sites to one or both termini (please see Chapter 8).
- DNA fragments with recessed 3' termini can be partially filled in controlled reactions using the Klenow fragment of *E. coli* DNA polymerase I (please see Figure 1-10). As discussed in Chapter 9, this procedure often generates complementary termini from restriction sites that are otherwise incompatible, thus facilitating ligation of the vector and foreign DNAs. Because partial filling eliminates the ability of termini on the same molecule to pair with one another, the fre-

**FIGURE 1-10 Filling of Recessed 3' Termini by the Klenow Fragment of *E. coli* DNA Polymerase I**

The Klenow fragment of *E. coli* DNA polymerase I catalyzes the template-directed addition of deoxynucleotide triphosphates to a recessed 3'-hydroxyl group. Synthesis occurs in a 5'→3' direction until the recessed terminus is completely filled.



quencies of circularization and self-oligomerization during the ligation reaction are also reduced (Hung and Wensink 1984; Zabarovsky and Allikmets 1986). Keep in mind that micromolar concentrations of dATP can inhibit bacteriophage T4 DNA ligase. Thus, if dATP is used as a substrate in a partial end-filling reaction, the modified DNA product should be purified by spun-column chromatography or by two rounds of ethanol precipitation in the presence of ammonium acetate. This removes unincorporated dATP from the DNA preparation.

This protocol describes a standard procedure for cloning DNA fragments with protruding ends. Protocol 18 provides a method for attaching adaptors to a DNA fragment with protruding ends in order to introduce a particular restriction endonuclease recognition site. The slightly more difficult task of cloning blunt-end DNAs is presented in Protocol 19, whereas Protocol 20 describes methods for treating linearized plasmid DNA with alkaline phosphatases. For further details on ligation, please see the information panel on **DNA LIGASES**.

**MATERIALS**

**CAUTION:** Please see Appendix 12 for appropriate handling of materials marked with <!>.

**Buffers and Solutions**

Please see Appendix 1 for components of stock solutions, buffers, and reagents. Dilute stock solutions to the appropriate concentrations.

ATP (10 mM)

Ethanol

Phenol:chloroform (1:1, v/v) <!>

Sodium acetate (3 M, pH 5.2)

TE (pH 8.0)

**Enzymes and Buffers**

*Bacteriophage T4 DNA ligase*

Please see the information panel on **DNA LIGASES**

*Restriction endonucleases*

**Gels**

*Agarose gels*

Optional, please see Steps 1, 2, and 4.

*Polyacrylamide gel* <!>

Optional, please see Step 2.

## Nucleic Acids and Oligonucleotides

*Vector DNA (plasmid)*

*Foreign or target DNA fragment*

Adaptors may be added to the target DNA as described in Protocol 18 of this chapter.

## Special Equipment

*Equipment for spun-column chromatography*

*Water bath preset to 16°C*

## Additional Reagents

*Step 7 of this protocol requires the reagents listed in Protocol 23, 24, 25, or 26 of this chapter.*

## METHOD

---

1. Digest the vector (10 µg) and foreign DNA with the two appropriate restriction enzymes.

Closed circular plasmid vectors are prepared for directional cloning by digestion with two restriction enzymes that cleave at different sequences and generate different termini. Wherever possible, try to avoid using restriction enzymes that cleave within 12 bp of each other in the multiple cloning site. After one of these sites has been cleaved, the second site will be located too close to the end of the linear DNA to allow efficient cleavage by the second enzyme. An excellent tabulation of the efficiency with which different restriction enzymes cleave sites located near the ends of DNA molecules is presented in the Appendix of the New England Biolabs catalog ([www.neb.com/neb/frame\\_tech.html](http://www.neb.com/neb/frame_tech.html)).

Read the manufacturer's instructions to determine if the two restriction enzymes work optimally in the same digestion buffer. If so, digestion of the vector DNA can be carried out simultaneously with both enzymes. If the two restriction enzymes require different buffers, it is best to carry out the digestions sequentially. In this case, the enzyme that prefers the lower concentration of salt should be used first. At the end of the reaction, analyze an aliquot of the DNA by gel electrophoresis to confirm that all of the plasmid DNA has been converted from circular to linear molecules. Then adjust the salt concentration appropriately and add the second enzyme.

2. Purify the digested foreign DNA by extraction with phenol:chloroform and standard ethanol precipitation.

Depending on the experiment, it may be necessary or desirable to isolate the target fragment(s) of foreign DNA by neutral agarose or polyacrylamide gel electrophoresis as described in Chapter 5. This purification is generally done when there are many restriction fragments in the preparation of foreign DNA that can ligate to the vector. Rather than screening large numbers of transformants for the desired clone(s), many investigators prefer to enrich for the foreign sequences of interest before ligation, e.g., by agarose gel electrophoresis.

3. Purify the vector DNA by spun-column chromatography followed by standard ethanol precipitation.

This procedure eliminates from the vector preparation the small fragment of DNA generated by digesting the plasmid at two closely spaced restriction sites within the multiple cloning site.

4. Reconstitute the precipitated DNAs separately in TE (pH 8.0) at a concentration of ~100 µg/ml. Calculate the concentration of the DNA (in pmole/ml), assuming that 1 bp has a mass of 660 daltons.

Confirm the approximate concentration of the two DNAs by analyzing aliquots by agarose gel electrophoresis.

5. Transfer appropriate amounts of the DNAs to sterile 0.5-ml microfuge tubes as follows:

Tube	DNA
A and D	vector (30 fmoles [ $\sim 100$ ng])
B	insert (foreign) (30 fmoles [ $\sim 10$ ng])
C and E	vector (30 fmoles) plus insert (foreign) (30 fmoles)
F	superhelical vector (3 fmoles [ $\sim 10$ ng])

The molar ratio of plasmid vector to insert DNA fragment should be  $\sim 1:1$  in the ligation reaction. The final DNA concentration should be  $\sim 10$  ng/ $\mu$ l.

- a. To Tubes A, B, and C add:

10x Ligation buffer	1.0 $\mu$ l
Bacteriophage T4 DNA ligase	0.1 Weiss unit
10 mM ATP	1.0 $\mu$ l
H <sub>2</sub> O	to 10 $\mu$ l

- b. To Tubes D and E, add:

10x Ligation buffer	1.0 $\mu$ l
10 mM ATP	1.0 $\mu$ l
H <sub>2</sub> O	to 10 $\mu$ l
no DNA ligase	

The DNA fragments can be added to the tubes together with the H<sub>2</sub>O and then warmed to 45°C for 5 minutes to melt any cohesive termini that have reannealed during fragment preparation. Chill the DNA solution to 0°C before the remainder of the ligation reagents are added. To achieve the maximum efficiency of ligation, set up the reactions in as small a volume as possible (5–10  $\mu$ l). Adding ATP as a component of the 10x ligation buffer leaves more volume for vector or foreign DNA in the reaction mixture. Some commercial ligase buffers contain ATP. When using such buffers, the addition of ATP is no longer required. For a definition of Weiss units, please see the information panel on **DNA LIGASES**.

6. Incubate the reaction mixtures overnight at 16°C or for 4 hours at 20°C.
7. Transform competent *E. coli* with dilutions of each of the ligation reactions as described in Protocol 23, 24, 25, or 26. As controls, include known amounts of a standard preparation of superhelical plasmid DNA to check the efficiency of transformation.

Tube	DNA	Ligase	Expected number of transformed colonies
A	vector	+	$\sim 0$ ( $\sim 10^4$ fewer than Tube F) <sup>1</sup>
B	insert	+	0
C	vector and insert	+	$\sim 10$ -fold more than Tube A or D
D	vector	–	$\sim 0$ ( $\sim 10^4$ fewer than Tube F)
E	vector and insert	–	some, but fewer than Tube C
F	superhelical vector	–	$> 2 \times 10^5$

<sup>1</sup>Transformants arising from ligation of vector DNA alone are due either to failure of one or both restriction endonucleases to digest the DNA to completion or to ligation of the vector to residual amounts of the small fragment of the multiple cloning site.



# Protocol 18

---

## Attaching Adaptors to Protruding Termini

**P**ROTOCOL 17 IS EASILY MODIFIED TO ACCOMMODATE the addition of an adaptor to a DNA fragment with protruding ends. Adaptors may be purchased in both phosphorylated and unphosphorylated forms (i.e., with phosphate residues or hydroxyl groups at their 5' termini; please see the information panel on **ADAPTORS** and Table 1-13. Because DNA ligase requires 5-phosphoryl termini, unphosphorylated adaptors must be modified before use by transferring the  $\gamma$ -phosphate from ATP to the 5'-hydroxyl group. This reaction is catalyzed by the bacteriophage-T4-encoded enzyme polynucleotide kinase. If phosphorylated adaptors are purchased, omit Step 1 (phosphorylation step) of the protocol, and begin with Step 2.

### MATERIALS

---

**CAUTION:** Please see Appendix 12 for appropriate handling of materials marked with <!>.

#### Buffers and Solutions

Please see Appendix 1 for components of stock solutions, buffers, and reagents. Dilute stock solutions to the appropriate concentrations.

*ATP (10 mM)*

Omit ATP from the ligation reaction in Step 2 if the ligation buffer contains ATP.

*Ethanol*

*10x Linker kinase buffer*

*Phenol:chloroform (1:1, v/v) <!>*

*Sodium acetate (3 M, pH 5.2)*

*TE (pH 8.0)*

#### Enzymes and Buffers

*Bacteriophage T4 DNA ligase*

Please see the information panel on **DNA LIGASES**

*Polynucleotide kinase*

*Restriction endonucleases*

#### Nucleic Acids and Oligonucleotides

*Foreign or target DNA fragment*

*Synthetic oligonucleotide or adaptor dissolved in TE (pH 8.0) at a concentration of ~400  $\mu$ g/ml.*

For a hexamer, this concentration is equivalent to a 50  $\mu$ M solution.

Adaptors are available from Stratagene. Please see the information panel on **ADAPTORS**

**Special Equipment**

Equipment for spun-column chromatography (please see Appendix 8)  
Water bath preset to 65°C

**METHOD**

1. To phosphorylate the adaptors, add to a sterile microfuge tube:

synthetic oligonucleotide or adaptor	0.5–2.0 µg, dissolved in TE (pH 8.0)
10× linker kinase buffer	1.0 µl
10 mM ATP	1.0 µl
H <sub>2</sub> O	to 10 µl
bacteriophage T4 polynucleotide kinase	1.0 unit

Incubate the reaction for 1 hour at 37°C.

There is no need to purify the phosphorylated adaptors: Aliquots of the reaction mixture can be transferred directly into ligation reactions.

2. To ligate the phosphorylated adaptors to a DNA fragment with complementary protruding ends, set up a ligation reaction as follows:

DNA fragment	100–200 ng
phosphorylated adaptor	10–20-fold molar excess
10× ligation buffer	1.0 µl
bacteriophage T4 DNA ligase	0.1 Weiss unit
10 mM ATP	1.0 µl
H <sub>2</sub> O	to 10 µl

Incubate the ligation mixture for 6–16 hours at 4°C.

To achieve the maximum efficiency of ligation, set up the reactions in as small a volume as possible (5–10 µl). Adding ATP as a component of the 10× ligation buffer leaves more volume for vector or foreign DNA in the reaction mixture. Some commercial ligase buffers contain ATP. When using such buffers, the addition of ATP is not required.

3. Inactivate the DNA ligase by incubating the reaction mixture for 15 minutes at 65°C.
4. Dilute the ligation reaction with 10 µl of the appropriate 10× restriction enzyme buffer. Add sterile H<sub>2</sub>O to a final volume of 100 µl followed by 50–100 units of restriction enzyme.
5. Incubate the reaction for 1–3 hours at 37°C.  
The restriction enzyme catalyzes the removal of polymerized linkers from the ends of the DNA fragment and creates protruding termini. A huge amount of restriction enzyme is required to digest the large quantities of adaptors present in the reaction.
6. Extract the restriction digestion with phenol:chloroform and recover the DNA by standard ethanol precipitation.
7. Collect the precipitated DNA by centrifugation at maximum speed for 15 minutes at 4°C in a microfuge, and resuspend the DNA in 50 µl of TE (pH 8.0).
8. Pass the resuspended DNA through a spun column to remove excess adaptors and their cleavage products.
9. The modified DNA fragment can now be ligated to a plasmid vector with protruding ends that are complementary to those of the cleaved adaptor (please see Protocol 17).

# Protocol 19

---

## Blunt-ended Cloning into Plasmid Vectors

**T**O OBTAIN THE MAXIMUM NUMBER OF "CORRECT" LIGATION products in cloning blunt-end target fragments, the two components of DNA in the ligation reaction must be present at an appropriate ratio. If the molar ratio of plasmid vector to target DNA is too high, then the ligation reaction may generate an undesirable number of circular empty plasmids, both monomeric and polymeric; if too low, the ligation reaction may generate an excess of linear and circular homo- and heteropolymers of varying sizes, orientations, and compositions. For this reason, the orientation of the foreign DNA and the number of inserts in each recombinant clone must always be validated by restriction endonuclease mapping or some other means. As a general rule, acceptable yields of monomeric circular recombinants can be obtained from ligation reactions containing equimolar amounts of plasmid and target DNAs, with the total DNA concentration <100 µg/ml (Bercovich et al. 1992).

This protocol describes procedures for cloning blunt-ended DNA fragments into linearized plasmid vectors. Protocols 20 and 21 present further strategies to facilitate the recovery of the correct ligation products in blunt-ended cloning. Removal of 5'-phosphate residues from the vector (please see Protocol 20) will suppress recircularization of the linear plasmid. Note, however, that opinions vary as to whether dephosphorylation is advantageous; for further discussion of this issue, please refer to the introduction to Protocol 20. As a more effective approach, synthetic linkers encoding restriction endonuclease recognition sites may be ligated to blunt-ended DNA termini (please see Protocol 21) to provide cohesive ends for cloning by the method in Protocol 17. Protocols for filling recessed 3' termini or for removing protruding 5' or 3' termini are described in Chapter 9, Protocol 10.

### MATERIALS

---

**CAUTION:** Please see Appendix 12 for appropriate handling of materials marked with <!>.

#### Buffers and Solutions

**Please see Appendix 1 for components of stock solutions, buffers, and reagents. Dilute stock solutions to the appropriate concentrations.**

*ATP (10 mM)*

Omit ATP from the ligation reaction in Step 2 if the ligation buffer contains ATP.

*Ethanol*

*Phenol:chloroform (1:1, v/v) <!>*

*Polyethylene glycol (30% w/v PEG 8000 solution) <!>*

*Sodium acetate (3 M, pH 5.2)*

*TE (pH 8.0)*

## Enzymes and Buffers

*Bacteriophage T4 DNA ligase*

Please see the information panel on **DNA LIGASES**.

*Restriction endonucleases*

## Gels

*Agarose gels*

Optional, please see Steps 2 and 3.

*Polyacrylamide gels <!>*

Optional, please see Step 2.

## Nucleic Acids and Oligonucleotides

*Foreign or target DNA (blunt-end fragment)*

*Vector (plasmid) DNA*

## Additional Reagents

*Step 4 of this protocol requires the reagents listed in Protocol 20 of this chapter.*

*Step 7 of this protocol requires the reagents listed in Protocol 23, 24, 25, or 26 of this chapter.*

## METHOD

---

1. In separate reactions, digest 1–10 µg of the plasmid DNA and foreign DNA with the appropriate restriction enzyme(s) that generate blunt ends.
2. Purify the digested foreign DNA and vector DNA by extraction with phenol:chloroform and standard ethanol precipitation (please see Appendix 8).

Depending on the experiment, it may be necessary or desirable to isolate the target fragment(s) of foreign DNA by neutral agarose or polyacrylamide gel electrophoresis as described in Chapter 5. This isolation is generally done when there are a large number of restriction fragments in the preparation of foreign DNA that can ligate to the vector. Rather than screening multiple transformants for the desired clone(s), many investigators prefer to enrich for the foreign sequences of interest before ligation.

3. Reconstitute the precipitated DNAs separately in TE (pH 8.0) at a concentration of ~100 µg/ml. Calculate the concentration of the DNAs (in pmole/ml) assuming that 1 bp has a mass of 660 daltons.

Confirm the approximate concentration of the two DNAs by analyzing aliquots by agarose gel electrophoresis.

4. Dephosphorylate the plasmid vector DNA as described in Protocol 20.
5. Transfer appropriate amounts of the DNAs to sterile 0.5-ml microfuge tubes as follows:

Tube	DNA
A and E	vector <sup>1</sup> (60 fmoles [~100 ng])
B	foreign <sup>2</sup> (60 fmoles [~10 ng])
C and F	vector <sup>1</sup> (60 fmoles) plus foreign (60 fmoles) <sup>3</sup>
D	linearized vector (contains 5'-terminal phosphates) (60 fmoles)
G	superhelical vector (6 fmoles [~10 ng])

<sup>1</sup>Vector DNA is dephosphorylated as described in Protocol 20.

<sup>2</sup>Linkers may be ligated to foreign target DNA.

<sup>3</sup>The molar ratio of plasmid vector to insert DNA fragment should be ~1:1 in the ligation reaction. The total DNA concentration in the ligation reaction should be ~10 ng/µl.

**a.** To Tubes A, B, and C add:

10x Ligation buffer	1.0 $\mu$ l
Bacteriophage T4 DNA ligase	0.5 Weiss unit
5 mM ATP	1.0 $\mu$ l
H <sub>2</sub> O	to 8.5 $\mu$ l
30% PEG 8000	1–1.5 $\mu$ l

**b.** To Tubes D, E, and F add:

10x Ligation buffer	1.0 $\mu$ l
5 mM ATP	1.0 $\mu$ l
H <sub>2</sub> O	to 8.5 $\mu$ l
30% PEG 8000	1–1.5 $\mu$ l
no DNA ligase	

To achieve the maximum efficiency of ligation, set up the reactions in as small a volume as possible (5–10  $\mu$ l). Adding ATP as a component of the 10x ligation buffer leaves more volume for vector or foreign DNA in the reaction mixture. Some commercial ligase buffers contain ATP. When using such buffers, the addition of ATP is not required.

The DNA fragments can be added to the tubes together with the H<sub>2</sub>O and then warmed to 45°C for 5 minutes to help dissociate any clumps of DNA that have formed during fragment preparation. Chill the DNA solution to 0°C before the remainder of the ligation reagents are added. It is important (i) to warm the PEG stock (30%) solution to room temperature before adding to the ligation reaction and (ii) to add this ingredient last. DNA can precipitate at cold temperatures in the presence of PEG 8000.

- Incubate the reaction mixtures overnight at 16°C or for 4 hours at 20°C.
- Transform competent *E. coli* with dilutions of each of the ligation reactions, using one of the methods described in Protocols 23 through 26. As controls, include known amounts of a standard preparation of superhelical plasmid DNA to check the efficiency of transformation.

Tube	DNA	Ligase	Expected number of transformants
A	vector <sup>1</sup>	+	~0 <sup>3</sup>
B	insert	+	0
C	vector <sup>1</sup> and insert	+	~5-fold more than Tube F
D	vector <sup>1</sup>	–	~0
E	vector <sup>2</sup>	–	~50-fold more than Tube D
F	vector <sup>1</sup> and insert	–	~50-fold more than Tube D
G	superhelical vector	–	2 × 10 <sup>5</sup>

<sup>1</sup>Dephosphorylated.

<sup>2</sup>Not dephosphorylated.

<sup>3</sup>Transformants arising from ligation of dephosphorylated vector DNA alone are due to failure to remove 5' residues during treatment with alkaline phosphatase.

# Protocol 20

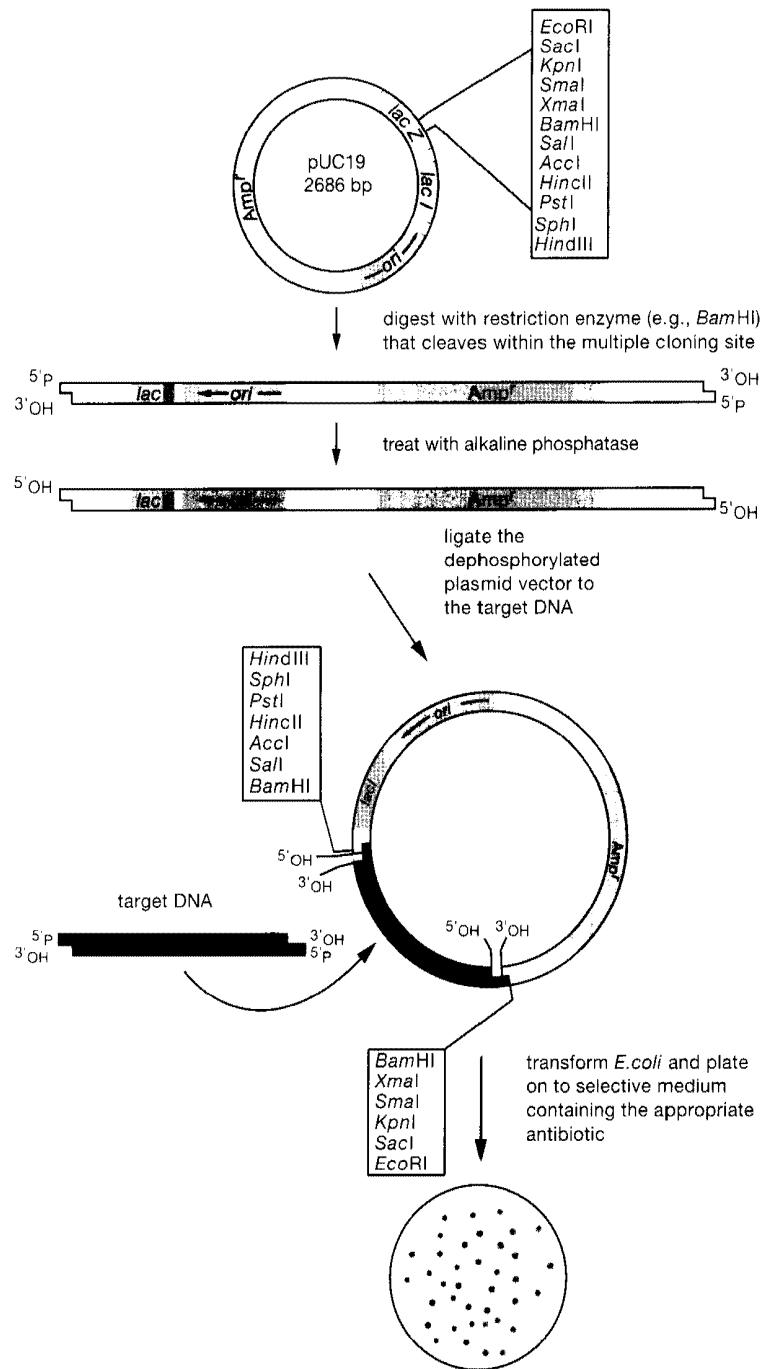
---

## Dephosphorylation of Plasmid DNA

**R**EMOVAL OF TERMINAL 5'-PHOSPHATE GROUPS MAY BE USED to suppress self-ligation and circularization of plasmid DNA. During ligation in vitro, DNA ligase will catalyze the formation of a phosphodiester bond between adjacent nucleotides only if one nucleotide carries a 5'-phosphate residue and the other carries a 3'-hydroxyl terminus. Recircularization of plasmid DNA can therefore be minimized by removing the 5'-phosphate residues from both termini of the plasmid DNA with alkaline phosphatase (Seeburg et al. 1977; Ullrich et al. 1977). However, a foreign DNA segment with intact 5'-terminal phosphate residues can be ligated efficiently in vitro to the dephosphorylated plasmid DNA to generate an open circular molecule containing two nicks (please see Figure 1-11). Because these open circular DNA molecules transform *E. coli* more efficiently than dephosphorylated linear DNA, most of the transformants should, in theory, contain recombinant plasmids.

Despite its logical appeal, many investigators continue to have doubts about the value of dephosphorylation. There is no question that removal of the 5'-phosphate residues suppresses recircularization of linear plasmid DNA and therefore diminishes the background of transformed bacterial colonies that carry "empty" plasmids. All too frequently, however, there is a parallel decline in the number of colonies that carry the desired recombinant. In addition, some investigators believe that the presence of 5'-hydroxyl groups may lead to an increase in the frequency of rearranged or deleted clones. For these reasons, directional cloning is the preferred method of cloning in plasmids whenever the appropriate restriction sites are available. Dephosphorylation of the vector is now recommended only when:

- *The DNA insert to be cloned is only available in small amounts.* In this situation, the use of a tenfold molar excess of dephosphorylated vector over insert will ensure that all available insert is ligated to the vector.
- *When the transformants are to be screened by restriction enzyme digestion of minipreparations of plasmid DNA.* Because preparing plasmid DNA from more than a dozen or two small-scale cultures of bacteria is tedious, the use of a dephosphorylated vector will ensure a high frequency of the desired recombinants in a small sample of transformants.
- *When cloning blunt-ended fragments of DNA* (please see protocol 19).
- *If a vector that has been prepared by cleavage with two different enzymes generates a large number of transformed colonies.* This indicates either that one of the two enzymes used to prepare the vector failed to cleave the DNA to completion or that the small fragment of DNA released from the multiple cloning site has not been removed from the vector preparation but



**FIGURE 1-11 Dephosphorylation**

The diagram shows the use of phosphatase to prevent recircularization of vector DNA.

instead is ligated into the vector. In both cases, dephosphorylation of the vector can be of use since removal of the 5'-terminal phosphate residues prevents reconstitution of closed circular plasmid DNAs.

Dephosphorylation is, however, *not* needed when cloning DNA fragments with complementary protruding ends provided recombinants are screened by  $\alpha$ -complementation and/or identified by colony hybridization (Protocols 27 and 28). Because large numbers of colonies may

be readily screened on a single plate, rare recombinants can easily be identified and recovered, even when the number of background colonies is high. This protocol presents a method to remove 5'-phosphate residues from protruding or blunt termini of linearized plasmids.

## MATERIALS

---

**CAUTION:** Please see Appendix 12 for appropriate handling of materials marked <!>.

### Buffers and Solutions

Please see Appendix 1 for components of stock solutions, buffers, and reagents. Dilute stock solutions to the appropriate concentrations.

*EDTA (0.5 M, pH 8.0)*

*EGTA (0.5 M, pH 8.0)*

Optional, please see Step 6.

*Ethanol*

*Phenol <!>*

*Phenol:chloroform (1:1, v/v) <!>*

*SDS (10% w/v)*

*Sodium acetate (3 M, pH 5.2 and pH 7.0)*

*TE (pH 8.0)*

*Tris-Cl (10 mM, pH 8.3)*

### Enzymes and Buffers

*Calf intestinal alkaline phosphatase (CIP)*

or

*Shrimp alkaline phosphatase (SAP)*

*Proteinase K (10 mg/ml)*

Please see the discussion on Proteinase K in Appendix 4.

*Restriction endonucleases*

### Gels

*Agarose gel (0.7%) cast in TBE containing 0.5 µg/ml ethidium bromide <!>*

Please see Step 2.

### Nucleic Acids and Oligonucleotides

*Vector DNA (closed circular plasmid)*

### Special Equipment

*Water bath preset to 56°C or 65°C*

Please see Step 6.

## METHOD

---

1. Digest a reasonable quantity of closed circular plasmid DNA (10 µg) with a two- to threefold excess of the desired restriction enzyme for 1 hour.
2. Remove an aliquot (0.1 µg), and analyze the extent of digestion by electrophoresis through a 0.7% agarose gel containing ethidium bromide (please see Chapter 5, Protocol 1), using undigested plasmid DNA as a marker. If digestion is not complete, add more restriction enzyme and continue the incubation.



**TABLE 1-8 Conditions for Dephosphorylation of 5'-phosphate Residues from DNA**

TYPE OF TERMINUS	ENZYME/AMOUNT PER MOLE DNA ENDS	INCUBATION TEMPERATURE/TIME
5'-Protruding	0.01 unit CIP <sup>a</sup>	37°C/30 minutes
	0.1 unit SAP	37°C/60 minutes
3'-Protruding	0.1–0.5 unit CIP <sup>b</sup>	37°C/15 minutes <i>then</i>
		55°C/45 minutes
Blunt	0.5 unit SAP	37°C/60 minutes
	0.1–0.5 unit CIP <sup>b</sup>	37°C/15 minutes <i>then</i>
		55°C/45 minutes
	0.2 unit SAP	37°C/60 minutes

<sup>a</sup>After the initial 30-minute incubation, add a second aliquot of CIP enzyme and continue incubation for another 30 minutes at 37°C.

<sup>b</sup>Add a second aliquot of CIP just before beginning the incubation at 55°C.

- When digestion is complete, extract the sample once with phenol:chloroform and recover the DNA by standard precipitation with ethanol. Store the ethanolic solution on ice for 15 minutes.
- Recover the DNA by centrifugation at maximum speed for 10 minutes at 4°C in a microfuge, and dissolve the DNA in 110 µl of 10 mM Tris-Cl (pH 8.3).  
Reserve 20 µl of the DNA preparation for later use as a control (please see Protocol 19).
- To the remaining 90 µl of the linearized plasmid DNA, add 10 µl of 10× CIP or 10× SAP buffer and the appropriate amount of calf intestinal phosphatase (CIP) or shrimp alkaline phosphatase (SAP) and incubate as described in Table 1-8.
- Inactivate the phosphatase activity:

To inactivate CIP at the end of the incubation period: Add SDS and EDTA (pH 8.0) to final concentrations of 0.5% and 5 mM, respectively. Mix well, and add proteinase K to a final concentration of 100 µg/ml. Incubate for 30 minutes at 55°C.

Alternatively, CIP can be inactivated by heating to 65°C for 30 minutes (or 75°C for 10 minutes) in the presence of 5 mM EDTA or 10 mM EGTA (both at pH 8.0).

*or*

To inactivate SAP: Incubate the reaction mixture for 15 minutes at 65°C in the dephosphorylation buffer.

At the end of the dephosphorylation reaction, it is crucial to remove or completely inactivate the alkaline phosphatase before setting up the ligation reactions. Although both CIP and SAP can be inactivated by heating as described above, we recommend that the dephosphorylation reaction be extracted with phenol/chloroform before using the dephosphorylated DNA in a ligation reaction.

- Cool the reaction mixture to room temperature, and then extract it once with phenol and once with phenol:chloroform.
- Recover the DNA by standard precipitation with ethanol. Mix the solution again and store it for 15 minutes at 0°C.

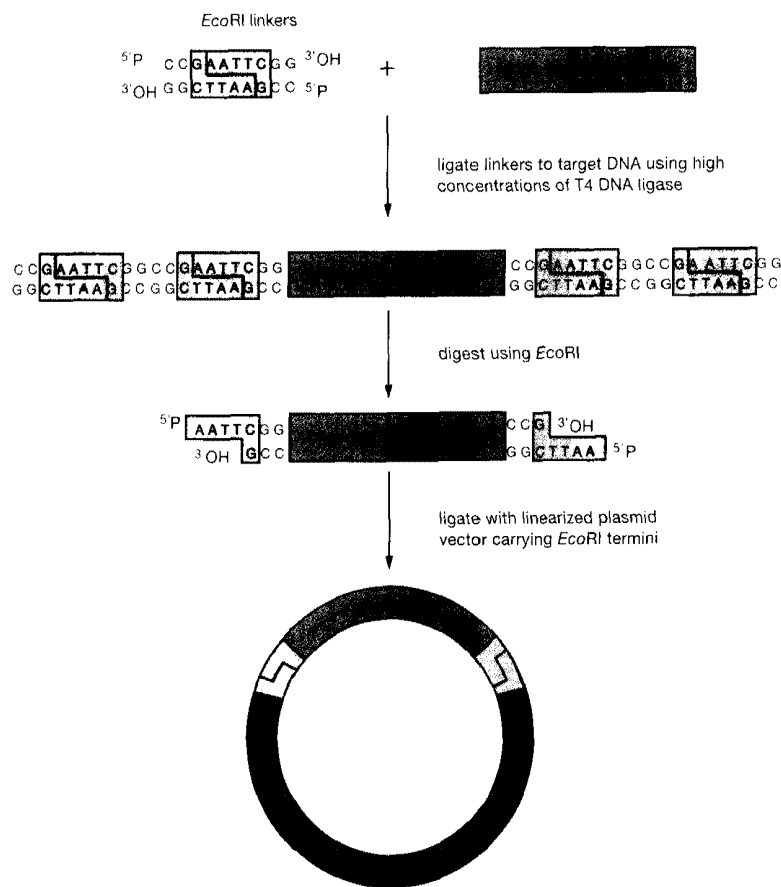
9. Recover the DNA by centrifugation at maximum speed for 10 minutes at 4°C in a microfuge. Wash the pellet with 70% ethanol at 4°C and centrifuge again.
10. Carefully remove the supernatant and leave the open tube on the bench to allow the ethanol to evaporate.
11. Dissolve the precipitated DNA in TE (pH 8.0) at a concentration of 100 µg/ml. Store the DNA in aliquots at -20°C.

# Protocol 21

## Addition of Synthetic Linkers to Blunt-ended DNA

**L**INKERS ARE SMALL SELF-COMPLEMENTARY PIECES of synthetic DNA, usually 8–16 nucleotides in length, that anneal to form blunt-ended, double-stranded molecules containing a recognition site for a restriction enzyme (please see Figure 1-12).

Linkers are used to equip blunt-ended termini of DNA with restriction sites as an aid to cloning (Scheller et al. 1977). A large variety of linkers available from commercial suppliers can



**FIGURE 1-12** Cloning by Addition of Linkers to Blunt-ended Target DNA

**TABLE 1-9 Linker Sequences**

<i>Bam</i> HI	d(CGGGATCCCG)
<i>Bam</i> HI	d(CGCGGATCCGCG)
<i>Bgl</i> II	d(GAAGATCTTC)
<i>Eco</i> RI	d(GGAATTCC)
<i>Eco</i> RI	d(CGGAATTCCG)
<i>Eco</i> RI	d(CCGGAATTCCGG)
<i>Hind</i> III	d(CCAAGCTTGG)
<i>Hind</i> III	d(CCCAAGCTTGGG)
<i>Nco</i> I	d(CATGCCATGGCATG)
<i>Nde</i> I	d(CCATATGG)
<i>Nhe</i> I	d(CTAGCTAGCTAG)
<i>Not</i> I	d(AGCGGCCGCT)
<i>Pst</i> I	d(GCTGCAGC)
<i>Sac</i> I	d(CGAGCTCG)
<i>Sal</i> I	d(CGGTTCGACCG)
<i>Sma</i> I	d(TCCCCCGGGGGA)
<i>Spe</i> I	d(CGGAAGCTTCCG)
<i>Srf</i> I	d(AGCCCCGGGCT)
<i>Xba</i> I	d(CTAGTCTAGACTAG)
<i>Xho</i> I	d(CCGCTCGAGCGG)

Modified with permission, ©1999 Stratagene.

be purchased in two forms that carry either a phosphate group or a hydroxyl group on the 5' termini (please see Table 1-9). Only phosphorylated molecules are substrates for T4 DNA ligase, and nonphosphorylated linkers must therefore be treated with bacteriophage T4 polynucleotide kinase and ATP before they can be joined to DNA. In a typical experiment, phosphorylated linkers are ligated in 75–100-fold molar excess in the presence of a blunt-ended target molecule. This heavily skewed stoichiometry drives end-to-end ligation of linkers and polymerization of linkers to each end of the target DNA. The excess linkers are cleaved from the DNA fragment by the appropriate restriction enzyme, and their remnants are removed by gel filtration or gel electrophoresis. The purified DNA fragment, now a few nucleotides longer and equipped with conventional cohesive termini, may be ligated into a vector carrying compatible termini (please see Figure 1-12).

In many cases, particular linkers are chosen because they carry a restriction site that is known to be absent from the body of an individual target DNA. However, a different strategy is required when linkers are used to clone populations of DNA molecules whose sequences are unknown, e.g., a population of cDNAs. This can be achieved as follows:

- Use the cognate methylating enzyme to modify internal recognition sites in the cDNAs and thereby protect them against cleavage by the restriction enzymes used to trim the polymerized linkers from the termini of the cDNAs. For example, *Eco*RI linkers can be added to a DNA fragment that contains one or more internal recognition sites by treating the DNA with *Eco*RI methylase in the presence of *S*-adenosylmethionine (SAM, a methyl group donor) before linker addition. Methylation of the first adenosyl residue in the GAATTC recognition site prevents subsequent cleavage by the *Eco*RI restriction enzyme when polymerized linkers are removed from the ends of the modified DNA. For more details, please consult Appendix 4.

- Partially fill recessed 3' termini of an *Xho*I cloning site on the vector and ligate to the cDNA carrying phosphorylated adaptors with 3-base protruding termini complementary to the partially filled *Xho*I site. Neither the vector nor the cDNA molecules can anneal to themselves, but they can join to one another. Because the *Xho*I site is regenerated, the cloned cDNA can be recovered by digestion with *Xho*I. This strategy greatly improves the efficiency of the ligation step in cDNA cloning and eliminates the need to methylate the cDNA or to digest it with restriction enzymes before insertion into the vector (Yang et al. 1986; Elledge et al. 1991). For more information, please see the information panel on **ADAPTORS**.

Finally, in some blunt-ended DNA ligations, it is possible to include a restriction enzyme in the ligation reaction or to restrict the ligated DNA before transformation, in order to increase the proportion of bacterial colonies carrying the desired recombinants. For example, *Sma*I and *Hinc*II are two restriction enzymes that cleave to yield blunt ends and whose recognition sites are included in most multiple cloning sites. In ligations where these two sites will not be regenerated when the target DNA is ligated to the vector, and in which the two enzymes do not cleave within the DNA fragment to be ligated, the *Sma*I or *Hinc*II enzyme can be included in the ligation reaction. Alternatively, and more efficiently, after ligation, the reaction can be diluted into a final volume of 100  $\mu$ l of 1 $\times$  restriction enzyme buffer and digested with 5–10 units of the appropriate enzyme for 1–3 hours. Either of these treatments prior to transformation will result in cleavage of self-ligated vector DNA, thereby enriching for recombinants whose *Sma*I or *Hinc*II sites have been eliminated by ligation of the insert. Because circular DNAs produce manyfold more transformants/ $\mu$ g than linear DNAs, most *E. coli* colonies arising after transformation will carry the desired recombinants. A similar strategy can be used when cloning blunt-ended DNA fragments generated by PCR. Stratagene markets a kit, pCR-ScriptSK(+), for this purpose.

## MATERIALS

---

**CAUTION:** Please see Appendix 12 for appropriate handling of materials marked with <!>.

### Buffers and Solutions

Please see Appendix 1 for components of stock solutions, buffers, and reagents. Dilute stock solutions to the appropriate concentrations.

*Ammonium acetate* (4 M, pH 4.8)

*ATP* (5 mM and 10 mM)

Omit 5 mM from the ligation reaction in Step 2 if the ligation buffer contains ATP.

*Ethanol*

*10 $\times$  Linker kinase buffer*

600 mM Tris-Cl (pH 7.6)

100 mM MgCl<sub>2</sub>

100 mM dithiothreitol

2 mg/ml bovine serum albumin

*Phenol:chloroform* (1:1, v/v) <!>

*Sodium acetate* (3 M, pH 5.2)

*TE* (pH 8.0)

### Enzymes and Buffers

*Bacteriophage T4 DNA ligase*

Please see the information panel on **DNA LIGASES**

*Bacteriophage T4 polynucleotide kinase*  
*Restriction endonucleases*

## Gels

*Polyacrylamide gel (10%) <1> or agarose gel (0.7%) (optional)*

These gels may be used to assess the results of ligation and digestion. Please see the note to Step 7.

## Nucleic Acids and Oligonucleotides

*Foreign or target DNA (blunt-end fragment)*

*Synthetic linkers dissolved in TE (pH 8.0) at a concentration of 400 µg/ml*

For a dodecamer, this concentration is equivalent to a 50 µM solution.

## Radioactive Compounds

*[ $\gamma$ -<sup>32</sup>P]ATP <1> (1–10 µCi)*

Optional for phosphorylation reaction. Please see the note to Step 2.

## Special Equipment

*Equipment for spun-column chromatography*

*Water bath preset to 65°C*

## METHOD

---

### Phosphorylation of Linkers (If Necessary)

1. Assemble the following reaction mixture in a sterile 0.5-ml microfuge tube:

10× linker kinase buffer	1.0 µl
10 mM ATP	1.0 µl
synthetic linker dissolved in TE (pH 8.0)	2.0 µg <sup>1</sup>
H <sub>2</sub> O	to 9 µl
bacteriophage T4 polynucleotide kinase	10 units

<sup>1</sup>Approximately 250 pmoles of a dodecamer.

Incubate the reaction for 1 hour at 37°C.

If necessary, methylation of internal restriction sites in the target DNA should be carried out at this stage, i.e., carried out before linker addition and according to the manufacturer's instructions.

### Ligation of Phosphorylated Linkers to Blunt-ended DNA

2. Calculate the concentration of termini in the preparation of blunt-ended DNA and then assemble the following ligation mixture in the order given in a sterile 0.5-ml microfuge tube:

50 µg of a 1 kb segment of double-stranded DNA = 78.7 nmoles or 157.4 nM of termini.	
blunt-ended DNA	2 pmoles of termini
phosphorylated linkers	150–200 pmoles of termini
H <sub>2</sub> O	to 7.5 µl
10× ligation buffer	1.0 µl
5 mM ATP (free acid)	1.0 µl
bacteriophage T4 DNA ligase	1.0 Weiss unit

Incubate the reaction mixtures for 12–16 hours at 4°C.

To achieve the maximum efficiency of ligation, set up the reactions in as small a volume as possible (5–10 µl). Addition of ATP as a component of the 10× ligation buffer leaves more volume for

vector or foreign DNA in the reaction mixture. Some commercial ligase buffers contain ATP. When using such buffers, the addition of ATP is no longer required. For a definition of Weiss units, please see the information panel on **DNA LIGASES**.

3. Inactivate the bacteriophage T4 DNA ligase by heating the reaction mixture to 65°C for 15 minutes.
4. Cool the ligation mixture to room temperature and then add:

10x restriction enzyme buffer	10 µl
restriction enzyme	50 units
sterile H <sub>2</sub> O	to a final volume of 100 µl

Incubate the reaction for 1–3 hours at 37°C.

### Recovery of Ligated DNA

5. Purify the restricted DNA by extraction with phenol:chloroform. Precipitate the DNA with 2 volumes of ethanol in the presence of 2 M ammonium acetate.
6. Collect the precipitated DNA by centrifugation at maximum speed for 15 minutes at 4°C in a microfuge, and dissolve the pellet in 50 µl of TE (pH 8.0).
7. Pass the resuspended DNA through a spun column to remove excess linkers (please see Appendix 8).

Usually, the ligation and restriction endonuclease reactions go well and there is no need to check the products before proceeding. If necessary, however, these steps can be checked as follows:

- During ligation, phosphorylated linkers assemble into polymers (e.g., dimers, trimers, and tetramers) that can be detected when 1.0 µl of the reaction mixture (Step 2) is analyzed by electrophoresis through a neutral 10% polyacrylamide gel. A ladder of multimers should be visible when the gel is stained by ethidium bromide or SYBR Gold.
- If radiolabeled linkers are used and if the ligation is successful, the radioactive linkers will form a series of radioactive bands that can be resolved by electrophoresis through a neutral 10% polyacrylamide gel. However, instead of staining, the radiolabeled linkers may be detected by autoradiography or phosphorimaging. When the linker is labeled to high specific activity, it is possible to verify that the radiolabeled linker has become attached to the target DNA because some of the radioactivity elutes with the target DNA during spun-column chromatography (Step 7). Alternatively, an aliquot of the reaction mixture can be analyzed by electrophoresis through an agarose gel. After ligation, a small fraction of the radiolabel should comigrate with the target fragment.
- To verify that the restriction enzyme has cleaved the polymerized linkers to completion, analyze 10 µl of the restriction digest by polyacrylamide gel electrophoresis. The linker ladder should now be reduced to monomers.

8. Recover the DNA by standard ethanol precipitation and dissolve the precipitate in 10–20 µl of TE (pH 8.0).

The modified DNA fragment can now be ligated as described in Protocol 17 into a plasmid (or bacteriophage) vector with protruding ends that are complementary to those introduced by the linker.

# Protocol 22

---

## Ligating Plasmid and Target DNAs in Low-melting-temperature Agarose

**T**HE SLOWEST STEP IN CLONING IN PLASMIDS is the electrophoretic purification of the desired restriction fragment of foreign DNA and the appropriate segment of plasmid DNA. In the protocol given below (adapted from Struhl 1985), ligation of plasmid and foreign DNAs is carried out in the presence of low-melting-temperature agarose (please see Chapter 5). The method works for both blunt-end ligation and ligation of cohesive termini, but it requires a large amount of ligase and its efficiency is about one to two orders of magnitude lower than ligation with purified DNA (Protocols 17 and 19). For this reason, the method is not suitable for construction of libraries and is used chiefly for rapid subcloning of segments from large fragments of DNA in dephosphorylated vectors and for assembling recombinant constructs.

### MATERIALS

---

**CAUTION:** Please see Appendix 12 for appropriate handling of materials marked with <!>.

#### Enzymes and Buffers

<i>2x Bacteriophage T4 DNA ligase mixture</i>	
1 M Tris-Cl (pH 7.6)	1.0 $\mu$ l
100 mM MgCl <sub>2</sub>	2.0 $\mu$ l
200 mM dithiothreitol	1.0 $\mu$ l
10 mM ATP	1.0 $\mu$ l
H <sub>2</sub> O	4.5 $\mu$ l
Bacteriophage T4 DNA ligase	1 Weiss unit

10  $\mu$ l is required for each ligation.

Prepare fresh for each use in a microfuge tube chilled on ice. Store the reaction mixture in ice until needed. For definition of Weiss units, please see the information panel on **DNA LIGASES**.

#### *Restriction endonucleases*

#### Gels

##### *Low-melting-temperature agarose gel*

Please see Chapter 5.

#### Nucleic Acids and Oligonucleotides

##### *Foreign DNA*

##### *Plasmid DNA (~100 $\mu$ g/ml, dephosphorylated)*

Approximately 100 ng of dephosphorylated DNA is required for each ligation.



## Special Equipment

Heating block preset to 70°C

Ultraviolet lamp, hand-held, long wavelength (302 nm) <math>\langle ! \rangle</math>

Water bath preset to 16°C

## METHOD

---

1. Use the appropriate restriction enzyme(s) to digest an amount of target DNA sufficient to yield ~250 ng of the desired fragment. Perform the digestion in a volume of 20  $\mu$ l or less.
2. Separate the DNA fragments by electrophoresis through a low-melting/gelling-temperature agarose gel.
3. Examine the agarose gel under long-wavelength UV illumination. From the relative fluorescent intensities of the desired bands, estimate the amounts of DNA that they contain. Use a clean razor blade to cut out the desired bands in the smallest possible volume of agarose (usually 40–50  $\mu$ l). Leave a small amount of each band in the gel to mark the positions of the DNA fragments and then photograph the dissected gel.
4. Place the excised and trimmed slices of gel in separate, labeled microfuge tubes.  
If necessary, the agarose slices may be stored for a few days at 4°C in closed tubes.
5. Melt the agarose by heating the tubes to 70°C for 15 minutes in a heating block. Estimate the volume of the melted agarose in the tube and calculate the volume that would contain ~200 ng of DNA.

The aim is to harvest ~200 ng of foreign DNA in a volume of 10  $\mu$ l or less. This takes practice. However, ligations work, albeit less efficiently, for bands containing as little as 10 ng of DNA that are only just visible in the gel.

6. In a sterile microfuge tube warmed to 37°C, combine the following:

dephosphorylated plasmid DNA	60 fmoles
foreign DNA fragment	120–240 fmoles (in a volume of 10 $\mu$ l or less)

Mix the contents of the tube quickly with a sterile disposable pipette tip before the agarose solidifies.

The molar ratio of foreign DNA to plasmid vector in the ligation reaction should be no less than 2:1 and no more than 4:1.

7. In separate tubes, set up two additional ligations as controls, one containing only the dephosphorylated plasmid vector and the other containing only the fragment of foreign DNA.
8. Incubate the three tubes for 5–10 minutes at 37°C, and then add to each tube 10  $\mu$ l of ice-cold 2x bacteriophage T4 DNA ligase mixture. Mix the contents of the tube quickly with a sterile disposable pipette tip before the agarose solidifies. Incubate the reactions for 12–16 hours at 16°C.

The recombinants, products of the ligation reaction, can now be used directly for transformation (as described in Protocol 23, 24, or 25 or for electroporation as described in Protocol 26) into *E. coli*. Remelt the agarose in the ligation mixtures by heating the sealed microfuge tubes to 70°C for 10–15 minutes in a heating block before transformation or electroporation.

Typically, 1–5  $\mu$ l of each ligation reaction is used to transform chemically prepared competent bacterial cells. Only 0.1–1.0  $\mu$ l of the ligation reaction is required for transformation of bacterial cells by the more efficient method of electroporation. Addition of a greater volume of the ligation mixture will increase the solute concentration in the electroporation cell to the point where arcing becomes a distinct possibility.

# Protocol 23

---

## The Hanahan Method for Preparation and Transformation of Competent *E. coli*: High-efficiency Transformation

**W**HEN DOUG HANAHAN WAS A GRADUATE STUDENT at Cold Spring Harbor Laboratory and Harvard University in the late 1970s and early 1980s, he achieved transformation efficiencies that were unheard of previously, but then became standard. Hanahan drove a fast car, worked mostly at night and with some secrecy, never telling the ingredients of the transformation buffer that gave him such spectacular results. However, he freely and generously distributed the buffer to anyone whose experiment needed high efficiencies of transformation. A good many of the cDNA libraries generated on the East Coast in the early 1980s were established with Hanahan's transformation buffer, which was known as "Liquid Gold" because of its beautiful shimmering color.

Eventually, the formula for Liquid Gold was published, together with a detailed description of how to achieve high efficiencies of transformation (Hanahan 1983). If followed scrupulously, Hanahan's procedure can reproducibly generate competent cultures of *E. coli* that can be transformed at high frequencies ( $5 \times 10^8$  transformed colonies/ $\mu\text{g}$  of superhelical plasmid DNA). The key word here is scrupulously. Follow Hanahan's instructions *exactly* and all will be well. Take a short cut, use dirty glassware, impure water, or a stale chemical and disappointment will follow, which may explain why some investigators struggle to reproduce Hanahan's results.

Three factors appear to be crucial for obtaining consistently high frequencies of transformation of competent cells prepared by the Hanahan procedure:

- **The purity of the reagents used in the transformation buffers.** It is most important to prepare the competent cells using water and dimethylsulfoxide (DMSO) of the highest purity (Hanahan 1985). Some reagents, including components of bacterial media, decline with storage. Whenever possible, use freshly purchased reagents and growth media. If problems arise, individual reagents (e.g., DMSO, dithiothreitol [DTT], glycerol, and 2-[N-morpholino]ethanesulfonic acid [MES]) should be substituted one at a time in the transformation protocol to ascertain the quality of a given batch of reagent and its effect on the transformation frequency.
- **The state of growth of the cells.** For unknown reasons, the highest frequencies of transformation are obtained with cultures that have been grown directly from a master stock stored in freezing medium at  $-70^\circ\text{C}$ . Cultures that have been passaged continuously in the laboratory or that have been stored at  $4^\circ\text{C}$  or at room temperature should not be used.
- **The cleanliness of the glassware and plasticware.** Because trace amounts of detergent or other chemicals greatly reduce the efficiency of bacterial transformation, it is best to set aside a batch

of glassware that is used for no other purpose than to prepare competent bacteria. This glassware should be washed and rinsed by hand, filled with pure water (Milli-Q or equivalent), and sterilized by autoclaving. The water should be discarded just before the glassware is used. Keep in mind that many manufactured plastics and filters used for sterilization contain detergents that can severely reduce the transformation frequency.

Hanahan's procedure works well with strains of *E. coli* commonly used in molecular cloning, including DH1, DH5, MM294, JM108/9, DH5 $\alpha$ , and many others. However, a few strains of *E. coli* (e.g., MC1061) are refractory to this method. For further details and the extension of the method to other species of bacteria, see Hanahan et al. (1991, 1995). Other methods for transformation are described in Protocol 24 (preparation of "ultra-competent" cells) and Protocol 25 (transformation using calcium chloride).

## MATERIALS

---

**CAUTION:** Please see Appendix 12 for appropriate handling of materials marked with <!>.

### Buffers and Solutions

Please see Appendix 1 for components of stock solutions, buffers, and reagents. Dilute stock solutions to the appropriate concentrations.

#### DMSO <!>

Oxidation products of DMSO, presumably dimethyl sulfone and dimethyl sulfide, are inhibitors of transformation (Hanahan 1985).

#### DnD (DMSO and DTT) solution

1.53 g of dithiothreitol  
9 ml of DMSO  
100  $\mu$ l of 1 M potassium acetate (pH 7.5)  
H<sub>2</sub>O to 10 ml

Sterilize the DnD solution by filtration through a Millex SR membrane unit (Millipore), which is designed to withstand organic solvents. Dispense 160- $\mu$ l aliquots of the DnD solution into sterile 0.5-ml microfuge tubes. Close the tubes tightly and store them at -20°C.

For preparation of 1 M potassium acetate (pH 7.5), please see Appendix 1.

#### Transformation buffers (please see Step 1)

Standard transformation buffer (TFB) is used when preparing competent cells for immediate use. Frozen storage buffer (FSB) is used to prepare stocks of competent cells that are to be stored at -70°C.

### Media

#### SOB agar plates containing 20 mM MgSO<sub>4</sub> and the appropriate antibiotic

Standard SOB contains 10 mM MgSO<sub>4</sub>

#### SOB medium containing 20 mM MgSO<sub>4</sub>

Standard SOB contains 10 mM MgSO<sub>4</sub>

#### SOC medium

Approximately 1 ml of this medium is needed for each transformation reaction.

### Nucleic Acids and Oligonucleotides

#### Plasmid DNA (recombinant plasmid)

Construct using one of the methods described in Protocols 17 through 22 of this chapter.

### Centrifuges and Rotors

Sorvall GSA rotor or equivalent

## Special Equipment

Liquid nitrogen <math>\langle ! \rangle</math>  
 Polypropylene tubes (50 ml), chilled in ice  
 Polypropylene tubes (17 x 100 mm; Falcon 2059), chilled in ice  
 Water bath preset to 42°C

## Vectors and Bacterial Strains

*E. coli* strain to be transformed (frozen stock)  
 The strain should be stored at -70°C in freezing medium (please see Appendices 1 and 8).

## METHOD

▲ **IMPORTANT** All steps in this protocol should be carried out aseptically.

## Preparation of Cells

### 1. Prepare transformation buffer.

TFB is used when preparing competent cells for immediate use. FSB is used to prepare stocks of competent cells that are to be stored at -70°C. Organic contaminants in the H<sub>2</sub>O used to prepare transformation buffers can reduce the efficiency of transformation of competent bacteria. H<sub>2</sub>O obtained directly from a well-serviced Milli-Q filtration system (Millipore) usually gives good results. If problems should arise, treat the deionized H<sub>2</sub>O with activated charcoal before use.

### TO PREPARE STANDARD TRANSFORMATION BUFFER

- a. Prepare 1 M MES by dissolving 19.52 g of MES in 80 ml of pure H<sub>2</sub>O (Milli-Q, or equivalent). Adjust the pH of the solution to 6.3 with 5 M KOH, and add pure H<sub>2</sub>O to bring the final volume to 100 ml. Sterilize the solution by filtration through a disposable prerinsed Nalgene filter (0.45-μm pore size). Divide into 10-ml aliquots and store at -20°C.
- b. Prepare TFB by dissolving all the solutes listed below in ~500 ml of H<sub>2</sub>O and then add 10 ml of 1 M MES buffer (pH 6.3). Adjust the volume of the TFB to 1 liter with pure H<sub>2</sub>O.

Reagent	Amount per liter	Final concentration
1 M MES (pH 6.3)	10 ml	10 mM
MnCl <sub>2</sub> ·4H <sub>2</sub> O	8.91 g	45 mM
CaC <sub>2</sub> ·2H <sub>2</sub> O	1.47 g	10 mM
KCl	7.46 g	100 mM
Hexammincobalt chloride	0.80 g	3 mM
H <sub>2</sub> O	to 1 liter	

- c. Sterilize the TFB by filtration through a disposable prerinsed Nalgene filter (0.45-μm pore size). Divide the solution into 40-ml aliquots in tissue-culture flasks (e.g., Corning, or equivalent) and store them at 4°C.

### TO PREPARE FROZEN STORAGE BUFFER

- a. Prepare 1 M potassium acetate by dissolving 9.82 g of potassium acetate in 90 ml of pure H<sub>2</sub>O (Milli-Q, or equivalent). Adjust the pH of the solution to 7.5 with 2 M acetic acid, add pure H<sub>2</sub>O to bring the final volume to 100 ml. Divide the solution into aliquots and store at -20°C.

- b. Prepare FSB by dissolving all of the solutes listed below in ~500 ml of pure H<sub>2</sub>O. After the components are dissolved, adjust the pH of the solution to 6.4 with 0.1 N HCl. Too high a pH cannot be adjusted by adding base; instead, discard the solution and begin again. Adjust the volume of the final solution to 1 liter with pure H<sub>2</sub>O.

Reagent	Amount per liter	Final concentration
1 M potassium acetate (pH 7.5)	10 ml	10 mM
MnCl <sub>2</sub> ·4H <sub>2</sub> O	8.91 g	45 mM
CaCl <sub>2</sub> ·2H <sub>2</sub> O	1.47 g	10 mM
KCl	7.46 g	10 mM
Hexamminecobalt chloride	0.80 g	100 mM
Glycerol	100 ml	10% (v/v)
H <sub>2</sub> O	to 1 liter	

- c. Sterilize the solution by filtration through a disposable prerinsed Nalgene filter (0.45- $\mu$ m pore size). Dispense the solution into 40-ml aliquots and store the aliquots in tissue culture flasks (e.g., Corning, or equivalent) at 4°C. During storage, the pH of the solution drifts down to a final value of 6.1–6.2 but then stabilizes.
- Use an inoculating loop to streak *E. coli* of the desired strain directly from a frozen stock onto the surface of an SOB agar plate. Incubate the plate for 16 hours at 37°C.
 

It is not necessary to thaw the frozen stock of bacteria. Sufficient cells will stick to the loop when it is scratched across the surface of the frozen stock. A single tube of frozen stock can be used many times.
  - Transfer four or five well-isolated colonies into 1 ml of SOB containing 20 mM MgSO<sub>4</sub>. Disperse the bacteria by vortexing at moderate speed, and then dilute the culture in 30–100 ml of SOB containing 20 mM MgSO<sub>4</sub> in a 1-liter flask.
 

The colonies should be no more than 2–3 mm in diameter.
  - Grow the cells for 2.5–3.0 hours at 37°C, monitoring the growth of the culture.
 

For efficient transformation, it is essential that the number of *viable* cells not exceed 10<sup>8</sup> cells/ml, which for most strains of *E. coli* is equivalent to an OD<sub>600</sub> of ~0.4. To ensure that the culture does not grow to a higher density, measure the OD<sub>600</sub> of the culture every 15–20 minutes. Plot a graph of the data so that the time when the OD<sub>600</sub> of the culture approaches 0.4 can be predicted with some accuracy. Begin to harvest the culture when the OD<sub>600</sub> reaches 0.35.

For reasons that are unclear, the highest efficiencies of transformation are obtained at two separate points in the growth curve of *E. coli*: in early- to mid-log phase (OD<sub>600</sub> = 0.4) (Hanahan 1983) and in late-log phase (OD<sub>600</sub> = 0.95) (Tang et al. 1994). The early peak is easier to work with because the high efficiency of transformation is sustained for a longer time. The later peak is much steeper and a 2–3-minute delay in collecting the cells can cost an order of magnitude in transformation efficiency.

Because the relationship between the OD<sub>600</sub> and the number of viable cells/ml varies somewhat from strain to strain, it is essential to calibrate the spectrophotometer by measuring the OD<sub>600</sub> of a growing culture of the particular strain of *E. coli* at different times in its growth cycle and determining the number of viable cells at each of these times by plating dilutions of the culture on LB agar plates in the absence of antibiotics.
  - Transfer the cells to sterile, disposable, ice-cold 50-ml polypropylene tubes. Cool the cultures to 0°C by storing the tubes on ice for 10 minutes.
  - Recover the cells by centrifugation at 2700g (4100 rpm in a Sorvall GSA rotor) for 10 minutes at 4°C.
  - Decant the medium from the cell pellets. Stand the tubes in an inverted position for 1 minute to allow the last traces of medium to drain away.

8. Resuspend the pellets by swirling or gentle vortexing in ~20 ml (per 50-ml tube) of ice-cold TFB or FSB transformation buffer. Store the resuspended cells on ice for 10 minutes.
9. Recover the cells by centrifugation at 2700g (4100 rpm in a Sorvall GSA rotor) for 10 minutes at 4°C.
10. Decant the buffer from the cell pellets. Stand the tubes in an inverted position for 1 minute to allow the last traces of buffer to drain away.
11. Resuspend the pellets by swirling or gentle vortexing in 4 ml (per 50-ml tube) of ice-cold TFB or FSB. Proceed either with Step 12a if the competent cells are to be used immediately or with Step 12b if the competent cells are to be stored at -70°C and used at a later date.

## Preparation of Competent Cells

12. Prepare competent cells for transformation.

### TO PREPARE FRESH COMPETENT CELLS

- a. Add 140 µl of DnD solution into the center of each cell suspension. Immediately mix by swirling gently, and then store the suspension on ice for 15 minutes.
- b. Add an additional 140 µl of DnD solution to each suspension. Mix by swirling gently, and then store the suspension on ice for a further 15 minutes.
- c. Dispense aliquots of the suspensions into chilled, sterile 17 × 100-mm polypropylene tubes. Store the tubes on ice.

For most cloning purposes, 50-µl aliquots of the competent-cell suspension will be more than adequate. However, when large numbers of transformed colonies are required (e.g., when constructing cDNA libraries), larger aliquots may be needed.

Glass tubes should not be used as they lower the efficiency of transformation by ~10-fold.

### TO PREPARE FROZEN STOCKS OF COMPETENT CELLS

- a. Add 140 µl of DMSO per 4 ml of resuspended cells. Mix gently by swirling, and store the suspension on ice for 15 minutes.
- b. Add an additional 140 µl of DMSO to each suspension. Mix gently by swirling, and then return the suspensions to an ice bath.
- c. Working quickly, dispense aliquots of the suspensions into chilled, sterile microfuge tubes or tissue culture vials. Immediately snap-freeze the competent cells by immersing the tightly closed tubes in a bath of liquid nitrogen. Store the tubes at -70°C until needed.

For most cloning purposes, 50-µl aliquots of the competent-cell suspension will be more than adequate. However, when large numbers of transformed colonies are required (e.g., when constructing cDNA libraries), larger aliquots may be needed.

- d. When needed, remove a tube of competent cells from the -70°C freezer. Thaw the cells by holding the tube in the palm of the hand. Just as the cells thaw, transfer the tube to an ice bath. Store the cells on ice for 10 minutes.
- e. Use a chilled, sterile pipette tip to transfer the competent cells to chilled, sterile 17 × 100-mm polypropylene tubes. Store the cells on ice.

Glass tubes should not be used as they lower the efficiency of transformation by ~10-fold.

## Transformation

Include all of the appropriate positive and negative controls (please see the panel on **BACTERIAL TRANSFORMATION**).

13. Add the transforming DNA (up to 25 ng per 50  $\mu$ l of competent cells) in a volume not exceeding 5% of that of the competent cells. Swirl the tubes gently several times to mix their contents. Set up at least two control tubes for each transformation experiment, including a tube of competent bacteria that receives a known amount of a standard preparation of super-helical plasmid DNA and a tube of cells that receives no plasmid DNA at all. Store the tubes on ice for 30 minutes.

14. Transfer the tubes to a rack placed in a preheated 42°C circulating water bath. Store the tubes in the rack for exactly 90 seconds. Do not shake the tubes.

Heat shock is a crucial step. It is very important that the cells be raised to exactly the right temperature at the correct rate. The incubation times and temperatures given here have been worked out using Falcon 2059 tubes. Other types of tubes will not necessarily yield equivalent results.

15. Rapidly transfer the tubes to an ice bath. Allow the cells to cool for 1–2 minutes.
16. Add 800  $\mu$ l of SOC medium to each tube. Warm the cultures to 37°C in a water bath, and then transfer the tubes to a shaking incubator set at 37°C. Incubate the cultures for 45 minutes to allow the bacteria to recover and to express the antibiotic resistance marker encoded by the plasmid.

To maximize the efficiency of transformation, gently agitate (<225 cycles/minute) the cells during the recovery period.

If screening by  $\alpha$ -complementation, proceed to Protocol 27 for plating.

17. Transfer the appropriate volume (up to 200  $\mu$ l per 90-mm plate) of transformed competent cells onto agar SOB medium containing 20 mM  $MgSO_4$  and the appropriate antibiotic.

When selecting for resistance to tetracycline, the entire transformation mixture may be spread on a single plate (or plated in top agar). In this case, collect the bacteria by centrifuging for 20 seconds at room temperature in a microfuge, and then gently resuspend the cell pellet in 100  $\mu$ l of SOC medium by tapping the sides of the tube.

**▲ IMPORTANT** Sterilize a bent glass rod by dipping it into ethanol and then in the flame of a Bunsen burner. When the rod has cooled to room temperature, spread the transformed cells gently over the surface of the agar plate.

When selecting for resistance to ampicillin, transformed cells should be plated at low density (<10<sup>4</sup> colonies per 90-mm plate), and the plates should not be incubated for more than 20 hours at 37°C. The enzyme  $\beta$ -lactamase is secreted into the medium from ampicillin-resistant transformants and can rapidly inactivate the antibiotic in regions surrounding the colonies. Thus, plating cells at high density or incubating them for long periods of time results in the appearance of ampicillin-sensitive satellite colonies. This problem is ameliorated, but not completely eliminated, by using carbenicillin rather than ampicillin in selective media and increasing the concentration of antibiotic from 60  $\mu$ g/ml to 100  $\mu$ g/ml. The number of ampicillin-resistant colonies does not increase in linear proportion to the number of cells applied to the plate, perhaps because of growth-inhibiting substances released from the cells killed by the antibiotic.

18. Store the plates at room temperature until the liquid has been absorbed.
19. Invert the plates and incubate them at 37°C. Transformed colonies should appear in 12–16 hours.

Transformed colonies may be screened for the presence of recombinant plasmids using one of the methods described in Protocols 27, 28, 31, and 32 of this chapter or Protocol 12 in Chapter 8.

### BACTERIAL TRANSFORMATION

In every experiment, it is essential to include positive controls to measure the efficiency of transformation, and negative controls to eliminate the possibility of contamination and to identify the potential causes of failure.

#### Negative Controls

An aliquot of competent cells to which no DNA is added should be carried through the transformation experiment. The entire aliquot should be plated on a single agar plate containing the appropriate antibiotic used to select transformants. No bacterial colonies should grow on this plate or on a selective plate that received no bacteria at all. If any are detected, the following possibilities should be considered:

- **The competent cells are contaminated with an antibiotic-resistant strain of bacteria during the experiment.** Perhaps one of the solutions/reagents used in the transformation protocol is contaminated.
- **The selective plates are defective.** Perhaps the antibiotic was omitted altogether from the plates or was added to agar that was too hot.
- **The selective plates are contaminated with an antibiotic resistant strain of bacteria.** In this case, colonies usually appear both on the surface of the medium and in the agar.

#### Positive Controls

An aliquot of competent cells should be transformed with a known amount of a standard preparation of circular superhelical plasmid DNA. This control provides a measure of the efficiency of transformation and allows a standard for comparison with previous transformation experiments. We recommend preparing two large batches of diluted supercoiled plasmid DNA (1 ng/ml for the Hanahan and Inoue procedures; 500 ng/ml for the calcium chloride procedure). These preparations should be stored at  $-70^{\circ}\text{C}$  in TE (pH 7.8) in very small aliquots. The appropriate standard preparation (2–5  $\mu\text{l}$ ) should be used to measure the efficiency of transformation of each new batch of competent cells and to check the efficiency of transformation in every experiment. Failure to obtain transformed colonies in a given experiment indicates problems with the competent bacteria or the transformation buffer.

When a ligation reaction is used as a source of transforming DNA, the transformation efficiency is reduced by at least two orders of magnitude compared with the supercoiled plasmid DNA control. The actual number of transformants obtained per  $\mu\text{g}$  of ligated DNA will depend on the amount of recombinant plasmid generated during the ligation reaction, and on the presence of inhibitors of transformation such as agarose and enzymes.



# Protocol 24

---

## The Inoue Method for Preparation and Transformation of Competent *E. Coli*: “Ultra-Competent” Cells

**A**T ITS BEST, THIS METHOD FOR PREPARING COMPETENT *E. coli* from Inoue et al. (1990) can challenge the efficiencies achieved by Hanahan (1983). However, under standard laboratory conditions, efficiencies of  $1 \times 10^8$  to  $3 \times 10^8$  transformed colonies/ $\mu\text{g}$  of plasmid DNA are more typical. The advantages of the procedure are that it is less finicky, more reproducible, and therefore more predictable than the original Hanahan method.

This protocol differs from other procedures in that the bacterial culture is grown at 18°C rather than the conventional 37°C. Otherwise, the protocol is unremarkable and follows a fairly standard course. Why growing the cells at low temperature should affect the efficiency of transformation is anybody's guess. Perhaps the composition or the physical characteristics of bacterial membranes synthesized at 18°C are more favorable for uptake of DNA, or perhaps the phases of the growth cycle that favor efficient transformation are extended.

Incubating bacterial cultures at 18°C is a challenge. Most laboratories do not have a shaking incubator that can accurately maintain a temperature of 18°C summer and winter. One solution is to place an incubator in a 4°C cold room and use the temperature control to heat the incubator to 18°C. Alternatively, there is almost no loss of efficiency if the cultures are grown at 20–23°C, which is the ambient temperature in many laboratories. Cultures incubated at these temperatures grow slowly with a doubling time of 2.5 to 4 hours. This can lead to frustration, especially late at night when it seems that the culture will never reach the desired  $\text{OD}_{600}$  of 0.6. The answer to this problem is to set up cultures in the evening and harvest the bacteria early the following morning. The procedure works well with many strains of *E. coli* in common use in molecular cloning, including XL1-Blue, DH1, JM103, JM108/9, DH5 $\alpha$ , and HB101.

### MATERIALS

---

**CAUTION:** Please see Appendix 12 for appropriate handling of materials marked with <!>.

#### Buffers and Solutions

Please see Appendix 1 for components of stock solutions, buffers, and reagents. Dilute stock solutions to the appropriate concentrations.

#### DMSO <!>

Oxidation products of DMSO, presumably dimethyl sulfone and dimethyl sulfide, are inhibitors of transformation (Hanahan 1985). To avoid problems, purchase DMSO of the highest quality.

#### *Inoue transformation buffer* (please see Step 1)

Chilled to 0°C before use.

## Nucleic Acids and Oligonucleotides

*Plasmid DNA (recombinant plasmid)*

Construct using one of the methods described in Protocols 17 through 22 of this chapter.

## Media

*LB or SOB medium for initial growth of culture*

*SOB agar plates containing 20 mM MgSO<sub>4</sub> and the appropriate antibiotic*

Standard SOB contains 10 mM MgSO<sub>4</sub>.

*SOB medium, for growth of culture to be transformed*

Prepare three 1-liter flasks of 250 ml each and equilibrate the medium to 18–20°C before inoculation.

*SOC medium*

Approximately 1 ml of this medium is needed for each transformation reaction.

## Centrifuges and Rotors

*Sorvall GSA rotor or equivalent*

## Special Equipment

*Liquid nitrogen <math>\langle ! \rangle</math>*

*Polypropylene tubes (17 × 100 mm; Falcon 2059), chilled in ice*

*Shaking Incubator (18°C)*

*Water bath preset to 42°C*

## METHOD

▲ **IMPORTANT** All steps in this protocol should be carried out aseptically.

## Preparation of Cells

1. Prepare Inoue transformation buffer (chilled to 0°C before use).

Organic contaminants in the H<sub>2</sub>O used to prepare transformation buffers can reduce the efficiency of transformation of competent bacteria. H<sub>2</sub>O obtained directly from a well-serviced Milli-Q filtration system (Millipore) usually gives good results. If problems should arise, treat the deionized H<sub>2</sub>O with activated charcoal before use.

- a. Prepare 0.5 M PIPES (pH 6.7) (piperazine-1,2-bis[2-ethanesulfonic acid]) by dissolving 15.1 g of PIPES in 80 ml of pure H<sub>2</sub>O (Milli-Q, or equivalent). Adjust the pH of the solution to 6.7 with 5 M KOH, and then add pure H<sub>2</sub>O to bring the final volume to 100 ml. Sterilize the solution by filtration through a disposable prerinsed Nalgene filter (0.45- $\mu$ m pore size). Divide into aliquots and store frozen at –20°C.
- b. Prepare Inoue transformation buffer by dissolving all of the solutes listed below in 800 ml of pure H<sub>2</sub>O and then add 20 ml of 0.5 M PIPES (pH 6.7). Adjust the volume of the Inoue transformation buffer to 1 liter with pure H<sub>2</sub>O.

Reagent	Amount per liter	Final concentration
MnCl <sub>2</sub> ·4H <sub>2</sub> O	10.88 g	55 mM
CaCl <sub>2</sub> ·2H <sub>2</sub> O	2.20 g	15 mM
KCl	18.65 g	250 mM
PIPES (0.5 M, pH 6.7)	20 ml	10 mM
H <sub>2</sub> O	to 1 liter	

- c. Sterilize Inoue transformation buffer by filtration through a prerinsed 0.45- $\mu$ m Nalgene filter. Divide into aliquots and store at –20°C.

2. Pick a single bacterial colony (2–3 mm in diameter) from a plate that has been incubated for 16–20 hours at 37°C. Transfer the colony into 25 ml of LB broth or SOB medium in a 250-ml flask. Incubate the culture for 6–8 hours at 37°C with vigorous shaking (250–300 rpm).
3. At about 6 o'clock in the evening, use this starter culture to inoculate three 1-liter flasks, each containing 250 ml of SOB. The first flask receives 10 ml of starter culture, the second receives 4 ml, and the third receives 2 ml. Incubate all three flasks overnight at 18–22°C with moderate shaking.
4. The following morning, read the OD<sub>600</sub> of all three cultures. Continue to monitor the OD every 45 minutes.
5. When the OD<sub>600</sub> of one of the cultures reaches 0.55, transfer the culture vessel to an ice-water bath for 10 minutes. Discard the two other cultures.

The ambient temperature of most laboratories rises during the day and falls during the night. The number of degrees and the timing of the drop from peak to trough varies depending on the time of year, the number of people working in the laboratory at night, and so on. Because of this variability, it is difficult to predict the rate at which cultures will grow on any given night. Using three different inocula increases the chances that one of the cultures will be at the correct density after an overnight incubation.
6. Harvest the cells by centrifugation at 2500g (3900 rpm in a Sorvall GSA rotor) for 10 minutes at 4°C.
7. Pour off the medium and store the open centrifuge bottle on a stack of paper towels for 2 minutes. Use a vacuum aspirator to remove any drops of remaining medium adhering to walls of the centrifuge bottle or trapped in its neck.
8. Resuspend the cells gently in 80 ml of ice-cold Inoue transformation buffer.

The cells are best suspended by swirling rather than pipetting or vortexing.
9. Harvest the cells by centrifugation at 2500g (3900 rpm in a Sorvall GSA rotor) for 10 minutes at 4°C.
10. Pour off the medium and store the open centrifuge tube on a stack of paper towels for 2 minutes. Use a vacuum aspirator to remove any drops of remaining medium adhering to the walls of the centrifuge tube or trapped in its neck.

### Freezing of Competent Cells

11. Resuspend the cells gently in 20 ml of ice-cold Inoue transformation buffer.
12. Add 1.5 ml of DMSO. Mix the bacterial suspension by swirling and then store it in ice for 10 minutes.
13. Working quickly, dispense aliquots of the suspensions into chilled, sterile microfuge tubes. Immediately snap-freeze the competent cells by immersing the tightly closed tubes in a bath of liquid nitrogen. Store the tubes at –70°C until needed.

Freezing in liquid nitrogen enhances transformation efficiency by ~5-fold.  
For most cloning purposes, 50- $\mu$ l aliquots of the competent-cell suspension will be more than adequate. However, when large numbers of transformed colonies are required (e.g., when constructing cDNA libraries), larger aliquots may be necessary.
14. When needed, remove a tube of competent cells from the –70°C freezer. Thaw the cells by holding the tube in the palm of the hand. Just as the cells thaw, transfer the tube to an ice bath. Store the cells on ice for 10 minutes.

15. Use a chilled, sterile pipette tip to transfer the competent cells to chilled, sterile 17 × 100-mm polypropylene tubes. Store the cells on ice.

Glass tubes should not be used since they lower the efficiency of transformation by ~10-fold

## Transformation

Include all of the appropriate positive and negative controls (please see the panel on **BACTERIAL TRANSFORMATION** in Protocol 23).

16. Add the transforming DNA (up to 25 ng per 50  $\mu$ l of competent cells) in a volume not exceeding 5% of that of the competent cells. Swirl the tubes gently several times to mix their contents. Set up at least two control tubes for each transformation experiment, including a tube of competent bacteria that receives a known amount of a standard preparation of super-helical plasmid DNA and a tube of cells that receives no plasmid DNA at all. Store the tubes on ice for 30 minutes.

17. Transfer the tubes to a rack placed in a preheated 42°C circulating water bath. Store the tubes in the rack for exactly 90 seconds. Do not shake the tubes.

Heat shock is a crucial step. It is very important that the cells be raised to exactly the right temperature at the correct rate. The incubation times and temperatures given here have been worked out using Falcon 2059 tubes. Other types of tubes will not necessarily yield equivalent results.

18. Rapidly transfer the tubes to an ice bath. Allow the cells to cool for 1–2 minutes.

19. Add 800  $\mu$ l of SOC medium to each tube. Warm the cultures to 37°C in a water bath, and then transfer the tubes to a shaking incubator set at 37°C. Incubate the cultures for 45 minutes to allow the bacteria to recover and to express the antibiotic resistance marker encoded by the plasmid.

To maximize the efficiency of transformation, gently agitate (<225 cycles/minute) the cells during the recovery period.

If screening by  $\alpha$ -complementation, proceed to Protocol 27 for plating.

20. Transfer the appropriate volume (up to 200  $\mu$ l per 90-mm plate) of transformed competent cells onto agar SOB medium containing 20 mM MgSO<sub>4</sub> and the appropriate antibiotic.

When selecting for resistance to tetracycline, the entire transformation mixture may be spread on a single plate (or plated in top agar). In this case, collect the bacteria by centrifuging for 20 seconds at room temperature in a microfuge, and then gently resuspend the cell pellet in 100  $\mu$ l of SOC medium by tapping the sides of the tube.

▲ **IMPORTANT** Sterilize a bent glass rod by dipping it into ethanol and then in the flame of a Bunsen burner. When the rod has cooled to room temperature, spread the transformed cells gently over the surface of the agar plate.

When selecting for resistance to ampicillin, transformed cells should be plated at low density (<10<sup>4</sup> colonies per 90-mm plate), and the plates should not be incubated for more than 20 hours at 37°C. The enzyme  $\beta$ -lactamase is secreted into the medium from ampicillin-resistant transformants and can rapidly inactivate the antibiotic in regions surrounding the colonies. Thus, plating cells at high density or incubating them for long periods of time results in the appearance of ampicillin-sensitive satellite colonies. This problem is ameliorated, but not completely eliminated, by using carbenicillin rather than ampicillin in selective media and increasing the concentration of antibiotic from 60  $\mu$ g/ml to 100  $\mu$ g/ml. The number of ampicillin-resistant colonies does not increase in linear proportion to the number of cells applied to the plate, perhaps because of growth-inhibiting substances released from the cells killed by the antibiotic.

21. Store the plates at room temperature until the liquid has been absorbed.

22. Invert the plates and incubate them at 37°C. Transformed colonies should appear in 12–16 hours.

Transformed colonies may be screened for the presence of recombinant plasmids using one of the methods described in Protocols 27, 28, 31, and 32 of this chapter or Protocol 12 in Chapter 8.

# Protocol 25

---

## Preparation and Transformation of Competent *E. coli* using Calcium Chloride

**T**HE FOLLOWING SIMPLE AND RAPID VARIATION OF THE TECHNIQUE published by Cohen et al. (1972) is frequently used to prepare batches of competent bacteria that yield  $5 \times 10^6$  to  $2 \times 10^7$  transformed colonies/ $\mu\text{g}$  of supercoiled plasmid DNA. This efficiency of transformation is high enough to allow all routine cloning in plasmids to be performed with ease. Competent cells made by this procedure may be preserved at  $-70^\circ\text{C}$ , although there may be some deterioration in the efficiency of transformation during prolonged storage.

### MATERIALS

---

#### Buffers and Solutions

Please see Appendix 1 for components of stock solutions, buffers, and reagents. Dilute stock solutions to the appropriate concentrations.

##### *CaCl<sub>2</sub>·2H<sub>2</sub>O (1 M)*

When preparing competent cells, thaw a 10-ml aliquot of the stock solution and dilute it to 100 ml with 90 ml of pure H<sub>2</sub>O. Sterilize the solution by filtration through a prerinsed Nalgene filter (0.45- $\mu\text{m}$  pore size), and then chill it to  $0^\circ\text{C}$ .

or

##### *Standard transformation buffer (TFB) (please see Protocol 23, Step 1)*

For many strains of *E. coli*, standard TFB (Hanahan 1983) may be used instead of CaCl<sub>2</sub> with equivalent or better results.

##### *MgCl<sub>2</sub>-CaCl<sub>2</sub> solution, ice cold*

#### Media

*LB or SOB medium for initial growth of culture*

*SOB agar plates containing 20 mM MgSO<sub>4</sub> and the appropriate antibiotic*

Standard SOB contains 10 mM MgSO<sub>4</sub>.

*SOC medium*

Approximately 1 ml of this medium is required for each transformation reaction.

#### Nucleic Acids and Oligonucleotides

*Plasmid DNA (recombinant plasmid)*

Construct using one of the methods described in Protocols 17 through 22 of this chapter.

## Centrifuges and Rotors

Sorvall GSA rotor or equivalent

## Special Equipment

Polypropylene tube (50 ml), chilled in ice

Polypropylene tubes (17 × 100 mm; Falcon 2059), chilled in ice

Water bath preset to 42°C

## METHOD

---

▲ **IMPORTANT** All steps in this procedure should be carried out aseptically.

### Preparation of Cells

1. Pick a single bacterial colony (2–3 mm in diameter) from a plate that has been incubated for 16–20 hours at 37°C. Transfer the colony into 100 ml of LB broth or SOB medium in a 1-liter flask. Incubate the culture for 3 hours at 37°C with vigorous agitation, monitoring the growth of the culture. As a guideline, 1 OD<sub>600</sub> of a culture of *E. coli* strain DH1 contains ~10<sup>9</sup> bacteria/ml.

For efficient transformation, it is essential that the number of *viable* cells not exceed 10<sup>8</sup> cells/ml, which for most strains of *E. coli* is equivalent to an OD<sub>600</sub> of ~0.4. To ensure that the culture does not grow to a higher density, measure the OD<sub>600</sub> of the culture every 15–20 minutes. Plot a graph of the data so that the time when the OD<sub>600</sub> of the culture approaches 0.4 can be predicted with some accuracy. Begin to harvest the culture when the OD<sub>600</sub> reaches 0.35.

Because the relationship between the OD<sub>600</sub> and the number of viable cells/ml varies substantially from strain to strain, the spectrophotometer must be calibrated by measuring the OD<sub>600</sub> of a growing culture of the particular strain of *E. coli* at different times in its growth cycle and determining the number of viable cells at each of these times by plating dilutions of the culture on LB agar plates in the absence of antibiotics.

2. Transfer the bacterial cells to sterile, disposable, ice-cold 50-ml polypropylene tubes. Cool the cultures to 0°C by storing the tubes on ice for 10 minutes.
3. Recover the cells by centrifugation at 2700g (4100 rpm in a Sorvall GSA rotor) for 10 minutes at 4°C.
4. Decant the medium from the cell pellets. Stand the tubes in an inverted position on a pad of paper towels for 1 minute to allow the last traces of media to drain away.
5. Resuspend each pellet by swirling or gentle vortexing in 30 ml of ice-cold MgCl<sub>2</sub>–CaCl<sub>2</sub> solution (80 mM MgCl<sub>2</sub>, 20 mM CaCl<sub>2</sub>).
6. Recover the cells by centrifugation at 2700g (4100 rpm in a Sorvall GSA rotor) for 10 minutes at 4°C.
7. Decant the medium from the cell pellets. Stand the tubes in an inverted position on a pad of paper towels for 1 minute to allow the last traces of media to drain away.
8. Resuspend the pellet by swirling or gentle vortexing in 2 ml of ice-cold 0.1 M CaCl<sub>2</sub> (or TFB) for each 50 ml of original culture.
9. At this point, either use the cells directly for transformation as described in Steps 10 through 16 below or dispense into aliquots and freeze at –70°C (please see Protocol 23, Step 12).

For most strains of *E. coli* (except for MC1061), TFB may be used at this stage instead of  $\text{CaCl}_2$  with equivalent or better results.

The cells may be stored at 4°C in  $\text{CaCl}_2$  solution for 24–48 hours (Dagert and Ehrlich 1979). The efficiency of transformation increases four- to sixfold during the first 12–24 hours of storage and thereafter decreases to the original level.

## Transformation

Include all of the appropriate positive and negative controls (please see the panel on **BACTERIAL TRANSFORMATION** in Protocol 23).

10. To transform the  $\text{CaCl}_2$ -treated cells directly, transfer 200  $\mu\text{l}$  of each suspension of competent cells to a sterile, chilled 17 × 100-mm polypropylene tube using a chilled micropipette tip. Add DNA (no more than 50 ng in a volume of 10  $\mu\text{l}$  or less) to each tube. Mix the contents of the tubes by swirling gently. Store the tubes on ice for 30 minutes.
11. Transfer the tubes to a rack placed in a preheated 42°C circulating water bath. Store the tubes in the rack for exactly 90 seconds. Do not shake the tubes.

Heat shock is a crucial step. It is very important that the cells be raised to exactly the right temperature at the correct rate.

12. Rapidly transfer the tubes to an ice bath. Allow the cells to chill for 1–2 minutes.
13. Add 800  $\mu\text{l}$  of SOC medium to each tube. Incubate the cultures for 45 minutes in a water bath set at 37°C to allow the bacteria to recover and to express the antibiotic resistance marker encoded by the plasmid.

The cells may be gently agitated (50 cycles/minute or less in a rotary shaker) at 37°C during the recovery period.

If screening by  $\alpha$ -complementation, proceed to Protocol 27 for plating.

14. Transfer the appropriate volume (up to 200  $\mu\text{l}$  per 90-mm plate) of transformed competent cells onto agar SOB medium containing 20 mM  $\text{MgSO}_4$  and the appropriate antibiotic.

When selecting for resistance to tetracycline, the entire transformation mixture may be spread on a single plate (or plated in top agar). In this case, collect the bacteria by centrifuging for 20 seconds at room temperature in a microfuge, and then gently resuspend the cell pellet in 100  $\mu\text{l}$  of SOC medium by tapping the sides of the tube.

**▲ IMPORTANT** Sterilize a bent glass rod by dipping it into ethanol and then in the flame of a Bunsen burner. When the rod has cooled to room temperature, spread the transformed cells gently over the surface of the agar plate.

When selecting for resistance to ampicillin, transformed cells should be plated at low density (<10<sup>4</sup> colonies per 90-mm plate), and the plates should not be incubated for more than 20 hours at 37°C. The enzyme  $\beta$ -lactamase is secreted into the medium from ampicillin-resistant transformants and can rapidly inactivate the antibiotic in regions surrounding the colonies. Thus, plating cells at high density or incubating them for long periods of time results in the appearance of ampicillin-sensitive satellite colonies. This problem is ameliorated, but not completely eliminated, by using carbenicillin rather than ampicillin in selective media and increasing the concentration of antibiotic from 60  $\mu\text{g}/\text{ml}$  to 100  $\mu\text{g}/\text{ml}$ . The number of ampicillin-resistant colonies does not increase in linear proportion to the number of cells applied to the plate, perhaps because of growth-inhibiting substances released from the cells killed by the antibiotic.

15. Store the plates at room temperature until the liquid has been absorbed.
16. Invert the plates and incubate at 37°C. Transformed colonies should appear in 12–16 hours.

Transformed colonies may be screened for the presence of recombinant plasmids using one of the methods described in Protocols 27, 28, 31, and 32 of this chapter.

# Protocol 26

---

## Transformation of *E. coli* by Electroporation

**P**REPARED ELECTROCOMPETENT BACTERIA IS CONSIDERABLY easier than preparing cells for transformation by chemical methods. Bacteria are simply grown to mid-log phase, chilled, centrifuged, washed extensively with ice-cold buffer or H<sub>2</sub>O to reduce the ionic strength of the cell suspension, and then suspended in an ice-cold buffer containing 10% glycerol. DNA may be introduced immediately into the bacteria by exposing them to a short high-voltage electrical discharge (Chassy and Flickinger 1987; Chassy et al. 1988; Dower et al. 1988; please see the information panel on **ELECTROPORATION**). Alternatively, the cell suspension may be snap-frozen and stored at -70°C for up to 6 months before electroporation, without loss of transforming efficiency.

Because *E. coli* cells are small, they require very high field strengths (12.5–15 kV cm<sup>-1</sup>) for electroporation compared to those used to introduce DNA into eukaryotic cells (Dower et al. 1988; Smith et al. 1990). Optimal efficiency is achieved using small volumes of a dense slurry of bacteria (~2 × 10<sup>10</sup>/ml) contained in specially designed cuvettes fitted with closely spaced electrodes. Electroporation is temperature-dependent and is best carried out at 0–4°C. The efficiency of transformation drops as much as 100-fold when electroporation is carried out at room temperature.

The highest *efficiency* of transformation (colonies/μg input plasmid DNA) is obtained when the concentration of input DNA is high (1–10 μg/ml) and when the length and intensity of the electrical pulse are such that only 30–50% of the cells survive the procedure. Under these conditions, as many as 80% of the surviving cells may be transformed. Higher *frequencies* of transformation (colonies/molecule input DNA) are obtained when the DNA concentration is low (~10 pg/ml). Most of the transformants then result from the introduction of a single plasmid molecule into an individual cell. High concentrations of DNA, on the other hand, favor the formation of cotransformants in which more than one plasmid molecule becomes established in transformed cells (Dower et al. 1988). This is highly undesirable in some circumstances, for example, when generating cDNA libraries in plasmid vectors.

The method outlined in this protocol works well with most strains of *E. coli* and with plasmids <15 kb in size. However, substantial variation in the efficiency of transformation between strains of *E. coli* has been reported (e.g., please see Elvin and Bingham 1991; Miller and Nickoloff 1995), and given what is known about the mechanism of uptake of DNA by electroporation, it would be reasonable to expect that very large plasmids would transform *E. coli* with reduced efficiency. As is the case with chemical transformation, linear plasmid DNAs introduced into *E. coli* by a pulsed electrical discharge transform very inefficiently — from 10- to 1000-fold less effi-



ciently than the corresponding closed circular DNA — perhaps because the exposed termini of linear DNA are susceptible to attack by intracellular nucleases.

## MATERIALS

---

**CAUTION:** Please see Appendix 12 for appropriate handling of materials marked with <!>.

### Buffers and Solutions

Please see Appendix 1 for components of stock solutions, buffers, and reagents. Dilute stock solutions to the appropriate concentrations.

*Glycerol (10% v/v) (molecular biology grade), ice cold*

*Pure H<sub>2</sub>O*

Milli-Q or equivalent, sterilized by filtration through prerinsed 0.45- $\mu$ m filters. Store at 4°C.

### Nucleic Acids and Oligonucleotides

*Plasmid DNA (recombinant plasmid)*

Construct using one of the methods described in Protocols 17 through 22 of this chapter.

### Media

*GYT medium, ice cold*

10% (v/v) glycerol

0.125% (w/v) yeast extract

0.25% (w/v) tryptone

This recipe comes from Tung and Chow (1995).

*LB medium, prewarmed to 37°C*

*SOB agar plates containing 20 mM MgSO<sub>4</sub> and the appropriate antibiotic*

Standard SOB contains 10 mM MgSO<sub>4</sub>.

*SOC medium*

Approximately 1 ml of this medium is needed for each transformation reaction.

### Special Equipment

*Electroporation device and cuvettes fitted with electrodes spaced 0.1–0.2 cm apart*

The smaller the gap between the electrodes, the higher the strength of the electrical field generated by a given voltage. However, the risk of arcing increases as the distance between the electrodes decreases and as the applied voltage is raised. Conservative investigators will therefore choose cuvettes with a gap of 0.2 cm, whereas those who are willing to take risks with their experiments will opt for the smaller gap.

*Ice water bath*

*Liquid nitrogen <!>*

## METHOD

---

▲ **IMPORTANT** All steps in this protocol should be carried out aseptically.

### Preparation of Cells

1. Inoculate a single colony of *E. coli* from a fresh agar plate into a flask containing 50 ml of LB medium. Incubate the culture overnight at 37°C with vigorous aeration (250 rpm in a rotary shaker).
2. Inoculate two aliquots of 500 ml of prewarmed LB medium in separate 2-liter flasks with 25 ml of the overnight bacterial culture. Incubate the flasks at 37°C with agitation (300 cycles/minute in a rotary shaker). Measure the OD<sub>600</sub> of the growing bacterial cultures every 20 minutes.

Optimum results ( $>10^9$  transformants/ $\mu\text{g}$ ) are obtained with standard strains of *E. coli* (DH1, DH5 $\alpha$ , JM103, JM109, HB101, and their derivatives) when the OD<sub>600</sub> of the culture is 0.35–0.4. This density is usually achieved after ~2.5 hours of incubation.

For efficient transformation, it is essential that the number of *viable* cells not exceed  $10^8$  cells/ml, which for most strains of *E. coli* is equivalent to an OD<sub>600</sub> of ~0.4. To ensure that the culture does not grow to a higher density, measure the OD<sub>600</sub> of the culture every 15–20 minutes. Plot a graph of the data so that the time when the OD<sub>600</sub> of the culture approaches 0.4 can be predicted with some accuracy. Begin to harvest the culture when the OD<sub>600</sub> reaches 0.35.

- When the OD<sub>600</sub> of the cultures reaches 0.4, rapidly transfer the flasks to an ice-water bath for 15–30 minutes. Swirl the culture occasionally to ensure that cooling occurs evenly. In preparation for the next step, place the centrifuge bottles in an ice-water bath.

For maximum efficiency of transformation, it is crucial that the temperature of the bacteria not rise above 4°C at any stage in the protocol.

- Transfer the cultures to ice-cold centrifuge bottles. Harvest the cells by centrifugation at 1000g (2500 rpm in a Sorvall GSA rotor) for 15 minutes at 4°C. Decant the supernatant and resuspend the cell pellet in 500 ml of ice-cold pure H<sub>2</sub>O.
- Harvest the cells by centrifugation at 1000g (2500 rpm in a Sorvall GSA rotor) for 20 minutes at 4°C. Decant the supernatant and resuspend the cell pellet in 250 ml of ice-cold 10% glycerol.
- Harvest the cells by centrifugation at 1000g (2500 rpm in a Sorvall GSA rotor) for 20 minutes at 4°C. Decant the supernatant and resuspend the pellet in 10 ml of ice-cold 10% glycerol.

Take care when decanting because the bacterial pellets lose adherence in 10% glycerol.

- Harvest cells by centrifugation at 1000g (2500 rpm in a Sorvall GSA rotor) for 20 minutes at 4°C. Carefully decant the supernatant and use a Pasteur pipette attached to a vacuum line to remove any remaining drops of buffer. Resuspend the pellet in 1 ml of ice-cold GYT medium.

This is best done by gentle swirling rather than pipetting or vortexing.

- Measure the OD<sub>600</sub> of a 1:100 dilution of the cell suspension. Dilute the cell suspension to a concentration of  $2 \times 10^{10}$  to  $3 \times 10^{10}$  cells/ml ( $1.0 \text{ OD}_{600} = \sim 2.5 \times 10^8$  cells/ml) with ice-cold GYT medium.
- Transfer 40  $\mu\text{l}$  of the suspension to an ice-cold electroporation cuvette (0.2-cm gap) and test whether arcing occurs when an electrical discharge is applied (please see Step 16 below). If so, wash the remainder of the cell suspension once more with ice-cold GYT medium to ensure that the conductivity of the bacterial suspension is sufficiently low ( $<5$  mEq).
- To use the electrocompetent cells immediately, proceed directly to Step 12. Otherwise, store the cells at  $-70^\circ\text{C}$  until required. For storage, dispense 40- $\mu\text{l}$  aliquots of the cell suspension into sterile, ice-cold 0.5-ml microfuge tubes, drop into a bath of liquid nitrogen, and transfer to a  $-70^\circ\text{C}$  freezer.
- To use frozen electrocompetent cells, remove an appropriate number of aliquots of cells from the  $-70^\circ\text{C}$  freezer. Store the tubes at room temperature until the bacterial suspensions are thawed and then transfer the tubes to an ice bath.

## Electroporation

- Pipette 40  $\mu\text{l}$  of the freshly made (or thawed) electrocompetent cells into ice-cold sterile 0.5-ml microfuge tubes. Place the cells on ice, together with an appropriate number of bacterial electroporation cuvettes.

13. Add 10 pg to 25 ng of the DNA to be electroporated in a volume of 1–2  $\mu$ l to each microfuge tube and incubate the tube on ice for 30–60 seconds. Include all of the appropriate positive and negative controls (please see the panel on **BACTERIAL TRANSFORMATION** in Protocol 23).

Ideally, the DNA to be electroporated should be resuspended at a concentration of 1–10  $\mu$ g/ml in  $H_2O$  or TE (pH 8.0). Two options are available when a DNA ligation reaction is used directly for electroporation. Either the ligation reaction can be diluted 1/10 to 1/20 in  $H_2O$  or the DNA can be purified by spun-column chromatography or by extraction with phenol:chloroform followed by precipitation with ethanol in the presence of 2 M ammonium acetate. The precipitated DNA is then rinsed with 70% ethanol and resuspended in TE (pH 8.0) or  $H_2O$  at a concentration of 1–10  $\mu$ g/ml.

For the construction of libraries, where high efficiency is required and cotransformants are undesirable, total DNA concentrations of <10 ng/ml are recommended (Dower et al. 1988). For routine transformation of *E. coli* with a superhelical plasmid, 10–50 pg of DNA is adequate. When sub-cloning into a plasmid, up to 25 ng of DNA diluted from the ligation mixture can be used.

14. Set the electroporation apparatus to deliver an electrical pulse of 25  $\mu$ F capacitance, 2.5 kV, and 200 ohm resistance.
15. Pipette the DNA/cell mixture into a cold electroporation cuvette. Tap the solution to ensure that the suspension of bacteria and DNA sits at the bottom of the cuvette. Dry condensation and moisture from the outside of the cuvette. Place the cuvette in the electroporation device.
16. Deliver a pulse of electricity to the cells at the settings indicated above. A time constant of 4–5 milliseconds with a field strength of 12.5 kV/cm should register on the machine.

The presence of ions in the electroporation cuvette increases the conductivity of the solution and causes the electrical current to arc or skip through the solution of cells and DNA. Arcing is usually manifest by the generation of a popping sound in the cuvette during the electrical pulse. The uneven transfer of the charge through the cuvette drastically reduces the efficiency of transformation. Arcing increases at higher temperatures and occurs with solutions having an electrical conductance >5 mEq (e.g., 10 mM salt or 20 mM  $Mg^{2+}$  solutions). If arcing occurs in the presence of DNA but not in its absence, remove ions from the DNA preparation as described in Step 13.

17. As quickly as possible after the pulse, remove the electroporation cuvette and add 1 ml of SOC medium at room temperature.

Some investigators believe that the addition of medium at room temperature provides a heat shock that increases the efficiency of transformation.

18. Transfer the cells to a 17  $\times$  100-mm or 17  $\times$  150-mm polypropylene tube and incubate the cultures with gentle rotation for 1 hour at 37°C.

If screening by  $\alpha$ -complementation, proceed to Protocol 27 for plating.

19. Plate different volumes (up to 200  $\mu$ l per 90-mm plate) of the electroporated cells onto SOB agar medium containing 20 mM  $MgSO_4$  and the appropriate antibiotic.

When transforming with a superhelical plasmid, where transformants can be expected in abundance, a small volume of the bacterial culture can be streaked with a sterile loop onto an agar plate (or a segment of a plate) containing the appropriate antibiotics. However, if only small numbers of transformants are expected, it is best to spread 200- $\mu$ l aliquots of the bacterial suspension on each of five plates. We do not recommend plating a concentrated suspension of the bacterial culture on a single plate since the large number of dead cells resulting from electroporation may inhibit the growth of rare transformants.

20. Store the plates at room temperature until the liquid has been absorbed.
21. Invert the plates and incubate them at 37°C. Transformed colonies should appear in 12–16 hours.

Transformed colonies may be screened for the presence of recombinant plasmids using one of the methods described in Protocols 27, 28, 31, and 32 of this chapter.

# Protocol 27

---

## Screening Bacterial Colonies Using X-gal and IPTG: $\alpha$ -Complementation

**T**HIS PROTOCOL PRESENTS METHODS FOR IDENTIFYING recombinant plasmids by  $\alpha$ -complementation (for a detailed discussion of  $\alpha$ -complementation, please see the introduction to this chapter). The chromogenic substrate X-gal (please see the information panel on X-GAL) is mixed with the bacterial culture, combined with molten top agar, and then spread on selection plates. If resources are limited, the required volume of X-gal can be spread on top of an agar plate (please see the panel on **ALTERNATE PROTOCOL: DIRECT APPLICATION OF X-GAL AND IPTG TO AGAR PLATES** at the end of this protocol). The efficiency of transformation is slightly higher when the bacteria are plated in top agar rather than on the surface of agar plates. Perhaps the transformed bacteria prefer the slightly anaerobic state within the soft agar or the isosmolarity provided by the agar medium. Include the following controls:

- A strain of *E. coli* synthesizing the  $\omega$ -fragment of  $\beta$ -galactosidase. An ideal control is the parental untransformed strain from which the transformed colonies under test are derived. Colonies of the parental, untransformed strain should all be white.
- The same  $\omega$ -producing strain transformed by the empty plasmid vector, which encodes the  $\alpha$ -fragment of  $\beta$ -galactosidase. These colonies should all be blue.

Methods for performing  $\alpha$ -complementation with bacteriophage  $\lambda$  and bacteriophage M13 vectors are described in Chapters 2 and 3, respectively.

### MATERIALS

---

#### Buffers and Solutions

Please see Appendix 1 for components of stock solutions, buffers, and reagents. Dilute stock solutions to the appropriate concentrations.

*IPTG solution (20% w/v)*

*X-gal solution <math>\langle ! \rangle</math> (2% w/v)*

Please see the information panel on X-GAL.

IPTG (isopropyl- $\beta$ -D-thiogalactoside) is a nonfermentable analog of lactose that inactivates the *lacZ* repressor (Barkley and Bourgeois 1978), and therefore induces transcription of the *lac* operon. Most strains of bacteria commonly used for  $\alpha$ -complementation, however, do not synthesize significant quantities of *lac* repressor. Consequently, there is usually no need to induce synthesis of the host- and plasmid-encoded fragments of  $\beta$ -galactosidase for histochemical analysis of bacterial colonies. If the bacterial strain carries the  $I^Q$  allele of *lac* repressor and/or if the plasmid carries a *lacI* gene, IPTG should be used to induce synthesis of both fragments of the enzyme.

## Media

*LB or YT agar plates containing the appropriate antibiotic*  
*LB or YT top agar*

## Special Equipment

*Heating block preset to 45°C*  
*Wooden toothpicks or Inoculating needles*

## Vectors and Bacterial Strains

*E. coli culture, transformed with recombinant plasmids*  
 Use bacteria transformed by one of the methods described in Protocols 23 through 26 of this chapter.

## METHOD

1. Dispense aliquots of molten top agar into 17 × 100-mm tubes. Place the tubes in a 45°C heating block until they are needed.  
     Use 3-ml aliquots for 90-mm plates and 7-ml aliquots for 150-mm plates.
2. Remove the first tube from the heating block. Working quickly, add 0.1 ml of bacterial suspension containing <3000 viable bacteria for a 90-mm plate and <10,000 for a 150-mm plate. Close the top of the tube and invert it several times to disperse the bacteria through the molten agar.
3. Open the tube and add the appropriate amounts of X-gal and IPTG (if required) as shown in Table 1-10. Close the top of the tube and gently invert it several times to mix the contents.
4. Quickly pour the molten top agar into the center of a hardened agar plate containing the appropriate antibiotic and distribute the solution by swirling.
5. Repeat Steps 2–4 until all of the samples have been plated.
6. Allow the soft agar to harden at room temperature, wipe any condensation from the lid of the plates, and then incubate the plates in an inverted position for 12–16 hours at 37°C.

**TABLE 1-10 Components for Top Agar**

SIZE OF PLATE	AMOUNT OF REAGENT		
	MOLTEN TOP AGAR	X-GAL	IPTG <sup>a</sup>
90 mm	3 ml	40 $\mu$ l	7 $\mu$ l
150 mm	7 ml	100 $\mu$ l	20 $\mu$ l

<sup>a</sup>May not be required; please see the entry on IPTG in the Materials list.

7. Remove the plates from the incubator and store them for several hours at 4°C, to allow the blue color to develop.
8. Identify colonies carrying recombinant plasmids.
  - Colonies that carry wild-type plasmids contain active  $\beta$ -galactosidase. These colonies are pale blue in the center and dense blue at their periphery.
  - Colonies that carry recombinant plasmids do not contain active  $\beta$ -galactosidase. These colonies are creamy-white or eggshell blue, sometimes with a faint blue spot in the center.

Viewing the plates against a canary yellow background can enhance the eye's ability to discriminate between blue and white colonies.

9. Select and culture colonies carrying recombinant plasmids.

Blue or white colonies can develop in several different orientations in the soft agar, often resembling far off tilted galaxies. Regardless of the orientation, they are readily picked by stabbing into the thin layer of soft agar with a sterile inoculating needle or sterile toothpick and transferring the inoculum to a tube of medium containing the appropriate antibiotic.

#### **ALTERNATIVE PROTOCOL: DIRECT APPLICATION OF X-GAL AND IPTG TO AGAR PLATES**

An alternative to preparing top agar can be achieved by spreading a concentrated solution of X-gal on the surface of a premade agar plate, rather than incorporating the halogenated galactoside throughout the entire volume of the agar medium. Take care when spreading the X-gal solution. Colonies in the center of the plate may be a deeper blue due to variations in the concentration of X-gal across the plate.

#### **Method**

1. Pipette 40  $\mu$ l of 2% X-gal solution and, if necessary, 7  $\mu$ l of 20% IPTG solution onto the center of a premade 90-mm agar plate (e.g., LB or YT) containing the appropriate antibiotic. For a 15-cm diameter agar plate, transfer 100  $\mu$ l of X-gal and, if necessary, 20  $\mu$ l of IPTG to the center of the plate.
2. Use a sterile spreader (or a bent Pasteur pipette whose tip has been sealed in a flame) to spread the solutions over the entire surface of the plate. Incubate the plate at 37°C until all of the fluid has disappeared. Because of the low volatility of dimethyl formamide, this procedure can take up to 3–4 hours if the plate is freshly made.
3. Inoculate the plate with the bacteria to be tested by streaking with a bacterial loop, by arranging clones with toothpicks, or by spreading up to 100  $\mu$ l of a bacterial suspension (50,000 cells/ml) on the surface of a 90-mm agar plate or 200  $\mu$ l on a 15-cm plate.
4. After the inoculum has been absorbed, incubate the plate in an inverted position for 12–19 hours at 37°C.
5. Remove the plate from the incubator and store it at 4°C for several hours, during which the blue color develops to its full extent.
6. Identify colonies carrying recombinant plasmids.

# Protocol 28

---

## Screening Bacterial Colonies by Hybridization: Small Numbers

**T**HIS PROCEDURE IS USED TO SCREEN A SMALL NUMBER of transformed bacterial colonies (100–200) that are dispersed over several agar plates and are to be screened by hybridization to the same radiolabeled probe (Protocols 29 and 30 deal with the transfer of intermediate and large number of colonies, respectively). The colonies are consolidated (gridded) onto a master agar plate and onto a nitrocellulose or nylon filter laid on the surface of a second agar plate. After a period of growth, the colonies that have grown on the filter are lysed in situ and processed for hybridization, as described in Protocols 31 and 32. Meanwhile, the master plate is stored at 4°C until the results of the screening procedure become available.

Over the years, three types of solid supports have been used for in situ hybridization of lysed bacterial colonies: nitrocellulose filters, nylon filters, and Whatman 541 filter papers. Nylon filters are the most durable of the three and will withstand several rounds of hybridization and washing at elevated temperatures. They are therefore preferred when colonies are to be screened sequentially with a number of different probes. In side-by-side comparisons, nylon filters yield enhanced hybridization signals relative to nitrocellulose filters. However, when screening bacterial colonies, the hybridization signal is usually so strong that this difference between the two solid supports is not a significant factor. When they were first introduced, different treatments were required to fix efficiently DNA to nylon filters sold by different manufacturers. Although satisfactory results can be obtained by treating currently available nylon filters as if they were nitrocellulose, optimal performance still requires adherence to the manufacturers' instructions.

Whatman 541 filter paper, which has a high wet-strength, was first used to screen bacterial colonies by Gergen et al. (1979). It is now used chiefly to screen arrayed libraries that are stored as cultures of individual transformed colonies in separate wells of microtiter plates (Linbro Scientific). These ordered libraries are duplicated on the surface of agar medium (usually in square Petri dishes), and the resulting colonies are then transferred to Whatman 541 paper and lysed either by alkali or by a combination of alkali and heat (Maas 1983). Conditions for hybridization of the immobilized DNA are essentially identical to those established for nitrocellulose filters. Whatman 541 paper has some advantages over nitrocellulose filters: It is less expensive, more durable during hybridization, and less prone to distortion and cracking during drying. However, unless care is taken during the denaturation step (Maas 1983), the strength of the hybridization signal is significantly lower than that obtained from nitrocellulose filters. For routine screening of bacterial colonies, therefore, nitrocellulose or nylon filters remain the preferred choice as solid supports.

## MATERIALS

---

**CAUTION:** Please see Appendix 12 for appropriate handling of materials marked with <!>.

### Media

*LB or SOB agar plates containing the appropriate antibiotic*

*LB or SOB agar plates containing chloramphenicol <!>*

Optional, please see Step 5. Chloramphenicol is supplemented at 170–200 µg/ml.

### Special Equipment

*Nitrocellulose (Millipore HAWP, or equivalent) or Nylon filters*

Filters need not be detergent-free or sterile.

*Syringe (3 cc), Hypodermic needles (18 gauge), and Waterproof black drawing ink (India Ink)*

These materials are used to orient the filters on the master plates. For an alternative method, please see note to Step 6.

*Wooden toothpicks or Inoculating loops*

### Additional Reagents

*Step 8 of this protocol requires the reagents listed in Protocols 31 and 32 of this chapter.*

### Vectors and Bacterial Strains

*E. coli strain, transformed with recombinant plasmids*

Use bacteria transformed by one of the methods described in Protocols 23 through 26 of this chapter.

*E. coli strain, transformed with nonrecombinant plasmid (e.g., pUC, used as a negative control)*

## METHOD

---

1. Place a nitrocellulose or nylon filter on an agar plate (test plate) containing the selective antibiotic.

Handle the filter with gloved hands as finger oils prevent wetting of the filter and prevent DNA transfer.

2. Draw a numbered grid on a piece of graph paper (1-cm-square grid). Number the base of each agar master plate and place the plate on the grid. Draw a mark on the side of the plate at the 6 o'clock position.

This marking allows the master plate to be orientated with the grid.

3. Use sterile toothpicks or inoculating loops to transfer bacterial colonies one by one onto the filter on the test plate and then onto the master agar plate that contains the selective antibiotic but no filter. Make small streaks 2–3 mm in length (or dots) arranged according to the grid pattern under the dish. Streak each colony in an identical position on both plates.

Up to 100 colonies can be streaked onto a single 90-mm plate.

4. Finally, streak a colony containing a nonrecombinant plasmid (e.g., pUC) onto the filter and the master plate.

This negative control is necessary to show that the radiolabeled probe can discriminate between empty plasmids and recombinants. DNA fragments isolated from recombinant plasmids by restriction enzyme cleavage and agarose gel electrophoresis are often contaminated with plasmid DNA sequences, which can create problems when these fragments are used as hybridization probes for Grunstein-Hogness screening (Grunstein and Hogness 1975) of transformed bacterial colonies.



5. Invert the plates and incubate them at 37°C until the bacterial streaks have grown to a width of 0.5–1.0 mm (typically 6–16 hours).

At this stage, when the bacteria are still growing rapidly, the filter may be transferred to an agar plate containing chloramphenicol and incubated for a further 12 hours at 37°C (Hanahan and Meselson 1980, 1983). This amplification step is necessary only when the copy number of the recombinant plasmid is expected to be low (e.g., if a large segment of foreign DNA has been inserted) or when highly degenerate oligonucleotides are used as probes. Under normal circumstances, cloned DNA sequences can be detected very easily by hybridization without prior amplification of the recombinant plasmid. Amplification can only be carried out with vectors that replicate in relaxed fashion (please see introduction to this chapter).

6. Mark the filter in three or more asymmetric locations by stabbing through it and into the agar of the test plate with an 18-gauge needle, attached to a syringe, dipped in waterproof black drawing ink (India Ink). Mark the master plate in approximately the same locations.

With practice, it is possible to avoid the use of ink (which can be messy) by punching holes through the filter into the underlying agar with an empty 18-gauge needle. After hybridization, back lighting via a light box can be used to align the holes in the filter with the marks in the agar.

Many investigators prefer to orient the filter by using sharp scissors to cut small notches at various points on its circumference. After the notched and numbered filter has been placed on the surface of the agar, the positions of the serrations are marked on the bottom of the plate. The shapes of the serrations and their positions define the orientation of the filter on the plate.

7. Seal the master plate with Parafilm and store it at 4°C in an inverted position until the results of the hybridization reaction are available.
8. Lyse the bacteria adhering to the filter and bind the liberated DNA to the nitrocellulose or nylon filter using the procedures described in Protocol 31. Proceed with hybridization as described in Protocol 32.

# Protocol 29

---

## Screening Bacterial Colonies by Hybridization: Intermediate Numbers

**B**ACTERIAL COLONIES GROWING ON AGAR PLATES can be transferred en masse to nitrocellulose filters. A sterile filter is placed directly onto the bacterial colonies. After a short period of time to allow transfer of bacterial cells to the filter, the filter is gently removed and prepared for hybridization. However, if the copy number of the recombinant plasmid is expected to be low (e.g., if a large segment of foreign DNA has been inserted) or when highly degenerate oligonucleotides are used as probes, the filter may be placed (colony side up) on the surface of a fresh agar plate containing the appropriate antibiotic. After incubation for a few hours, the filter with its cargo of enlarged colonies is prepared for hybridization. Meanwhile, the original (master) plate is incubated for a few hours to allow the bacterial colonies to regrow in their original positions.

These procedures work with bacterial colonies of any size, but small colonies give the clearest results as they produce sharp hybridization signals and do not smear during transfer from the agar plate to the filter. The method works best with 90-mm plates containing up to 2500 colonies. Larger filters are difficult to place perfectly on the surface of 150-mm plates without air bubbles. For further information on filters, please refer to the introduction to Protocol 28.

### MATERIALS

---

**CAUTION:** Please see Appendix 12 for appropriate handling of materials marked with <!>.

#### Media

*LB or SOB agar plates (90-mm) containing appropriate antibiotics*

Plates that are 2–3 days old give the best results in this protocol because they absorb fluid from the bacterial inoculum more readily.

*LB or SOB plates containing chloramphenicol <!>*

Optional, please see Step 6. Chloramphenicol is used at 170–200 µg/ml.

#### Special Equipment

*Nitrocellulose (Millipore HATF, or equivalent) or Nylon filters, sterile and detergent-free Syringe (3 cc), Hypodermic needles (23 gauge), and Waterproof black drawing ink (India Ink)*

These materials are used to orient the filters on the master plates. For an alternative method, please see note to Step 4.

*Whatman 3MM circular filter papers*

Prepare in advance a stack of Whatman 3MM papers (one for each nitrocellulose or nylon, plus a few spares) cut to a size slightly larger than the filters. These are commercially available as precut circles from several manufacturers.

## Additional Reagents

Step 6 of this protocol requires the reagents listed in Protocols 31 and 32 of this chapter.

## Vectors and Bacterial Strains

*E. coli* strain, transformed with recombinant plasmids, as culture

Use bacteria transformed by one of the methods described in Protocols 23 through 26 of this chapter.

## METHOD

---

1. Plate out the transformed *E. coli* culture onto 90-mm LB or SOB agar plates, at dilutions calculated to generate up to 2500 transformed colonies. When the colonies reach an average size of 1.5 mm, transfer the plates from the incubator to a cold room.
2. Number the dry filters with a soft-lead pencil or a ball-point pen, wet them with water, and interleave them between dry Whatman 3MM filters. Wrap the stack of filters loosely in aluminum foil, and sterilize them by autoclaving (15 psi [1.05 kg/cm<sup>2</sup>] for 10 minutes on liquid cycle).

Prepare enough filters to make one or two replicas from the starting agar plates. Although sterile filters are preferred for this procedure, nonsterile filters may be used if no more replicas are to be made from the master plate.
3. Place a dry, sterile detergent-free nitrocellulose filter, numbered side down, on the surface of the LB (or SOB) agar medium, in contact with the bacterial colonies (plated in Step 1), until it is completely wet.

Take care to prevent air bubbles from becoming trapped between the filter and the agar. This is best done by bending the filter slightly so that contact is first made between the center of the filter and the agar medium. Be careful not to move the filter relative to the agar medium after contact has been made.
4. Once the filter is in place, key the filter to the underlying medium by stabbing in three or more asymmetric locations through the filter with a 23-gauge needle attached to a syringe, dipped in waterproof black drawing ink.

A 23-gauge needle or smaller dipped in ink works best (dip once per plate, three holes per plate).  
With practice, it is possible to avoid the use of ink (which can be messy) by punching holes through the filter into the underlying agar with an empty 18-gauge needle. After hybridization, back lighting via a light box can be used to align the holes in the filter with the marks in the agar.  
Many investigators prefer to orient the filter by using sharp scissors to cut small notches at various points on its circumference. After the notched and numbered filter has been placed on the surface of the agar, the positions of the serrations are marked on the bottom of the plate. The shapes of the serrations and their positions define the orientation of the filter on the plate.
5. Grip the edge of the filter with blunt-ended forceps and, in a single smooth movement, peel the filter from the surface of the agar.

Usually, the colonies are transferred in their entirety from the agar to the filter leaving behind small indentations in the surface of the medium. When the master plate is incubated at 37°C, the remaining bacteria grow to fill the indentations but do not expand further.
6. Proceed with one of the following options as appropriate:
  - Lyse the bacteria adhering to the filter and bind the liberated DNA to the nitrocellulose or nylon filter using the procedures described in Protocol 31. Proceed with hybridization as described in Protocol 32.
  - Lyse the bacteria and immobilize the DNA as described in the alternative protocol at the end of this protocol.

- Place the filter, colony side up, on the surface of a fresh LB (or SOB) agar plate containing the appropriate antibiotic. After incubation for a few hours, when the colonies have grown to a size of 2–3 mm, remove the filter and proceed with lysis and hybridization as described in Protocols 31 and 32.

This option should be taken only when the transfer of the colonies to the filter is poor or uneven, which is not usually the case.

- Amplify the colonies on the filter by transferring the filter to an agar plate containing chloramphenicol (170–200 µg/ml) and incubating for 12 hours at 37°C. Proceed with lysis and hybridization (Protocols 31 and 32).

This amplification step (Hanahan and Meselson 1980, 1983) is necessary only when the copy number of the recombinant plasmid is expected to be low (e.g., if a large segment of foreign DNA has been inserted) or when highly degenerate oligonucleotides are used as probes. Under normal circumstances, cloned DNA sequences can be detected very easily by hybridization without prior amplification of the recombinant plasmid. Amplification can only be carried out with vectors that replicate in relaxed fashion (please see introduction to this chapter).

- Use the filter to prepare a second replica:

- a. Place the filter colony side up on the surface of a fresh LB (or SOB) agar plate containing the appropriate antibiotic.
- b. Lay a dry nitrocellulose filter carefully on top of the first and key to it as described in Step 4 above.
- c. Incubate the “filter sandwich” for several hours at 37°C.

The plasmids are amplified, if desired, by further incubation on an agar plate containing chloramphenicol.

- d. Proceed with lysis and hybridization (Protocols 31 and 32), keeping the filters as a sandwich during the lysis and neutralization steps, but peeling them apart before the final wash (Ish-Horowitz and Burke 1981).

7. Incubate the master plate for 5–7 hours at 37°C until the colonies have regrown (please see note to Step 5). Seal the plate with Parafilm, and store it at 4°C in an inverted position.

#### **ALTERNATIVE PROTOCOL: RAPID LYSIS OF COLONIES AND BINDING OF DNA TO NYLON FILTERS**

The following procedure, based on a protocol developed by Gary Struhl in 1983 while he was a post-doc in Tom Maniatis' laboratory, eliminates treatment of nylon filters with alkali and can save time when dealing with large numbers of filters. Note that nitrocellulose filters may only be used in this procedure if they have been autoclaved prior to colony transfer.

##### **Method**

1. After removing the filters from the top agarose (Step 5), place them, DNA side up, on paper towels for 5–10 minutes.
2. When their edges begin to curl, place the filters in stacks of ten interleaved with circular Whatman 3MM papers. Place a few 3MM papers on the top and bottom of the stack.
3. Place the stacks on a small platform (e.g., an inverted Pyrex dish) in an autoclave. Expose the filters to “streaming steam” for 3 minutes (i.e., 100°C; avoid super-heated steam).
4. Transfer the stack of filter papers and nitrocellulose filters to a vacuum oven. Bake for 2 hours at 80°C while drawing a vacuum continuously. Remove any 3MM paper that sticks to the nitrocellulose filters by soaking in 2x SSPE before prehybridizing.

# Protocol 30

---

## Screening Bacterial Colonies by Hybridization: Large Numbers

**T**HIS METHOD IS USED TO PLATE AND SUBSEQUENTLY REPLICATE large numbers of colonies onto nitrocellulose or nylon filters. The procedure is derived from Hanahan and Meselson (1980, 1983) and is chiefly used when plating out bacteria transformed by a plasmid cDNA library. The bacteria are plated directly from a transformation mixture or an amplified aliquot of the cDNA library onto detergent-free nitrocellulose filters, and replica filters are prepared by filter-to-filter contact. Using this technique, as many as  $2 \times 10^4$  colonies per 150-mm plate or  $10^4$  colonies per 90-mm plate can be replicated and subsequently screened by hybridization. For further information on filters, please refer to the introduction to Protocol 28.

### MATERIALS

---

**CAUTION:** Please see Appendix 12 for appropriate handling of materials marked with <!>.

#### Media

*LB or SOB agar plates containing appropriate antibiotics*

Plates that are 2–3 days old give the best results in this protocol because they absorb fluid from the bacterial inoculum more readily.

*LB or SOB agar plates containing appropriate antibiotics and 25% (v/v) glycerol*

*LB or SOB plates containing chloramphenicol <!>*

Optional, please see Step 12. Chloramphenicol is supplemented at 170–200 µg/ml.

#### Special Equipment

*Blunt-ended forceps (e.g., Millipore forceps)*

*Hypodermic needles (18 gauge)*

*Nitrocellulose (Millipore HATF, or equivalent) or Nylon filters, sterile and detergent-free*

*Syringe barrel (3 cc)*

*Whatman 3MM circular filter papers*

Prepare a stack of Whatman 3MM papers in advance (one for each nitrocellulose or nylon filter, plus a few spares) cut to a size slightly larger than the filters. These are commercially available as pre-cut circles from several manufacturers. Wrap the stack of Whatman 3MM papers in aluminum foil and sterilize them by autoclaving for 10 minutes at 15 psi (1.05 kg/cm<sup>2</sup>) on liquid cycle.

## Additional Reagents

Step 14 of this protocol requires the reagents listed in Protocols 31 and 32 of this chapter.

## Vectors and Bacterial Strains

*E. coli* strain, transformed with recombinant plasmids, as culture

Use bacteria transformed by one of the methods described in Protocols 23 through 26 of this chapter.

or

Amplified aliquot of cDNA library, grown as culture

Please see Chapter 11, Protocol 1.

## METHOD

---

### Plating Out the Transformation Mix

1. Number the dry filters with a soft-lead pencil or a ball-point pen, wet them with water, and interleave them between dry Whatman 3MM filters. Wrap the stack of filters loosely in aluminum foil, and sterilize them by autoclaving (15 psi [1.05 kg/cm<sup>2</sup>] for 10 minutes on liquid cycle).

Prepare enough filters to make one or two replicas from the starting agar plates. Although sterile filters are preferred for this procedure, nonsterile filters may be used if no more replicas are to be made from the master plate.

2. Use sterile, blunt-ended forceps to lay a sterile filter, numbered side down, on a 2–3-day-old LB (or SOB) agar plate containing the appropriate antibiotic. When the filter is thoroughly wet, peel it from the plate and replace it, numbered side up, on the surface of the agar.
3. Apply the bacteria, in a small volume of liquid, to the center of the filter on the surface of the agar plate. Use a sterile glass spreader to disperse the fluid evenly, leaving a border 2–3 mm wide around the circumference of the filter free of bacteria.

A large filter (137-mm diameter) will accommodate up to 0.5 ml of liquid containing  $2 \times 10^4$  viable bacteria. A small filter (82-mm diameter) will accommodate up to 0.2 ml of liquid containing a  $\sim 10^4$  bacteria.

4. Incubate the plate (noninverted) with the lid ajar for a few minutes in a laminar flow hood to allow the inoculum to evaporate. Then close the lid, invert the plate, and incubate at 37°C until small colonies (0.1–0.2-mm diameter) appear (~8–10 hours).
5. If desired, replica filters may be prepared at this stage (proceed with Step 6). Otherwise, prepare the bacterial colonies for storage at –20°C:

- a. Transfer the filter colony side up to a labeled LB (or SOB) agar plate containing the appropriate antibiotic and 25% glycerol.
- b. Incubate the plate for 2 hours at 37°C.

When working with a cDNA library, it is best to freeze the master plate. Freezing decreases the possibility of contamination with molds and fungi and preserves the master plate for many months. Alternatively, the master filters can be stored for up to 2 weeks at 4°C on LB or SOB plates containing antibiotic and no glycerol.

- c. Seal the plate well with Parafilm, and store it in an inverted position in a sealed plastic bag at –20°C.

Replicas can be made after thawing the master plate at room temperature (still in the inverted position).

## Making the Replica Filters

6. Lay the master nitrocellulose or nylon filter colony side up on a sterile Whatman 3MM paper.
7. Number a damp, sterile nitrocellulose or nylon filter, and lay it on the master filter. Take care to prevent air bubbles from becoming trapped between the two filters.

This is best done by bending the second filter slightly so that contact is first made between the centers of the filters. Be careful not to move the filters relative to one another once contact has been made. Try to arrange the filters so that they do not overlap exactly; this makes it easier to separate the two filters later on.
8. Cover the filter sandwich with a second 3MM circle and place the bottom of a Petri dish on top of the 3MM paper. Press down firmly on the Petri dish with the palm of the hand to facilitate transfer of bacteria from the master filter to the replica.
9. Dismantle the Petri dish bottom and top 3MM paper, and orient the two filters by making a series of holes with an 18-gauge needle attached to a syringe.

Make sure the needle punctures both filters!
10. Peel the filters apart. Lay the replica on a fresh LB (or SOB) agar plate containing the appropriate antibiotic.

A second replica can be made from the master filter at this point by repeating Steps 6 through 9. Key the second replica to the existing holes in the master filter.
11. Place the second replica filter (if made) and the master filter on a fresh LB (or SOB) agar plate containing the appropriate antibiotic and incubate all plates at 37°C until colonies appear (4–6 hours).
12. At this stage, when the bacteria are still growing rapidly, the filter may be transferred to an agar plate containing chloramphenicol (170–200 µg/ml) and incubated for 12 hours at 37°C.
13. Move the master nitrocellulose filter to a fresh LB (or SOB) agar plate containing the appropriate antibiotic and 25% glycerol. Then freeze it as described in Step 5.
14. Lyse the bacteria adhering to the replica filters and bind the liberated DNA to the nitrocellulose or nylon filter using the procedures described in Protocol 31. Proceed with hybridization as described in Protocol 32.

# Protocol 31

---

## Lysing Colonies and Binding of DNA to Filters

**T**HIS PROTOCOL DESCRIBES THE LIBERATION OF DNA from bacterial colonies transformed with recombinant plasmids, and the subsequent fixing of the nucleic acid to the nitrocellulose or nylon filters in situ. The method is based on the original procedure of Grunstein and Hogness (1975). The hybridization of radiolabeled probes to nucleic acids immobilized on filters is presented in Protocol 32.

Both baking and cross-linking serve to fix the bacterial DNA to the nylon or nitrocellulose filters. The choice between the two methods depends on the equipment at hand and the way in which the filters will be used. If the filters are to be hybridized with several different probes and stripped between probing reactions, then it is better to cross-link the DNA to the filters with UV light. For single hybridization reactions, we have not been able to discern a difference between the two fixation methods regarding the efficiencies with which DNA is fixed to the filter, the amount of nonspecific background hybridization, or the intensity or crispness of the autoradiographic signal from a positive colony. Cross-linking is faster than baking, requiring 20–30 seconds per filter, compared to a 1–2-hour bake. However, cross-linking is usually carried out in a machine that is adjusted to deliver a set amount of energy to each filter. These UV light cross-linkers are expensive and generally have a life of ~1 year in an active laboratory. Vacuum baking ovens cost about the same amount but last 10 years or more in very active departments.

### MATERIALS

---

**CAUTION:** Please see Appendix 12 for appropriate handling of materials marked with <!.>.

#### Buffers and Solutions

Please see Appendix 1 for components of stock solutions, buffers, and reagents. Dilute stock solutions to the appropriate concentrations.

*Denaturing solution*

*Neutralizing solution*

*SDS (10% w/v)*

Optional, please see Steps 1 and 3.

*2x SSPE*

#### Special Equipment

*Glass or plastic trays for processing filters*

Cafeteria trays are ideal for this purpose, as they can accommodate batches of up to 25 filters of 9–10-cm diameter.



Microwave oven, Vacuum baking oven, preset to 80°C, or UV light <!--> cross-linking device

Please see Source book for a list of manufacturers of cross-linking devices.

Whatman 3MM paper

## Vectors and Bacterial Strains

Filters carrying colonies of *E. coli* transformants

Use transformants prepared by one of the methods described in Protocols 28 through 30 of this chapter.

## METHOD

---

1. Cut four pieces of Whatman 3MM paper (or an equivalent) to an appropriate size and shape and fit them neatly onto the bottoms of four glass or plastic trays. Saturate each of the pieces of 3MM paper with one of the following solutions:
  - 10% SDS (optional)  
denaturing solution
  - neutralizing solution
  - 2x SSPE
2. Pour off any excess liquid and roll a 10-ml pipette along the sheet to smooth out any air bubbles that occur between the 3MM paper and the bottom of the container.
  - If the 3MM paper is too wet, the bacterial colonies swell and diffuse during lysis. The hybridization signals then become blurred and attenuated, and it is very difficult to identify individual colonies that give rise to the signal.
3. Use blunt-ended forceps to peel the nitrocellulose or nylon filters from their plates and place them colony side up on the SDS-impregnated 3MM paper for 3 minutes.
  - This treatment limits the diffusion of the plasmid DNA during subsequent denaturation and neutralization and results in a sharper hybridization signal.
4. After the first filter has been exposed to the SDS solution for 3 minutes, transfer it to the second sheet of 3MM paper saturated with denaturing solution. Transfer the remainder of the filters in the same order in which they were removed from their agar plates. Expose each filter to the denaturing solution for 5 minutes.
  - When transferring filters from one tray to another, use the edge of the first tray as a scraper to remove as much fluid as possible from the underside of the filter. Alternatively, remove excess liquid by transferring the filter briefly to a dry paper towel. Try to avoid getting fluid on the side of the filter carrying the bacterial colonies.
5. Transfer the filters to the third sheet of 3MM paper, which has been saturated with neutralizing solution. Leave the filters for 5 minutes.
  - Optional:* Repeat this step once.
6. Transfer the filters to the last sheet of 3MM paper, which has been saturated with 2x SSPE. Leave the filters for 5 minutes.
  - We prefer to fill a tray or tub (such as that used in washing filters after hybridization) with a volume of 2x SSPE and then to float the filters from Step 5 on the surface of this solution for several minutes. Thereafter, the container is agitated to sink the filter below the surface of the solution and left until the last filter to be worked up is similarly treated. This step accomplishes two goals: rinsing the filter of neutralization solution and inundating the filter with EDTA to chelate divalent cations such as Mg<sup>2+</sup> and thereby to inhibit the action of any residual nucleases that degrade DNA.

7. Dry the filters using one of the methods below.

*If the DNA is to be fixed to the filters by baking:* Lay the filters, colony side up, on a sheet of dry 3MM paper and allow them to dry at room temperature for at least 30 minutes.

*If the DNA is to be fixed to the filters by cross-linking with UV light:* Lay the filters on a sheet of 2x SSPE-impregnated 3MM paper or on dry paper, depending on the manufacturer's recommendation.

8. Fix the DNA to the filters using one of the methods below.

*For baking:* Sandwich the filters between two sheets of dry 3MM paper, and fix the DNA to the filters by baking for 1–2 hours at 80°C in a vacuum oven.

Overbaking can cause the filters to become brittle. Nitrocellulose filters that have not been completely neutralized turn yellow or brown during baking and chip very easily. The background of nonspecific hybridization also increases dramatically in this situation.

*For cross-linking with UV light:* Follow the manufacturer's instructions for fixing DNA to filters using a commercial device for this purpose.

9. Hybridize the DNA immobilized on the filters to a labeled probe as described in Protocol 32.

Any filters not used immediately in hybridization reactions should be interleaved between 3MM filters and stored covered in aluminum foil at room temperature.

# Protocol 32

---

## Hybridization of Bacterial DNA on Filters

**T**HIS PROTOCOL PROVIDES PROCEDURES TO HYBRIDIZE DNA from transformed colonies immobilized onto filters with radiolabeled probes and to recover from a master plate the corresponding colonies that hybridize specifically to the probe. These techniques are designed to be used with probes that are on average longer than 100 nucleotides in length. Methods for screening bacterial colonies with shorter radiolabeled oligonucleotides are given in Chapter 10.

The purity of a radiolabeled DNA or RNA probe is important when screening plasmid-containing bacterial colonies. Cloned DNA fragments excised from plasmids are commonly used to prepare the hybridization probe. However, even a small amount of contamination by vector sequences will generate probes that hybridize to bacterial colonies transformed by any plasmid used in molecular cloning. This lack of specificity can also occur when using probes prepared from bacteriophages to screen plasmids (or vice versa), since many vectors contain fragments of the *lacZ* gene. To ensure that a DNA fragment that will be used to prepare a hybridization probe does not contain vector sequences, we recommend purifying the DNA through two gels (agarose or polyacrylamide) as described in Chapter 5, before carrying out the radiolabeling reaction.

The following protocol is designed for 30 circular nitrocellulose filters, 82 mm in diameter. Appropriate adjustments to the volumes should be made when carrying out hybridization reactions with different numbers or sizes of filters.

---

### MATERIALS

**CAUTION:** Please see Appendix 12 for appropriate handling of materials marked with <!.>.

#### Buffers and Solutions

Please see Appendix 1 for components of stock solutions, buffers, and reagents. Dilute stock solutions to the appropriate concentrations.

*Formamide <!.>*

Optional, please see the panel on **PREHYBRIDIZATION AND HYBRIDIZATION SOLUTIONS** following Step 5. Many batches of reagent-grade formamide are sufficiently pure to be used without further treatment. However, if any yellow color is present, the formamide should be deionized (please see Appendix 1).

*Prehybridization/hybridization solution*

Please see the panel on **PREHYBRIDIZATION AND HYBRIDIZATION SOLUTIONS** following Step 5.

**1x BLOTTO <!>**

1x BLOTTO (Bovine Lacto Transfer Technique Optimizer [Johnson et al. 1984]) is as effective a blocking agent as Denhardt's reagent, but much less expensive.

BLOTTO should not be used in combination with high concentrations of SDS, which will cause the milk proteins to precipitate. If background hybridization is a problem, NP-40 may be added to the hybridization solution to a final concentration of 1%. BLOTTO should not be used as a blocking reagent when radiolabeled RNA is used as the hybridization probe, because of the possibility that the dried milk may contain significant amounts of RNase activity. In this situation, 5x Denhardt's solution (please see Appendix 1) should be substituted for BLOTTO.

**Prewashing solution**

6x SSC or 6x SSPE

**Wash solution 1**

2x SSC

0.1% (w/v) SDS

**Wash solution 2**

1x SSC

0.1% (w/v) SDS

**Wash solution 3**

0.1x SSC

0.1% (w/v) SDS

**Media**

*LB, YT, or Terrific Broth containing the appropriate antibiotic*

**Nucleic Acids and Oligonucleotides****Filters with immobilized DNA from transformed colonies**

Use filters prepared as described in Protocol 31.

**Probes****<sup>32</sup>P-labeled double-stranded DNA probe or Synthetic oligonucleotide probes**

Prepare the probes as described in Chapter 9 (for double-stranded DNA probe) or Chapter 10 (for oligonucleotide probes). For a further discussion of probes for colony screening, please see the protocol introduction. Between  $2 \times 10^5$  and  $1 \times 10^6$  cpm of <sup>32</sup>P-labeled probe (specific activity  $\sim 5 \times 10^7$  cpm/ $\mu$ g) should be used per milliliter of prehybridization solution. When <sup>32</sup>P-labeled cDNA or RNA is used as a probe, poly(A) at a concentration of 1  $\mu$ g/ml should be included in the prehybridization and hybridization solutions to prevent the probe from binding to T-rich sequences that are common in eukaryotic DNA.

**Special Equipment****Boiling water bath**

*Glass baking dish (15 x 7.5 x 5 cm) or other hybridization chamber*

*Incubators preset to 42°C (if prehybridizing in formamide), 50°C, and 68°C*

**ALTERNATIVE HYBRIDIZATION CHAMBERS**

Some investigators prefer to incubate filters in heat-sealable plastic bags (Sears Seal-A-Meal or equivalent) during the prehybridization and hybridization steps, rather than in crystallization dishes. The former method avoids problems with evaporation and, because the sealed bags can be submerged in a water bath, ensures that the temperatures during hybridization and washing are correct. The bags must be opened and resealed when changing buffers. To avoid radioactive contamination of the water bath, the resealed bag containing radioactivity should be sealed inside a second, noncontaminated bag.

If only a small number of filters are subjected to hybridization, then a glass screw-top bottle that fits the rollers of a hybridization oven can be used in place of a crystallization dish or Seal-A-Meal bag. These bottles and ovens have the advantage that small volumes of hybridization solution can be used and the hybridization temperature can be accurately controlled. For further details, please see the panel on **HYBRIDIZATION CHAMBERS** in Chapter 6, Protocol 10.

*Radioactive ink* <1>

Reusable alternatives to radioactive ink are chemiluminescent markers available from Stratagene (Glogos). The markers can be used multiple times and should be exposed to fluorescent light just prior to a new round of autoradiography.

*Water-soluble glue stick*

For example, UHU Stic, distributed by FaberCastell.

*Whatman 3MM paper or equivalent*

*Wooden toothpicks or Inoculating needle*

## Additional Reagents

Step 15 of this protocol requires the reagents listed in Protocol 1 or 4 of this chapter.

Step 15 may also require the reagents listed in Chapter 8, Protocol 12.

## METHOD

---

### Prewashing and Prehybridization of the Filters

1. Float the baked or cross-linked filters on the surface of a tray of 2x SSC until they have become thoroughly wetted from beneath. Submerge the filters for 5 minutes.

Because some batches of nitrocellulose filters swell and distort during hybridization and subsequent drying, it becomes difficult to align the orientation dots on the autoradiograph and filter or agar plate. This problem can be alleviated to some extent by autoclaving the dry filters between pieces of damp 3MM paper before use (10 psi [0.70 kg/cm<sup>2</sup>] for 10 minutes on liquid cycle). Nylon filters do not suffer from this problem.

2. Transfer the filters to a glass baking dish containing at least 200 ml of prewashing solution. Stack the filters on top of one another in the solution. Cover the dish with Saran Wrap and transfer it to a rotating platform in an incubator. Incubate the filters for 30 minutes at 50°C.

This prewashing step removes bacterial colony debris and can substantially reduce background hybridization, especially when screening colonies at high density.

In this and all subsequent steps, the filters should be slowly agitated to prevent them from sticking to one another. Do not allow the filters to dry at any stage during the prewashing, prehybridization, or hybridization steps.

3. Gently scrape the bacterial debris from the surfaces of the filters using Kimwipes soaked in prewashing solution. This scraping ensures removal of colony debris and does not affect the intensity or sharpness of positive hybridization signals.
4. Transfer the filters to 150 ml of prehybridization solution in a glass baking dish. Incubate the filters with agitation for 1–2 hours or more at the appropriate temperature (i.e., 68°C when hybridization is to be carried out in aqueous solution; 42°C when hybridization is to be carried out in 50% formamide; please see panel below).

The filters should be completely covered by the prehybridization solution (please see the panel on **ALTERNATIVE HYBRIDIZATION CHAMBERS**). During prehybridization, sites on the nitrocellulose filter that nonspecifically bind single- or double-stranded DNA become blocked by proteins in the BLOTTO. Agitation ensures that the filters are continuously bathed in and evenly coated by the prehybridization fluid.

### Denaturation of the Probe and Performance of Hybridization

5. Denature <sup>32</sup>P-labeled double-stranded DNA by heating to 100°C for 5 minutes. Chill the probe rapidly in ice water.

Alternatively, the probe may be denatured by adding 0.1 volume of 3 N NaOH. After 5 minutes at

**PREHYBRIDIZATION AND HYBRIDIZATION SOLUTIONS**

Whether or not to use a prehybridization solution containing formamide is largely a matter of personal preference. Both versions of these solutions give excellent results and neither has clear-cut advantages over the other. However, hybridization in 50% formamide at 42°C is less harsh on nitrocellulose filters than is hybridization at 68°C in aqueous solution. Offsetting this advantage is the two- to threefold slower rate of hybridization in solutions containing formamide. Nylon filters are impervious to the deleterious effects of aqueous hybridization at high temperatures.

To maximize the rate of annealing of the probe with its target, hybridizations are usually carried out in solutions of high ionic strength (6x SSC or 6x SSPE) at a temperature that is 20–25°C below  $T_m$  (please see the information panel on **MELTING TEMPERATURES** in Chapter 10). Both solutions work equally well when hybridization is carried out in aqueous solvents. However, when formamide is included in the hybridization buffer, 6x SSPE is preferred because of its greater buffering power.

room temperature, transfer the probe to ice water and add 0.05 volume of 1 M Tris-Cl (pH 7.2) and 0.1 volume of 3 N HCl. Store the probe in ice water until it is needed.

Single-stranded probes need not be denatured.

6. Add the probe to the prehybridization solution covering the filters. Incubate at the appropriate temperature until  $1-3 C_0t_{1/2}$  is achieved. During the hybridization, keep the containers holding the filters tightly closed to prevent the loss of fluid by evaporation.
  - Use between  $2 \times 10^5$  and  $1 \times 10^6$  cpm of  $^{32}\text{P}$ -labeled probe (specific activity  $\sim 5 \times 10^7$  cpm/ $\mu\text{g}$ ) per milliliter of prehybridization solution. Using more probe will cause the background of nonspecific hybridization to increase, whereas using less will reduce the rate of hybridization.
  - If oligonucleotide probes are used, then please see Chapter 10, Protocol 8, for oligonucleotide hybridization and washing conditions.
  - Hybridization mixtures containing radiolabeled single-stranded probes may be stored at 4°C for several days and reused without further treatment. In some cases, hybridization probes prepared from double-stranded DNA templates can be reused after freezing the solution, thawing, and boiling for 5 minutes in a chemical fume hood.
7. When the hybridization is complete, remove the hybridization solution and immediately immerse the filters in a large volume (300–500 ml) of Wash solution 1 at room temperature. Agitate the filters gently and turn them over at least once during washing. After 5 minutes, transfer the filters to a fresh batch of wash solution and continue to agitate them gently. Repeat the washing procedure twice more.
  - At no stage during the washing procedure should the filters be allowed to dry.
8. Wash the filters twice for 0.5–1.5 hours in 300–500 ml of Wash solution 2 at 68°C.
  - At this point, the background is usually low enough to put the filters on film. If the background is still high or if the experiment demands washing at high stringencies, immerse the filters for 60 minutes in 300–500 ml of Wash solution 3 at 68°C.
9. Dry the filters in the air at room temperature on 3MM paper. Streak the underside of the filters with a water-soluble glue stick and arrange the filters (numbered side up) on a clean, dry, flat sheet of 3MM paper. Press the filters firmly against the 3MM paper to ensure sticking.
10. Apply adhesive dot labels marked with either radioactive ink or chemiluminescent markers to several asymmetric locations on the 3MM paper. Cover the filters and labels with Saran Wrap. Use tape to secure the wrap to the back of the 3MM paper and stretch the wrap over the paper to remove wrinkles.
  - These markers serve to align the autoradiograph with the filters!<sup>†</sup>

## Analysis of Hybridization Signal and Identification of Positive Colonies

11. Analyze the filters by phosphorimaging or exposing them to X-ray film (Kodak XAR-2, XAR-5, or their equivalents) for 12–16 hours at  $-70^{\circ}\text{C}$  with an intensifying screen.

The optimum exposure must be empirically determined and will depend on the size of the colony, the copy number of the plasmid vector, the specific activity of the probe, and the type of filter used.
12. Develop the film and align it with the filters using the marks left by the radioactive ink. Use a nonradioactive fiber-tip pen in a nonblack color to mark the film with the positions of the asymmetrically located dots on the numbered filters.
13. Tape a piece of clear Mylar or other firm transparent sheet to the film. Mark on the clear sheet the positions of positive hybridization signals. Also mark (in a different color) the positions of the asymmetrically located dots. Remove the clear sheet from the film. Identify the positive colonies by aligning the dots on the clear sheet with those on the agar plate.

Alternatively, place the film on a light box and align the agar plate containing the master colonies or filter with the stab marks in the agar/master filter. Identify positive colonies by aligning the hybridization signals with colonies on the master plate.

When screening colonies at high density, it is sometimes easiest to remove the master filter from the agar plate and to place it directly on the autoradiograph. Line up the filter with the film via the needle/pen marks.

Filters glued to 3MM paper are readily removed in preparation for stripping (please see Chapter 6, Protocol 10) by placing the 3MM paper with attached filters in a tub of  $2\times$  SSC. The water-soluble glue dissolves readily in this solution, releasing the filters for transfer to a stripping solution.
14. Use a sterile toothpick or inoculating needle to transfer each positive bacterial colony into 1–2 ml of rich medium (e.g., LB, YT, or Terrific Broth) containing the appropriate antibiotic.

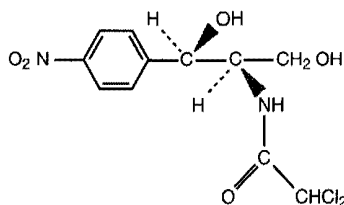
Often, the alignment of the filters with the plate does not permit identification of an individual hybridizing colony. In this case, several adjacent colonies should be pooled. The culture is grown for several hours, diluted, and replated on agar plates so as to obtain  $\sim 500$  colonies per plate. These colonies are then screened a second time by hybridization. A single, well-isolated, positive colony should be picked from the secondary screen and used for further analysis.
15. After a period of growth, plasmid DNA can be isolated from the culture by one of the miniprep methods described in Protocols 1 and 4 and can be further analyzed by restriction endonuclease digestion or by PCR (please see Chapter 8, Protocol 12).

## CHLORAMPHENICOL

Chloramphenicol inhibits protein synthesis and blocks host DNA synthesis but has no effect on replication of relaxed plasmids. The copy number of relaxed plasmids therefore increases during incubation of the bacterial culture in the drug. Amplification is necessary to achieve high yields of relaxed plasmids, which normally replicate to only moderate numbers in their host bacteria. Plasmids of a later generation (e.g., pUC plasmids) carry a modified *colE1* replicon and replicate to such high copy numbers that amplification is unnecessary. These high-copy-number plasmids can be purified in large yield from bacterial cultures that are allowed to grow to saturation in the absence of chloramphenicol. However, treatment with chloramphenicol still has some advantages even for these plasmids. Because it blocks bacterial replication, the bulk and viscosity of the bacterial lysate are reduced, which greatly simplifies purification of the plasmid. In general, the benefits of chloramphenicol treatment outweigh the small inconvenience involved in adding the drug to the growing bacterial culture.

### Properties and Mode of Action of Chloramphenicol

- Chloramphenicol inhibits bacterial protein synthesis by decreasing the catalytic rate constant of peptidyl transferase, located on 70S ribosomes (Drainas et al. 1987).
- Chloramphenicol was first isolated from a soil actinomycete in 1947 (Ehrlich et al. 1947), and by 1950, it was available in a synthetic form that became widely used as a broad-spectrum antibiotic (please see Figure 1-13). However, its clinical use has since been curtailed because of drug-induced bone-marrow toxicity and because resistance to chloramphenicol develops readily in bacteria (for review, please see Shaw 1983).
- Because chloramphenicol inhibits bacterial protein synthesis, it prevents replication of the bacterial chromosome. However, replication of many "relaxed" plasmids, including virtually all vectors carrying the wild-type *pMB1* (or *colE1*) replicon, continues in the presence of the drug until 2000 or 3000 copies have accumulated in the cell (Clewell 1972).
- Until the early 1980s, chloramphenicol was used routinely to obtain decent yields of plasmids containing the wild-type *colE1* replicon from large-scale cultures. Most high-copy-number plasmid vectors constructed after 1982 carry mutations that prevent or destabilize the interactions between *RNAI* and *RNII* and thereby release plasmid DNA from copy-number control. Because vectors containing these mutated versions of the *colE1* origin are maintained at several hundred copies per cell, high yields of plasmid DNA can be obtained without inhibiting bacterial protein synthesis. Nevertheless, treating bacterial cultures with chloramphenicol still has some advantages: The copy number of the plasmids increases a further two- to threefold in the presence of the drug, and more significantly, the bulk and viscosity of the bacterial lysate are greatly reduced because host replication is inhibited. Many investigators find that adding chloramphenicol to the growing culture is far more convenient than dealing with a highly viscous lysate.
- For many years, it was thought that amplification of plasmids in the presence of chloramphenicol was effective only when the host bacteria were grown in minimal medium. However, a protocol that uses rich medium and chloramphenicol gives reproducibly high yields ( $\geq 1$  mg of plasmid DNA per 500 ml of cul-



**FIGURE 1-13 Structure of Chloramphenicol**

Chemical bonds depicted by filled arrows appear above the plane of the figure; bonds represented by dashed lines appear below the plane of the figure.



ture) with strains of *E. coli* harboring low-copy-number plasmids carrying the pMB1 or colE1 replicon (e.g., please see Protocol 3).

- Improved yields of pBR322 and its derivatives have been obtained from bacterial cultures treated with low concentrations of chloramphenicol (10–20 µg/ml) that do not completely suppress host protein synthesis (Frenkel and Bremer 1986). The reason for this result is not understood, but it could be explained if the replication of plasmids carrying the colE1 origin required an unstable host factor that continues to be synthesized during partial inhibition of protein synthesis.

### Mechanism of Resistance to Chloramphenicol

- Naturally occurring resistance to chloramphenicol in bacteria is due to the activity of the enzyme chloramphenicol acetyltransferase (encoded by the *cat* gene), which catalyzes the transfer of an acetyl group from acetyl coenzyme A (CoA) to the C3-hydroxyl group of the antibiotic. The product of the reaction, 3-acetoxychloramphenicol, neither binds to the peptidyl transferase center of 70S ribosomes nor inhibits peptidyl transferase.
- In field strains of Enterobacteriaceae and other Gram-negative bacteria, the *cat* gene is constitutively expressed and is usually carried on plasmids that confer multiple drug resistance.
- Several variants of the *cat* gene product have been described, all of which form trimers consisting of identical subunits of  $M_r \sim 25,000$ . The type I variant, which is encoded by a 1102-bp segment of transposon Tn9, is in wide use as a reporter gene. However, most kinetic and structural analyses have been carried out with the type III variant, which yields crystals suitable for X-ray analysis. The active site, which is located at the subunit interface, contains a histidine residue, which is postulated to act as a general base catalyst in the acetylation reaction (Leslie et al. 1988; Shaw et al. 1988). The two substrates (chloramphenicol and acetyl-CoA) approach the active site through tunnels located on opposite sides of the molecule.

## KANAMYCINS

### Properties and Mode of Action of Kanamycins

The kanamycins, which are members of the aminoglycoside family of antibiotics, were first isolated in 1957 at the Japanese National Institutes of Health from cultures of *Streptomyces kanamyceticus* (Umezawa et al. 1967), which synthesizes three forms of the antibiotic: kanamycins A, B, and C. Kanamycin A, the major component, has a broad spectrum of activity against many species of bacteria and for several years was an important antibiotic for the treatment of serious infections caused by Gram-negative bacilli. Its stereochemistry and absolute configuration were derived initially by chemical methods and nuclear magnetic resonance (NMR) and were later confirmed by X-ray crystallography (for review, please see Hooper 1982).

The aminoglycoside antibiotics are polycations that diffuse readily through porin channels in the outer membranes of Gram-negative bacteria. However, transport from the periplasmic space into the cytosol is driven by the negative membrane potential of the inner periplasmic membrane and is, therefore, an energy-dependent process. Once in the cytosol, these antibiotics interact with at least three ribosomal proteins and with specific bases within the decoding region of the smaller ribosomal RNA subunit, resulting in inhibition of protein synthesis and an increased frequency of induced translational errors (for reviews, please see Noller 1984; Cundliffe 1990).

In vitro, kanamycin and other aminoglycoside antibiotics that lack a guanido group (e.g., neomycin and gentamycin) also inhibit splicing of group I introns (von Ahsen et al. 1991, 1992; von Ahsen and Noller 1993). This observation supports the idea that the aminoglycoside antibiotics may recognize ancient structures in RNA that have been conserved through long stretches of evolutionary time (Davies 1990).

### Mechanism of Resistance to Kanamycin

In structure, the kanamycins resemble gentamycin, neomycin, and geneticin (G418) (please see Figure 1-14), and they are inactivated by many of the same bacterial aminophosphotransferases (APHs) (for reviews, please see Davies and Smith 1978; Shaw et al. 1993). Of the seven major groups of APHs that have been distinguished on the basis of their substrate specificities, two have been used extensively as selectable markers for kanamycin resistance ( $Km^r$ ): APH(3')-I isolated from transposon Tn903, and APH(3')-II isolated from Tn5. The APHs encoded by these genes inactivate kanamycin by transferring the  $\gamma$ -phosphate of ATP to the hydroxyl group in the 3' position of the pseudosaccharide.

Both *aph(3')-Ia* and *aph(3')-IIa* have been used as selectable markers in prokaryotic vectors. However, it is not always easy to ascertain from the literature which gene has been used to construct particular vectors. This is unfortunate because the DNA sequences of *aph(3')-Ia* and *aph(3')-IIa* have diverged extensively (Shaw et al. 1993), such that the two genes have different restriction maps and will not cross-hybridize under normal conditions of stringency. APH(3')-II efficiently inactivates geneticin (G418) and is used as a dominant selectable marker in eukaryotic cells (e.g., please see Jimenez and Davies 1980; Colbère-Garapin et al. 1981; Southern and Berg 1982; Chen and Fukuhara 1988).

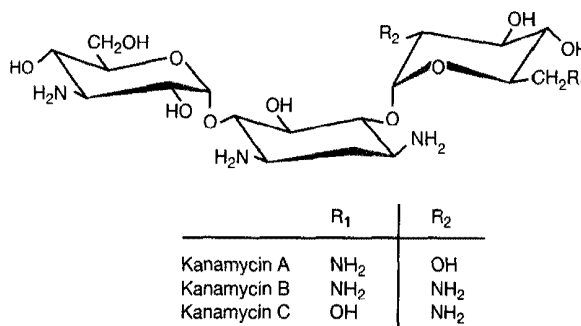


FIGURE 1-14 Structures of Kanamycins

---

**pBR322**

---

- pBR322 and all of its derivatives replicate in a relaxed fashion. Their copy number can be increased from ~20 to >500 by inhibiting bacterial protein synthesis with an antibiotic such as chloramphenicol.
- pBR322 and some of its derivatives recombine to form multimers in *recA*<sup>+</sup> hosts (Bedbrook et al. 1979). pBR322 does not carry a stability region (*cer*) that maintains the plasmid as monomers, which are more efficiently partitioned between daughter cells (Summers and Sherratt 1984). *cer* is a 280-bp sequence at which a host recombinase (*xerC*) acts in concert with ArgR and PepA proteins to reduce multimeric plasmid DNAs to a monomeric form (Colloms et al. 1990).
- pBR322 and its immediate derivatives lack a partition function and are readily lost from cells during sustained growth in minimal media in the absence of antibiotics. This problem was solved by the construction of plasmids that contain the *par* locus of pSC101 in a pBR322 backbone (Zurita et al. 1984). The *par* locus induces supercoiling of the origin of replication, which somehow allows each plasmid molecule in the intracellular pool to be treated as an individual unit of inheritance (Miller et al. 1990; Conley and Cohen 1995; Firshein and Kim 1997).
- pBR322, like almost all plasmid vectors commonly used in molecular cloning, is nonconjugative and is incapable of directing its conjugal transfer from one bacterium to another. This is because pBR322 lacks a region (*mob*) encoding proteins that bind to the plasmid DNA at the origin of transfer (*oriT*). Mob proteins introduce a single-strand nick at a site called *nic* located within a *cis*-acting region called *bom* (for reviews, please see Chan et al. 1984; Willetts and Wilkins 1984). pBR322 and some plasmid vectors of the same vintage can be mobilized if a conjugative plasmid that expresses Mob proteins is also present in the cell (Young and Poulis 1978). Mobilization of pBR322 then occurs from the *nic* site (nucleotide 2254 in the pBR sequence). Newer plasmid vectors lack the *nic/bom* site and cannot be mobilized (Twigg and Sherratt 1980; Covarrubias et al. 1981).

## TETRACYCLINE

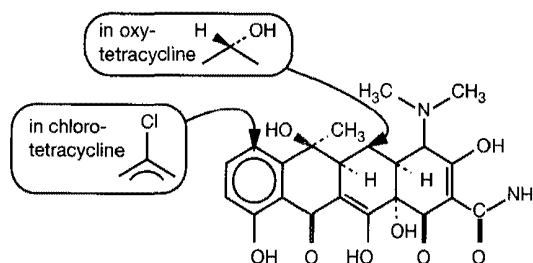
### Properties and Mode of Action of Tetracycline

- All tetracyclines share an identical four-ring carbocyclic skeleton that supports a variety of groups (please see Figure 1-15).
- The first of the tetracyclines — chlortetracycline — was discovered in 1948 as a naturally occurring antibiotic synthesized by *Streptomyces aureofaciens* and active against a wide-range of Gram-positive and Gram-negative bacteria and protozoa. By 1980, ~1000 tetracycline derivatives had been isolated and/or synthesized, and the estimated global production was in excess of 500 metric tons (for review, please see Chopra et al. 1992).
- Tetracycline enters bacterial cells by passive diffusion across the outer membrane through porin channels, which are composed of the OmpF protein. Transport of the antibiotic across the cytoplasmic membrane and into the cytoplasm requires pH or electropotential gradients.
- Tetracycline inhibits bacterial growth by disrupting codon-anticodon interactions at the ribosome, which blocks protein synthesis (for reviews, please see Gale et al. 1981; Chopra 1985; Chopra et al. 1992). Specifically, the antibiotic binds to a single site on the 30S ribosomal subunit and thereby prevents attachment of aminoacyl-tRNA to the acceptor site.

### Mechanism of Resistance of Tetracycline

- The chief mechanism by which *E. coli* becomes resistant to high concentrations of tetracycline involves antiporter proteins, known as Tet proteins, which are located in the bacterial inner membrane and, in exchange for a proton, expel intracellular tetracycline-metal complexes against a concentration gradient (for review, please see Chopra et al. 1992). Resistant cells are able to grow in the presence of tetracycline because they maintain a low intracellular concentration of the drug.
- The five known related tetracycline efflux genes, designated *tetA(A)* to *tetA(E)*, encode hydrophobic proteins of homologous sequence and similar structure.
- The *tetA(C)* gene of pBR322 and many other vectors encodes a 392-residue polypeptide composed of two domains each containing six transmembrane segments (for review and references, please see McNicholas et al. 1992). The TetA(C) protein assembles into a multimeric form in the inner membrane of *E. coli* (Hickman and Levy 1988).
- The expression of *tetA(C)* has several collateral effects on the cell (for references, please see Griffith et al. 1994). These effects include (1) reduced growth and viability, (2) increased supercoiling of plasmid DNA, (3) complementation of defects in potassium uptake, and (4) increased susceptibility to other antibacterial agents, including aminoglycoside antibiotics and lipophilic acids.

Inactivation of the *tetA(C)* gene therefore provides growth advantage to bacteria that are exposed to such agents. In the early days of molecular cloning, this effect was used to select for bacteria carrying recombinant plasmids in which the *tetA(C)* gene had been inactivated by insertion of a foreign DNA sequence (Bochner et al. 1980).



**FIGURE 1-15 Structure and Synthesis of Tetracycline**

The carbon atoms in the tetracycline skeleton carry substitute groups in various tetracycline derivatives. Chemical bonds (*filled arrows*) appear above the plane of the figure; bonds (*dashed lines*) appear below the plane of the figure.

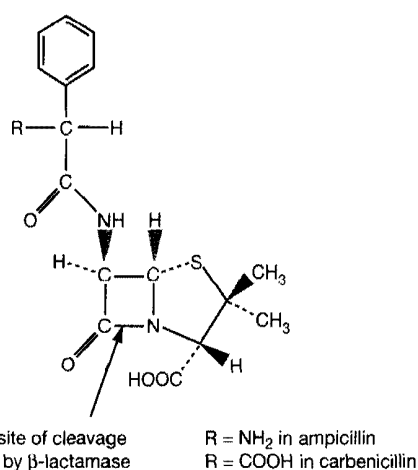
## AMPICILLIN AND CARBENICILLIN

### Properties and Mode of Action of Ampicillin and Carbenicillin

- Ampicillin is an aminopenicillin; carbenicillin is a semi-synthetic carboxypenicillin (please see Figure 1-16).
- The antimicrobial activity of both compounds extends to Gram-negative organisms such as *Haemophilus influenzae* and *E. coli*. Carbenicillin was the first penicillin with significant activity against *Pseudomonas* species that are not susceptible to aminopenicillins, such as ampicillin.
- The rigidity of the cell walls of susceptible organisms is due in part to a thin layer of cross-linked peptidoglycan, just 1–2 molecules thick. The long glycan chains are composed entirely of amino sugars and are cross-linked by peptide chains containing D-amino acids. The penicillins inhibit the final stage of synthesis of cross-links, which occurs outside the cell and is catalyzed by a transpeptidase (for reviews, please see Neu 1985; Donowitz and Mandell 1988). Penicillins are most active against bacteria in the logarithmic phase of growth and have relatively little effect in the stationary phase, when synthesis of peptidoglycan is suppressed.
- In addition to their activity against transpeptidase, penicillins inhibit enzymes (called penicillin-binding proteins or PBPs) necessary for the rod-like structure of *E. coli* and for septum formation during division (Tomasz 1986).

### Mechanism of Resistance to Ampicillin and Carbenicillin

- The periplasmic enzyme  $\beta$ -lactamase catalyzes hydrolysis of the cyclic amide bond of the  $\beta$ -lactam ring, with concomitant detoxification of ampicillin and carbenicillin (Abraham and Chain 1940; Bush and Sykes 1984).
- $\beta$ -lactamases are present in small amounts in the periplasmic space of field strains of antibiotic-resistant, Gram-negative bacteria. They are coded either chromosomally or on plasmids. The most prevalent  $\beta$ -lactamase in Gram-negative bacteria — the TEM  $\beta$ -lactamase — is named after the initials of the Athenian girl from whom a strain of *E. coli* expressing the enzyme was first isolated in 1965 (Datta and Kontomichalou 1965). The TEM  $\beta$ -lactamase, which is widely used as a selectable marker in molecular cloning, is a 286-residue protein encoded by the *bla* gene (Sutcliffe 1978). The first 23 amino acids of the nascent lactamase protein function as a signal sequence cleaved during translocation of the protein into the periplasm.
- When  $\beta$ -lactamase is expressed from high-copy vectors, such as those used in molecular cloning, large amounts of the enzyme are secreted into the medium. Sufficient  $\beta$ -lactamase can be produced by a single transformed colony to hydrolyze the antibiotic in the surrounding medium and to create a protected zone in which antibiotic-sensitive colonies can grow. This leads to the appearance of nontransformed, satellite colonies. The problem is ameliorated, but not completely eliminated, by using carbenicillin rather than ampicillin in selective media, because carbenicillin is more resistant than ampicillin to hydrolysis by the  $\beta$ -lactamases of genera such as *Pseudomonas* and *Escherichia*.



**FIGURE 1-16** Cleavage of  $\beta$ -Lactam Antibiotics by  $\beta$ -Lactamase

Chemical bonds (filled arrows) appear above the plane of the figure; bonds (dashed lines) appear below the plane of the figure.

---

**X-GAL**

---

*E. coli* encodes a  $\beta$ -galactosidase that hydrolyzes the disaccharide lactose into the monosaccharides glucose and galactose. The activity of the enzyme can be assayed with a chromogenic substrate such as X-gal (5-bromo-4-chloro-3-indolyl- $\beta$ -D-galactoside), which is converted by  $\beta$ -galactosidase into an insoluble dense blue compound (Horwitz et al. 1964; Davies and Jacob 1968).

This discovery came about when, in 1967, Julian Davies, working at the Pasteur Institute, was trying to develop nondestructive histochemical stains that would allow him to distinguish between  $\text{Lac}^+$  and  $\text{Lac}^-$  colonies. This goal required finding a specific chromogenic substrate that would be hydrolyzed by  $\beta$ -galactosidase to highly colored products that were both nondiffusible and nontoxic. Davies was pleased to find that phenyl- $\beta$ -galactosides produced a satisfactory color reaction, but he was less gratified by their conversion to toxic nitrophenols that efficiently killed the very cells he was trying to identify. Understandably, Davies, who is voluble and Welsh, found this situation a little frustrating. He expressed his Cymric indignation to Mel Cohn, a visitor to the laboratory, who fortunately remembered reading a brief paper by Horwitz and his colleagues describing the use of dihalogeno-indolyl compounds as histological stains for  $\beta$ -galactosidase (Horwitz et al. 1964). Davies' next problem was to persuade the people at the Pasteur to buy some X-gal. In those days, X-gal was not available commercially and custom synthesis cost \$1000 per gram. After much discussion, X-gal was ordered, synthesized, and delivered. In addition to being sensitive and nontoxic, X-gal turned out to be an extremely beautiful histochemical reagent that has generated gorgeous pictures of  $\beta$ -galactosidase expression in flora and fauna of all types. When Jacques Monod first saw the brilliant blue color of induced bacterial colonies, he commented that this was proof that *E. coli* was the most intelligent organism in the world.

---

 **$\alpha$ -COMPLEMENTATION**

---

$\alpha$ -Complementation occurs when two inactive fragments of *E. coli*  $\beta$ -galactosidase associate to form a functional enzyme. Deletion of the 5' region of the *lacZ* gene encoding the initiating methionine residues causes translation to begin at a downstream methionine residue, generating a carboxy-terminal fragment of the enzyme (the  $\omega$ - or  $\alpha$ -acceptor fragment). An amino-terminal fragment (the  $\alpha$ -donor fragment) is generated by deletion or chain-terminating mutations in the structural gene. Although neither the  $\alpha$ -donor fragment nor the  $\omega$ -acceptor fragment is enzymatically active, the two parts of the enzyme can associate to form an active  $\beta$ -galactosidase both in cells and in vitro (Ullmann et al. 1967). Many  $\alpha$  donors of varying lengths are functional for complementation. The minimum requirement seems to be an  $\alpha$ -peptide containing residues 3–41 (Langley et al. 1975; Zabin 1982; Weinstock et al. 1983; Henderson et al. 1986).

Analysis of the three-dimensional structure of *E. coli*  $\beta$ -galactosidase (Jacobson et al. 1994) provides a rational explanation for  $\alpha$ -complementation.  $\beta$ -galactosidase is a tetramer composed of four identical monomers of 1023 amino acids, which are folded into five sequential domains. The amino-terminal segment of the monomer (the complementation region) directly participates in the interfacial association among monomers by forming contacts with domains 1, 2, and 3 of its own monomer. The complementation peptide also stabilizes an interfacial four-helix bundle composed of two helices from each of two monomers.

Many of the plasmid vectors carry a short segment of *E. coli* DNA containing the regulatory sequences and the coding information for the first 146 amino acids of the  $\beta$ -galactosidase gene. Embedded in the coding region is a polycloning site that maintains the reading frame and results in the harmless interpolation of a small number of amino acids into the amino-terminal fragment of  $\beta$ -galactosidase. Vectors of this type are used in host cells that express the carboxy-terminal portion of  $\beta$ -galactosidase. Although neither the host-encoded nor the plasmid-encoded fragments of  $\beta$ -galactosidase are themselves active, they can associ-

ate to form an enzymatically active protein. This type of complementation, in which deletion mutants of the operator-proximal segment of the *lacZ* gene are complemented by  $\beta$ -galactosidase-negative mutants that have the operator-proximal region intact, is called  $\alpha$ -complementation (Ullmann et al. 1967). The *lac*<sup>+</sup> bacteria that result from  $\alpha$ -complementation are easily recognized because they form blue colonies in the presence of the chromogenic X-gal (Horwitz et al. 1964; Davies and Jacob 1968; please see the information panel on **X-GAL**). However, insertion of a fragment of foreign DNA into the polycloning site of the plasmid almost invariably results in production of an amino-terminal fragment that is no longer capable of  $\alpha$ -complementation. Bacteria carrying recombinant plasmids therefore form white colonies. The development of this simple color test has greatly simplified the identification of recombinants constructed in plasmid vectors. It is easy to screen many thousands of transformed colonies and to recognize from their white appearance those that carry putative recombinant plasmids. The structure of these recombinants can then be verified by restriction analysis of minipreparations of vector DNA or by other diagnostic criteria. For procedures for screening recombinants using  $\alpha$ -complementation, please see Protocol 27 and the panel on **ALTERNATIVE PROTOCOL: ON DIRECT APPLICATION OF X-GAL AND IPTG TO AGAR PLATES**.

Screening by  $\alpha$ -complementation is highly dependable but not completely infallible:

- Insertion of foreign DNA does not always inactivate the complementing activity of the  $\alpha$ -fragment of  $\beta$ -galactosidase. If the foreign DNA is small (<100 bp), and if the insertion neither disrupts the reading frame nor affects the structure of the  $\alpha$ -fragment,  $\alpha$ -complementation may not be seriously affected. Examples of this phenomenon have been documented but they are very rare and of significance only to the investigator who encounters this problem.
- Not all white colonies carry recombinant plasmids. Mutation or loss of *lac* sequences may purge the plasmid of its ability to express the  $\alpha$ -fragment. However, this is not a problem in practice because the frequency of *lac*<sup>-</sup> mutants in the plasmid population is usually far lower than the number of recombinants generated in a ligation reaction.

In most bacterial strains used for  $\alpha$ -complementation, the  $\omega$ -fragment is encoded by the deletion mutant *lacZ* $\Delta$ M15, which lacks codons 11–41 of the  $\beta$ -galactosidase gene (Ullmann and Perrin 1970). This mutant gene is usually carried on an F' plasmid.

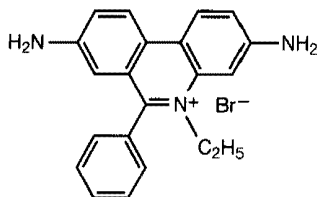
Strains of bacteria commonly used for  $\alpha$ -complementation do not synthesize significant quantities of *lac* repressor. Consequently, there is usually no need to induce synthesis of  $\omega$  and  $\alpha$  fragments for histochemical analysis of bacterial colonies. If necessary, synthesis of both fragments can be fully induced by IPTG, a nonfermentable lactose analog that inactivates the *lacZ* repressor (Barkley and Bourgeois 1978).

---

## ETHIDIUM BROMIDE

---

Ethidium bromide (3,8-diamino-6-ethyl-5-phenylphenanthridium bromide) was synthesized in the 1950s in an effort to develop phenanthridine compounds as effective trypanocidal agents; the structure is shown in Figure 1-17. Ethidium emerged from the screening program with flying colors. It was 10–50-fold more effective against trypanosomes than the parent compound, was no more toxic to mice, and, unlike earlier phenanthridines, did not induce photosensitization in cattle (Watkins and Wolfe 1952). Ethidium bromide is still widely used for the treatment and prophylaxis of trypanomiasis in cattle in tropical and subtropical countries.



**FIGURE 1-17** Structure of Ethidium Bromide

---

In addition to its veterinary uses, ethidium bromide has played an important part in the development of molecular cloning: Staining with a low concentration of ethidium bromide has been the standard method of detecting small quantities of DNA in agarose gels for more than 25 years (Sharp et al. 1973); and from 1966 to the mid-1980s, equilibrium CsCl-ethidium bromide centrifugation was the only reliable method available to purify closed circular DNAs (Bauer and Vinograd 1971). The usefulness of ethidium bromide for these tasks derives from its fluorescent properties in combination with its ability to intercalate between the base pairs of double-stranded DNA.

After insertion into the helix, the planar stacked tricyclic phenanthridine ring system of the drug lies perpendicular to the helical axis and makes van der Waals contacts with the base pairs above and below. At saturation in solutions of high ionic strength, approximately one ethidium molecule is intercalated per 2.5 bp, independent of the base composition of the DNA. The geometry of the base pairs and their positioning with respect to the helix are unchanged except for their displacement by 3.4 Å along the helix axis (Waring 1965). This causes a 27% increase in the length of double-stranded DNA (Freifelder 1971) saturated with ethidium bromide.

When isolated from host cells, closed circular DNA molecules display a right-handed superhelical structure that results from a deficiency of Watson-Crick turns. Intercalation of ethidium bromide requires local uncoiling of the helix at the point of insertion, which alters the average pitch of the helix and increases the average number of base pairs per turn until a critical value is reached when the circular DNA molecules are unstrained and free of all supercoils (Lerman 1961). As more drug is added, the additional uncoiling forces the circles to form left-handed supercoils (Crawford and Waring 1967; Bauer and Vinograd 1968). However, the binding affinity of the dye for closed circular DNA decreases progressively as the number of reversed supercoils increases. Because of this decrease in binding affinity, closed circular DNAs bind less drug at saturation than do nicked circles or linear molecules (Bauer and Vinograd 1968, 1970). Binding of ethidium bromide reduces the buoyancy of DNA in CsCl density gradients, and the magnitude of this decrease is a function of the average number of drug molecules bound per base pair. Because of the restricted binding of ethidium bromide to positively supercoiled DNAs, closed circular DNAs come to equilibrium at a denser position (~1.59 g/cc) in CsCl-ethidium bromide gradients than linear or nicked circular DNAs (1.55 g/cc).

The fixed position of the planar group of ethidium bromide and its close proximity to the bases cause the bound dye to display an increased fluorescent yield compared to the dye in free solution. Ultraviolet (UV) radiation at 254 nm is absorbed by the DNA and transmitted to the dye; radiation at 302 nm and 366 nm is absorbed by the dye itself. In both cases, a fraction of energy is re-emitted at 590 nm in the red-orange region of the visible spectrum (LePecq and Paoletti 1967). Most of the commercially available UV light sources emit UV light at 302 nm. The fluorescent yield of ethidium bromide-DNA complexes is considerably greater at this wavelength than at 366 nm but is slightly less than at shorter wavelength (254 nm). However, the amount of photobleaching and nicking of the DNA is much less at 302 nm than at 254 nm (Brunk and Simpson 1977).

The reaction between ethidium bromide and DNA is reversible (Waring 1965), but the dissociation of the complex is very slow and is measured in days rather than minutes or hours. For practical purposes, dissociation is achieved by passing the complex through a small column packed with a cation-exchange resin such as Dowex AG50W-X8 (Waring 1965; Radloff et al. 1967) or by extracting with organic solvents such as isopropanol (Cozzarelli et al. 1968) or *n*-butanol (Wang 1969). The former method has been shown to result in the removal of ethidium bromide to a binding ratio below that detectable by fluorescence, a molar ratio of dye to nucleic acid of 1:4000 (Radloff et al. 1967).

Ethidium bromide also binds with highly variable stoichiometry to RNA, heat-denatured or single-stranded DNA, and the cyclic-coil form of closed circular DNA. This is attributed to binding of the drug to helical regions formed by intrastrand interactions in these polynucleotides (Waring 1965, 1966; LePecq and Paoletti 1967).



---

**CONDENSING AND CROWDING REAGENTS**

---

Condensing reagents, like hexamminecobalt chloride and crowding reagents, such as polyethylene glycol, have two effects on ligation reactions:

- They accelerate the rate of ligation of blunt-ended DNA by one to three orders of magnitude. This increase allows ligation reactions to be performed at lower concentrations of enzyme and DNA.
- They alter the distribution of ligation products. Intramolecular ligation is suppressed, and the ligation products are created exclusively by intermolecular joining events. Thus, even at concentrations of DNA that favor circularization, all of the DNA products are linear multimers.

Different batches of PEG 8000 stimulate the ligation of blunt-ended DNAs to different extents. It is a good idea to test several batches of PEG 8000 to determine which one yields a maximum stimulation of ligation, and then to dedicate the chosen bottle for use in ligation reactions only. The maximum stimulation of ligation usually occurs between 3% and 5% PEG 8000 in the ligation reaction; however, this value can fluctuate between different batches and should be determined empirically. The PEG stock (13%) solution should be warmed to room temperature before being added to the ligation reaction, as DNA can precipitate at cold temperatures in the presence of PEG 8000. In addition, it is important that the PEG stock solution be added as the final ingredient to the ligation reaction. Stimulation of blunt-ended DNA ligation by PEG 8000 is highly dependent on the concentration of magnesium ions, which should be maintained in the 5–10 mM range in the ligation reaction.

In our hands, PEG gives more reproducible stimulation of blunt-end ligation than hexamminecobalt chloride.

---

**PURIFICATION OF PLASMID DNA BY PEG PRECIPITATION**

---

Minipreparations of plasmid DNA can be used as templates in dideoxysequencing reactions whose products can be analyzed on automated machines (please see Chapter 12). The length of the DNA sequence established in a run on one of these machines is determined largely by the purity of the plasmid DNA. The following steps can be added to the standard minipreparation of plasmid DNA by alkaline lysis with SDS to provide “sequencing-grade” plasmid DNA that reproducibly yields >600 bp of readable sequence on machines such as the Applied Biosystems Models 370A or 377.

1. To 50  $\mu$ l of a minipreparation of plasmid DNA (prepared as described in Protocol 1), add 8.0  $\mu$ l of 4 M NaCl and 40  $\mu$ l of 13% (w/v) PEG 8000. Incubate the mixture on ice for 20–30 minutes.
2. Collect the DNA precipitate by centrifugation at maximum speed for 15 minutes at 4°C in a microfuge. Carefully remove the supernatant by gentle aspiration.

The pellet of DNA is translucent and generally invisible at this stage.

3. Rinse the pellet with 500  $\mu$ l of 70% ethanol.  
The precipitate changes to a milky-white color and becomes visible.
4. Carefully pour off the ethanol. Rinse the DNA pellet once more with 70% ethanol. Store the tube in an inverted position at room temperature until the last visible traces of ethanol have evaporated.
5. Dissolve the DNA in 20–30  $\mu$ l of H<sub>2</sub>O.

1.5 ml of bacterial culture should yield 3–5  $\mu$ g of purified plasmid DNA. Check the concentration and integrity of the preparation of plasmid DNA by agarose gel electrophoresis using known amounts of plasmid DNA of similar size as standards. Do not submit a plasmid DNA to a sequencing facility without first performing this agarose gel check.

---

**LYSOZYMES**

---

*A drop from the nose of Fleming, who had a cold, fell onto an agar plate where large yellow colonies of a contaminant had grown, and lysozyme was discovered. He made this important discovery because when he saw that the colonies of the contaminant were fading, his mind went straight to the right cause of the phenomenon he was observing — that the drop from his nose contained a lytic substance. And, also immediately, he thought that this substance might be present in many secretions and tissues of the body. And he found that this was so — the substance was in tears, saliva, leucocytes, skin, fingernails, mother's milk — thus very widely distributed in amounts and also in plants.*

Lady Amelia Fleming (Personal Recollections of Lysozyme and Fleming)

*I have been trying to point out that in our lives chance may have an astonishing influence and, if I may offer advice to the young laboratory worker, it would be this — never to neglect an extraordinary appearance or happening. It may be — usually is, in fact — a false alarm that leads to nothing, but it may on the other hand be the clue provided by fate to lead you to some important advance.*

Alexander Fleming (from his lecture at Harvard University)

- Lysozymes are a family of enzymes that catalyze the acid base hydrolysis of  $\beta$ -(1,4) linkages between *N*-acetylglucosamine and *N*-acetylmuramic acid residues in the proteoglycan of bacterial cell walls (Blake et al. 1967; Fursht 1985). They were discovered by Alexander Fleming, who identified an enzyme activity that rapidly lysed suspensions of bacteria (Fleming 1922). The products of digestion by vertebrate lysozymes of the cell walls of bacteria were identified in the late 1950s, which allowed the structure and composition of the substrate to be deduced (for review, please see Jollés 1960).
- Lysozymes are widely distributed in nature and are expressed wherever there is a need to lyse bacterial cells, for example, during release of bacteriophages from infected cells, on the surface of vertebrate mucosa, and in a great number of secretions of different animals, both vertebrate and invertebrate. No structural similarity exists between vertebrate and bacteriophage-encoded lysozymes such as bacteriophage  $\lambda$  endolysin and bacteriophage T4 endoacetylmuramidase.
- In molecular cloning, vertebrate lysozymes (e.g., egg-white lysozyme) are used at pH 8.0 in combination with EDTA and detergents to liberate cosmid and plasmid DNAs from their bacterial hosts (Godson and Vapnek 1973).

---

**POLYETHYLENE GLYCOL**


---

PEG is a straight chain polymer of a simple repeating unit  $\text{H}(\text{OCH}_2\text{CH}_2)_n\text{OH}$ , and it is available in a range of molecular weights whose names reflect the number ( $n$ ) of repeating units in each molecule. In PEG 400, for example,  $n = 8-9$ , whereas in PEG 4000,  $n$  ranges from 68 to 84.

PEG induces macromolecular crowding of solutes in aqueous solution (Zimmerman and Minton 1993) and has a range of uses in molecular cloning, including:

- Precipitation of DNA molecules according to their size. The concentration of PEG required for precipitation is in inverse proportion to the size of the DNA fragments (Lis and Schleif 1975a,b; Ogata and Gilbert 1977; Lis 1980). The precipitation of DNA by PEG is most efficient in the presence of 10 mM  $\text{MgCl}_2$  at room temperature (Paithankar and Prasad 1991). Under these conditions, the efficiency of PEG precipitation approaches that obtainable with ethanol. Both long linear and circular forms of DNAs are efficiently precipitated; however, linear DNAs of less than 150 bp are not quantitatively precipitated by PEG/ $\text{MgCl}_2$ .
- Precipitation and purification of bacteriophage particles (Yamamoto et al. 1970).
- Increasing the efficiency of reassociation of complementary chains of nucleic acids during hybridization, blunt-end ligation of DNA molecules, and end-labeling of DNA with bacteriophage T4 polynucleotide kinase (Zimmerman and Minton 1993).
- Fusion of cultured cells with bacterial protoplasts (Schaffner 1980; Rassoulzadegan et al. 1982).

---

**CESIUM CHLORIDE AND CESIUM CHLORIDE EQUILIBRIUM DENSITY GRADIENTS**


---

Cesium, the 55th element, was discovered in 1855 by Wilhelm Bunsen, a German chemist better known for his burner.

Because cesium atoms are so heavy, concentrated solutions of CsCl form density gradients after only a few hours of high-speed centrifugation (Meselson et al. 1957). The buoyant density of a macromolecule is defined as the concentration of CsCl (in  $\text{g}/\text{cm}^3$ ) at that exact point in the density gradient at which the macromolecule floats. The density of the initial solution of CsCl in the centrifuge tube is usually adjusted so that it corresponds to the density of the molecules or particles under investigation. For example, because the buoyant density of most double-stranded linear DNAs in CsCl is  $\sim 1.70$  g/ml, gradients are usually formed from a CsCl solution whose initial density is also 1.70 g/ml.

**Double-stranded DNAs**

The density of double-stranded linear DNA in CsCl is a function of its base composition (Schildkraut et al. 1962).

$$\rho = (0.098)[\text{G+C}] + 1.660 \text{ g/cm}^3$$

where

$$\begin{aligned} \rho &= \text{buoyant density of DNA} \\ [\text{G+C}] &= \text{mole fraction of G+C in double-stranded DNA} \end{aligned}$$

In solutions of  $\text{Cs}_2\text{SO}_4$ , the density of double-stranded DNA is insensitive to base composition.

**Single-stranded DNAs**

In CsCl solutions, the density of single-stranded DNA is  $\sim 0.015\text{--}0.020\text{ g/cm}^3$  greater than that of double-stranded DNA of the same base composition.

**RNA**

The buoyant density of single-stranded RNA in CsCl is  $>1.8\text{ gm/cm}^3$ . This is approximately the density of a saturated solution of CsCl. RNA therefore forms a pellet on the bottom of CsCl density gradients. The difference in buoyant density of RNA and DNA forms the basis of an efficient method to prepare RNAs that are free of traces of DNA (Glišin et al. 1974).

**Bacteriophage Particles**

The buoyant density of protein in CsCl is  $\sim 1.3\text{ g/cm}^3$ , whereas the density of double-stranded DNA is  $\sim 1.70\text{ g/cm}^3$ . Virus particles have a density that reflects their ratio of nucleic acid to protein. For example, bacteriophage  $\lambda$ , which consists of almost equal parts of protein and double-stranded DNA has a density of  $\sim 1.48\text{ g/cm}^3$ . This is sufficiently different from other cellular components that equilibrium density centrifugation in CsCl has long been used as a standard method of purification of bacteriophage  $\lambda$  particles (Yamamoto et al. 1970).

**Properties of CsCl Solutions**

The concentration of CsCl corresponding to any desired density between 1.20 and 1.80 (30–60% w/w of CsCl at 25°C) can be calculated from the following table.

The properties of aqueous solutions of CsCl are given in Table 1-11 on the following page.

TABLE 1-11 Properties of Solutions of Cesium Chloride

A % BY WEIGHT	$D_{20}^{20}$	Cs (G/LITER)	M (G-MOLE/LITER)	CW (G/LITER)	CO-CW (G/LITER)	$n-n_0$ ( $\times 10^4$ )	N	$\Delta$ °C	S (G-MOLE/LITER)
.00	1.0000	0	.000	998.2	0	0	1.3330	.00	.000
1.00	1.0076	10.1	.060	995.8	2.5	8	1.3338	.20	.057
2.00	1.0153	20.3	.120	993.3	5.0	15	1.3345	.40	.114
3.00	1.0232	30.6	.182	990.7	7.5	23	1.3353	.59	.172
4.00	1.0311	41.2	.245	988.2	10.1	31	1.3361	.80	.231
5.00	1.0392	51.9	.308	985.5	12.7	39	1.3369	1.00	.292
6.00	1.0475	62.7	.373	982.9	15.3	48	1.3378	1.21	.353
7.00	1.0558	73.8	.438	980.2	15.0	56	1.3386	1.42	.414
8.00	1.0643	85.0	.505	977.5	20.8	65	1.3395	1.63	.477
9.00	1.0730	96.4	.573	974.7	23.5	73	1.3403	1.85	.541
10.00	1.0818	108.0	.641	971.9	26.4	82	1.3412	2.07	.605
11.00	1.0907	119.8	.711	969.0	29.3	91	1.3421	2.29	.669
12.00	1.0997	131.7	.782	966.1	32.2	100	1.3430	2.52	.735
13.00	1.1089	143.9	.855	963.1	35.2	110	1.3439	2.75	.801
14.00	1.1183	156.3	.928	960.0	38.2	119	1.3449	2.99	.867
15.00	1.1278	168.9	1.003	956.9	41.3	128	1.3458	3.22	.934
16.00	1.1375	181.7	1.079	953.8	44.5	138	1.3468	3.46	1.002
17.00	1.1473	194.7	1.156	950.6	47.7	148	1.3478	3.71	1.070
18.00	1.1573	207.9	1.235	947.3	51.0	158	1.3488	3.96	1.139
19.00	1.1674	221.4	1.315	943.9	54.3	168	1.3498	4.21	1.215
20.00	1.1777	235.1	1.396	940.5	57.7	178	1.3508	4.47	1.286
22.00	1.1989	263.3	1.564	933.5	64.8	199	1.3529		
24.00	1.2207	292.4	1.737	926.1	72.1	220	1.3550		
26.00	1.2433	322.7	1.916	918.4	79.8	242	1.3572		
28.00	1.2666	354.0	2.103	910.4	87.9	265	1.3595		
30.00	1.2908	386.6	2.296	902.0	96.3	288	1.3618		
32.00	1.3158	420.3	2.496	893.1	105.1	312	1.3642		
34.00	1.3417	455.4	2.705	883.9	114.3	337	1.3666		
36.00	1.3685	491.8	2.921	874.3	124.0	362	1.3692		
38.00	1.3963	529.6	3.146	864.2	134.1	388	1.3718		
40.00	1.4251	569.0	3.380	853.5	144.7	414	1.3744		
42.00	1.4550	610.0	3.623	842.4	155.8	442	1.3772		
44.00	1.4861	652.7	3.877	830.8	167.5	470	1.3800		
46.00	1.5185	697.3	4.141	818.5	179.7	500	1.3829		
48.00	1.5522	743.7	4.417	805.7	192.5	530	1.3860		
50.00	1.5874	792.3	4.706	792.3	206.0	562	1.3891		
52.00	1.6241	843.0	5.007	778.2	220.0	595	1.3924		
54.00	1.6625	896.2	5.323	763.4	234.8	629	1.3959		
56.00	1.7029	951.9	5.654	747.9	250.3	665	1.3995		
58.00	1.7453	1010.5	6.001	731.7	266.5	703	1.4033		
60.00	1.7900	1072.1	6.367	714.7	283.5	744	1.4074		
62.00	1.8373	1137.1	6.754	696.9	301.3	787	1.4117		
64.00	1.8875	1205.9	7.162	678.3	319.9	833	1.4163		

Cesium chloride, CsCl; molecular weight = 168.37; relative specific refractivity = 0.465.

Reprinted, with permission, from CRC Handbook of Chemistry and Physics (1980-1981) (ed. R.C. Weast), 61st edition. Copyright CRC Press, Boca Raton, Florida.

## DNA LIGASES

Ligases catalyze the formation of phosphodiester bonds between the directly adjacent 3'-hydroxyl and 5'-phosphoryl termini of nucleic acid molecules. The substrates may be DNA or RNA, and the cofactors that generate high-energy intermediates in the reaction may be ATP or  $\text{NAD}^+$ , depending on the type of ligase.

In vivo, DNA ligases are required for enzymatic completion of lagging-strand synthesis during replication of DNA, and they are also involved in genetic recombination and in DNA repair (Gottesman et al. 1973; Horiuchi et al. 1975; Waga et al. 1994; for review, please see Kornberg and Baker 1992; Shuman 1996; Lehman 1998). In vitro, DNA ligases are used chiefly to create novel combinations of nucleic acid molecules and to attach them to vectors before molecular cloning. More specialized uses of DNA ligases include the sealing of nicks in the second strand during synthesis of cDNA (Okayama and Berg 1982), the amplification of DNA segments that lie outside the boundaries of known DNA sequences (the inverse PCR) (Triglia et al. 1988), the detection of nicks in DNA by the release of AMP (Weiss et al. 1968b), and, more recently, the detection of point mutations in DNA by the ligase chain reaction (also known as the ligase amplification reaction) (Landegren et al. 1988; Wu and Wallace 1989; Barany 1991a,b).

DNA ligases used in molecular cloning are either of bacterial origin or bacteriophage-encoded. All eubacteria, whether thermophilic or mesophilic, contain a single ligase gene that encodes an  $\text{NAD}^+$ -dependent enzyme (Olivera and Lehman 1967; Takahashi et al. 1984). During the first step of a ligation reaction, the diphosphate linkage of  $\text{NAD}^+$  is used as a phosphoanhydride and the adenyl group is transferred to the  $\epsilon$ -amino group of a lysine residue (Zimmerman et al. 1967; Gumpert and Lehman 1971). In the case of ligases encoded by the ATP-dependent ligases of eukaryotes and bacteriophages, the high-energy enzyme intermediate is formed more conventionally, by hydrolysis of the  $\alpha,\beta$  pyrophosphate in ATP and transfer of the adenyl group to a lysine residue (Becker et al. 1967; Cozzarelli et al. 1967; Weiss and Richardson 1967; Weiss et al. 1968a). From then on, however, the mechanism of the reaction catalyzed by the two types of enzymes is similar: The adenyl residue is transferred to the 5'-phosphate at the terminus of one DNA molecule, which is then open to nucleophilic attack by a hydroxyl group at the 3' terminus of an immediately adjacent DNA molecule. This results in the formation of a phosphodiester bond, elimination of AMP, and covalent joining of the DNA strands (for reviews of the mechanism of the ligation reaction, please see Lehman 1974; Higgins and Cozzarelli 1979; Engler and Richardson 1982; Shuman 1996).

The amino acid sequences of *E. coli* ligase show little overall similarity to the sequences of bacteriophage-encoded DNA ligases, to eukaryotic ATP-dependent ligases, or to the ligases of thermophilic bacteria. However, in all ligases so far identified (including RNA ligases), the lysine residue that becomes adenylated during the reaction lies in the vicinity of a reasonably well-conserved hexapeptide motif ( $\text{K}^{\text{+}}\text{-Y-D-G-X-R}$  in the case of T4 DNA Ligase) (Barker et al. 1985; Lauer et al. 1991; Kletzin 1992; Shuman 1996). In addition, the superfamily of ATP-dependent ligases shares five other linear sequence elements that are involved in contacts between the enzyme and ATP (Tomkinson et al. 1991; Shuman 1996).

The DNA ligases used in molecular cloning differ in their abilities to ligate noncanonical substrates, such as blunt-ended duplexes, DNA-RNA hybrids, or single-stranded DNAs. These and other properties are summarized in Table 1-12 on the following page.

### Bacteriophage T4 DNA Ligase

- T4 DNA ligase, which is encoded by gene 30 of bacteriophage T4 (Wilson and Murray 1979), is a monomeric protein of 487 amino acids (calculated  $M_r = 55,230$ ) (Weiss et al. 1968b; Armstrong et al. 1983).
- T4 DNA ligase, which is purified commercially from overproducing strains of *E. coli* (Tait et al. 1980), has a  $K_m$  of  $6 \times 10^{-7}$  M for cohesive termini (Sugino et al. 1977),  $5 \times 10^{-5}$  M for blunt ends, and  $1.9 \times 10^{-9}$  M for nicks. The  $K_m$  of the enzyme for ATP is  $\sim 5 \times 10^{-5}$  M (Weiss et al. 1968b).
- T4 RNA ligase has been reported to stimulate the activity of T4 DNA ligase (Sugino et al. 1977). However, agents such as polyethylene glycol (Pheiffer and Zimmerman 1983) and hexamminecobalt chloride (Rusche and Howard-Flanders 1985), which increase macromolecular crowding and increase the rate of ligation by three orders of magnitude, are less expensive (please see the information panel on **CONDENSING AND CROWDING REAGENTS**).

TABLE 1-12 DNA Ligases

LIGASE	SUBSTRATES <sup>a</sup>				COFACTORS AND ACTIVATORS	TEMPERATURE	SULFHYDRYL REAGENTS
	COHESIVE TERMINI	BLUNT ENDS	DNA-RNA HYBRIDS	RNA-RNA HYBRIDS			
<i>E. coli</i> ligase	yes	yes <sup>b</sup>	no	no	DPN <sup>+</sup> Mg <sup>2+</sup> (1–3 mM)	10–15°C for cohesive termini 37°C for closing nicks <sup>c</sup>	not required <sup>d</sup>
T4 ligase	yes	yes <sup>b</sup>	yes <sup>e</sup>	yes <sup>e</sup>	ATP Mg <sup>2+</sup> (10 mM)	4°C for cohesive termini <sup>f</sup> 15–25°C for blunt ends <sup>g</sup> 37°C for closing nicks <sup>i</sup>	dithiothreitol required <sup>h</sup>
Ligases of thermophilic bacteria	yes	no	no	no	DPN <sup>+</sup> <sup>j</sup> Mg <sup>2+</sup> (10 mM)	24–37°C for cohesive termini 65–72°C for closing nicks <sup>k,l,m</sup>	required <sup>k,m</sup>

<sup>a</sup>DNA ligases will not join pairs of DNAs whose termini carry the following groups at the point of ligation:

- 5'-hydroxyl and 3'-hydroxyl
- 5'-hydroxyl and 3'-phosphate
- 5'-phosphate and 3'-dideoxynucleoside
- 5'-triphosphate and 3'-hydroxyl

<sup>b</sup>*E. coli* DNA ligase was originally reported (Sugino et al. 1977) to be incompetent at joining of blunt-ended DNA molecules except in the presence of condensing agents such as PEG or Ficoll (Zimmerman and Pfeiffer 1983) and with monovalent cations such as Na<sup>+</sup> (Hayashi et al. 1985a,b). More recently, however, Barringer et al. (1990) have shown that *E. coli* DNA ligase is capable of joining blunt-ended and some single-stranded nucleic acids with kinetics that are dependent on enzyme and substrate concentration. However, for routine ligation of blunt-ended DNAs, bacteriophage T4 ligase is the enzyme of choice. T4 DNA ligase will ligate blunt-ended molecules (Ehrlich et al. 1977; Sgaramella and Ehrlich 1978), but the rate of reaction is not linearly dependent on enzyme concentration and works efficiently only in high concentrations of DNA and enzyme. In addition, condensing agents such as PEG, Ficoll, and hexamminecobalt chloride accelerate the rate of blunt-end ligation by T4 DNA ligases by a factor of 1000 and permit ligation at lower enzyme, ATP, and DNA concentrations (Zimmerman and Pfeiffer 1983; Rusche and Howard-Flanders 1985). Blunt-end ligation is inhibited by high concentrations of Na<sup>+</sup> (≥50 mM) and phosphate (≥25 mM) (Rae et al. 1975).

<sup>c</sup>Dugaiczky et al. (1975).

<sup>d</sup>Weiss and Richardson (1967).

<sup>e</sup>T4 DNA ligase can join RNA molecules annealed to either complementary DNA or RNA templates, albeit with low efficiency (Kleppe et al. 1970).

<sup>f</sup>Ferretti and Sgaramella (1981).

<sup>g</sup>Weiss et al. (1968a,b).

<sup>h</sup>Sgaramella and Ehrlich (1978).

<sup>i</sup>Pohl et al. (1982).

<sup>j</sup>Almost all thermophilic ligases, like mesophilic eubacterial ligases, use DPN<sup>+</sup> as a cofactor. However, one thermostable ligase that requires ATP as a cofactor has been cloned and sequenced (Kletzin 1992). The properties of this enzyme have not been investigated in detail.

<sup>k</sup>Takahashi et al. (1984).

<sup>l</sup>Takahashi and Uchida (1986).

<sup>m</sup>Barany (1991a,b).

- As shown in Table 1-12, T4 DNA ligase can catalyze the ligation of cohesive termini (Hedgpeth et al. 1972; Mertz and Davis 1972), oligodeoxynucleotides, or oligoribonucleotides in RNA-DNA hybrids (Olivera and Lehman 1968; Kleppe et al. 1970; Fareed et al. 1971). In addition, the enzyme can efficiently promote the end-to-end joining of two duplex molecules with fully base-paired termini (Sgaramella et al. 1970; Ehrlich et al. 1977).
- T4 DNA ligase shows a strong (Wiaderkiewicz and Ruiz-Carillo 1987; Landegren et al. 1988; Wu and Wallace 1989), but not absolute, aversion (Goffin et al. 1987) to joining oligonucleotides that are hybridized to a complementary template and contain a mispaired base at either the 3' or 5' junction of the two strands. This ability to discriminate between perfectly and imperfectly paired termini allowed the development of oligonucleotide ligation and amplification systems to detect mutations in genes of medical interest.
- High concentrations (>100 mM) of monovalent cations such as Na<sup>+</sup> and K<sup>+</sup> inhibit the activity of T4 DNA ligase, the extent of the inhibition varying with the terminal sequences of the substrate DNAs (Hayashi et al. 1985a). However, in the presence of crowding agents such as 10% PEG, monovalent cations have a paradoxical effect and stimulate the activity of the enzyme.

## *E. coli* DNA Ligase

- *E. coli* DNA ligase is encoded by the *lig* gene that lies at 52 minutes on the *E. coli* genetic map (Gottesman et al. 1973; Bachmann 1990).
- The *lig* gene (Gottesman 1976) and *lop11 lig<sup>+</sup>* (Cameron et al. 1975), a regulatory mutant overproducing the enzyme, have been cloned into bacteriophage  $\lambda$  vectors, thus facilitating large-scale purification of the enzyme (Panasenko et al. 1977, 1978). The nucleotide sequence of the *lig* gene (Ishino et al. 1986) shows that *E. coli* DNA ligase consists of 671 amino acids with a molecular weight of 73,690.
- For several years, it was believed that *E. coli* DNA ligase would not ligate blunt-ended double-stranded DNA. However, following cloning and expression of the ligase gene, highly active preparations of the enzyme became available that were able to catalyze blunt-end ligation with moderate efficiency (Barringer et al. 1990). Blunt-end ligation is stimulated about tenfold when the reaction mixture contains 10–15% PEG and high concentrations of  $K^+$  (Hayashi et al. 1985b). Nevertheless, *E. coli* DNA ligase is not widely used in molecular cloning procedures, since T4 DNA ligase is capable of efficiently joining blunt-ended DNAs in the absence of crowding agents.
- Unlike T4 DNA ligase, *E. coli* DNA ligase will not efficiently join RNA to DNA and is therefore unable to join adjacent RNA and DNA segments that arise during replacement synthesis of second-strand cDNA (Okayama and Berg 1982). The bacterial enzyme can therefore be used to generate long strands of cDNA that are uninterrupted by segments of RNA.

## Thermostable DNA Ligases

- The genes encoding thermostable ligases from several thermophilic bacteria have been cloned, sequenced, and expressed to high levels in *E. coli* (e.g., please see Takahashi et al. 1984; Barany and Gelfand 1991; Lauer et al. 1991; Jónsson et al. 1994). Several of these enzymes are available from commercial sources.
- Like the *E. coli* enzyme, almost all thermostable ligases use  $NAD^+$  as a cofactor and work preferentially at nicks in double-stranded DNA. In addition, thermostable ligases, like their mesophilic homolog, can catalyze blunt-end ligation in the presence of crowding agents, even at elevated temperatures (Takahashi and Uchida 1986).
- Because thermostable ligases retain activity after multiple rounds of thermal cycling, they are used extensively in the ligase amplification reaction to detect mutations in mammalian DNAs.

## Units of Ligase Activity

The standardization of ligase activity in units that are meaningful to both biochemists and molecular cloners has proven to be an elusive goal. For the last 20 years, at least three different units have been used to measure ligase activity:

- A *Weiss unit* (Weiss et al. 1968b) is defined as the amount of ligase that catalyzes the exchange of 1 nmole of  $^{32}P$  from inorganic pyrophosphate to ATP in 20 minutes at 37°C.
- The *Modrich-Lehman unit* (Modrich and Lehman 1971), now rarely used, is based on the conversion of radiolabeled  $d(A-T)_n$  copolymer with 3'-hydroxyl and 5'-phosphoryl termini to a form resistant to digestion with exonuclease III. One Modrich-Lehman unit is defined as the amount of enzyme required to convert 100 nmoles of  $d(A-T)_n$  to an exonuclease-III-resistant form in 30 minutes under standard assay conditions.
- *Arbitrary units*, defined by commercial suppliers, are based on the ability of ligase to ligate cohesive ends of DNA. These units are often more subjective than quantitative and provide little guidance to an investigator who values precision. In the absence of meaningful information, most investigators setting up ligation reactions must resort to guesswork, which inevitably means that more ligase will be used than is necessary. This, of course, is exactly what the commercial companies seek. As a rough guide, 1 Weiss unit is approximately equivalent to 60 cohesive end units (as defined by New England Biolabs). Thus, in 30 minutes at 16°C, 0.015 Weiss units of T4 DNA ligase should ligate 50% of fragments derived by digestion of 5  $\mu$ g of bacteriophage  $\lambda$  DNA with *Hind*III.



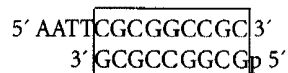
---

**ADAPTORS**


---

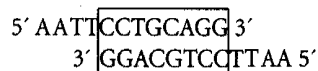
Adaptors are used to replace one type of protruding terminus with another. They are short double-stranded synthetic oligonucleotides that carry an internal restriction endonuclease recognition site and single-stranded tails at one or both ends (please see Table 1-13). This protruding sequence can be ligated to DNA fragments containing a complementary single-stranded terminus. After ligation, the DNA can be cleaved with the appropriate restriction enzyme to create a new protruding terminus.

Adaptors are available in two basic designs and a variety of specificities. Some adaptors consist of a partial duplex formed between two oligonucleotides of different lengths; for example, the *EcoRI-NotI* adaptor from Stratgene has the following structure:



During ligation, the protruding 5' end of the adaptor becomes joined to the complementary terminus of the target DNA, restoring an *EcoRI* site (GAATTC). In addition, the ligation of the phosphorylated blunt ends allows the adaptors to form dimers that contain internal *NotI* recognition sites (GCGGCCGC). Higher-order polymer formation cannot occur because the protruding 5' terminus is not phosphorylated.

By contrast, another class of adaptors is supplied as an unphosphorylated single oligonucleotide whose sequence is partially self-complementary. After duplex formation, the *EcoRI-PstI* adaptor from U.S. Specialty Biochemicals has the following structure:



During ligation, one strand of the adaptor becomes joined to the complementary terminus of the target DNA, restoring an *EcoRI* site. No further ligation is possible unless the adaptor has been phosphorylated in the investigator's laboratory, in which case the adaptors can form tandem arrays. Phosphorylation is recommended because tandem arrays of adaptors are cleaved more efficiently than single adaptors by the second restriction enzyme, in this case, *PstI* (site: CTGCAG).

Adaptors also offer an excellent way to ligate cDNA to vectors during the construction of cDNA libraries. The recessed 3' termini of an *XhoI* cloning site on the vector are partially filled, and phosphorylated adaptors with 3-base protruding termini complementary to the partially filled *XhoI* site are attached to the cDNA. Neither the vector nor the cDNA molecules can anneal to themselves, but they can join to one another. Because the *XhoI* site is regenerated, the cloned cDNA can be recovered by digestion with *XhoI*. This strategy greatly improves the efficiency of the ligation step in cDNA cloning and eliminates the need to methylate the cDNA or to digest it with restriction enzymes before insertion into the vector (Yang et al. 1986; Elledge et al. 1991).

Alternatively, PCR can be used to add a desired restriction site or sites at the 5' and 3' ends of a fragment of amplified DNA by simply incorporating the recognition sequence at the 5' ends of the oligonucleotide primers. In many cases, the target DNA can be cloned into one restriction site in a polylinker and then excised by digestion with another restriction enzyme or combination of enzymes. For routine subcloning, this is often the method of choice because the target DNA can be inserted into a polylinker that contains several useful flanking restriction sites. However, a polylinker is not always available that carries the desired restriction site in an appropriate location. This problem can be solved by using an adaptor with the appropriate length of "spacer" between the protruding terminus and the internal restriction site. Adaptors therefore simplify the task of creating genes that efficiently express fusion proteins because they allow the target DNA, free of potentially deleterious flanking sequences, to be inserted in-frame into the desired expression vector.

**TABLE 1-13 Adaptor Sequences**

<i>EcoRI-NotI</i>	5' AATTCGCGGCCGC 3' 3' GCGCCGGCG 5'
<i>BamHI-SmaI</i>	5' GATCCCCCGGG 3' 3' GGGGCC 5'
<i>EcoRI-SmaI</i>	5' AATCCCCCGGG 3' 3' GGGGCC 5'
<i>Sall-SmaI</i>	5' TCGACCCCGGG 3' 3' GGGGCC 5'
<i>HindIII-SmaI</i>	5' AGCTTCCCGGG 3' 3' AGGGCC 5'
<i>BamHI-PstI</i>	5' GATCCCTGCAG 3' 3' GGACGTC 5'
<i>EcoRI-EcoRI</i>	5' AATTCGAATTC 3' 3' GCTTAAG 5'
<i>EcoRI-XhoI</i>	5' AATTCGGCTCGAG 3' 3' GCCGAGCTC 5'
<i>XhoIII-EcoRI</i>	5' AGCTTGAATTC 3' 3' ACTTAAG 5'
<i>XhoI-EcoRI</i>	5' TCGAGGAATTC 3' 3' CCTTAAG 5'
<i>BamHI-EcoRI</i>	5' GATCCGAATTC 3' 3' GCTTAAG 5'
<i>Sall-NotI</i>	5' TCGACGCGGCCGC 3' 3' GCGCCGGCG 5'
<i>HindIII-NotI</i>	5' AGCTTGCGGCCGC 3' 3' ACGCCGGCG 5'
<i>XhoI-NotI</i>	5' TCGAGGCGGCCGC 3' 3' CCGCCGGCG 5'
<i>Sall-XhoI</i>	5' TCGACCTCGAG 3' 3' GGAGCTC 5'

Modified with permission, © 1999 Stratagene.

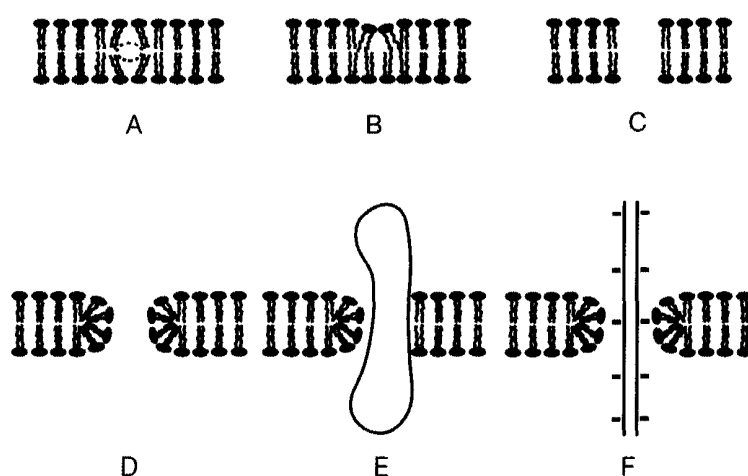
**ELECTROPORATION**

The application of a sharp pulse of electricity is thought to cause dimpling of membranes followed by formation of transient hydrophobic pores whose diameter fluctuates from a minimum of 2 nm to a maximum of several nm. Some of the larger hydrophobic pores are converted to hydrophilic pores because the energy needed to create and maintain a hydrophilic pore is reduced as the transmembrane voltage is increased (Weaver 1993). Reclosing of pores seems to be a stochastic process that can be delayed by keeping the cells at low temperature. While the pores remain open, DNA molecules can easily pass from the medium into the cytoplasm (please see Figure 1-18).

The transmembrane voltage required for formation of large hydrophobic pores varies in direct proportion to the diameter of the target cell. Most manufacturers of electroporation machines provide literature describing the approximate voltages required for transfection of specific cell types in their particular apparatus. Three important parameters of the pulse affect the efficiency of electroporation:

- *Length* of pulse is determined mainly by the value of the capacitor and the conductivity of the medium. Most commercial electroporation machines use capacitive discharge to produce controlled pulses.
- *Field strength* varies in direct proportion to the applied voltage and in inverse proportion to the distance between the electrodes. Most manufacturers provide cuvettes of various sizes to suit the task at hand and recommend that the cuvettes be used only once. However, many investigators, in an effort to reduce costs, wash and re-use the cuvettes several times. The wisdom of this practice is a topic of ongoing debate (e.g., please see Hengen 1995).
- *Shape* is determined by the design of the electroporation device. The wave form produced by most commercial machines is simply the exponential decay pattern of a discharging capacitor (Dower et al. 1988).

For most commonly used strains of *E. coli*, maximum rates of transformation are achieved after a single electrical pulse with a field strength of 12.5–15 kV cm<sup>-1</sup> and a length of 4.5–5.5 milliseconds. Under these conditions, ~50% of the cells survive.



**FIGURE 1-18 Changes in the Membrane during Electroporation**

Drawings of hypothetical structures for transient and metastable membrane conformations believed to be relevant to electroporation. (A) Fredd volume fluctuation; (B) aqueous protrusion or "dimple"; (C,D) hydrophobic pores usually regarded as the "primary pores" through which ions and molecules pass; (E) composite pore with "foot in the door" charged macromolecule inserted into a hydrophilic pore. The transient aqueous pore model assumes that transitions from A→B→C or D occur with increasing frequency as U is increased. Type F may form by entry of a tethered macromolecule, while the transmembrane voltage is significantly elevated, and then persist after U has decayed to a small value through pore conduction. It is emphasized that these hypothetical structures have not been directly observed and that support for them derives from the interpretation of a variety of experiments involving electrical, optical, mechanical, and molecular transport behavior. (Reprinted, with permission, from Weaver 1993 [copyright Wiley-Liss, Inc.]

## REFERENCES

- Abraham E.P. and Chain E. 1940. An enzyme from bacteria able to destroy penicillin. *Nature* **146**: 837.
- Ahmed A. 1984. Plasmid vectors for positive galactose-resistance selection of cloned DNA in *Escherichia coli*. *Gene* **28**: 37–43.
- Armstrong J., Brown R.S., and Tsugita A. 1983. Primary structure and genetic organization of phage T4 DNA ligase. *Nucleic Acids Res.* **11**: 7145–7156.
- Bachmann B.J. 1990. Linkage map of *Escherichia coli* K-12, edition 8 (erratum *Microbiol. Rev.* [1991] **55**: 191). *Microbiol. Rev.* **54**: 130–197.
- Balbas P., Soberón X., Merino E., Zurita M., Lomeli H., Valle F., Flores N., and Bolívar F. 1986. Plasmid vector pBR322 and its special purpose derivatives—A review. *Gene* **50**: 3–40.
- Banner D.W., Kokkindis M., and Tsernoglou D. 1987. Structure of the ColE1 Rop protein at 1.7Å resolution. *J. Mol. Biol.* **196**: 657–675.
- Barany F. 1991a. Genetic disease detection and DNA amplification using cloned thermostable ligase. *Proc. Natl. Acad. Sci.* **88**: 189–193.
- . 1991b. The ligase chain reaction in a PCR world (erratum *PCR Methods Appl.* [1991] **1**: 149). *PCR Methods Appl.* **1**: 5–16.
- Barany F. and Gelfand D.H. 1991. Cloning, overexpression and nucleotide sequence of a thermostable DNA ligase-encoding gene. *Gene* **109**: 1–11.
- Barker D.G., White J.H., and Johnston L.H. 1985. The nucleotide sequence of the DNA ligase gene (CDC9) from *Saccharomyces cerevisiae*: A gene which is cell-cycle regulated and induced in response to DNA damage. *Nucleic Acids Res.* **13**: 8323–8337.
- Barkley M.D. and Bourgeois S. 1978. Repressor recognition of operator and effectors. In *The operon* (ed. J.H. Miller and W.S. Reznikoff), pp. 177–220. Cold Spring Harbor Laboratory, Cold Spring Harbor, New York.
- Barlow J.J., Mathias A.P., Williamson R., and Gammack D.B. 1963. A simple method for quantitative isolation of undegraded high molecular weight ribonucleic acid. *Biochem. Biophys. Res. Commun.* **13**: 61–66.
- Barnes W.M. 1977. Plasmid detection and sizing in single colony lysates. *Science* **195**: 393–394.
- Barringer K.J., Orgel L., Wahl G., and Gingeras T.R. 1990. Blunt-end and single-strand ligations by *Escherichia coli* ligase: Influence on an in vitro amplification scheme. *Gene* **89**: 117–122.
- Bauer W. and Vinograd J. 1968. The interaction of closed circular DNA with intercalative dyes. I. The superhelix density of SV-40 DNA in the presence and absence of dye. *J. Mol. Biol.* **33**: 141–171.
- . 1970. Interaction of closed circular DNA with intercalative dyes. II. The free energy of superhelix formation in SV-40 DNA. *J. Mol. Biol.* **47**: 419–435.
- . 1971. The use of intercalative dyes in the study of closed circular DNA. *Progr. Mol. Subcell. Biol.* **2**: 181–215.
- Bazalari M. and Helinski D.R. 1968. Circular DNA forms of colicinogenic factors E1, E2 and E3 from *Escherichia coli*. *J. Mol. Biol.* **36**: 185–194.
- Beck E. and Bremer E. 1980. Nucleotide sequence of the gene *ompA* coding the outer membrane protein II of *Escherichia coli* K-12. *Nucleic Acids Res.* **8**: 3011–3027.
- Becker A., Lyn G., Gefter M., and Hurwitz J. 1967. The enzymatic repair of DNA. II. Characterization of phage-induced sealase. *Proc. Natl. Acad. Sci.* **58**: 1996–2003.
- Bedbrook J.R., Lehrach H., and Ausubel F.M. 1979. Directive segregation in the basis of ColE1 plasmid incompatibility. *Nature* **281**: 447–452.
- Bercovich J.A., Grinstein S., and Zorzopulos J. 1992. Effect of DNA concentration of recombinant plasmid recovery after blunt-end ligation. *BioTechniques* **12**: 190–193.
- Bernard P. 1995. New *cadB* positive-selection cloning vectors with kanamycin or chloramphenicol selectable markers. *Gene* **162**: 159–160.
- . 1996. Positive selection of recombinant DNA by *CadB*. *BioTechniques* **21**: 320–323.
- Birnboim H.C. and Doly J. 1979. A rapid alkaline procedure for screening recombinant plasmid DNA. *Nucleic Acids Res.* **7**: 1513–1523.
- Bittner M. and Vapnek D. 1981. Versatile cloning vectors derived from the runaway-replication plasmid pKN402. *Gene* **15**: 319–329.
- Blake C.C.F., Johnson L.N., Mair G.A., North A.C.T., Phillips D.C., and Sarma V.R. 1967. Crystallographic studies of the activity of hen egg-white lysozyme. *Proc. R. Soc. Lond. B Biol. Sci.* **167**: 378–388.
- Bochner B., Huang H., Schiever G., and Ames B. 1980. Positive selection for loss of tetracycline resistance. *J. Bacteriol.* **143**: 926–933.
- Bolívar F., Rodríguez R.L., Betlach M.C., and Boyer H.W. 1977a. Construction and characterization of new cloning vehicles. I. Ampicillin-resistant derivatives of plasmid pMB9. *Gene* **2**: 75–93.
- Bolívar F., Rodríguez R.L., Green P.J., Betlach M.C., Heyneker H.L., Boyer H.W., Crosa J.H., and Falkow S. 1977b. Construction and characterization of new cloning vehicles. II. A multipurpose cloning system. *Gene* **2**: 95–113.
- Boyle J.S. and Lew A.M. 1995. An inexpensive alternative to glass-milk for DNA purification. *Trends Genet.* **11**: 8.
- Brendel V. and Perelson A.S. 1993. Quantitative model of ColE1 plasmid number copy control. *J. Mol. Biol.* **229**: 860–872.
- Brosius J. 1992. Compilation of superlinker vectors. *Methods Enzymol.* **216**: 469–483.
- Brunk C.F. and Simpson L. 1977. Comparison of various ultraviolet sources for fluorescent detection of ethidium bromide-DNA complexes in polyacrylamide gels. *Anal. Biochem.* **82**: 455–462.
- Burns D.M. and Beacham I.R. 1984. Positive selection vectors: A small plasmid vector useful for the direct selection of *Sau3A*-generated overlapping DNA fragments. *Gene* **27**: 323–325.
- Bush K. and Sykes R.B. 1984. Interaction of  $\beta$ -lactam antibiotics with  $\beta$ -lactamases as a cause for resistance. In *Antimicrobial drug resistance* (ed. L.E. Bryan), pp. 1–31. Academic Press, New York.
- Cameron J.R., Panasenko S.M., Lehman I.R., and Davis R.W. 1975. In vitro construction of bacteriophage lambda carrying segments of the *Escherichia coli* chromosome: Selection of hybrids containing the gene for DNA ligase. *Proc. Natl. Acad. Sci.* **72**: 3416–3420.
- Cantor C.R. and Schimmel P.R. 1980. *Biophysical chemistry*. Part III. *The behavior of biological macromolecules*, p. 1251. W.H. Freeman, San Francisco, California.
- Carter M.J. and Milton I.D. 1993. An inexpensive and simple

- method for DNA purification on silica particles. *Nucleic Acids Res.* **21**: 1044.
- Cesareni G., Helmer-Citterich M., and Castagnoli L. 1991. Control of ColE1 plasmid replication by antisense RNA. *Trends Genet.* **7**: 230–235.
- Chan P.T., Ohmori H., Tomizawa J.-I., and Lebowitz J. 1984. Nucleotide sequence and gene organization of ColE1 DNA. *J. Biol. Chem.* **260**: 8925–8935.
- Chang A.C.Y. and Cohen S.N. 1978. Construction and characterization of amplifiable multicopy DNA cloning vehicles derived from the p15A cryptic miniplasmid. *J. Bacteriol.* **134**: 1141–1156.
- Chassy B.M. and Flickinger J.L. 1987. Transformation of *Lactobacillus casei* by electroporation. *FEMS Microbiol. Lett.* **44**: 173–177.
- Chassy B.M., Mercenier A., and Flickinger J. 1988. Transformation of bacteria by electroporation. *Trends Biotechnol.* **6**: 303–309.
- Chen X.J. and Fukuhara H. 1988. A gene fusion system using the aminoglycoside 3'-phosphotransferase gene of the kanamycin-resistance transposon Tn903: Use in the yeast *Kluyveromyces lactis* and *Saccharomyces cerevisiae*. *Gene* **69**: 181–192.
- Cheng S. and Modrich P. 1983. Positive selection cloning vehicle useful for overproduction of hybrid proteins. *J. Bacteriol.* **154**: 1005–1008.
- Chiang C.-S. and Bremer H. 1991. Maintenance of pBR322-derived plasmids without functional RNAI. *Plasmid* **26**: 186–200.
- Chopra I. 1985. Mode of action of the tetracyclines and the nature of bacterial resistance to them. In *The tetracyclines* (ed. J.J. Hlavka and J.H. Boothe), pp. 317–392. Springer-Verlag, Berlin, Germany.
- Chopra I., Hawkey P.M., and Hinton M. 1992. Tetracyclines, molecular and clinical aspects. *J. Antimicrob. Chemother.* **29**: 245–277.
- Claverie-Martin F., Diaz-Torres M.R., Yacey S.D., and Kushner S.R. 1989. Cloning of the altered mRNA stability (*ams*) gene of *Escherichia coli* K-12. *J. Bacteriol.* **171**: 5479–5486.
- Clewell D.B. 1972. Nature of ColE1 plasmid replication in *Escherichia coli* in the presence of chloramphenicol. *J. Bacteriol.* **110**: 667–676.
- Clewell D.B. and Helinski D.R. 1969. Supercoiled circular DNA-protein complex in *Escherichia coli*: Purification and induced conversion to an open circular form. *Proc. Natl. Acad. Sci.* **62**: 1159–1166.
- Cohen A. and Clark A.J. 1986. Synthesis of linear plasmid multimers in *Escherichia coli* K-12. *J. Bacteriol.* **167**: 327–335.
- Cohen S.N., Chang A.C.Y., and Hsu L. 1972. Nonchromosomal antibiotic resistance in bacteria: Genetic transformation of *Escherichia coli* by R-factor DNA. *Proc. Natl. Acad. Sci.* **69**: 2110–2114.
- Cohen S.N., Chang A.C.Y., Boyer H.W., and Helling R.B. 1973. Construction of biologically functional bacterial plasmids *in vitro*. *Proc. Natl. Acad. Sci.* **73**: 3240–3244.
- Colbère-Garapin F., Horodniceanu F., Kourilsky P., and Garapin A.C. 1981. A new dominant hybrid selective marker for higher eukaryotic cells. *J. Mol. Biol.* **150**: 1–14.
- Collins J. 1981. Instability of palindromic DNA in *Escherichia coli*. *Cold Spring Harbor Symp. Quant. Biol.* **45**: 409–416.
- Collins J. and Hohn B. 1978. Cosmids: A type of plasmid gene-cloning vector that is packageable *in vitro* in bacteriophage lambda heads. *Proc. Natl. Acad. Sci.* **75**: 4242–4246.
- Colloms S.D., Sykora P., Szatmari G., and Sherratt D.J. 1990. Recombination at ColE1 *cer* requires the *Escherichia coli* XerC gene product, a member of the lambda integrase family of site specific recombinases. *J. Bacteriol.* **172**: 6973–6980.
- Conley D.L. and Cohen S.N. 1995. Effects of the pSC101 partition (*par*) locus on *in vivo* DNA supercoiling near the plasmid replication origin. *Nucleic Acids Res.* **23**: 701–707.
- Covarrubias L., Cervantes L., Covarrubias A., Soberón X., Vichido I., Blanco A., Kupersztoch-Portnoy Y.M., and Bolivar F. 1981. Construction and characterization of new cloning vehicles. V. Mobilization and coding properties of pBR322 and several deletion derivatives, including pBR327 and pBR328. *Gene* **13**: 25–35.
- Covey C., Richardson D., and Carbon J. 1976. A method for the deletion of restriction sites in bacterial plasmid deoxyribonucleic acid. *Mol. Gen. Genet.* **145**: 155–158.
- Cozzarelli N.R., Kelly R.B., and Kornberg A. 1968. A minute circular DNA from *Escherichia coli* 15. *Proc. Natl. Acad. Sci.* **60**: 992–999.
- Cozzarelli N.R., Melechen N.E., Jovin T.M., and Kornberg A. 1967. Polynucleotide cellulose as a substrate for a polynucleotide ligase induced by phage T4. *Biochem. Biophys. Res. Commun.* **28**: 578–586.
- Craine B.L. 1982. Novel selection for tetracycline- or chloramphenicol-sensitive *Escherichia coli*. *J. Bacteriol.* **151**: 487–490.
- Crawford L.V. and Waring M.J. 1967. Supercoiling of polyoma virus DNA measured by its interaction with ethidium bromide. *J. Mol. Biol.* **25**: 23–30.
- Cundliffe E. 1990. Recognition sites for antibiotics within rRNA. In *The ribosome: Structure, function, and evolution* (ed. W.E. Hill et al.), pp. 479–490. American Society for Microbiology, Washington, D.C.
- Dagert M. and Ehrlich S.D. 1979. Prolonged incubation in calcium chloride improves the competence of *Escherichia coli* cells. *Gene* **6**: 23–28.
- Damag S. and Bullock D.W. 1993. A simple two-step method for efficient blunt-end ligation of DNA fragments. *BioTechniques* **15**: 448–452.
- Datta N. and Kontomichalou P. 1965. Penicillinase synthesis controlled by infectious R factors in *Enterobacteriaceae*. *Nature* **208**: 239–241.
- Davies J. 1990. What are antibiotics? Archaic functions for modern activities. *Mol. Microbiol.* **4**: 1227–1232.
- Davies J. and Jacob F. 1968. Genetic mapping of the regulator and operator genes of the lac operon. *J. Mol. Biol.* **36**: 413–417.
- Davies J. and Smith D.I. 1978. Plasmid-determined resistance to antimicrobial agents. *Annu. Rev. Microbiol.* **32**: 469–518.
- Davison J. 1984. Mechanism of control of DNA replication and incompatibility in ColE1-type plasmids—A review. *Gene* **28**: 1–15.
- Denhardt D.T. 1966. A membrane-filter technique for the detection of complementary DNA. *Biochem. Biophys. Res. Commun.* **23**: 641–646.
- Doherty J.P., Lindeman R., Trent R.J., Graham M.W., and Woodcock D.M. 1993. *Escherichia coli* host strains SURE and SRB fail to preserve a palindrome cloned in lambda phage: Improved alternate host strains. *Gene* **124**: 29–35.
- Donowitz G.R. and Mandell G.L. 1988. beta-lactam antibiotics. *N. Engl. J. Med.* **318**: 419–426 and 490–500.
- Dorin M. and Bornecque C.A. 1995. Fast separations of plasmid DNA using discontinuous gradients in the preparative ultracentrifuge. *BioTechniques* **18**: 90–91.
- Dower W.J., Miller J.F., and Ragsdale C.W. 1988. High efficiency transformation of *E. coli* by high voltage electroporation. *Nucleic Acids Res.* **16**: 6127–6145.

- Drainas D., Kalpaxis D.L., and Coutsogeorgopoulos C. 1987. Inhibition of ribosomal peptidyltransferase by chloramphenicol. Kinetic studies. *Eur. J. Biochem.* **164**: 53–58.
- Dugaiczky A., Boyer H.W., and Goodman H.M. 1975. Ligation of *Eco*RI endonuclease-generated DNA fragments into linear and circular structures. *J. Mol. Biol.* **96**: 171–184.
- Eguchi Y. and Tomizawa J. 1990. Complex formed by complementary RNA stem-loops and its stabilization by a protein: Function of ColE1 Rom protein. *Cell* **60**: 199–209.
- Eguchi Y., Itoh T., and Tomizawa J. 1991. Antisense RNA. *Annu. Rev. Biochem.* **60**: 631–652.
- Ehrlich S.D., Sgaramella V., and Lederberg J. 1977. T4 ligase joins flush-ended DNA duplexes generated by restriction endonucleases. In *Nucleic acid-protein recognition* (ed. H.J. Vogel), pp. 261–268. Academic Press, New York.
- Ehrlich J., Bartz Q.R., Smith R.M., Joslyn D.A., and Burkholder P.R. 1947. Chloromycetin, a new antibiotic from a soil actinomycete. *Science* **106**: 417.
- Elledge S.J., Mulligan J.T., Ramer S.W., Spottswood M., and Davis R.W. 1991.  $\lambda$ YES: A multifunctional cDNA expression vector for the isolation of genes by complementation of yeast and *Escherichia coli* mutations. *Proc. Natl. Acad. Sci.* **88**: 1731–1735.
- Ellis J., Carlin A., Steffes C., Wu J., Liu J., and Rosen B.P. 1995. Topological analysis of the lysine-specific permease of *Escherichia coli*. *Microbiology* **141**: 1927–1935.
- Elvin S. and Bingham A.H.A. 1991. Electroporation-induced transformation of *Escherichia coli*: Evaluation of a square waveform pulse. *Lett. Appl. Microbiol.* **12**: 39–42.
- Engler M.J. and Richardson C.C. 1982. DNA ligases. In *The enzymes* (ed. P.D. Boyer), vol. 15, pp. 3–29. Academic Press, New York.
- Fareed G.C., Wilt E.M., and Richardson C.C. 1971. Enzymatic breakage and joining of deoxyribonucleic acid. 8. Hybrids of ribo- and deoxyribonucleotide homopolymers as substrates for polynucleotide ligase of bacteriophage T4. *J. Biol. Chem.* **246**: 925–932.
- Ferretti L. and Sgaramella V. 1981. Temperature dependence of the joining by T4 DNA ligase of termini produced by type II restriction endonucleases. *Nucleic Acids Res.* **9**: 85–93.
- Fiedler S. and Wirth R. 1988. Transformation of bacteria with plasmid DNA by electroporation. *Anal. Biochem.* **170**: 38–44.
- Fil N.P., Bendiak D., Collins J., and Friesen J.D. 1979. Expression of *Escherichia coli* ribosomal protein and RNA polymerase genes cloned on plasmids. *Mol. Gen. Genet.* **173**: 39–50.
- Firshein W. and Kim P. 1997. Plasmid replication and partition in *Escherichia coli*: Is the cell membrane the key? *Mol. Microbiol.* **23**: 1–10.
- Fleming A. 1922. On a remarkable bacteriolytic element found in tissues and secretions. *Proc. R. Soc. Lond. B Biol. Sci.* **93**: 306–317.
- Frenkel L. and Bremer H. 1986. Increased amplification of plasmids pBR322 and pBR327 by low concentrations of chloramphenicol. *DNA* **5**: 539–544.
- Freifelder D. 1971. Electron microscopic study of the ethidium bromide-DNA complex. *J. Mol. Biol.* **60**: 401–403.
- Fursh A. 1985. *Enzyme structure and mechanism*, 2nd edition. W.H. Freeman, New York.
- Gale E.F., Cundliffe E., Reynolds P.E., Richmond M.H., and Waring M.J. 1981. Antibiotic inhibitors of ribosome function. In *The molecular basis of antibiotic action*, 2nd edition, pp. 402–408. John Wiley, Chichester, United Kingdom.
- Gergen J.P., Stern R.H., and Wensink P.C. 1979. Filter replicas and permanent collections of recombinant DNA plasmids. *Nucleic Acids Res.* **7**: 2115–2136.
- Gillespie D. and Spiegelman S. 1965. A quantitative assay for DNA-RNA hybrids with DNA immobilized on a membrane. *J. Mol. Biol.* **12**: 829–842.
- Giza P.E. and Huang R.C. 1989. A self-inducing runaway-replication plasmid expression system utilizing the Rop protein. *Gene* **78**: 73–84.
- Glišin V., Crkvenjakov R., and Byus C. 1974. Ribonucleic acid isolated by cesium chloride centrifugation. *Biochemistry* **13**: 2633–2637.
- Godson G.N. and Vapnek D. 1973. A simple method of preparing large amounts of  $\phi$ X174 RFI supercoiled DNA. *Biochim. Biophys. Acta* **299**: 516–520.
- Goffin C., Bailly V., and Verly W.G. 1987. Nicks 3' or 5' to AP sites or to mispaired bases, and one-nucleotide gaps can be sealed by T4 DNA ligase. *Nucleic Acids Res.* **15**: 8755–8771.
- Gómez-Márquez J., Friere M., and Segade F. 1987. A simple procedure for the large-scale purification of plasmid DNA. *Gene* **54**: 255–259.
- Good L. and Nazar R.N. 1995. Visualization of CsCl/EtdBr plasmid preparations under visible light. *BioTechniques* **18**: 556–557.
- Gottesman M.M. 1976. Isolation and characterization of a lambda specialized transducing phage for the *Escherichia coli* DNA ligase gene. *Virology* **72**: 33–44.
- Gottesman M.M., Hicks M.L., and Gellert M. 1973. Genetics and function of DNA ligase in *Escherichia coli*. *J. Mol. Biol.* **77**: 531–547.
- Griffith J.K., Cuellar D.H., Fordyce C.A., Hutchings K.G., and Mondragon A.A. 1994. Structure and function of the class C tetracycline/H<sup>+</sup> antiporter: Three independent groups of phenotypes are conferred by TetA $\chi$ . *Mol. Membr. Biol.* **11**: 271–277.
- Grunstein M. and Hogness D.S. 1975. Colony hybridization: A method for the isolation of cloned DNAs that contain a specific gene. *Proc. Natl. Acad. Sci.* **72**: 3961–3965.
- Gumport R.I. and Lehman I.R. 1971. Structure of the DNA ligase-adenylate intermediate: Lysine (epsilon-amino)-linked adenosine monophosphoramidate. *Proc. Natl. Acad. Sci.* **68**: 2559–2563.
- Hagan C.E. and Warren G.J. 1983. Viability of palindromic DNA is restored by deletions occurring at low but variable frequency in plasmids of *E. coli*. *Gene* **24**: 317–326.
- Hanahan D. 1983. Studies on transformation of *Escherichia coli* with plasmids. *J. Mol. Biol.* **166**: 557–580.
- . 1985. Techniques for transformation of *E. coli*. In *DNA cloning: A practical approach* (ed. D.M. Glover), vol. 1, pp. 109–135. IRL Press, Oxford, United Kingdom.
- . 1987. Mechanisms of DNA transformation. In *Escherichia coli and Salmonella typhimurium: Cellular and molecular biology* (ed. F.C. Neidhardt et al.), vol. 2, pp. 1177–1183. American Society for Microbiology, Washington, D.C.
- Hanahan D. and Bloom F.R. 1996. Mechanisms of DNA transformation. In *Escherichia coli and Salmonella: Cellular and molecular biology*, 2nd edition (ed. F.C. Neidhardt et al.), vol. 2, pp. 2449–2459. American Society for Microbiology, Washington, D.C.
- Hanahan D. and Meselson M. 1980. Plasmid screening at high colony density. *Gene* **10**: 63–67.
- . 1983. Plasmid screening at high colony density. *Methods Enzymol.* **100**: 333–342.
- Hanahan D., Jessec J., and Bloom F.R. 1991. Plasmid transforma-

- tion of *E. coli* and other bacteria. *Methods Enzymol.* **204**: 63–113.
- \_\_\_\_\_. 1995. Techniques for transformation of *E. coli*. In *DNA cloning: A practical approach*, 2nd edition. *Core techniques* (ed. D.M. Glover and B.D. Hames), vol. 1, pp. 1–36. IRL Press, Oxford, United Kingdom.
- Hansen E.G. and von Meyenberg K. 1979. Characterization of the *dnaA*, *gyrB* and other genes in the *dnaA* region of the *Escherichia coli* chromosome on specialized transducing phages  $\lambda$ tna. *Mol. Gen. Genet.* **175**: 135–144.
- Hayashi K., Nakazawa M., Ishizaki Y., and Obayashi A. 1985a. Influence of monovalent cations on the activity of T4 DNA ligase in the presence of polyethylene glycol. *Nucleic Acids Res.* **13**: 3261–3271.
- Hayashi K., Nakazawa M., Ishizaki Y., Hiraoka N., and Obayashi A. 1985b. Stimulation of intermolecular ligation with *E. coli* DNA ligase by high concentrations of monovalent cations in polyethylene glycol solutions. *Nucleic Acids Res.* **13**: 7979–7992.
- Hayes W. 1969. Introduction: What are episomes and plasmids? In *Bacterial episomes and plasmids* (ed. G.E.W. Wolstenholme and M. O'Connor), pp. 4–8. Little, Brown and Co., Boston, Massachusetts.
- He L., Soderbom F., Wagner E.G., Binnie U., Binns N., and Masters M. 1993. PcnB is required for the rapid degradation of RNAI, the antisense RNA that controls the copy number of ColE1-related plasmids. *Mol. Microbiol.* **9**: 1131–1142.
- Hearst J.E. and Vinograd J. 1961a. The net hydration of deoxyribonucleic acid. *Proc. Natl. Acad. Sci.* **47**: 825–830.
- \_\_\_\_\_. 1961b. The net hydration of T-4 bacteriophage deoxyribonucleic acid and the effect of hydration on buoyant behavior in a density gradient at equilibrium in the ultracentrifuge. *Proc. Natl. Acad. Sci.* **47**: 1005–1014.
- Hedgpeth J., Goodman H.M., and Boyer H.W. 1972. DNA nucleotide sequence restricted by the RI endonuclease. *Proc. Natl. Acad. Sci.* **69**: 3448–3452.
- Heitman J. and Model P. 1987. Site-specific methylases induce the SOS repair response in *Escherichia coli*. *J. Bacteriol.* **169**: 3243–3250.
- Helinski D.R., Toukdarian A.E., and Novick R.P. 1996. Replication control and other stable maintenance mechanisms of plasmids. In *Escherichia coli and Salmonella: Cellular and molecular biology*, 2nd edition (ed. F.C. Neidhardt et al.), vol. 2, pp. 2295–2323. American Society for Microbiology, Washington, D.C.
- Helmer-Citterich M., Anceschi M.M., Banner D.W., and Cesareni G. 1988. Control of ColE1 replication: Low affinity specific binding of Rop (Rom) to RNAI and RNAII. *EMBO J.* **7**: 557–566.
- Henderson D.R., Friedman S.B., Harris J.D., Manning W.B., and Zoccoli M.A. 1986. CEDIA, a new homogeneous immunoassay system. *Clin. Chem.* **32**: 1637–1641.
- Hengen P. 1995. Electrotransformation of *Escherichia coli* with plasmid DNA. *Trends Biochem. Sci.* **20**: 248–249.
- \_\_\_\_\_. 1996. Methods and reagents. Preparing ultra-competent *Escherichia coli*. *Trends Biochem. Sci.* **21**: 75–76.
- \_\_\_\_\_. 1997. Methods and reagents. Reducing background colonies with positive selection vectors. *Trends Biochem. Sci.* **22**: 105–106.
- Henrich B. and Plapp R. 1986. Use of the lysis gene of bacteriophage  $\phi$ X174 for the construction of a positive selection vector. *Gene* **42**: 345–349.
- Hershfield V., Boyer H.W., Yanofsky C., Lovett M.A., and Helinski D.R. 1974. Plasmid ColE1 as a molecular vehicle for cloning and amplification of DNA. *Proc. Natl. Acad. Sci.* **71**: 3455–3459.
- Hickman R.K. and Levy S.B. 1988. Evidence that TET protein functions as a multimer in the inner membrane of *Escherichia coli*. *J. Bacteriol.* **170**: 1715–1720.
- Higgins N.P. and Cozzarelli N.R. 1979. DNA-joining enzymes: A review. *Methods Enzymol.* **68**: 50–71.
- Hildeman D.A. and Muller D. 1997. Increased yield of plasmid DNA during removal of CsCl by ethanol precipitation. *BioTechniques* **22**: 878–879.
- Holmes D.S. and Quigley M. 1981. A rapid boiling method for the preparation of bacterial plasmids. *Anal. Biochem.* **114**: 193–197.
- Hooper I.R. 1982. The naturally occurring aminoglycoside antibiotics. In *Aminoglycoside antibiotics* (ed. H. Umezawa and I.R. Hooper), pp. 1–35. Springer-Verlag, Berlin, Germany.
- Hoppe B.L., Conti-Tronconi B.M., and Horton R.M. 1992. Gel-loading dyes compatible with PCR. *BioTechniques* **12**: 679–680.
- Horiuchi T., Sato T., and Nagata T. 1975. DNA degradation in an amber mutant of *Escherichia coli* K12 affecting DNA ligase and viability. *J. Mol. Biol.* **95**: 271–287.
- Horwitz J.P., Chua J., Curby R.J., Tomson A.J., DaRooge M.A., Fisher B.E., Mauricio J., and Klundt I. 1964. Substrates for cytochemical demonstration of enzyme activity. I. Some substituted 3-indolyl- $\beta$ -D-glycopyranosides. *J. Med. Chem.* **7**: 574–575.
- Huang A. and Campbell J. 1993. A simple improvement to the Triton lysis procedure for plasmid isolation. *BioTechniques* **14**: 730.
- Hung M.-C. and Wensink P.C. 1984. Different restriction enzyme-generated sticky DNA ends can be joined in vitro. *Nucleic Acids Res.* **12**: 1863–1874.
- Inoue H., Nojima H., and Okayama H. 1990. High efficiency transformation of *Escherichia coli* with plasmids. *Gene* **96**: 23–28.
- Ish-Horowicz D. and Burke J.F. 1981. Rapid and efficient cosmid cloning. *Nucleic Acids Res.* **9**: 2989–2998.
- Ishino Y., Shinagawa H., Makino K., Tsunasawa S., Sakiyama F., and Nakata A. 1986. Nucleotide sequence of the *lig* gene and primary structure of DNA ligase of *Escherichia coli*. *Mol. Gen. Genet.* **204**: 1–7.
- Jacob F. and Wollman E.L. 1958. Les episomes, elements genetiques ajoutes. *C.R. Acad. Sci.* **247**: 154–156.
- Jacob F., Brenner S., and Cuzin F. 1964. On the regulation of DNA replication in bacteria. *Cold Spring Harbor Symp. Quant. Biol.* **28**: 329–348.
- Jacobson R.H., Zhang X.-J., DuBose R.F., and Matthews B.W. 1994. Three dimensional structure of  $\beta$ -galactosidase from *E. coli*. *Nature* **369**: 761–766.
- Jimenez A. and Davies J. 1980. Expression of a transposable antibiotic resistance element in *Saccharomyces*. *Nature* **287**: 869–871.
- Johnson D.A., Gautsch J.W., Sportsman J.R., and Elder J.H. 1984. Improved technique utilizing nonfat dry milk for analysis of proteins and nucleic acids transferred to nitrocellulose. *Gene Anal. Tech.* **1**: 3–8.
- Jollés P. 1960. Lysozyme. In *The enzymes*, 2nd edition (ed. P.D. Boyer et al.), vol. 4, pp. 431–445. Academic Press, New York.
- Jónsson Z.O., Thorbjarnardóttir S.H., Eggertsson G., and Palsdóttir A. 1994. Sequence of the DNA ligase-encoding gene from *Thermus scotoductus* and conserved motifs in DNA ligases. *Gene* **151**: 177–180.
- Kahn M., Kolter R., Thomas C., Figurski D., Meyer R., Remaut E.,

- and Helinski D.R. 1979. Plasmid cloning vehicles derived from plasmids ColE1, F, R6K, and RK2. *Methods Enzymol.* **68**: 268–280.
- Keesey J. 1996. *Epitope tagging: Basic laboratory methods* (catalog no. 1674773). Boehringer Mannheim, Indianapolis, Indiana.
- Kleppe K., Van de Sande J.H., and Khorana H.G. 1970. Polynucleotide ligase-catalyzed joining of deoxyribo-oligonucleotides on ribopolynucleotide templates and of ribo-oligonucleotides on deoxyribo-polynucleotide templates. *Proc. Natl. Acad. Sci.* **67**: 68–73.
- Kletzin A. 1992. Molecular characterisation of a DNA ligase gene of the extremely thermophilic archaeon *Desulfurolobus ambivalens* shows close phylogenetic relationship to eukaryotic ligases. *Nucleic Acids Res.* **20**: 5389–5396.
- Kolodziej P.A. and Young R.A. 1991. Epitope tagging and protein surveillance. *Methods Enzymol.* **194**: 508–519.
- Kondo T., Mukai M., and Kondo Y. 1991. Rapid isolation of plasmid DNA and LiCl-ethidium bromide treatment and gel filtration. *Anal. Biochem.* **198**: 30–35.
- Kondo T., Nakajima Y., and Kawakami M. 1979. Effect of salts and chromatin concentrations on the buoyant density of chromatin in metrizamide gradient. *Biochim. Biophys. Acta* **561**: 526–534.
- Kornberg A. and Baker T.A. 1992. *DNA replication*, 2nd edition. W.H. Freeman, New York.
- Kües U. and Stahl U. 1989. Replication of plasmids in gram-negative bacteria. *Microbiol. Rev.* **53**: 491–516.
- Kuhn I., Stephenson F.H., Boyer H.W., and Greene P.J. 1986. Positive selection vectors utilizing lethality of the *EcoRI* endonuclease. *Gene* **42**: 253–263.
- Kusano K., Nakayama K., and Nakyama H. 1989. Plasmid-mediated lethality and plasmid multimer formation in an *Escherichia coli* *recBC* *sbcBC* mutant. Involvement of *recF* recombination pathway genes. *J. Mol. Biol.* **209**: 623–634.
- Lacatena R.M. and Cesareni G. 1981. Base pairing of RNAI with its complementary sequence in the primer precursor inhibits ColE1 replication. *Nature* **294**: 623–626.
- Lacatena R.M., Banner D.W., Castagnoli L., and Cesarini G. 1984. Control of pMB1 replication: Purified Rop protein and RNAI affect primer production *in vitro*. *Cell* **37**: 1009–1014.
- Landegren U., Kaiser R., Sanders J., and Hood L. 1988. A ligase-mediated gene detection technique. *Science* **241**: 1077–1080.
- Langley K.E., Villarejo M.R., Fowler A.V., Zamenhof P.J., and Zabin I. 1975. Molecular basis of  $\beta$ -galactosidase  $\alpha$ -complementation. *Proc. Natl. Acad. Sci.* **72**: 1254–1257.
- Lauer G., Rudd E.A., McKay D.L., Ally A., Ally D., and Backman K.C. 1991. Cloning, nucleotide sequence, and engineered expression of *Thermus thermophilus* DNA ligase, a homolog of *Escherichia coli* DNA ligase. *J. Bacteriol.* **173**: 5047–5053.
- Lederberg J. 1952. Cell genetics and hereditary symbiosis. *Physiol. Rev.* **32**: 403–430.
- Lehman I.R. 1974. DNA ligase: Structure, mechanism, and function. *Science* **186**: 790–797.
- . 1998. Recollections of a DNA enzymologist. *Protein Sci.* **7**: 1061–1066.
- LePecq J.B. and Paoletti C. 1967. A fluorescent complex between ethidium bromide and nucleic acids. Physical-chemical characterization. *J. Mol. Biol.* **27**: 87–106.
- Lerman L.S. 1961. Structural considerations in interaction of DNA and acridines. *J. Mol. Biol.* **3**: 18–30.
- Leslie A.G., Moody P.C., and Shaw W.V. 1988. Structure of chloramphenicol acetyltransferase at 1.75Å resolution. *Proc. Natl. Acad. Sci.* **85**: 4133–4137.
- Lilley D.M. 1980. The inverted repeat as a recognizable structural feature in supercoiled DNA molecules. *Proc. Natl. Acad. Sci.* **77**: 6468–6472.
- Lin-Chao S. and Cohen S.N. 1991. The rate of processing and degradation of antisense RNAI regulates the replication of ColE1-type plasmids *in vivo*. *Cell* **65**: 1233–1242.
- Lin-Chao S., Chen W.-T., and Wong T.-T. 1992. High copy number of the pUC plasmid results from a Rom/Rop-suppressible point mutation in RNAII. *Mol. Microbiol.* **6**: 3385–3393.
- Linder P., Churchward G., Xia G.X., Yu Y.Y., and Caro L. 1985. An essential replication gene, *repA*, of plasmid pSC101 is autoregulated. *J. Mol. Biol.* **181**: 383–393.
- Lis J.T. 1980. Fractionation of DNA fragments by polyethylene glycol induced precipitation. *Methods Enzymol.* **65**: 347–353.
- Lis J.T. and Schleif R. 1975a. Size fractionation of double-stranded DNA by precipitation with polyethylene glycol. *Nucleic Acids Res.* **2**: 383–389.
- . 1975b. The regulatory region of the L-arabinose operon: Its isolation on a 1000 base-pair fragment from DNA heteroduplexes. *J. Mol. Biol.* **95**: 409–416.
- Little J.W. 1979. Construction and characterization of a plasmid coding for a fragment of the *Escherichia coli* *recA* protein. *Mol. Gen. Genet.* **177**: 13–22.
- Maas R. 1983. An improved colony hybridization method with significantly increased sensitivity for detection of single genes. *Plasmid* **10**: 296–298.
- Maloy S.R. and Nunn W.D. 1981. Selection for loss of tetracycline resistance by *Escherichia coli*. *J. Bacteriol.* **145**: 1110–1111.
- Mandel M. and Higa A. 1970. Calcium-dependent bacteriophage DNA infection. *J. Mol. Biol.* **53**: 159–162.
- McNicholas P., Chopra I., and Rothstein D.M. 1992. Genetic analysis of the *tetA*(C) gene on plasmid pBR322. *J. Bacteriol.* **174**: 7926–7933.
- Mertz J.E. and Davis R.W. 1972. Cleavage of DNA by R 1 restriction endonuclease generates cohesive ends. *Proc. Natl. Acad. Sci.* **69**: 3370–3374.
- Meselson M., Stahl F.W., and Vinograd J. 1957. Equilibrium sedimentation of macromolecules in density gradients. *Proc. Natl. Acad. Sci.* **43**: 581–588.
- Messing J. 1983. New M13 vectors for cloning. *Methods Enzymol.* **101**: 20–78.
- Miller C.A., Beaucage S.L., and Cohen S.N. 1990. Role of DNA superhelicity in partitioning of the pSC 101 plasmid. *Cell* **62**: 127–133.
- Miller E.M. and Nickoloff J.A. 1995. *Escherichia coli* electrotransformation. *Methods Mol. Biol.* **47**: 105–113.
- Miller J.F., Dower W.J., and Tompkins L.S. 1988. High-voltage electroporation of bacteria: Genetic transformation of *Campylobacter jejuni* with plasmid DNA. *Proc. Natl. Acad. Sci.* **85**: 856–860.
- Miller J.H. 1972. *Experiments in molecular genetics*. Cold Spring Harbor Laboratory, Cold Spring Harbor, New York.
- Mizuuchi K., Mizuuchi M., and Gellert M.J. 1982. Cruciform structures in palindromic DNA are favored by DNA supercoiling. *J. Mol. Biol.* **156**: 229–243.
- Modrich P. and Lehman I.R. 1971. Enzymatic characterization of a mutant of *Escherichia coli* with an altered DNA ligase. *Proc. Natl. Acad. Sci.* **68**: 1002–1005.
- Mongolsuk S., Rabibhadana S., Vattanaviboon P., and Loprasert S. 1994. Generalized and mobilizable positive-selection cloning vectors. *Gene* **143**: 145–146.
- Murray N.E. and Kelley W.S. 1979. Characterization of the *λ*polA transducing phages: Effective expression of the *E. coli* *polA*



- gene. *Mol. Gen. Genet.* **175**: 77–87.
- Neu H.C. 1985. Penicillins. In *Principles and practice of infectious diseases*, 2nd edition (ed. G.L. Mandell et al.), pp. 166–180. Wiley, New York.
- Neumann E. and Rosenheck K. 1972. Permeability changes induced by electric impulses in vesicular membranes. *J. Membr. Biol.* **10**: 279–290.
- Neumann E., Schaefer-Ridder M., Wang Y., and Hofschneider P.H. 1982. Gene transfer into mouse lymphoma cells by electroporation in high electric fields. *EMBO J.* **1**: 841–845.
- Nicoletti V.G. and Condorelli D.F. 1993. Optimized PEG method for rapid plasmid DNA purification: High yield from “midiprep.” *BioTechniques* **14**: 532–534, 536.
- Nilsson B., Uhlen M., Josephson S., Gattenbeck S., and Philipson L. 1983. An improved positive selection vector constructed by oligonucleotide-mediated mutagenesis. *Nucleic Acids Res.* **11**: 8019–8030.
- Noller H.F. 1984. Structure of ribosomal RNA. *Annu. Rev. Biochem.* **53**: 119–162.
- Nordström K. 1990. Control of plasmid replication—How do DNA iterons set the replication frequency? *Cell* **63**: 1121–1124.
- Nordström K. and Uhlin B.E. 1992. Runaway-replication plasmids as tools to produce large quantities of proteins from cloned genes in bacteria. *Bio/Technology* **10**: 661–666.
- Nordström K. and Wagner E.G. 1994. Kinetic aspects of control of plasmid replication by antisense RNA. *Trends Biochem. Sci.* **19**: 294–300.
- Norlander J., Kempe T., and Messing J. 1983. Construction of improved M13 vectors using oligodeoxynucleotide-directed mutagenesis. *Gene* **26**: 101–106.
- Novick R.P. 1987. Plasmid incompatibility. *Microbiol. Rev.* **51**: 381–395.
- Nygaard A.P. and Hall B.D. 1963. A method for the detection of RNA-DNA complexes. *Biochem. Biophys. Res. Commun.* **120**: 98–104.
- Ogata R. and Gilbert W. 1977. Contacts between the lac repressor and the thymines in the lac operator. *Proc. Natl. Acad. Sci.* **74**: 4973–4976.
- Oishi M. and Cosloy S.D. 1972. The genetic and biochemical basis of the transformability of *Escherichia coli* K12. *Biochem. Biophys. Res. Commun.* **49**: 1568–1572.
- Okayama H. and Berg P. 1982. High-efficiency cloning of full-length cDNA. *Mol. Cell. Biol.* **2**: 161–170.
- Olivera B.M. and Lehman I.R. 1967. Diphosphopyridine nucleotide: A cofactor for the polynucleotide-joining enzyme from *Escherichia coli*. *Proc. Natl. Acad. Sci.* **57**: 1700–1704.
- . 1968. Enzymic joining of polynucleotides. 3. The polydeoxyadenylate-polydeoxythymidylate homopolymer pair. *J. Mol. Biol.* **36**: 261–274.
- Paithankar K.R. and Prasad K.S.N. 1991. Precipitation of DNA by polyethylene glycol and ethanol. *Nucleic Acids Res.* **19**: 1346.
- Panasenko S.M., Alazard R.J., and Lehman I.R. 1978. A simple, three-step procedure for the large scale purification of DNA ligase from a hybrid lambda lysogen constructed in vitro. *J. Biol. Chem.* **253**: 4590–4592.
- Panasenko S.M., Cameron J.R., Davis R.W., and Lehman I.R. 1977. Five hundredfold overproduction of DNA ligase after induction of a hybrid lambda lysogen constructed in vitro. *Science* **196**: 188–189.
- Pheiffer B.H. and Zimmerman S.B. 1983. Polymer-stimulated ligation: Enhanced blunt- or cohesive-end ligation of DNA or deoxyribooligonucleotides by T4 DNA ligase in polymer solutions. *Nucleic Acids Res.* **11**: 7853–7871.
- Pierson V.L. and Barcak G.J. 1999. Development of *E. coli* host strains tolerating unstable DNA sequences on ColE1 vectors. *Focus (Life Technologies)* **21**: 18–19.
- Podkovyrov S.M. and Larson T.J. 1995. A new vector-host system for construction of lacZ transcriptional fusions where only low-level gene expression is desirable. *Gene* **156**: 151–152.
- Pohl F.M., Thomae R., and Karst A. 1982. Temperature dependence of the activity of DNA-modifying enzymes: Endonucleases and DNA ligase. *Eur. J. Biochem.* **123**: 141–152.
- Pritchard R.H. 1984. Control of DNA replication in bacteria. In *The microbial cell cycle* (ed. P. Nurse and E. Streiblová), pp. 19–27. CRC Press, Boca Raton, Florida.
- Rae A.J., Kleppe R.K., and Kleppe K. 1975. Kinetics and effect of salts and polyamines on T4 polynucleotide ligase. *Eur. J. Biochem.* **60**: 437–443.
- Radloff R., Bauer W., and Vinograd J. 1967. A dye-buoyant density method for the detection and isolation of closed circular duplex DNA: The closed circular DNA in HeLa cells. *Proc. Natl. Acad. Sci.* **57**: 1514–1521.
- Raleigh E.A. and Wilson G. 1986. *Escherichia coli* K-12 restricts DNA containing 5-methylcytosine. *Proc. Natl. Acad. Sci.* **83**: 9070–9074.
- Rassoulzadegan M., Binetruy B., and Cuzin F. 1982. High frequency of gene transfer after fusion between bacteria and eukaryotic cells. *Nature* **295**: 257–259.
- Remaut E., Tsao H., and Fiers W. 1983. Improved plasmid vectors with a thermoinducible expression and temperature-regulated runaway replication. *Gene* **22**: 103–113.
- Rusche J.R. and Howard-Flanders P. 1985. Hexamine cobalt chloride promotes intermolecular ligation of blunt end DNA fragments by T4 DNA ligase. *Nucleic Acids Res.* **13**: 1997–2008.
- Sambrook J., Fritsch E.F., and Maniatis T. 1989. *Molecular cloning: A laboratory manual*, 2nd edition. Cold Spring Harbor Laboratory Press, Cold Spring Harbor, New York.
- Schaffner W. 1980. Direct transfer of cloned genes from bacteria to mammalian cells. *Proc. Natl. Acad. Sci.* **77**: 2163–2167.
- Scheller R.H., Dickerson R.E., Boyer H.W., Riggs A.D., and Itakura K. 1977. Chemical synthesis of restriction enzyme recognition sites useful for cloning. *Science* **196**: 177–180.
- Schildkraut C., Marmur J., and Doty P. 1962. Determination of base composition of deoxyribonucleic acid from its buoyant density in CsCl. *J. Mol. Biol.* **4**: 430–443.
- Schleef M. and Heimann P. 1993. Cesium chloride or column preparation? An electron microscopical view of plasmid preparations. *BioTechniques* **14**: 544.
- Seeburg P., Shine J., Martial J.A., Baxter J.D., and Goodman H.M. 1977. Nucleotide sequence and amplification in bacteria of structural gene for rat growth hormone. *Nature* **270**: 486–494.
- Sgaramella V. and Ehrlich S.D. 1978. Use of the T4 polynucleotide ligase in the joining of flush-ended DNA segments generated by restriction endonucleases. *Eur. J. Biochem.* **86**: 531–537.
- Sgaramella V. and Khorana H.G. 1972. CXII. Total synthesis of the structural gene for an alanine transfer RNA from yeast. Enzymic joining of the chemically synthesized polydeoxynucleotides to form the DNA duplex representing nucleotide sequence 1 to 20. *J. Mol. Biol.* **72**: 427–444.
- Sgaramella V., Van de Sande J.H., and Khorana H.G. 1970. Studies on polynucleotides. C. A novel joining reaction catalyzed by the T4-polynucleotide ligase. *Proc. Natl. Acad. Sci.* **67**: 1468–1475.

- Sharp P.A., Sugden B., and Sambrook J. 1973. Detection of two restriction endonuclease activities in *Haemophilus influenzae* using analytical agarose-ethidium bromide electrophoresis. *Biochemistry* **12**: 3055–3063.
- Shaw K.J., Rather P.N., Hare R.S., and Miller G.H. 1993. Molecular genetics of aminoglycoside resistance genes and familial relationships of the aminoglycoside-modifying enzymes. *Microbiol. Rev.* **57**: 138–163.
- Shaw W.V. 1983. Chloramphenicol acetyltransferase: Enzymology and molecular biology. *CRC Crit. Rev. Biochem.* **14**: 1–46.
- Shaw W.V., Day P., Lewendon A., and Murray I.A. 1988. Tinkering with antibiotic resistance: Chloramphenicol acetyltransferase and its substrates. *Biochem. Soc. Trans.* **16**: 939–942.
- Shine J. and Dalgarno L. 1975. Determination of cistron specificity in bacterial ribosomes. *Nature* **254**: 34–38.
- Short J.M., Fernandez J.M., Sorge J.A., and Huse W.D. 1988.  $\lambda$ ZAP: A bacteriophage  $\lambda$  expression vector with in vivo excision properties. *Nucleic Acids Res.* **16**: 7583–7600.
- Shuman S. 1996. Closing the gap on DNA ligase. *Structure* **4**: 653–656.
- Smith M., Jessee J., Landers T., and Jordan J. 1990. High efficiency bacterial electroporation of  $1 \times 10^{10}$  *E. coli* transformants per microgram. *Focus (Life Technologies)* **12**: 38–40.
- Southern E.M. 1975. Detection of specific sequences among DNA fragments separated by gel electrophoresis. *J. Mol. Biol.* **98**: 503–517.
- Southern P.J. and Berg P. 1982. Transformation of mammalian cells to antibiotic resistance with a bacterial gene under control of the SV40 early region promoter. *J. Mol. Appl. Genet.* **1**: 327–341.
- Spratt B.G., Boyd A., and Stoker N. 1980. Defective and plaque-forming lambda transducing bacteriophage carrying penicillin-binding protein-cell shape genes: Genetic and physical mapping and identification of gene products from the *lipdAcA-rodA-pbpA-leuS* region of the *Escherichia coli* chromosome. *J. Bacteriol.* **143**: 569–581.
- Steele C., Zhang S., and Shillito E.J. 1994. Effect of different antibiotics on efficiency of transformation of bacteria by electroporation. *BioTechniques* **17**: 360–365.
- Stoker N.G., Fairweather N.F., and Spratt B.G. 1982. Versatile low-copy-number plasmid vectors for cloning in *Escherichia coli*. *Gene* **18**: 335–341.
- Struhl K. 1985. A rapid method for creating recombinant DNA molecules. *BioTechniques* **3**: 452–453.
- Sugino A., Goodman H.M., Heyneker H.L., Shine J., Boyer H.W., and Cazzarelli N.R. 1977. Interaction of bacteriophage T4 RNA and DNA ligases in joining of duplex DNA at base-paired ends. *J. Biol. Chem.* **252**: 3987–3994.
- Summers D.K. and Sherratt D.J. 1984. Multimerization of high copy number plasmids causes instability: ColE1 encodes a determinant for plasmid monomerization and stability. *Cell* **36**: 1097–1103.
- Sutcliffe J.G. 1978. Nucleotide sequence of the ampicillin resistance gene of *Escherichia coli* plasmid pBR322. *Proc. Natl. Acad. Sci.* **75**: 3737–3741.
- Svaren J., Inagami S., Lovegren E., and Chalkley R. 1987. DNA denatures upon drying after ethanol precipitation. *Nucleic Acids Res.* **15**: 8739–8754.
- Tabor S. and Richardson C.C. 1985. A bacteriophage T7 RNA polymerase/promoter system for controlled exclusive expression of specific genes. *Proc. Natl. Acad. Sci.* **82**: 1074–1078.
- Tait R.C., Rodriguez R.L., and West R.W.J. 1980. The rapid purification of T4 DNA ligase from a lambda T4 lig lysogen. *J. Biol. Chem.* **255**: 813–815.
- Takahashi M. and Uchida T. 1986. Thermophilic HB8 DNA ligase: Effects of polyethylene glycols and polyamines on blunt-end ligation of DNA. *J. Biochem.* **100**: 123–131.
- Takahashi M., Yamaguchi E., and Uchida T. 1984. Thermophilic DNA ligase. Purification and properties of the enzyme from *Thermus thermophilus* HB8. *J. Biol. Chem.* **259**: 10041–10047.
- Taketo A. 1988. Sensitivity of *Escherichia coli* to viral nucleic acid. 17. DNA transfection of *Escherichia coli* by electroporation. *Biochim. Biophys. Acta* **949**: 318–324.
- Tang X., Nakata Y., Li H.O., Zhang M., Gao H., Fujita A., Sakatsume O., Ohta T., and Yokoyama K. 1994. The optimization of preparations of competent cells for transformation of *E. coli*. *Nucleic Acids Res.* **22**: 2857–2858.
- Tartof K.D. and Hobbs C.A. 1987. Improved media for growing plasmid and cosmid clones. *Focus (Life Technologies)* **9**: 12.
- Tomasz A. 1986. Penicillin-binding proteins and the antibacterial effectiveness of  $\beta$ -lactam antibiotics. *Rev. Infect. Dis.* (suppl. 3) **8**: S260–S278.
- Tomizawa J. 1985. Control of ColE1 replication: Initial interaction of RNAI and the primer transcript is reversible. *Cell* **40**: 527–535.
- . 1987. Regulation of ColE1 replication by antisense RNA. In *Molecular biology of RNA: New perspectives* (ed. M. Inoue and B. Dudock), pp. 249–259. Academic Press, New York.
- . 1990a. Control of ColE1 plasmid replication. Intermediates in the binding of RNAI and RNAII. *J. Mol. Biol.* **212**: 683–694.
- . 1990b. Control of ColE1 plasmid replication. Interaction of Rom protein with an unstable complex formed by RNAI and RNAII. *J. Mol. Biol.* **212**: 695–708.
- Tomizawa J. and Itoh T. 1981. Plasmid ColE1 incompatibility determined by interaction of RNA I with primer transcript. *Proc. Natl. Acad. Sci.* **78**: 6096–6100.
- Tomizawa J. and Som T. 1984. Control of ColE1 plasmid replication: Enhancement of the binding of RNAI to the primer transcript by the Rom protein. *Cell* **38**: 871–878.
- Tomkinson A.E., Totty N.F., Ginsburg M., and Lindahl T. 1991. Location of the active site for enzyme-adenylate formation in DNA ligases. *Proc. Natl. Acad. Sci.* **88**: 400–404.
- Triglia T., Peterson M.G., and Kemp D.J. 1988. A procedure for in vitro amplification of DNA segments that lie outside the boundaries of known sequences. *Nucleic Acids Res.* **16**: 8186.
- Trudel P., Provost S., Massie B., Chartrand P., and Wall L. 1996. pGATA: A positive selection vector based on the toxicity of the transcription factor GATA-1 to bacteria. *BioTechniques* **20**: 684–693.
- Tsong T.Y. 1991. Electroporation of cell membranes. *Biophys. J.* **60**: 297–306.
- Tung W.L. and Chow K.C. 1995. A modified medium for efficient electrotransformation of *E. coli*. *Trends Genet.* **11**: 128–129.
- Twigg A.J. and Sherratt D. 1980. Trans-complementable copy-number mutants of plasmid ColE1. *Nature* **283**: 216–218.
- Uhlin B.E. and Nordström K. 1978. A runaway-replication mutant of plasmid R1*drd*-19: Temperature-dependent loss of copy number control. *Mol. Gen. Genet.* **165**: 167–179.
- Uhlin B.E., Molin S., Gustaffson P., and Nordström K. 1979. Plasmids with temperature-dependent copy numbers for amplification of cloned genes and their products. *Gene* **6**: 91–106.
- Ullmann A. and Perrin D. 1970. Complementation in  $\beta$ -galactosidase. In *The lactose operon* (ed. J.R. Beckwith and D. Zipser), pp. 143–172. Cold Spring Harbor Laboratory, Cold Spring Harbor, New York.

- Ullmann A., Jacob E., and Monod J. 1967. Characterization by in vitro complementation of a peptide corresponding to an operator-proximal segment of the beta-galactosidase structural gene of *Escherichia coli*. *J. Mol. Biol.* **24**: 339–343.
- Ullrich A., Shine J., Chirgwin J., Pictet R., Tischer E., Rutter W.J., and Goodman H.M. 1977. Rat insulin genes: Construction of plasmids containing the coding sequences. *Science* **196**: 1313–1319.
- Umezawa H., Okanishi M., Utahara R., Maeda K., and Kondo S. 1967. Isolation and structure of kanamycin inactivated by a cell free system of kanamycin-resistant *E. coli*. *J. Antibiot.* **20**: 136–141.
- Uproft P. and Healey A. 1987. Rapid and efficient method for cloning of blunt-ended DNA fragments. *Gene* **51**: 69–75.
- Vernet T., Lau P.C., Narang S.A., and Visentin L.P. 1985. A direct selection vector derived from pColE3-CA38 and adapted for foreign gene expression. *Gene* **34**: 87–93.
- Vieira J. and Messing J. 1982. The pUC plasmids, an M13-mp7-derived system for insertion mutagenesis and sequencing with synthetic universal primers. *Gene* **19**: 259–268.
- . 1987. Production of single-stranded plasmid DNA. *Methods Enzymol.* **153**: 3–11.
- Vinograd J. and Lebowitz J. 1966. Physical and topological properties of circular DNA. *J. Gen. Physiol.* **49**: 103–125.
- von Ahsen U. and Noller H.F. 1993. Footprinting the sites of interaction of antibiotics with catalytic group I intron RNA. *Science* **260**: 1500–1503.
- von Ahsen U., Davies J., and Schroeder R. 1991. Antibiotic inhibition of group I ribozyme function. *Nature* **353**: 368–370.
- . 1992. Non-competitive inhibition of group I intron RNA self-splicing by aminoglycoside antibiotics. *J. Mol. Biol.* **226**: 935–941.
- Wade N. 1977. Dicing with nature: Three narrow escapes. *Science* **195**: 378.
- Waga S., Bauer G., and Stillman B. 1994. Reconstitution of complete SV40 DNA replication with purified replication factors. *J. Biol. Chem.* **269**: 10923–10934.
- Wang J.C. 1969. Variation of the average rotation angle of the DNA helix and the superhelical turns of covalently closed cyclic  $\lambda$  DNA. *J. Mol. Biol.* **43**: 25–39.
- Waring M.J. 1965. Complex formation between ethidium bromide and nucleic acids. *J. Mol. Biol.* **13**: 269–282.
- . 1966. Structural requirements for the binding of ethidium bromide to nucleic acids. *Biochim. Biophys. Acta* **114**: 234–244.
- Watkins T.I. and Wolfe G. 1952. Effect of changing the quaternizing group on the trypanocidal activity of dimidium bromide. *Nature* **169**: 506.
- Weaver J.C. 1993. Electroporation: A general phenomenon for manipulating cells and tissues. *J. Cell. Biochem.* **51**: 426–435.
- Weinstock G.M. 1987. General recombination in *Escherichia coli*. In *Escherichia coli and Salmonella typhimurium: Cellular and molecular biology* (ed. F.C. Neidhardt et al.), vol. 2, pp. 1034–1043. American Society for Microbiology, Washington, D.C.
- Weinstock G.M., Berman M.L., and Silhavy T.J. 1983. Chimeric genetics with  $\beta$ -galactosidase. In *Expression of cloned genes in prokaryotic and eukaryotic cells: Gene amplification and analysis* (ed. T.S. Papas et al.), vol. 3, pp. 27–64. Elsevier, New York.
- Weiss B. and Richardson C.C. 1967. Enzymatic breakage and joining of deoxyribonucleic acid. III. An enzyme-adenylate intermediate in the polynucleotide ligase reaction. *J. Biol. Chem.* **242**: 4270–4272.
- Weiss B., Thompson A., and Richardson C.C. 1968a. Enzymatic breakage and joining of deoxyribonucleic acid. VII. Properties of the enzyme-adenylate intermediate in the polynucleotide ligase reaction. *J. Biol. Chem.* **243**: 4556–4563.
- Weiss B., Jacquemin-Sablon A., Live T.R., Fareed G.C., and Richardson C.C. 1968b. Enzymatic breakage and joining of deoxyribonucleic acid. VI. Further purification and properties of polynucleotide ligase from *Escherichia coli* infected with bacteriophage T4. *J. Biol. Chem.* **243**: 4543–4555.
- Wiaderkiewicz R. and Ruiz-Carrillo A. 1987. Mismatch and blunt to protruding-end joining by DNA ligases. *Nucleic Acids Res.* **15**: 7831–7848.
- Willets N. and Wilkins B. 1984. Processing of plasmid DNA during bacterial conjugation. *Microbiol. Rev.* **48**: 24–41.
- Wilson G.G. and Murray N.E. 1979. Molecular cloning of the DNA ligase gene from bacteriophage T4. I. Characterisation of the recombinants. *J. Mol. Biol.* **132**: 471–491.
- Wu D.Y. and Wallace R.B. 1989. The ligation amplification reaction (LAR)—Amplification of specific DNA sequences using sequential rounds of template-dependent ligation. *Genomics* **4**: 560–569.
- Yamamoto K.R., Alberts B.M., Benzinger R., Lawhorne L., and Treiber G. 1970. Rapid bacteriophage sedimentation in the presence of polyethylene glycol and its application to large-scale virus purification. *Virology* **40**: 734–744.
- Yang Y.C., Ciarletta A.B., Temple P.A., Chung M.P., Kovacic S., Witek-Giannotti J.S., Leary A.C., Kriz R., Donahue R.E., Wong G.G., Clark S., et al. 1986. Human IL-3 (multi-CSF): Identification by expression cloning of a novel hematopoietic growth factor related to murine IL-3. *Cell* **47**: 3–10.
- Yanisch-Perron C., Vieira J., and Messing J. 1985. Improved M13 phage cloning vectors and host strains: Nucleotide sequences of the M13mp18 and pUC19 vectors. *Gene* **33**: 103–119.
- Yazynin S.A., Deyev S.M., Jucovic M., and Hartley R.W. 1996. A plasmid vector with positive selection and directional cloning based on a conditionally lethal gene. *Gene* **169**: 131–132.
- Young I.G. and Poulis M.I. 1978. Conjugal transfer of cloning vectors derived from ColE1. *Gene* **4**: 175–179.
- Zabarovsky E.R. and Allikmets R.L. 1986. An improved technique for the efficient construction of gene libraries by partial filling-in of cohesive ends. *Gene* **42**: 119–123.
- Zabin I. 1982. Beta-galactosidase alpha-complementation. A model of protein-protein interaction. *Mol. Cell. Biochem.* **49**: 87–96.
- Zimmerman S.B. and Minton A.P. 1993. Macromolecular crowding: Biochemical, biophysical and physiological consequences. *Annu. Rev. Biophys. Biomol. Struct.* **22**: 27–65.
- Zimmerman S.B. and Pfeiffer B.H. 1983. Macromolecular crowding allows blunt-end ligation by DNA ligases from rat liver or *Escherichia coli*. *Proc. Natl. Acad. Sci.* **80**: 5852–5856.
- Zimmerman S.B., Little J.W., Oshinsky C.K., and Gellert M. 1967. Enzymatic joining of DNA strands: A novel reaction of diphosphopyridine nucleotide. *Proc. Natl. Acad. Sci.* **57**: 1841–1848.
- Zimmerman U. 1982. Electric field-mediated fusion and related electrical phenomena. *Biochim. Biophys. Acta* **694**: 227–277.
- Zurita M., Bolivar F., and Soberón X. 1984. Construction and characterization of new cloning vehicles. VII. Construction of a plasmid pBR327 $_{par}$ , a completely sequenced, stable derivative of pBR327 containing the  $par$  locus of pSC101. *Gene* **28**: 119–122.

# Chapter 2

## Bacteriophage $\lambda$ and Its Vectors

---

### INTRODUCTION

### PROTOCOLS

1	Plating Bacteriophage $\lambda$	2.25
	• Additional Protocol: Plaque-Assay of Bacteriophages That Express $\beta$ -Galactosidase	2.30
	• Additional Protocol: Macroplaques	2.31
2	Picking Bacteriophage $\lambda$ Plaques	2.32
3	Preparing Stocks of Bacteriophage $\lambda$ by Plate Lysis and Elution	2.34
	• Alternative Protocol: Preparing Stocks of Bacteriophage $\lambda$ by Plate Lysis and Scraping	2.37
4	Preparing Stocks of Bacteriophage $\lambda$ by Small-scale Liquid Culture	2.38
5	Large-scale Growth of Bacteriophage $\lambda$ : Infection at Low Multiplicity	2.40
	• Alternative Protocol: Large-scale Growth of Bacteriophage $\lambda$ : Infection at High Multiplicity	2.42
6	Precipitation of Bacteriophage $\lambda$ Particles from Large-scale Lysates	2.43
7	Assaying the DNA Content of Bacteriophage $\lambda$ Stocks and Lysates by Gel Electrophoresis	2.45
8	Purification of Bacteriophage $\lambda$ Particles by Isopycnic Centrifugation through CsCl Gradients	2.47
	• Alternative Protocol: Purification of Bacteriophage $\lambda$ Particles by Isopycnic Centrifugation through CsCl Equilibration Gradients	2.51
9	Purification of Bacteriophage $\lambda$ Particles by Centrifugation through a Glycerol Step Gradient	2.52
10	Purification of Bacteriophage $\lambda$ Particles by Pelleting/Centrifugation	2.54
11	Extraction of Bacteriophage $\lambda$ DNA from Large-scale Cultures Using Proteinase K and SDS	2.56
12	Extraction of Bacteriophage $\lambda$ DNA from Large-scale Cultures Using Formamide	2.59
13	Preparation of Bacteriophage $\lambda$ DNA Cleaved with a Single Restriction Enzyme for Use as a Cloning Vector	2.61
14	Preparation of Bacteriophage $\lambda$ DNA Cleaved with Two Restriction Enzymes for Use as a Cloning Vector	2.64
15	Alkaline Phosphatase Treatment of Bacteriophage $\lambda$ Vector DNA	2.68

16	Purification of Bacteriophage $\lambda$ Arms: Centrifugation through Sucrose Density Gradients	2.71
17	Partial Digestion of Eukaryotic DNA for Use in Genomic Libraries: Pilot Reactions	2.76
18	Partial Digestion of Eukaryotic DNA for Use in Genomic Libraries: Preparative Reactions	2.80
19	Ligation of Bacteriophage $\lambda$ Arms to Fragments of Foreign Genomic DNA	2.84
20	Amplification of Genomic Libraries	2.87
21	Transfer of Bacteriophage DNA from Plaques to Filters	2.90
	• Alternative Protocol: Rapid Transfer of Plaques to Filters	2.95
22	Hybridization of Bacteriophage DNA on Filters	2.96
23	Rapid Analysis of Bacteriophage $\lambda$ Isolates: Purification of $\lambda$ DNA from Plate Lysates	2.101
	• Additional Protocol: Removing Polysaccharides by Precipitation with CTAB	2.105
24	Rapid Analysis of Bacteriophage $\lambda$ Isolates: Purification of $\lambda$ DNA from Liquid Cultures	2.106

### INFORMATION PANELS

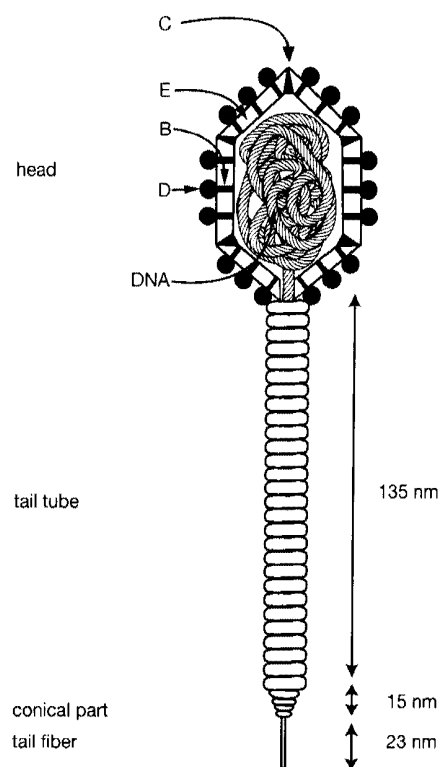
Bacteriophages: Historical Perspective	2.109
Minimizing Damage to Large DNA Molecules	2.110
In Vitro Packaging	2.110

**S**INCE BACTERIOPHAGE  $\lambda$  WAS FIRST USED AS A CLONING VEHICLE in the early 1970s (Murray and Murray 1974; Rambach and Tiollais 1974; Thomas et al. 1974), more than 400 different vectors have been described. Some of these vectors are the direct descendants of field strains of lambdoid bacteriophages; others are far more esoteric (please see the information panel on **BACTERIOPHAGES: HISTORICAL PERSPECTIVE**). This introduction contains information on the genetics and molecular biology of the virus that is required for the investigator to choose wisely among these vectors and to use them effectively.

The word that comes to mind when thinking about  $\lambda$  is elegance. The genetic circuitry of the virus is etched into DNA with great delicacy and the utmost economy. The experiments to trace the filigree of connecting regulatory loops within this circuitry match the virus itself in both beauty and subtlety. The distillation of these findings into a harmonious and general theory of gene control is an intellectual achievement that equals any other in biology in this century. And, as an early phage worker has written, “at each (of these) steps, the situation was aesthetically so pleasant that everybody felt happy with the picture.” (Thomas 1993)

A direct bequest of the store of detailed knowledge and physiology of bacteriophage  $\lambda$  accumulated during the past 40 years has been the development of versatile and sophisticated vectors for the cloning, propagation, and expression of eukaryotic genes.

The genome of wild-type bacteriophage  $\lambda$  is a double-stranded DNA molecule, 48,502 bp in length. Figure 2-1 shows a sketch of the structure of bacteriophage  $\lambda$ . The sequences of the DNAs of two strains of  $\lambda$  are known in their entirety (Sanger et al. 1982; Daniels et al. 1983a,b); partial sequences of many other strains and vectors are scattered throughout various databases. The DNA is carried in bacteriophage particles as a linear double-stranded molecule with single-stranded termini 12 nucleotides in length (cohesive termini or *cos*). Soon after entering a host bacterium, the cohesive termini associate by base pairing to form a circular molecule with two



**FIGURE 2-1 Structure of Bacteriophage  $\lambda$**

The schematic drawing depicts the components of the bacteriophage  $\lambda$  particle. Arrows indicate the locations within the particle of the proteins encoded by genes *C*, *E*, *B*, and *D*.

staggered nicks 12 nucleotides apart (Wu and Taylor 1971; Yarmolinski 1971; Weigel et al. 1973; Nichols and Donelson 1978). These nicks are rapidly sealed by the host's DNA ligase and gyrase to generate a closed circular DNA molecule that serves as the template for transcription during the early, uncommitted phase of infection.

During lytic growth, the circular DNA directs the synthesis of  $\sim 30$  proteins required for its replication, the assembly of bacteriophage particles, and cell lysis. The lytic cycle takes 40–45 minutes and generates  $\sim 100$  infectious virus particles per infected bacterium.

In its lysogenic state, bacteriophage  $\lambda$  DNA is integrated into the bacterial genome, is replicated as part of the bacterial chromosome, and is thus transmitted to progeny bacteria like a chromosomal gene. During establishment of lysogeny, only a small number of  $\lambda$  genes are expressed, including the *cI* gene, which inhibits expression of lytic functions and positively regulates transcription of its own gene, and *int*, which is required for integration of the phage DNA into the bacterial chromosome.

During maintenance of lysogeny, much of the integrated bacteriophage genome is quiescent, with only three genes being transcribed: *rexA*, *rexB*, and *cI*. *rexA* and *rexB* prevent superinfection of  $\lambda$  lysogens by certain other bacteriophages, whereas, as mentioned previously, the *CI* protein blocks transcription of genes required for lytic infection.

## GENOMIC ORGANIZATION

The genome of bacteriophage  $\lambda$  carries a complement of at least 30 genes. The order of many of these genes was originally established by assaying the ability of bacteriophages carrying substitutions and/or deletions to rescue mutations (Kaiser 1955) and by measuring the frequency of genetic recombination between mutants of various types. The recombination frequency between distant

genetic markers is ~15%, whereas the smallest reported recombination frequency (between mutations separated by just 4 bp) is 0.05% (McDermitt et al. 1976; Rosenberg et al. 1978).

Although the order of genes ascertained by these methods was essentially correct, estimates of genetic distances between mutations did not always correspond to the physical distances because of local variation in recombination rates. Measurements of the distances between markers, genes, and mutations became precise only when bacteriophage  $\lambda$  DNA was sequenced (please see Figure 2-2). The genes of bacteriophage  $\lambda$  are organized into functionally related clusters.

- The left-hand region includes genes *Nu1* through *J* whose products are used to package the viral DNA into bacteriophage heads and to assemble infectious virions from filled heads and preformed tails.
- The central region (*J* through *gam*) codes for functions involved in gene regulation, establishment and maintenance of lysogeny, and genetic recombination. Many genes of the central region are not essential for lytic growth and can be sacrificed during construction of bacteriophage  $\lambda$  vectors to make room for segments of foreign DNA.
- The right-hand region (*gam* through *Rz*) contains essential genes used in replication of bacteriophage  $\lambda$  and lysis of infected bacteria.

## THE UNCOMMITTED PHASE OF INFECTION

---

### Adsorption

Bacteriophage  $\lambda$  adsorbs to the trimeric maltoporin receptor, an outer membrane protein consisting of three identical 421-residue monomers, each folded into an 18-strand  $\beta$ -barrel (Thirion and Hofnung 1972; Schwartz 1975; Neuhaus 1982). Adsorption involves interaction between maltoporin receptors and the carboxy-terminal residues of the 1133-residue viral J protein (Werts et al. 1994), which is located at the tip of the tail fiber (Schirmer et al. 1995). All three monomers are involved in binding and adsorption of phage (Marchal and Hofnung 1983). About half of the binding sites are exposed on long peptide loops projecting into the periplasm, whereas the rest are buried at locations where the loops pack together into the  $\beta$ -barrel.

As its name suggests, the maltoporin receptor is normally used to facilitate diffusion of maltose and maltodextrins into the cell (Szmelcman and Hofnung 1975; Ferenci and Boos 1980). Synthesis of these receptors, which are encoded by the bacterial *lamB* gene, is repressed by glucose and induced by maltose (Schwartz 1967). The outer membrane of a fully induced bacterial cell contains  $\sim 5 \times 10^4$  maltoporin receptors.

Infection by bacteriophage  $\lambda$  initially involves formation of reversible phage-receptor complexes that progress to irreversible complexes (Lieb 1953a) when contacts are established between components of the tail fiber and a membrane-bound mannose phosphotransferase encoded by the bacterial gene *ptsM* (Postma 1987). The reversible attachment of the bacteriophage is facilitated by magnesium ions and occurs rapidly (within a few minutes) both at room temperature and at 37°C (Lieb 1953a). The linear viral DNA is then injected into the bacterium, right end first, through the bacteriophage's tail tube (Chattoraj and Inman 1974; Saigo and Uchida 1974; Thomas 1974). However, injection of the viral DNA and the subsequent events in the lytic cycle do not occur efficiently at room temperature (MacKay and Bode 1976). Plaques of bacteriophage  $\lambda$  will, therefore, not form unless bacterial lawns are incubated at temperatures higher than  $\sim 28^\circ\text{C}$ .



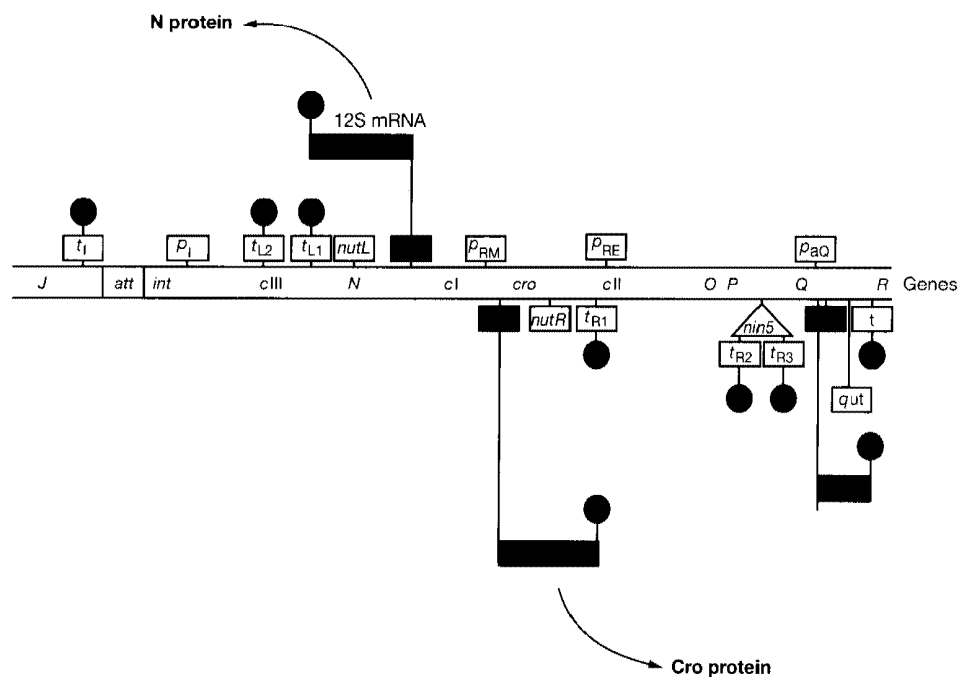


### Immediate Early Transcription

After the linear viral DNA has been converted to a superhelical, covalently closed circle, early transcription is initiated at two divergent promoters,  $p_L$  and  $p_R$ , which are located to the left and right, respectively, of the *cI* (repressor) gene. The resulting “immediate early” RNAs terminate at the ends of the *N* and *cro* genes, at sites  $t_L$  and  $t_{R1}$ , respectively, although ~40% of the rightward transcripts continue through genes *O* and *P* (which encode proteins involved in DNA replication) and terminate at  $t_{R2}$ . Transcription from  $p_L$  and  $p_R$  is carried out by *E. coli* RNA polymerase, whereas termination of RNA synthesis at  $t_L$ ,  $t_{R1}$ , and  $t_{R2}$  is mediated by the *E. coli*-encoded protein  $\rho$  (for review, please see Friedman 1988; Das 1993; Oppenheim et al. 1993). The 12S leftward transcript codes for the N protein (pN), an antiterminator whose action is essential for the next phase of lytic infection.

### Delayed Early Transcription

The delayed early genes of bacteriophage  $\lambda$  flank the immediate early genes *N* and *cro*. Their transcription is dependent on the product of the immediate early gene *N*, which allows the host RNA polymerase to read through the transcriptional terminators  $t_L$  and  $t_{R1}$  into the flanking delayed early genes, *cII* and *cIII*. Because pN is unstable ( $t_{1/2} = 1-2$  minutes) in *lon*<sup>+</sup> bacteria (Gottesman et al. 1981), expression of *cII* and *cIII* requires continued synthesis of the 12S immediate early RNA (please see Figure 2-3). Transcription of *N* from  $p_L$  is negatively controlled by the bacteriophage-encoded repressors CI and Cro and positively controlled by the *E. coli*-encoded RNase III (Oppenheim et al. 1993). In addition, pN may negatively autoregulate its own translation.



**FIGURE 2-3 Bacteriophage  $\lambda$  Immediate Early Transcription**

RNA polymerase binds to three promoters  $p_R$ ,  $p_R'$ , and  $p_L$  and transcribes the DNA until it encounters a  $p$ -dependent termination site (●). The major gene product of leftward transcription is the N protein. The major gene product of rightward transcription is the Cro protein. No protein is synthesized from the small transcript initiated from the  $p_R'$  promoter. (Shaded boxes) The products of transcription.

The specific binding sites for pN, called *nutL* and *nutR* (for *N*-utilization), are embedded in the leftward and rightward immediate early RNAs. Each *nut* site contains a unique hairpin structure called *boxB* to which dimers of pN bind soon after *nut* is transcribed. Full activity of pN, however, requires a set of accessory antitermination factors encoded by the host bacterium: NusA, NusB, NusG, and the ribosomal protein S10 (for reviews, please see Das 1993; Roberts 1993). The pN-*boxB* complex interacts with these factors and the RNA polymerase, allowing the enzyme to elongate nascent RNA chains at an increased rate and to skip through sites of transcriptional pausing.

pN is thus an RNA-binding protein that acts as an operon-specific antiterminator by recognizing a signal in immediate early RNAs and binding to the transcription complex. This binding allows RNA synthesis to proceed through several  $\rho$ -dependent and  $\rho$ -independent terminators. The N protein is therefore a positive regulatory element whose activity is necessary for the lytic growth of bacteriophages carrying  $t_{R2}$ . However, mutants of bacteriophage  $\lambda$  that carry a deletion of  $t_{R2}$  can grow (albeit poorly). Such bacteriophages are known as *nin* (*N*-independent) mutants (Court and Sato 1969). The *nin5* mutation (please see Figures 2-2 and 2-3), which is carried in many bacteriophage  $\lambda$  vectors, is a deletion of 2800 bp between genes *P* and *Q* that removes  $t_{R2}$  and some genes relevant to recombination between plasmids and bacteriophage DNA.

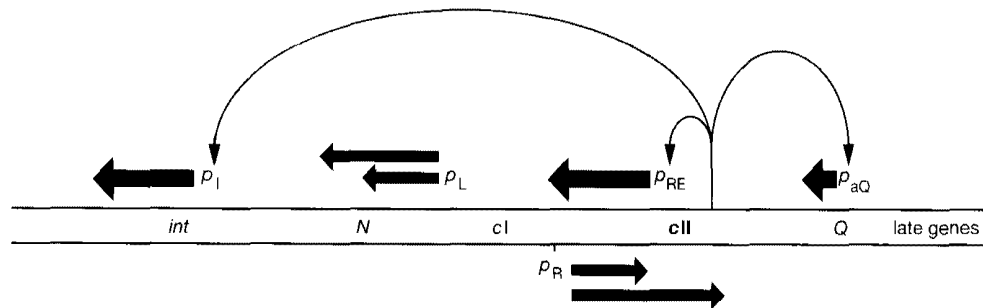
## Infection Reaches an Important Crossroad

The outcome of infection — lysogeny or vegetative growth — remains unresolved until the end of the delayed early phase. By this stage, the bacteriophage proteins required for the next steps in both pathways are present in the infected cells, which are therefore poised to follow either course as circumstances dictate. In wild-type *E. coli*, the decision between lysogeny and the lytic cycle is influenced by the multiplicity of infection and by the nutritional state of the cell. The higher the multiplicity (Boyd 1951; Lieb 1953b) and the worse the nutritional state of cell (Kourilsky 1973; Herskowitz and Hagen 1980), the higher the frequency of lysogenization. The biochemical mediator of lysogeny may be 3'-5' cAMP, whose intracellular concentration alters in response to changes in nutritional conditions (Hong et al. 1971; Grodzicker et al. 1972). When bacteria are grown in rich medium, the intracellular concentrations of cAMP are low, and the lytic pathway is favored. In mutant cells that lack cAMP, the lytic pathway is heavily favored. Because none of the known bacteriophage promoters are responsive to cAMP, it seems likely that the decision between lysogeny and lytic infection is influenced in part by a bacterial gene or genes that are regulated by cAMP.

A key element in the decision between lysis and lysogeny is the bacteriophage-encoded CII protein (please see the panel on **CII PROTEIN**), the activator of transcription of  $\lambda$  genes that (1)

### CII PROTEIN

- The CII protein is synthesized as a 97-amino-acid polypeptide. After removal of the amino-terminal methionine and the subterminal valine, the polypeptide associates into an active tetrameric form.
- It is a DNA-binding protein that interacts specifically and with reasonable affinity ( $3 \times 10^{-7}$  M) with a 20–25-bp region of three leftward promoters:  $p_{RE}$ ,  $p_V$ , and  $p_{aQ}$ . The consensus sequence for binding is TTGCN<sub>6</sub>TTGC.
- CII and RNA polymerase interact with the three leftward promoters in a cooperative manner, such that full activation of transcription occurs when the concentration of cII is tenfold less ( $3 \times 10^{-8}$  M) than that required for maximal binding of cII alone.
- The CII protein is unstable (half-life = 2 minutes) but is partially stabilized by the bacteriophage CIII protein. In addition, its natural rate of degradation is diminished or enhanced by several bacterial gene products. Mutations in the *E. coli lon* and *cya* genes increase the rate of degradation of CII and, therefore, favor the lytic response, whereas mutations in the *hflA* and *hflB* loci extend the half-life of the protein and facilitate the lysogenic response (Hoyt et al. 1982; Banuett et al. 1986; for reviews, please see Friedman et al. 1984; Ho and Rosenberg 1988).



**FIGURE 2-4 The Bacteriophage  $\lambda$  CII Protein Is a Transcriptional Activator**

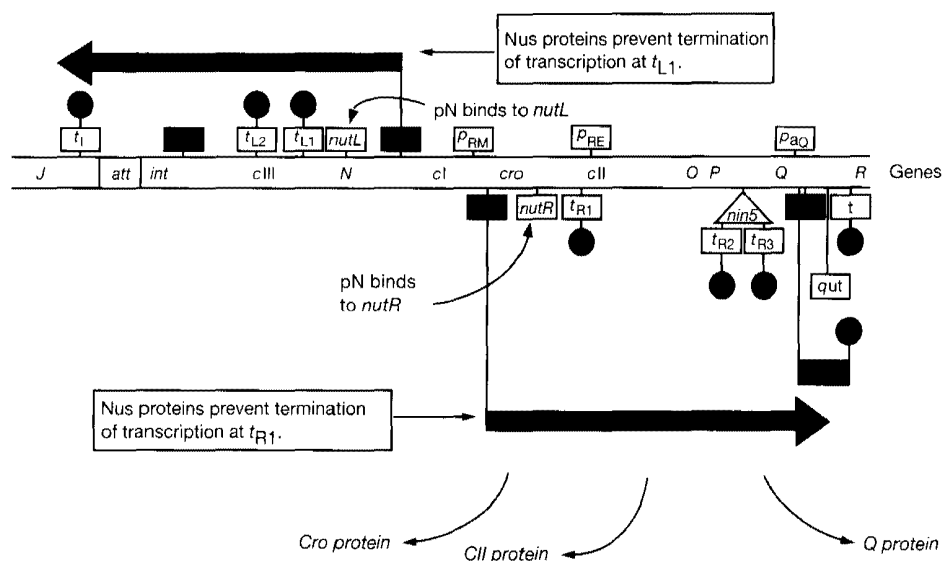
The product of the *cII* gene transcribed from the  $p_R$  promoter is a transcriptional activator that stimulates leftward transcription (thick arrows) from  $p_I$ ,  $p_{RE}$ , and  $p_{aQ}$ . The promoter  $p_{RE}$  controls expression of the *CI* (repressor) protein, whereas  $p_I$  controls expression of *int* (encoding integrase). The promoter  $p_{aQ}$  directs the synthesis of an antisense RNA that is believed to reduce expression of the *Q* (antiterminator) gene product. The products of early transcription initiated from the promoters  $p_L$  and  $p_R$  are represented by thin arrows. (Modified, with permission, from Ho and Rosenberg 1988.)

represses lytic functions and (2) catalyzes integration of the viral DNA into the host chromosome (Echols 1980; Herskowitz and Hagen 1980; Wulff and Rosenberg 1983). A high intracellular concentration of CII favors lysogeny, whereas a low concentration tips the balance in favor of lysis. The CII protein coordinately regulates transcription from three separate leftward promoters:  $p_{RE}$ ,  $p_I$ , and  $p_{aQ}$  (please see Figure 2-4). Thus, when a sufficient concentration of CII is present in the infected cell, transcription of *int* and *cI* genes is activated. The integrase (Int) protein, synthesized from  $p_I$ , catalyzes a breaking and joining event that leads to insertion of the viral DNA into the host chromosome. The product of the *cI* gene —  $\lambda$  repressor — binds to three 17-bp operators in each of the early promoters  $p_R$  and  $p_L$ , thereby denying access of RNA polymerase to the promoters and hence blocking transcription of phage early genes *N*, *cro*, *O*, *P*, and *Q*, whose products are essential for onward progression of the lytic cycle (please see the panel on **CI PROTEIN**). This stranglehold can be broken by another transcriptional repressor — Cro — which competes with CI protein for occupation of the operator  $O_R$  (please see Figure 2-5). The outcome of this compe-

### CI PROTEIN

Bacteriophage  $\lambda$  CI protein (236 amino acids;  $M_r = 26,228$ ) is an inactive monomer at very low concentrations ( $<10^{-9}$  M), but at physiological concentrations, it forms functional homodimers. Although commonly called  $\lambda$  repressor because of its negative regulatory functions at  $o_L$  and  $o_R$ , CI protein is also a positive regulator of gene transcription and can activate transcription of its own gene.

- The DNA-binding domain of CI protein lies within the amino-terminal region of the molecule (Sauer et al. 1979) and contains five stretches of  $\alpha$ -helix, of which two (helices 2 and 3) form a helix-loop-helix motif and are involved in sequence-specific binding to the major groove of DNA (Pabo and Lewis 1982; Beamer and Pabo 1992; for more details, please see review by Hochschild 1994). The CI protein binds symmetrically to DNA, so that each amino-terminal domain contacts a similar set of bases.
- The carboxy-terminal domain of the CI protein contains the major sites for dimerization and oligomerization (Pabo et al. 1979).
- $o_L$  and  $o_R$  both contain three binding sites for CI protein. In each case, site 1 (i.e.,  $o_{L1}$  and  $o_{R1}$ ) has a  $\sim 10$ -fold greater affinity than the other sites for CI protein. The repressor, therefore, always binds first to  $o_{L1}$  and  $o_{R1}$  and then binds to the other sites in the operator in a cooperative manner (Johnson et al. 1979). Cooperativity is mediated by the carboxy-terminal domains of repressor dimers.
- When incubated at high pH in vitro, CI protein undergoes an autocatalytic cleavage at a Gly-Ala peptide bond located between the two domains. In vivo, autocatalytic cleavage occurs in the presence of bacterial RecA protein, which acts as a coprotease (Little 1984; for review, please see Little 1993).



**FIGURE 2-5 Bacteriophage  $\lambda$  Delayed Early Transcription**

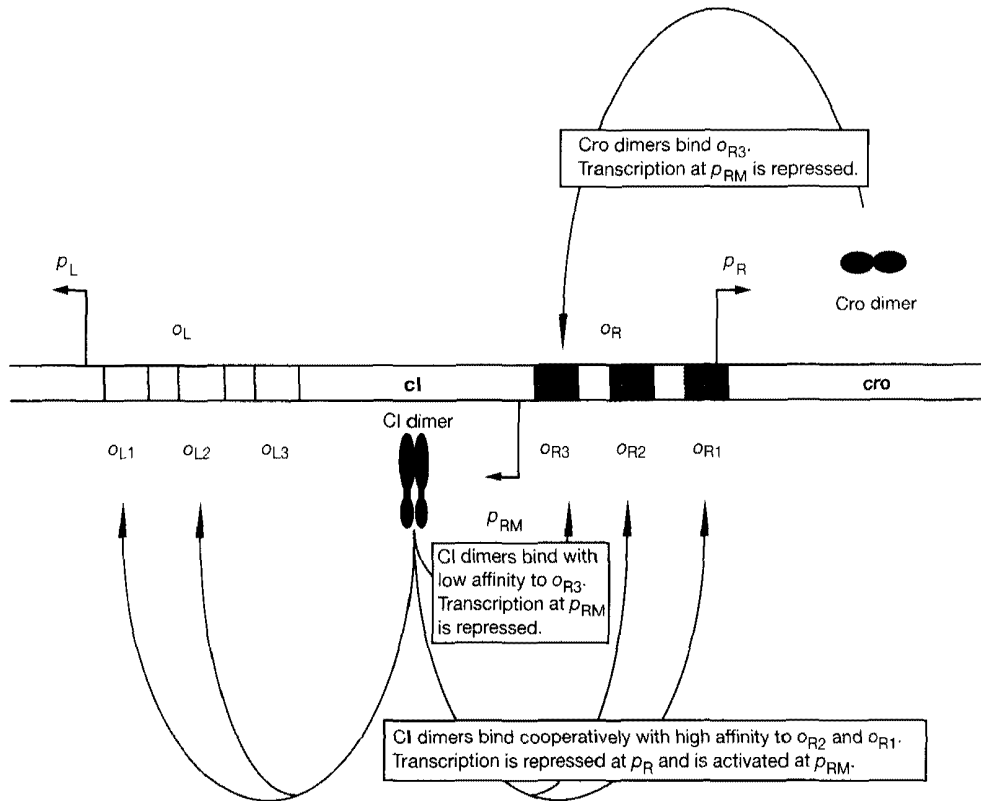
*N* protein turns on genes to the left of *N*, including *cIII* and genes involved in recombination and, in addition, genes to the right of *cro*, including *cII* and the DNA replication genes *O* and *P* and the positive regulator of late transcription, *Q*. During the delayed early phase of transcription, the fate of the infected cell remains undecided, and infection can progress either to lysogeny or to a cycle of vegetative growth. By the end of the delayed early phase, an irrevocable decision has been taken to proceed down one pathway or the other. (Shaded boxes) The products of transcription; (●) transcription termination sites.

#### THE DISCOVERY OF BACTERIOPHAGE $\lambda$

Bacteriophage  $\lambda$  first appeared in the laboratory in 1951, when Esther Lederberg found that certain mutants of *Escherichia coli* K-12, which survived following treatment with intensive ultraviolet (UV) irradiation, grew normally in pure culture but died of a bacteriophage infection after conjugation to other bacterial strains. The parental wild-type K-12 strain, like most others in use at that time, was naturally lysogenic for bacteriophage  $\lambda$ . Exposure to UV irradiation cured the surviving bacteria of prophage, generating bacterial strains that were no longer immune to external infection by the bacteriophage. Strains "cured" in this way fell victim to lysis by bacteriophage  $\lambda$  (1) when incubated with lysogenic strains, which spontaneously produce infectious phage particles at a low rate, or (2) when during conjugation, the DNA of a lysogenic strain was transferred to a nonlysogenic recipient. In both cases, the incoming bacteriophage genome entered a repressor-free cell and established a cycle of lytic growth, generating a batch of progeny particles that could lytically infect the remaining nonlysogenic cells in the culture.

Lysogeny was not a new phenomenon, having already been studied over the course of 40 or more years by an illustrious cadre of phage workers including Macfarlane Burnet, Eugène and Elizabeth Wollmann, Jules Bordet, and Felix D'Herelle (for a review of early work on lysogeny, please see Brock 1990). However, none of their experiments provided a satisfying explanation of the constant production of small amounts of infectious bacteriophages by pure cultures of bacteria and the episodic and unpredictable occurrence of massive lysis. "Worthless" was Max Delbrück's succinct description of a half century of honest effort.

All this changed as a result of André Lwoff's elegant experiments showing first that exposure to small amounts of UV irradiation reproducibly caused an entire culture of lysogenic *Bacillus megaterium* to liberate bacteriophage particles in a synchronous fashion (Lwoff and Gutmann 1950), and second that every cell of the culture carried a prophage (for review, please see Lwoff 1953). The discovery of induction was of great importance because it made possible both genetic and biochemical studies of the production of temperate bacteriophages. Lwoff's papers caused tremendous excitement in the phage world and were sufficient to persuade sceptics that the phenomenon of lysogeny was both real and accessible. Writing 15 years later in prose that was still passionate, Lwoff (1966) describes the discovery of induction as the highlight of his scientific life. By contrast, Esther Lederberg's paper — far more laconic and pallid — gives no sign that she had discovered the bacteriophage that was to become the defining crucible for molecular studies of prokaryotic gene control.



**FIGURE 2-6 Wiring Diagram of the Switch between Lytic Infection and Lysogeny**

Dimers of the CI repressor bind most tightly to  $o_{R1}$  and least tightly to  $o_{R3}$ . Cro has the opposite relative affinities. Transcription at promoter  $p_R$  is repressed when  $o_{R1}$  is occupied by CI; transcription at  $p_{RM}$  is repressed when  $o_{R3}$  is occupied by CI. Thus, CI establishes lysogeny by throttling expression of genes transcribed from  $p_R$  and, once the lysogenic state is achieved, controls its own concentration by inhibiting transcription at  $p_{RM}$ . Because binding of CI to adjacent sites is cooperative, the proximity of  $o_{R2}$  ensures a sharp concentration dependence of binding to  $o_{R1}$ . Binding of CI to  $o_{R2}$  also activates transcription from  $p_{RM}$ . On induction, CI protein is inactivated by cleavage and transcription from  $p_R$  resumes. The first product of transcription is the mRNA for Cro. Binding of Cro to  $o_{R3}$  prevents further synthesis of CI protein. Repression of transcription is relieved at  $p_L$  and established at  $p_{RM}$ . The switch to lytic infection is then permanent (Ptashne 1986). (Modified, with permission, from Harrison 1992.)

tion determines whether the cell will become lysogenic or will advance to the late stages of lytic infection. The three binding sites of  $O_R$  are arranged within and between two divergent promoters for the genes encoding the two repressors. Cro and the CI protein bind to these sites with different preferences (order of binding, cooperativity, and affinity) (Johnson et al. 1979). Thus, the CI protein binds to sites  $o_{R1}$  and  $o_{R2}$  strongly and cooperatively, whereas Cro binds to  $o_{R3}$  strongly and to  $o_{R1}$  weakly (Cro does not bind cooperatively). Each protein turns off the gene encoding its competitor as well as the appropriate downstream genes that are required for lytic growth or lysogeny. The two repressors therefore not only compete for the same sites, but also have mutually antagonistic physiological effects (for reviews, please see Gussin et al. 1983; Ptashne 1992).

In addition to its repressive effects on rightward transcription, the CI protein stimulates leftward transcription of its own gene by a factor of  $\sim 10$ . This effect is mediated by binding of a repressor dimer at  $o_{R2}$ ; a repressor dimer bound at  $o_{R1}$  interacts cooperatively with repressor bound at  $o_{R2}$  to stabilize binding to the DNA (please see Figure 2-6) (Meyer et al. 1980). The bound repressor is able to make direct contact with RNA polymerase at the leftward promoter,

$p_{RM}$  (Guarente et al. 1982; Hochschild et al. 1983) and thereby to stimulate the transition from the closed to the open transcription complex (Hawley and McClure 1983; Fong et al. 1993). Transcription from  $p_{RM}$  may also be stimulated by CI-mediated exclusion of RNA polymerase from binding to  $p_R$  (Hershberger et al. 1993).

In summary, during establishment of lysogeny, repressor synthesis is directed by the promoter  $p_{RE}$  under positive regulation by the CII and CIII proteins. However, because repressor prevents transcription from  $p_R$  and  $p_L$ , it blocks further expression of *cII* and *cIII*, respectively. Thus, these genes are inactive in lysogens (Bode and Kaiser 1965). Furthermore, since CII and CIII are unstable, CI protein must eventually suppress, albeit indirectly, transcription from  $p_{RE}$ . Transcription of *cI* from a second promoter  $p_{RM}$  is therefore required for the maintenance of lysogeny (please see Lysogeny [p. 2.15] and Figure 2-6).

## LATE LYTIC INFECTION

---

### DNA Replication

Two genes, *O* and *P*, are weakly transcribed from  $p_R$  immediately after infection and more strongly later as a consequence of pN-mediated antitermination. The products of these genes, together with some of the host replication proteins and stress proteins, are required for replication of bacteriophage DNA (for reviews, please see Furth and Wickner 1983; Kornberg and Baker 1992). During the early phase of infection, bacteriophage  $\lambda$  DNA replicates bidirectionally as a Cairns or  $\theta$  (circle to circle) form, using a single origin (*ori*) that is activated by proteins pO and pP. In a wild-type *E. coli* infected with wild-type bacteriophage  $\lambda$ , ~50 monomeric, circular bacteriophage genomes are synthesized before replication shifts to a rolling circle mode. Linear DNA molecules are then generated that consist of tandem polymers of the bacteriophage genome arranged head to tail. These long concatemeric molecules are cut and packaged into proheads of progeny particles (please see Figure 2-7 and DNA Packaging [p. 2.14]).

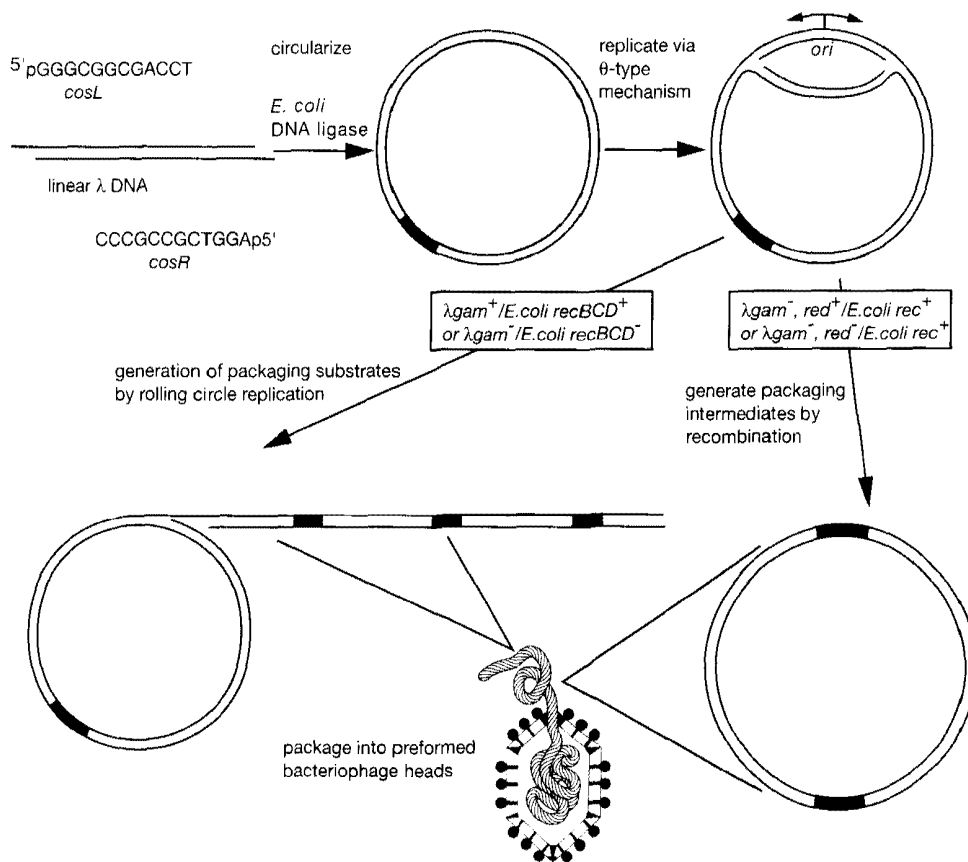
It is not known what triggers the mid-stream shift from  $\theta$  to rolling circle replication. However, the conversion from one mode to another is inhibited by the heterotrimeric exonuclease V, which is encoded by the bacterial *recB*, *recC*, and *recD* genes (Telander-Muskavitch and Linn 1981). Nevertheless, the production of concatenated DNA is not affected in *recBCD*<sup>+</sup> cells as long as the infecting bacteriophage carries a functional *gam* gene. The product of this gene binds to exonuclease V and inactivates its exonucleolytic activity (Unger and Clark 1972; Kuzminov et al. 1994). In the absence of Gam protein, the potent, multifunctional RecBCD nuclease degrades the concatenated linear bacteriophage DNA produced by rolling circle replication. Gam protein is not needed for production of linear concatenates of viral DNA if the RecBCD nuclease is defective or absent (Greenstein and Skalka 1975). Most bacteriophage  $\lambda$  vectors lack the *gam* gene but can nevertheless multiply to a passable extent in *recBCD*<sup>+</sup> cells if they are able to generate concatemeric forms of the genome that are suitable substrates for packaging of progeny particles. Such concatemers can be formed by recombination between monomeric circular DNA molecules that are produced by  $\theta$ -type replication.

### Recombination Systems in Cells Infected with Bacteriophage $\lambda$

Both bacteriophage  $\lambda$  and *E. coli* encode recombination systems (*red* and *recA*, respectively) that can produce dimeric and multimeric circles from the replicating  $\theta$  form. Most bacteriophage  $\lambda$  vectors that are *gam*<sup>-</sup> are also *red*<sup>-</sup> and must therefore be propagated on *recA*<sup>+</sup> strains of bacteria in order to promote the efficient production of circular multimers. During packaging, these cir-

cular forms, like the head-to-tail tandem polymers produced by rolling circle replication, are cleaved at the *cosL* and *cosR* sites by the terminase function of the bacteriophage-encoded A protein. However, the presence of an active bacterial recombination system can sometimes lead to instability in sequences cloned in bacteriophage  $\lambda$  vectors, particularly in genomic sequences that contain repetitive elements. There are three ways to avoid this problem:

- Several vectors have been designed that carry the *gam* gene on one of the arms of the bacteriophage genome. Examples of such vectors are Charon 32–35 and 40 (Loenen and Blattner 1983; Dunn and Blattner 1987).
- Gam protein can be supplied in *trans* from a plasmid (Crouse 1985). In this system, the expression of *gam* is controlled by the product of the Q gene of the incoming bacteriophage. Inactivation of exonuclease V can therefore occur only after infection.



**FIGURE 2-7 Bacteriophage  $\lambda$  Replication and Recombination**

During lytic infection, bacteriophage  $\lambda$  DNA, which is injected into the cell as a linear molecule, is rapidly converted to a closed circular form by ligation of the cohesive ends (*cos*). During the early phase of infection, DNA replication proceeds bidirectionally ( $\theta$ -type replication) and generates  $\sim 50$  monomeric copies of the circular viral DNA per cell. In the presence of the *gam* gene product in host cells that are *recBCD*<sup>+</sup>, or in the absence of the *gam* gene product in host cells that are *recBCD*<sup>-</sup>, replication converts to a rolling circle mode. The events of replication generate linear concatemers of viral DNA, which are substrates for packaging of the viral DNA into the preformed heads of bacteriophage particles. In *recBCD*<sup>+</sup> cells that are infected with a *gam*<sup>-</sup> phage, rolling circle replication cannot be established. Under such circumstances, progeny particles cannot be produced unless a suitable system is available to catalyze recombination between circular monomers of viral DNA, generating multimeric circles that are acceptable substrates for packaging into preformed bacteriophage heads.

- A number of mutant strains of *E. coli* are available that are recombination-proficient but deficient in exonuclease V. These include strains that are defective in *recB* or *recC*, as well as strains carrying the mutations *sbcA* or *sbcB*, both of which suppress mutations in *recBC*.

Because synthesis of catenated bacteriophage DNA is impeded by exonuclease V, *red<sup>-</sup>gam<sup>-</sup>* bacteriophages produce small plaques when plated on wild-type *E. coli*. However, recombination-deficient bacteriophage mutants carrying an octameric  $\chi$  DNA sequence known as  $\chi$  (chi) produce plaques that are close to normal in size (Lam et al. 1974; Henderson and Weil 1975; please see the panel on **CHI  $\chi$  SITE**). The presence of (1) the  $\chi$  sequence in the bacteriophage genome and (2) an active recombination RecBCD system provided by the host leads to an increase in the efficiency of recombination events that generate closed circular dimers and multimers from  $\theta$  forms. *red<sup>-</sup>gam<sup>-</sup>* bacteriophages package these multimers efficiently, and *red<sup>-</sup>gam<sup>-</sup> $\chi$ <sup>+</sup>* bacteriophages grow to a reasonable yield in wild-type *E. coli*.

### CHI ( $\chi$ ) SITE

$\chi$  is an 8-bp-long sequence of double-stranded genomic DNA (5' GCTGGTGG 3') that, in *E. coli*, causes increased recombination over a region of several kilobases located asymmetrically around the  $\chi$  sequence. The stimulatory effect of  $\chi$  sequences on recombination is due to the formation of a nick about five nucleotides 3' of the  $\chi$  site by the *E. coli* RecBCD protein, a heterotrimeric enzyme encoded by the *recB*, *recC*, *recD* genes (Taylor et al. 1985; for review, please see Taylor 1988). The nick only occurs when the enzyme passes through the  $\chi$  sequence in one direction (from right to left, as written above), unwinding the DNA as it goes (Faulds et al. 1979; Yagil et al. 1980; Smith et al. 1981). The combination of unwinding and nicking generates a single-stranded "tail" with a  $\chi$  sequence near its 3' end. This tail is believed to be a potent substrate for RecA protein, which catalyzes the formation of recombinant molecules between the single-stranded tail and homologous double-stranded DNA (for review, please see Smith 1990).

Of the several major pathways of recombination in *E. coli*, only RecBCD is stimulated by  $\chi$  sites.  $\chi$  sites are therefore inactive in *recB*, *recC*, and *recBC* double mutants. Normally, the RecBCD protein expresses a powerful exonuclease V activity (Telander-Muskavitch and Linn 1981) that is used, e.g., to destroy foreign DNA that has been cleaved by restriction enzymes (Simmon and Lederberg 1972; Oliver and Goldberg 1977). However,  $\chi$  sites protect linear DNA from degradation both in vivo and in vitro, perhaps by inactivating the exonuclease V activity of the RecBCD nuclease (Kuzminov et al. 1994). With the help of the RecA protein, the frayed end of DNA invades a homologous sequence to form a branched structure that can be converted into a replication fork and resolved by recombination.

$\chi$  sequences were first discovered in bacteriophage  $\lambda$  as mutations creating recombinational hot spots for RecBCD-promoted recombination (Lam et al. 1974; Henderson and Weil 1975; Stahl et al. 1975); there are no  $\chi$  sites in wild-type  $\lambda$  DNA. However,  $\chi$  sequences have been created by single-base changes at several widely spaced sites in the bacteriophage  $\lambda$  genome. The *E. coli* genome contains a total of  $\sim 10^3$   $\chi$  sites,  $\sim 1$  per 4–5 kb (Faulds et al. 1979; Blaisdell et al. 1993; Burland et al. 1993; for reviews, please see Smith 1983; Murray 1991). Of these sites in the *E. coli* chromosome, 90% are oriented such that they will protect against degradation of DNA proceeding toward the origin of replication (Burland et al. 1993; Médigue et al. 1993).  $\chi$  sites, therefore, serve as bulwarks, which are strategically deployed to protect crucial sites in DNA against the ravages of the RecBCD protein.

Because recombination is essential for efficient replication and packaging of bacteriophage  $\lambda$  genomes, the presence or absence of  $\chi$  sites and the state of the host recombination machinery are important factors to consider when selecting a host cell for a particular bacteriophage  $\lambda$  vector. The requirement for a  $\chi$  site in *red<sup>-</sup>gam<sup>-</sup>* bacteriophages can be eliminated by using as hosts bacterial strains that carry *recD* mutations. These strains, which are superproficient in recombination but defective in exonuclease V production (Amundsen et al. 1986), generate concatemers of bacteriophage  $\lambda$  DNA by both recombination and rolling circle replication. The recombination system in *recD<sup>-</sup>* mutants is so active that a  $\chi$  sequence is no longer required in *red<sup>-</sup>gam<sup>-</sup>* bacteriophages. Because some bacteriophage  $\lambda$  vectors are *red<sup>-</sup>gam<sup>-</sup>* and do not carry a  $\chi$  site, recombinants would normally be expected to display a small-plaque phenotype on wild-type *E. coli*. However, eukaryotic DNAs contain sequences that can mimic  $\chi$  sites. Thus, some recombinant bacteriophages will carry insertions of foreign DNA that contain  $\chi$  sequences and others will not. The recombinants that contain the  $\chi$  sequences will grow to higher titer, form larger plaques, and become overrepresented during amplification of libraries. This problem can be overcome by avoiding vectors (such as Charon 28 and 30) which give rise to *gam<sup>-</sup>* recombinants that do not contain a  $\chi$  site. These vectors should only be used for construction of libraries if the recombinants are propagated on *recBC<sup>-</sup>* or *recD<sup>-</sup>* hosts.



## Late Transcription

As discussed earlier, the mRNA synthesized from  $p_R$  encodes a repressor, Cro, that competes with CI protein for binding to three sites in each of two operator regions,  $o_L$  and  $o_R$  (Johnson et al. 1978, 1979; for reviews, please see Gussin et al. 1983; Ptashne 1992). Binding of Cro to  $o_{R3}$  prevents further synthesis of CI protein and makes the commitment to the lytic pathway irreversible. By this stage, sufficient amounts of another positive control protein, encoded by gene Q, have been synthesized to ensure efficient transcription of late viral genes (Dove 1966; Joyner et al. 1966). These genes encode proteins that will be assembled into bacteriophage heads and tails. In addition, pQ regulates genes required for cell lysis. Like pN, pQ is an antiterminator that modifies RNA polymerase so that the enzyme no longer recognizes downstream terminators. Unlike pN, which binds to a unique hairpin in nascent RNA, pQ binds to a specific DNA sequence, *qut*, that overlaps with  $p_R$ . From this site and while the enzyme is stalled at the transcriptional pause site, pQ transforms RNA polymerase into an antiterminating state. This modification, whose nature is unknown, may lower the  $K_m$  of the enzyme for nucleoside triphosphates (NTPs) (Yarnell and Roberts 1992).

Functions expressed late in bacteriophage development are controlled primarily through termination and antitermination of transcription (Roberts 1975).  $p_R$  — the sole promoter used for transcription of the entire late region — is active at early times during infection. However, in the absence of pQ, the transcription complex pauses for several minutes at base pair 16/17 of the transcript and then terminates at a strong terminator,  $t_R$ , located at base pair 194 (Grayhack et al. 1985; for reviews, please see Friedman 1988; Das 1993). Under the influence of pQ and in the presence of the host factor NusA, transcripts initiated at  $p_R$  are rapidly extended through both the pause site at base pair 16 and the terminator at  $t_R$ . Transcription then proceeds around the circular genome through the late genes and terminates within the *b* region (please see Figure 2-6).

## DNA Packaging and Assembly of Bacteriophage Particles

In the late stages of lytic infection, duplex concatemeric DNA is packaged into a DNA-free prohead according to the scheme outlined in Figures 2-7 and 2-8 (for reviews, please see Black 1988; Casjens and Hendrix 1988). An early precursor in the pathway leading to head assembly is a scaffolded prehead. Further maturation, which involves removal of the scaffolding protein and proteolytic processing of other components, depends on a protein (the product of *groE* gene) supplied by the host. The resulting structures are called preheads. Packaging the bacteriophage genome into preheads requires two phage-encoded proteins, Nu1 and A, which bind to the concatenated linear DNA near left *cos* sites (please see the panel on  $\lambda$  TERMINASE). Two adjacent *cos* sites of the concatenated linear DNA are brought close together at the entrance to the head, where they are cleaved in a staggered fashion by the terminase function of the A protein to generate the 12-nucleotide cohesive termini. The cleaved DNA-protein complex then becomes attached to a defined area on the prehead (Frackman et al. 1984). In the presence of protein FI, the DNA, left-hand end first, is pumped into the prehead by an ATP-dependent process (Emmons 1974; Kaiser et al. 1975; Hsaio and Black 1977; Hendrix 1978; for review, please see Black 1988). During filling, the prehead increases in size by ~11–45% (Hohn 1983). Finally, the D, or “decoration,” protein attaches to the outside of the filled capsid, locking the head in place around the DNA (Sternberg and Weisberg 1977). The head is also stabilized by the addition of one final protein, the product of gene FII, which forms at least a portion of the site to which the tails bind (Casjens et al. 1972; Tsui and Hendrix 1980).

**λ TERMINASE**

λ terminase is a packaging enzyme that fashions concatemers of viral DNA into unit-length genomes with protruding 5' termini, 12 bp in length (for reviews, please see Feiss and Becker 1983; Feiss 1986; Becker and Murialdo 1990). The site of action of terminase is called the cohesive end site or *cos* (Emmons 1974; Feiss and Campbell 1974). Unit-length λ chromosomes are therefore normally generated by cleavage of linear concatemers at two *cos* sites spaced one genome length apart.

Terminase is a hetero-oligomer of polypeptides encoded by the two leftmost genes on the bacteriophage λ genome: the *Nu1* gene (which encodes a 181-amino-acid polypeptide) and the *A* gene (which encodes a 641-amino-acid polypeptide) (for review, please see Feiss and Becker 1983). Both subunits can hydrolyze ATP (Parris et al. 1988), and mutants of either gene display the same phenotype, i.e., the accumulation of concatemers and empty proheads (Murialdo and Siminovitch 1972).

The DNA sequence that is recognized and cleaved by terminase consists of two subsites, the *cosN* (*cos* nicking) site, previously called *cos*, and the adjacent *cosB* (*cos* binding) site. Under normal conditions, cleavage at *cosN* is carried out by the larger subunit of terminase (*gpA*) and is accompanied by hydrolysis of ATP (Gold and Becker 1983), which acts both as an allosteric effector of terminase and to melt the *cos* ends after cleavage (Higgins et al. 1988; Cue and Feiss 1993). Following nicking at *cosN*, terminase remains tightly bound to the left end of the λ chromosome in a complex called complex I (Becker et al. 1977; Sippy and Feiss 1992; Cue and Feiss 1993). Complex I then binds to the portal protein (encoded by the bacteriophage λ *B* gene), which serves as the site of DNA entry into the prohead (Yeo and Feiss 1995). Terminase remains bound to the portal protein as DNA is reeled from the cleaved concatemer into the prohead. Packaging ceases when terminase introduces staggered nicks at the next *cos* site, by which time the prohead contains a complete linear bacteriophage λ genome ~50 kb in length. The filled heads then associate with preformed tail units, which have been assembled by a separate pathway.

The noncontractile tail shaft of bacteriophage λ consists of ~32 rings of V protein, each containing six polypeptide subunits (for review, please see Casjens and Hendrix 1988). These subunits form a hollow tube 9 nm in diameter through which the DNA is injected on infection. Very little is known about the structure of the proximal end of the tail except that small numbers of the gene *U* and possibly gene *Z* proteins are located there. It is not understood how the preformed tail and filled heads are assembled into bacteriophage particles. The distal tip of the tail contains at least six different polypeptides, including two or three molecules of the gene *J* protein that is involved in attachment to the *lamB* receptor during adsorption (please see the section entitled Adsorption, p. 2.4).

**Lysis**

Lysis of the host bacterium by bacteriophage λ requires proteins encoded by the first three genes in the late transcript: *S*, *R*, and *Rz* (for review, please see Young 1992). The functions of these three genes and the properties of the proteins they encode are summarized in Table 2-1. Many of the bacteriophage λ strains used in the laboratory carry an amber mutation *Sam7* in the *S* gene. This mutation prevents or delays lysis, allowing the assembly of progeny particles to continue for an extended period of time. The accumulated intracellular particles can be liberated artificially by lysing the infected cell with chloroform.

**LYSOGENY**

Only a fraction of wild-type cells infected with bacteriophage λ undergo a lytic cycle of infection. Instead, in a large proportion of the infected population, the lytic cycle is aborted, and the surviving cells thereafter carry a copy of the viral DNA integrated into their genome.

TABLE 2-1 Lysis Genes of Bacteriophage  $\lambda$ 

GENE	SIZE AND PROPERTIES OF PROTEIN	FUNCTION OF WILD-TYPE PROTEIN	PHENOTYPE OF MUTANTS
<i>S</i>	an 8.5-kD (107-residue) inner membrane protein, <i>S</i> is lethal when expressed at physiological levels	homo-oligomers of <i>S</i> form holes in the inner membrane, which allow <i>R</i> protein to enter the periplasmic space	most mutants display delayed lysis, which leads to an intracellular accumulation of assembled bacteriophage particles; addition of chloroform to an induced <i>S</i> lysogen results in instantaneous lysis of the culture
<i>R</i>	a soluble 17.5-kD trans-glycosylase	attacks glycosidic bonds in the peptidoglycan cell wall, generating a 1,6-disaccharide product	lysis is abolished but the infected cells die at the usual time of lysis
<i>Rz</i>	a membrane protein of ~19 kD	possibly an endopeptidase that cleaves oligopeptide cross-links in the peptidoglycan cell wall	lysis in liquid culture is unaffected unless 5–10 mM divalent cations are present, in which case, spheroplasts form at the normal time for lysis

For references, please see review by Young (1992).

## Integration

Two proteins — the bacteriophage-encoded integrase (*Int*, Gingery and Echols 1967; Zissler 1967) and host-encoded integration host factor (*IHF*, Miller and Friedman 1977; Nash et al. 1977; Nash and Robertson 1981) — are required for the integration of bacteriophage DNA into the host chromosome (please see the panel on **INT AND ATT**). The unique regions of bacterial and viral DNAs involved in the recombination event are called *attB* and *attP* sites, respectively (for reviews, please see Weisberg and Landy 1983; Landy 1989; Nash 1990; Friedman 1992; Campbell 1993).

### INT AND ATT

*Int* recombinase (356 amino acids) is a type I topoisomerase that cuts and rejoins DNA strands one at a time (Kikuchi and Nash 1979a,b; Hoess et al. 1980; Craig and Nash 1983). Its preferred substrate, at least in vitro, is closed circular DNA containing negative superhelical turns (Mizuuchi et al. 1978; Richet et al. 1986). *Int* generates a Holliday structure by catalyzing a two-strand exchange at a precise nucleotide by way of a transient DNA-protein bond on a tyrosine residue. Branch migration then occurs across a 7-bp segment of the core, and the Holliday structure is resolved by exchange between the two other strands.

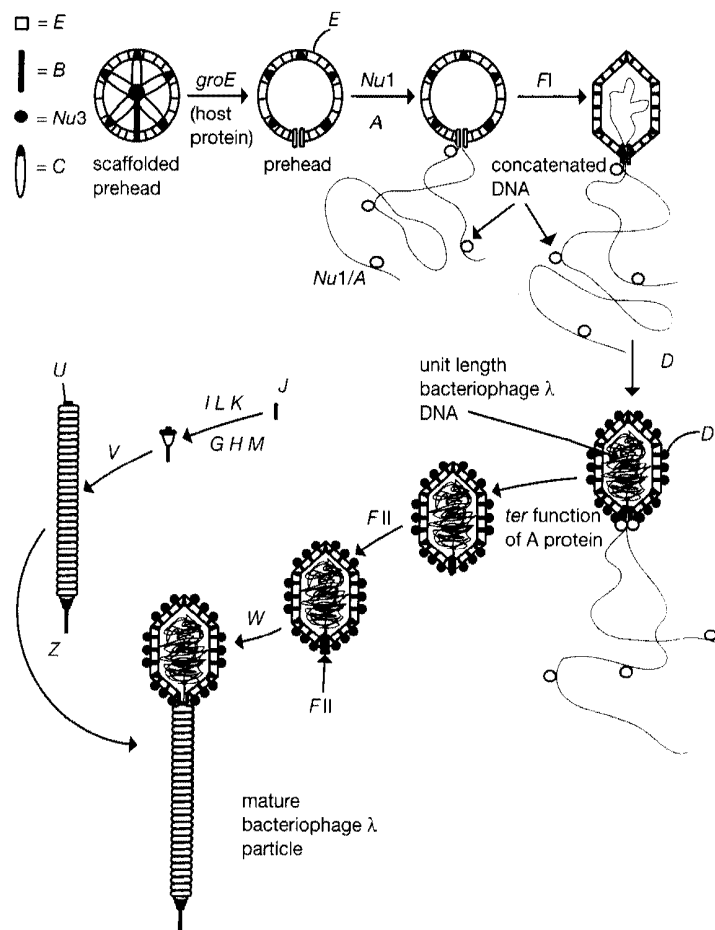
Proper positioning of integrase is facilitated by *IHF*, which bends the DNA duplex into structures compatible with the required DNA-protein interactions (for reviews, please see Nash 1990; Kim and Landy 1992). *IHF* is a heterodimer of two small polypeptides, *IHF $\alpha$*  and *IHF $\beta$* , encoded by *himA* and *himD* (*hip*), respectively (Miller et al. 1979).

*attP* spans ~240 bp of bacteriophage DNA centered on a 15-bp core that is identical between bacteriophage and host chromosomes and includes the crossover point (Weisberg and Landy 1983). *attB* is 21 bp long and is composed chiefly of the core region. During integration, *attP* recombines with *attB* to form a prophage flanked by recombinant *attL* and *attR* sites. The inserted prophage is therefore bracketed by a 15-bp repeat in direct orientation. During excision, these flanking repeats serve as substrates for recombination, regenerating the *attB* and *attP* sites.

## Transcription of Prophage Genes

Almost all viral transcription is repressed in the integrated state; the *rexA*, *rexB*, and *cI* genes, however, continue to be expressed. The *cI* gene product not only blocks transcription of early genes from the  $p_R$  and  $p_L$  promoters, but also positively regulates its own synthesis. Low concentrations of the repressor cause the activity of the maintenance promoter,  $p_{RM}$  to increase; high concentrations inhibit initiation of transcription at  $p_{RM}$  (for review, please see Ptashne 1992). All of these effects are mediated by the binding of repressor to two operator regions ( $o_L$  and  $o_R$ ) (please see Figure 2-6) (Johnson et al. 1979). Bacteriophages with mutations in gene *cI*, *cII*, or *cIII* are unable to establish repression efficiently; they therefore form clear plaques.

Wild-type prophages can be induced by cleavage of the CI repressor following exposure to agents that damage DNA (for review, please see Roberts and Devoret 1983). Cleavage occurs between an alanine and a glycine residue in the hinge region linking the DNA-binding amino-terminal domain and the carboxy-terminal dimerization domain. Little (1984) has shown that cleavage of the CI protein occurs autocatalytically at pH 10 in an intramolecular reaction that displays first-order kinetics and is independent of protein concentration. In vivo, cleavage of the Ala-Gly



**FIGURE 2-8 Schematic Diagram of the Assembly Pathway of Bacteriophage λ**

The gene products involved in each step are indicated (for details, please see the accompanying text and Hohn [1979]). The letters signify the bacteriophage genes encoding various structural proteins used in the construction of bacteriophage particles.

bond and the consequent inactivation of CI protein requires the host RecA protein. Mutant CI proteins (encoded by *ci ind<sup>-</sup>* mutants) are resistant to RecA-mediated cleavage and cannot undergo autodigestion in vitro. This and many other lines of evidence indicate that the function of RecA protein is to stimulate self-cleavage of the CI protein (for reviews, please see Little 1991, 1993).

Bacteriophages carrying a temperature-sensitive mutation in the *ci* gene are able to establish and maintain the lysogenic state as long as the cells are propagated at low temperature (30°C). At this temperature, the repressor retains its ability to inhibit transcription from  $p_L$  and  $p_R$ . However, lytic growth can be induced by heating the bacterial culture for 10–15 minutes to 45°C, which partially inactivates the *cI*<sub>857</sub> repressor (Sussman and Jacob 1962). Although the repressor can renature when the culture is cooled to 37°C (Mandal and Lieb 1976), its concentration is too low to allow reestablishment of lysogeny. Instead, transcription resumes from  $p_L$  and  $p_R$  when ~80% of the CI protein has been inactivated. At this stage, only ~40 monomers of repressor remain in the cell, too small a number to sustain cooperative binding to  $o_{R1}$  and  $o_{R2}$ . In addition, because CI protein stimulates transcription of its own gene, synthesis of new repressor molecules decreases as the concentration of CI falls. The first protein synthesized when transcription resumes from  $p_R$  is Cro, which binds to  $o_{R3}$ , blocking any further synthesis of repressor, and thereby committing the viral genome to a cycle of vegetative growth. The integration and excision proteins, Int and Xis, act together to cause the *att* sites to recombine, resulting in excision of the prophage DNA from the host chromosome. The lytic cycle then follows its usual course.

## CONSTRUCTION OF BACTERIOPHAGE $\lambda$ VECTORS

At first glance, the adaptation of bacteriophage  $\lambda$ , with its large and complex genome, for use as a vector would seem to be a bleak prospect. The DNA of wild-type strains contains multiple sites for many of the most useful restriction enzymes, and these sites are often located in regions of the genome essential for lytic growth of the virus. Moreover, because bacteriophage  $\lambda$  particles will not accommodate molecules of DNA that are much longer than the viral genome, it might seem that the virus would be useful as a vector for only small pieces of foreign DNA.

These problems, however, are not as formidable as they might at first appear. First, the central third of the viral genome is not essential for lytic growth. By the late 1960s, much work had been carried out on specialized transducing bacteriophages, which are formed when excision of  $\lambda$  prophages from the bacterial chromosome occurs by illegitimate recombination, rather than the normal homologous exchange between *att* sites. Part of the central region of the viral genome becomes replaced by the segment of the bacterial chromosome flanking the integrated prophage. Specialized transducing particles derived from lysogens carrying the  $\lambda$  prophage at its normal integration site in the bacterial chromosome can carry the host's neighboring *gal* or *bio* genes. Lysogens carrying prophages at ectopic integration sites produce transducing particles carrying other parts of the *E. coli* chromosome. Genetic studies of these specialized transducing bacteriophages had shown that the region of the bacteriophage  $\lambda$  genome lying between the *J* and *N* genes could be replaced by *E. coli* DNA (for reviews, please see Campbell 1962; Franklin 1971). The analysis of the structure and function of these transducing particles became a prelude to the exploration of bacteriophage  $\lambda$  as a vector.

During the early 1970s, methods were perfected for manipulating sites of cleavage by restriction enzymes in the bacteriophage  $\lambda$  genome. The first of these methods, based on the knowledge of the genetics of restriction and modification of DNA by *E. coli*, allowed selection in vivo of derivatives of bacteriophage  $\lambda$  from which all sites for *EcoRI* had been eliminated from the essential portion of the viral genome. By growing the virus alternatively in strains of *E. coli* that

either possessed or lacked a plasmid coding for *EcoRI*, mutants of bacteriophage  $\lambda$  were isolated that contained only one or two targets for *EcoRI* located in the nonessential region of the genome (Murray and Murray 1974; Rambach and Tiollais 1974; Thomas et al. 1974). Because this kind of selection in vivo was possible only when the bacteriophage could be grown in hosts that synthesized the restriction enzyme of interest, it was necessary to develop alternative methods to obtain vectors suitable for use with other restriction enzymes. For example:

- Recombinants between bacteriophage  $\lambda$  and other lambdoid bacteriophages (e.g.,  $\phi 80$ ) were constructed that either contained or lacked particular restriction sites.
- The development of procedures for packaging purified bacteriophage  $\lambda$  DNA into infectious particles permitted vectors with the desired combination of restriction sites to be generated by in vitro manipulation. Bacteriophage  $\lambda$  DNA was digested with a restriction enzyme, and the surviving molecules were packaged into particles in vitro and propagated in *E. coli* (Klein and Murray 1979). After several successive cycles of digestion, packaging, and growth, bacteriophage genomes were obtained that had lost restriction sites by mutation while retaining infectivity.
- More recently, synthetic oligonucleotides have been used to construct specifically designed DNA fragments that are then inserted into the bacteriophage genome. Using this method, restriction sites were placed at desired locations with precision and high efficiency (Frischauf et al. 1983; Karn et al. 1984).

Together, these methods have led to the development of a large number of vectors that can accept and propagate fragments of foreign DNA generated by a variety of different restriction enzymes (for reviews, please see Murray 1983, 1991).

### **Insertion Vectors**

Vectors that have a single target site for insertion of foreign DNA are known as insertion vectors. The genome of these bacteriophages is ~20% shorter than that of DNA of wild-type bacteriophage  $\lambda$  because many of the genes that are not required for lytic growth have been removed. Insertion of an appropriate segment of foreign DNA into the cloning site restores the genome to something like its full length and facilitates packaging into infectious particles in vitro (Murray et al. 1977; Sternberg et al. 1977; Williams and Blattner 1980). The maximum size of DNA that can be accommodated in an insertion vector varies from 5 kb to 11 kb, depending on the design of the particular vector.

### **Replacement Vectors**

Bacteriophages that have a pair of cloning sites flanking a segment of nonessential DNA are known as replacement vectors. Digestion of linear vector DNA with the appropriate restriction enzymes generates two arms — left and right — that together carry all of the genes required for lytic infection. Removal of the central, nonessential “stuffer” fragment reduces the genome of the vector to a size that cannot be efficiently packaged into bacteriophage particles. Viable bacteriophages can only be formed by ligating a segment of foreign DNA between the purified left and right arms (Thomas et al. 1974). The largest segment of DNA that can be cloned in a replacement vector varies from 8 kb to 24 kb, depending on the vector. Cloning of longer DNA fragments requires deletion of essential bacteriophage genes, whose products must then be supplied in *trans*.

There is no single bacteriophage  $\lambda$  vector suitable for cloning all DNA fragments. Therefore, a careful choice must be made among the available vectors for the one best suited to the particular task at hand. Five obvious considerations influence this choice:

- the restriction enzyme(s) to be employed
- the size of the fragment of foreign DNA to be inserted
- whether the vector is to be used to express cloned DNA sequences in *E. coli*
- whether the foreign DNA is to be rescued from the bacteriophage vector in the form of a plasmid or phagemid
- whether the foreign DNA carried in the vector is to be assembled into a large overlapping contig of cloned DNAs

The development of vectors containing multiple cloning sites and the availability of a variety of restriction enzymes that cleave DNA to produce compatible cohesive termini have greatly simplified the mechanics of cloning into bacteriophage  $\lambda$  vectors. However, the size of the insert remains an important factor to be considered when choosing a vector. Only ~60% of the viral genome (the left arm, ~20 kb in length, including the head and tail genes *A–J*, and the right arm, 8–10 kb in length, from  $p_R$  through the *cosR* site) is necessary for lytic growth of the bacteriophage; the central one third of the genome can be replaced by foreign DNA. However, the viability of bacteriophages decreases dramatically when the lengths of their genomes are greater than 105% or less than 78% of that of wild-type bacteriophage  $\lambda$ . The combination of vector and foreign DNA must result in a recombinant bacteriophage that falls within acceptable size limits.

In the late 1970s and early 1980s, when cloning in bacteriophage vectors was still an adventure, difficulty was sometimes experienced in constructing very large libraries of recombinants. When the amount of starting DNA was limiting, the libraries often contained a high proportion of “empty” clones. To alleviate this problem, genetic markers were incorporated into the vectors to allow rapid selection or screening for recombinants and elimination of empty clones consisting only of vector sequences. Because of steady improvements in library construction, particularly in efficiency of packaging of bacteriophage  $\lambda$  particles and in the preparation of large quantities of DNA for cloning, these genetic markers are no longer used on a routine basis. However, they are still of some value when the starting material for cloning is in short supply, e.g., when genomic DNA is recovered from flow-sorted chromosomes or from microdissected tissue or when cDNA is prepared from mRNA extracted from a few hundred cells. Table 2-2 lists some of the genetic markers that have been used to select or screen for recombinants.

In addition to the markers listed in Table 2-2, certain vectors have been designed to take advantage of the fact that growth of wild-type bacteriophage  $\lambda$  is restricted in lysogens carrying prophage P2. This phenotype is called  $\text{Spi}^+$  (sensitive to P2 interference). However, strains of bacteriophage  $\lambda$  lacking two genes involved in recombination (*red* and *gam*) grow in P2 lysogens and display the  $\text{Spi}^-$  phenotype (Zissler et al. 1971) as long as they carry a  $\chi$  site and the host strain is  $\text{rec}^+$ . Several replacement vectors, such as  $\lambda 2001$ ,  $\lambda \text{DASH}$ , and the EMBL series, carry the *red* and/or *gam* genes in the stuffer fragment. Replacement of the stuffer fragment with a piece of foreign DNA results in recombinant bacteriophages that are  $\text{Spi}^-$  and thus able to grow in P2 lysogens of *E. coli* (Karn et al. 1980, 1984).

Because recombinant bacteriophages outgrow the parental vector in P2 lysogens, it would seem to be unnecessary to take steps to minimize the number of nonrecombinants formed when constructing genomic DNA libraries, e.g., by purifying the left and right arms of the vector from the stuffer fragment. In practice, however, removal of the stuffer fragment has been found to improve the efficiency with which fragments of foreign DNA can be cloned and propagated in

**TABLE 2-2 Genetic Markers Used to Select or Screen for Bacteriophage  $\lambda$  Recombinants**

GENETIC MARKER	PHENOTYPE		EXAMPLES OF VECTORS	REFERENCES
	VECTOR	RECOMBINANT		
<b>Selectable Markers</b>				
<i>cl</i>	<p>Bacteriophages carrying a wild-type copy of the <i>cl</i> gene form plaques with very low efficiency on <i>hfl</i><sup>-</sup> strains of <i>E. coli</i>.</p> <p>Insertion vectors of this class are hybrids between <math>\lambda</math> and lambdoid phage 434 that contain a cloning site in the immunity region of 434. Such vectors form plaques with very low efficiency on strains of <i>E. coli</i> that carry an <i>hfl</i> marker. In the absence of the Hfl protease, the product of the bacteriophage <math>\lambda</math> <i>cII</i> gene accumulates to much higher levels than usual. <i>cII</i> is a positive regulator of the <i>cl</i> gene, so that the net effect of the <i>hfl</i><sup>-</sup> mutation is to increase the amount of the CI repressor in the infected cell. Lytic growth of bacteriophage <math>\lambda</math> is curtailed, and the bacteriophage genome enters the lysogenic state with very high efficiency. Insertion of foreign DNA into the 434 immunity region inactivates the repressor and generates recombinants that are able to form plaques on <i>hfl</i><sup>-</sup> strains. This property is extremely useful when constructing recombinant DNA libraries in <math>\lambda</math>gt10. A single passage of such libraries in <i>hfl</i><sup>-</sup> strains eliminates a high proportion of the nonrecombinant bacteriophages from the population and reduces significantly the labor of screening the library by hybridization.</p> <p>This class of vectors is known as immunity vectors.</p>	<p>Recombinants form plaques efficiently on <i>hfl</i><sup>-</sup> strains of <i>E. coli</i> (e.g., NM514, Murray 1983)</p>	<p><math>\lambda</math>NM641 <math>\lambda</math>NM1149 <math>\lambda</math>NM1150 <math>\lambda</math>gt10</p>	<p>Murray et al. (1977); Scalenghe et al. (1981); Scherer et al. (1981); Huynh et al. (1985); Murray (1983, 1991)</p>
Bacteriophage T5A3 gene	<p>Replacement vectors of this class contain a stuffer fragment that carries two copies of the bacteriophage T5A3 gene. Vectors will not form plaques on <i>E. coli</i> strains carrying plasmid Collb.</p>	<p>Recombinants form plaques on <i>E. coli</i> strains carrying plasmid Collb</p>		<p>Davison et al. (1979)</p>
<i>Spi</i>	<p>For details, please see text.</p>			
<b>Screening Markers</b>				
<i>lacZ</i>	<p>Forms blue plaques on strains of <i>lacZ</i><sup>-</sup> <i>E. coli</i> plated on media containing X-gal.</p>	<p>White plaques</p>	<p><math>\lambda</math>gt11 <math>\lambda</math>gt22-23 <math>\lambda</math>ZAP</p>	<p>Blattner et al. (1977); Pourcel and Tiollais (1977); Pourcel et al. (1979); Huynh et al. (1985)</p>
<i>int</i>	<p>Forms red plaques on strains of <i>E. coli</i> growing on tetrazolium galactose plates and carrying a defective prophage in the <i>gal</i> operon. Infection by an <i>int</i><sup>+</sup><i>xis</i><sup>+</sup> vector results in excision of the prophage restoring a functional <i>gal</i> operon.</p>	<p>White plaques</p>		<p>Enquist and Weisberg (1976); Klein and Murray (1979)</p>



vectors of this type (Frischauf et al. 1983). The multiple restriction sites contained in the poly-cloning sites of the EMBL series of vectors (and in analogous vectors,  $\lambda$ 2001 [Karn et al. 1984] and  $\lambda$ DASH [Sorge 1988]) permit the stuffer fragment to be easily rendered unclonable by digestion with two different restriction enzymes.

The improved efficiency of cloning in vectors equipped with the Spi system comes at a price. As mentioned earlier, recombinants constructed in these vectors lack the *red* and *gam* genes, which can have disadvantages under certain circumstances. In bacteria infected by *gam*<sup>-</sup> bacteriophage, the only DNA molecules available for packaging are relatively rare, exonuclease-resistant, closed circular dimers generated by  $\theta$ -form replication and subsequent recombination (catalyzed by the products of the bacteriophage  $\lambda$  *red* gene or the host *recA* gene). However, the presence of an active bacterial recombination system occasionally leads to rearrangements (in particular to deletion) of segments of foreign DNA that carry repeated sequences (e.g., please see Lauer et al. 1980). To avoid this problem, several vectors have been designed that carry the *gam* gene on one of the arms of the bacteriophage  $\lambda$  DNA. Examples of such vectors are Charon 32–35 and 40 (Loenen and Blattner 1983; Dunn and Blattner 1987). Since each of these vectors is *red*<sup>-</sup>, infected *recA* cells are phenotypically *RecA*<sup>-</sup>, *RecBC*<sup>-</sup>, and *Red*<sup>-</sup>. The use of such vectors has in some instances overcome the problems of cloning segments of foreign DNA containing recombinogenic sequences.

The final genetic factor to consider in choosing a vector is the presence of a  $\chi$  site. As discussed earlier, the growth of *red*<sup>-</sup>*gam*<sup>-</sup> bacteriophages on wild-type *E. coli* is limited by the availability of concatenated DNA molecules that can be efficiently packaged into phage particles. However, the presence of a  $\chi$  site increases the efficiency of the recombination process that gives rise to packaging substrates. As a result, the plaques formed by *red*<sup>-</sup>*gam*<sup>-</sup>  $\chi$  bacteriophages are almost as large as those formed by *red*<sup>+</sup>*gam*<sup>+</sup> bacteriophages. Because most bacteriophage replacement  $\lambda$  vectors are *red*<sup>-</sup>*gam*<sup>-</sup> when the stuffer fragments are removed, recombinants would normally be expected to display the small-plaque phenotype. However, eukaryotic DNAs contain sequences that can mimic  $\chi$  sites. Thus, some recombinant bacteriophages will carry insertions of foreign DNA that contain  $\chi$  sequences and others will not. The recombinants that contain  $\chi$  sequences will grow to higher titer, form larger plaques, and become overrepresented during amplification of libraries. This problem can be overcome by avoiding vectors (such as Charon 28 and 30) that give rise to *gam*<sup>-</sup> recombinants that do not contain a  $\chi$  site. These vectors should only be used for construction of libraries if the recombinant bacteriophages are propagated on *recBC*<sup>-</sup> or *recD*<sup>-</sup> hosts. For construction of genomic DNA libraries, we recommend vectors such as  $\lambda$ 2001,  $\lambda$ DASH,  $\lambda$ FIX, and the EMBL series, which contain  $\chi$  sites in the arms, or Charon 32–35 and 40, which generate *red*<sup>-</sup>*gam*<sup>+</sup> recombinants. All of these vectors give rise to recombinant plaques of relatively uniform size.

### Expression Vectors

Beginning in the mid 1980s and continuing to the present day, several bacteriophage expression vectors have been developed that permit not only the propagation of foreign sequences, but also their expression in bacterial cells, their transcription in vitro into RNA, and, in some cases, their automatic recovery as autonomously replicating phagemids. The prototype  $\lambda$  expression vector is  $\lambda$ gt11 (Young and Davis 1983a; Huynh et al. 1985), which carries a portion of the *E. coli*  $\beta$ -galactosidase gene, including the upstream elements that are essential for its expression. The carboxy-terminal coding region of this gene contains a single *EcoRI* site into which foreign DNA can be inserted.  $\lambda$ gt18–23 are derivatives of  $\lambda$ gt11 that can accept larger inserts and that allow the use of up to four additional restriction enzymes (Han and Rutter 1987, 1988). In appropriate lytic or

lysogenic hosts, the chimeric gene can be induced, resulting in the synthesis of a fusion protein consisting of the amino-terminal portion of the  $\beta$ -galactosidase gene fused to sequences encoded by the downstream open reading frame. cDNA libraries constructed in  $\lambda$ gt11 and  $\lambda$ gt18–23 may be screened immunologically for expression of specific antigens in *E. coli*. This approach has been remarkably successful and has led to the isolation of many genes encoding proteins for which no probes other than specific antisera were available.

Bacteriophage  $\lambda$  vectors such as  $\lambda$ gt11 and  $\lambda$ gt18–23 carry the *clts857* mutation in addition to an amber mutation in the *S* (lysis) gene, *Sam7*. At 42°C, where the *clts857* repressor is only partially functional (Lieb 1979), these vectors form plaques on strains of *E. coli* (such as Y1090*hsdR*) that carry the amber suppressor *supF*. At temperatures where the repressor is active (32°C), these bacteriophage strains can form lysogens. In the original description of  $\lambda$ gt11 (Young and Davis 1983b), cDNA libraries constructed in  $\lambda$ gt11 were screened as bacterial lysogens. The colonies were induced by heating and screened immunologically for production of foreign proteins encoded by the cloned cDNAs. Propagation and screening of expression libraries as lysogens appeared to offer two potential advantages:  $\lambda$ gt11 genomes inherited as part of the host-cell chromosome would perhaps be more stable genetically than genomes propagated by lytic infection, and the repression of synthesis of potentially toxic fusion proteins might be more complete in cells containing only one integrated copy of the recombinant genome than in lytically infected cells that rapidly accumulate hundreds of copies. Despite these apparent advantages, libraries constructed in  $\lambda$ gt11 are no longer propagated as lysogens nor screened after induction because some recombinants are unable to form stable lysogens (Huynh et al. 1985). Furthermore, when plaques, rather than colonies of induced lysogens, are screened with immunological or nucleic acid probes, the signal-to-noise ratio is much higher.

Perhaps the most versatile vector currently available is ZAP Express (Stratagene). cDNAs up to 12 kb in length can be cloned unidirectionally into this vector, automatically excised by superinfection with a filamentous helper bacteriophage, and recircularized to form a plasmid that will drive expression of the cloned cDNA in both bacteria (via the *lac* promoter) and mammalian cells (via the cytomegalovirus immediate early promoter). ZAP Express contains selectable markers for both prokaryotic and eukaryotic cells and carries a portmanteau of controlling elements derived from at least eight different organisms (SV40, cytomegalovirus, *E. coli*, bacteriophages  $\phi$ 1, T3, and T7, various plasmids, and bacteriophage  $\lambda$  itself), as well as a medley of synthetic cloning sites and linkers. Although this synthetic genome may lack the elegance of wild-type  $\lambda$ , it is surely a testimony to the ingenuity and dexterity of its constructors and to the continuing tolerance of the bacteriophage to the works of Man.

## CLONING IN BACTERIOPHAGE $\lambda$ VECTORS

---

Bacteriophage  $\lambda$  has many uses as a cloning vehicle, ranging from subcloning of genomic DNA sequences initially cloned in vectors with larger capacity (e.g., bacterial artificial chromosomes or P1 bacteriophages) to construction of complex cDNA or genomic DNA libraries. Cloning in bacteriophage  $\lambda$  involves several steps that are summarized in the flow chart presented in Figure 2-9.

The protocols in this chapter describe methods to prepare and test bacteriophage  $\lambda$  vectors for cloning and to construct genomic DNA libraries in these vectors. Detailed procedures for the preparation of cDNA libraries are given in Chapter 11.

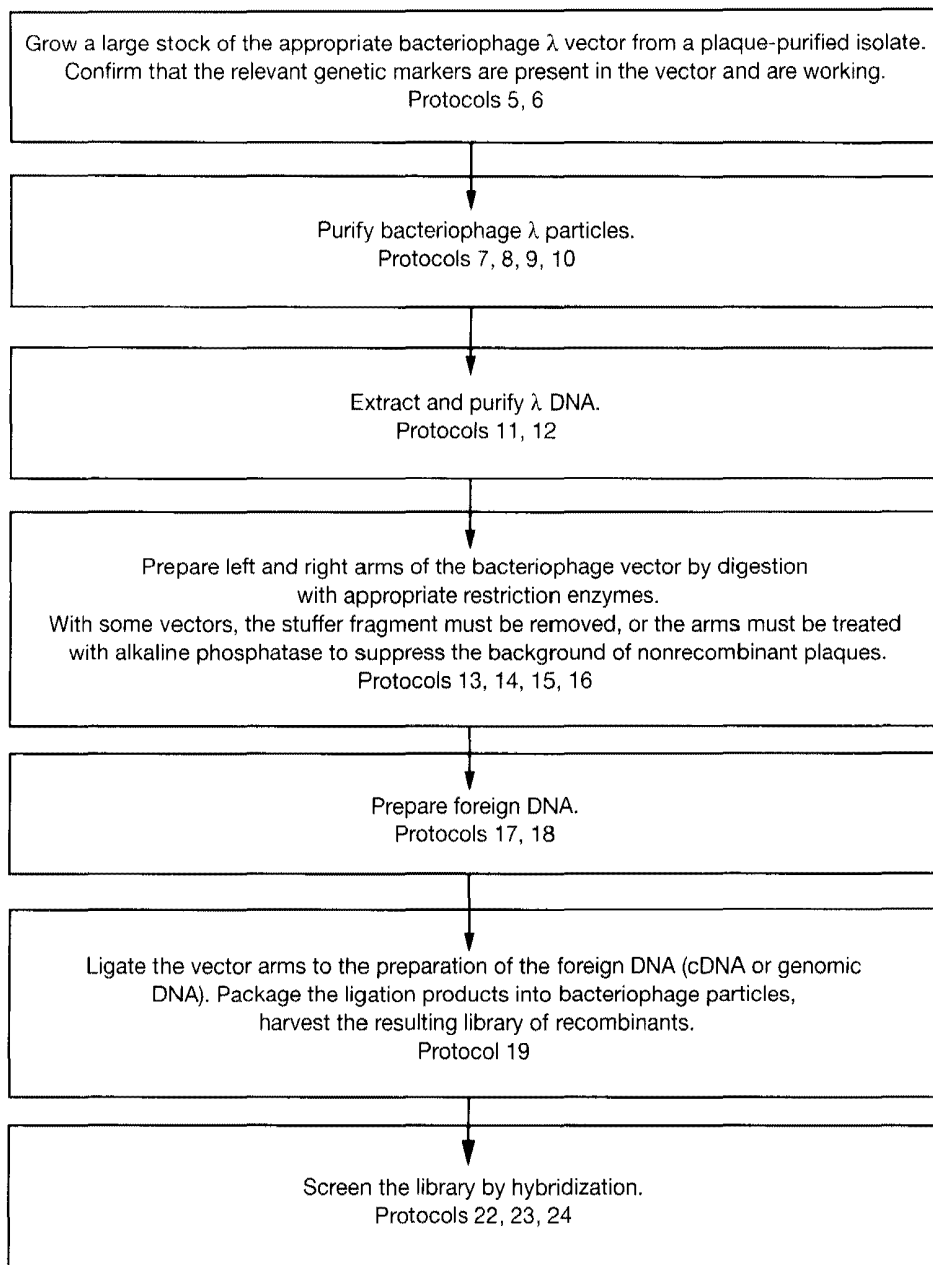


FIGURE 2-9 Flowchart of Protocols in This Chapter

# Protocol 1

---

## Plating Bacteriophage $\lambda$

**A** PLAQUE DERIVES FROM INFECTION OF A SINGLE BACTERIUM by a single bacteriophage particle. The progeny virus particles synthesized by this first infectious center adsorb to and infect neighboring bacteria, which in turn release another generation of daughter virus particles. If bacteria are growing in a semisolid medium (e.g., containing agarose or agar), the diffusion of the progeny virus particles is limited. Under these circumstances, the result of successive rounds of infection is a spreading zone of bacterial lysis that, after several hours of incubation, becomes visible to the naked eye as a relatively clear, circular area in an otherwise turbid background of bacterial growth. Because each plaque contains the progeny of a single virus particle, the bacteriophages derived from a single plaque are essentially genetically identical to one another. A method for generating macroplaques of bacteriophage  $\lambda$  is given at the end of this protocol. Bacteriophage  $\lambda$  vectors that carry the *E. coli lacZ* gene may be analyzed as described in the panel on **ADDITIONAL PROTOCOL: PLAQUE ASSAY OF BACTERIOPHAGES THAT EXPRESS  $\beta$ -GALACTOSIDASE** at the end of this protocol.

### MATERIALS

---

**CAUTION:** Please see Appendix 12 for appropriate handling of materials marked with <!>.

#### Buffers and Solutions

Please see Appendix 1 for components of stock solutions, buffers, and reagents. Dilute stock solutions to the appropriate concentrations.

*MgSO<sub>4</sub>* (10 mM)

*SM* and *SM plus gelatin*

#### Media

*LB* or *NZCYM* (50-ml aliquots in 250-ml conical flasks)

The choice between these two media is largely a matter of personal preference. NZCYM, the richer of the two media, was introduced in the 1970s by the Wisconsin phage workers (Blattner et al. 1977) to grow the enfeebled strains of *E. coli* mandated by cloning regulations in force at that time. The medium has long outlived the regulations and remains in wide use today.

*LB* or *NZCYM* agar plates

Freshly poured plates are too wet for use in plaque assays. To prevent running and smearing of plaques, store the plates for 2 days at room temperature before use. They can then be transferred to plastic sleeves and stored at 4°C. Plates stored at 4°C should be placed at room temperature for 1–2 hours before use in Step 10 below. Warming the plates in this way reduces problems of condensation and allows the top agar subsequently to spread across the entire surface of the plate before it sets. For further information, please see note to Step 12.

**ADDITION OF MALTOSE FOR GROWTH OF  $\lambda$** 

Some investigators add maltose to media used to grow and plate bacteriophage  $\lambda$ . The presence of 0.2% maltose leads to a substantial induction of the maltose operon including the *lamB* gene, which encodes the cell surface receptor to which bacteriophage  $\lambda$  binds (Schwartz 1967). This induction should theoretically increase the efficiency of infection and hence the yield of bacteriophage. The use of maltose is a double-edged sword, however, since florid growth of some strains of *E. coli* in such rich medium may lead to cell lysis and the accumulation of cellular debris laden with the LamB protein. Binding of bacteriophage particles to this debris leads to futile release of the viral DNA and an unproductive infection. In our hands, there is little difference in bacteriophage yield from cultures grown in the presence or absence of maltose.

**LB or NZCYM top agar or agarose (0.7%)**

Melt the top agarose just before use by heating it in a microwave oven for a short period of time. Store aliquots of the melted solution in a 47°C heating block or water bath to prevent the agarose from solidifying until needed in Step 10 below.

Agarose is preferred to agar in this protocol in order to minimize contamination with inhibitors that can interfere with subsequent enzymatic analysis of bacteriophage DNA.

This solution is also known as soft agar/agarose.

**Centrifuges and Rotors**

*Sorvall SS-34 or equivalent*

**Special Equipment**

*Filter paper circles (to fit Petri dish)*

Optional, please see note to Step 12.

*Heating block or water bath preset to 47°C*

**Vectors and Bacterial Strains**

*Bacteriophage  $\lambda$  stocks*

*E. coli strain*

Be sure to use strains of *E. coli* that have been appropriately designed to support the growth of the vector. For a complete listing of relevant *E. coli* genetic markers found in strains used to propagate bacteriophage  $\lambda$ , please see Table 2-3. Before using a particular  $\lambda$  vector, consult the literature and/or heed the recommendations provided by commercial suppliers regarding the choice of a suitable strain of *E. coli*.

**METHOD****Preparation of Plating Bacteria**

1. Inoculate NZCYM or LB medium (50 ml in a 250-ml conical flask) with a single bacterial colony of the appropriate *E. coli* strain. Grow the culture overnight at 37°C with moderate agitation.

Some protocols recommend growing the culture at 30°C instead of 37°C. Growth at the lower temperature increases the chance that the cells will not have reached saturation during the overnight growth period, hence reducing the amount of cell debris in the medium. As noted earlier, bacteriophages added to saturated cultures can adsorb to the LamB protein present on cellular debris, thereby reducing the titer of the bacteriophage inoculum.

2. Centrifuge the cells at 4000g (5800 rpm in a Sorvall SS-34 rotor) for 10 minutes at room temperature.
3. Discard the supernatant, and resuspend the cell pellet in 20 ml of 10 mM MgSO<sub>4</sub>. Measure the OD<sub>600</sub> of a 1/100 dilution of the resuspended cells and dilute the cells to a final concentration of 2.0 OD<sub>600</sub> with 10 mM MgSO<sub>4</sub>.

To improve the viability of the plating bacteria during storage, incubate the cell suspension in a 100-ml sterile flask for 1 hour at 37°C with moderate agitation.

For many strains of *E. coli*, 1.0 OD<sub>600</sub>/ml is approximately equal to 1.0 × 10<sup>9</sup> bacterial cells/ml. However, the relationship between the OD<sub>600</sub> and the number of viable cells/ml varies from strain to strain and is affected by the conditions of growth. It is advisable to carry out a calibration experiment to measure the OD<sub>600</sub> of a culture of the particular strain of *E. coli* at different stages in its growth cycle and to count the number of viable cells at each of these times by plating dilutions of the culture on LB agar plates.

4. Store the suspension of plating bacteria at 4°C.
 

Suspensions of robust strains of *E. coli* may be used for up to 2–3 weeks. However, severely enfeebled strains of *E. coli* (e.g., *recA*<sup>-</sup> strains) lose viability quickly when stored under conditions of starvation at 4°C. Use fresh cultures of such strains for plating bacteriophage  $\lambda$ .
5. Melt top agar or agarose by heating it in a microwave oven for a short period of time. Store aliquots of the melted agar or agarose (3 ml for 100-mm plates, 7 ml for 200-mm plates) on a heating block or in a water bath at 47°C to keep the solution molten.

## Infection of Plating Bacteria

6. Prepare tenfold serial dilutions of the bacteriophage stocks (in SM plus gelatin). Mix each dilution by *gentle* vortexing or by tapping on the side of the tube.
 

The gelatin helps to stabilize the bacteriophage particles.

Excessive vortexing damages the tails of bacteriophage  $\lambda$  particles.
7. Dispense 0.1 ml of plating bacteria from Step 4 into a series of sterile tubes (13 or 17 × 100 mm).
8. Add 0.1 ml of each dilution of bacteriophage stock to a tube of plating bacteria. Mix the bacteria and bacteriophages by shaking or gently vortexing.
9. Incubate the mixture for 20 minutes at 37°C to allow the bacteriophage particles to adsorb to the bacteria. Remove the tubes from the water bath and allow them to cool to room temperature.
 

Always include a control tube that contains SM but no bacteriophage  $\lambda$ .

Adsorption of bacteriophage  $\lambda$  to its receptor is fairly slow, hence the requirement for 20 minutes incubation.
10. Add an aliquot of molten agar or agarose to the first tube. Mix the contents of the tube by gentle tapping or vortexing for five seconds and, *without delay*, pour the entire contents of the tube onto the center of a labeled agar plate. Try to avoid creating air bubbles. Swirl the plate gently to ensure an even distribution of bacteria and top agarose. Repeat the procedure until the contents of all the tubes have been transferred to separate labeled plates.
11. Replace the lids on the plates. Allow the top agar/agarose to harden by standing the plates for 5 minutes at room temperature. Invert the closed plates and incubate them at 37°C.
 

With some *E. coli* strains and bacteriophage vectors, better plaques are formed when the plates are incubated at temperatures other than 37°C. For example, when using the Stratagene *E. coli* strains SRB<sub>p</sub> and SRB(P2)<sub>p</sub> as hosts, an incubation temperature of 39°C is recommended. In addition,  $\lambda$ gt10 vectors produce better plaques on *E. coli hfl* strains when incubated at 39°C (for details, please see the introduction to Chapter 11).

TABLE 2-3 *E. coli* Strains Used to Propagate Bacteriophage  $\lambda$  Vectors

PHENOTYPE	RELEVANT GENOTYPE	STRAIN	USES	REFERENCES
Sup <sup>-</sup>	<i>sup<sup>+</sup></i>	R594	Nonpermissive for vectors carrying amber mutations	Campbell (1965); Borck et al. (1976)
r <sub>k</sub>	<i>supE hsdR</i>	MM294, Q358, C600, BNN93, K802	Permissive for vectors carrying amber mutations Will modify but not restrict DNA at <i>EcoRI</i> sites	Appleyard (1954); Wood (1966); Meselson and Yuan (1968); Karn et al. (1980); Young and Davis (1983a)
r <sub>k</sub>	<i>supE supF hsdR</i>	LE392, ED8654	Permissive for vectors carrying amber mutations Will modify but not restrict DNA at <i>EcoRI</i> sites	Borck et al. (1976); Murray et al. (1977)
r <sub>k</sub> <sup>-</sup>	<i>supF<sup>-</sup> hsdR</i>	NM538	Permissive for vectors carrying amber mutations Will modify but not restrict DNA at <i>EcoRI</i> sites	Frischauf et al. (1983)
r <sub>k</sub> Rec <sup>-</sup>	<i>supE supF hsdR recA</i>	NM531	Permissive for vectors carrying amber mutations Will modify but not restrict DNA at <i>EcoRI</i> sites <i>recA<sup>-</sup></i> strain	Arber et al. (1983)
r <sub>k</sub> <sup>-</sup> RecE <sup>-</sup>	<i>hsdR recBC sbcA</i>	NM519	Will modify but not restrict DNA at <i>EcoRI</i> sites Used for growth of Spi <sup>-</sup> bacteriophages	Arber et al. (1983)
r <sub>k</sub> RecD <sup>+</sup>	<i>supE supF hsdR recC</i>	TAP90	Used for production of high-titer lysates for growth of Spi <sup>-</sup> bacteriophage Will modify but not restrict DNA at <i>EcoRI</i> sites	Patterson and Dean (1987)
r <sub>k</sub> <sup>-</sup> McrB <sup>-</sup>	<i>hsdR mcrB <math>\Delta</math>lac</i>	MBM7014.5, MC1061	Used for constructing libraries in bacteriophage $\lambda$ ORF8 Will modify but not restrict DNA at <i>EcoRI</i> sites	Raleigh and Wilson (1986); Meissner et al. (1987)
r <sub>k</sub> RecD <sup>-</sup> Mcr <sup>-</sup>	<i>supE hsdR mcrB mcrA recD</i>	KW251	Permissive for vectors carrying amber mutations Used for propagation of high-titer lysates Will modify but not restrict DNA at <i>EcoRI</i> sites Permits propagation of cytosine methylated DNA	
r <sub>k</sub> <sup>-</sup> Lac <sup>-</sup> Lon <sup>-</sup>	<i>hsdR supF <math>\Delta</math>lac <math>\Delta</math>lon pMC9</i>	Y1090 <i>hsdR</i>	Permissive for growth of $\lambda$ gt11 and $\lambda$ gt18-23 Contains high levels of <i>lac</i> repressor Is deficient in the <i>lon</i> protease Will modify but not restrict DNA at <i>EcoRI</i> sites	Young and Davis (1983b); Jendrisak et al. (1987)
r <sub>k</sub> <sup>-</sup> Hfl <sup>-</sup>	<i>supE hsdR hflA</i>	BNN102 (C600 <i>hflA</i> )	Will modify but not restrict DNA at <i>EcoRI</i> sites Nonpermissive for $\lambda$ gt10 Permissive for recombinants that have foreign DNA inserted in the <i>cl</i> gene	Young and Davis (1983a)
r <sub>k</sub> Mcr RecA <sup>-</sup> <i>lacI<sup>h</sup> <math>\Delta</math>M15</i>	<i>supE <math>\Delta</math>(mcrCB<sup>-</sup> hsd SMR<sup>-</sup> mcr recA lac F<sup>+</sup> proAB<sup>+</sup> lacI<sup>h</sup> <math>\Delta</math>M15 Tn10)</i>	XLI-Blue MRF <sup>+</sup>	Permissive for vectors carrying amber mutations Will modify but not restrict DNA at <i>EcoRI</i> sites Permits $\alpha$ -complementation of $\beta$ -galactosidase in a <i>recA<sup>-</sup></i> strain	Jerpseth et al. (1992)

$r_k^- lacZ\Delta M15$	<i>supE supF hsdR</i> F' <i>proAB<sup>+</sup> lacI<sup>q</sup> lacZ\Delta M15</i>	BB4	Permissive for vectors carrying amber mutations Will modify but not restrict DNA at <i>EcoRI</i> sites Permits $\alpha$ -complementation of $\beta$ -galactosidase	Bullock et al. (1987)
$r_k^- lacZ\Delta M15 Rec^-$	<i>supE supF hsdR lac^-</i> F' <i>proAB<sup>+</sup> lacI<sup>q</sup> lacZ\Delta M15</i>	X1.1-Blue	Will modify but not restrict DNA at <i>EcoRI</i> sites Permits $\alpha$ -complementation of $\beta$ -galactosidase	Bullock et al. (1987)
$r_k^- lacI^q\Delta M15$	<i>supE</i> $\Delta(lac^- proAB)$ $\Delta(mcrB^- hsdSM)5$ F' <i>proAB lacI<sup>q</sup> Z\Delta M15</i>	NM522	Permissive for vectors carrying amber mutations Permits $\alpha$ -complementation of $\beta$ -galactosidase Permits $\alpha$ -complementation of $\beta$ -galactosidase <i>recA<sup>-</sup></i> strain	Gough and Murray (1983)
$Lac^-$	<i>supE</i> $\Delta(lac-pro)$ F' <i>proAB<sup>+</sup> lacI<sup>q</sup> lacZ^-</i>	CSH18	Permissive for vectors carrying amber mutations Used to screen recombinants made in vectors carrying a <i>lacZ</i> gene	Miller (1972); Williams and Blattner (1979)
$r_B^- m_B^- Rec^-$	<i>hsdS recA</i>	HB101	Nonpermissive for vectors carrying amber mutations Will not modify or restrict DNA at <i>EcoRI</i> sites <i>recA<sup>-</sup></i> strain	Boyer and Roulland-Dussoix (1969); Bolivar and Backman (1979)
$r_B^- m_B^-$	<i>supE supF hsdS</i>	DP50 <i>supF</i>	Permissive for vectors carrying amber mutations Will not modify or restrict DNA at <i>EcoRI</i> sites	Leder et al. (1977); B. Bachmann (pers. comm.)
$r_B^- m_B^- Rec^-$	<i>supE supF hsdS recA</i>	ED8767	Permissive for vectors carrying amber mutations Will not modify or restrict DNA at <i>EcoRI</i> sites <i>recA<sup>-</sup></i> strain	Murray et al. (1977)
$r_k^- (P2)$	<i>supE hsdR (P2)</i>	Q359	Used for selection of $Spi^-$ bacteriophage Will modify but not restrict DNA at <i>EcoRI</i> sites Permissive for vectors carrying amber mutations	Karn et al. (1980)
$r_k^- (P2)$	<i>supF hsdR (P2cox)</i>	NM539	Used for selection of $Spi^-$ bacteriophage Will modify but not restrict DNA at <i>EcoRI</i> sites Permissive for vectors carrying amber mutations	Frischauf et al. (1983)
$\lambda Eam$	(N205 <i>recA</i> [ $\lambda imm434 cIts b2 red$ <i>Eam Sam/\lambda</i> ])	BHB2688	Used to prepare packaging extracts	Hohn and Murray (1977); Hohn (1979)
$\lambda Dam$	(N205 <i>recA</i> [ $\lambda imm434 cIts b2 red$ <i>Dam Sam/\lambda</i> ])	BHB2690	Used to prepare packaging extracts	Hohn and Murray (1977); Hohn (1979)
$\lambda cos2$	<i>E. coli</i> C ( $\lambda cos2 \Delta B xis red gam am210$ <i>cIts857 nin Sam/\lambda</i> )	SMR10	Used to prepare packaging extracts	Rosenberg (1985)



**12.** Continue incubating the plates overnight, then count or select (pick) individual plaques.

Plaques begin to appear after ~7 hours of incubation and should be counted or picked after 12–16 hours. By this time, the plaques formed on robust strains of *E. coli* should be 2–3 mm in diameter.

If the plates are too dry, the plaques will grow more slowly and will not reach their full size. Freshly poured plates have different problems. During incubation at 37°C, droplets of moisture sweat onto the surface of the top agar and cause the developing plaques to streak and run into one another. This smearing can be avoided by storing the plates for 2 days at room temperature before use or by drying the plates with the lids ajar for 2 hours in a laminar-flow hood or (less desirable) a 37°C incubator. In an emergency, when there is no time to dry the plates, remove any droplets of water from the lids of the plates after the top agar has set and insert a piece of (sterile) circular filter paper into each lid. During incubation of the inverted plates at 37°C, the filter paper absorbs much of the humidity and keeps streaking to a minimum.

With experience, the size of plaques can be adjusted to suit the task at hand. For example, when screening libraries by hybridization, it is often desirable to restrict the size of the plaques so that the maximum number of bacteriophages can be screened per plate. In this case, use well-aged plates and use slightly more bacteria than usual for each lawn. Under other conditions, e.g., when using enfeebled *red gam*<sup>-</sup> strains of bacteriophage  $\lambda$ , it may be necessary to reduce the bacterial inoculum and/or to use a lower (0.6%) concentration of top agar/agarose to obtain plaques of an acceptable size. Bacteriophage  $\lambda$  plaques do not increase in size after the bacterial lawn is fully grown and the cells have reached stationary phase.

**ADDITIONAL PROTOCOL: PLAQUE-ASSAY OF BACTERIOPHAGES THAT EXPRESS  $\beta$ -GALACTOSIDASE**

Many bacteriophage  $\lambda$  vectors contain a copy of the *E. coli lacZ* gene, which encodes  $\beta$ -galactosidase. When these vectors are plated in media containing X-gal (5-bromo-4-chloro-3-indolyl- $\beta$ -D-galactopyranoside), a chromogenic substrate for  $\beta$ -galactosidase, a bright ring of blue dye is formed around the plaques. With time, the entire plaque assumes a blue tinge. When segments of foreign DNA are cloned into these vectors, the *lacZ* gene, and hence the chromogenic reaction, is disrupted and the plaques are no longer etched in blue. During construction of cDNA and genomic libraries in bacteriophage  $\lambda$  vectors, the relative number of blue and white plaques indicates the proportion of empty vectors (blue plaques) and potential recombinants (colorless plaques).

**Additional Materials**

**CAUTION:** Please see Appendix 12 for appropriate handling of materials marked with <!>.

*LB or NZCYM top agar or agarose, containing X-gal <!>*

For 3 ml of top agar, use 40  $\mu$ l of 2% X-gal. Add X-gal to cooled (47°C) top agar just before use.

*E. coli plating bacteria*

Use any strain of *E. coli* that will support lytic growth of the particular strain of bacteriophage  $\lambda$  (please see Table 2-3), as long as it is not an overproducer of  $\beta$ -galactosidase. The presence of a single copy of the *lacZ* gene in the bacterial chromosome does not interfere with the assay. Please see the information panel on  $\alpha$ -COMPLEMENTATION (Chapter 1). Prepare the bacteria as described in Protocol 1.

**Method**

1. Dilute the bacteriophage stock in SM plus gelatin.
2. Infect 0.1-ml aliquots of plating bacteria with 10  $\mu$ l of the appropriate dilutions of bacteriophage. Incubate the infected cultures for 20 minutes at 37°C.
3. Add 3 ml of molten top agar (at 47°C) containing X-gal to the first tube. Mix the contents of the tube by tapping or gentle vortexing. Pour the contents of the tube onto an agar plate.
4. Repeat Step 3 with the remaining dilutions of the bacteriophage stock.
5. When the top agar has set, invert the plates and incubate for 15–18 hours at 37°C.
6. Remove the plates from the 37°C incubator, place at room temperature for a further 2 hours, and then record the color of the plaques.

During incubation at room temperature, the intensity of the blue color is enhanced. For accurate comparison, the intensity of color in the plaques should be matched to color standards that can be obtained from Stratagene.

**ADDITIONAL PROTOCOL: MACROPLAQUES**

Macroplaques are areas of lysed bacteria (~0.5 cm in diameter) that are formed when bacteriophages from a single conventional plaque are dabbed onto a bacterial culture growing in top agar. A macroplaque typically contains ~20 times more infectious particles than a conventional plaque. Macroplaque stocks may be used to infect small-scale bacterial cultures (minipreparations) and to prepare plate lysates of bacteriophage  $\lambda$ .

**Method**

1. Add 0.1 ml of plating bacteria to 3 ml of molten top agar at 47°C. Mix the contents of the tube by tapping or gentle vortexing and then pour the contents of the tube onto an LB agar plate that has been equilibrated to room temperature. Store the plate at room temperature to allow the top agar to harden.
2. Use a sterile wooden toothpick to transfer bacteriophage from a single well-isolated plaque to the surface of the top agar. Inoculate an area ~0.3 cm in diameter by touching the toothpick lightly to the surface several times.
3. Incubate the plate for 6–8 hours at 37°C.
4. Harvest the macroplaques with the large end of a sterile borosilicate Pasteur pipette.

Each macroplaque yields several agar plugs that can be stored either together or separately in 400–500  $\mu$ l of SM. The plugs can be stored in this form for several weeks at 4°C without significant loss of bacteriophage viability.

# Protocol 2

---

## Picking Bacteriophage $\lambda$ Plaques

**G**ENETICALLY HOMOGENEOUS STOCKS OF BACTERIOPHAGE  $\lambda$  are generated by “picking” a well-isolated plaque and placing the agar/agarose containing the zone of lysis in storage solution. The resulting stock solution can be used to prepare plate lysates or liquid cultures of the bacteriophage or can be stored for later analysis. The following protocol describes a general method for picking and storing plaques.

### MATERIALS

---

**CAUTION:** Please see Appendix 12 for appropriate handling of materials marked with <!>.

#### Buffers and Solutions

Please see Appendix 1 for components of stock solutions, buffers, and reagents. Dilute stock solutions to the appropriate concentrations.

*Chloroform* <!>  
*SM*

#### Special Equipment

*Borosilicate Pasteur pipette (equipped with a rubber bulb) or a Micropipette*  
*Microfuge tubes or Polypropylene test tubes (13 x 100 mm)*

#### Vectors and Bacterial Strains

*Bacteriophage  $\lambda$ , grown as well-isolated plaques on bacterial lawn (please see Protocol 1)*

### METHOD

---

1. Place 1 ml of SM in a sterile microfuge tube or polypropylene test tube. Add 1 drop (~50  $\mu$ l) of chloroform.  
Polypropylene tubes are used because they are resistant to chloroform.

2. Use a borosilicate Pasteur pipette equipped with a rubber bulb, or a micropipette, to stab through the chosen plaque of bacteriophage  $\lambda$  into the hard agar beneath. Apply mild suction so that the plaque, together with the underlying agar, is drawn into the pipette.

Because bacteriophages can diffuse considerable distances through the layer of top agar, choose well-separated plaques. For the same reason, it is best, wherever possible, to pick plaques shortly after the bacterial lawn has grown up and the bacteriophage plaques have first appeared. Picking plaques early in their development also reduces the unwelcome possibility of obtaining a bacteriophage stock that contains significant numbers of undesirable mutants.

Alternatively, plaques may be picked by touching a sterile 8-cm wooden stick (also called an applicator or orange stick) or a sterile toothpick to the surface of the top agar/agarose in the center of the chosen plaque. Immediately place the stick in SM/chloroform in a 13 x 100-mm tube and mix the contents of the tube by vortexing to dislodge fragments of agar/agarose containing the bacteriophages.

Some investigators prefer to use the wide end of sterile borosilicate Pasteur pipettes (without cotton plugs). The agar plug stays in the pipette and can be expelled into a sterile polypropylene tube by a flick of the practiced wrist. Bacteriophages can be stored in these plugs for several weeks at 4°C without significant loss of viability, as long as the plugs do not become dehydrated.

3. Wash out the fragments of agar from the borosilicate Pasteur pipette into the tube containing SM/chloroform (prepared in Step 1). Let the capped tube stand for 1–2 hours at room temperature to allow the bacteriophage particles to diffuse from the agar. To assist the elution of the virus, rock the tube gently on a rocking platform. Store the bacteriophage suspension at 4°C.

An average bacteriophage plaque yields  $\sim 10^6$  infectious bacteriophage particles, which can be stored indefinitely at 4°C in SM/chloroform without loss of viability (please see the panel on **LONG-TERM STORAGE OF BACTERIOPHAGE  $\lambda$  STOCKS** in Protocol 3). The virus recovered from a plaque can be used as described in Protocols 3 and 4 to prepare larger stocks of bacteriophages by the plate lysis or the liquid culture methods. For screening recombinant plaques, please see the panel on **ANALYZING RECOMBINANTS USING PCR**

#### **ANALYZING RECOMBINANTS USING PCR**

When screening cDNA libraries constructed in a bacteriophage  $\lambda$  vector such as  $\lambda$ gt10 or  $\lambda$ gt11, it is often useful to establish the length of a cDNA harbored in a hybridization-positive bacteriophage before growing up a small-scale preparation of the virus. With bacteriophage  $\lambda$  vectors whose entire DNA sequence is known, or for those in which at least the DNA sequence immediately adjacent to the cloning site is known, polymerase chain reaction (PCR) can be carried out directly on the plaque lysate to determine the size of the cDNA insert. Two oligonucleotide primers complementary to the vector DNA flanking the cloning site are used in PCR, together with an aliquot of the bacteriophage eluate in SM/chloroform. A complete protocol for direct PCR analysis of bacteriophage  $\lambda$  eluates is described in Chapter 8, Protocol 12.

# Protocol 3

---

## Preparing Stocks of Bacteriophage $\lambda$ by Plate Lysis and Elution

**T**WO METHODS ARE COMMONLY USED TO PREPARE STOCKS from single plaques of bacteriophage  $\lambda$ : plate lysates (described in Protocol 3), in which the bacteriophages are propagated in bacteria grown in top agar or agarose, and small-scale liquid cultures (Protocol 4), in which the bacteriophages are propagated in bacteria growing in liquid medium. Although both methods yield useful bacteriophage stocks, the first has the advantage of allowing the investigator to determine whether or not the bacteriophages have grown successfully merely by looking at the degree of confluence of lysis. In addition, the titer of plate stocks is usually higher than that of stocks prepared from liquid cultures. A disadvantage of the first method, however, is that bacteriophage DNA isolated from plate stocks may be contaminated with sulfated polysaccharides and glycans that leach from the top agar/agarose. More often than not, these polysaccharides are innocuous and cause no trouble. Sometimes, however, they inhibit enzymes used to analyze or manipulate bacteriophage  $\lambda$  DNA. This protocol describes a reliable method for preparing plate lysates and recovering bacteriophage by elution from the top agar with SM. Alternatively, the bacteriophage may be recovered from "soft" (low concentration) top agarose by scraping the top agarose into SM (please see the panel on **ADDITIONAL PROTOCOL: PREPARING STOCKS OF BACTERIOPHAGE  $\lambda$  BY PLATE LYSIS AND SCRAPING** at the end of this protocol).

---

### MATERIALS

---

**CAUTION:** Please see Appendix 12 for appropriate handling of materials marked with <!>.

#### Buffers and Solutions

Please see Appendix 1 for components of stock solutions, buffers, and reagents. Dilute stock solutions to the appropriate concentrations.

*Chloroform* <!>  
*SM*

#### Media

*LB or NZCYM agar plates*

Freshly poured plates (10-cm or 15-cm diameter) that have been equilibrated to room temperature give the best results in these methods. The older the plates, the lower the titer of the resulting plate stock.

Adequate yields of most strains of bacteriophage  $\lambda$  can be obtained by using LB or NZCYM bottom agar as described above. However, if problems arise, improved yields can often be obtained from LB bottom agar that has been supplemented with:

- 0.3% (w/v) glucose
- 0.075 mM  $\text{CaCl}_2$
- 0.004 mM  $\text{FeCl}_3$
- 2 mM  $\text{MgSO}_4$

Glucose represses the *lamB* gene and thus reduces the amount of bacteriophage that is lost by adsorption to bacterial debris (please see the panel on **ADDITION OF MALTOSE FOR GROWTH OF  $\lambda$**  in Protocol 1). Calcium ions also reduce loss by readsorption, whereas ferric ions may stimulate respiration and suppress the lysogenic pathway of bacteriophage development (Arber et al. 1983).

*LB or NZCYM top agarose (0.7%)*

Agarose is preferred to agar in this protocol in order to minimize contamination with inhibitors that can interfere with subsequent enzymatic analysis of bacteriophage DNA.

## Centrifuges and Rotors

*Sorvall SS-34 or equivalent*

## Special Equipment

*Heating block or water bath preset to 47°C*

*Screw or snap-cap polypropylene tubes (13 × 100 mm or larger)*

## Additional Reagents

*Step 9 of this protocol requires the reagents listed in Protocol 1 of this chapter.*

## Vectors and Bacterial Strains

*Bacteriophage  $\lambda$  stock*

Prepared as described in Protocol 2. Alternatively, the source of bacteriophage may be a macroplaque (please see the panel on **ADDITIONAL PROTOCOL: MACROPLAQUES** in Protocol 1).

*E. coli plating bacteria*

Prepared as described in Protocol 1 of this chapter.

## METHOD

### 1. Prepare infected cultures for plating:

*For a 10-cm diameter Petri dish:* Mix  $10^5$  pfu of bacteriophage (usually  $\sim 1/10$  of a resuspended individual plaque or  $1/100$  of a macroplaque with 0.1 ml of plating bacteria).

*For a 15-cm Petri dish:* Mix  $2 \times 10^5$  pfu with 0.2 ml of plating cells.

Always set up at least one control tube containing uninfected cells. Incubate the infected and control cultures for 20 minutes at 37°C to allow the virus to attach to the cells.

When preparing stocks of isolated bacteriophage  $\lambda$  that grow poorly, increase the inoculum to  $10^6$  pfu per 0.1 ml of plating bacteria.

### 2. Add 3 ml of molten top agarose (47°C) (10-cm plate) or 7.0 ml of molten top agarose (47°C) (15-cm plate) to the first tube of infected cells. Mix the contents of the tube by gentle tapping or vortexing for a few seconds, and, *without delay*, pour the entire contents of the tube onto the center of a labeled agar plate. Try to avoid creating air bubbles. Swirl the plate gently to

ensure an even distribution of bacteria and top agarose. Repeat this step until the contents of each of the tubes have been transferred onto separate plates.

3. Incubate the plates *without inversion* for ~12–16 hours at 37°C.
 

Plates are not inverted during incubation to encourage sweating of fluid onto the surface of the dish, which allows the bacteriophages to spread more easily.

At the time of harvesting, the plaques should touch one another, and the only visible bacterial growth should be a gauzy webbing that marks the junction between adjacent plaques. The plate containing uninfected cells should develop into a smooth lawn of confluent bacterial growth.
4. Remove the plates from the incubator and add SM (5 ml to each 10-cm plate or 10 ml to each 15-cm plate). Store the plates for several hours at 4°C on a shaking platform.
5. Using a separate Pasteur pipette for each plate, transfer as much of the SM as possible into sterile screw- or snap-cap polypropylene tubes.
6. Add 1 ml of fresh SM to each plate, swirl the fluid gently, and store the plates for 15 minutes in a tilted position to allow all of the fluid to drain into one area. Again remove the SM and combine it with the first harvest. Discard the plate.
7. Add 0.1 ml of chloroform to each of the tubes containing SM, vortex the tubes briefly, and then remove the bacterial debris by centrifugation at 4000g (5800 rpm in a Sorvall SS-34 rotor) for 10 minutes at 4°C.
8. Transfer the supernatants to fresh polypropylene tubes, and add 1 drop of chloroform to each tube. Store the resulting bacteriophage plate stocks at 4°C.
9. Measure the concentration of infectious virus particles in each stock by plaque assay as described in Protocol 1.

The titer of plate stocks should be  $\sim 10^9$  to  $10^{10}$  pfu/ml and should remain stable as long as the stock is stored properly (please see the panel on **LONG-TERM STORAGE OF BACTERIOPHAGE  $\lambda$  STOCKS**).

#### **LONG-TERM STORAGE OF BACTERIOPHAGE $\lambda$ STOCKS**

Stocks of most strains of bacteriophage  $\lambda$  are stable for several years when stored at 4°C in SM containing a small amount of chloroform (0.3% v/v). However, many investigators have found that some bacteriophage  $\lambda$  recombinants lose viability when stored in this way for a few months. This problem can usually be avoided by using freshly distilled chloroform or chloroform that has been extracted with anhydrous sodium bicarbonate to remove products of photolysis. However, we also recommend that the titer of master stocks be checked every 2–3 months and that master stocks of all important bacteriophage  $\lambda$  strains whose genotypes have been verified be stored at –70°C. Before storage, add dimethylsulfoxide (DMSO) to the bacteriophage stock to a final concentration of 7% (v/v). Gently invert the tube several times to ensure that the DMSO and the virus stock are thoroughly mixed. Plunge the sealed tube into liquid nitrogen. When the liquid has frozen, transfer the tube to a –70°C freezer for long-term storage. To recover the bacteriophages:

1. Add 0.1 ml of plating bacteria to 3 ml of molten top agar at 47°C. Mix the contents of the tube by tapping or gentle vortexing and then pour the contents of the tube onto an LB agar plate that has been equilibrated to room temperature. Store the plate for 10 minutes at room temperature to allow the top agar to harden.
2. Scrape the surface of the frozen bacteriophage stock with a sterile 18-gauge needle. Gently streak the needle over the hardened surface of the top agar. Incubate the infected plate for 12–16 hours at the appropriate temperature to obtain bacteriophage plaques.
3. Pick a well-isolated plaque and generate a high-titer stock by one of the methods described in Protocol 3 or 4.

**ALTERNATIVE PROTOCOL: PREPARING STOCKS OF BACTERIOPHAGE  $\lambda$  BY PLATE LYSIS AND SCRAPING**

An alternative method for preparing plate lysates involves recovering the bacteriophages from the plate by scraping the soft agarose into SM. This approach suffers from the drawback of contamination with sulfated polysaccharides and glycans that may inhibit the activities of some enzymes used for further manipulations of recovered DNA.

Recovery of bacteriophage from plate stocks by elution is described in Protocol 3; preparation of bacteriophage stocks from small liquid cultures is presented in Protocol 4.

**Additional Materials***LB or NZCYM top agarose*

Prepare as a 0.5% (w/v) solution instead of the 0.7% solution. The use of the lower concentration of top agarose facilitates removal of the layer of top agarose. Agarose is preferred to agar in this protocol in order to minimize contamination with inhibitors that can interfere with subsequent enzymatic analysis of bacteriophage DNA.

Adequate yields of most strains of bacteriophage  $\lambda$  can be obtained by using LB or NZCYM bottom agar as described above. However, if problems arise, improved yields can often be obtained from LB bottom agar that has been supplemented with:

- 0.3% (w/v) glucose
- 0.075 mM  $\text{CaCl}_2$
- 0.004 mM  $\text{FeCl}_3$
- 2 mM  $\text{MgSO}_4$

Glucose represses the *lamB* gene and thus reduces the amount of bacteriophage that is lost by adsorption to bacterial debris (please see the panel on **ADDITION OF MALTOSE FOR GROWTH OF  $\lambda$**  in Protocol 1). Calcium ions also reduce loss by readsorption, whereas ferric ions may stimulate respiration and suppress the lysogenic pathway of bacteriophage development (Arber et al. 1983).

**Method****1. Prepare infected cultures for plating:**

*For a 10-cm diameter Petri dish:* Mix  $10^5$  pfu of bacteriophage (usually  $\sim 1/10$  of a resuspended individual plaque or  $1/100$  of a macroplaque with 0.1 ml of plating bacteria).

*For a 15-cm Petri dish:* Mix  $2 \times 10^5$  pfu with 0.2 ml of plating cells.

Always set up at least one control tube containing uninfected cells. Incubate the infected and control cultures for 20 minutes at  $37^\circ\text{C}$  to allow the virus to attach to the cells.

When preparing stocks of isolated bacteriophage  $\lambda$  that grow poorly, increase inoculum to  $10^6$  pfu/0.1 ml of plating bacteria.

**2. Add 3 ml of molten top agarose ( $47^\circ\text{C}$ ) (10-cm plate) or 7.0 ml of molten top agarose ( $47^\circ\text{C}$ ) (15-cm plate) to the first tube of infected cells. Mix the contents of the tube by gentle tapping or vortexing for five seconds and, *without delay*, pour the entire contents of the tube onto the center of a labeled agar plate. Try to avoid creating air bubbles. Swirl the plate gently to ensure an even distribution of bacteria and top agarose. Repeat this step until the contents of all the tubes have been transferred onto separate plates.****3. Incubate the plates *without inversion* for 8 hours at  $37^\circ\text{C}$ .**

Plates are not inverted during incubation to prevent the top agar/agarose from slipping and to encourage sweating of fluid onto the surface of the dish, which allows the bacteriophages to spread more easily.

At the time of harvesting, the plaques should touch one another, and the only visible bacterial growth should be a gauzy webbing that marks the junction between adjacent plaques. The plate containing uninfected cells should develop into a smooth lawn of confluent bacterial growth.

**4. When confluent lysis has occurred, add 5 ml of SM to the plate and gently scrape the soft top agarose into a sterile centrifuge tube, using a sterile bent glass rod.****5. Add an additional 2 ml of SM to the plate to rinse off any remaining top agarose, and combine it with the top agarose in the centrifuge tube (from Step 4).****6. Add 0.1 ml of chloroform to the agarose suspension and mix the suspension by slow rotation or gentle shaking for 15 minutes at  $37^\circ\text{C}$ .****7. Centrifuge the suspension at  $4000g$  (5800 rpm in a Sorvall SS-34 rotor) for 10 minutes at  $4^\circ\text{C}$ . Recover the supernatant, add 1 drop of chloroform, and store the virus stock as described in the panel on **LONG-TERM STORAGE OF BACTERIOPHAGE  $\lambda$  STOCKS**.**

The titer of plate stocks should be  $\sim 10^9$  to  $10^{10}$  pfu/ml and should remain stable as long as the stock is stored properly.



# Protocol 4

---

## Preparing Stocks of Bacteriophage $\lambda$ by Small-scale Liquid Culture

**H**IGH-TITER STOCKS OF BACTERIOPHAGE  $\lambda$  MAY BE PREPARED from small-scale liquid cultures. The method presented here was originally described by Leder et al. (1977). In general, the yields of bacteriophage  $\lambda$  are lower and more variable than those obtained by plate lysis. A larger initial inoculum of bacteriophage is also required. However, stocks of bacteriophage  $\lambda$  grown in liquid culture are cleaner and free of sulfated polysaccharides that may contaminate plate lysates (please see Protocol 3).

### MATERIALS

---

**CAUTION:** Please see Appendix 12 for appropriate handling of materials marked with <!.>.

#### Buffers and Solutions

Please see Appendix 1 for components of stock solutions, buffers, and reagents. Dilute stock solutions to the appropriate concentrations.

*Chloroform* <!.>

*SM*

#### Media

*LB or NZCYM medium prewarmed to 37°C*

#### Centrifuges and Rotors

*Sorvall SS-34 or equivalent*

#### Special Equipment

*Incubator preset to 30°C*

*Polypropylene culture tube (17 × 100 mm)*

#### Vectors and Bacterial Strains

*Bacteriophage  $\lambda$  stock*

Prepared as described in Protocol 2 of this chapter.

**METHOD**

---

1. Inoculate a single colony of an appropriate *E. coli* strain into 5 ml of NZCYM or LB medium in a sterile polypropylene culture tube. Incubate the culture overnight with vigorous shaking at 30°C.

Growth at lower temperature increases the chance that the cells will not have reached saturation during the overnight growth period, hence preventing the accumulation of large amounts of cell debris in the medium. Bacteriophages added to saturated cultures can adsorb to the LamB protein present on cellular debris, thereby reducing the titer of the bacteriophage inoculum.

Alternatively, grow a small overnight culture at 37°C, dilute into 5 ml of NZCYM or LB medium in a sterile polypropylene tube, and incubate the culture for 2–3 hours at 37°C.

2. Transfer 0.1 ml of the fresh overnight bacterial culture (prepared in Step 1) to a sterile 17 × 100-mm polypropylene culture tube with a loose-fitting cap. Infect the culture with  $\sim 10^6$  pfu of bacteriophage  $\lambda$  in 50–100  $\mu$ l of SM.

Although most strains of bacteriophage grow well in liquid culture and routinely yield lysates containing  $5 \times 10^8$  pfu/ml, there are some strains that replicate poorly. This problem can often be solved by increasing the ratio of bacteriophage to bacteria in the infection or by growing the infected culture at 39°C, the optimum temperature for growth of certain strains of bacteriophage. In addition, some investigators prefer to carry out the adsorption step at 0°C in the presence of 5 mM CaCl<sub>2</sub> (Patterson and Dean 1987). This procedure allows a more uniform infection and synchronous growth of the bacteriophage.

3. Incubate the infected culture for 20 minutes at 37°C to allow the bacteriophage particles to adsorb to the bacteria.
4. Add 4 ml of NZCYM or LB medium, prewarmed to 37°C, and incubate the culture with vigorous agitation until lysis occurs (usually 8–12 hours at 37°C).

Agitation is best accomplished by positioning the culture tube in a shaker incubator (300 cycles/minute). To ensure adequate aeration, the cap of the culture tube *should not* be tightly closed.

The onset of lysis is marked by a distinct decrease in turbidity of the culture caused by the destruction of the bacterial cells. If the culture is held up to the light, the Schlieren patterns and silky appearance of a dense, unlysed bacterial culture should not be visible. Cellular debris, appearing as whitish strings in the medium, may be visible upon lysis.

If lysis does not occur or is incomplete after 12 hours of incubation, add an equal volume of prewarmed NZCYM or LB medium to the culture and continue incubation for a further 2–3 hours at 37°C with vigorous agitation.

5. After lysis has occurred, add 2 drops ( $\sim 100$   $\mu$ l) of chloroform and continue incubation for 15 minutes at 37°C.
6. Centrifuge the culture at 4000g (5800 rpm in a Sorvall SS-34 rotor) for 10 minutes at 4°C.
7. Recover the supernatant, add 1 drop ( $\sim 50$   $\mu$ l) of chloroform, and store the virus stock as described in the panel on **LONG-TERM STORAGE OF BACTERIOPHAGE  $\lambda$  STOCKS** in Protocol 3.

# Protocol 5

---

## Large-scale Growth of Bacteriophage $\lambda$ : Infection at Low Multiplicity

**L**ARGE QUANTITIES OF BACTERIOPHAGE  $\lambda$  MAY BE PREPARED by infection of a bacterial culture at low multiplicity (described in this protocol) or by infection at high multiplicity (presented in the panel on **ALTERNATIVE PROTOCOL: LARGE-SCALE GROWTH OF BACTERIOPHAGE  $\lambda$ : INFECTION AT HIGH MULTIPLICITY** at the end of this protocol). After infection at low multiplicity, the culture is transferred immediately to a large volume of medium. Because only a small fraction of the initial bacterial population is infected, the uninfected cells in the culture continue to divide for several hours. However, successive rounds of growth and reinfection lead to the production of increasing quantities of bacteriophage. Eventually, all of the bacteria become infected and complete lysis of the culture occurs. Care is required with this method because small changes in the ratio of cells to bacteriophage particles in the initial infection greatly affect the final yield of bacteriophage particles. Furthermore, the optimum ratio varies for different strains of bacteriophage  $\lambda$  and bacteria. With a little effort, however, the method can be adapted for use with most combinations of virus and host cells. This approach is particularly well-suited to slow-growing strains of bacteriophage  $\lambda$  (e.g., those harboring large genomic DNA inserts).

This protocol is a modification of a method first described by Blattner et al. (1977) and is but one of many variants in common use.

### MATERIALS

---

**CAUTION:** Please see Appendix 12 for appropriate handling of materials marked with <!>.

#### Buffers and Solutions

Please see Appendix 1 for components of stock solutions, buffers, and reagents. Dilute stock solutions to the appropriate concentrations.

*Chloroform* <!>

*SM*

#### Media

*NZCYM*

For a starter culture, prepare 100 ml of NZCYM in a 500-ml conical flask. For subsequent large-scale culture, prepare 4  $\times$  500-ml aliquots of NZCYM in 2-liter flasks, prewarmed to 37°C. Four additional 500-ml aliquots may be needed for Step 9.

## Centrifuges and Rotors

*Sorvall SS-34 or equivalent*

## Additional Reagents

*Step 11 of this protocol requires the reagents listed in Protocol 6 of this chapter.*

## Vectors and Bacterial Strains

*High-titer stock of bacteriophage  $\lambda$*

Prepared as described in Protocol 3 or 4 of this chapter. The titer should be  $10^9$  to  $10^{10}$  pfu/ml.

## METHOD

---

1. Inoculate 100 ml of NZCYM in a 500-ml conical flask with a single colony of an appropriate bacterial host. Incubate the culture overnight at 37°C with vigorous agitation.
2. Measure the OD<sub>600</sub> of the culture. Calculate the cell concentration assuming that 1 OD<sub>600</sub> =  $1 \times 10^9$  cells/ml.
3. Withdraw four aliquots, each containing  $10^{10}$  cells. Centrifuge each aliquot at 4000g (5800 rpm in a Sorvall SS-34 rotor) for 10 minutes at room temperature. Discard the supernatants.
4. Resuspend each bacterial pellet in 3 ml of SM.
5. Add the appropriate number of infectious bacteriophage particles and swirl the culture to ensure that the inoculum is dispersed rapidly throughout the culture.
 

The number of bacteriophage particles used is crucial. For strains of bacteriophage  $\lambda$  that grow well (e.g., EMBL3 and 4 and  $\lambda$ gt10), add  $5 \times 10^7$  pfu to each suspension of  $10^{10}$  cells; for bacteriophages that grow relatively poorly (e.g., the Charon series), it is better to increase the starting inoculum to  $5 \times 10^8$  pfu. However, there are no hard and fast rules, and the conscientious investigator will undoubtedly want to experiment to find the multiplicity that gives the best results.
6. Incubate the infected cultures for 20 minutes at 37°C with intermittent swirling.
7. Add each infected aliquot to 500 ml of NZCYM, prewarmed to 37°C in 2-liter flasks. Incubate the cultures at 37°C with vigorous shaking (300 cycles/minute in a rotary shaker).
8. Begin to monitor the cultures for lysis after 8 hours. Concomitant growth of bacteria and bacteriophages should occur, resulting in lysis of the culture after 8–12 hours. If lysis is observed, proceed to Step 10.
 

A fully lysed culture contains a considerable amount of bacterial debris, which can vary in appearance from a fine, splintery precipitate to much larger, stringy clumps. If the cultures are held up to the light, the Schlieren patterns and silky appearance of a dense, unlysed bacterial culture should not be visible.
9. If lysis is not apparent after 12 hours, check a small sample of the cultures for evidence of bacteriophage growth.
  - a. Transfer two aliquots (1 ml each) of the infected culture into glass tubes.
  - b. Add 1 or 2 drops of chloroform (~50–100  $\mu$ l) to one of the tubes, and incubate both tubes for 5–10 minutes at 37°C with intermittent shaking.

- c. Compare the appearance of the two cultures by holding the tubes up to a light. If infection is near completion but the cells have not yet lysed, the chloroform will cause the cells to burst and the turbid culture will clear to the point where it is translucent. In this case, proceed to Step 10.

If lysis does not occur or is incomplete, the preparation can sometimes be rescued by adding to each of the cultures an additional 500 ml of NZCYM, preheated to 37°C. Continue to incubate the cultures for a further 2–3 hours at 37°C with vigorous shaking (300 cycles/minute in a rotary shaker).

10. Add 10 ml of chloroform to each flask, and continue the incubation for a further 10 minutes at 37°C with shaking.
11. Cool the cultures to room temperature and proceed to precipitate the bacteriophage particles as described in Protocol 6.

Further purification of bacteriophage particles may be achieved by using one of the methods presented in Protocols 8 through 10 of this chapter.

#### **ALTERNATIVE PROTOCOL: LARGE-SCALE GROWTH OF BACTERIOPHAGE $\lambda$ : INFECTION AT HIGH MULTIPLICITY**

Large quantities of bacteriophage  $\lambda$  may be prepared by infection of a bacterial culture at high multiplicity as described in this protocol; alternative preparation of large quantities of bacteriophage by infection at low multiplicity is presented in Protocol 5. During infection at high multiplicity, most of the bacteria in the culture are infected at the beginning of the procedure. Therefore, growth of bacteriophages is completed in a short time (usually 3–4 hours) and is marked by complete lysis of the bacterial culture. This method is commonly used to prepare large stocks of rapidly growing strains of bacteriophage  $\lambda$ , for example,  $\lambda$ gt10 recombinants containing cDNA inserts.

#### **Additional Materials**

##### **NZCYM**

For the starter culture used in Step 1, prepare 5 ml of NZCYM in a 15-ml culture tube. For subsequent large-scale culture, prepare 4 x 500-ml aliquots of NZCYM in 2-liter flasks, prewarmed to 37°C.

Step 5 of this protocol requires the reagents listed in Protocol 6 of this chapter.

#### **Method**

1. Inoculate 5 ml of NZCYM in a 15-ml culture tube with a single colony of an appropriate bacterial host. Incubate the culture overnight at 37°C with vigorous agitation.
2. Inoculate 500 ml of NZCYM, prewarmed to 37°C in each of four 2-liter flasks, with 1 ml of the overnight culture per flask. Incubate the cultures at 37°C, with vigorous shaking, until the  $OD_{600}$  of the cultures reaches 0.5 (3–4 hours).
3. Add  $10^{10}$  pfu of bacteriophage  $\lambda$  in SM to each flask, and continue incubating the cultures at 37°C with vigorous shaking until lysis occurs (usually 3–5 hours).  
To maximize the yield of particular strains of bacteriophage  $\lambda$ , it may be necessary to adjust the multiplicity of infection or the length of incubation.
4. Add 10 ml of chloroform to each flask, and continue the incubation for a further 10 minutes at 37°C with shaking.
5. Cool the cultures to room temperature and precipitate the bacteriophage particles, as described in Protocol 6.

Further purification of bacteriophage particles may be achieved by using one of the methods presented in Protocols 8 through 10 of this chapter.

# Protocol 6

---

## Precipitation of Bacteriophage $\lambda$ Particles from Large-scale Lysates

**B**ACTERIOPHAGE  $\lambda$ , PREPARED FROM LARGE-SCALE CULTURES as described in Protocol 5, may be recovered from the lysate by precipitation with polyethylene glycol (PEG) in the presence of high salt. Residual cellular debris and PEG are subsequently extracted by treatment with chloroform, and the bacteriophage particles may be subjected to further purification as described in Protocols 8 through 10. Before further purification, we recommend analysis of the yield of the bacteriophage preparation (please see Protocol 7).

### MATERIALS

---

**CAUTION:** Please see Appendix 12 for appropriate handling of materials marked with <!.>.

#### Buffers and Solutions

Please see Appendix 1 for components of stock solutions, buffers, and reagents. Dilute stock solutions to the appropriate concentrations.

*Chloroform* <!.>

*NaCl (solid)*

*Polyethylene glycol (PEG 8000)* <!.>

Use ~50 g for each 500 ml of culture.

*SM*

#### Enzymes and Buffers

*Pancreatic DNase I (1 mg/ml)*

*Pancreatic RNase (1 mg/ml) in TE (pH 7.6)*

#### Centrifuges and Rotors

*Sorvall GSA rotor or equivalent*

#### Special Equipment

*Graduated cylinder (2 liters)*

#### Vectors and Bacterial Strains

*E. coli culture, infected with bacteriophage  $\lambda$  and lysed*

Prepared as described in Protocol 5 of this chapter.

## METHOD

---

### Precipitation of Bacteriophage Particles with PEG

1. Cool the lysed cultures containing bacteriophage  $\lambda$  to room temperature. Add pancreatic DNase I and RNase, each to a final concentration of 1  $\mu\text{g}/\text{ml}$ . Incubate the lysed cultures for 30 minutes at room temperature.

Crude commercial preparations of both DNase I and RNase are more than adequate to digest the nucleic acids liberated from lysed bacteria in this step of the protocol. Without digestion, a significant number of bacteriophage particles become entrapped in the slime of host nucleic acids.

2. To each 500-ml culture, add 29.2 g of solid NaCl (final concentration, 1 M). Swirl the cultures until the salt has dissolved. Store the cultures for 1 hour on ice.

The addition of NaCl promotes dissociation of bacteriophage particles from bacterial debris and is required for efficient precipitation of bacteriophage particles by PEG. Some investigators prefer to add the PEG (Step 4) at the same time as the NaCl (Step 2). The centrifugation step (3) may then be omitted. However, be warned that the simultaneous addition of PEG and NaCl works efficiently only if the bacteriophage grows well and the titer of bacteriophage in the original lysed culture is  $>2 \times 10^{10}$  pfu/ml.

3. Remove debris by centrifugation at 11,000g (8300 rpm in a Sorvall GSA rotor) for 10 minutes at 4°C. Combine the supernatants from the four cultures into a clean 2-liter graduated cylinder.
4. Measure the volume of the pooled supernatants and then transfer the preparation to a clean 2-liter flask. Add solid PEG 8000 to a final concentration of 10% w/v (i.e., 50 g per 500 ml of supernatant). Dissolve the PEG by slow stirring on a magnetic stirrer at room temperature.
5. Transfer the solution to polypropylene centrifuge bottles, cool the bacteriophage/PEG solution in ice water, and store the centrifuge bottles for at least 1 hour on ice to allow the bacteriophage particles to precipitate.
6. Recover the precipitated bacteriophage particles by centrifugation at 11,000g (8300 rpm in a Sorvall GSA rotor) for 10 minutes at 4°C. Discard the supernatants, and stand the inverted centrifuge bottles in a tilted position for 5 minutes to allow the remaining fluid to drain away from the pellet. Remove any residual fluid with a pipette.

### Extraction of Bacterial Debris with Chloroform

7. Use a wide-bore pipette equipped with a rubber bulb to resuspend the bacteriophage pellet gently in SM (8 ml for each 500 ml of supernatant from Step 3). Place the centrifuge bottles on their sides at room temperature for 1 hour so that the SM covers and soaks the pellets.

Wash the walls of the centrifuge bottle gently but thoroughly, as the precipitate of bacteriophages sticks to them, especially if the bottle is old and pitted. The tails can be sheared from bacteriophage  $\lambda$  particles by violent pipetting.

8. Extract the PEG and cell debris from the bacteriophage suspension by adding an equal volume of chloroform. Vortex the mixture gently for 30 seconds. Separate the organic and aqueous phases by centrifugation at 3000g (4300 rpm in a Sorvall GSA rotor) for 15 minutes at 4°C. Recover the aqueous phase, which contains the bacteriophage particles.

To determine yield, analyze the bacteriophage suspension by gel electrophoresis (Protocol 7); it may be subjected to further purification by centrifugation using one of the methods described in Protocols 8 through 10 of this chapter.

# Protocol 7

---

## Assaying the DNA Content of Bacteriophage $\lambda$ Stocks and Lysates by Gel Electrophoresis

**T**HIS PROTOCOL DESCRIBES A RAPID TECHNIQUE TO ESTIMATE the DNA content of bacteriophage  $\lambda$  stocks. The method can be used to (1) find out whether the yield of bacteriophage particles in stocks and lysates is sufficient to justify pressing ahead with full-scale purification and (2) monitor the purification process and to locate troublesome steps.

### MATERIALS

---

**CAUTION:** Please see Appendix 12 for appropriate handling of materials marked with <!.>.

#### Buffers and Solutions

Please see Appendix 1 for components of stock solutions, buffers, and reagents. Dilute stock solutions to the appropriate concentrations.

*2.5x SDS-EDTA dye mix*

#### Enzymes and Buffers

*DNase I dilution buffer*

*Pancreatic DNase I (1 mg/ml)*

#### Gels

*Agarose gel (0.7%) cast in 0.5x TBE, containing 0.5  $\mu$ g/ml ethidium bromide <!.>*

#### Nucleic Acids and Oligonucleotides

*Bacteriophage  $\lambda$  DNA (control DNA)*

*Please see Step 5.*

#### Special Equipment

*Water bath preset to 65°C*

#### Vectors and Bacterial Strains

*Bacteriophage  $\lambda$  lysates or stocks*

*Prepared by using one of the methods described in Protocols 3 and 4 (for small-scale lysates) or Protocol 5 (for large-scale lysates) of this chapter.*



## METHOD

---

1. Make a working solution of pancreatic DNase I (1  $\mu\text{g}/\text{ml}$ ) as follows: Dilute 1  $\mu\text{l}$  of the stock solution of DNase I with 1 ml of ice-cold DNase I dilution buffer.
2. Mix the solution by gently inverting the closed tube several times. Take care to avoid bubbles and foam. Store the solution in ice until needed. Discard the working solution after use.

Crude plate lysates usually yield a clean band of bacteriophage  $\lambda$  DNA. However, lysates of liquid cultures almost always contain an abundance of fragments of bacterial DNA that may obscure the band of bacteriophage DNA in the agarose gel. This problem can be avoided by treating aliquots of the crude lysates with pancreatic DNase I (Step 3) before releasing the bacteriophage  $\lambda$  DNA from the bacteriophage particles with SDS and EDTA (Step 4).
3. Transfer 10  $\mu\text{l}$  of crude bacteriophage lysate or stock to a microfuge tube. Add 1  $\mu\text{l}$  of the working solution of pancreatic DNase and incubate the mixture for 30 minutes at 37°C.
4. Add 4  $\mu\text{l}$  of 2.5 $\times$  SDS-EDTA dye mixture and incubate the closed tube for 5 minutes at 65°C.

This procedure cracks the bacteriophage coats, releases the viral DNA, and, at the same time, inactivates DNase.
5. Load the sample onto an 0.7% agarose gel containing 0.5  $\mu\text{g}/\text{ml}$  ethidium bromide.

As controls, use samples containing 5, 25, and 100 ng of bacteriophage  $\lambda$  DNA.
6. Perform electrophoresis at <5 V/cm until the bromophenol blue has migrated 3–4 cm.

The bands of DNA will be smeared if the voltage is too high.
7. Examine the gel under UV illumination. Use the intensity of fluorescence of the DNA standards as a guide to estimate the amount of bacteriophage  $\lambda$  DNA in the test sample.

A high-titer lysate (10  $\mu\text{l}$ ) should contain between 10 ng and 50 ng of bacteriophage DNA.

# Protocol 8

---

## Purification of Bacteriophage $\lambda$ Particles by Isopycnic Centrifugation through CsCl Gradients

**S**EVERAL VENERABLE METHODS ARE AVAILABLE TO PURIFY BACTERIOPHAGE  $\lambda$  particles from bacterial lysates. The choice among these methods is dictated by the size of the lysate and degree of purity required for the task at hand. Various options for purification are presented in this protocol, and in the panel on **ALTERNATIVE PROTOCOL: PURIFICATION OF BACTERIOPHAGE  $\lambda$  PARTICLES BY ISOPYCNIC CENTRIFUGATION THROUGH CsCl EQUILIBRIUM GRADIENTS**, as well as in Protocols 9 and 10.

Isopycnic centrifugation through CsCl gradients is used to prepare infectious bacteriophage  $\lambda$  particles of the highest purity that are essentially free of contaminating bacterial nucleic acids (please see the panels on **CsCl STEP GRADIENTS** and **CsCl EQUILIBRIUM GRADIENTS** in this protocol). DNA prepared from these particles is ideal for use as templates for DNA sequencing, for subcloning into plasmid vectors, and for generating probes that can be used for in situ hybridization. A secondary advantage is that the stocks are highly concentrated ( $>10^{11}$  pfu/ml) and maintain their infectivity for many years when stored at 4°C. The procedure given here is a modification of the classic method described by Yamamoto et al. (1970) and is suitable for large-scale ( $>1$  liter) liquid cultures. Protocol 9 is a faster version that is more appropriate for smaller cultures.

In Protocols 9 and 10, bacteriophage  $\lambda$  particles are centrifuged at high speed and deposited at the bottom of the centrifuge tube. Although the resulting preparations are not as pure as those generated by isopycnic centrifugation, they yield intact DNA suitable for routine subcloning or for preparation of bacteriophage  $\lambda$  arms.

### MATERIALS

---

#### Buffers and Solutions

**Please see Appendix 1 for components of stock solutions, buffers, and reagents. Dilute stock solutions to the appropriate concentrations.**

*CsCl (solid)*

*CsCl solutions*

Use a high quality (molecular biology grade) of solid CsCl to prepare three solutions of different densities by adding solid CsCl to SM, as indicated below. Store the solutions at room temperature.

CsCl Solutions Prepared in SM (100 ml) for Step Gradients

Density $\rho$ (g/ml)	CsCl (g)	SM (ml)	Refractive Index $\eta$
1.45	60	85	1.3768
1.50	67	82	1.3815
1.70	95	75	1.3990

*Ethanol*

## Centrifuges and Rotors

Beckman SW41 or SW28 rotor or equivalent

Beckman Ti50 or SW50.1 rotor or equivalent, with clear centrifuge tubes  
(c.g., Beckman Ultra-Clear tubes)

## Special Equipment

Hypodermic needle (21 gauge)

## Vectors and Bacterial Strains

Suspension of bacteriophage  $\lambda$  particles

Prepared as described in Protocol 6 of this chapter.

## METHOD

---

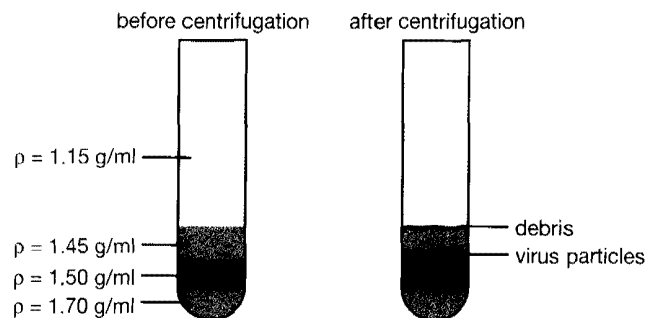
1. Measure the volume of the bacteriophage suspension, and add 0.5 g of solid CsCl per ml of bacteriophage suspension. Place the suspension on a rocking platform until the CsCl is completely dissolved.
2. Pour enough CsCl step gradients to fractionate the bacteriophage suspension. Each gradient can accommodate ~16 ml of bacteriophage suspension. The number of step gradients required equals the final aqueous volume (Step 1) divided by 0.4 x tube volume (please see note below). Use clear plastic centrifuge tubes (e.g., Beckman Ultra-Clear tubes) that fit the Beckman SW41 or SW28 rotor (or equivalent).

The step gradients may be made either by carefully layering three CsCl solutions of decreasing density on top of one another or by layering solutions of increasing density under one another.

Some types of centrifuge tubes (e.g., Ultra-Clear) are hydrophobic, which causes the CsCl solutions to run down the tubes as droplets rather than in a continuous stream. When using tubes of this type, it is better to form a density gradient by underlaying rather than overlaying the solution.

3. Make a mark with a permanent felt-tipped marker pen on the outside of the tube opposite the position of the interface between the  $\rho = 1.50$  g/ml layer and the  $\rho = 1.45$  g/ml layer (Figure 2-10).

The CsCl step gradients should occupy ~60% of the volume of the ultracentrifuge tube. For example, in a Beckman SW28 tube (or equivalent), which hold 38 ml, the step gradients consist of 7.6 ml of each of the three CsCl solutions. Balance tubes should be poured with the same CsCl density solutions.



**FIGURE 2-10** CsCl Gradients for Purifying Bacteriophage  $\lambda$

After centrifugation, the bacteriophage particles form a visible band at the interface between the 1.45 g/ml and 1.50 g/ml CsCl layers.

4. Carefully layer the bacteriophage suspension over the step gradients. Centrifuge the gradients at 87,000g (22,000 rpm in a Beckman SW28 rotor) for 2 hours at 4°C.

#### CsCl STEP GRADIENTS

The CsCl step gradients separate the bacteriophage particles from most of the cellular proteins, including viral proteins that are used to package the bacteriophage DNA and that are synthesized in infected cells in large excess. Cellular and viral proteins have a density of  $\sim 1.3$  g/ml. Wild-type bacteriophage  $\lambda$  has a density of  $\sim 1.5$  g/ml, and the particles therefore become concentrated in a visible band at the interface between the 1.45-g/ml layer and the 1.50-g/ml layer. Some recombinant viruses have a higher density because they carry inserts of foreign DNA whose GC content is high or because the amount of DNA in the recombinant particles is larger than the genome of the parental vector. Usually, the bluish band of bacteriophage particles is thick (1–2 mm) and very easy to see. If the yield of bacteriophage particles is low, place the gradient against a black background and shine a light from above to locate the band of particles.

If the yields of purified bacteriophage are consistently low, the number of infectious bacteriophage particles should be measured in samples taken at various stages during the purification to determine where losses are occurring. Alternatively, monitor the amount of viral DNA present at different stages by gel electrophoresis. This rapid and inexpensive method helps to locate problem areas and, with practice, can be used routinely to determine whether the yield of bacteriophage particles is sufficient to justify pressing ahead with full-scale purification. The gel assay is described in Protocol 7.

Failure to include adequate concentrations of  $Mg^{2+}$  in solutions used during the purification of bacteriophage  $\lambda$  can drastically lower virus yields. The virus particles are exceedingly sensitive to EDTA and other chelators, and it is essential that  $Mg^{2+}$  (10–30 mM) be present at all stages of the purification to prevent disintegration of the particles.

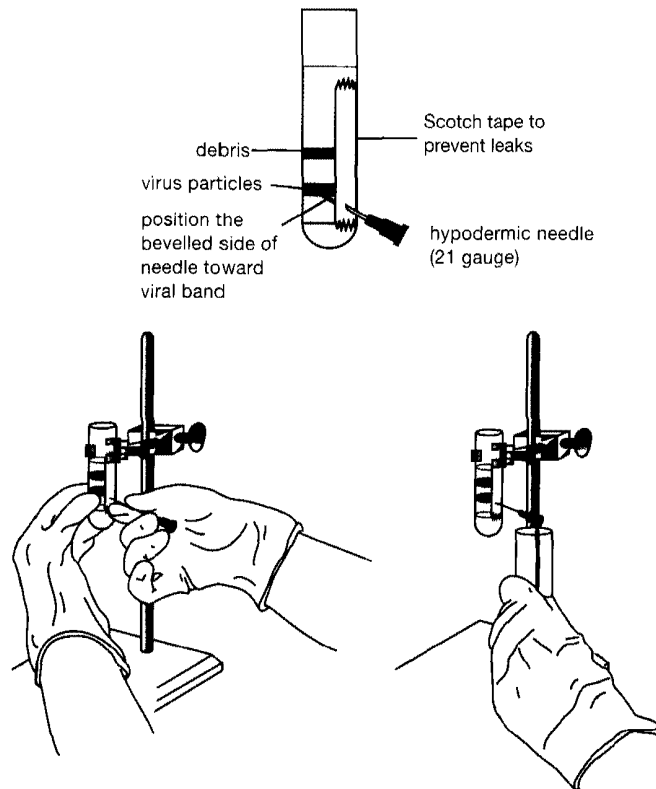
5. Collect the bacteriophage particles by puncturing the side of the tube as follows.
  - a. Carefully wipe the outside of the tube with ethanol to remove any grease or oil, and then attach a piece of Scotch Tape to the outside of the tube, level with the band of bacteriophage particles.
 

The tape acts as a seal to prevent leakage around the needle.
  - b. Use a 21-gauge hypodermic needle (no syringe-barrel required) to puncture the tube through the tape and collect the band of bacteriophage particles (Figure 2-11).
 

Keep fingers away from the path of the needle in case the needle penetrates through the tube. Take care not to contaminate the bacteriophage particles with material from other bands that are visible in the gradient. These bands contain various types of bacterial debris and unassembled bacteriophage components.
6. Place the suspension of bacteriophage particles in an ultracentrifuge tube that fits a Beckman Ti50 or SW50.1 rotor (or equivalent) and fill the tube with CsCl solution ( $\rho = 1.5$  g/ml in SM). Centrifuge at 150,000g (41,000 rpm in a Beckman Ti50 rotor) for 24 hours at 4°C or at 160,000g (36,000 rpm in a Beckman SW50.1 rotor) for 24 hours at 4°C.

#### CsCl EQUILIBRIUM GRADIENTS

The second CsCl centrifugation (Step 6) is an equilibrium gradient that separates the bacteriophage from contaminating RNA and DNA. Nucleic acids will not come to full equilibrium during an overnight centrifugation in CsCl and thus remain distributed throughout the tube. The resolution of this second centrifugation is higher than that obtained in the step gradient because the virus particles reach equilibrium in a very shallow density gradient (i.e., the density difference between the top and bottom of the gradient is quite small). As a consequence, the second centrifugation can often resolve two populations of bacteriophages that differ in the amount of DNA harbored in the viral genome. In a classic paper in human molecular genetics, Lauer et al. (1980) exploited this resolving power to show that bacteriophage clones harboring the hemoglobin  $\alpha$  gene often rearrange upon propagation in *E. coli* to produce exactly the same deletion mutations found in certain subjects with  $\alpha$ -thalassemia.



**FIGURE 2-11** Collection of Bacteriophage  $\lambda$  Particles by Side Puncture

7. Collect the band of bacteriophage particles as described in Step 5. Store the bacteriophage suspension at 4°C in the CsCl solution in a tightly capped tube.  
Bacteriophage  $\lambda$  DNA may now be extracted from the suspension as described in Protocol 11.
8. (*Optional*) If necessary, the bacteriophage particles can be further purified and concentrated by a second round of equilibrium centrifugation in CsCl. Transfer the bacteriophage suspension to one or more ultracentrifuge tubes that fit a Beckman SW50.1 rotor (or equivalent). Fill the tubes with a solution of CsCl in SM ( $\rho = 1.5$ ) and centrifuge the tubes at 160,000g (36,000 rpm in a Beckman SW50.1 rotor) for 24 hours at 4°C. When centrifugation is complete, collect the bacteriophage particles as described in Steps 3 and 4 of the following alternative protocol.

**ALTERNATIVE PROTOCOL: PURIFICATION OF BACTERIOPHAGE  $\lambda$  PARTICLES BY ISOPYCNIC CENTRIFUGATION THROUGH CSCL EQUILIBRIUM GRADIENTS**

When dealing with small-scale preparations of bacteriophage  $\lambda$  (infected cultures of 1 liter or less), the CsCl step gradient (Protocol 8) can be omitted and replaced by a single round of equilibrium centrifugation. The resulting preparation of bacteriophage particles is essentially free of contaminating bacterial nucleic acids.

**Additional Materials**

*CsCl (solid)*

*SM containing CsCl*

Use a high quality (molecular biology grade) of solid CsCl to prepare a solution of 0.75 g/ml by adding solid CsCl to SM. Store the solution at room temperature.

**Method**

1. Measure the volume of the bacteriophage suspension and add 0.75 g of solid CsCl per ml of bacteriophage suspension. Mix the suspension gently to dissolve the CsCl.
2. Transfer the bacteriophage suspension to an ultracentrifuge tube that fits a Beckman Ti50 or SW50.1 rotor (or equivalent). Fill the tube with SM containing 0.75 g/ml CsCl and centrifuge it at 150,000g (41,000 rpm in a Beckman Ti50 rotor) for 24 hours at 4°C or at 160,000g (36,000 rpm in a Beckman SW50.1 rotor) for 24 hours at 4°C.
3. Collect the bacteriophage particles by puncturing the side of the tube as follows.
  - a. Carefully wipe the outside of the tube with ethanol to remove any grease or oil, and then attach a piece of Scotch Tape to the outside of the tube, level with the band of bacteriophage particles.  
The tape acts as a seal to prevent leakage around the needle.
  - b. Use a 21-gauge hypodermic needle (syringe-barrel optional) to puncture the tube through the tape and collect the band of bacteriophage particles (please see Figure 2-11).  
Keep fingers away from the path of the needle in case the needle penetrates through the tube. Take care not to contaminate the bacteriophage particles with material from other bands that are visible in the gradient. These bands contain various types of bacterial debris and unassembled bacteriophage components.
4. Store the bacteriophage suspension at 4°C in the CsCl solution in a tightly capped tube.  
Bacteriophage  $\lambda$  DNA may now be extracted from the suspension as described in Protocol 11.

# Protocol 9

---

## Purification of Bacteriophage $\lambda$ Particles by Centrifugation through a Glycerol Step Gradient

**T**HIS MODIFICATION OF THE YAMAMOTO PURIFICATION PROCEDURE (described in Protocol 8) involves the use of a glycerol step gradient in place of the two CsCl centrifugation runs (Vande Woude et al. 1979). Although the use of glycerol gradients to purify bacteriophage  $\lambda$  is a quicker procedure, it does not yield bacteriophage of high purity and should not be used to prepare storage stocks.

This protocol is suitable for preparing bacteriophage particles that will yield DNA to be used for subcloning, for making bacteriophage stocks, or for preparing bacteriophage  $\lambda$  arms.

---

### MATERIALS

---

#### Buffers and Solutions

Please see Appendix 1 for components of stock solutions, buffers, and reagents. Dilute stock solutions to the appropriate concentrations.

*EDTA (0.5 M, pH 8.0)*

*Glycerol (5% and 40% v/v) in SM*

*SM*

#### Enzymes and Buffers

*Pancreatic DNase I (1 mg/ml)*

*Pancreatic RNase in TE (1 mg/ml, pH 7.6)*

#### Centrifuges and Rotors

*Beckman SW41 or SW28 rotor or equivalent, with clear centrifuge tubes (e.g., Beckman Ultra-Clear tubes)*

#### Vectors and Bacterial Strains

*Suspension of bacteriophage  $\lambda$  particles*

Prepared as described in Protocol 6 of this chapter.

## METHOD

---

1. Prepare a glycerol step gradient in a Beckman SW41 polycarbonate tube (or its equivalent; one tube is needed for each 5 ml of bacteriophage suspension):
  - a. Pipette 3 ml of a solution consisting of 40% glycerol in SM into the bottom of the tube.
  - b. Carefully layer 4 ml of a solution consisting of 5% glycerol in SM on top of the 40% glycerol solution.
  - c. Carefully layer the bacteriophage suspension on top of the 5% glycerol layer. Fill the tube with SM.
2. Centrifuge the step gradient at 151,000g (35,000 rpm in a Beckman SW41 or SW28 rotor) for 60 minutes at 4°C.
3. Discard the supernatant, and resuspend the bacteriophage pellet in 1 ml of SM per liter of original culture.
4. Add pancreatic DNase I and RNase to final concentrations of 5  $\mu\text{g/ml}$  and 1  $\mu\text{g/ml}$ , respectively. Incubate the reaction mixture for 30 minutes at 37°C.
5. Add EDTA from a 0.5 M stock solution (pH 8.0) to a final concentration of 20 mM.  
Bacteriophage  $\lambda$  DNA may now be extracted from the suspension as described in Protocol 11.



# Protocol 10

---

## Purification of Bacteriophage $\lambda$ Particles by Pelleting/Centrifugation

**I**F THE PURPOSE OF PURIFYING BACTERIOPHAGE PARTICLES is to obtain segments of foreign DNA for subsequent subcloning or to prepare bacteriophage  $\lambda$  arms, then the CsCl step gradient and equilibrium gradient (Protocol 8) can be replaced with a centrifugation step that deposits the bacteriophage particles on the bottom of the centrifuge tube. Preparations obtained in this manner are not as clean as those obtained by equilibrium gradient centrifugation or centrifugation through glycerol (Protocol 9), but they suffice for DNA extraction.

### MATERIALS

---

#### Buffers and Solutions

Please see Appendix 1 for components of stock solutions, buffers, and reagents. Dilute stock solutions to the appropriate concentrations.

SM

#### Centrifuges and Rotors

*Beckman SW28 rotor or equivalent*

#### Vectors and Bacterial Strains

*Suspension of bacteriophage  $\lambda$  particles*

Prepared as described in Protocol 6 of this chapter.

### METHOD

---

1. Transfer the bacteriophage suspension into a tube for use in a Beckman SW28 rotor (or equivalent).
2. Collect the bacteriophage particles by centrifugation at 110,000g (25,000 rpm in a Beckman SW28 rotor) for 2 hours at 4°C.

3. Carefully pour off and discard the supernatant.  
A glassy pellet of bacteriophage particles should be visible on the bottom of the tube.
4. Add 1–2 ml of SM to the pellet, and store it overnight at 4°C, preferably on a slowly rocking platform.
5. The following morning, pipette the solution gently up and down to ensure that all of the bacteriophage particles have been resuspended.  
Bacteriophage  $\lambda$  DNA may now be extracted from the suspension as described in Protocol 11.

# Protocol 11

---

## Extraction of Bacteriophage $\lambda$ DNA from Large-scale Cultures Using Proteinase K and SDS

**D**NA IS BEST ISOLATED FROM LARGE-SCALE PREPARATIONS OF BACTERIOPHAGE  $\lambda$  by digesting the viral coat proteins with a powerful protease such as proteinase K, followed by extraction with phenol:chloroform. This procedure also may be adapted for use with smaller (50–100 ml) preparations, as noted in the protocol. Protocol 12 describes an alternative, more rapid method to isolate viral DNA from bacteriophage particles purified by isopycnic centrifugation through CsCl gradients.

When purifying bacteriophage  $\lambda$  DNA, keep in mind that vector and recombinant genomes range between 43 kb and 53 kb in length and are thus susceptible to shearing. Take care to avoid creating shearing forces capable of breaking the DNA during extraction (please see the information panel on **MINIMIZING DAMAGE TO LARGE DNA MOLECULES**).

### MATERIALS

---

**CAUTION:** Please see Appendix 12 for appropriate handling of materials marked with  $\langle ! \rangle$ .

#### Buffers and Solutions

Please see Appendix 1 for components of stock solutions, buffers, and reagents. Dilute stock solutions to the appropriate concentrations.

*Chloroform*  $\langle ! \rangle$

*Dialysis buffer*

10 mM NaCl

50 mM Tris-Cl (pH 8.0)

10 mM MgCl<sub>2</sub>

Two containers of dialysis buffer are required, each containing 1000 times the volume of the bacteriophage solution. Store at room temperature until needed.

*EDTA* (0.5 M, pH 8.0)

*Ethanol*

*Phenol*  $\langle ! \rangle$

*Phenol:chloroform* (1:1, v/v)  $\langle ! \rangle$

*SDS* (10% w/v)

*Sodium acetate* (3 M, pH 7.0)

*TE* (pH 7.6 and pH 8.0)

## Enzymes and Buffers

### *Proteinase K*

Please see the entry on Proteinase K in Appendix 4.

### *Restriction endonucleases*

## Gels

Agarose gel (0.7%) cast in 0.5x TBE, containing 0.5  $\mu\text{g/ml}$  ethidium bromide <!>

## Centrifuges and Rotors

Sorvall SS-34 rotor or equivalent

## Special Equipment

*Borosilicate Pasteur pipette (sealed) or Shepherd's crook*

*Dialysis tubing, boiled*

For preparation of dialysis tubing for use with DNA, please see Appendix 8.

*Water bath preset to 56°C*

## Vectors and Bacterial Strains

*Bacteriophage  $\lambda$  particles in CsCl suspension*

Purify as described in Protocol 8, 9, or 10 of this chapter.

## METHOD

---

### Dialysis of Bacteriophage Suspension

1. Transfer the prepared bacteriophage suspension to a section of dialysis tubing sealed at one end with a knot or a plastic closure. Close the other end of the dialysis tube. Place the sealed tube in a flask containing a 1000-fold volume excess of dialysis buffer and a magnetic stir bar. Dialyze the bacteriophage suspension for 1 hour at room temperature with slow stirring.

The purpose of this step is to reduce the concentration of CsCl in the preparation. Beautiful Schlieren patterns caused by the rapid escape of cesium ions from the dialysis tube will appear when the dialysis sac is dunked into the buffer.

2. Transfer the dialysis tube to a fresh flask of buffer and dialyze the bacteriophage suspension for an additional hour.
3. Transfer the bacteriophage suspension into a polypropylene centrifuge tube.  
The tube should not be more than one-third full.
4. To the dialyzed bacteriophage suspension, add 0.5 M EDTA (pH 8.0) to a final concentration of 20 mM.

### Extraction of Bacteriophage Particles

5. To the suspension, add proteinase K to a final concentration of 50  $\mu\text{g/ml}$ .

6. Add SDS to a final concentration of 0.5%, and mix the solution by gently inverting the tube several times.  
The solution will change rapidly in appearance from a bluish suspension of bacteriophage particles to a clear solution containing viral DNA and the products of proteolysis of the viral coat proteins.
7. Incubate the digestion mixture for 1 hour at 56°C and then cool the mixture to room temperature.
8. Add an equal volume of equilibrated phenol to the digestion mixture, and mix the organic and aqueous phases by gently inverting the tube several times until a complete emulsion has formed.
9. Separate the phases by centrifugation at 3000g (5000 rpm in a Sorvall SS-34 rotor) for 5 minutes at room temperature. Use a wide-bore pipette to transfer the aqueous phase to a clean tube (please see the information panel on **MINIMIZING DAMAGE TO LARGE DNA MOLECULES**).
10. Extract the aqueous phase once with a 1:1 mixture of equilibrated phenol and chloroform.
11. Recover the aqueous phase as described above (Step 9), and repeat the extraction with an equal volume of chloroform. For large-scale preparations, proceed to Step 12.

#### FOR SMALLER-SCALE QUANTITIES (BACTERIOPHAGE FROM 50- TO 100-ML CULTURES)

- a. Recover the bacteriophage DNA by standard ethanol precipitation.
- b. Store the solution for 30 minutes at room temperature.  
The bacteriophage  $\lambda$  DNA can usually be seen as a threadlike precipitate after addition of ethanol, which can be plucked from the solution on the outside of a sealed tip of a borosilicate Pasteur pipette or Shepherd's crook.
- c. Redissolve the DNA in an appropriate volume of TE (pH 7.6), and proceed to Step 14.

#### Removal of CsCl

12. Transfer the aqueous phase to a dialysis sac.
13. Dialyze the preparation of bacteriophage DNA overnight at 4°C against three changes of a 1000-fold volume of TE (pH 8.0).
14. Measure the absorbance of the solution at 260 nm and calculate the concentration of the DNA.  
1 OD<sub>260</sub> = 50  $\mu$ g/ml of double-stranded DNA. A single particle of bacteriophage contains  $\sim 5 \times 10^{-11}$   $\mu$ g of DNA. The yield of bacteriophage DNA usually ranges from 500  $\mu$ g to several mg per liter, depending on the titer of the bacteriophage in the lysed culture.
15. Check the integrity of the DNA by analyzing aliquots (0.5  $\mu$ g) that are undigested or have been cleaved by appropriate restriction enzyme(s). Analyze the DNAs by electrophoresis through a 0.7% agarose gel, using markers of an appropriate size.
16. Store the stock of bacteriophage DNA at 4°C.

# Protocol 12

---

## Extraction of Bacteriophage $\lambda$ DNA from Large-scale Cultures Using Formamide

**F**ORMAMIDE MAY BE USED INSTEAD OF SDS/PROTEINASE K (please see Protocol 11) to remove the bacteriophage coats from purified particles. Although not as effective, this method is somewhat quicker to perform than the preceding method. Please see the information panel on **MINIMIZING DAMAGE TO LARGE DNA MOLECULES**.

### MATERIALS

---

**CAUTION:** Please see Appendix 12 for appropriate handling of materials marked with <!.>.

#### Buffers and Solutions

Please see Appendix 1 for components of stock solutions, buffers, and reagents. Dilute stock solutions to the appropriate concentrations.

*EDTA (0.5 M, pH 8.0)*

*Ethanol*

*Formamide, deionized <!.>*

*NaCl (5 M)*

*TE (pH 8.0)*

*Tris-Cl (2 M, pH 8.5)*

#### Enzymes and Buffers

*Restriction endonucleases*

#### Gels

*Agarose gel (0.7%) cast in 0.5 $\times$  TBE, containing 0.5  $\mu$ g/ml ethidium bromide <!.>*

#### Special Equipment

*Borosilicate Pasteur pipette (sealed) or Shepherd's crook*

#### Vectors and Bacterial Strains

*Bacteriophage  $\lambda$  particles*

*Purify as described in Protocol 9 or 10 of this chapter.*

## METHOD

---

1. If necessary, remove CsCl from the preparation of bacteriophage particles as described in Steps 1–4 of Protocol 11.
2. Measure the volume of the preparation of bacteriophage particles.
3. Add 0.1 volume of 2 M Tris (pH 8.5), 0.05 volume of 0.5 M EDTA (pH 8.0), and 1 volume of deionized formamide. Incubate the solution for 30 minutes at 37°C.  
During incubation, the milky suspension of bacteriophage particles clears to a transparent solution.
4. Precipitate the bacteriophage  $\lambda$  DNA by adding 1 volume (equal to the final volume in Step 3) of H<sub>2</sub>O and 6 volumes (each equal to the final volume in Step 3) of ethanol.
5. Hook the precipitate of bacteriophage  $\lambda$  DNA onto the end of a sealed borosilicate Pasteur pipette or Shepherd's crook and transfer it to microfuge tube containing 70% ethanol.
6. Collect the DNA pellet by brief centrifugation (10 seconds) in a microfuge.  
Avoid lengthy centrifugation as this compacts the DNA, making it difficult to dissolve.
7. Discard the supernatant and store the open tube on the bench for a few minutes to allow the ethanol to evaporate. Redissolve the damp pellet of DNA in 300  $\mu$ l of TE by tapping on the side of the tube. Try to avoid vortexing.  
This process can be lengthy. If the DNA proves difficult to dissolve, incubate the tube for 15 minutes at 50°C.
8. Reprecipitate the DNA by adding 6  $\mu$ l of 5 M NaCl and 750  $\mu$ l of ethanol. Collect the precipitated DNA and redissolve it as described in Steps 6 and 7.
9. Check the integrity of the DNA by analyzing aliquots (0.5  $\mu$ g) that are undigested or have been cleaved by appropriate restriction enzyme(s). Analyze the DNAs by electrophoresis through a 0.7% agarose gel using markers of an appropriate size.
10. Store the stock of bacteriophage DNA at 4°C.

# Protocol 13

---

## Preparation of Bacteriophage $\lambda$ DNA Cleaved with a Single Restriction Enzyme for Use as a Cloning Vector

**I**N SOME CASES, BACTERIOPHAGE  $\lambda$  DNA CAN BE PREPARED for cloning by simple digestion with restriction enzymes. This option is viable only when using vectors that allow genetic selection of recombinant bacteriophages carrying sequences of foreign DNA (e.g., the EMBL series,  $\lambda$ 2001,  $\lambda$ DASH,  $\lambda$ ZAP, and  $\lambda$ gt10). In such cases, it is not necessary to take steps to minimize the formation of nonrecombinant bacteriophages. However, when genetic selection of recombinant bacteriophages is not possible or is inefficient, biochemical and physical methods are used to reduce the number of “empty” vectors in the recombinant population. These methods include physical separation of the stuffer fragment from the vector arms, treatment of the digested vector DNA with alkaline phosphatase to reduce the possibility of regenerating empty vector genomes by ligation of left and right arms, and digestion of vectors with combinations of restriction enzymes that will destroy the ability of the stuffer fragment to reinsert into the arms.

This protocol describes the preparation and characterization of bacteriophage  $\lambda$  vector DNA that is cleaved with a single restriction enzyme. Subsequent protocols describe the preparation of DNA cleaved with two restriction enzymes (Protocol 14) and treatment of vector DNA with alkaline phosphatase (Protocol 15).

### MATERIALS

---

**CAUTION:** Please see Appendix 12 for appropriate handling of materials marked with <!>.

#### Buffers and Solutions

Please see Appendix 1 for components of stock solutions, buffers, and reagents. Dilute stock solutions to the appropriate concentrations.

*ATP (10 mM)*

Omit ATP from Step 7 if the ligation buffer contains ATP.

*Chloroform <!>*

*EDTA (0.5 M, pH 8.0)*

*Ethanol*

*Phenol:chloroform (1:1, v/v) <!>*



*Sodium acetate (3 M, pH 7.0)*

It is important to use a solution of sodium acetate solution that has been equilibrated to pH 7.0 rather than the more common pH 5.3. EDTA, which is used to remove divalent cations from the restriction buffer after digestion, precipitates from solution at pH 5.3 when present at concentrations in excess of 5–10 mM.

*Sucrose gel-loading buffer*

Please see Table 5-4 in Chapter 5, Protocol 1.

*TE (pH 7.6 and pH 8.0)*

## Enzymes and Buffers

*Bacteriophage T4 DNA ligase*

*Restriction endonucleases with appropriate buffers*

## Gels

*Agarose gel (0.7%) cast in 0.5x TBE, containing 0.5  $\mu\text{g/ml}$  ethidium bromide <math>\langle ! \rangle</math>*

## Nucleic Acids and Oligonucleotides

*Bacteriophage  $\lambda$  DNA*

Prepared as described in Protocol 11 or 12 of this chapter.

## Special Equipment

*Water bath preset to 68°C*

## Additional Reagents

*Step 7 (part e) of this protocol requires the reagents listed in Protocol 1 of this chapter.*

## Vectors and Bacterial Strains

*Bacteriophage  $\lambda$  packaging mixtures*

Packaging mixtures may be purchased in a kit form from any of several commercial manufacturers (e.g., Stratagene, Promega, and Life Technologies). Please see the information panel on **IN VITRO PACKAGING**.

## METHOD

---

1. Mix 25–50  $\mu\text{g}$  of bacteriophage  $\lambda$  DNA with TE (pH 8.0) to give a final volume of 170  $\mu\text{l}$ .
2. Add 20  $\mu\text{l}$  of the appropriate 10x restriction enzyme buffer. Remove two aliquots, each containing 0.2  $\mu\text{g}$  of undigested bacteriophage  $\lambda$  DNA. Store the aliquots of undigested DNA on ice.  

These aliquots of undigested DNA will be used as controls during the agarose gel electrophoresis (Steps 4 and 7).
3. Add a threefold excess (75–150 units) of the appropriate restriction enzyme and incubate the digestion mixture for 1 hour at the temperature recommended by the manufacturer.

4. Cool the reaction to 0°C on ice. Remove another aliquot (0.2  $\mu$ g). Incubate this aliquot and one of the two aliquots of undigested DNA (Step 2 above) for 10 minutes at 68°C to disrupt the cohesive termini of the bacteriophage DNA. Add a small amount (10  $\mu$ l) of sucrose gel-loading buffer and immediately load the samples onto an 0.7% agarose gel.

If the restriction enzyme digestion is complete, then no DNA will migrate at the position of the undigested control bands. Instead, two or more (depending on the number of cleavage sites in the vector) smaller DNA fragments will be seen. Carefully examine the number and yield of these smaller fragments to ensure that no partial digestion products are present.

This step is not as easy as it sounds. The left and right arms of bacteriophage  $\lambda$  DNA carry complementary termini 12 bases in length that can reanneal with one another. The resulting hydrogen-bonded DNA species can be easily confused with uncleaved bacteriophage  $\lambda$  DNA. For this reason, it is important to load and run the gel immediately after the DNA samples have been removed from the 68°C water bath.

If digestion is incomplete, warm the reaction to the appropriate temperature, add more restriction enzyme (50–100 units), and continue the incubation at the optimal temperature recommended by the manufacturer.

5. When digestion is complete, add 0.5 M EDTA (pH 8.0) to a final concentration of 5 mM, and extract the digestion mixture once with phenol:chloroform and once with chloroform.
6. Recover the DNA from the aqueous phase by ethanol precipitation in the presence of 0.3 M sodium acetate (pH 7.0). Collect the precipitate by centrifuging at maximum speed for 2 minutes at 4°C in a microfuge. Wash the pellet in 70% ethanol and redissolve the DNA in 100  $\mu$ l of TE (pH 7.6). Determine the concentration by measuring absorbance at 260 nm.
7. Remove an aliquot of DNA (0.5  $\mu$ g), and test for its ability to be ligated as follows:
  - a. Adjust the volume of the DNA solution to 17  $\mu$ l with H<sub>2</sub>O.
  - b. Add 2  $\mu$ l of 10x ligation buffer and, if necessary, 1  $\mu$ l of 10 mM ATP.  
Some commercial ligase buffers contain ATP. When using such buffers, the addition of ATP is no longer required.
  - c. Remove 5  $\mu$ l of the mixture prepared in Step b and store on ice.
  - d. Add 0.2–0.5 Weiss unit of bacteriophage T4 DNA ligase to the remainder of the mixture (Step b), and incubate the reaction for 2 hours at 16°C.
  - e. Use a commercially available bacteriophage  $\lambda$  packaging reaction (please see the information panel on **IN VITRO PACKAGING**) to package 0.1  $\mu$ g of the ligated and unligated samples and 0.1  $\mu$ g of the undigested vector DNA from Step 2. Determine the titer (pfu/ml) of each packaged reaction as described in Protocol 1.

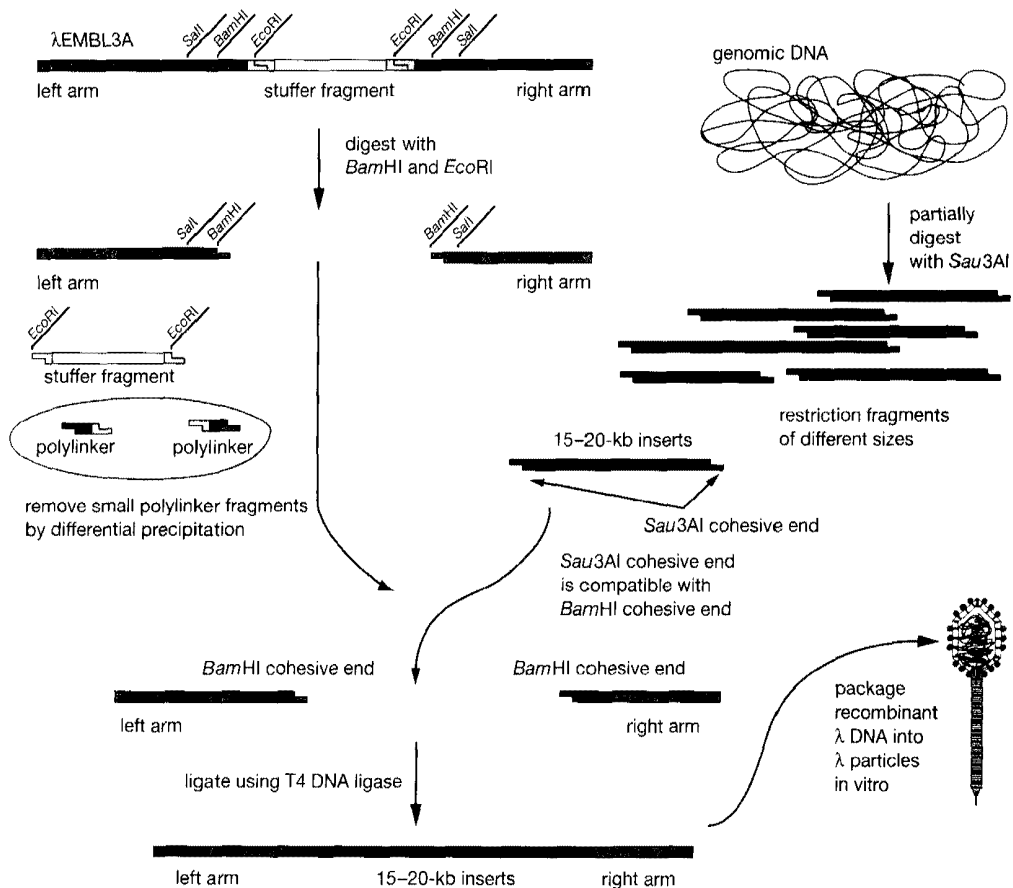
The background of plaques obtained after cleavage of bacteriophage  $\lambda$  vectors at a single restriction site is sometimes unacceptably high because of the accumulation of mutants in the original population that are resistant to cleavage with the restriction enzyme. This problem can be reduced if the bacteriophage  $\lambda$  vector is plaque-purified frequently.

The packaging efficiency of the digested vector should increase by nearly three orders of magnitude after ligation. The packaging efficiency of the ligated sample should be ~10% of that of undigested vector DNA.

# Protocol 14

## Preparation of Bacteriophage $\lambda$ DNA Cleaved with Two Restriction Enzymes for Use as a Cloning Vector

**R**EPLACEMENT VECTORS, SUCH AS  $\lambda$ 2001,  $\lambda$ DASH, THE EMBL series, and Charon 34, 35, and 40, contain a series of restriction sites, arranged in opposite orientations, at each end of the central stuffer fragment (Frischauf et al. 1983). In EMBL3A, for example, the order of restriction sites in the left polycloning site is *Sal*I-*Bam*HI-*Eco*RI and the order in the right polycloning site is *Eco*RI-*Bam*HI-*Sal*I.



**FIGURE 2-12** Cleaving a Bacteriophage  $\lambda$  Replacement Vector with Restriction Endonucleases

Please see text for details.

*Bam*HI-*Sall*. Digestion of such a vector with both *Bam*HI and *Eco*RI yields left and right arms that carry *Bam*HI termini, a stuffer fragment carrying *Eco*RI termini, and short segments of the polycloning sites carrying *Eco*RI and *Bam*HI termini (please see Figure 2-12). These segments can easily be removed by differential precipitation with isopropanol or by spun column centrifugation (please see Appendix 8).

The arms can be efficiently ligated to target DNAs that carry termini compatible with *Bam*HI but are unable to ligate to *Eco*RI termini of the stuffer fragment. By suppressing ligation to the stuffer fragment in this way, the proportion of nonrecombinant bacteriophages in cDNA and genomic libraries can be decreased by two orders of magnitude. When this "biochemical selection" is used in combination with a genetic selection (e.g., *Spi*), the proportion of nonrecombinant bacteriophages can be reduced by a further 100-fold. Hence, with many replacement vectors, there is no need to remove the stuffer fragment or to purify the left and right arms by gel electrophoresis or sucrose density centrifugation.

## MATERIALS

---

**CAUTION:** Please see Appendix 12 for appropriate handling of materials marked with <!>.

### Buffers and Solutions

Please see Appendix 1 for components of stock solutions, buffers, and reagents. Dilute stock solutions to the appropriate concentrations.

*ATP* (10 mM)

Omit ATP from Step 10 if the ligation buffer contains ATP.

*Chloroform* <!>

*Ethanol*

*Phenol:chloroform* (1:1, v/v) <!>

*Sodium acetate* (3 M, pH 5.2)

*Sucrose gel-loading buffer*

Please see Table 5-4 in Chapter 5, Protocol 1.

*TE* (pH 7.6 and pH 8.0)

### Enzymes and Buffers

*Bacteriophage T4 DNA ligase*

*Restriction endonucleases*

### Gels

*Agarose gel* (0.7%) cast in 0.5x TBE, containing 0.5  $\mu$ g/ml ethidium bromide <!>

### Nucleic Acids and Oligonucleotides

*Bacteriophage  $\lambda$  (replacement vector) DNA*

Prepared as described in Protocol 11 or 12 of this chapter.

### Special Equipment

*Water bath* preset to 68°C

### Additional Reagents

Step 10 (part e) of this protocol requires the reagents listed in Protocol 1 of this chapter.

### Vectors and Bacterial Strains

*Bacteriophage  $\lambda$  packaging mixtures*

Packaging mixtures may be purchased in kit form from any of several commercial manufacturers (e.g., Stratagene, Promega, Epicenter Technologies, and Life Technologies). Please see the information panel on **IN VITRO PACKAGING**

## METHOD

1. Mix 25–50  $\mu\text{g}$  of bacteriophage  $\lambda$  DNA purified from a replacement vector with TE (pH 8.0) to give a final volume of 170  $\mu\text{l}$ .
2. Add 20  $\mu\text{l}$  of one of the two appropriate 10 $\times$  restriction enzyme buffers. Remove two aliquots, each containing 0.2  $\mu\text{g}$  of undigested bacteriophage  $\lambda$  DNA. Store the aliquots of undigested DNA on ice.

These aliquots of undigested DNA will be used as controls during the agarose gel electrophoresis in Step 4 and in the test ligation in Step 10.
3. Add a fourfold excess (100–200 units) of one of the two appropriate restriction enzymes and incubate the digestion mixture for 4 hours at the temperature recommended by the manufacturer.
4. Cool the reaction to 0 $^{\circ}\text{C}$  on ice. Remove two aliquots (0.2  $\mu\text{g}$ ). Incubate one of these aliquots (save the other for analysis in Step 10 below) and one of the two aliquots of undigested DNA (Step 2 above) for 10 minutes at 68 $^{\circ}\text{C}$  to disrupt the cohesive termini of the bacteriophage DNA. Add a small amount ( $\sim$ 10  $\mu\text{l}$ ) of sucrose gel-loading buffer and *immediately* electrophorese the samples through an 0.7% agarose gel.

If the restriction enzyme digestion is complete, no DNA will migrate at the position of the undigested control bands. Instead, three or more (depending on the number of cleavage sites in the vector) smaller DNA fragments will be seen. The number and yield of these smaller fragments should be examined carefully to ensure that no partial digestion products are present.
5. Purify the DNA by extracting twice with phenol:chloroform and once with chloroform.
6. Recover the DNA by standard ethanol precipitation.

The quality of the library and the efficiency of cloning target DNAs depends on the effectiveness of digestion with restriction enzymes in Steps 3 and 7. It is therefore worth investing some effort to make sure that digestion has been complete. The efficiency of digestion can be monitored in several ways. The best of these involves setting up a series of test reactions (Step 10 below) to compare the efficiency of packaging digested and undigested vector DNAs, before and after ligation. If the number of nonrecombinant bacteriophages is unacceptably high ( $>10^4$  pfu/ $\mu\text{g}$  of cleaved vector DNA), then the digestion and analysis should be repeated.

Alternatively, the biochemical methods outlined below can be used to measure the efficiency of digestion. However, these surrogate assays are less satisfactory because they do not directly measure the ability of the DNA preparation to perform as a vector.

- A small fraction of the product of the first digestion can be end-labeled (please see Chapter 9, Protocol 10 or 11); the radiolabel can then be used to monitor digestion by the second restriction enzyme. If this method is used, it is important to ligate the cohesive termini of the vector DNA before digestion with the first restriction enzyme (please see Protocol 15). This ligation prevents incorporation of significant amounts of radiolabel into the cohesive termini. After end-labeling, add a small quantity of the radioactive DNA (0.01–0.1  $\mu\text{g}$ ) to the bulk of the vector preparation. Digestion with the second restriction enzyme should result in quantitative movement of the label from the large stuffer fragment and arms into the small polycloning site; this movement can be readily monitored by gel electrophoresis and autoradiography or phosphorimaging.
- PCRs can be set up using sets of primers that lie to the left and right of the target restriction sites (please see Chapter 8, Protocol 1). Cleavage of the restriction sites will eliminate (or greatly reduce) the PCR products. To obtain an estimate of the efficiency of cleavage, it is usually necessary to compare the amount of amplified products generated in a series of PCRs containing different quantities of undigested vector DNA and digested vector DNA.

7. Redissolve the DNA in TE (pH 8.0) at a concentration of 250  $\mu\text{g}/\text{ml}$ . Add the appropriate 10 $\times$  restriction buffer and digest the DNA with the second restriction enzyme. Use a fourfold excess of enzyme and incubate the reaction for 4 hours.
8. Purify the DNA by extracting twice with phenol:chloroform and once with chloroform. Recover the DNA by standard ethanol precipitation.

Short fragments carrying the polycloning sites can be removed by isopropanol precipitation by spin column chromatography (Appendix 8).
9. Redissolve the DNA in TE (pH 7.6) at a concentration of 300–500  $\mu\text{g}/\text{ml}$ . Store an aliquot (0.2  $\mu\text{g}$ ) at  $-20^\circ\text{C}$ .
10. To determine the effectiveness of the digestion procedure, set up trial ligation reactions using 0.2  $\mu\text{g}$  of the vector digested with only the first enzyme (the aliquot set aside at Step 4 above) and 0.2  $\mu\text{g}$  of the final preparation (Step 9). Package equivalent amounts of DNA (0.1  $\mu\text{g}$ ) from each ligation mixture and titrate the infectivity of the resulting bacteriophage particles.
  - a. Adjust the volumes of the two DNA solutions to 17  $\mu\text{l}$  with  $\text{H}_2\text{O}$ .
  - b. Add to each sample 2  $\mu\text{l}$  of 10 $\times$  ligation buffer and, if necessary, 1  $\mu\text{l}$  of 10 mM ATP.

Omit ATP if using a commercial ligase buffer that contains ATP.
  - c. Remove 10- $\mu\text{l}$  aliquots of each of the mixtures prepared in Step b and store the aliquots on ice.
  - d. Add 0.2–0.5 Weiss units of bacteriophage T4 DNA ligase to the remainder of the mixtures (Step b) and incubate the reactions for 2 hours at  $16^\circ\text{C}$ .
  - e. Use a commercial bacteriophage  $\lambda$  packaging reaction (please see the information panel on **IN VITRO PACKAGING**) to package 0.1  $\mu\text{g}$  of the ligated and unligated samples and 0.1  $\mu\text{g}$  of the undigested vector DNA from Step 2. Determine the titer (pfu/ml) of each packaged reaction as described in Protocol 1.

The background of plaques obtained after cleavage of bacteriophage  $\lambda$  vectors at a restriction site is sometimes unacceptably high because of the accumulation of mutants in the original population that cannot be cleaved with the restriction enzyme. This problem can be reduced if the bacteriophage  $\lambda$  vector is plaque-purified frequently.

The packaging efficiency of the vector digested with only one enzyme should increase by nearly three orders of magnitude after ligation. The packaging efficiency of the ligated sample should be  $\sim 10\%$  of that of undigested vector DNA.

The efficiency of packaging of the doubly digested vector should be two to three orders of magnitude *less* than that of the vector DNA digested with only one restriction enzyme.

# Protocol 15

---

## Alkaline Phosphatase Treatment of Bacteriophage $\lambda$ Vector DNA

**R**EMOVAL OF THE 5'-PHOSPHATE GROUPS FROM THE INTERNAL TERMINI of bacteriophage  $\lambda$  arms can effectively prevent self-ligation and reduce the background of nonrecombinant bacteriophages. This method is used to suppress the background of nonrecombinants when using insertion vectors that contain a single site for cloning (e.g.,  $\lambda$ gt10,  $\lambda$ gt11, and  $\lambda$ ORF8) or when using an insertion vector with a polycloning site (e.g.,  $\lambda$ gt18–23 and  $\lambda$ ZAP) and cutting with a single enzyme.

The procedure also is effective when ligation to a stuffer fragment cannot be suppressed by physical procedures (please see this protocol and Protocols 13 and 14). It is very important that the cohesive (*cos*) termini of the vector be reannealed and ligated together *before* treatment with alkaline phosphatase. Unless the *cos* termini are protected in this way, the ability of the vector arms to form concatemers with target DNAs will be greatly reduced or eliminated, with disastrous effects on the efficiency of packaging.

### MATERIALS

---

**CAUTION:** Please see Appendix 12 for appropriate handling of materials marked with <!.>.

#### Buffers and Solutions

Please see Appendix 1 for components of stock solutions, buffers, and reagents. Dilute stock solutions to the appropriate concentrations.

*$\lambda$  Annealing buffer*

100 mM Tris-Cl (pH 7.6)

10 mM MgCl<sub>2</sub>

*ATP (10 mM)*

Omit ATP from Step 2 if the ligation buffer contains ATP.

*Chloroform <!.>*

*EDTA (0.5 M, pH 8.0)*

*Ethanol*

*Phenol:chloroform (1:1, v/v) <!.>*

*SDS (10% w/v)*

*Sodium acetate (3 M, pH 5.2 and pH 7.0)*

It is important to use a sodium acetate solution equilibrated to pH 7.0 at Step 8 in this protocol, rather than the more common pH 5.3 solution. EDTA, which is used to inactivate the restriction enzyme after digestion, precipitates from solution at pH 5.3 when present at concentrations in excess of 5–10 mM.

*TE (pH 7.6 and pH 8.0)*

*Tris-Cl (10 mM, pH 8.3)*

## Enzymes and Buffers

### *Bacteriophage T4 DNA ligase*

### *Calf intestinal alkaline phosphatase*

Calf intestinal alkaline phosphatase (CIP) may be purchased as an aqueous solution; ~0.01 unit of CIP will remove the terminal phosphates from 1 pmole of 5' termini of bacteriophage  $\lambda$  DNA (1 pmole of 5' termini of a 40-kb linear DNA is 16  $\mu$ g).

Alkaline phosphatase enzymes from bacterial or crustacean sources can be substituted for CIP. For a discussion on the relative merits of these enzymes, please see Chapter 9, Protocol 13.

### *10x Dephosphorylation buffer*

100 mM Tris-Cl (pH 8.3)

10 mM ZnCl<sub>2</sub>

10 mM MgCl<sub>2</sub>

### *Proteinase K*

Please see the entry on Proteinase K in Appendix 4.

### *Restriction endonucleases*

## Nucleic Acids and Oligonucleotides

### *Bacteriophage $\lambda$ DNA*

Prepared as described in Protocol 11 or 12 of this chapter.

## Special Equipment

*Dog toe-nail clippers or Wide-bore pipette tips*

*Water baths preset to 16°C, 42°C, 56°C, and 68°C*

## Additional Reagents

*Step 13 of this protocol requires the reagents listed in Protocols 1 and 14 of this chapter.*

## Vectors and Bacterial Strains

### *Bacteriophage $\lambda$ packaging mixtures*

Packaging mixtures may be purchased in kit form from any of several commercial manufacturers (e.g., Stratagene, Promega, and Life Technologies). For ligation conditions, please see the information panel on **IN VITRO PACKAGING**

## METHOD

---

1. Dissolve 50–60  $\mu$ g of DNA of the appropriate bacteriophage  $\lambda$  vector in a final volume of 150  $\mu$ l of  $\lambda$  annealing buffer. Incubate the DNA for 1 hour at 42°C to allow the ends of the viral DNA containing the *cos* sites to anneal.
2. Add 20  $\mu$ l of 10x ligase buffer, 20  $\mu$ l of 10 mM ATP (if necessary), and 0.2–0.5 Weiss unit of bacteriophage T4 DNA ligase/ $\mu$ g of DNA. Incubate the reaction for 1–2 hours at 16°C.  
Omit ATP if using a commercial ligase buffer that contains ATP.
3. Extract the ligation reaction with phenol:chloroform.  
During ligation, the  $\lambda$  DNA will form closed circles and long concatemers and become sensitive to shearing (please see the information panel on **MINIMIZING DAMAGE TO LARGE DNA MOLECULES**). Handle the ligated DNA carefully! Do not vortex. Carry out the phenol:chloroform extraction by gently inverting the tube to elicit emulsion formation.
4. Separate the organic and aqueous phases by centrifugation for 1 minute at room temperature in a microfuge. Remove the aqueous phase containing the viral DNA to a new tube using an automatic pipetting device equipped with a disposable tip that has been snipped with dog toe-nail clippers to increase the diameter of the hole.



5. Recover the DNA by standard ethanol precipitation. Rinse the pellet with 1 ml of 70% ethanol and recentrifuge for 2 minutes. Remove the 70% ethanol supernatant and store the open tube on the bench to allow the ethanol to evaporate. Redissolve the damp pellet of DNA in 150  $\mu$ l of TE (pH 8.0).

Check that the ligation of *cos* termini has succeeded by heating an aliquot (0.2  $\mu$ g) of the ligated DNA for 5 minutes at 68°C in TE. Chill the DNA in ice water and then electrophorese the DNA immediately through a 0.6% agarose gel. As controls, use (i) bacteriophage  $\lambda$  DNA that has been heated but not ligated and (ii) bacteriophage  $\lambda$  DNA that has been ligated but not heated.

Ligation should convert the bacteriophage  $\lambda$  DNA to closed circular and concatenated forms that show no change in migration after heating. The unligated, heated control DNA should migrate as a linear molecule, ~50 kb in length.

6. Digest the ligated DNA with one or more restriction enzymes as described in Protocol 13 or 14.
7. Repeat Steps 3 and 4 (above).
8. Add 0.1 volume of 3 M sodium acetate (pH 7.0) and 2 volumes of ethanol. Recover the precipitate of DNA by centrifugation for 10 minutes at 4°C in a microfuge. Rinse the pellet with 1 ml of 70% ethanol and recentrifuge for 2 minutes. Remove the 70% ethanol supernatant and store the open tube on the bench to allow the ethanol to evaporate.
9. Dissolve the digested and ethanol-precipitated DNA at a concentration of 100  $\mu$ g/ml in 10 mM Tris-Cl (pH 8.3), and store an aliquot (0.2  $\mu$ g) on ice. Treat the remainder of the DNA with an excess of CIP for 1 hour at 37°C as follows:
  - a. Add 0.1 volume of 10x dephosphorylation buffer and 0.01 unit of CIP for every 10  $\mu$ g of bacteriophage  $\lambda$  DNA.
  - b. Mix, and incubate the reaction for 30 minutes at 37°C. Add a second aliquot of CIP and continue incubation for an additional 30 minutes.
 

Blunt and recessed 5' termini are poor substrates for CIP. To improve the efficiency of dephosphorylation of termini of this type, carry out the second half of the incubation at 55°C. At this temperature, the ends of double-stranded DNA molecules tend to breathe and fray, thereby allowing the enzyme to access recessed 5'-phosphate groups.
10. Add SDS and EDTA (pH 8.0) to final concentrations of 0.5% and 5 mM, respectively. Mix the solution by gentle vortexing and add proteinase K to a final concentration of 100  $\mu$ g/ml. Incubate the mixture for 30 minutes at 56°C.
 

Proteinase K is used to digest CIP, which must be completely removed if the subsequent ligation reactions are to work efficiently. Alternatively, CIP (or shrimp alkaline phosphatase, please see Chapter 9, Protocol 13) can be inactivated by heating the reaction (at the end of Step 9) to 65°C for 1 hour in the presence of 5 mM EDTA and then extracting the reaction mixture once with phenol:chloroform.
11. Cool the reaction mixture to room temperature, and purify the bacteriophage  $\lambda$  DNA by extracting once with phenol:chloroform and once with chloroform. Recover the DNA by ethanol precipitation in the presence of 0.3 M sodium acetate (pH 7.0).
12. Dissolve the DNA in TE (pH 7.6) at a concentration of 300–500  $\mu$ g/ml. Store the dephosphorylated DNA at –20°C in aliquots of 1–5  $\mu$ g.
13. Measure the efficiency of dephosphorylation by ligating a portion (0.2  $\mu$ g) of the digested vector before and after treatment with CIP (for ligation conditions, please see Protocol 13). Package the DNA into bacteriophage particles (for packaging conditions, please see Protocol 14), and titrate the infectivity.

Phosphatase treatment should reduce ligation and the efficiency of packaging of the arms by two to three orders of magnitude.

# Protocol 16

---

## Purification of Bacteriophage $\lambda$ Arms: Centrifugation through Sucrose Density Gradients

**U**NLIKE INSERTION VECTORS, THE GENOMES OF REPLACEMENT VECTORS contain a central stuffer segment that must be removed to accommodate segments of foreign DNA. This process is generally referred to as "preparation of  $\lambda$  arms" and involves restriction endonuclease digestion of  $\lambda$  DNA to separate the two arms from the stuffer fragment, followed by purification of the arms. Two methods are commonly used to purify arms: sucrose density gradient centrifugation (described here) and centrifugation through NaCl density gradients. Although the latter procedure is quicker, the arms are sometimes contaminated by small amounts of stuffer fragment, perhaps because the resolving power of sodium chloride gradients is limited. Ethidium bromide, at a concentration of 2  $\mu\text{g/ml}$ , can be included in sucrose or NaCl density gradients. The positions of the different species of DNA within the gradient can then be determined visually. With practice, it is possible to pool those fractions that contain the annealed arms without prior analysis by agarose gel electrophoresis. In some cases, for example, if the restriction endonuclease digested ends of the vector are to be treated with phosphatase, it is desirable to ligate the cohesive termini of vector DNA before digesting with restriction endonucleases. The accompanying panel on **LIGATION FIRST** (see Method) describes the series of steps required to perform the preliminary ligation.

Bacteriophage  $\lambda$  arms can also be purified by preparative electrophoresis through 0.5% agarose gels. In general, however, the yield of DNA obtained by gel electrophoresis is lower than that obtained by density gradient centrifugation.

Purified arms of the most popular vectors (e.g., EMBL3 and EMBL4,  $\lambda\text{gt}10$ ,  $\lambda\text{gt}11$ ,  $\lambda\text{FixII}$ ,  $\lambda\text{DASH}$ , and  $\lambda\text{ZAP}$ ) are available from commercial sources. These are invaluable if something goes wrong or when cloning in bacteriophage  $\lambda$  for the first time. It may also be less expensive to use commercial arms rather than domestically produced reagents for the occasional small-scale cloning project, for example, subcloning from individual bacterial or yeast artificial chromosomes. However, if the arms are to be used regularly or for the construction of libraries, it is more economical to prepare them by density gradient centrifugation.

This method for purification of bacteriophage  $\lambda$  arms through sucrose density gradients is derived from Maniatis et al. (1978), and it can be used to prepare the arms of any bacteriophage  $\lambda$  vector.

## MATERIALS

---

**CAUTION:** Please see Appendix 12 for appropriate handling of materials marked with <!>.

### Buffers and Solutions

Please see Appendix 1 for components of stock solutions, buffers, and reagents. Dilute stock solutions to the appropriate concentrations.

EDTA (0.5 M, pH 8.0)

Ethanol

MgCl<sub>2</sub> (1 M)

NaCl (1 M)

n-butanol <!>

Sodium acetate (3 M, pH 5.2)

Sucrose gel-loading buffer

Please see Table 5-4 in Chapter 5, Protocol 1.

TE (pH 7.6 and pH 8.0)

### Gels

Agarose gel (0.5% and 0.7%) cast in 0.5x TBE, containing 0.5  $\mu$ g/ml ethidium bromide <!>

Please see Step 3.

Agarose gel (0.5%, 75 mm thick), cast in 0.5x TBE, containing 0.5  $\mu$ g/ml ethidium bromide

Please see Step 7.

### Nucleic Acids and Oligonucleotides

Bacteriophage  $\lambda$  DNA

Prepared as described in Protocol 11 or 12 of this chapter.

### Centrifuges and Rotors

Beckman SW28 rotor or equivalent, with clear centrifuge tubes, 25 x 89 mm

(e.g., Beckman SW28 tubes or equivalent)

### Special Equipment

Dialysis tubing, boiled

For preparation of dialysis tubing for use with DNA, please see Appendix 8.

Hypodermic needle (21 gauge)

Large-bore tips

Sucrose gradients

Prepare two sucrose solutions, one containing 10% (w/v) sucrose and another containing 40% (w/v) sucrose in a buffer of 1 M NaCl, 20 mM Tris-Cl (pH 8.0), and 5 mM EDTA (pH 8.0). Sterilize the two solutions by filtration through 0.22- $\mu$ m nitrocellulose filters. The gradients are prepared as described in Step 1.

Alternatively, linear sucrose gradients can be formed by diffusion (Brakke 1958). Many investigators prefer to use this method when large numbers of gradients are required. Four sterile sucrose solutions are required (10%, 20%, 30%, and 40% [w/v] sucrose) in 1 M NaCl, 20 mM Tris-Cl (pH 8.0), and 5 mM EDTA (pH 8.0). To form a 38-ml gradient in a Beckman SW28 centrifuge tube (or equivalent), 9.5 ml of each of the four sucrose solutions is successively layered on top of each other. Most investigators prefer to place the 40% sucrose solution in the bottom of the tube and then to overlay carefully with the three remaining solutions in order of decreasing density: 30%, 20%, and finally 10% sucrose. However, the gradients can also be formed by placing the least dense sucrose solution (10%) in the bottom of the tube and underlaying with progressively more dense sucrose solutions. Allow the step gradients to stand undisturbed for 2.5–3.0 hours at room temperature. Place each gradient in a bath of ice water to cool for 15 minutes before centrifugation.

Water baths preset to 42°C and 68°C

### Additional Reagents

Step 2 of this protocol requires the reagents listed in Protocol 13 or 14 of this chapter.

## METHOD

### LIGATION FIRST

This method serves as an optional preliminary sequence of steps that may be performed before Step 2 (restriction endonuclease digestion) of the protocol for purifying bacteriophage  $\lambda$  arms. In this "Ligation First" method, the cohesive termini of the vector DNA are ligated together before digesting with restriction enzyme(s). The resulting concatemers are then cleaved by the appropriate restriction enzymes into left and right arms (which remain joined together) and the stuffer fragment. Ligation, followed by restriction endonuclease digestion, ensures that a majority of the purified vector has intact *cos* sites. These, in turn, increase the efficiency of packaging in the subsequent cloning steps.

1. Incubate the undigested bacteriophage  $\lambda$  DNA for 1 hour at 42°C in 150  $\mu$ l of 0.1 M Tris-Cl (pH 7.6), 10 mM MgCl<sub>2</sub> to allow the cohesive termini to anneal.
2. Add 20  $\mu$ l of 10x ligation buffer (please see Protocol 13), 20  $\mu$ l of 10 mM ATP (if necessary), and 0.2–0.5 Weiss unit of bacteriophage T4 DNA ligase/ $\mu$ g of DNA. Incubate the reaction mixture for 1–2 hours at 16°C.
3. Extract the ligated DNA once with phenol:chloroform.
 

During ligation, the bacteriophage  $\lambda$  DNA forms closed circles and long concatemers and will be more sensitive to shearing. Handle the ligated DNA carefully! Do not vortex. Carry out the phenol:chloroform extraction by gently inverting the tube to emulsify the two phases.
4. Centrifuge the emulsion for 1 minute at room temperature to separate the organic and aqueous phases. Transfer the aqueous phase containing the viral DNA to a new tube using an automatic pipetting device equipped with a large-bore tip.
5. Recover the DNA by standard ethanol precipitation.
6. Proceed with Step 2 of this protocol to digest the concatenated DNA with the appropriate restriction enzymes and fractionate the cleaved DNA by centrifugation through a sucrose gradient.

### Preparation of Sucrose Gradients

1. Prepare one or more 38-ml (10–40% w/v) sucrose gradients in clear ultracentrifuge tubes. Store the gradients for 1–2 hours at 4°C in a quiet place until they are needed (Step 4).
 

Continuous sucrose density gradients are best made in a gradient-making device such as those supplied by Bio-Rad or Techware. Each gradient should take 10–20 minutes to pour at room temperature using a gradient maker. Each gradient can accommodate 60–75  $\mu$ g of digested bacteriophage  $\lambda$  DNA.
2. Digest and analyze ~60  $\mu$ g of the bacteriophage  $\lambda$  vector DNA as described in Protocol 13 or 14. After standard ethanol precipitation, dissolve the DNA in TE (pH 7.6) at a concentration of 150  $\mu$ g/ml. Set aside an aliquot (0.2  $\mu$ g) for use as an electrophoretic control (Step 7).
 

It is sometimes possible to digest the vector DNA with a restriction enzyme that cleaves within the stuffer fragment but not the arms. The aims of this strategy are both to reduce the size of the stuffer fragment(s) and thereby improve the separation of the stuffer from the arms and to produce termini that are incompatible with those of the arms. To determine whether this strategy can be used, consult a description of the vector.

If the vector arms have been ligated first (please see the panel on **LIGATION FIRST**), proceed to Step 4.
3. Add MgCl<sub>2</sub> (1 M) to a final concentration of 10 mM, and incubate the solution of bacteriophage DNA for 1 hour at 42°C to allow the cohesive termini of bacteriophage  $\lambda$  DNA to anneal. Analyze an aliquot (0.2  $\mu$ g) by electrophoresis through an 0.7% agarose gel to determine whether annealing has occurred.
 

Use as markers 0.2  $\mu$ g of intact bacteriophage  $\lambda$  DNA (Protocol 11 or 12), and an aliquot (0.2  $\mu$ g) of the annealed DNA that has been heated to 68°C for 10 minutes to melt the cohesive termini.

4. Load onto each gradient no more than 75  $\mu\text{g}$  of annealed, digested bacteriophage  $\lambda$  DNA in a volume of 500  $\mu\text{l}$  or less.

More DNA can cause the gradient to be overloaded and lead to poor separation of the stuffer fragments from the arms.

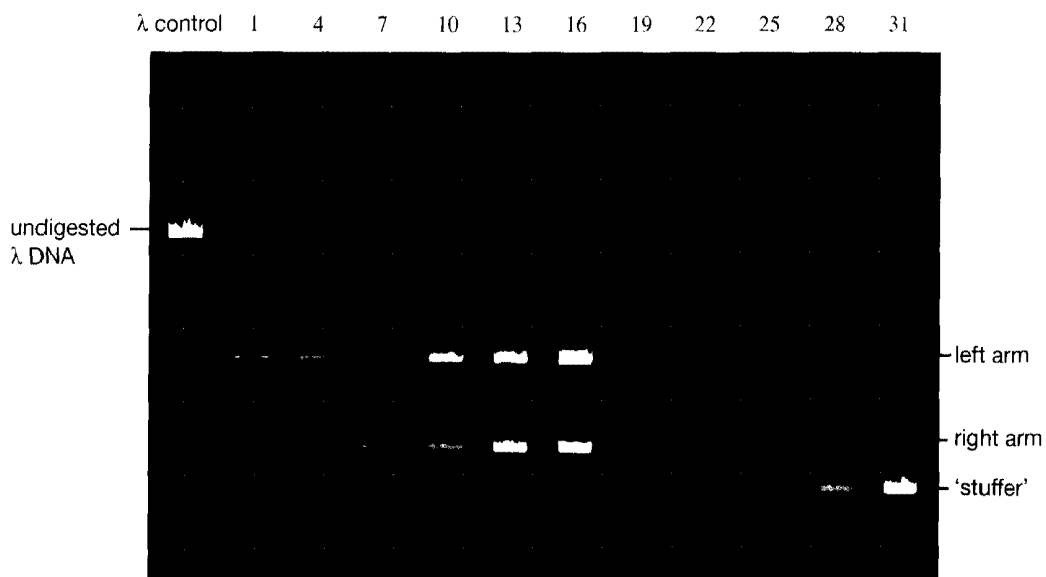
5. Centrifuge the gradients at 120,000g (26,000 rpm in a Beckman SW28 rotor) for 24 hours at 15°C.
6. Collect 0.5-ml fractions through a 21-gauge needle inserted through the bottom of the centrifuge tube.
7. Take two 15- $\mu\text{l}$  aliquots from every third fraction and dilute each with 35  $\mu\text{l}$  of  $\text{H}_2\text{O}$ . Add 8  $\mu\text{l}$  of sucrose gel-loading buffer, heat one aliquot from each fraction to 68°C for 5 minutes, and leave the second aliquot untreated. Analyze all of the samples by electrophoresis through a thick 0.5% agarose gel. Use as markers intact bacteriophage  $\lambda$  DNA and the aliquot of digested DNA set aside in Step 2.

Adjust the sucrose and salt concentrations of the markers to match those of the samples; otherwise, their electrophoretic mobilities will not be comparable.

The annealed arms migrate through the 0.5% agarose gel at a rate that is usually indistinguishable from that of intact bacteriophage  $\lambda$  DNA. Do not run the analytical gels at high voltage or in electrophoresis buffers of high electrical resistance: Overheating melts the cohesive termini of bacteriophage  $\lambda$  DNA during electrophoresis.

8. After photographing the gel, locate and pool the fractions that contain the annealed arms (Figure 2-13).

Be careful not to include fractions that are visibly contaminated with undigested bacteriophage  $\lambda$  DNA or fractions that contain significant quantities of unannealed left or right arms or stuffer fragment(s).



**FIGURE 2-13 Preparation of the Arms of Bacteriophage  $\lambda$  DNA by Sucrose Gradient Centrifugation**

In the experiment depicted here, the DNA of bacteriophage  $\lambda$  vector Charon 28 was digested with *Bam*HI, and centrifuged through a 10–40% linear sucrose gradient, which was then fractionated as described in the protocol. Aliquots from every third fraction were heated to 68°C for 5 minutes and then prepared for electrophoresis and analyzed on a 0.5% agarose gel. The positions of the left arm (23.5 kb), right arm (9 kb), “stuffer” fragments (6.5 kb), and undigested  $\lambda$  DNA are indicated. Fractions 1–16 containing the arms were pooled.

9. Dialyze the pooled fractions against a 1000-fold excess of TE (pH 8.0) for 12–16 hours at 4°C, with at least one change of buffer.

Be sure to allow for a two- to threefold increase in volume during dialysis.

Alternatively, if the volume of the pooled sample is small, the DNA can be precipitated with ethanol without prior dialysis by diluting the sample with TE (pH 7.6) so that the concentration of sucrose is reduced to ~10%. In this case, if ethidium bromide was included in the density gradients, extract the purified arms twice with isoamyl alcohol to remove residual dye from the DNA.

10. Extract the dialyzed sample several times with *n*-butanol to reduce its volume to less than 3 ml.
11. Recover the dialyzed DNA by standard ethanol precipitation.
12. Dissolve the DNA in TE (pH 7.6) at a concentration of 300–500  $\mu\text{g/ml}$ .
13. Measure the concentration of the DNA spectrophotometrically ( $1 \text{ OD}_{260} = \sim 50 \mu\text{g/ml}$ ), and analyze an aliquot by electrophoresis through a 0.5% agarose gel to assess its purity. Store the DNA at  $-20^\circ\text{C}$  in aliquots of 1–5  $\mu\text{g}$ .

# Protocol 17

---

## Partial Digestion of Eukaryotic DNA for Use in Genomic Libraries: Pilot Reactions

**H**IGH-MOLECULAR-WEIGHT DNA CAN BE FRAGMENTED in a quasi-random fashion, irrespective of its base composition and sequence, by hydrodynamic shearing (please see Table 12-1 in Chapter 12, Protocol 1). However, DNA prepared in this way requires extensive enzymatic manipulations (repair of termini, methylation, ligation to linkers, digestion of linkers) to protect internal restriction sites and to generate cohesive termini compatible with those of the vectors used to generate genomic DNA libraries (Maniatis et al. 1978). On the other hand, partial digestion with restriction enzymes that recognize frequently occurring tetranucleotide sequences within eukaryotic DNA yields a population of fragments that is close enough to random for many purposes and yet can be used without further manipulation to generate genomic libraries.

The following are four methods commonly used for partial digestion of high-molecular-weight DNA in solution:

- varying the concentration of the enzyme
- varying the length of the incubation
- limiting the concentration of  $Mg^{2+}$  (Albertsen et al. 1990)
- protecting a subset of restriction sites with the cognate methylase (Hoheisel et al. 1989)

The first of these methods is the simplest to set up and, in our hands, the most reproducible. The conditions for partial digestion are established empirically in pilot experiments presented in this protocol, whose intent is to maximize the yield of fragments of a size appropriate for insertion into a vector. The aim of these small-scale reactions is to determine the amount of enzyme required to reduce the modal size of the DNA to 20–25 kb (when bacteriophage  $\lambda$  is used as a vector) or ~45 kb (for construction of libraries in cosmids). The optimum amount of enzyme necessary will vary for each batch of enzyme and preparation of DNA. On the basis of the results obtained from the pilot experiments, large-scale preparative reactions are set up, each containing slightly different concentrations of restriction enzyme (Protocol 18).

To construct a genomic library, the average length of the starting genomic DNA should be at least eight times the capacity of the vector. This size range ensures that the majority of DNA molecules created by partial digestion with restriction enzyme(s) are derived from internal segments of the high-molecular-weight DNA and therefore carry termini that are compatible with those of the vector arms. Methods to isolate genomic DNA of the required size are presented in Chapter 6, Protocols 1 and 2. The size of the genomic DNA before digestion should be checked by pulsed-field electrophoresis or by conventional electrophoresis through a 0.7% agarose gel, using as markers oligomers of bacteriophage  $\lambda$  DNA. These can be either obtained commercially or generated in the laboratory.

Before using a preparation of genomic DNA, it is a good idea to set up a mock enzyme digestion that includes genomic DNA and 1x restriction enzyme buffer, but no enzyme. Incubate the solution for 1–2 hours at the optimum digestion temperature for the particular enzyme and then examine the DNA by electrophoresis through a 0.5% agarose gel or by pulsed-field gel electrophoresis. Compare the mock-digested DNA to a sample of DNA that has been incubated in TE for the same period of time and to a sample not subjected to incubation. There should be no difference in the size of the DNA present in the three samples. If degradation has occurred in the sample incubated in restriction enzyme buffer, then the starting DNA is probably contaminated with a nonspecific DNase that is activated by the presence of the  $Mg^{2+}$  ions in the buffer. This type of contaminant can be removed by gentle extraction with phenol:chloroform and dialysis against several changes of TE (pH 7.6).

## MATERIALS

**CAUTION:** Please see Appendix 12 for appropriate handling of materials marked with <!>.

### Buffers and Solutions

Please see Appendix 1 for components of stock solutions, buffers, and reagents.  
Dilute stock solutions to the appropriate concentrations.

*Sucrose gel-loading buffer*

Please see Table 5-4 in Chapter 5, Protocol 1.

*Tris-Cl (10 mM, pH 8.0)*

### Enzymes and Buffers

*Restriction endonucleases*

The best results are obtained if the same batch of 10x buffer is used in both the pilot reactions and the large-scale reaction.

### Gels

*Agarose gel (0.6%) cast in 0.5x TBE, containing 0.5  $\mu$ g/ml ethidium bromide <!>*

or

*Agarose gel for pulsed-field gel electrophoresis*

Please see Step 8. For information on pulsed-field gel electrophoresis, please see Chapter 5.

### Nucleic Acids and Oligonucleotides

*Genomic DNA, high molecular weight*

*Oligomers of bacteriophage  $\lambda$  DNA and plasmids*

Use as DNA size standards during gel electrophoresis. Please see Appendix 6.

### Special Equipment

*Capillary tube, sealed*

*Dialysis tubing, boiled*

For preparation of dialysis tubing for use with DNA, please see Appendix 8.

*Water bath preset to 70°C*

*Wide-bore pipette tips*



## METHOD

---

1. Set up pilot reactions using the same batch of genomic DNA that will be used to prepare fragments for cloning.
  - a. Dilute 30  $\mu\text{g}$  of high-molecular-weight eukaryotic DNA to 900  $\mu\text{l}$  with 10 mM Tris-Cl (pH 8.0) and add 100  $\mu\text{l}$  of the appropriate 10x restriction enzyme buffer.
  - b. Use a sealed glass capillary to mix the solution gently. This mixing ensures that the high-molecular-weight DNA is distributed evenly throughout the restriction enzyme buffer.
  - c. After mixing, store the diluted DNA for 1 hour at room temperature to allow any residual clumps of DNA to disperse (please also see the note to Step 8, below).

If the concentration of the high-molecular-weight DNA is low, it is best to increase the volume of the pilot reactions and concentrate the DNA after digestion by standard ethanol precipitation. This approach minimizes the possibility of shearing the high-molecular-weight DNA, which can occur if it is concentrated before digestion. Each pilot reaction should contain at least 1  $\mu\text{g}$  of DNA to allow the heterogeneous products of digestion to be detected by staining with ethidium bromide.

2. Label a series of microfuge tubes 1 through 10. Use a wide-bore glass capillary or disposable plastic pipette tip to transfer 60  $\mu\text{l}$  of the DNA solution to a microfuge tube (Tube 1). Transfer 30  $\mu\text{l}$  of the DNA solution to each of nine additional labeled microfuge tubes. Incubate the tubes on ice.
3. Add 2 units of the appropriate restriction enzyme to Tube 1.

Use a sealed glass capillary to mix the restriction enzyme with the DNA. Do not allow the temperature of the reaction to rise above 4°C.
4. Use a fresh pipette tip to transfer 30  $\mu\text{l}$  of the reaction from Tube 1 to the next tube in the series. Mix as before, and continue transferring the reaction to successive tubes. Do not add anything to the tenth tube (the no enzyme control), but discard 30  $\mu\text{l}$  from the ninth tube.
5. Incubate the reactions for 1 hour at 37°C.
6. Inactivate the restriction enzyme by heating the reactions to 70°C for 15 minutes.

For some enzymes, it is necessary to heat the reaction to 80°C for 20 minutes. Check the product documentation in the manufacturer's catalog or Web site.
7. Cool the reactions to room temperature and add the appropriate amount of sucrose gel-loading buffer.

Use a sealed glass capillary to mix the solutions gently.
8. Use wide-bore plastic pipette tip or a disposable wide-bore glass capillary to transfer the solutions to the wells of a 0.6% agarose gel or, even better, to the lanes of an agarose gel for pulsed-field electrophoresis (please see Chapter 5). Perform electrophoresis.

When separating the partial digestion products by agarose gel electrophoresis, it is essential to run the gel under conditions of maximum resolution. Use the same batch of buffer to cast the gel and to fill the gel tank prior to electrophoresis. The gel should be run slowly ( $<1$  V/cm) at 4°C to prevent smearing of the fragments of DNA. Occasionally, problems arise during loading of the gel because the DNA solution will not sink to the bottom of the well. This floating occurs when very high-molecular-weight DNA is present in the preparation. To minimize the problem, make sure that the DNA is homogeneously dispersed and load the samples very slowly into the wells of the gel. After loading, allow the gel to stand for a few minutes so that the DNA can diffuse evenly throughout the wells.

9. Compare the size of the digested eukaryotic DNA with that of DNA standards composed of oligomers of bacteriophage  $\lambda$  DNA and plasmids. Identify the partial digestion conditions that result in a majority of the genomic DNA migrating in the desired size range.

Before partial digestion of genomic DNA with the desired restriction enzyme, there should be no low-molecular-weight DNA detectable in the preparation. With increasing time of digestion or increasing amounts of restriction enzyme, the modal size of DNA should decrease monotonically, i.e., there should be no residual material at the top of the gel and no sign of a resistant fraction of DNA. Optimal conditions of digestion should yield a population of DNA molecules that migrates as a fairly compact band of the desired size. If the DNA smears into the lower part of the gel, do not proceed further. It is likely that the DNA has been asynchronously digested by the restriction enzyme, with some molecules in the starting population being cleaved more frequently than others. This phenomenon can occur if the restriction buffer and enzyme are not distributed homogeneously throughout the DNA solution at the start of the reaction. Clumps of DNA are relatively inaccessible to restriction enzymes and can be digested only from the outside. Unless the DNA is evenly dispersed, the rate of digestion cannot be predicted or controlled. One solution to this problem is to dialyze the DNA to be used for the pilot and large-scale digests for several hours against a 20-fold excess of the appropriate 1x restriction enzyme buffer. Alternatively, allow the DNA to stand for several hours at 4°C after dilution and addition of 10x restriction enzyme buffer. Gently stir the DNA solution from time to time using a sealed glass capillary tube.

# Protocol 18

---

## Partial Digestion of Eukaryotic DNA for Use in Genomic Libraries: Preparative Reactions

**H**IGH-MOLECULAR-WEIGHT DNA CAN BE FRAGMENTED by partial digestion with restriction enzymes. (In particular circumstances, it may be desirable to perform a complete digestion of the DNA; for further discussion, please see the panel on **CLONING SPECIFIC FRAGMENTS OF GENOMIC DNA**.) The appropriate conditions for partial digestion are established in pilot experiments (please see Protocol 17). The results of the pilot experiments determine the conditions for three large-scale reactions for preparing genomic DNA for cloning, presented here. The reactions utilize the results generated in Protocol 17 as a starting point and make small adjustments in the ratio of enzyme to DNA substrate around the empirically determined optimum. Bracketing the conditions that are predicted to work well offers some insurance against problems that can arise during scale-up of pilot experiments. Nevertheless, it is important to ensure that the conditions for the large-scale digestion are as identical as possible to those used in the pilot experiment in Protocol 17. After preparative digestion, the products of the large-scale partial digestion are fractionated by sucrose gradient centrifugation, and the fragments of the desired size are recovered.

### **CLONING SPECIFIC FRAGMENTS OF GENOMIC DNA**

In some cases, the size of the target DNA fragment in a genomic DNA sample is known. For example, a restriction fragment of a known size may be required to fill a gap in a cloned region, for constructing a knock-out vector, or for isolating a grossly rearranged allele of a target gene. In these situations, enriching the population of genomic DNA for fragments in the desired size range decreases the amount of screening of recombinants and increases the chance of isolating the desired clone. The protocol for partial purification is identical to that described above except that the genomic DNA is subject to complete digestion with the restriction enzyme instead of a partial digestion. Before sucrose gradient fractionation, the digested DNA can be subjected to Southern blotting (if an appropriate probe is available) to ensure that the digest is complete. In addition, if a probe is available, a Southern blot of the agarose gel used to analyze fractions isolated from the sucrose gradient (Step 5) can identify those containing the highest concentration of the target fragment. Thereafter, the pooled fractions can be dialyzed and the DNA recovered by standard ethanol precipitation before ligation into an appropriate vector.

## MATERIALS

**CAUTION:** Please see Appendix 12 for appropriate handling of materials marked with <!.>.

### Buffers and Solutions

Please see Appendix 1 for components of stock solutions, buffers, and reagents. Dilute stock solutions to the appropriate concentrations.

*Ammonium acetate (10 M)*

*Ethanol*

*n-butanol <!.>*

*Phenol:chloroform (1:1, v/v) <!.>*

*Sodium acetate (3 M, pH 5.2)*

*Sucrose gel-loading buffer*

Please see Table 5-4 in Chapter 5, Protocol 1.

*TE (pH 8.0)*

*Tris-Cl (10 mM, pH 8.0)*

### Enzymes and Buffers

*Restriction endonucleases*

The best results are obtained if the same batch of 10x buffer is used in both the pilot reactions and the large-scale reaction.

### Gels

*Agarose gel*

Please see Step 2.

*Agarose gel (0.6%) cast in 0.5x TBE, containing 0.5 µg/ml ethidium bromide <!.>*

Please see Step 7.

*Agarose gel for pulsed-field gel electrophoresis*

Please see Step 12. For information on pulsed-field gel electrophoresis, please see Chapter 5.

### Nucleic Acids and Oligonucleotides

*Genomic DNA, high molecular weight*

*Oligomers of bacteriophage λ DNA and plasmids*

Use as DNA size standards during gel electrophoresis. Please see Appendix 6.

### Centrifuges and Rotors

*Beckman SW28 rotor or equivalent*

### Special Equipment

*Dialysis tubing, boiled*

For preparation of dialysis tubing for use with DNA, please see Appendix 8.

*Gradient fractionating device (optional)*

Please see Step 4. These devices are rather hard to come by, but they generally can be borrowed from aged biochemists. If all else fails, the gradients can be fractionated by puncturing the bottom of the centrifuge tube with a 21-gauge hypodermic needle (no syringe barrel required).

*Sucrose gradients*

Prepare two sucrose solutions, one containing 10% (w/v) sucrose and another containing 40% (w/v) sucrose in a buffer of 1 M NaCl, 20 mM Tris-Cl (pH 8.0), and 5 mM EDTA (pH 8.0). Sterilize the two solutions by filtration through 0.22-µm nitrocellulose filters. The gradients are prepared as described in Step 1.

Alternatively, linear sucrose gradients can be formed by diffusion (Brakke 1958). Many investigators prefer to use this method when large numbers of gradients are required. Four sterile sucrose solutions are required (10%, 20%, 30%, and 40% [w/v] sucrose) in 1 M NaCl, 20 mM Tris-Cl (pH 8.0), and 5 mM EDTA (pH 8.0). To form a 38-ml gradient in a Beckman SW28 centrifuge tube (or equivalent), 9.5 ml of

each of the four sucrose solutions is successively layered on top of each other. Most investigators prefer to place the 40% sucrose solution in the bottom of the tube and then to overlay carefully with the three remaining solutions in order of decreasing density: 30%, 20%, and finally 10% sucrose. However, the gradients can also be formed by placing the least dense sucrose solution (10%) in the bottom of the tube and underlying with progressively more dense sucrose solutions. Allow the step gradients to stand undisturbed for 2.5–3.0 hours at room temperature. Place each gradient in a bath of ice water to cool for 15 minutes before centrifugation.

*Water bath preset to 68°C*

## METHOD

---

### Preparation of the Gradient

1. Prepare one or more 38-ml (10–40% w/v) sucrose gradients in clear ultracentrifuge tubes. Store the gradients for 1–2 hours at 4°C in a quiet place until they are needed (Step 5).  
 Continuous sucrose density gradients are best made in a gradient-making device such as those supplied by Bio-Rad or Techware. Each gradient should take 10–20 minutes to pour at room temperature using a gradient maker. Each gradient can accommodate 60–75  $\mu\text{g}$  of digested bacteriophage  $\lambda$  DNA.
2. Set up a series of digestions, each containing 100  $\mu\text{g}$  of high-molecular-weight DNA.
  - a. Use three different concentrations of restriction enzyme that straddle the optimal concentration determined in the pilot experiments (Protocol 17).
  - b. Incubate the reactions for the appropriate time with the restriction enzyme.
  - c. Analyze an aliquot of the partially digested DNA by gel electrophoresis to ensure that the digestion has worked according to prediction. Until the results are available, store the remainder of the sample at 0°C.
3. Gently extract the digested DNA twice with phenol:chloroform.
4. Recover the DNA by standard precipitation with ethanol and dissolve it in 200  $\mu\text{l}$  of TE (pH 8.0).

### Size Fractionation of DNA through the Gradient

5. Heat the DNA sample (100  $\mu\text{g}$ ) for 10 minutes at 68°C, cool to 20°C, and gently layer the sample on the top of the gradient. Centrifuge the gradients at 83,000g (25,000 rpm in a Beckman SW28 rotor) for 22 hours at 20°C.  
 Centrifugation is carried out at room temperature rather than 4°C to suppress intra- and inter-molecular annealing of cohesive termini.
6. Use a 21-gauge needle or a gradient fractionation device to puncture the bottom of the tube and collect 350- $\mu\text{l}$  fractions.
7. Mix 10  $\mu\text{l}$  of every other fraction with 10  $\mu\text{l}$  of H<sub>2</sub>O and 5  $\mu\text{l}$  of sucrose gel-loading buffer. Analyze the size of the DNA in each fraction by electrophoresis through a 0.6% agarose gel, using oligomers of plasmid DNA or other high-molecular-weight standards as markers. Adjust the sucrose and salt concentrations of the markers to correspond to those of the samples.
8. Following electrophoresis, pool the gradient fractions containing DNA fragments of the desired size (e.g., 35–45 kb for construction of libraries in cosmids and 20–25 kb for construction of libraries in bacteriophage  $\lambda$  vectors).

9. Dialyze the pooled fractions against 2 liters of TE (pH 8.0) for 12–16 hours at 4°C, with a change of buffer after 4–6 hours.

Leave space in the dialysis sac for the sample to expand two- to threefold in volume.

Alternatively, if the volume of the pooled sample is sufficiently small, the DNA can be precipitated with ethanol without prior dialysis after first diluting the sample with TE (pH 8.0) so that the concentration of sucrose is reduced to 10% or less.

10. Extract the dialyzed DNA several times with an equal volume of *n*-butanol until the volume is reduced to ~1 ml.
11. Precipitate the DNA with ethanol at room temperature in the presence of 2 M ammonium acetate (from a 10 M stock solution).
12. Recover the DNA by centrifugation and dissolve the DNA in TE (pH 8.0) at a concentration of 300–500 µg/ml. Analyze an aliquot of the DNA (0.5 µg) by electrophoresis through a conventional 0.6% agarose gel or by pulsed-field electrophoresis to check that the size distribution of the digestion products is correct. Store the DNA at 4°C.
13. To establish genomic DNA libraries, ligate the fractionated DNA to the arms of bacteriophage λ vectors as described in Protocol 19. For the preparation of cosmid libraries, please see Chapter 4, Protocol 1.

# Protocol 19

---

## Ligation of Bacteriophage $\lambda$ Arms to Fragments of Foreign Genomic DNA

**T**WO IMPORTANT PARAMETERS MUST BE CONSIDERED WHEN LIGATING bacteriophage  $\lambda$  arms to segments of foreign DNA: the molar ratio of arms to potential inserts and the concentration of each DNA species in the reaction mixture. Optimum values for both of these parameters can be estimated from theoretical considerations (Dugaiczuk et al. 1975). By necessity, however, such calculations assume that all the DNA molecules in the ligation reaction are perfect. As this nirvana is rarely attained, it is advisable to carry out pilot reactions to check the efficiency of each new preparation of arms and potential inserts.

Typically, trial ligations contain  $\sim 0.5$ – $1.0$   $\mu\text{g}$  of bacteriophage  $\lambda$  arms and different amounts of foreign DNA. The molar ratio of arms to potential inserts in the test ligations should range from 1:4 to 8:1 (please see Table 2-4) and the volume of the ligation mixture should be as small as possible (10  $\mu\text{l}$  or less). The amounts of inserts recommended in Table 2-4 have been calculated on the assumption that the ligation reactions contain 1  $\mu\text{g}$  of bacteriophage  $\lambda$  arms, 40 kb in size. In the ligation reactions containing the lowest recommended amount of foreign DNA, the bacteriophage  $\lambda$  arms will be present in eightfold molar excess; in mixtures containing the greatest amount of potential insert, the insert will be present in fourfold molar excess. It is essential to also include two controls containing (1) bacteriophage  $\lambda$  arms but no insert and (2) insert but no bacteriophage  $\lambda$  arms. Once assembled, the ligation reactions are usually incubated for 4–16 hours at 16°C.

The success of the ligation reactions can be estimated by electrophoretic analysis of small aliquots, using a 0.5% agarose gel. If the ligation reactions have been successful, then almost all of the DNA should be at least as large as intact bacteriophage  $\lambda$  DNA. However, it is difficult to know whether a large DNA species on an agarose gel is composed of the desired vector-insert combinations or other undesirable combinations (e.g., [vector]<sub>n</sub>, [insert]<sub>n</sub>). A better method of judging the success of the ligation is to package a proportion of the ligation products (10–25%) into bacteriophage particles *in vitro*. The ligation reaction containing the optimum ratio of arms to inserts should yield at least  $10^6$  to  $10^7$  recombinants/ $\mu\text{g}$  of bacteriophage  $\lambda$ . After the ratio of arms to insert that gives the largest number of recombinant bacteriophage has been established, additional ligation and packaging reactions may be set up to generate a library of cloned fragments. This primary library can then be plated and screened by hybridization directly for recombinant bacteriophages of interest, or the library can be amplified, divided into aliquots, and stored.

**TABLE 2-4** Amounts of Insert DNA Used in Trial Ligations Containing 1  $\mu$ g of Bacteriophage  $\lambda$  Arms

SIZE OF POTENTIAL INSERT DNA (kb)	AMOUNT OF INSERT DNA (ng)
2-4	6-200
4-8	12-400
8-12	24-600
12-16	36-800
16-20	48-1000
20-24	60-1200

## MATERIALS

**CAUTION:** Please see Appendix 12 for appropriate handling of materials marked with <!>.

### Buffers and Solutions

Please see Appendix 1 for components of stock solutions, buffers, and reagents. Dilute stock solutions to the appropriate concentrations.

*ATP (10 mM)*

Omit ATP from Step 1 if the ligation buffer contains ATP.

*SM and SM plus gelatin*

### Enzymes and Buffers

*Bacteriophage T4 DNA ligase*

### Gels

*Agarose gel (0.7%) cast in 0.5 $\times$  TBE, containing 0.5  $\mu$ g/ml ethidium bromide <!>*

Please see Step 6.

### Nucleic Acids and Oligonucleotides

*Genomic DNA, of an appropriate size for the vector*

Prepared as described in Protocol 18 of this chapter. In addition, please see the panel in the introduction to Protocol 18.

### Media

*LB or NZCYM agar plates*

*LB or NZCYM top agarose*

For details on using top agarose, please see Protocol 1 of this chapter. Agarose is preferred to agar in this protocol in order to minimize contamination with inhibitors that can interfere with subsequent enzymatic analysis of bacteriophage.

### Special Equipment

*Heating block or water bath preset to 47°C (for top agarose)*

*Water bath preset to 16°C*

### Additional Reagents

*Step 4 of this protocol requires the reagents listed in Protocol 1 of this chapter.*

### Vectors and Bacterial Strains

*Bacteriophage  $\lambda$  packaging mixtures*

These may be purchased in kit form from any of several commercial manufacturers (e.g., Epicentre Technology, Life Technologies, Promega, and Stratagene).

For a discussion of in vitro packaging extracts, please see the information panel on **IN VITRO PACKAGING**.



*Bacteriophage  $\lambda$  DNA arms*

Prepared by one of the methods described in Protocols 11 through 15 of this chapter.

*E. coli plating bacteria*

Prepared as described in Protocol 1 of this chapter.

**METHOD**

1. Use Table 2-4 as a guide to set up a series of ligation reactions that contain the following:

bacteriophage $\lambda$ arms	0.5–1.0 $\mu$ g
partially digested genomic DNA	6–1200 ng
10 $\times$ ligation buffer	0.5–1.0 $\mu$ l
10 mM ATP (if necessary)	0.5–1.0 $\mu$ l
bacteriophage T4 DNA ligase	0.5–1.0 $\mu$ l
H <sub>2</sub> O	to 5 or 10 $\mu$ l

Set up two control reactions in which the vector and insert DNAs are each ligated in the absence of the other. Incubate the ligation reactions for 4–16 hours at 16°C.

To achieve the maximum efficiency of ligation, set up the reactions in as small a volume as possible (5–10  $\mu$ l). The addition of ATP as a component of the 10 $\times$  ligation buffer leaves more volume for vector or foreign DNA in the reaction mixture.

Omit ATP if using a commercial ligase buffer that contains ATP.

2. Package an aliquot (10–25%) of each of the ligation reactions into bacteriophage particles, following the instructions provided by the manufacturer of the packaging extract.
 

Most manufacturers provide a control preparation of bacteriophage  $\lambda$  DNA that can be used as a standard to measure the efficiency of packaging.
3. Make a series of tenfold dilutions ( $10^{-1}$  to  $10^{-5}$ ) of the packaging reactions, using as a diluent SM plus gelatin or an equivalent buffer recommended by the manufacturer of the packaging extract.
4. Assay the number of plaque-forming units in 1  $\mu$ l and 10  $\mu$ l of each dilution as described in Protocol 1.
5. From the ligation reaction yielding the largest number of infectious bacteriophage particles, pick 6–12 plaques and prepare a small amount of recombinant DNA from each as described in Protocol 23.
6. Check the size of the inserts of genomic DNA by digestion with the appropriate restriction enzymes, followed by electrophoresis through a 0.7% agarose gel, using appropriate size markers.
7. If the bacteriophages are recombinants and contain inserts of the desired size, establish a genomic DNA library by setting up multiple ligation and packaging reactions. The ratio of insert to vector DNA in these reactions should be that which generated the greatest number of recombinant plaques in the trial reactions.
8. Estimate the total number of recombinant plaques generated in the large-scale ligation and packaging reactions. Calculate the depth to which a library of this size would cover the target genome.

To provide fivefold coverage of a mammalian genome ( $3 \times 10^9$  bp), a bacteriophage  $\lambda$  library containing inserts whose average size is 20 kb would contain  $2 \times 10^6$  independent recombinants.

# Protocol 20

---

## Amplification of Genomic Libraries

**T**HE LIBRARY OF RECOMBINANT BACTERIOPHAGES MAY BE AMPLIFIED by growing plate stocks directly from the packaging mixture as described in this protocol. However, whenever possible, the amplification step should be omitted and the primary library screened directly for DNA sequences of interest. Amplification invariably decreases the complexity (the number of independent clones) present in the library, in part because slower-growing recombinant bacteriophages are disadvantaged during successive rounds of bacteriophage growth. Variation in the growth of individual bacteriophages can arise, for example, from the presence of sequences in the segment of foreign DNA that cannot be efficiently replicated or that are toxic for essential host or viral functions or from recombination events that decrease the size of the bacteriophage genome below that required for efficient packaging of the DNA. The greater the amplification of the library, the more distorted the population of recombinant bacteriophages becomes.

Direct screening of an unamplified library increases the chance of identifying and recovering recombinants of interest that grow slowly or produce lower yields of virus. Of course, the recombinant bacteriophage particles packaged from the ligation reactions are a finite resource. However, as long as the supply of foreign DNA is not limiting, it is preferable to set up additional ligation/packaging reactions, to forego amplification, and to screen bacteriophages directly from packaging reactions. If the source of foreign DNA is in short supply, amplification may be unavoidable, but should be kept to a minimum. For an alternative amplification method, please see the panel on **IN SITU AMPLIFICATION** in Protocol 21).

---

### MATERIALS

---

**CAUTION:** Please see Appendix 12 for appropriate handling of materials marked with <!>.

#### Buffers and Solutions

Please see Appendix 1 for components of stock solutions, buffers, and reagents. Dilute stock solutions to the appropriate concentrations.

*Chloroform* <!>

*SM*

## Media

*LB or NZCYM agar plates (150 mm)*

*LB or NZCYM top agarose*

For details on using top agarose, please see Protocol 1 of this chapter. Agarose is preferred to agar in this protocol in order to minimize contamination with inhibitors that can interfere with subsequent enzymatic analysis of bacteriophage.

## Centrifuges and Rotors

*Sorvall SS-34 rotor or equivalent*

## Special Equipment

*Water bath or heating block preset to 47°C (for top agarose)*

## Vectors and Bacterial Strains

*Bacteriophage  $\lambda$  library*

Prepared as described in Protocol 19 of this chapter.

*E. coli plating bacteria*

Prepared as described in Protocol 1 of this chapter.

## METHOD

---

1. To amplify a bacteriophage  $\lambda$  library, mix aliquots of the packaging mixture containing 10,000–20,000 recombinant bacteriophages in a volume of 50  $\mu$ l or less with 0.2 ml of plating bacteria in a 13  $\times$  100-mm tube. Incubate the infected culture for 20 minutes at 37°C.
2. Add 6.5 ml of melted top agar/agarose (47°C) to the first aliquot of infected bacteria. Mix the contents of the tube by tapping or by gentle vortexing, and spread the infected bacteria onto the surface of a freshly poured 150-mm plate of bottom agar. Repeat the procedure with the remaining infected cultures.

Alternatively, as many as 450,000 bacteriophages may be mixed with 1.4 ml of bacteria and plated in 75 ml of top agar/agarose on 500 ml of bottom agar in a 23  $\times$  33-cm glass baking dish. For a discussion of the pros and cons of using baking dishes, please see the note under the LB agar plates entry in the materials list in Protocol 21.

3. Incubate the plates for a maximum of 8–10 hours at 37°C.  
Do not allow the plaques to grow so large that they touch one another. The short period of growth minimizes the chance for infection of bacteria with two different recombinants, thereby reducing the possibility of recombination between repetitive sequences carried by different recombinants with consequent “scrambling” of the library; and it decreases the opportunity for changes in the bacteriophage population that may occur because of variations in the rate of growth of different recombinants.
4. Overlay the plates with 12 ml of SM (or 150 ml of SM if baking dishes are used). Store the plates overnight at 4°C on a level surface.

The amplified recombinant bacteriophage will elute from the top agar into SM.

5. Harvest the SM from all of the plates into a single, sterile polypropylene centrifuge tube or bottle. Wash each plate with an additional 4 ml of SM, and combine the washings with the primary harvest. Add 0.2 ml of chloroform to the resulting amplified bacteriophage stock. Store the stock for 15 minutes at room temperature with occasional gentle shaking to allow time for the chloroform to lyse all of the infected cells.
6. Remove cell and agarose debris by centrifugation at 4000g (5800 rpm in a Sorvall SS-34 rotor) for 5 minutes at 4°C.
7. Transfer the supernatant to a sterile glass tube or bottle. Divide the amplified bacteriophage library into aliquots and store them at 4°C. Measure the titer of the library by plaque assay.

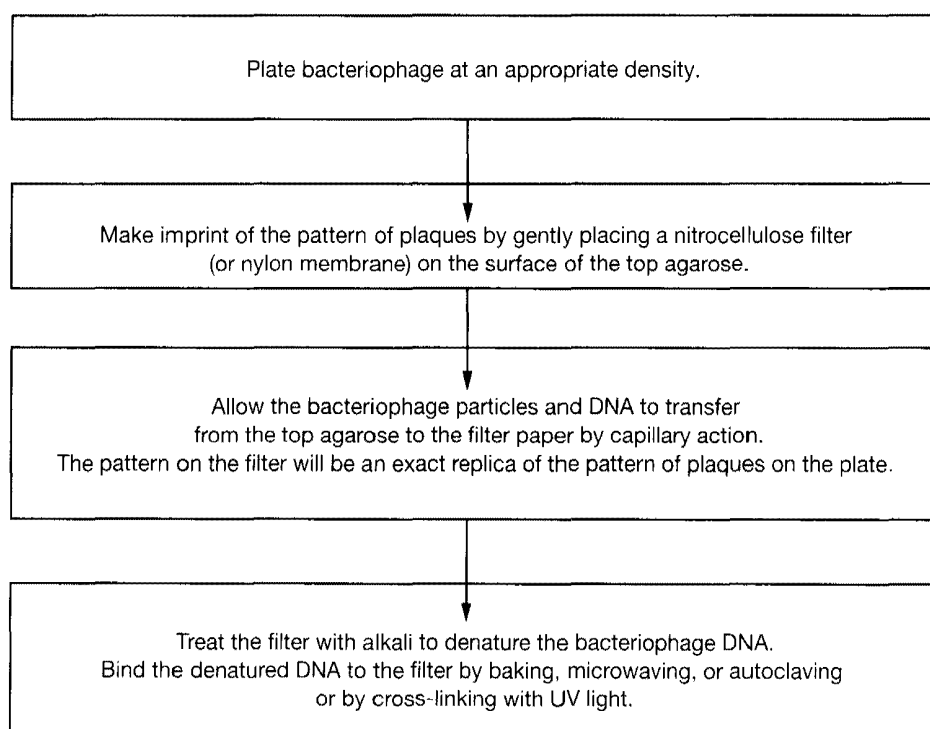
The titer of the amplified library should be stable for several months. Nevertheless, to decrease the chance of mishaps, several aliquots of the library should be placed in long-term storage as described in the panel on **LONG-TERM STORAGE OF BACTERIOPHAGE  $\lambda$  STOCKS** in Protocol 3.

# Protocol 21

---

## Transfer of Bacteriophage DNA from Plaques to Filters

**A** METHOD TO IDENTIFY AND ISOLATE SPECIFIC RECOMBINANTS from libraries of bacteriophage  $\lambda$  was developed early in the history of molecular cloning by Benton and Davis (1977). The procedure, which remains in common use, involves mass screening of plaques by hybridization in situ with  $^{32}\text{P}$ -labeled probes. With practice, it is possible to identify a single recombinant that carries the desired target sequence on a plate containing 15,000 or more plaques. For a method for amplification of bacteriophage particles on filters, please see the panel on **IN SITU AMPLIFICATION** at the end of this protocol. This protocol describes how plaques are transferred en masse from Petri dishes to nitrocellulose or nylon filters. The sequence of events is presented in Figure 2-14.



**FIGURE 2-14** Flowchart: Sequence of Transfer Steps

## MATERIALS

---

### Buffers and Solutions

Please see Appendix 1 for components of stock solutions, buffers, and reagents. Dilute stock solutions to the appropriate concentrations.

*Denaturing solution*

Depending on the number of filters to be processed, 1 liter or more may be required.

*Neutralizing solution*

Depending on the number of filters to be processed, 1 liter or more may be required.

*SM plus gelatin*

*2x SSPE*

Depending on the number of filters to be processed, 1 liter or more may be required.

### Media

*LB or NZCYM agar plates*

If the plates are not well-dried, the layer of top agarose will peel off the agar base when the filter is removed. Usually, 2-day-old plates that have been dried for several additional hours at 37°C with the lids slightly open work well. In humid weather, however, incubation for 1 day or more at 41°C may be necessary.

In the 1970s and 1980s, when screening large numbers of plaques, it was fashionable to use large Pyrex dishes instead of standard Petri dishes. This vogue was driven more by energetic investigators of the time than by common sense. For most laboratories, Pyrex dishes are an impractical option. They are heavy, breakable, have large footprints, require some sort of temporary covering during incubation, and need nitrocellulose or nylon sheets that have been specially cut to fit. Today, most laboratories use either the standard 100-mm plates or oversize (150-mm) plates. The choice between them is often determined by the size of the investigators hands.

*LB or NZCYM top agarose*

For details on using top agarose, please see Protocol 1 of this chapter. Agarose is preferred to agar in this protocol in order to minimize contamination with inhibitors that can interfere with subsequent enzymatic analysis of bacteriophage. In addition, top agarose is preferred because top agar often peels from the plate when the nitrocellulose or nylon filters are removed.

Melt the top agarose just before use by heating it in a microwave oven for a short period of time. Store the 3- or 7-ml aliquots of melted solution in a 47°C heating block or water bath to prevent the agarose from solidifying until needed in Step 3 below.

### Special Equipment

*Cross-linking device (e.g., Stratalinker, Stratagene; GS Gene Linker, Bio-Rad), Microwave oven, or Vacuum oven preset to 80°C*

*Hypodermic needle and syringe (21 gauge)*

*Nitrocellulose or Nylon filters*

Detergent-free nitrocellulose (Millipore HATF or equivalent) or nylon filters are required. To reduce the possibility of contaminating the master plates, it is best to sterilize the filters before use as described in Step 1.

If the filters will be hybridized sequentially to a number of different probes, it is better to use nylon rather than nitrocellulose filters. Nylon filters are more pliable than nitrocellulose filters and are more resistant to repeated exposure to extremes of temperature. Nylon filters are also preferred when hybridization is to be carried out in solvents containing formamide or tetramethylammonium chloride (please see Chapter 6). However, different brands of nylon filters vary in their ability to bind DNA, in the ease with which they can be stripped of radiolabeled probes, and in the degree to which they distort during repeated rounds of stripping and rehybridization (Khandjian 1987). It would therefore be sensible to check the properties of nylon filters obtained from different manufacturers before attempting large-scale screening of bacteriophage  $\lambda$  libraries. Follow the manufacturer's recommendations closely, as they presumably have been shown to lead to optimal results. In our hands, however, the lysis and hybridization procedures described in Protocol 22 work well with most commercial brands of nitrocellulose or nylon filters.

Water baths preset to 47°C and 65°C  
 Waterproof black drawing ink (India Ink)  
 Whatman 3MM paper  
 Whatman 3MM filter papers (85-mm diameter)

## Vectors and Bacterial Strains

### *Bacteriophage $\lambda$ library*

Prepared as described in Protocol 19 of this chapter or purchase from a commercial source.

### *E. coli plating bacteria*

Prepared as described in Protocol 1 of this chapter.

## METHOD

---

### Preparation of Filters and Transfer of Plaques

1. Prepare the filters for transfer:
  - a. Number the dry filters with a soft-lead pencil or a ball-point pen.  
 Prepare enough filters to make one or two (duplicate) replicas from the starting agar plate. In the latter case, number two sets of filters 1A, 1B, 2A, 2B, etc.
  - b. Soak the filters in water for 2 minutes.
  - c. Arrange the filters in a stack with each filter separated from its neighbor by an 85-mm-diameter Whatman 3MM filter paper.
  - d. Wrap the stack of filters in aluminum foil, and sterilize them by autoclaving for 15 minutes at 15 psi (1.05 kg/cm<sup>2</sup>) on liquid cycle.
2. Make a dilution (in SM plus gelatin) of the packaging mixture, bacteriophage stock, or library. Mix aliquots of the diluted bacteriophage stock with the appropriate amount of freshly prepared plating bacteria (please see Table 2-5). Incubate the infected bacterial cultures for 20 minutes at 37°C.

The diluted stock (100  $\mu$ l) should contain ~15,000 infectious bacteriophages when using 100-mm plates or 50,000 infectious particles when using 150-mm plates.

When screening bacteriophage libraries, it is best to infect the cells as a single pool. For example, when using ten 150-mm plates, 1 ml of diluted bacteriophage stock containing 500,000 pfu would be added to 3 ml of freshly prepared plating bacteria. After 20 minutes at 37°C, equal volumes of the infected culture are then distributed into 17  $\times$  100-mm tubes for plating. This procedure ensures that each plate contains approximately the same number of plaques.

**TABLE 2-5 Number of Plaques in Culture Dishes of Various Sizes**

Size of Petri dish	90 mm	150 mm
Total area of dish	63.9 cm <sup>2</sup>	176.7 cm <sup>2</sup>
Volume of bottom agar	30 ml	80 ml
Volume of plating bacteria	0.1 ml	0.3 ml
Volume of top agarose	2.5 ml	6.5–7.5 ml
Maximum number of plaques/dish	15,000	50,000

To find a bacteriophage that carries a particular genomic sequence, it may be necessary to screen one million or more recombinants in a genomic DNA library. Table 2-5 shows the maximum number of plaques that can be efficiently screened in culture dishes of different sizes. If the bacteriophages are plated at too high a density, the plaques will be crowded and hence unable to expand to their full size. As a result, the hybridization signal will be attenuated. In addition, when the bacteriophage plaques form a confluent mass, the top agarose tends to peel from the plate during removal of the nitrocellulose or nylon filter. Although this is not a total disaster, it certainly makes the task of identifying and isolating desired recombinants far more difficult. It is therefore important to measure the titer of the library before plating to ensure that the number, size, and spacing of plaques are correct.

3. Add to each aliquot of infected cells 3 ml or 6.5 ml of molten (47°C) top agarose. Pour the contents of each tube onto separate, numbered 90-mm or 150-mm agar plates.

Avoid bubbles since these will displace the filter and can generate background during the hybridization step.

4. Close the plates, allow the top agarose to harden, and incubate at 37°C in an inverted position until plaques appear and are just beginning to make contact with one another (10–12 hours).

To minimize plate-to-plate variation, it is crucial that each plate be heated to the same extent when placed in the incubator. If possible, arrange the plates in a single layer rather than in stacks. If restrictions on incubator space force stacking, stagger the plates on top of each other to enhance exposure to the air in the incubator. During incubation, keep a close eye on the plates to monitor plaque formation and size. However, resist the temptation to open the inside incubator door too many times since this will alter the temperature of the incubator and retard plaque formation. The density and size of plaques are ideal when a wispy filigree of bacterial growth is visible between adjacent plaques, whose diameter should not exceed 1.0 mm. The yield of viruses is often low from plates that show confluent lysis with no visible remnants of the bacterial lawn, simply because of a shortage of bacteria for infection. The intensity of the hybridization signal is therefore reduced and is frequently below the limit of detection.

5. Chill the plates for at least 1 hour at 4°C to allow the top agarose to harden.

6. Remove the plates from the cold room or refrigerator. Make imprints of the plaques on each plate using the first set of labeled filters. Place a dry, labeled circular nitrocellulose or nylon filter neatly onto the surface of the top agarose so that it comes into direct contact with the plaques.

Handle the filter with gloved hands; finger oils prevent wetting of the filter and affect transfer of DNA. Grasp the filter by its edges and allow the center of the slightly bent filter to make contact with the center of the top agar. Once contact has been made, slowly release the filter and allow it to flatten onto the surface of the top agarose. Do not attempt to adjust the position of the filter since this will inevitably lead to tearing of the top agarose. Be careful not to trap air bubbles, which will displace the filter and may generate background during hybridization.

7. Mark the filter in three or more asymmetric, peripheral locations by stabbing through it and into the agar beneath with a 21-gauge needle attached to a syringe containing waterproof black drawing ink.

Make sure that the keying marks are asymmetrically placed and that both the filter and the plate are marked. There must be enough ink on the plate to be easily visible when a second filter is in place. Large blotches of ink, however, are undesirable. Ink often becomes contaminated with bacteriophages and bacteria if it has been used many times. This problem can be minimized by heating the ink in a microwave oven to inactivate contaminating viruses and microorganisms.

8. After 1–2 minutes, use blunt-ended forceps (e.g., Millipore forceps) to peel the filters from each plate in turn.

This step is best done by pulling slowly upward on one edge of the filter and peeling the entire filter from the underlying agarose in a single smooth motion. At this stage, some investigators prefer to dry the filters for 15 minutes on paper towels or sheets of Whatman 3MM paper. However, in our hands, this step is unnecessary.

At this point, the transferred bacteriophage may be amplified; please see the panel on **IN SITU AMPLIFICATION** at the end of this protocol.



## Denaturation of the Bacteriophage DNA on the Filter

9. Transfer each filter, plaque side up, to a sheet of Whatman 3MM paper (or equivalent) impregnated with denaturing solution in a plastic cafeteria tray or Pyrex dish for 1–5 minutes.

Make sure that excess denaturing solution does not rinse over the sides of the nitrocellulose or nylon filters. When transferring the filters, use the edge of cafeteria tray or dish to remove as much fluid as possible from the underside of the filters.

Some investigators prefer to carry out the denaturation and neutralization (Steps 9 and 10) by immersing the filters in each solution. However, this results in weaker signals when the filters are probed by hybridization.

For an alternative method for processing filters (replacing Steps 9–13), please see the panel on **ALTERNATIVE PROTOCOL: RAPID TRANSFER OF PLAQUES TO FILTERS**.

10. Transfer the filters, plaque side up, to a sheet of Whatman 3MM paper impregnated with neutralizing solution for five minutes.

If nitrocellulose filters are used, repeat the neutralizing step using a fresh impregnated sheet of 3MM paper.

## Fixation of Bacteriophage DNA to the Filters

11. Prepare the filters for fixing.

*To fix the DNA to the filters by microwaving or baking:* If using a microwave oven, proceed directly to Step 13. If baking in a vacuum oven, transfer the filters, plaque side up, to a sheet of dry 3MM paper or a stack of paper towels. Allow filters to dry for at least 30 minutes at room temperature.

*To fix the DNA to nylon filters by cross-linking with UV light:* Place the filters on a sheet of Whatman 3MM paper impregnated with 2x SSPE, and move the tray of 2x SSPE containing the filters to the vicinity of the UV light cross-linker.

12. After the first set of filters has been processed, use the second set of filters to take another imprint of the plaques, if required. Make sure that both sets of filters are keyed to the plate at the same positions.

Generally, the second set of filters is left in contact with the plaques for 3 minutes, or until the filter is completely wet. As many as seven replicas have been prepared from a single plate (Benton and Davis 1977), but the strength of the hybridization signal decreases significantly after the third replica.

13. Fix the DNA from the plaques to the filter.

*To fix by treatment in a microwave oven:* Place the damp filters on a sheet of dry Whatman 3MM paper and irradiate them for 2–3 minutes at full power in a microwave oven.

*To fix by baking:* Arrange the dried filters (Step 10) in a stack with adjacent filters separated by a sheet of dry Whatman 3MM paper. Bake the stack of filters for 1–2 hours at 80°C in a vacuum oven.

Check the oven after 30 minutes and wipe away any condensation from the door. The filters must be baked under vacuum rather than stewed.

Baking for more than 2 hours can cause nitrocellulose filters to become brittle. Baking at temperatures higher than 80°C can cause nitrocellulose filters to explode.

Nitrocellulose filters that have not been completely neutralized turn yellow or brown during baking and chip very easily. The background of nonspecific hybridization increases dramatically.

To fix by cross-linking with UV light: Carry out the procedure using a commercial device for this purpose and follow the manufacturer's instructions.

▲ **IMPORTANT** Do not allow the filters to dry out prior to cross-linking.

14. After baking or cross-linking, loosely wrap the dry filters in aluminum foil and store them at room temperature. Alternatively, if hybridization is to be carried out within a day or so, wash the filters for 30 minutes at 65°C in 0.1x SSC or SSPE, 0.5% SDS and store them wet in sealed plastic bags.

The filters may now be used for hybridization as described in Protocol 22.

#### IN SITU AMPLIFICATION

Woo et al. (1978) and Woo (1979) have described a modification of the Benton and Davis (1977) screening method that involves amplification of the bacteriophages on the nitrocellulose filter prior to hybridization. Because more bacteriophage DNA becomes attached to the nitrocellulose filter, the autoradiographic signals from positive clones are enhanced approximately fivefold. Amplification therefore leads to an improvement in the ratio of signal to noise and also allows the length of the autoradiographic exposure to be reduced. Amplification is particularly valuable when oligonucleotides of high degeneracy are used as probes (please see Chapter 10), when only a small amount of a valuable probe is available, or when screening under conditions of reduced stringency. A detailed protocol for in situ amplification is outlined on pages 2.112–2.113 of the Second Edition of *Molecular Cloning*.

#### ALTERNATIVE PROTOCOL: RAPID TRANSFER OF PLAQUES TO FILTERS

The following procedure, based on a protocol developed by Gary Struhl in 1983 while he was a postdoctoral fellow in Tom Maniatis' laboratory, eliminates treatment of filters with alkali, can save time when dealing with large numbers of filters, and may be used as an alternative to Steps 9 through 13. Nitrocellulose filters must be sterilized to prevent shrinkage (please see Step 1 above); however, nylon filters are, in our hands, superior and are therefore recommended.

##### Method

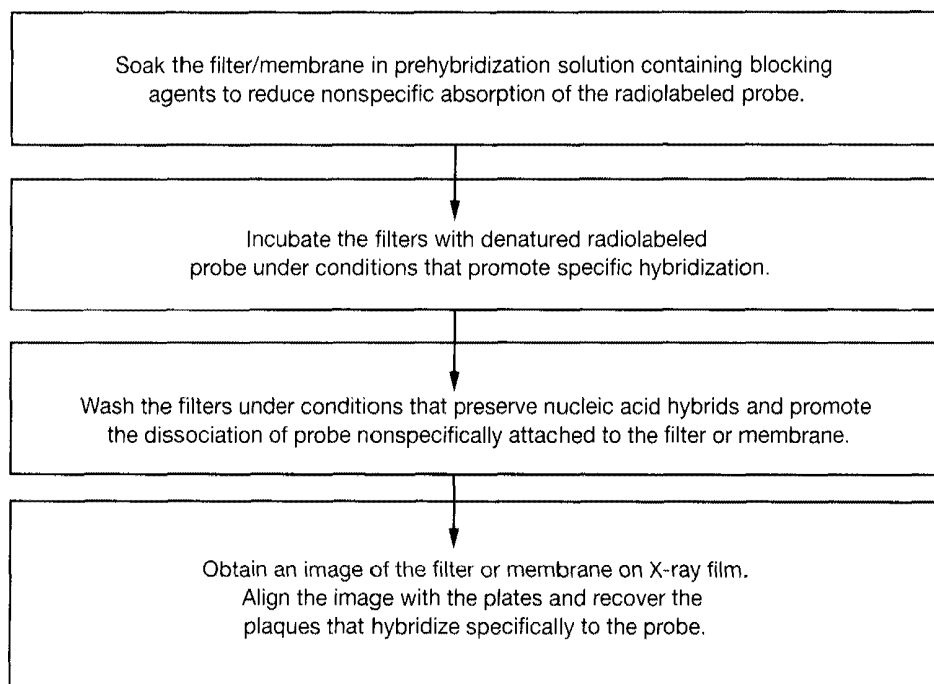
1. After removing the filters from the top agarose (Step 8), place them, DNA side up, on paper towels for 5–10 minutes.
2. When their edges begin to curl, place the filters in stacks of ten interleaved with circular Whatman 3MM papers. Place a few 3MM papers on the top and bottom of the stack.
3. Place the stacks on a small platform (e.g., an inverted Pyrex dish) in an autoclave. Expose the filters to "streaming steam" for 3 minutes (i.e., 100°C — avoid super-heated steam).
4. Transfer the stack of filter papers and nitrocellulose filters to a vacuum oven.
5. Bake for 2 hours at 80°C while drawing a vacuum continuously. Remove any 3MM paper that sticks to the nitrocellulose filters by soaking in 2x SSPE before prehybridizing.
6. Proceed to Step 14 of the protocol.

# Protocol 22

---

## Hybridization of Bacteriophage DNA on Filters

**F**ILTERS CARRYING IMMOBILIZED DNA FROM PLAQUES ARE SCREENED by hybridization in situ with  $^{32}\text{P}$ -labeled probes. The technique is extremely robust, highly specific, and very sensitive and allows the identification of a single recombinant among several thousand plaques. The plaque identified as hybridization-positive is then purified by subsequent rounds of screening. The overall sequence of events is presented in Figure 2-15. For further details on the hybridization of DNA immobilized on filters, please see Chapter 6, Protocol 10.



**FIGURE 2-15** Flowchart: Sequence of Hybridization Steps

## MATERIALS

**CAUTION:** Please see Appendix 12 for appropriate handling of materials marked with <!.>.

### Buffers and Solutions

Please see Appendix 1 for components of stock solutions, buffers, and reagents. Dilute stock solutions to the appropriate concentrations.

*Chloroform* <!.>

*Prehybridization solution* <!.>

Please see the panel on **PREHYBRIDIZATION AND HYBRIDIZATION SOLUTIONS** in Chapter 1, Protocol 32.

*SM*

*2x SSPE*

Depending on the number of filters to be processed, 1 liter or more may be required.

*Wash solution 1*

2x SSC

0.1% (w/v) SDS

*Wash solution 2*

1x SSC

0.1% (w/v) SDS

*Wash solution 3*

0.1x SSC

0.1% (w/v) SDS

### Nucleic Acids and Oligonucleotides

*Filters immobilized with bacteriophage DNA*

Prepared as described in Protocol 21 of this chapter.

*Radiolabeled probe* <!.>

Prepared as described in Chapter 9 or 10.

### Special Equipment

*Boiling water bath (for denaturing double-stranded probes)*

*Glass (Pyrex) baking dish or other hybridization chamber*

#### ALTERNATIVE HYBRIDIZATION CHAMBERS

Some investigators prefer to incubate filters in heat-sealable plastic bags (Sears Seal-A-Meal or equivalent) (e.g., please see Chapter 6, Protocol 10) during the prehybridization and hybridization steps, rather than in crystallization dishes. The former method avoids problems with evaporation and, because the sealed bags can be submerged in a water bath, ensures that the temperatures during hybridization and washing are correct. The bags must be opened and resealed when changing buffers. To avoid radioactive contamination of the water bath, the resealed bag containing radioactivity should be sealed inside a second, noncontaminated bag.

If only a small number of filters are subjected to hybridization, then use a glass screw-top bottle that fits the rollers of a hybridization oven in place of a crystallization dish or Seal-A-Meal bag. These bottles and ovens have the advantage that small volumes of hybridization solution can be used and the hybridization temperature can be accurately controlled.

*Glue stick, water-soluble (e.g., UHU Stic distributed by FaberCastell)*

*Incubation chamber preset at the appropriate hybridization temperature*

Please see Step 2.

*Radioactive ink* <!.>

Radioactive ink is made by mixing a small amount of <sup>32</sup>P with waterproof black drawing ink. We find it convenient to make the ink in three grades: very hot (>2000 cps on a hand-held minimonitor), hot (>500 cps on a hand-held minimonitor), and cool (>50 cps on a hand-held minimonitor). Use a fiber-

tip pen to apply ink of the desired hotness to the adhesive labels. Attach radioactive-warning tape to the pen, and store it in an appropriate place.

Reusable alternatives to radioactive ink are chemiluminescent markers available from Stratagene (Glogos). The markers can be used multiple times and should be exposed to fluorescent light just prior to a new round of autoradiography.

*Whatman 3MM paper*

## METHOD

1. If the filters are dry, float the baked or cross-linked filters on the surface of 2x SSPE until they have become thoroughly wetted from beneath. Submerge the filters for 5 minutes.

Make sure that no air bubbles are trapped under the filters. The filters should change from white to a bluish color as the aqueous solvent penetrates the pores of the filter. Make sure that there are no white spots or patches remaining on the filters before proceeding to Step 2.

2. Transfer the filters to a Pyrex dish or other hybridization chamber containing prehybridization solution. Use 3 ml of prehybridization solution per 82-mm filter or 5 ml per 132-mm filter. Incubate the filters with gentle agitation on a rocking platform for 1–2 hours or more at the appropriate temperature (i.e., 68°C when hybridization is to be carried out in aqueous solution; 42°C when hybridization is to be carried out in 50% formamide).

Whatever type of container is used, the important point is that the filters are completely covered by the prehybridization solution. During prehybridization, sites on the nitrocellulose filter that nonspecifically bind single- or double-stranded DNA become bound by proteins in the blocking solution. Agitation ensures that the filters are continuously bathed in and evenly coated by the prehybridization fluid.

Whether or not to use a prehybridization solution containing formamide is largely a matter of personal preference. Both versions of the recommended solutions give excellent results and neither has clear-cut advantages over the other. However, hybridization in 50% formamide at 42°C is less harsh on nitrocellulose filters than is hybridization at 68°C in aqueous solution. Offsetting this advantage is the two- to threefold slower rate of hybridization in solutions containing formamide. Nylon filters are impervious to the deleterious effects of aqueous hybridization at high temperatures.

3. Denature  $^{32}\text{P}$ -labeled double-stranded probes by heating for 5 minutes at 100°C. Chill the probe rapidly in ice water. Single-stranded probes need not be denatured.

Alternatively, the probe may be denatured by adding 0.1 volume of 3 N NaOH. After 5 minutes at room temperature, transfer the probe to ice water and add 0.1 volume of 1 M Tris-Cl (pH 7.2) and 0.1 volume of 2.5 N HCl. After denaturation, store the probes in ice water until needed. At low temperature, the rate of reassociation of DNA is extremely slow and essentially the probe remains in a single-stranded form.

Between  $2 \times 10^5$  and  $1 \times 10^6$  cpm of  $^{32}\text{P}$ -labeled probe (specific activity  $5 \times 10^7$  cpm/ $\mu\text{g}$ ) should be used per milliliter of hybridization solution. Using more probe causes the background of nonspecific hybridization to increase; using less reduces the rate of hybridization.

If radiolabeled oligonucleotides are used as probes in this step, please see Chapter 6, Protocol 10, or Chapter 10, Protocol 8 for hybridization and washing conditions.

### PURITY OF PROBES

It is essential that probes used to screen bacteriophage  $\lambda$  libraries contain no sequences that will hybridize to DNA sequences in the vector. Several bacteriophage  $\lambda$  vectors, such as  $\lambda\text{gt}11$ ,  $\lambda\text{ORF8}$ , lambda ZAP, and some of the  $\lambda$  Charon bacteriophages, contain the *E. coli lacZ* gene, either for immunochemical screening or as part of a plasmid integrated into the bacteriophage genome to assist with rescue of cloned sequences, or as part of the central stuffer fragment. Because DNA probes are often prepared from fragments of plasmids that contain all or part of the *lacZ* gene, even a small amount of contamination will cause the probe to hybridize indiscriminately to bacteriophage plaques. To ensure that a DNA fragment does not contain sequences that are complementary to the vector, we recommend (i) purifying the DNA successively through two gels (agarose or polyacrylamide) as described in Chapter 5, before carrying out the radiolabeling reaction, or (ii) preparing the probe by PCR amplification and purification (please see Chapter 8, Protocol 1).

4. Add the denatured probe to the prehybridization solution covering the filters. Incubate the filters for 12–16 hours at the appropriate temperature (please see Chapter 6, Protocol 10).

During hybridization, keep the containers holding the filters tightly closed to prevent the loss of fluid by evaporation.

To maximize the rate of annealing of the probe with its target, hybridizations are usually carried out in solutions of high ionic strength (6x SSC or 6x SSPE) at a temperature that is 20–25°C below the melting temperature (please see Chapter 1, Protocols 28–30 or Chapter 6, Protocol 10). Both SSPE and SSC work equally well when hybridization is carried out in aqueous solvents. However, when formamide is included in the hybridization buffer, 6x SSPE is preferred because of its greater buffering capacity. For a general discussion of the factors that affect the rate and specificity of hybridization of radioactive probes to nucleic acids immobilized on solid supports, please see Chapter 6, Protocol 10.

5. When the hybridization is completed, *quickly* remove filters from the hybridization solution and *immediately* immerse them in a large volume (300–500 ml) of Wash solution 1 at room temperature. Agitate the filters gently, turning them over at least once during washing. After 5 minutes, transfer the filters to a fresh batch of wash solution and continue to agitate them gently. Repeat the washing procedure twice more.

At no stage during the washing procedure should the filters be allowed to dry or to stick together.

Only a small fraction of the probe forms specific hybrids with the target sequences immobilized on the filters. Therefore, hybridization solutions may be recovered, stored, and reused for a second round of hybridization. However, the intensity of the signal obtained from recycled hybridization solution may be reduced for a variety of reasons: the reduced specific activity of the probe due to radioactive decay, degradation of the probe during incubation, and renaturation of double-stranded probe during the first hybridization step.

6. Wash the filters twice for 1–1.5 hours in 300–500 ml of Wash solution 2 at 68°C.

With experience, it is possible to use a hand-held monitor to test whether washing is complete. If the background is still too high or if the experiment demands washing at high stringencies, immerse the filters for 60 minutes in 300–500 ml of Wash solution 3 at 68°C.

7. Dry the filters in the air at room temperature on sheets of Whatman 3MM paper or stacks of paper towels. Streak the underside of the filters with a water-soluble glue stick and arrange the filters (numbered side up) on a clean, dry, flat sheet of 3MM paper. Firmly press the filters against the 3MM paper to ensure that they do not move. Apply adhesive labels marked with radioactive ink or chemiluminescent markers to several asymmetric locations on the 3MM paper. These markers serve to align the autoradiograph with the filters. Cover the filters and labels with Saran Wrap/Cling Film. Use tape to secure the wrap to the back of the 3MM paper and stretch the wrap over the paper to remove wrinkles.
8. Expose the filters to X-ray film (Kodak XAR-2, XAR-5, or their equivalent) for 12–16 hours at –70°C with an intensifying screen.
9. Develop the film and align it with the filters using the marks left by the radioactive ink or fluorescent marker. Use a nonradioactive red fiber-tip pen to mark the film with the positions of the asymmetrically located dots on the numbered filters.
10. Identify the positive plaques by aligning the orientation marks with those on the agar plate.

When duplicate sets of filters are hybridized to the same probe, there is less chance of confusing a background smudge with a positive plaque. Pick only those plaques that yield convincing hybridization signals on both sets of filters for further analysis. When screening a genomic library for a single-copy gene, expect to find no more than one positive clone per  $10^5$  plaques screened. When screening cDNA libraries, the number of positives depends on the abundance of the mRNA of interest.

Filters glued to 3MM paper are readily removed in preparation for stripping (please see Chapter 6, Protocol 10) by placing the 3MM paper with attached membranes in a tub of 2x SSC. The water-soluble glue dissolves in this solution, releasing the filters for transfer to a stripping solution and a round of hybridization to another probe, if desired.

11. Pick each positive plaque as described in Protocol 2 and store in 1 ml of SM containing a drop (50  $\mu$ l) of chloroform.

If the alignment of the filters with the plate does not permit identification of an individual hybridizing plaque, an agar plug containing several plaques in the area of interest should be cored using the large end of a sterile Pasteur pipette. Use a fresh pipette to core each hybridization-positive area.

12. To purify a hybridization-positive plaque, plate an aliquot (usually 50  $\mu$ l of a  $10^{-2}$  dilution) of the bacteriophages that are recovered from the cored agar plug and proceed with subsequent rounds of screening by hybridization.

Ideally, in a second round plating, there should be ~300 plaques on a 100-mm plate. These plaques are then screened a second time by hybridization. Pick a single, well-isolated positive plaque from the secondary screen and subject it to additional rounds of screening until the stock is genetically pure and every plaque hybridizes to the probe of interest. Use a plaque derived from the final round of screening to make a stock as described in Protocol 3 or 4.

# Protocol 23

---

## Rapid Analysis of Bacteriophage $\lambda$ Isolates: Purification of $\lambda$ DNA from Plate Lysates

**A**NALYSIS OF PROMISING GENOMIC OR CDNA CLONES often begins by digesting minipreparations of bacteriophage  $\lambda$  DNA with restriction enzymes and analyzing the products of digestion by agarose gel electrophoresis. The two methods presented here and in Protocol 24 are for the rapid preparation of small amounts of bacteriophage  $\lambda$  DNA that are suitable for use as substrates for restriction enzymes, as templates for RNA synthesis with DNA-dependent RNA polymerases encoded by bacteriophages SP6, T3, and T7, and as templates in the PCR.

This protocol (Xu 1986) is designed for use with bacteriophages prepared from plate lysates, whereas Protocol 24 is more suitable for bacteriophages grown in liquid cultures (Leder et al. 1977). Several other approaches are summarized in the panel on **ALTERNATIVE PURIFICATION METHODS** at the end of this protocol.

The clones also may be analyzed simply and directly as described in the panel on **ANALYSIS OF CLONES USING PCR** at the end of this protocol. In later chapters, we discuss additional methods that can be used to analyze inserts cloned in bacteriophage  $\lambda$  recombinants.

- Vectors such as  $\lambda$ ZAP and  $\lambda$ ZipLox have been designed to allow inserts to be recovered and analyzed as plasmids (for details, please see the introduction to Chapter 11). This method works best with small inserts ( $\leq 8$  kb) and is chiefly of benefit when recovering cloned cDNA from bacteriophage  $\lambda$  recombinants.
- Small inserts also can be recovered by using specially designed thermostable DNA polymerases to catalyze long-range PCR (for details, please see Chapter 8, Protocol 13).

This method is derived from that described by Xu (1986) and was provided by Diane Jelinek and Daphne Davis (University of Texas Southwestern Medical Center, Dallas).



## MATERIALS

---

**CAUTION:** Please see Appendix 12 for appropriate handling of materials marked with <!.>.

### Buffers and Solutions

Please see Appendix 1 for components of stock solutions, buffers, and reagents. Dilute stock solutions to the appropriate concentrations.

*Chloroform* <!.>

*Ethanol*

*High-salt buffer*

20 mM Tris-Cl (pH 7.4)

1.0 M NaCl

1 mM EDTA (pH 8.0)

*Isopropanol*

*Low-salt buffer*

20 mM Tris-Cl (pH 7.4)

0.2 M NaCl

1 mM EDTA (pH 8.0)

*Phenol:chloroform (1:1, v/v)* <!.>

*SM*

*TE (pH 8.0)*

*TM*

### Media

*LB or NZCYM agarose plates*

Freshly poured plates (150-mm diameter) that have been equilibrated to room temperature give the best results in this method. Agarose is preferred to agar in order to minimize contaminants that can interfere with enzymatic analysis of DNA prepared from plate lysates of bacteriophage  $\lambda$  DNA.

*LB or NZCYM top agarose*

For details on using top agarose, please see Protocol 1 of this chapter. Agarose is preferred to agar in this protocol in order to minimize contamination with inhibitors that can interfere with subsequent enzymatic analysis of bacteriophage.

### Centrifuges and Rotors

*Sorvall SS-34 rotor or equivalent*

### Special Equipment

*Borosilicate Pasteur pipette*

*Elutip-d columns (Schleicher & Schuell)*

*Water bath or heating block preset to 47°C*

*Whatman DE52*

DE52 is a preparation of DEAE-cellulose, an anion-exchange resin, that is used in this protocol to remove host DNA and RNA from plate or liquid lysates. A preswollen version of DE52 is available from Whatman and works exceedingly well in this protocol. For each 150-mm plate lysate to be purified, 10 ml of a 2:1 slurry of DE52 in LB medium is required.

### Vectors and Bacterial Strains

*Bacteriophage  $\lambda$ , recombinant, grown as single well-isolated plaques on a lawn of bacteria*

Prepared as described in Protocol 1 of this chapter.

*E. coli plating bacteria*

Prepared as described in Protocol 1 of this chapter.

## METHOD

---

### Preparation of Lysates

1. Use a borosilicate Pasteur pipette to pick 8–10 well-isolated bacteriophage plaques from a plate derived from a genetically pure, plaque-purified bacteriophage stock. Place the plaques in 1 ml of SM and 50  $\mu$ l of chloroform. Store the suspension for 4–6 hours at 4°C to allow the bacteriophage particles to diffuse from the top agarose.
2. In a small, sterile culture tube, mix 50–100  $\mu$ l of the bacteriophage suspension ( $\sim 10^3$  pfu) with 150  $\mu$ l of plating bacteria. Incubate the infected culture for 20 minutes at 37°C. Add 7.0 ml of molten (47°C) top agarose (0.7%), and spread the bacterial suspension on the surface of a freshly poured 150-mm plate containing NZCYM agarose.
3. Incubate the inverted plate at 37°C until the plaques cover almost the entire surface of the plate (7–9 hours).

Do not incubate the plates for too long, otherwise confluent lysis will occur, which reduces the yield of bacteriophage DNA.
4. Add 7 ml of TM directly onto the surface of the top agarose. Allow the bacteriophage particles to elute during 4 hours of incubation at 4°C with constant, gentle shaking.
5. Transfer the bacteriophage  $\lambda$  eluate to a centrifuge tube, and remove the bacterial debris by centrifugation at 4000g (58,000 rpm in a Sorvall SS-34 rotor) for 10 minutes at 4°C. A small aliquot of cleared lysate can be set aside at this step as a bacteriophage stock solution. Store the stock at 4°C over a small volume of chloroform.
6. Dispense 10 ml of a 2:1 slurry of DE52 resin into a centrifuge tube and sediment the resin by centrifugation at 500g (2000 rpm in a Sorvall SS-34 rotor) for 5 minutes at room temperature. Remove the supernatant from the resin pellet and place the centrifuge tube on ice.
7. Resuspend the DE52 in the cleared TM and allow the bacteriophage particles to absorb to the resin by rocking the centrifuge tube for 3 minutes at room temperature.
8. Centrifuge the TM/DE52 slurry at 4000g (5800 rpm in a Sorvall SS-34 rotor) for 5 minutes. Carefully transfer the supernatant to a fresh centrifuge tube and repeat the centrifugation step. Discard the pellet after each centrifugation.
9. Transfer the supernatant from the second centrifugation to a fresh centrifuge tube. Extract the supernatant, which contains the bacteriophage  $\lambda$  particles, once with phenol:chloroform.
10. Transfer the aqueous phase, which contains the bacteriophage  $\lambda$  DNA, to a fresh polypropylene tube and add an equal volume of isopropanol. Store the mixture for 10 minutes at  $-70^\circ\text{C}$ .
11. Collect the precipitated bacteriophage DNA by centrifugation at 16,500g (12,000 rpm in a Sorvall SS-34 rotor) for 20 minutes at 4°C.
12. Drain the isopropanol from the centrifuge tube and allow the pellet of DNA to dry in air.
13. Redissolve the DNA pellet in 2 ml of low-salt buffer.

14. Purify the bacteriophage DNA by chromatography on an Elutip-d column:
  - a. Use a syringe to push 1–2 ml of high-salt buffer through the Elutip-d column.
  - b. Push 5 ml of low-salt buffer through the column.
  - c. Attach the 0.45- $\mu$ m prefilter to the column and slowly push the DNA sample (Step 13) through the column.
  - d. Rinse the column with 2–3 ml of low-salt buffer.
  - e. Remove the prefilter and elute the DNA with 0.4 ml of high-salt buffer. Collect the eluate at this step in a 1.5-ml microfuge tube.
15. Add 1 ml of ethanol to the solution of eluted DNA, invert the tube several times, and incubate the mixture on ice for 20 minutes. Collect the precipitated DNA by centrifugation in a microfuge, discard the supernatant, and rinse the pellet of DNA with 0.5 ml of 70% ethanol. Discard the supernatant and allow the pellet of DNA to dry in the air. Dissolve the pellet of DNA in 50  $\mu$ l of TE (pH 8.0).

Resuspend the DNA by tapping on the side of the tube. Try to avoid vortexing. If the DNA proves difficult to dissolve, incubate the tube for 15 minutes at 50°C.

If minipreparations are working well, expect to isolate ~5  $\mu$ g of purified bacteriophage DNA from  $5 \times 10^{10}$  infectious particles. It is possible to estimate the quantity of bacteriophage DNA present in a plate lysate or liquid culture lysate by direct agarose gel electrophoresis (please see Protocol 7).

For restriction analysis and agarose gel electrophoresis, digest a 5–10- $\mu$ l aliquot of the resuspended DNA. If the DNAs are resistant to cleavage, treat them according to the method described on the following page in **ADDITIONAL PROTOCOL: REMOVING POLYSACCHARIDES BY PRECIPITATION WITH CTAB**.

#### ALTERNATIVE PURIFICATION METHODS

Hundreds of different methods are described in the literature to prepare small amounts of bacteriophage  $\lambda$  DNA from plate lysates or liquid cultures. Most of these are minor variations or elaborations of the basic techniques described in this protocol. The two problems that arise most frequently are poor yields of DNA and an inability to cleave the DNA with restriction enzymes. As discussed, the first of these problems is best solved by experimenting with the ratios of bacteriophage to host cells when setting up the plate lysates or liquid cultures. The second, which is more commonly encountered with plate lysates rather than liquid cultures, is often caused by polysaccharide inhibitors derived from the host bacteria and/or the agar. This problem can sometimes be solved by using agarose or agar from a different manufacturer or by substituting agarose for agar in the medium used to pour the plates. If the problem persists, the best course of action is to use a more elaborate scheme to purify the bacteriophage particles and the bacteriophage DNA. For example:

- Manfioletti and Schneider (1988) describe a variation of the above methods in which DEAE cellulose or triethylaminoethyl cellulose is first used to remove polyanions from the lysate. Proteinase K and EDTA are then used to release the DNA from the virus particles, and finally, the bacteriophage DNA is precipitated with hexadecyltrimethyl ammonium bromide (CTAB).
- The protonated form of DE52 can also be used as a chromatography resin to purify bacteriophage  $\lambda$  particles from liquid cultures or plate lysates (Helms et al. 1985, 1987). The negatively charged virus particles bind to the resin in low concentrations of  $Mg^{2+}$  and are eluted in buffers containing high concentrations of  $Mg^{2+}$ . The viral DNA is extracted by digesting the bacteriophage particles with proteinase K in the presence of a detergent such as SDS. The DNA is then precipitated with isopropanol.
- Several companies sell kits to prepare bacteriophage DNA from plate or liquid lysates. The Wizard kit marketed by Promega is fairly typical and involves digesting the lysate with nuclease to remove contaminating bacterial DNA and RNA, precipitating the bacteriophage particles from the supernatant with PEG or a resin, and finally purifying the viral DNA on another resin. These kits work well if the manufacturers' instructions are followed to the letter. However, like all commercial products, they are expensive and are therefore best used as a last resort if other methods fail.

**ANALYSIS OF CLONES USING PCR**

A simple approach to analyze cDNA clones is to use PCR to amplify the insert (please see Chapter 8, Protocol 12).

If the oligonucleotide primers are well-designed, the amplified DNA can be digested with a restriction enzyme and ligated into a plasmid vector, or it can be cloned directly without restriction (please see Chapter 8, Protocol 5). With longer cDNA clones and genomic DNA inserts, three strategies should be considered. The first is to use a version of long PCR (Barnes 1994) to amplify the insert before analysis or subcloning (Chapter 8, Protocol 13). The second is to rescue the insert as a phagemid DNA (Short et al. 1988). This option requires that a bacteriophage vector with an integrated phagemid genome (e.g., Stratagene's  $\lambda$ ZAP or BRL's ZipLox vectors) be used in the construction of the original library. A third strategy is to digest the recombinant bacteriophage DNA with a restriction enzyme to release the foreign DNA from the  $\lambda$  arms and then to subclone the insert directly into a plasmid vector. In general, no purification of the restriction digest is required prior to ligation, since vector arm-plasmid ligation products are poor candidates for transformation of bacteria. When setting up the ligation reactions, aim for an equimolar molar ratio of insert to plasmid vector and use a high-frequency transformation protocol (please see Chapter 1) to introduce the DNA into *E. coli*. For large genomic DNA inserts of 15–20 kb, it is often necessary to screen colonies of transformed bacteria by hybridization, as the background of empty colonies can be high. Once the cDNA or genomic DNA insert is cloned into a high-copy-number plasmid vector, much larger quantities of DNA can be prepared for detailed restriction mapping, exon hunting, and DNA sequence analysis.

**ADDITIONAL PROTOCOL: REMOVING POLYSACCHARIDES BY PRECIPITATION WITH CTAB**

If the bacteriophage DNA preparations obtained in Protocols 23 and 24 are resistant to cleavage by restriction enzymes, the DNA can be purified further by precipitation with the cationic detergent hexadecyltrimethyl ammonium bromide (CTAB). This procedure efficiently removes polysaccharides, which are frequently the cause of the problem.

**Additional Materials**

**CAUTION:** Please see Appendix 12 for appropriate handling of materials marked with <!>.

*Bacteriophage DNA*

Prepared as described in Protocol 23 or 24 of this chapter.

*Chloroform:isoamyl alcohol (24:1, v/v)* <!>

*CTAB (10% v/v) in 0.7 M NaCl* <!>

Dissolve 4.1 g of NaCl in 80 ml of H<sub>2</sub>O and slowly add 10 g of CTAB while heating the solution to 55°C and stirring. Adjust the final volume to 100 ml, and store above 15°C to prevent CTAB from precipitating.

CTAB, also known as cetrimide, is available from Sigma. Please see the information panel on CTAB in Chapter 6.

*NaCl (5 M)*

*TE (pH 7.6)*

*Water bath preset to 68°C*

**Method**

1. Precipitate the bacteriophage DNA with ethanol and dissolve it in 300  $\mu$ l of TE (pH 7.6).  
Resuspend the DNA by tapping on the side of the tube. Try to avoid vortexing. If the DNA proves difficult to dissolve, incubate the tube for 15 minutes at 50°C.
2. To the bacteriophage DNA pellet, add 50  $\mu$ l of 5 M NaCl, followed by 40  $\mu$ l of CTAB/NaCl solution. Incubate the DNA/CTAB/NaCl solution for 10 minutes at 68°C.
3. Purify the bacteriophage DNA by extraction with chloroform:isoamyl alcohol, and then centrifuge the emulsion for 3 minutes in a microfuge to separate the phases.
4. Transfer the (upper) aqueous phase to a fresh tube, and extract with phenol:chloroform.
5. Centrifuge the emulsion for 3 minutes in a microfuge to separate the phases.
6. Transfer the (upper) aqueous phase to a fresh tube, and precipitate the bacteriophage DNA with isopropanol at room temperature.
7. Resuspend the pellet of DNA in 100  $\mu$ l of TE (pH 8.0).  
Resuspend the DNA by tapping on the side of the tube. Try to avoid vortexing. If the DNA proves difficult to dissolve, incubate the tube for 15 minutes at 50°C.

# Protocol 24

---

## Rapid Analysis of Bacteriophage $\lambda$ Isolates: Purification of $\lambda$ DNA from Liquid Cultures

**B**ACTERIOPHAGE  $\lambda$  DNA MAY BE PURIFIED EASILY FROM BACTERIOPHAGE grown in liquid cultures as described here. The preceding protocol presented a method for purifying bacteriophage  $\lambda$  DNA from plate lysates. In general, bacteriophage  $\lambda$  does not grow as well in small liquid cultures as in plate lysates. The following method should therefore be used only with robust strains of the bacteriophage, such as  $\lambda$ gt10,  $\lambda$ gt11,  $\lambda$ ZAP, or ZipLox recombinants. For analyzing clones using PCR, please see the panel on **ANALYSIS OF CLONES USING PCR** in Protocol 23.

---

### MATERIALS

---

**CAUTION:** Please see Appendix 12 for appropriate handling of materials marked with <!.>.

#### Buffers and Solutions

Please see Appendix 1 for components of stock solutions, buffers, and reagents. Dilute stock solutions to the appropriate concentrations.

*Chloroform* <!.>

*Ethanol*

*High-salt buffer*

20 mM Tris-Cl (pH 7.4)

1.0 M NaCl

1 mM EDTA (pH 8.0)

*Isopropanol*

*Low-salt buffer*

20 mM Tris-Cl (pH 7.4)

0.2 M NaCl

1 mM EDTA (pH 8.0)

*Phenol:chloroform (1:1, v/v)* <!.>

*SM*

*TE (pH 8.0)*

#### Media

*NZCYM medium*

## Centrifuges and Rotors

*Sorvall SS-34 rotor or equivalent*

## Special Equipment

*Borosilicate Pasteur pipette*

*Elutip-d columns (Schleicher & Schuell)*

*Water bath or heating block preset to 47°C*

*Whatman DE52*

DE52 is a preparation of DEAE-cellulose, an anion-exchange resin, that is used in this protocol to remove host DNA and RNA from plate or liquid lysates. A preswollen version of DE52 is available from Whatman and works exceedingly well in this protocol. For each 150-mm plate lysate to be purified, 10 ml of a 2:1 slurry of DE52 in LB medium is required.

## Vectors and Bacterial Strains

*Bacteriophage recombinant, grown as single well-isolated plaques on a lawn of bacteria*

Prepared as described in Protocol 1 of this chapter.

*E. coli strain, grown as well-isolated, single colonies on an agar plate*

Inoculate a single colony of an appropriate *E. coli* strain into 25 ml of NZCYM medium and incubate overnight at 30°C. Measure the OD<sub>600</sub> of the overnight culture and calculate the number of cells/ml using the conversion factor: 1 OD<sub>600</sub> = 1 × 10<sup>9</sup> cells/ml.

Growth at 30°C increases the chance that the cells will not have reached saturation during the overnight growth period. The amount of cell debris in the medium is therefore kept to a minimum. Bacteriophages added to a saturated culture can attach to the MalB protein present on cellular debris, leading to a non-productive infection.

## METHOD

1. Use a borosilicate Pasteur pipette to pick a single well-isolated bacteriophage plaque into 1 ml of SM containing a drop of chloroform in a small sterile polypropylene tube. Store the suspension for 4–6 hours at 4°C to allow the bacteriophage particles to diffuse from the top agarose.
2. In a 25-ml tube, mix 0.5 ml of the bacteriophage suspension ( $\sim 3 \times 10^6$  bacteriophages) with 0.1 ml of an overnight culture of bacteria. Incubate the culture for 15 minutes at 37°C.  
The yield of bacteriophage particles (and hence DNA) is greatly affected by the absolute amounts and relative amounts of bacteriophages and bacterial cells in the inoculum for the liquid lysate. When using an unfamiliar strain of *E. coli*, bacteriophage  $\lambda$  vector, or recombinant, it is best to set up a series of cultures containing different ratios of bacteria and bacteriophages. Prepare bacteriophage  $\lambda$  DNA from each of the resulting liquid lysates.
3. Add 4 ml of NZCYM medium, and incubate the culture for  $\sim 9$  hours at 37°C with vigorous agitation.  
The culture should clear, but very little debris should be evident.

If lysis does not occur or is incomplete, add an equal volume of prewarmed NZCYM medium to the cultures and continue incubation for a further 2–3 hours at 37°C with vigorous agitation. This step will occasionally drive the culture to complete lysis (and produce a higher yield of bacteriophage DNA).

Problems sometimes arise because minipreparations of bacteriophage DNA are contaminated by bacterial DNA or RNA. In this case, digest the culture lysate with DNase I before batch chromatography on DE52. To include this step, add crude pancreatic DNase I (please see Protocol 6) to a final concentration of 10 ng/ml before starting Step 4, and incubate the lysate for 30 minutes at 37°C. Thereafter, continue with the remainder of the protocol. DNase treatment decreases the viscosity of the lysate and may enhance removal of *E. coli* genomic DNA and RNA by DEAE-cellulose chromatography.

4. Add 0.1 ml of chloroform to the culture and continue incubation for a further 15 minutes at 37°C with vigorous agitation. Transfer the lysate to a 5-ml polypropylene centrifuge tube. Centrifuge at 800g (2600 rpm in a Sorvall SS-34 rotor) for 10 minutes at 4°C.
5. Transfer the supernatant to a fresh tube, and remove the bacterial debris by centrifugation at 4000g (5800 rpm in a Sorvall SS-34 rotor) for 10 minutes at 4°C. A small aliquot of cleared lysate can be set aside at this step as a bacteriophage stock solution. Store the stock at 4°C over chloroform.
6. Dispense 10 ml of a 2:1 slurry of DE52 resin into a fresh centrifuge tube and sediment the resin by centrifugation at 500g (2000 rpm in a Sorvall SS-34 rotor) for 5 minutes at room temperature. Remove the supernatant from the resin pellet and place the centrifuge tube on ice.
7. Resuspend the DE52 in the cleared bacteriophage  $\lambda$  supernatant and allow the bacteriophage particles to absorb to the resin by rocking the centrifuge tube for 3 minutes at room temperature.
8. Centrifuge the bacteriophage  $\lambda$  supernatant/DE52 slurry at 4000g (5800 rpm in a Sorvall SS-34 rotor) for 5 minutes. Carefully transfer the supernatant to a fresh centrifuge tube and repeat the centrifugation step. Discard the pellet after each centrifugation.
9. Transfer the supernatant from the second centrifugation to a fresh centrifuge tube. Extract the supernatant, which contains the bacteriophage  $\lambda$  particles, once with phenol:chloroform.
10. Transfer the aqueous phase, which contains the bacteriophage  $\lambda$  DNA, to a fresh polypropylene tube and add an equal volume of isopropanol. Store the mixture for 10 minutes at -70°C.
11. Collect the precipitated bacteriophage DNA by centrifugation at 16,500g (12,000 rpm in a Sorvall SS-34 rotor) for 20 minutes at 4°C.
12. Drain the isopropanol from the centrifuge tube and allow the pellet of DNA to dry in the air.
13. Dissolve the DNA pellet in 2 ml of low-salt buffer.
14. Purify the bacteriophage DNA by chromatography on an Elutip-d column as described in Protocol 23.
15. Mix 1 ml of ethanol with the solution of eluted DNA and incubate the mixture on ice for 20 minutes. Collect the precipitated DNA by centrifugation in a microfuge, discard the supernatant, and rinse the pellet of DNA with 0.5 ml of 70% ethanol. Discard the supernatant and allow the ethanol to evaporate. Dissolve the damp pellet of DNA in 50  $\mu$ l of TE (pH 8.0).

Resuspend the DNA by tapping on the side of the tube. Try to avoid vortexing. If the DNA proves difficult to dissolve, incubate the tube for 15 minutes at 50°C.

If minipreparations are working well, expect to isolate ~5  $\mu$ g of purified bacteriophage DNA from  $5 \times 10^{10}$  infectious particles. It is possible to estimate the quantity of bacteriophage DNA present in a plate lysate or liquid culture lysate by direct agarose gel electrophoresis (please see Protocol 7).

For restriction analysis and agarose gel electrophoresis, digest a 5–10- $\mu$ l aliquot of the resuspended DNA. If resistant to cleavage, treat the DNA samples according to the method described in **ADDITIONAL PROTOCOL: REMOVING POLYSACCHARIDES BY PRECIPITATION WITH CTAB** in Protocol 23.

---

**BACTERIOPHAGES: HISTORICAL PERSPECTIVE**

---

In 1909, Frederick William Twort was made Director of the Brown Animal Sanitary Institution in London, which had been set up ~40 years before as a hospital "for the care and treatment of Quadrupeds and Birds useful to Man." Twort, who had been trained as a microbiologist, had one scientific idea that he pursued all of his life — that pathogenic bacteria needed an "Essential Substance" for growth and vitality. Each organism required a different nutrient substance that was normally provided by the infected host. This was an important idea at the time, opening up an entire field of the nutritional requirements of bacteria and leading to the development of vaccines for pathogenic organisms that previously had been impossible to culture. In 1914, Twort set out to identify the elusive substance that would allow vaccinia virus to grow *in vitro*. At that time, smallpox vaccines were prepared in the skin of calves and were almost always contaminated with *Staphylococcus*. Twort wondered whether the contaminating bacteria might be the source of the essential substance for vaccinia. He plated the smallpox vaccine on nutrient agar slants and obtained large bacterial colonies of several colors. In addition, with the aid of a hand lens, he saw minute glassy areas that failed to grow when subcultured. He quickly realized that these were not degenerative changes but rather were the end stages of an acute infectious disease that destroyed the bacterial cells and could be artificially transmitted from one staphylococcal colony to another. In a publication in the *Lancet* in 1915, he called the contagion the Bacteriolytic Agent. Additional experiments proved that the agent could pass through porcelain filters and required bacteria for growth. Twort seems to have flirted with the idea that the Bacteriolytic Agent was vaccinia that invaded the bacteria in search of the Essential Substance.

Twort, like others, became interested in the possibility of using bacteriolytic agents to cure bacterial diseases of humans and animals. When this approach proved to be unsuccessful, Twort retreated to his original idea — that bacteriolytic agents required an additional factor of an exceptional nature to satisfy their fundamental physiological needs. However, his search for a substance that would allow viruses to grow apart from other forms of life was fruitless and his later research became decreasingly rational as he struggled to prove that bacteria evolved from viruses. Financial support for Twort's work had dwindled to almost nothing when, in 1944, the Brown Institution was destroyed by a bomb. This gave the University of London a long-sought opportunity to deprive Twort of his post and research facilities. He retired to live at Camberley, in a house appropriately called "The Wilderness."

In 1949, Twort wrote an embittered account of his experiences. By then, his work was largely forgotten and even the name Bacteriolytic Agent had been discarded in favor of Bacteriophage. By then, too, the physical nature of bacteriophages was understood: Their structures had been analyzed by electron microscopy, and quantitative assays of infectivity had been established. The ability to infect bacteria synchronously in a single-step growth experiment had opened the way to biochemical analysis of bacteriophage replication. The first bacteriophage mutants had been isolated, and genetic recombination had been demonstrated (Cairns et al. 1992). Finally, the ready emergence of bacterial mutants that were resistant to bacteriophage infection provided a rational explanation for the failure of bacteriophages as therapeutic agents. All this seems to have passed Twort by. He died in 1950, unaware of the impact of his early discovery and with his belief in an Essential Substance intact.

In 1917, two years after Twort's original publication, a French-Canadian, Felix D'Herelle, presented a paper to the Académie des Sciences on a microorganism (Le Bactériophage) that could kill dysentery bacilli. Whether D'Herelle was aware of Twort's work has been a matter of speculation. D'Herelle vigorously denied knowledge of Twort's earlier discovery and made persistent attempts to claim priority for himself. For many years, therefore, lysis of bacteria by phages was diplomatically known as the Twort-D'Herelle phenomenon. D'Herelle was a more incisive thinker than Twort and quickly recognized that bacteriophages behaved as infectious particles that could be titrated by plaque formation. He went on to describe a three-step process for the life history of the bacteriophage (attachment, multiplication, and release) that is remarkably accurate and perceptive (D'Herelle 1926). However, like Twort, D'Herelle became fascinated by the idea that bacteriophages could be used to cure bacterial infections and over the years collected a large amount of anecdotal data in support of this idea. Unlike Twort, D'Herelle tended to discount facts that were inconvenient and to the end remained a flamboyant proselytizer of an idea that even Twort had long since abandoned.

For a more detailed account of D'Herelle's discovery of bacteriophages, written with the benefit of hindsight, please see D'Herelle (1949).



---

## MINIMIZING DAMAGE TO LARGE DNA MOLECULES

---

Long molecules of high-molecular-weight DNA (>100 kb) are easily broken by shearing forces. Conventional methods of extracting and concentrating DNA, which include extraction with organic solvents and precipitation with ethanol or butanol, typically yield molecules smaller than 100 kb in size. Even linear DNA molecules as short as 50 kb — the size of the bacteriophage  $\lambda$  genome — can be broken by excessively rapid and prolonged pipetting and vigorous shaking.

Linear double-stranded DNA behaves in solution as a random coil that is stiffened by (1) stacking interactions between bases and (2) electrostatic repulsion between the regularly spaced negatively charged phosphates in the backbone. The rigidity of long DNA molecules leaves them vulnerable to shearing forces that cause double-stranded breaks, which occur most often in the center of the extended molecules. Velocity gradients strong enough to shear DNA are generated when solutions are agitated by vortexing or shaking, when solutions are drawn into or expelled from pipettes, or when long molecules of DNA are dissolved after precipitation by alcohols.

One way to minimize damage to DNA during transfer is simply to pour the solution from one container to another. However, this is not always feasible and is a risky business at the best of times. Solutions of high-molecular-weight DNA are viscous and tend to flow in one great lump rather than in a smooth controllable stream.

Wide-bore pipettes offer a safer method. These pipettes can be purchased commercially or fashioned as needed in the laboratory by cutting the tips from disposable plastic pipettes, blue pipette tips, or Pasteur pipettes. However, the small amount of negative pressure provided by rubber bulbs or a manual pipetting device may not be sufficient to retain extremely viscous solutions of DNA in the pipette. Electrically driven automatic pipettes (such as PipetteAids) are, therefore, preferred. The following are additional ways to minimize shearing.

- Stir rather than shake DNA solutions.
- Maintain a high DNA concentration.
- Use a buffer of high ionic strength to thereby reduce the electrostatic forces that confer stiffness upon large DNA molecules.
- Add condensing agents such as spermine or polylysine.
- Isolate and manipulate DNA inside agarose blocks (please see Chapter 5, Protocol 15). This method is not required when preparing genomic DNA for cloning in cosmids or bacteriophage  $\lambda$  vectors. However, it is the method of choice when preparing high-molecular-weight DNA for cloning in bacteriophage P1 vectors or when constructing bacterial and yeast artificial chromosomes.

---

## IN VITRO PACKAGING

---

Packaging of bacteriophage  $\lambda$  DNA in vitro was initially developed by Becker and Gold (1975) using mixtures of extracts prepared from bacteria infected with strains of bacteriophage  $\lambda$  carrying mutations in genes required for the assembly of bacteriophage particles. The procedure has been modified and improved to the point where  $2 \times 10^9$  pfu can be generated routinely in packaging reactions containing 1.0  $\mu\text{g}$  of intact bacteriophage  $\lambda$  DNA. This high efficiency of packaging, coupled with the development of a large stable of bacteriophage  $\lambda$  vectors and the ability to screen libraries by hybridization or immunochemical methods, led to the dominance of these vectors in cDNA library construction in the 1980s. The increased use of bacteriophage  $\lambda$  as a cloning vector also led to the development of commercial packaging reactions. Today, the preparation of packaging reactions as described in the Second Edition of this manual is almost a lost art, even in the laboratories of experienced bacteriophage workers. Commercial packaging reactions work exceedingly well and are so reasonably priced that they have replaced homemade extracts in most routine cloning tasks. However, for specialized applications such as the construction of linking and jumping genomic DNA libraries (which use huge numbers of packaging reactions), it is worth taking the time to prepare

home-brewed packaging extracts (Poustka 1993). Packaging extracts are prepared by one of two general strategies:

1. Expression of bacteriophage  $\lambda$  genes is induced in two separate lysogens that provide complementing components of the packaging reaction (e.g., please see Scalenghe et al. 1981). As a consequence of mutations in the prophage genomes, neither lysogen alone is capable of packaging exogenously added bacteriophage DNA. Extracts of each culture are prepared separately and blended at the bench into a mixture that contains all of the components necessary for packaging. The resulting packaging mixtures are efficient, typically yielding in excess of  $10^9$  pfu/ $\mu$ g of bacteriophage  $\lambda$  DNA, and essentially free from background (when assayed on appropriate hosts strains). Examples of commercially available, two-component systems are Gigapack II Gold (Stratagene) and the  $\lambda$  packaging system available from Life Technologies.
2. A single *E. coli* C bacteriophage  $\lambda$  lysogen is used to prepare an extract that contains all of the components necessary to package exogenously added viral DNA (Rosenberg 1987). One lysogen can be used to prepare packaging extracts for two reasons. First, the prophage carried in the lysogenic strain codes for all of the proteins needed for packaging. Second, the *cos* site of the prophage has been deleted. These features work together in the following manner. Induction of the lysogen results in the intracellular accumulation of all protein components needed for packaging, and complete preheads are formed. However, the next steps in the packaging process are the recognition of the *cos* sites on concatenated bacteriophage  $\lambda$  DNA by the bacteriophage A protein and the insertion of the bacteriophage  $\lambda$  genome into the prehead. The lack of the *cos* site in the prophage DNA prevents this step from occurring, and packaging is thus effectively halted at the prehead stage, even though all of the necessary components used later in the process are present. However, exogenous DNA with an active *cos* site can be inserted into the prehead, and the packaging process then leads to the production of an infectious bacteriophage particle. Extracts made in this way usually have a lower background of plaques than the classical binary mixtures, because the deletion of the *cos* site blocks packaging of endogenous bacteriophage  $\lambda$  DNA more completely than the mutations present in the binary strains. *E. coli* C was chosen as the lysogenic host to lessen the probability of recombination between cryptic bacteriophage  $\lambda$  prophages, which are known to be present in the genome of *E. coli* K, and the *cos*-deleted prophage. Furthermore, *E. coli* C lacks the *EcoK* restriction system (Rosenberg 1985). This system, like other restriction systems, cuts unmodified DNA in a sequence-specific manner and is also functional in packaging reactions in vitro. Thus, extracts prepared from cells of *E. coli* K have the potential to select against DNA that contains an unmodified *EcoK* recognition site. Because eukaryotic DNA used to construct libraries will not be protected from cleavage, clones that by chance contain an *EcoK* recognition site may be lost from the population during packaging. Reconstruction experiments show that bacteriophage  $\lambda$  DNA carrying an *EcoK* recognition site is packaged two- to sevenfold less efficiently in extracts derived from *E. coli* K than in extracts prepared from *E. coli* C (Rosenberg 1985).

The *E. coli* C restriction-modification systems express components (*mcrA* /*mcrB* and *mrr*) that digest DNA carrying methyl groups on cytosine and adenine residues. (e.g., please see Kretz et al. 1989; Kohler et al. 1990). Because most eukaryotic DNAs are methylated on these residues, packaging extracts from strains of *E. coli* carrying intact *mcr* and *mrr* systems select against methylated eukaryotic DNA sequences. However, the use of packaging extracts prepared from bacterial cells deficient in the *EcoK*, *mcr*, and *mrr* genes (genotype  $\Delta$ [*mrr*-*hsdRMS*-*mcrB*]) effectively eliminates this problem (Kretz et al. 1989). For good measure, the *mcrF*- and *mrr*-encoded restriction systems have also been eliminated from the *E. coli* strains used to prepare some commercially available in vitro packaging extracts. Examples of commercially available single-component bacteriophage  $\lambda$  packaging extracts are the Gigapack III Gold from Stratagene, the MaxPlax packaging extract from Epicentre Technologies, and the Packagene extract from Promega.

## REFERENCES

- Albertsen H.M., Abderrahim H., Cann H.M., Dausset J., Le Paslier D., and Cohen D. 1990. Construction and characterization of a yeast artificial chromosome library containing seven haploid human genome equivalents. *Proc. Natl. Acad. Sci.* **87**: 4256–4260.
- Amundsen S.K., Taylor A.F., Chaudhury A.M., and Smith G.R. 1986. *recD*: The gene for an essential third subunit of exonuclease V. *Proc. Natl. Acad. Sci.* **83**: 5558–5562.
- Appleyard R.K. 1954. Segregation of new lysogenic types during growth of a doubly lysogenic strain derived from *Escherichia coli* K12. *Genetics* **39**: 440–452.
- Arber W., Enquist L., Hohn B., Murray N.E., and Murray K. 1983. Experimental methods for use with lambda. In *Lambda II* (ed. R.W. Hendrix et al.), pp. 433–466. Cold Spring Harbor Laboratory, Cold Spring Harbor, New York.
- Bajorath J., Hinrichs W., and Saenger W. 1988. The enzymatic activity of proteinase K is controlled by calcium. *Eur. J. Biochem.* **176**: 441–447.
- Bajorath J., Raghunathan S., Hinrichs W., and Saenger W. 1989. Long-range structural changes in proteinase K triggered by calcium ion removal. *Nature* **337**: 481–484.
- Bamuett E., Hoyt M.A., MacFarlane L., Echols H., and Herskowitz I. 1986. *hflB*, a new *Escherichia coli* locus regulating lysogeny and the level of bacteriophage lambda cII protein. *J. Mol. Biol.* **187**: 213–224.
- Barnes W.M. 1994. PCR amplification of up to 35-kb DNA with high fidelity and high yield from lambda bacteriophage templates. *Proc. Natl. Acad. Sci.* **91**: 2216–2220.
- Beamer L.J. and Pabo C.O. 1992. Refined 1.8 Å crystal structure of the  $\lambda$  repressor-operator complex. *J. Mol. Biol.* **227**: 177–196.
- Becker A. and Gold M. 1975. Isolation of the bacteriophage lambda A-gene protein. *Proc. Natl. Acad. Sci.* **72**: 581–585.
- Becker A. and Murialdo H. 1990. Bacteriophage  $\lambda$  DNA: The beginning of the end. *J. Bacteriol.* **172**: 2819–2823.
- Becker A., Marko M., and Gold M. 1977. Early events in the *in vitro* packaging of bacteriophage  $\lambda$  DNA. *Virology* **78**: 291–305.
- Benton W.D. and Davis R.W. 1977. Screening lambda gt recombinant clones by hybridization to single plaques *in situ*. *Science* **196**: 180–182.
- Betzl C., Pal G.P., and Saenger W. 1988. Three-dimensional structure of proteinase K at 0.15nm resolution. *Eur. J. Biochem.* **178**: 155–171.
- Black L.W. 1988. DNA packaging in dsDNA bacteriophages. In *The bacteriophages* (ed. R. Calendar), vol. 2, pp. 321–373. Plenum Press, New York.
- Blaisdell B.E., Rudd K.E., Matin A., and Karlin S. 1993. Significant dispersed recurrent DNA sequences in the *Escherichia coli* genome. Several new groups. *J. Mol. Biol.* **229**: 833–848.
- Blattner F.R., Williams B.G., Blechl A.E., Denniston-Thompson K., Faber H.F., Furlong L.-A., Grunwald D.J., Kiefer D.O., Moore D.D., Schumm J.W., Sheldon E.L., and Smithies O. 1977. Charon phages: Safer derivatives of bacteriophage lambda for DNA cloning. *Science* **196**: 161–169.
- Bode V.C. and Kaiser A.D. 1965. Repression of the cII and cIII cistrons of phage lambda in a lysogenic bacterium. *Virology* **25**: 111–121.
- Bolivar F. and Backman K. 1979. Plasmids of *Escherichia coli* as cloning vectors. *Methods Enzymol.* **68**: 245–267.
- Borck K., Beggs J.D., Brammar W.J., Hopkins A.S., and Murray N.E. 1976. The construction *in vitro* of transducing derivatives of phage lambda. *Mol. Gen. Genet.* **146**: 199–207.
- Boyd J. 1951. 'Excessive dose' phenomenon in virus infections. *Nature* **167**: 1061–1062.
- Boyer H.W. and Roulland-Dussoix D. 1969. A complementation analysis of the restriction and modification of DNA in *Escherichia coli*. *J. Mol. Biol.* **41**: 459–472.
- Brakke M.K. 1958. Estimation of sedimentation constants of viruses by density-gradient centrifugation. *Virology* **6**: 96–114.
- Brock T.D. 1990. Lysogeny. In *The emergence of bacterial genetics*, pp. 163–188. Cold Spring Harbor Laboratory Press, Cold Spring Harbor, New York.
- Bullock W.O., Fernandez J.M., and Short J.M. 1987. XII-blue: A high efficiency plasmid transforming *recA Escherichia coli* strain with beta-galactosidase selection. *BioTechniques* **5**: 376–379.
- Burland V., Plunkett III, G., Daniels D.L., and Blattner F.R. 1993. DNA sequence and analysis of 136 kilobases of the *Escherichia coli* genome: Organizational symmetry around the origin of replication. *Genomics* **16**: 551–561.
- Cairns J., Stent G.S., and Watson J.D., eds. 1992. *Phage and the origins of molecular biology*, expanded edition. Cold Spring Harbor Laboratory Press, Cold Spring Harbor, New York.
- Campbell A.M. 1962. Episomes (review). *Adv. Genet.* **11**: 101–145.
- . 1965. The steric effect in lysogenization by bacteriophage lambda. I. Lysogenization of a partially diploid strain of *Escherichia coli* K12. *Virology* **27**: 329–339.
- . 1993. Thirty years ago in *Genetics*: Prophage insertion into bacterial chromosomes. *Genetics* **133**: 433–437.
- Casjens S. and Hendrix R. 1988. Control mechanisms in dsDNA bacteriophage assembly. In *The bacteriophages* (ed. R. Calendar), vol. 1, pp. 15–91. Plenum Press, New York.
- Casjens S., Horn T., and Kaiser A.D. 1972. Head assembly steps controlled by genes *F* and *W* in bacteriophage  $\lambda$ . *J. Mol. Biol.* **64**: 551–563.
- Chattoraj D.K. and Inman R.B. 1974. Location of DNA ends in P2, 186, P4 and lambda bacteriophage heads. *J. Mol. Biol.* **87**: 11–22.
- Court D. and Sato K. 1969. Studies of novel transducing variants of lambda: Dispensability of genes *N* and *Q*. *Virology* **39**: 348–352.
- Craig N.L. and Nash H.A. 1983. The mechanism of phage  $\lambda$  site-specific recombination: Site-specific breakage of DNA by Int topoisomerase. *Cell* **35**: 795–803.
- Crouse G.F. 1985. Plasmids supplying the *Q-qut*-controlled *gam* function permit growth of lambda *red gam* (*Fec*) bacteriophages on *recA* hosts. *Gene* **40**: 151–155.
- Cue D. and Feiss M. 1993. The role of *cos B*, the binding site for terminase, the DNA packaging enzyme of bacteriophage  $\lambda$ , in the nicking reaction. *J. Mol. Biol.* **234**: 594–609.
- Daniels D.L., Schroeder J.L., Szybalski W., Sanger F., and Blattner F.R. 1983a. Appendix I: A molecular map of coliphage lambda. In *Lambda II* (ed. R.W. Hendrix et al.), pp. 469–517. Cold Spring Harbor Laboratory, Cold Spring Harbor, New York.
- Daniels D.L., Schroeder J.L., Szybalski W., Sanger F., Coulson A.R., Hong G.F., Hill D.E., Petersen G.B., and Blattner F.R. 1983b. Appendix II: Complete annotated lambda sequence.

- In *Lambda II* (ed. R.W. Hendrix et al.), pp. 519–676. Cold Spring Harbor Laboratory, Cold Spring Harbor, New York.
- Das A. 1993. Control of transcription termination by RNA-binding proteins. *Annu. Rev. Biochem.* **62**: 893–930.
- Davison J., Brunel E., and Merchez M. 1979. A new host-vector system allowing selection for foreign DNA inserts in bacteriophage  $\lambda$ gtWES. *Gene* **8**: 69–80.
- D'Herelle F. 1926. *The bacteriophage and its behavior*. Williams and Wilkins, Baltimore, Maryland.
- . 1949. The bacteriophage. *Science News* (Penguin Press, Harmondsworth, England) **14**: 44–59.
- Dove W.F. 1966. Action of the  $\lambda$  chromosome. I. Control of functions late in bacteriophage development. *J. Mol. Biol.* **19**: 187–201.
- Dugaiczyk A., Boyer H.W., and Goodman H.M. 1975. Ligation of *EcoRI* endonuclease-generated DNA fragments into linear and circular structures. *J. Mol. Biol.* **96**: 171–184.
- Dunn I.S. and Blattner F.R. 1987. Charons 36 to 40: Multienzyme, high capacity, recombination deficient replacement vectors with polylinkers and polystuffers. *Nucleic Acids Res.* **15**: 2677–2698.
- Ebeling W., Hennrich N., Klockow M., Metz H., Orth H.D., and Lang H. 1974. Proteinase K from *Tritirachium album* Limber. *Eur. J. Biochem.* **47**: 91–97.
- Echols H. 1980. Bacteriophage  $\lambda$  development. In *The molecular genetics of development* (ed. T. Leighton and W.F. Loomis, Jr.), pp. 1–16. Academic Press, New York.
- Emmons S. 1974. Bacteriophage  $\lambda$  derivatives carrying two copies of the cohesive end site. *J. Mol. Biol.* **83**: 511–525.
- Enquist L.W. and Weisberg R.A. 1976. The red plaque test: A rapid method for identification of excision defective variants of bacteriophage lambda. *Virology* **72**: 147–153.
- Faulds D., Dower N., Stahl M.M., and Stahl F.W. 1979. Orientation-dependent recombinational hotspot activity in bacteriophage  $\lambda$ . *J. Mol. Biol.* **131**: 681–695.
- Feiss M. 1986. Terminase and the recognition, cutting and packaging of  $\lambda$  chromosomes. *Trends Genet.* **2**: 100–104.
- Feiss M. and Becker A. 1983. DNA packaging and cutting. In *Lambda II* (ed. R.W. Hendrix et al.), pp. 305–330. Cold Spring Harbor Laboratory, Cold Spring Harbor, New York.
- Feiss M. and Campbell A. 1974. Duplication of the bacteriophage lambda cohesive end site: Genetic studies. *J. Mol. Biol.* **83**: 527–540.
- Ferenci T. and Boos W. 1980. The role of the *Escherichia coli* lambda receptor in the transport of maltose and maltodextrins. *J. Supramol. Struct.* **13**: 101–116.
- Fong R.S.-C., Woody S., and Gussin G.N. 1993. Modulation of  $P_{RM}$  activity by the lambda  $P_R$  promoter in both the presence and absence of repressor. *J. Mol. Biol.* **232**: 792–804.
- Frackman S., Siegele D.A., and Feiss M. 1984. A functional domain of bacteriophage  $\lambda$  terminase for prohead binding. *J. Mol. Biol.* **180**: 283–300.
- Franklin N.C. 1971. Illegitimate recombination. In *The bacteriophage lambda* (ed. A.D. Hershey), pp. 175–194. Cold Spring Harbor Laboratory, Cold Spring Harbor, New York.
- Friedman D.L., Obson E.R., Georgopoulos C., Tilly K., Herskowitz I., and Banuett F. 1984. Interactions of bacteriophage and host macromolecules in the growth of bacteriophage lambda. *Microbiol. Rev.* **48**: 299–325.
- Friedman D.L. 1988. Regulation of phage gene expression by termination and antitermination of transcription. In *The bacteriophages* (ed. R. Calendar), vol. 2, pp. 263–319. Plenum Press, New York.
- . 1992. Interaction between bacteriophage  $\lambda$  and its *Escherichia coli* host. *Curr. Opin. Genet. Dev.* **2**: 727–738.
- Frischauf A.M., Lehrach H., Poustka A., and Murray N. 1983. Lambda replacement vectors carrying polylinker sequences. *J. Mol. Biol.* **170**: 827–842.
- Furth M.E. and Wickner S.H. 1983. Lambda DNA replication. In *Lambda II* (ed. R.W. Hendrix et al.), pp. 145–173. Cold Spring Harbor Laboratory, Cold Spring Harbor, New York.
- Gingery R. and Echols H. 1967. Mutants of bacteriophage  $\lambda$  unable to integrate into the host chromosome. *Proc. Natl. Acad. Sci.* **58**: 1507–1514.
- Gold M. and Becker A. 1983. The bacteriophage  $\lambda$  terminase: Partial purification and preliminary characterization of properties. *J. Biol. Chem.* **258**: 14619–14625.
- Gottesman S., Gottesman M., Shaw J.E., and Pearson M.L. 1981. Protein degradation in *E. coli*: The *lon* mutation and bacteriophage lambda N and cII protein stability. *Cell* **24**: 225–233.
- Gough J.A. and Murray N.E. 1983. Sequence diversity among related genes for recognition of specific targets in DNA molecules. *J. Mol. Biol.* **166**: 1–19.
- Grayhack E.J., Yang X.J., Lau L.E., and Roberts J.W. 1985. Phage lambda gene Q antiterminator recognizes RNA polymerase near the promoter and accelerates it through a pause site. *Cell* **42**: 259–269.
- Greenstein M. and Skalka A. 1975. Replication of bacteriophage  $\lambda$  DNA: *In vivo* studies of the interaction between the viral gamma protein and the host *recBC* DNAase. *J. Mol. Biol.* **97**: 543–549.
- Grodzicker T., Arditti R.R., and Eisen H. 1972. Establishment of repression by lambdaoid phage in catabolite activator protein and adenylate cyclase mutants of *Escherichia coli*. *Proc. Natl. Acad. Sci.* **69**: 366–370.
- Guarente L., Nye J.S., Hochschild A., and Ptashne M. 1982. Mutant  $\lambda$  phage repressor with a specific defect in its positive control function. *Proc. Natl. Acad. Sci.* **79**: 2236–2239.
- Gunkel F.A. and Gassen H.G. 1989. Proteinase K from *Tritirachium album* Limber. Characterization of the chromosomal gene and expression of the cDNA in *Escherichia coli*. *Eur. J. Biochem.* **179**: 185–194.
- Gussin G.N., Johnson A.D., Pabo C.O., and Sauer R.T. 1983. Repressor and cro protein: Structure, function and role in lysogenization. In *Lambda II* (ed. R.W. Hendrix et al.), pp. 93–121. Cold Spring Harbor Laboratory, Cold Spring Harbor, New York.
- Han J.H. and Rutter W.J. 1987.  $\lambda$ gt22, an improved  $\lambda$  vector for the directional cloning of full-length cDNA. *Nucleic Acids Res.* **15**: 6304.
- . 1988. Isolation of intact mRNA and construction of full-length cDNA libraries: Use of a new vector  $\lambda$ gt22, and primer-adapters for directional cDNA cloning. *Genet. Eng.* **10**: 195–219.
- Harrison S.C. 1992. Molecular characteristics of the regulatory switch in phages 434 and  $\lambda$ . In *Transcriptional regulation* (ed. S.L. McKnight and K.R. Yamamoto), pp. 449–473. Cold Spring Harbor Laboratory Press, Cold Spring Harbor, New York.
- Hawley D.K. and McClure W.R. 1983. The effect of lambda repressor mutation on the activation of transcription initiation from the lambda  $P_{RM}$  promoter. *Cell* **32**: 327–333.
- Helms C., Dutchik J.E., and Olson M.V. 1987. A lambda DNA protocol based on purification of phage on DEAE-cellulose. *Methods Enzymol.* **153**: 69–82.
- Helms C., Graham M.Y., Dutchik J.E., and Olson M.V. 1985. A

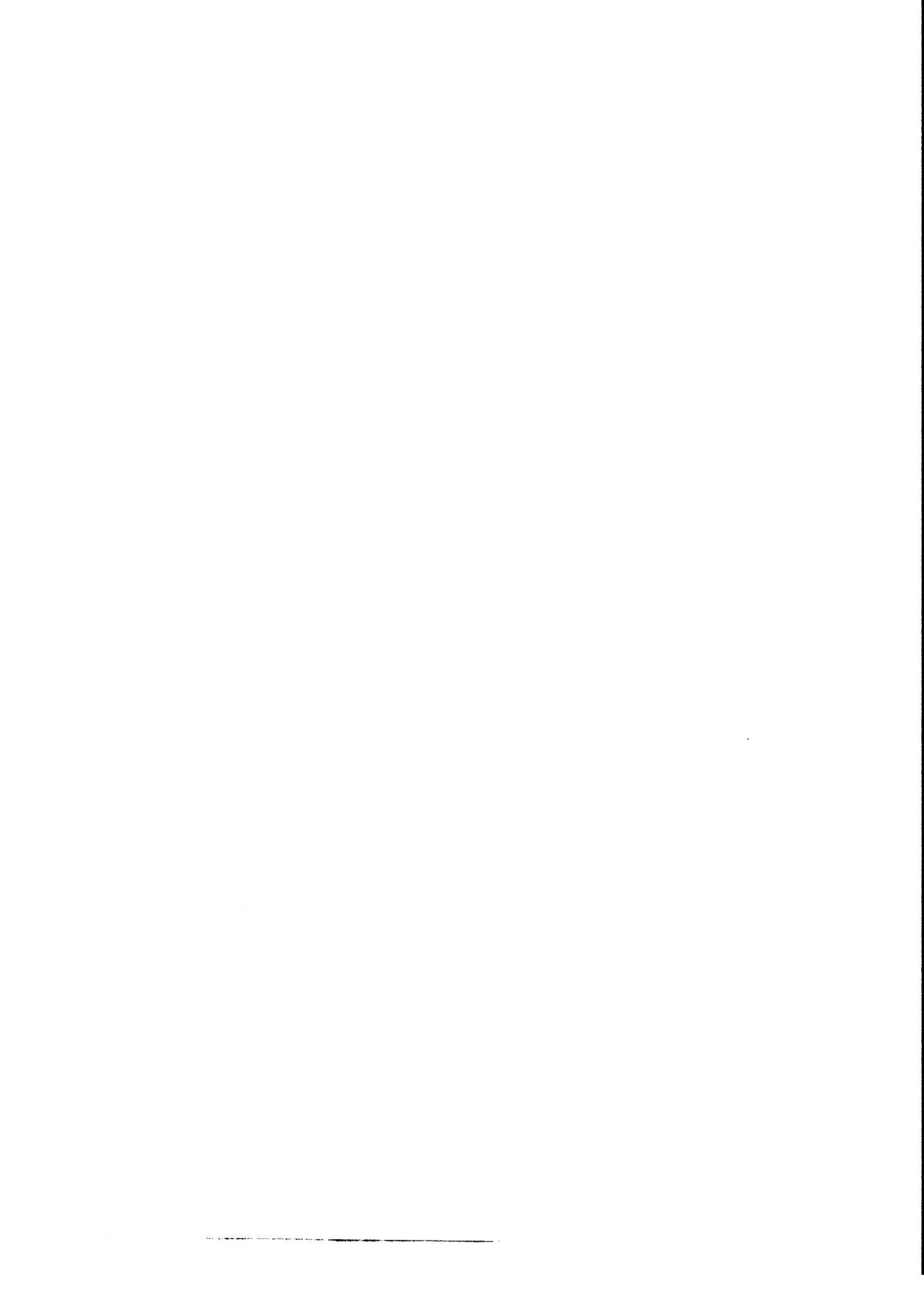
- new method for purifying lambda DNA from phage lysates. *DNA* **4**: 39–49.
- Henderson D. and Weil J. 1975. Recombination-deficient deletions in bacteriophage lambda and their interaction with *chi* mutations. *Genetics* **79**: 143–174.
- Hendrix R.W. 1978. Symmetry mismatch and DNA packaging in large bacteriophages. *Proc. Natl. Acad. Sci.* **75**: 4779–4783.
- Hendrix R.W., Roberts J.W., Stahl F.W., and Weisberg R.A., eds. 1983. *Lambda II*. Cold Spring Harbor Laboratory, Cold Spring Harbor, New York.
- Hershberger P.A., Mita B.C., Tripatara A., and deHaseth P.L. 1993. Interference by  $P_R$ -bound RNA polymerase with  $P_{RM}$  function *in vitro*. Modulation by the bacteriophage lambda cl protein. *J. Biol. Chem.* **268**: 8943–8948.
- Herskowitz I. and Hagen D. 1980. The lysis-lysogeny decision of phage  $\lambda$ : Explicit programming and responsiveness. *Annu. Rev. Genet.* **14**: 399–445.
- Higgins R.R., Lucko H.J., and Becker A. 1988. Mechanism of *cos* DNA cleavage by bacteriophage  $\lambda$  terminase: Multiple roles of ATP. *Cell* **54**: 765–775.
- Hilz H., Wieggers U., and Adamietz P. 1975. Stimulation of proteinase K action by denaturing agents: Application to the isolation of nucleic acids and the degradation of 'masked' proteins. *Eur. J. Biochem.* **56**: 103–108.
- Ho Y.S. and Rosenberg M. 1988. Structure and function of the transcription activator protein cII and its regulatory signals. In *The bacteriophages* (ed. R. Calendar), vol. 2, pp. 725–756. Plenum Press, New York.
- Hochschild A. 1994. Transcriptional activation. How  $\lambda$  repressor talks to RNA polymerase. *Curr. Biol.* **4**: 440–442.
- Hochschild A., Irwin N., and Ptashne M. 1983. Repressor structure and the mechanism of positive control. *Cell* **32**: 319–325.
- Hoess R.H., Foeller C., Bidwell K., and Landy A. 1980. Site-specific recombination functions of bacteriophage  $\lambda$ : DNA sequence of regulatory regions and overlapping structural genes for *Int* and *Xis*. *Proc. Natl. Acad. Sci.* **77**: 2482–2486.
- Hoheisel J.D., Nizetic D., and Lehrach H. 1989. Control of partial digestion combining the enzymes *dam* methylase and *Mbol*. *Nucleic Acids Res.* **17**: 9571–9582.
- Hohn B. 1979. *In vitro* packaging of  $\lambda$  and cosmid DNA. *Methods Enzymol.* **68**: 299–309.
- . 1983. DNA sequences necessary for packaging of bacteriophage  $\lambda$  DNA. *Proc. Natl. Acad. Sci.* **80**: 7456–7460.
- Hohn B. and Murray K. 1977. Packaging recombinant DNA molecules into bacteriophage particles *in vitro*. *Proc. Natl. Acad. Sci.* **74**: 3259–3263.
- Hong I.S., Smith G.R., and Ames B.N. 1971. Adenosine 3':5'-cyclic monophosphate concentration in the bacterial host regulates the viral decision between lysogeny and lysis. *Proc. Natl. Acad. Sci.* **68**: 2258–2262.
- Hoyt M.A., Knight D.M., Das A., Miller H.I., and Echols H. 1982. Control of phage lambda development by stability and synthesis of cII protein: Role of the viral cIII and host *hflA*, *hima* and *himD* genes. *Cell* **31**: 565–573.
- Hsaio C.L. and Black L.W. 1977. DNA packaging and the pathway of bacteriophage T4 head assembly. *Proc. Natl. Acad. Sci.* **74**: 3652–3656.
- Huynh T.V., Young R.A., and Davis R.W. 1985. Constructing and screening cDNA libraries in  $\lambda$ gt10 and  $\lambda$ gt11. In *DNA cloning: A practical approach* (ed. D.M. Glover), vol. 1, pp. 49–78. IRL Press, Oxford, United Kingdom.
- Jany K.-D., Lederer G., and Mayer B. 1986. Amino acid sequence of proteinase K from the mold *Tritirachium album* Limber. *FEBS Lett.* **199**: 139–144.
- Jendrisak J., Young R.A., and Engel J.D. 1987. Cloning cDNA into  $\lambda$ gt10 and  $\lambda$ gt11. *Methods Enzymol.* **152**: 359–371.
- Jerpseth B., Greener, A., Short J.M., Viola J., and Kretz P.L. 1992. XL1-Blue MRF *E. coli* cells:  $McrA^+$ ,  $McrCB^+$ ,  $McrF^-$ ,  $Mrr^-$ ,  $HsdR^-$  derivative of XL1-Blue cells. *Strategies Newsletter* **5**: 81–83. Stratagene, La Jolla, California.
- Johnson A.D., Meyer B.J., and Ptashne M. 1978. Mechanism of action of the *cro* protein of bacteriophage  $\lambda$ . *Proc. Natl. Acad. Sci.* **75**: 1783–1787.
- . 1979. Interactions between DNA-bound repressors govern regulation by the  $\lambda$  phage repressor. *Proc. Natl. Acad. Sci.* **76**: 5061–5065.
- Joyner A., Isaacs L.N., Echols H., and Sly W.S. 1966. DNA replication and messenger RNA production after induction of wild-type lambda bacteriophage and lambda mutants. *J. Mol. Biol.* **19**: 174–186.
- Kaiser D. 1955. A genetic study of the temperate coliphage  $\lambda$ . *Virology* **1**: 424–443.
- Kaiser D., Syvanen M., and Masuda T. 1975. DNA packaging steps in bacteriophage lambda head assembly. *J. Mol. Biol.* **91**: 175–186.
- Karn J., Brenner S., Barnett L., and Cesareni G. 1980. Novel bacteriophage  $\lambda$  cloning vector. *Proc. Natl. Acad. Sci.* **77**: 5172–5176.
- Karn J., Matthes H.W., Gait M.J., and Brenner S. 1984. A new selective cloning vector,  $\lambda$ 2001, with sites for *XbaI*, *BamHI*, *HindIII*, *EcoRI*, *SstI* and *XhoI*. *Gene* **32**: 217–224.
- Khandjian E.W. 1987. Optimized hybridization of DNA blotted and fixed to nitrocellulose and nylon membranes. *BioTechnology* **5**: 165–167.
- Kikuchi Y. and Nash H.A. 1979a. Integrative recombination of bacteriophage  $\lambda$ : Requirement for supertwisted DNA *in vivo* and characterization of *Int*. *Cold Spring Harbor Symp. Quant Biol.* **43**: 1099–1109.
- . 1979b. Nicking-closing activity associated with bacteriophage  $\lambda$  *int* gene product. *Proc. Natl. Acad. Sci.* **76**: 3760–3764.
- Kim S. and Landy A. 1992. Lambda *Int* protein bridges between higher order complexes at two distant chromosomal loci *attL* and *attR*. *Science* **256**: 198–203.
- Klein B. and Murray K. 1979. Phage lambda receptor chromosomes for DNA fragments made with restriction endonuclease I of *Bacillus amyloliquefaciens* H. *J. Mol. Biol.* **133**: 289–294.
- Kohler S.W., Provost G.S., Kretz P.L., Dyaico M.J., Sorge J.A., and Short J.M. 1990. Development of a short-term, *in vivo* mutagenesis assay: The effects of methylation on the recovery of a lambda phage shuttle vector from transgenic mice. *Nucleic Acids Res.* **18**: 3007–3013.
- Kornberg A. and Baker T.A. 1992. *DNA replication*, 2nd edition. W.H. Freeman, New York.
- Kourilsky P. 1973. Lysogenization by bacteriophage  $\lambda$ . I. Multiple infection and the lysogenic response. *Mol. Gen. Genet.* **122**: 183–195.
- Kretz P.L., Reid C.H., Greener A., and Short J.M. 1989. Effect of lambda packaging extract *mcr* restriction activity on DNA cloning. *Nucleic Acids Res.* **17**: 5409.
- Kuzminov A., Schabtach E., and Stahl F.W. 1994. *Chi* sites in combination with *recA* protein increase the survival of linear DNA in *Escherichia coli* by inactivating *exoV* activity of RecBCD nuclease. *EMBO J.* **13**: 2764–2776.

- Lam S.T., Stahl M.M., McMilin K.D., and Stahl F.W. 1974. Recombination-mediated recombinational hot spot activity in bacteriophage lambda. II. A mutation which causes hot spot activity. *Genetics* **77**: 425-433.
- Landy A. 1989. Dynamic, structural and regulatory aspects of lambda site-specific recombination. *Annu. Rev. Biochem.* **58**: 913-949.
- Lauer J., Shen C.K., and Maniatis T. 1980. The chromosomal arrangement of human  $\alpha$ -like globin genes: Sequence homology and  $\alpha$ -globin gene deletions. *Cell* **20**: 119-130.
- Leder P., Tiemeier D., and Enquist L. 1977. EK2 derivatives of bacteriophage lambda useful in the cloning of DNA from higher organisms: The  $\lambda$  gtWES system. *Science* **196**: 175-177.
- Lieb M. 1953a. Studies on lysogenization in *Escherichia coli*. *Cold Spring Harbor Symp. Quant. Biol.* **18**: 71-73.
- . 1953b. The establishment of lysogeny in *Escherichia coli*. *J. Bacteriol.* **65**: 642-651.
- . 1979. Heat-sensitive lambda repressors retain partial activity during bacteriophage infection. *J. Virol.* **32**: 162-166.
- Little J.W. 1984. Autodigestion of *lexA* and phage lambda repressors. *Proc. Natl. Acad. Sci.* **81**: 1375-1379.
- . 1991. Mechanism of specificity *lexA* cleavage: Autodigestion and the role of RecA coprotease. *Biochimie* **73**: 411-421.
- . 1993. *lexA* cleavage and other self-processing reactions. *J. Bacteriol.* **175**: 4943-4950.
- Loenen W.A.M. and Blattner E.R. 1983. Lambda charon vectors (Ch32, 33, 34 and 35) adapted for DNA cloning in recombination-deficient hosts. *Gene* **26**: 171-179.
- Lwoff A. 1953. Lysogeny. *Bacteriol. Rev.* **17**: 269-337.
- . 1966. The prophage and I. In *Phage and the origins of molecular biology* (ed. J. Cairns et al.), pp. 88-99. Cold Spring Harbor Laboratory, Cold Spring Harbor, New York.
- Lwoff A. and Gutmann A. 1950. Recherches sur un *Bacillus megatherium* lysogène. *Ann. Inst. Pasteur* **78**: 711-739.
- MacKay D.J. and Bode V.C. 1976. Events in lambda injection between phage adsorption and DNA entry. *Virology* **72**: 154-166.
- Mandal N.C. and Lieb M. 1976. Heat-sensitive DNA binding activity of the *cl* product of bacteriophage lambda. *Mol. Gen. Genet.* **146**: 299-302.
- Manfioletti G. and Schneider C. 1988. A new and fast method for preparing high quality lambda DNA suitable for sequencing. *Nucleic Acids Res.* **16**: 2873-2884.
- Maniatis T., Hardison R.C., Lacy E., Lauer J., O'Connell C., Quon D., Sim G.K., and Efstratiadis A. 1978. The isolation of structural genes from libraries of eukaryotic DNA. *Cell* **15**: 687-701.
- Marchal C. and Hofnung M. 1983. Negative dominance in gene *lamB*: Random assembly of secreted subunits issued from different polysomes. *EMBO J.* **2**: 81-86.
- McDermitt M., Pierce M., Staley D., Shimaji M., Shaw R., and Wulff D.L. 1976. Mutations masking the lambda *cin-I* mutation. *Genetics* **82**: 417-422.
- Medigue C., Viari A., Hénaut A., and Danchin A. 1993. Colibri: A functional data base for the *Escherichia coli* genome. *Microbiol. Rev.* **57**: 623-654.
- Meissner P.S., Sisk W.P., and Berman M.L. 1987. Bacteriophage lambda cloning system for the construction of directional cDNA libraries. *Proc. Natl. Acad. Sci.* **84**: 4171-4175.
- Meselson M. and Yuan R. 1968. DNA restriction enzyme from *E. coli*. *Nature* **217**: 1110-1114.
- Meyer B.J., Maurer R., and Ptashne M. 1980. Gene regulation at the right operator ( $O_R$ ) of bacteriophage lambda. II.  $O_R1$ ,  $O_R2$ , and  $O_R3$ : Their roles in mediating the effects of repressor and cro. *J. Mol. Biol.* **139**: 163-194.
- Miller H.I. and Friedman D.I. 1977. Isolation of *Escherichia coli* mutants unable to support lambda integrative recombination. In *DNA insertion elements, plasmids and episomes* (ed. A.I. Bukhari et al.), pp. 349-356. Cold Spring Harbor Laboratory, Cold Spring Harbor, New York.
- Miller H.I., Kikuchi A., Nash H.A., Weisberg R.A., and Friedman D.I. 1979. Site-specific recombination of bacteriophage lambda: The role of host gene products. *Cold Spring Harbor Symp. Quant. Biol.* **43**: 1121-1126.
- Miller J.H. 1972. *Experiments in molecular genetics*. Cold Spring Harbor Laboratory, Cold Spring Harbor, New York.
- Mizuuchi K., Gellert M., and Nash H.A. 1978. Involvement of supercoiled DNA in integrative recombination of bacteriophage lambda. *J. Mol. Biol.* **121**: 375-392.
- Müller A., Hinrichs W., Wolf W.M., and Saenger W. 1994. Crystal structure of calcium-free proteinase K at 1.5 Å resolution. *J. Biol. Chem.* **269**: 23108-23111.
- Murialdo H. and Siminovitch L. 1972. The morphogenesis of phage lambda. V. Form-determining function of the genes required for the assembly of the head. *Virology* **48**: 824-835.
- Murray N.E. 1983. Phage lambda and molecular cloning. In *Lambda II* (ed. R.W. Hendrix et al.), pp. 395-432. Cold Spring Harbor Laboratory, Cold Spring Harbor, New York.
- . 1991. Special uses of lambda phage for molecular cloning. *Methods Enzymol.* **204**: 280-301.
- Murray N.E. and Murray K. 1974. Manipulation of restriction targets in phage lambda to form receptor chromosomes for DNA fragments. *Nature* **251**: 476-481.
- Murray N.E., Brammar W.J., and Murray K. 1977. Lambdoid phages that simplify the recovery of *in vitro* recombinants. *Mol. Gen. Genet.* **150**: 53-61.
- Nash H.A. 1990. Bending and supercoiling of DNA at the attachment site of bacteriophage lambda. *Trends Biochem. Sci.* **15**: 222-227.
- Nash H.A. and Robertson C.A. 1981. Purification and properties of the *Escherichia coli* protein factor required for lambda integrative recombination. *J. Biol. Chem.* **256**: 9246-9253.
- Nash H.A., Mizuuchi K., Weisberg R.A., Kikuchi Y., and Gellert M. 1977. Integrative recombination of bacteriophage lambda — The biochemical approach to DNA insertions. In *DNA insertion elements, plasmids and episomes* (ed. A.I. Bukhari et al.), pp. 363-373. Cold Spring Harbor Laboratory, Cold Spring Harbor, New York.
- Neuhaus J.M. 1982. The receptor protein of phage lambda: Purification, characterization and preliminary electrical studies in planar lipid bilayers. *Ann. Microbiol.* **133**: 27-32.
- Nichols B.P. and Donelson J.E. 1978. 178-Nucleotide sequence surrounding the *cos* site of bacteriophage lambda DNA. *J. Virol.* **26**: 429-434.
- Oliver D.B. and Goldberg E.B. 1977. Protection of parental T4 DNA from a restriction exonuclease by the product of gene 2. *J. Mol. Biol.* **116**: 877-881.
- Oppenheim A.B., Kornitzer D., Altuvia S., and Court D.L. 1993. Posttranscriptional control of the lysogenic pathway in bacteriophage lambda. *Prog. Nucleic Acid Res. Mol. Biol.* **46**: 37-49.
- Pabo C.O. and Lewis M. 1982. The operator-binding domain of lambda repressor: Structure and DNA recognition. *Nature* **298**: 443-447.

- Pabo C.O., Sauer R.T., Sturtevant J.M., and Ptashne M. 1979. The  $\lambda$  repressor contains two domains. *Proc. Natl. Acad. Sci.* **76**: 1608–1612.
- Parris W., Davidson A., Keeler Jr., C.L., and Gold M. 1988. The *NuI* subunit of bacteriophage  $\lambda$  terminase. *J. Biol. Chem.* **263**: 8413–8419.
- Patterson T.A. and Dean M. 1987. Preparation of high titer lambda phage lysates. *Nucleic Acids Res.* **15**: 6298.
- Postma P.W. 1987. Phosphotransferase system for glucose and other sugars. In *Escherichia coli and Salmonella typhimurium. Cellular and molecular biology* (ed. F.C. Neidhardt et al.), vol. 1, pp. 127–141. American Society for Microbiology, Washington, D.C.
- Pourcel C. and Tiollais P. 1977.  $\lambda$ plac5 derivatives, potential vectors for DNA fragments cleaved by *Streptomyces stanfordii* restriction enzyme (*SstI*). *Gene* **1**: 281–286.
- Pourcel C., Marchal C., Louise A., Fritsch A., and Tiollais P. 1979. Bacteriophage lambda-*E. coli* K12 vector-host system for gene cloning and expression under lactose promoter control: I. DNA fragment insertion at the *lacZ EcoRI* restriction site. *Mol. Gen. Genet.* **170**: 161–169.
- Poustka A. 1993. Construction and use of chromosome jumping libraries. *Methods Enzymol.* **217**: 358–378.
- Ptashne M. 1986. *A genetic switch: Gene control and phage  $\lambda$* . Blackwell Scientific, Palo Alto, California and Cell Press, Cambridge, Massachusetts.
- . 1992. *A genetic switch: Phage  $\lambda$  and higher organisms*, 2nd edition. Blackwell Scientific, Palo Alto, California and Cell Press, Cambridge, Massachusetts.
- Raleigh E.A. and Wilson G. 1986. *Escherichia coli* K-12 restricts DNA containing 5-methylcytosine. *Proc. Natl. Acad. Sci.* **83**: 9070–9074.
- Rambach A. and Tiollais P. 1974. Bacteriophage  $\lambda$  having *EcoRI* endonuclease sites only in the non-essential region of the genome. *Proc. Natl. Acad. Sci.* **71**: 3927–3930.
- Richet E., Abcarian P., and Nash H.A. 1986. The interaction of recombination proteins with supercoiled DNA: Defining the role of supercoiling in lambda integrative recombination. *Cell* **46**: 1011–1021.
- Roberts J.W. 1975. Transcription termination and late control in phage lambda. *Proc. Natl. Acad. Sci.* **72**: 3300–3304.
- . 1993. RNA and protein elements of *E. coli* and  $\lambda$  transcription antitermination complexes. *Cell* **72**: 653–655.
- Roberts J.W. and Devoret R. 1983. Lysogenic induction. In *Lambda II* (ed. R.W. Hendrix et al.), pp. 123–144. Cold Spring Harbor Laboratory, Cold Spring Harbor, New York.
- Rosenberg M., Court D., Shimatake H., Brady C., and Wulff D.L. 1978. The relationship between function and DNA sequence in an intercistronic regulatory region in phage lambda. *Nature* **272**: 414–423.
- Rosenberg S.M. 1985. *EcoK* restriction during in vitro packaging of coliphage lambda DNA. *Gene* **39**: 313–315.
- . 1987. Improved in vitro packaging of lambda DNA. *Methods Enzymol.* **153**: 95–103.
- Saigo K. and Uchida H. 1974. Connection of the right-hand terminus of DNA to the proximal end of the tail in bacteriophage lambda. *Virology* **61**: 524–536.
- Sanger F., Coulson A.R., Hong G.F., Hill D.F., and Petersen G.B. 1982. Nucleotide sequence of bacteriophage  $\lambda$  DNA. *J. Mol. Biol.* **162**: 729–773.
- Sauer R.T., Pabo C.O., Meyer B.J., Ptashne M., and Backman K.C. 1979. Regulatory functions of the  $\lambda$  repressor reside in the amino-terminal domain. *Nature* **279**: 396–400.
- Scalenghe E., Turco E., Edstrom J.E., Pirota V., and Melli M. 1981. Microdissection and cloning of DNA from a specific region of *Drosophila melanogaster* polytene chromosomes. *Chromosoma* **82**: 205–216.
- Scherer G., Telford J., Baldari C., and Pirota V. 1981. Isolation of cloned genes differentially expressed at early and late stages of *Drosophila* embryonic development. *Dev. Biol.* **86**: 438–447.
- Schirmer T., Keller T.A., Wang Y.F., and Rosenbusch J.P. 1995. Structural basis for sugar translocation through maltoporin channels at 3.1 Å resolution. *Science* **267**: 512–514.
- Schwartz M. 1967. Sur l'existence chez *Escherichia coli* K12 d'une régulation commune à la biosynthèse des récepteurs du bactériophage  $\lambda$  et au métabolisme du maltose. *Ann. Inst. Pasteur* **113**: 685–704.
- . 1975. Reversible interaction between coliphage lambda and its receptor protein. *J. Mol. Biol.* **99**: 185–201.
- Short J.M., Fernandez J.M., Sorge J.A., and Huse W.D. 1988. Lambda ZAP: A bacteriophage lambda expression vector with in vivo excision properties. *Nucleic Acids Res.* **16**: 7583–7600.
- Siezen R.J. and Leunissen J.A. 1997. Subtilases: The superfamily of subtilisin-like serine proteases. *Protein Sci.* **6**: 501–523.
- Siezen R.J., de Vos W.M., Leunissen J.A., and Dijkstra B.W. 1991. Homology modelling and protein engineering strategy of subtilases, the family of subtilisin-like serine proteinases. *Protein Eng.* **4**: 719–737.
- Simmon V.F. and Lederberg S. 1972. Degradation of bacteriophage lambda deoxyribonucleic acid after restriction by *Escherichia coli* K-12. *J. Bacteriol.* **112**: 161–169.
- Sippy J. and Feiss M. 1992. Analysis of a mutation affecting the specificity domain for prohead binding of the bacteriophage  $\lambda$  terminase. *J. Bacteriol.* **174**: 850–856.
- Smith G.R. 1983. Chi hotspots of generalized recombination. *Cell* **34**: 709–710.
- . 1990. RecBCD enzyme. *Nucleic Acids Mol. Biol.* **4**: 78–98.
- Smith G.R., Kunes S.M., Schultz D.W., Taylor A., and Trimman K.L. 1981. Structure of Chi hotspots of generalized recombination. *Cell* **24**: 429–436.
- Sorge J.A. 1988. Bacteriophage lambda cloning vectors. In *Vectors: A survey of molecular cloning vectors and their uses* (ed. R.L. Rodriguez and D.T. Denhardt), pp. 43–60. Butterworth, Boston, Massachusetts.
- Stahl F.W., Crasemann J.M., and Stahl M.M. 1975. Rec-mediated recombinational hot spot activity in bacteriophage lambda III. Chi mutations are site mutations stimulating Rec-mediated recombination. *J. Mol. Biol.* **94**: 203–212.
- Sternberg N. and Weisberg R. 1977. Packaging of coliphage  $\lambda$  DNA. II. The role of the gene D protein. *J. Mol. Biol.* **117**: 733–759.
- Sternberg N., Tiemeier D., and Enquist L. 1977. In vitro packaging of a  $\lambda$  *Dam* vector containing *EcoRI* DNA fragments of *Escherichia coli* and phage P1. *Gene* **1**: 255–280.
- Sussman R. and Jacob F. 1962. Sur un système de répression thermosensible chez le bactériophage d'*Escherichia coli*. *C.R. Acad. Sci.* **254**: 1517.
- Szmelcman S. and Hofnung M. 1975. Maltose transport in *Escherichia coli* K-12: Involvement of the bacteriophage lambda receptor. *J. Bacteriol.* **124**: 112–118.
- Taylor A.F. 1988. RecBCD enzyme of *Escherichia coli*. In *Genetic recombination* (ed. R. Kucherlapati and G.R. Smith), pp. 231–263. American Society for Microbiology, Washington, D.C.
- Taylor A.F., Schultz D.W., Ponticelli A.S., and Smith G.R. 1985. RecBC enzyme nicking at Chi sites during DNA unwinding:

- Location and orientation-dependence of the cutting. *Cell* **41**: 153–163.
- Telander-Muskavitch K.M. and Linn S. 1981. *recBC*-like enzymes: Exonuclease V deoxyribonucleases. In *The enzymes*, 3rd edition (ed. P.D. Boyer), vol. 14, pp. 233–250. Academic Press, New York.
- Thirion J.P. and Hofnung M. 1972. On some genetic aspects of phage  $\lambda$  resistance in *E. coli* K12. *Genetics* **71**: 207–216.
- Thomas J.O. 1974. Chemical linkage of the tail to the right-hand end of bacteriophage lambda DNA. *J. Mol. Biol.* **87**: 1–9.
- Thomas M., Cameron J.R., and Davis R.W. 1974. Viable molecular hybrids of bacteriophage  $\lambda$  and eukaryotic DNA. *Proc. Natl. Acad. Sci.* **71**: 4579–4583.
- Thomas R. 1993. Bacteriophage  $\lambda$ : Transactivation, positive control and other odd findings. *BioEssays* **15**: 285–289.
- Tsui L. and Hendrix R.W. 1980. Head-tail connector of bacteriophage lambda. *J. Mol. Biol.* **142**: 419–438.
- Twort F.W. 1915. An investigation on the nature of ultra-microscopic viruses. *Lancet* **II**: 1241–1243.
- . 1949. The discovery of the bacteriophage. *Science News* (Penguin Press, Harmondsworth, England) **14**: 33–43.
- Unger R.C. and Clark A.J. 1972. Interaction of the recombination pathways of bacteriophage  $\lambda$  and its host *Escherichia coli* K12. Effects on exonuclease V activity. *J. Mol. Biol.* **70**: 539–548.
- Vande Woude G.E., Oskarsson M., Enquist L.W., Nomura S., Sullivan M., and Fischinger P.J. 1979. Cloning of integrated Moloney sarcoma proviral DNA sequences in bacteriophage lambda. *Proc. Natl. Acad. Sci.* **76**: 4464–4468.
- Weigel P.H., Englund P.T., Murray K., and Old R.W. 1973. The 3'-terminal nucleotide sequences of bacteriophage lambda DNA. *Proc. Natl. Acad. Sci.* **70**: 1151–1155.
- Weisberg R.A. and Landy A. 1983. Site-specific recombination in phage lambda. In *Lambda II* (ed. R.W. Hendrix et al.), pp. 211–250. Cold Spring Harbor Laboratory, Cold Spring Harbor, New York.
- Werts C., Michel V., Hofnung M., and Charbit A. 1994. Adsorption of bacteriophage lambda on the Lamb protein of *Escherichia coli* K-12: Point mutations in gene J of lambda responsible for extended host range. *J. Bacteriol.* **176**: 941–947.
- Wieggers U. and Hilz H. 1971. A new method using "proteinase K" to prevent mRNA degradation during isolation from HeLa cells. *Biochem. Biophys. Res. Commun.* **44**: 513–519.
- . 1972. Rapid isolation of undegraded polysomal RNA without phenol. *FEBS Lett.* **23**: 77–82.
- Williams B.G. and Blattner F.R. 1979. Construction and characterization of the hybrid bacteriophage lambda Charon vectors for DNA cloning. *J. Virol.* **29**: 555–575.
- . 1980. Bacteriophage lambda vectors for DNA cloning. *Genet. Eng.* **2**: 201–281.
- Woo S.L. 1979. A sensitive and rapid method for recombinant phage screening. *Methods Enzymol.* **68**: 389–395.
- Woo S.L., Dugaiczky A., Tsai M.-J., Lai E.C., Catterall J.F., and O'Malley B.W. 1978. The ovalbumin gene: Cloning of the natural gene. *Proc. Natl. Acad. Sci.* **75**: 3688–3692.
- Wood W.B. 1966. Host specificity of DNA produced by *Escherichia coli*: Bacterial mutations affecting the restriction and modification of DNA. *J. Mol. Biol.* **16**: 118–133.
- Wu R. and Taylor E. 1971. Nucleotide sequence analysis of DNA. II. Complete nucleotide sequence of the cohesive ends of bacteriophage lambda DNA. *J. Mol. Biol.* **57**: 491–511.
- Wulff D.L. and Rosenberg M. 1983. Establishment of repressor synthesis. In *Lambda II* (ed. R.W. Hendrix et al.), pp. 53–73. Cold Spring Harbor Laboratory, Cold Spring Harbor, New York.
- Xu S.-Y. 1986. A rapid method for preparing phage lambda DNA from agar plate lysates. *Gene Anal. Tech.* **3**: 90–91.
- Yagil E., Dower N.A., Chatteraj D., Stahl M., Pierson C., and Stahl F.W. 1980. Chi mutation in a transposon and the orientation dependence of Chi phenotype. *Genetics* **96**: 43–57.
- Yamamoto K.R., Alberts B.M., Benzinger R., Lawhorne L., and Treiber G. 1970. Rapid bacteriophage sedimentation in the presence of polyethylene glycol and its application to large-scale virus purification. *Virology* **40**: 734–744.
- Yarmolinsky M.B. 1971. Making and joining DNA ends. In *The bacteriophage lambda* (ed. A.D. Hershey), pp. 97–111. Cold Spring Harbor Laboratory, Cold Spring Harbor, New York.
- Yarnell W.S. and Roberts J.W. 1992. The phage  $\lambda$  gene Q transcription antiterminator binds DNA in the late gene promoter as it modifies RNA polymerase. *Cell* **69**: 1181–1189.
- Yeo A. and Feiss M. 1995. Specific interaction of terminase, the DNA packaging enzyme of bacteriophage  $\lambda$ , with the portal protein of the prohead. *J. Mol. Biol.* **245**: 141–150.
- Young R. 1992. Bacteriophage lysis: Mechanisms and regulation. *Microbiol. Rev.* **56**: 430–481.
- Young R.A. and Davis R.W. 1983a. Efficient isolation of genes by using antibody probes. *Proc. Natl. Acad. Sci.* **80**: 1194–1198.
- . 1983b. Yeast RNA polymerase II genes: Isolation with antibody probes. *Science* **222**: 778–782.
- Zissler J. 1967. Integration-negative (*int*) mutants of phage  $\lambda$ . *Virology* **31**: 189.
- Zissler J., Signer E., and Schaefer F. 1971. The role of recombination in growth of bacteriophage lambda. I. The gamma gene. In *The bacteriophage lambda* (ed. A.D. Hershey), pp. 455–475. Cold Spring Harbor Laboratory, Cold Spring Harbor, New York.





# Chapter 3

---

## Working with Bacteriophage M13 Vectors

### INTRODUCTION

### PROTOCOLS

1	Plating Bacteriophage M13	3.17
2	Growing Bacteriophage M13 in Liquid Culture	3.20
3	Preparation of Double-stranded (Replicative Form) Bacteriophage M13 DNA	3.23
4	Preparation of Single-stranded Bacteriophage M13 DNA	3.26
5	Large-scale Preparation of Single-stranded and Double-stranded Bacteriophage M13 DNA	3.30
6	Cloning into Bacteriophage M13 Vectors	3.33
7	Analysis of Recombinant Bacteriophage M13 Clones	3.39
	• Alternative Protocol: Screening Bacteriophage M13 Plaques by Hybridization	3.41
8	Producing Single-stranded DNA with Phagemid Vectors	3.42

### INFORMATION PANELS

Growth Times	3.49
Polyethylene Glycol	3.49

**R**ECOMBINANT FILAMENTOUS BACTERIOPHAGES are used to provide single-stranded copies of fragments of DNA cloned in other vectors. This approach is now commonly used in place of older physical and enzymatic techniques to separate the strands of segments of DNA. These single-stranded DNA fragments are used chiefly as templates for site-directed mutagenesis, sequencing of DNA fragments by the dideoxy chain-termination method, construction of subtractive cDNA libraries, and synthesis of strand-specific probes. Specialized M13 vectors can also be used for display of foreign peptides and proteins on the surface of the bacteriophage particles.

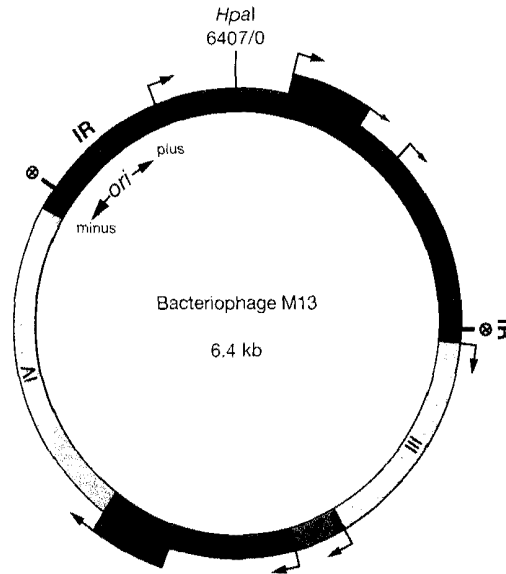
**THE DISCOVERY OF MALE-SPECIFIC BACTERIOPHAGES**

A search of New York City sewage (Loeb 1960) for viruses that grow only on male ( $F^+$  and Hfr) strains of *Escherichia coli* resulted in the isolation of seven types of bacteriophages (f1 through f7). Most of these bacteriophages turned out to be small, spherical viruses that contain RNA as their genetic material (Loeb and Zinder 1961). f1, although clearly different from the others in buoyant density and antigenic structure, was not immediately studied because it made turbid plaques that were difficult to detect and count. However, the initial report of male-specific bacteriophages inspired other groups to search for additional viruses with a sex-specific host range. From this work emerged the male-specific bacteriophages M13 (Munich 13) (Hofschneider 1963) and fd (Marvin and Hoffman-Berling 1963). Early electron micrographs of fd phages showed spheres embedded in a matrix of tangled fibrous material, which was at first thought to be pili that had detached from the bacterial cell wall. However, during extensive attempts to clean the bacteriophage preparations, infectivity always remained associated with these long flexible rod-like structures. The conclusion that these filaments were, in fact, the bacteriophages was strengthened by the observations (1) that high titers of infectious virus were always highly viscous and (2) that the infectivity was very sensitive to shearing forces. Chemical analysis showed that the filaments contained DNA whose base composition was not consistent with Watson-Crick base pairing. In addition, the DNA showed anomalous hydrodynamic properties that were not understood at the time but are now easily interpretable as those expected of circular and linear single-stranded DNA molecules.

**THE BIOLOGY OF FILAMENTOUS BACTERIOPHAGES**

M13 is a member of a family of filamentous bacteriophages with single-stranded DNA genomes ~6400 bases in length. The genomes of M13 and its two closest relatives fd and f1 are organized identically, and their particles are similar in size and shape. The DNAs of these bacteriophages have been completely sequenced (fd, Beck et al. 1978; M13, van Wezenbeek et al. 1980; f1, Beck and Zink 1981). More than 98% of their nucleotide sequences are identical; the few sites of differences are scattered around the genome, mostly in the third position of redundant codons (Beck and Zink 1981). M13, fd, and f1 actively complement and recombine with one another (Lyons and Zinder 1972) and may be regarded as identical for the purposes of the summary that follows. The genetic map of bacteriophage M13 is shown in Figure 3-1.

- M13 bacteriophages are filamentous particles that infect only male bacteria and do not lyse their hosts. Instead, they are released from infected cells even as the cells continue to grow and divide.
- During infection, the single-stranded bacteriophage genome is converted into a double-stranded, circular form called the replicative form (RF), which replicates as a Cairns or  $\theta$  structure. The RF molecules then generate single-stranded plus (+)-strand progeny DNA molecules by a rolling-circle mechanism. RF molecules are also templates for transcription of M13 genes, of which there are 11.
- Three of the viral gene products (pII, pV, and pX) are involved in the replication of the viral DNA and five virally coded transmembrane proteins (pIII, pVI, pVII, pVIII, and pIX) make up the capsid.
- Progeny particles are formed by a concerted process in which coat proteins are mustered into the bacterial membrane where they are assembled around the (+)-strand progeny DNA molecules. The protein-DNA complex is extruded from the cell in the form of a filamentous virus particle. These two processes, secretion and assembly of the filamentous virus particle, occur simultaneously in a coordinated manner. The viral gene products pI, pI\* (which is also known as pXI), and pIV are required for assembly of progeny bacteriophages, but do not become incorporated into particles.



**FIGURE 3-1 Genetic Map of Bacteriophage M13**

Wild-type M13 is a single-stranded circular DNA, 6407 nucleotides in length. The nucleotides are numbered from a unique *HpaI* site (van Wezenbeek et al. 1980). In the figure, the genes, which are all oriented in the same direction "clockwise," are numbered I to XI, the two intergenic regions are labeled IR, the major promoters are indicated with arrows, and the transcription terminators are marked with a cross in a circle. By convention, the viral DNA is called the (+) strand, which has the same sense as the viral mRNAs.

- All indispensable *cis*-acting elements of the M13 genome are sequestered into a 508-bp intergenic region, which has been cloned into plasmids. When cells transformed by these plasmids (or phagemids) are infected by a wild-type or mutant "helper" bacteriophage M13, single-stranded forms of the plasmid DNA are packaged into progeny particles.
- Because their genomes tend to be unstable, recombinant filamentous bacteriophages are not used for cloning and long-term propagation of segments of foreign DNA (please see Altling-Mees and Short 1993). Instead, they are used to provide single-stranded copies of fragments of DNA that have already been cloned in other vectors.

More than 90% of the bacteriophage M13 genome codes for protein products, and most of the 11 genes are separated by only a few nucleotides. The single-stranded genome encodes three classes of proteins: replication (pII, pV, and pX), morphogenetic (pI, pIV, and pXI), and structural (pIII, pVI, pVII, pVIII, and pIX) proteins. All structural proteins of the bacteriophage are inserted into the bacterial membrane prior to bacteriophage assembly (Endemann and Model 1995). For further details about the structures and functions of these proteins, please see Table 3-1.

A small noncoding region lies between genes VIII and III, whereas a more substantial noncoding region of 508 bp is located between genes II and IV. All of the vital *cis*-acting elements in the bacteriophage genome are condensed into this larger intergenic region, which contains sequences regulating packaging and orientation of the DNA within bacteriophage particles (Dotto et al. 1981b; Webster et al. 1981; Dotto and Zinder 1983), sites for the initiation and termination of synthesis of (+)-strand and minus (-)-strand DNA (please see Beck and Zink 1981; Dotto et al. 1983), and a signal for  $\rho$ -independent termination of transcription (see Konings and Schoenmakers 1978). Because these *cis*-acting elements are packed so tightly into a small region of DNA, they can easily be transferred en bloc to other types of cloning vehicles, such as plasmids.

TABLE 3-1 Summary of the Functions of Proteins Encoded by Bacteriophage M13

PROTEIN/ SIZE	FUNCTION
pI/348 residues	pI, which spans the inner membrane of M13-infected bacteria, interacts with the viral pIV and host-encoded thioredoxin and may also recognize the packaging signal in phage DNA, thereby initiating phage assembly. A smaller product, pXI, is produced by internal initiation of translation within the gene I transcript at methionine codon 241. pXI, which is also known as pI*, may be involved in forming the site for assembly of bacteriophage particles.
pII/410 residues	pII introduces a nick at a specific site in the intergenic region of the (+)-strand of RF DNA, initiating the rolling circle phase of replication, which generates (+)-strand progeny DNA molecules. pII also cleaves the single-stranded product of rolling circle replication into monomeric molecules that are packaged into progeny bacteriophage particles.
pIII/427 residues	pIII, a minor coat protein, is anchored to the membrane by a single membrane-spanning domain near the carboxyl terminus. As the M13 filament emerges from the infected cell, three to five copies of pIII are attached to the proximal tip of the bacteriophage particle. The proximal tip enters a new host first during infection and leaves the membrane last when progeny particles are extruded. pIII, which is associated with pVI at the proximal tip, is required for adsorption of the bacteriophage to the sex pili of new hosts and for penetration of the phage DNA. Fusion peptides in bacteriophage display libraries are located in the early mature region of pIII, near or immediately adjacent to the signal peptide cleavage site.
pIV/426 residues	pIV, a multimeric protein, may form a gated channel connecting the bacterial cytoplasm to the exterior. pIV, which is synthesized in large quantities in infected cells, interacts with pI and is required for the induction of the <i>E. coli psp</i> (phage shock protein) operon that occurs during M13 infection.
pV/87 residues	pV, an 87-amino-acid protein synthesized in large amounts in infected cells, binds strongly and in a cooperative manner to newly synthesized (+) strands. The resulting pV-DNA complexes move to specialized packaging sites on the bacterial membrane, where pV is stripped from the viral DNA and is recycled into the cell. In addition to DNA binding, pV also acts as a translational repressor by binding specifically to the leader sequences of viral mRNAs coding for gene II and other viral proteins. These two properties of pV work in combination to regulate both the expression and replication of the viral genome. When the intracellular concentration of pV reaches a critical level ( $10^5$ to $10^6$ molecules/cell/generation), the conversion of progeny (+) strands to double-stranded RF is suppressed, and the rolling circle phase of bacteriophage DNA replication therefore proceeds at an essentially constant pace.
pVI/112 residues	pVI is a minor coat protein of M13. A few molecules of pVI are located at the proximal end of the M13 filament, where they are associated with pIII. pVI is a membrane protein that is located in the cytoplasmic membrane before incorporation into virus particles.
pVII/33 residues	pVII is a coat protein that interacts with the packaging signal located in the intergenic region of M13 DNA. Five molecules of pVII are located at the end of the bacteriophage particle that emerges first from the infected cell.
pVIII/73 residues	pVIII, the major coat protein of M13, is synthesized as a preprotein known as "procoat," which binds to the inner surface of the plasma membrane and subsequently translocates as a loop structure across the membrane in the presence of a transmembrane potential. Particles of M13 contain ~2700 copies of the processed or mature 50-residue $\alpha$ -helical protein, arranged in a cylindrical sheath around the bacteriophage DNA.
pIX/32 residues	pIX is a minor coat protein of M13. Five copies of pIX are located at the end of the bacteriophage particle where assembly begins. Like pVII, pIX is a membrane protein that interacts with the packaging signal located in the intergenic region of M13 DNA.
pX	Translation of pX begins at the in-frame AUG triplet at codon 300 of pII. pX is therefore identical in sequence to the carboxy-terminal third of pII. pX, which is required for efficient accumulation of single-stranded DNA, is a powerful repressor of phage-specific DNA synthesis <i>in vivo</i> and is thought to limit the number of RF molecules in infected cells.
pXI (also known as pI*)	pXI, which spans the cytoplasmic membrane but lacks a cytoplasmic domain, is produced by internal initiation of translation within the gene I transcript at methionine codon 241. pXI may be involved in forming the site for assembly of bacteriophage particles.

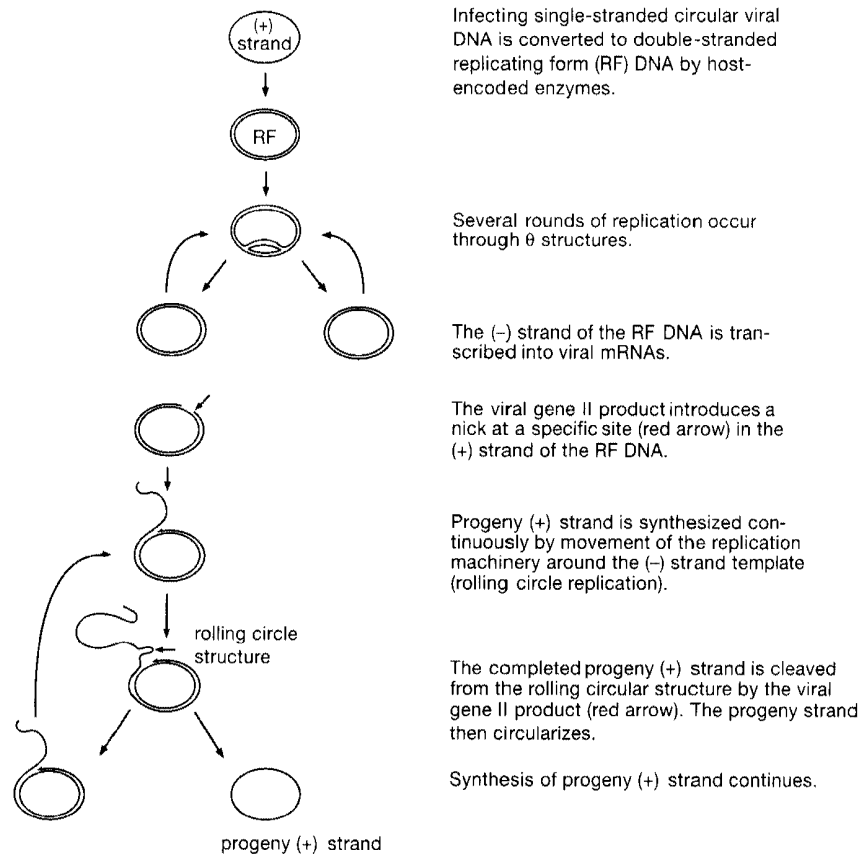
For references, please see reviews by Makowski (1984), Webster and Lopez (1985), Model and Russel (1988), and Russel (1991, 1995).

Bacteria transformed by these phage-plasmid hybrids (which are known as phagemids) produce single-stranded versions of the plasmid DNA when infected with helper wild-type or mutant filamentous bacteriophages carrying replication-defective intergenic regions. For further details, please see the introduction to Protocol 8, which deals with phagemids.

The filamentous particles of M13 infect only bacterial strains that express sex pili encoded by an F factor. Adsorption of the virus to the bacterial cell requires interaction between a sex pilus and the viral minor coat protein pIII, three to five copies of which are located at one end of the filamentous rod (please see Table 3-1). The following events then occur: As the rod-shaped virus penetrates the pilus, pIII interacts with the host TolQ, TolR, and TolA proteins, which (1) mediate removal of the major coat protein and (2) allow the viral DNA to penetrate into the body of the bacterium (Webster 1991).

- The infecting (+)-strand single-stranded DNA is then converted into a double-stranded circular form, called RF DNA. Synthesis of the (–) strand is initiated by a 20-nucleotide RNA primer that is synthesized at a unique site on the viral DNA by *E. coli* RNA polymerase (Geider and Kornberg 1974; Higashitani et al. 1993). Transcription of viral genes begins at any one of a series of promoters in RF DNA and proceeds unidirectionally to one of two terminators, which are located immediately downstream from genes VIII and IV. This organization of promoters and terminators leads to gradients of transcription in which genes located closest to a termination site (e.g., gene VIII) are transcribed much more frequently than genes further upstream (e.g., gene II) (for a review of this and other aspects of the molecular biology of filamentous bacteriophages, please see Model and Russel 1988; Russel 1995).
- Amplification of the viral genome begins when the protein product of gene II introduces a nick at a specific site in the (+) strand of the parental RF DNA (Meyer et al. 1979). *E. coli* DNA polymerase I then adds nucleotides to the free 3'-hydroxyl terminus, progressively displacing the original (+) strand from the circular (–)-strand template (please see Figure 3-2).
- After the replication fork has completed a full circle, the displaced (+) strand is cleaved by the gene II protein, generating a unit-length viral genome that is then circularized (Horiuchi 1980). During the first 15–20 minutes of infection, these progeny (+) strands are converted by cellular enzymes to closed circular RF DNA molecules, which serve as templates for further rounds of transcription and synthesis of additional (+) strands.
- By the time 100–200 copies of the RF DNA have accumulated in the infected cell, there is enough single-stranded DNA-binding protein (the product of gene V) to repress translation, inter alia, of gene II mRNA (Model et al. 1982; Yen and Webster 1982; Zaman et al. 1990) and to bind strongly and cooperatively to the newly synthesized (+) strands, thereby preventing their conversion to RF DNA. DNA synthesis therefore becomes dedicated almost exclusively to the production of progeny viral strands (Salstrom and Pratt 1971; Mazur and Zinder 1975). In addition, pX and pV are powerful repressors of phage-specific DNA synthesis and are thought to limit the number of RF molecules in infected cells (Fulford and Model 1984, 1988; Guilfoyle and Smith 1994). As a consequence, both the number of RF DNA molecules in the infected cell and the rate of production of progeny (+) strands are kept within moderate limits (Mazur and Model 1973; Lerner and Model 1981).

The morphogenesis of filamentous bacteriophage particles is extraordinary. Unlike most other bacterial viruses, progeny particles are not assembled intracellularly. Instead, morphogenesis and secretion occur in a concerted fashion, so that nascent virus particles are assembled as they cross the inner and outer bacterial membranes of the host cell. The intracellular pV–viral DNA complexes are compact, rod-like structures (Gray 1989) that associate with specific assembly sites in the bacterial membrane (Lopez and Webster 1983, 1985). The signal for packaging — an



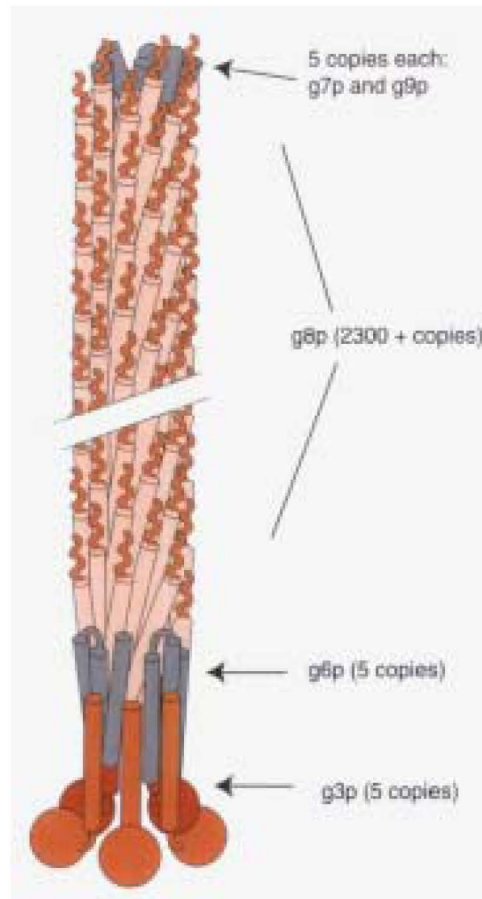
**FIGURE 3-2 Replication of Bacteriophage M13 DNA in Infected Bacteria**

The first four stages, up to the point where nicking of closed circular RF DNA begins, occur during the first 15–20 minutes of infection and result in the accumulation of 100–200 circular RF DNA molecules per cell. The subsequent production of single-stranded DNA is a continuous process that leads to morphogenesis of progeny particles.

inverted repeat located in the intergenic region of the bacteriophage DNA — protrudes from one end of the pV–viral DNA (Bauer and Smith 1988) and presumably initiates morphogenesis by interacting with the membrane-associated coat proteins, pVII and pIX. Assembly of virus particles is a repetitious process whereby the 1500 dimeric pV proteins are progressively removed from the (+) strand and replaced by capsid proteins as the nascent bacteriophage particle is extruded through the membranes of the infected cell. The finished viral filaments (illustrated in Figure 3-3), which are 100 times greater in length than in width, are extruded from the host cell without causing lysis or cell death (for reviews, please see Russel 1991, 1994, 1995).

Mature particles contain 5 of the 11 bacteriophage-encoded proteins (please see Table 3-1). At least four other proteins (pI, pIV, pXI, encoded by the virus, and thioredoxin, encoded by the host cell) are required for assembly and secretion.

Wild-type filamentous bacteriophages are long and flexible tubular structures, 880 nm in length and 6–7 nm in diameter (for reviews, please see Rasched and Oberer 1986; Russel 1991; Makowski 1994). A high-resolution X-ray crystallographic structure of the particles is not available, but models of the bacteriophage have been generated from fiber diffraction studies and solid-state nuclear magnetic resonance (NMR) (Opella et al. 1980; Banner et al. 1981; Glucksman et al. 1992; McDonnell et al. 1993; Marvin et al. 1994). The DNA at the core of the particles is coated by 2700 copies of an  $\alpha$ -helical 50-residue protein, which is encoded by gene VIII. The cap or distal end of the nascent bacteriophage cylinder extruded from the membrane consists of five



**FIGURE 3-3 Structural Model of an M13 Particle**

M13 is a filamentous bacteriophage of the family Inoviridae. The native particle is ~900 nm long and 6.5 nm in diameter and is composed of the single-stranded circular viral DNA encapsulated by ~2300 copies of the major coat protein, the product of phage gene 8 (g8p), plus five copies each of four minor proteins. The single-stranded bacteriophage DNA extends along the axis of the phage particle, with the length of the DNA determining both the length of and the number of g8p in the virus particle. The minor phage proteins g7p and g9p are involved in the initiation of assembly and are required for particle stability. g3p is a 42,000-dalton protein attached to the virus particle by g6p and is responsible for binding to host cells. (Courtesy of Lee Makowski and Matt Ray.)

copies each of pVII and pIX, which interact with the packaging signal in the intergenic region. The tail or proximal end of the completed cylinder consists of a complex of three to five copies of pVI and pIII.

Because the viral genome is not inserted into a preformed structure, there is no strict limit to the size of the single-stranded DNA that can be packaged. Rather, the length of the filamentous particle varies according to the amount of DNA it contains. Particles longer than unit length and containing multiple copies of the viral genome are found in stocks of all filamentous viruses (Salivar et al. 1967; Scott and Zinder 1967; Pratt et al. 1969), and inserts of foreign DNA seven times longer than the wild-type viral genome have been cloned and propagated in M13 (Messing 1981).

The replication of the filamentous bacteriophages occurs in harmony with that of the host bacterium, and the infected cells are therefore not lysed but continue to grow (albeit at one half to three quarters of the normal rate) while producing several hundred virus particles per cell per generation (Marvin and Hohn 1969). This production leads to the accumulation of vast numbers of particles in the medium; the titer of bacteriophage from a culture of infected bacteria frequently exceeds  $10^{12}$  pfu/ml.



## BACTERIOPHAGE M13 AS A VECTOR

Because single-stranded DNA is a poor substrate for most restriction endonucleases and DNA ligases, double-stranded segments of foreign DNA are inserted *in vitro* into the RF of the bacteriophage DNA (please see the panel on **ENGINEERING M13 AS A VECTOR**). This double-stranded closed circular DNA can easily be purified from infected cells, manipulated in the same way as plasmid DNA, and then reintroduced into cells by standard transformation procedures. The double-stranded DNA then reenters the replication cycle, eventually generating progeny bacteriophage particles that contain only one of the two strands of the foreign DNA. The other strand of the DNA, the (–) strand, is never packaged.

### ENGINEERING M13 AS A VECTOR

In 1963, when Peter-Hans Hofschneider described the isolation of Munich 13 from Bavarian sewage, the virus seemed to have few prospects. Indeed, research on M13 remained parochial until the early 1970s, when Joachim Messing, then a graduate student at the Max-Planck Institute in Munich, saw that the biological properties of the bacteriophage could be exploited for cloning and sequencing of foreign DNAs.

Messing reasoned that the length of the bacteriophage filaments reflected the size of the single-stranded DNA inside them. M13 might therefore be able to accommodate additional sequences of nonviral DNA in a manner that other single-stranded DNA viruses, such as the icosahedral  $\phi$ X174, could not. In addition, the single-stranded nature of the M13 genome made it ideal for use as a template in the recently described Sanger DNA sequencing method (Sanger et al. 1973). However, turning these properties into an advantage required solutions to some serious problems. In 1974, the restriction map of M13 was rudimentary, the locations of its genes were vague, and, worst of all for Messing, the restriction enzymes and DNA ligases required to solve these difficulties and to construct vectors were not commercially available. Messing (1991, 1993, 1996) has described in some detail the bootstrapping and borrowing that eventually allowed him to insert into M13 the genetic element that has been the key to the success of all subsequent vectors of the mp series: a 789-bp fragment of DNA encoding the control region of the wild-type *lac* operon and the first 146 amino acids of  $\beta$ -galactosidase. The resulting recombinant M13mp1 (for Max-Planck Institute), which carried the *lac* sequences inserted into a *Hae*III site in the intergenic region of the bacteriophage, was viable and expressed an  $\alpha$ -complementing fragment of  $\beta$ -galactosidase in infected cells (Messing et al. 1977; Gronenborn and Messing 1978).

Messing deliberately chose a strain of male host cells carrying an F' plasmid encoding a mutant of  $\beta$ -galactosidase lacking amino acids 11–41. This defective polypeptide can associate with the 146-residue amino-terminal fragment of  $\beta$ -galactosidase encoded by M13mp1 to form an enzymatically active protein. M13mp1 will therefore form deep-blue plaques when plated on hosts carrying the appropriate F' episome on medium containing IPTG (isopropyl- $\beta$ -D-thiogalactoside, a gratuitous inducer of the  $\beta$ -galactosidase gene) and X-gal (5-bromo-4-chloro-3-indolyl- $\beta$ -D-galactoside, a chromogenic substrate). (For additional historical details, please see the information panels on X-GAL and  $\alpha$ -COMPLEMENTATION in Chapter 1.) Insertion of foreign DNA into the *lacZ* region of M13mp1 usually eliminates  $\alpha$ -complementation and gives rise to recombinants that form pale blue or colorless plaques (Gronenborn and Messing 1978). Messing was therefore able to develop a histochemical test to distinguish between M13 recombinants that carried a piece of foreign DNA and empty vectors that did not.

Messing's next task was to equip the *lac* region of M13mp1 with restriction sites suitable for cloning. The *lac* fragment contained no useful restriction sites and few sequences that could be easily converted into one. During a trip to California, however, Messing learned that the chemical mutagen nitrosomethylurea would efficiently promote the conversion of guanine residues to thymine. Gronenborn and Messing (1978) therefore treated M13mp1 with nitrosomethylurea and screened for infectious RF molecules that were linearized by *Eco*RI. In this way, they were able to isolate a bacteriophage (M13mp2) that carried an *Eco*RI site at codon six of the  $\beta$ -galactosidase gene as a consequence of a G to T transition. Messing quickly realized that in-frame insertions of synthetic linkers into the newly created *Eco*RI site retained their ability to synthesize an  $\alpha$ -complementing fragment of  $\beta$ -galactosidase in infected cells. This observation was turned to great advantage during the course of the succeeding 15 years, when Messing and his co-workers equipped a succession of mp vectors with a wide variety of multiple cloning sites (e.g., please see Messing 1979; Messing et al. 1981; Yanisch-Perron et al. 1985; Vieira and Messing 1987, 1991). These embellishments, combined with an already powerful set of biological properties, provided M13 vectors with decisive practical advantages for site-directed mutagenesis, subtractive hybridization, and shotgun DNA sequencing.

Three types of M13 vectors have been described that differ in the location of the cloning site:

- **Cloning into the large intergenic region:** All genes of filamentous bacteriophages are essential, and vectors must therefore carry a full complement of coding sequences. However, segments of foreign DNA may be inserted into the 508-bp intergenic region located between genes II and IV (Messing et al. 1977; Gronenborn and Messing 1978). Insertion of foreign DNA segments within this intergenic region can severely affect the replication of the bacteriophage genome (Dotto and Zinder 1984a). Fortunately, most vectors used to clone foreign DNA sequences carry mutations (in gene II or V) that partially compensate for the disruption of the *cis*-acting elements (Dotto and Zinder 1984b).

A majority of vectors in current use adhere closely to the theme established by the M13mp series, differing chiefly in the number and variety of restriction sites that can accept DNA fragments. Typically, M13 vectors appear as pairs (e.g., M13mp18 and M13mp19) that vary only in the orientation of the nonsymmetrical polycloning region within the *lacZ* region. After cleavage of the RF DNAs with two different restriction enzymes, M13mp18 and M13mp19 cannot recircularize easily unless a double-stranded foreign DNA fragment with compatible termini is present in the ligation mixture. This fragment will be inserted in opposite orientations in the two vectors. Thus, one of the two strands of the fragment will be attached to the (+) strand of M13mp18, and the complementary strand will be attached to the (+) strand of M13mp19. The progeny of the M13mp18 recombinant will therefore contain one strand of the foreign DNA, and the progeny of the M13mp19 recombinant will contain the other (complementary) strand. Consequently, by using M13mp18 and M13mp19 as dual vectors, it is possible to use a single primer ("universal primer") to determine the sequence of nucleotides on opposite strands from each end of the inserted DNA and to generate probes that are complementary to only one strand or the other of the foreign DNA.

The *lacZ* fragments used in the construction of bacteriophage M13 vectors have also been inserted into a deleted version of pBR322, creating a family of plasmid vectors (pUC vectors) that contain a variety of commonly used cloning sites. These vectors are especially useful because they (1) can participate in  $\alpha$ -complementation and (2) carry the same constellation of restriction sites in the polycloning site as the analogous vectors of the mp series. Thus, fragments of foreign DNA can be moved between M13mp vectors and pUC vectors with great ease. In addition, the intergenic region of M13 is now a standard fixture of most plasmid vectors, which can therefore be used as conventional plasmids or as phagemids.

The original *lacZ* fragment carried in the mp series of M13 vectors and in pUC plasmids is derived from the wild-type *lac* operon and does not carry the *uv5* mutation and is therefore sensitive to catabolite repression.

- **Cloning into the small intergenic region:** The smaller intergenic region between genes VIII and III has also served as the cloning site for another series of vectors (Barnes 1979, 1980). In addition, a number of vectors carry other selectable markers (antibiotic resistance; *hisD*) that may be destroyed by insertion of a foreign DNA sequence (e.g., please see Barnes 1979; Herrmann et al. 1980; Zacher et al. 1980). Unfortunately, these systems require the establishment of colonies of infected cells that must be screened by replica plating, a much slower and more tedious process than visual examination of plaques.
- **Cloning into gene X:** If overproduced, gene X protein completely blocks phage-specific DNA synthesis (Fulford and Model 1988). A bacteriophage vector called M13-100 carries a super-

numerary copy of gene X in the large intergenic region of M13 (Guilfoyle and Smith 1994). Expression of the gene is driven by the T7 promoter and therefore occurs only in host cells, such as JM109(DE), that express T7 RNA polymerase. When foreign DNA sequences are cloned into the supernumerary copy of gene X, the gene is inactivated and the resulting recombinants can therefore replicate on JM109(DE) cells, which, of course, are nonpermissive hosts for empty vectors. This elegant system, which was developed to reduce the cost and manual labor of screening large numbers of plaques by histochemical staining, has not been widely adopted.

## BACTERIAL HOSTS FOR BACTERIOPHAGE M13 VECTORS

Because M13 enters the host cell through sex pili encoded by an F factor, only male bacteria are used to propagate the virus. Infections can be established in female cells if the bacteriophage DNA is introduced by transfection. However, the progeny particles produced by the transfected cells are unable to infect other cells in the culture, and the yields of virus are consequently very low.

Bacterial strains carrying F' plasmids and a number of genetic markers useful in work with M13 vectors have been constructed by Messing and his co-workers (Yanisch-Perron et al. 1985). The following are the most important of these markers:

- **lacZ $\Delta$ M15:** A deletion mutant that lacks the sequences of the *lacZ* gene coding for the amino-terminal portion of  $\beta$ -galactosidase (Beckwith 1964). The peptide expressed by  $\Delta$ M15 can take part in  $\alpha$ -complementation (Ullmann et al. 1967; Ullmann and Perrin 1970). Many hosts for bacteriophage M13 vectors carry this deleted version of the *lacZ* gene on an F' plasmid.
- **$\Delta$ (lac-proAB):** A deletion of the chromosomal segment that spans the *lac* operon and neighboring genes coding for enzymes involved in proline biosynthesis. Bacterial hosts carrying this marker are unable to use lactose as a carbon source and require proline for growth, unless *proAB* is present on an F' plasmid.
- **lacI<sup>q</sup>:** A mutant of the *lacI* gene that synthesizes approximately tenfold more repressor than wild type (Müller-Hill et al. 1968). This overproduction of repressor suppresses still further the already low level of transcription of the *lac* operon in the absence of inducer. Thus, synthesis of potentially toxic proteins is minimized when foreign coding sequences are placed under the control of the *lacZ* promoter in cells carrying a *lacI<sup>q</sup>* mutation. When the host cells carrying a *lacI<sup>q</sup>* mutation are grown in glucose, catabolite repression reduces the level of transcription across the intergenic region from the *lacZ* promoter, and so potentiates the production of single-stranded DNA. In most of the strains used in cloning with M13 vectors, *lacI<sup>q</sup>* is carried with *lacZ $\Delta$ M15* (see above) on an F' plasmid.
- **proAB:** The region of the bacterial chromosome that encodes enzymes involved in proline biosynthesis. The *proAB* genes are often carried on an F' plasmid, which can then complement proline prototrophy in a host with a (*lac-proAB*) deletion. When such cells are grown in media lacking proline, the maintenance of the F' plasmid in the host can be guaranteed.
- **traD36:** A mutation that suppresses conjugal transfer of F factors (Achtman et al. 1971). This marker was required by the National Institutes of Health (NIH) guidelines that were extant many years ago. The guidelines are no longer in force, but the marker lingers on in several of the bacterial strains dating from that era.
- **hsdR17 and hsdR4:** Mutations that lead to loss of restriction, but not modification, by the type I restriction/modification system of *E. coli* strain K. Unmodified DNA cloned directly into M13 vectors and propagated in bacterial strains carrying this mutation will be modified and therefore protected against restriction if the vector is subsequently introduced into an *hsd<sup>+</sup>* strain of *E. coli* K.

- **mcrA and mrr:** Mutations that lead to loss of restriction of methylated DNA and therefore enhance the cloning of genomic DNA in bacteriophage M13 vectors.
- **recA1:** The *recA* gene of *E. coli* codes for a DNA-dependent ATPase that is essential for genetic recombination in *E. coli* (for review, please see Radding 1982). Strains that carry the *recA1* mutation are defective in recombination and therefore have two advantages. First, plasmids propagated in these strains remain as monomers and do not form multimeric circles (Bedbrook and Ausubel 1976). Second, segments of foreign DNA propagated in M13 vectors may experience fewer deletions in *recA*<sup>-</sup> strains (Yanisch-Perron et al. 1985).
- **supE:** An amber suppressor that inserts glutamine at UAG codons. At one time, the NIH guidelines required bacteriophage M13 vectors to carry an amber mutation. This requirement has long since been dropped, and most vectors in common use today do not carry such mutations. However, many of the strains of *E. coli* that are used as hosts were developed when the guidelines were still in force. These strains and many of their derivatives carry a suppressor that allows the growth of vectors carrying certain amber mutations.

Table 3-2 contains a summary of strains of *E. coli* commonly used to propagate M13 vectors and recombinants, and Figure 3-4 displays the polycloning sites in many vectors.

## CHOOSING AND MAINTAINING A SUITABLE STRAIN OF *E. COLI*

As mentioned above, infection of *E. coli* by bacteriophage M13 and its close relatives requires an intact F pilus. To ensure that bacteria used for propagating bacteriophage M13 maintain the F' plasmid encoding the pilus structure, one of two positive selection strategies may be used:

- In all strains of *E. coli* commonly used for propagation of male-specific bacteriophages, the F' plasmid carries genes encoding enzymes involved in proline biosynthesis (*proAB*<sup>+</sup>). Because these genes have been deleted from the host chromosome, only those bacteria that carry the F' plasmid will be proline prototrophs and hence be able to form colonies on media lacking proline (e.g., M9 minimal medium). Bacterial strains grow much more slowly on minimal media than on rich media and do not survive prolonged periods of storage at 4°C. For this reason, it is important to prepare fresh cultures of host bacteria every few days on M9 minimal agar plates, using a master stock stored at -70°C as inoculum (please see below).
- Some but not all F' plasmids carry a gene encoding resistance to an antibiotic, usually kanamycin or tetracycline. Only cells that maintain the F' plasmid will grow in media containing the appropriate antibiotic. Using this selection eliminates the need to use minimal media, thereby greatly speeding the work of the laboratory.

Whatever the selection used to maintain the F' plasmid, master stocks of F' strains of *E. coli* used for propagation and plating of M13 should be stored at -70°C in LB medium containing 15% glycerol. The choice of bacterial strain should, however, not be dictated by the type of selection used to maintain the F' plasmid. Of much greater importance are the chromosomal markers carried by the strain, which can greatly influence the stability and yield of M13 recombinants and the purity of the single-stranded DNA templates prepared from infected cells. The following are two types of strain-dependent problems commonly encountered when cloning in filamentous bacteriophage vectors:

- **Deletion of part of the foreign DNA segment.** DNA cloned into the intergenic region of filamentous bacteriophages tends to be unstable. The larger the cloned segment, the greater the rate at which deletions occur. This problem can be minimized (although never completely

TABLE 3-2 Bacterial Strains Used to Propagate Bacteriophage M13 Vectors

PHENOTYPE	RELEVANT GENOTYPE	STRAIN	USES	REFERENCE
	<i>supE</i> $\Delta(lac-proAB)$ <i>F' traD36 proAB<sup>+</sup> lacI<sup>q</sup></i> <i>lacZ</i> $\Delta$ M15	JM101 <sup>a</sup>	permissive for vectors carrying amber mutations	Messing (1979)
r <sub>k</sub>	<i>supE</i> $\Delta(lac-proAB)$ <i>hsdR4</i> <i>F' traD36 proAB<sup>+</sup> lacI<sup>q</sup></i> <i>lacZ</i> $\Delta$ M15	JM105	permissive for vectors carrying amber mutations; will modify but not restrict transfected DNA	Yanisch-Perron et al. (1985)
r <sub>k</sub> <sup>-</sup>	<i>supE</i> $\Delta(lac-proAB)$ <i>hsdR17</i> <i>F' traD36 proAB<sup>+</sup> lacI<sup>q</sup></i> <i>lacZ</i> $\Delta$ M15	JM107 <sup>b</sup>	permissive for vectors carrying amber mutations; will modify but not restrict transfected DNA	Yanisch-Perron et al. (1985)
r <sub>k</sub> <sup>-</sup> Rec <sup>-</sup>	<i>supE</i> $\Delta(lac-proAB)$ <i>hsdR17</i> <i>recA1</i> <i>F' traD36 proAB<sup>+</sup> lacI<sup>q</sup></i> <i>lacZ</i> $\Delta$ M15	JM109 <sup>b,c</sup>	permissive for vectors carrying amber mutations; will modify but not restrict transfected DNA RecA <sup>-</sup> strain	Yanisch-Perron et al. (1985)
r <sub>k</sub> <sup>-</sup> Dam <sup>-</sup>	<i>supE</i> $\Delta(lac-proAB)$ <i>hsdR17</i> <i>dam</i> <i>F' traD36 proAB<sup>+</sup> lacI<sup>q</sup></i> <i>lacZ</i> $\Delta$ M15	JM110	permissive for vectors carrying amber mutations; will modify but not restrict transfected DNA; will not modify <i>BclI</i> sites	Yanisch-Perron et al. (1985)
r <sub>k</sub> <sup>-</sup> r <sub>m</sub> <sup>-</sup>	<i>supE</i> $\Delta(lac-proAB)$ <i>hsd</i> $\Delta$ 5 <i>F' traD36 proAB<sup>+</sup> lacI<sup>q</sup></i> <i>lacZ</i> $\Delta$ M15	TG1	permissive for vectors carrying amber mutations; will not modify or restrict transfected DNA	Gibson (1984)
r <sub>k</sub> <sup>-</sup> r <sub>m</sub> <sup>-</sup> Rec <sup>-</sup>	<i>supE</i> $\Delta(lac-proAB)$ <i>hsd</i> $\Delta$ 5 $\Delta(srI-recA)306::Tn10(tetr)$ <i>F' traD36 proAB<sup>+</sup> lacI<sup>q</sup></i> <i>lacZ</i> $\Delta$ M15	TG2	permissive for vectors carrying amber mutations; will not modify or restrict transfected DNA; RecA <sup>-</sup> strain	M. Biggin (pers. comm.)
(Tet <sup>r</sup> ) r <sub>k</sub> Rec <sup>-</sup>	<i>supE<sup>+</sup> lac<sup>-</sup> hsdR17 recA1</i> <i>F' ProAB<sup>+</sup> lacI<sup>q</sup> lacZ</i> $\Delta$ M15 <i>Tn10 (Tet<sup>r</sup>)</i>	XL1-Blue	permissive for vectors carrying amber mutations; will modify but not restrict transfected DNA; RecA <sup>-</sup> strain	Bullock et al. (1987)
	$\Delta(lac-proAB)$ <i>F' traD36 proAB<sup>+</sup> lacI<sup>q</sup></i>	XS127	used for growth of phagemids	Levinson et al. (1984)

$r_k^-$ Rec <sup>-</sup> Kan <sup>r</sup>	<i>hsdR recA1</i> F' <i>kan</i>	XSI01	used for growth of phagemids; will modify but not restrict transfected DNA; RecA <sup>-</sup> strain; carries episome conferring resistance to kanamycin	Levinson et al. (1984)
	<i>supE Δ(lac-proAB)</i> F' <i>ProAB<sup>+</sup> lacI<sup>q</sup> lacZΔM15</i>	71/18	used for growth of phagemids	Dente et al. (1983)
$r_k^-$	<i>supE Δ(lac-proAB) hsdR4</i> F' <i>traD36 proAB<sup>+</sup> lacI<sup>q</sup> lacZΔM15</i>	KK2186	permissive for vectors carrying amber mutations; will modify but not restrict transfected DNA	Zargusky and Berman (1984)
Rec <sup>-</sup>	<i>Δ(lac-proAB) Δ(stl-recA)</i> 306::Tn10( <i>tet<sup>r</sup></i> ) ( $\phi$ 80 <i>lacZΔM15</i> ) F' <i>traD36 proAB<sup>+</sup> lacI<sup>q</sup> lacZΔM15</i>	MV1184 <sup>d</sup>	used to propagate pUC118/pUC119; used to obtain single-stranded copies of phagemids; RecA <sup>-</sup> strain	Vieira and Messing (1987)
Mcr <sup>-</sup>	<i>supE Δ(lac-proAB)</i> <i>Δ(mcrB-hsdSM)5</i> F' <i>proAB lacI<sup>q</sup> lacZΔM15</i>	NM522	used for growth of phagemids; enhanced cloning of methylated genomic DNA	Gough and Murray (1983)
$r_k^- r_m^-$ Rec <sup>-</sup> Mcr <sup>-</sup>	<i>Δ(lac-pro AB)Δ(recA</i> 1398) <i>Δ(mrr-hsd RMS-mcrBC</i> <i>mcrA deoR rpsL</i> <i>srI<sup>-</sup>)</i> F' <i>proAB lacI<sup>q</sup> lacZΔM15</i>	DH115	used for growth of phagemids; RecA <sup>-</sup> strain; enhanced cloning of methylated genomic DNA; enhanced uptake of large plasmids	Lin et al. (1992)
$r_k^- r_m^-$ Rec <sup>-</sup> Mcr <sup>-</sup>	<i>supE recA1</i> <i>Δ(mcrA)183 Δ(mcr CB<sup>-</sup></i> <i>hsd SMR-mrr)173</i> F' <i>proAB lacI<sup>q</sup> lacZΔM15</i> Tn10( <i>tet<sup>r</sup></i> )	XLI-Blue MRF <sup>r</sup>	used for growth of phagemids; RecA <sup>-</sup> strain; enhanced cloning of methylated genomic DNA	Jerpseth et al. (1992)

<sup>a</sup>JM103 (Messing et al. 1981) is a restrictionless derivative of JM101 that has been used to propagate bacteriophage M13 recombinants. However, some cultivars of JM103 have lost the *hsdR4* mutation (Felton 1983) and are lysogenic for bacteriophage P1 (which codes for its own restriction/modification system). JM103 is therefore no longer recommended as a host for bacteriophage M13 vectors. Strain KK2186 (Zargusky and Berman 1984) is genetically identical to JM103 except that it is nonlysogenic for bacteriophage P1.

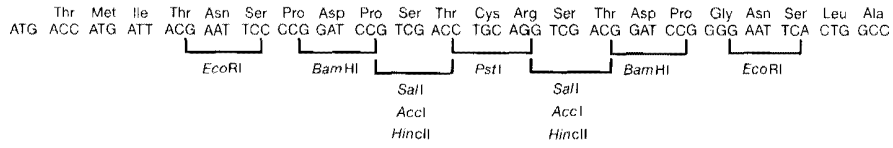
<sup>b</sup>JM106 and JM108 are identical to JM107 and JM109, respectively, except that they do not carry an F' episome. These strains will not support the growth of bacteriophage M13 but may be used to propagate plasmids. However, JM106 and JM108 do not carry the *lacI<sup>q</sup>* marker (normally present on the F' episome) and are therefore unable effectively to suppress the synthesis of potentially toxic products encoded by foreign DNA sequences cloned into plasmids carrying the *lacZ* promoter.

<sup>c</sup>JM108 and JM109 are defective for synthesis of bacterial cell walls and form mucoid colonies on minimal media. This trait does not affect their ability to support the growth of bacteriophage M13.

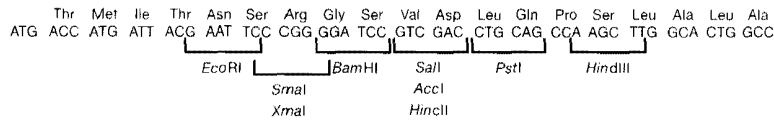
<sup>d</sup>The original strain of MV1184, constructed by M. Volkert (pers. comm.), did not carry an F' episome. However, the strain of MV1184 distributed by the Messing laboratory clearly carries an F' episome. It is therefore advisable to check strains of MV1184 on their arrival in the laboratory for their ability to support the growth of male-specific bacteriophages.

3.14 Chapter 3: Working with Bacteriophage M13 Vectors

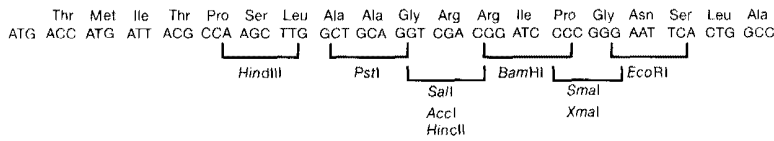
M13mp7/pUC7  
7237/2674



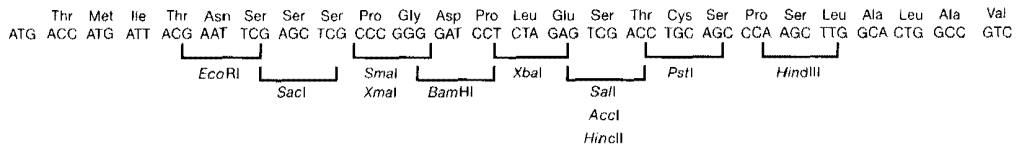
M13mp8/pUC8  
7237/2674



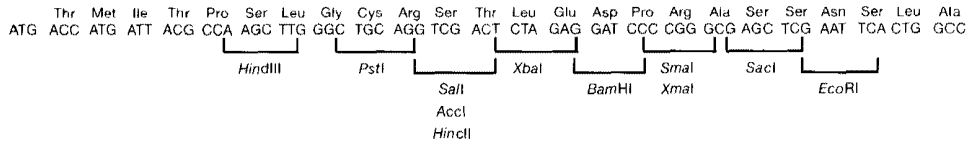
M13mp9/pUC9  
7598/2665



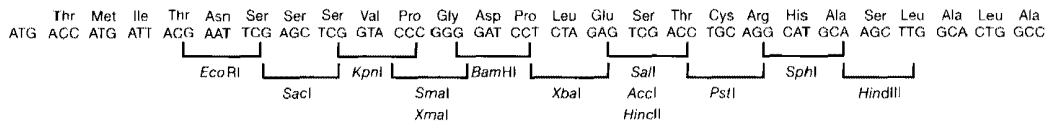
M13mp10/pUC12  
7243/2680



M13mp11/pUC13  
7243/2680



M13mp18/pUC18  
7249/2686



M13mp19/pUC19  
7249/2686

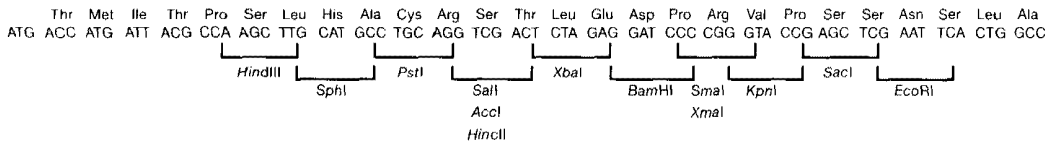
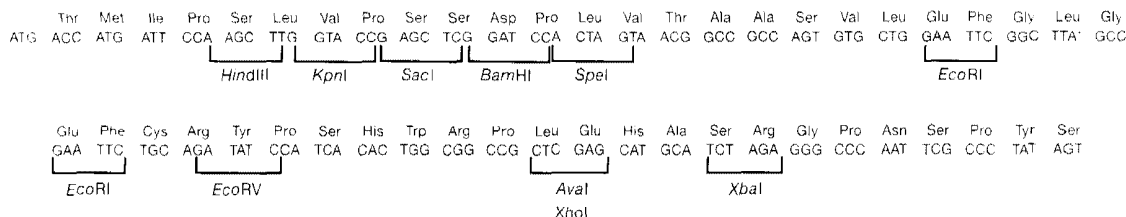


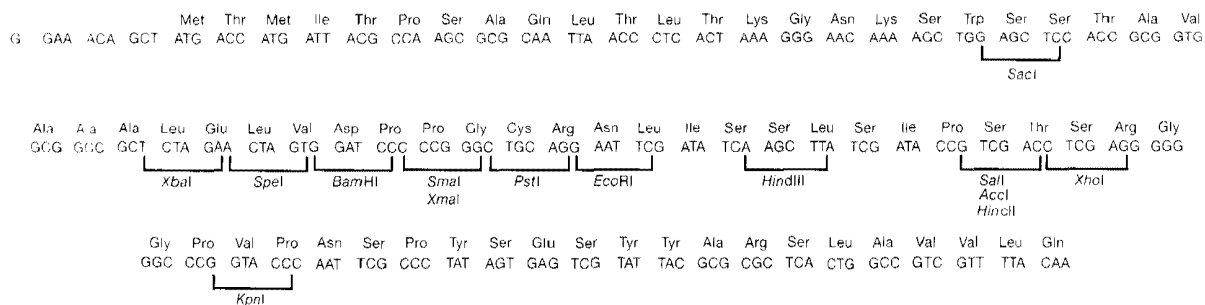
FIGURE 3-4 Multiple Cloning Sites in Bacteriophage M13 and Phagemid Vectors

Shown are the positions of restriction sites in the multiple cloning sites of commonly used bacteriophage M13 vectors and their corresponding pUC plasmids. The numbers beneath the names of the vectors are their approximate sizes (in nucleotides). The polycloning regions of the corresponding phagemids are virtually identical.

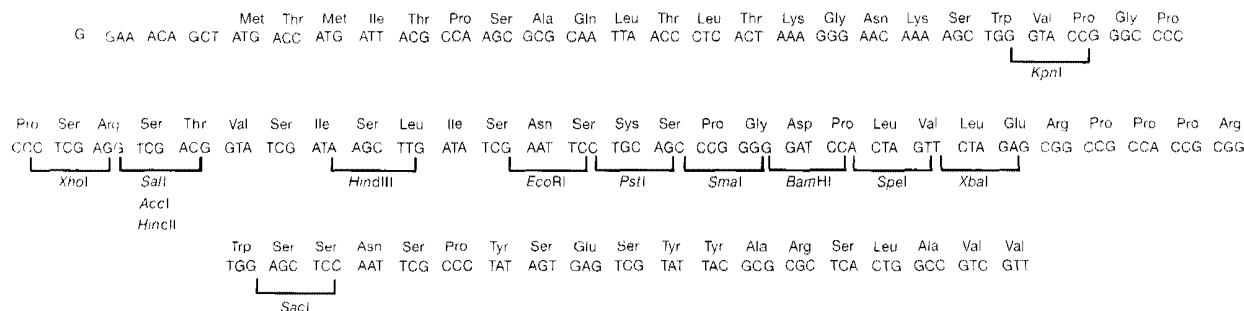
pCR 2.1  
3900



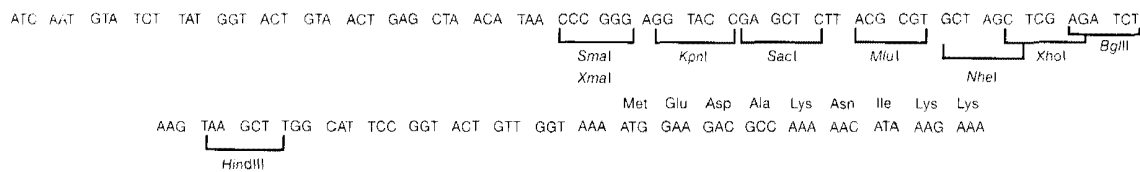
pBluescript II SK (+/-)  
2961



pBluescript II KS (+/-)  
2961



pGL2  
5789



pGal  
7486

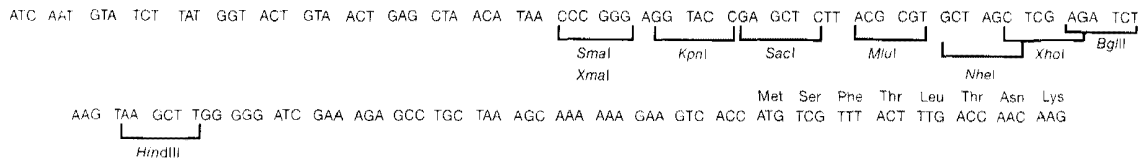


FIGURE 3-4 (See facing page for legend.)



eliminated) (1) by using strains of bacteria that carry *recA* mutations and (2) taking care never to propagate the bacteriophage by serial growth of infected cells in liquid culture. Instead, stocks of recombinant bacteriophages stored at  $-70^{\circ}\text{C}$  should be plated on an appropriate host, and bacteria from the center of a single well-isolated plaque should be used to establish a small-scale culture. This culture should provide sufficient quantities of single-stranded DNA or double-stranded RF DNA for most purposes. The culture should be grown for the shortest possible time (usually 4–8 hours, depending on the vector and the strain of *E. coli*) and should not be used as a stock to seed further cultures. Please see the information panel on **GROWTH TIMES**.

- **Insertion of the foreign DNA in only one orientation.** Quite frequently, a given vector will carry a specific segment of foreign DNA far more readily in only one of the two possible orientations. This phenomenon occurs because sequences on opposite strands of the foreign DNA interfere to different extents with the functioning of the vector's intergenic region. This problem can sometimes be avoided by inserting the foreign DNA at a different site within the polycloning site, by changing hosts strains, or by using a combination of restriction enzymes that allow directional cloning. However, if bacteriophage M13 vectors are forced to propagate unwelcome sequences of foreign DNA, the resulting recombinants are often unstable and give rise to progeny that carry deleted or rearranged versions of the foreign sequences. Under these circumstances, a better alternative is to propagate the foreign DNA in plasmid vectors that carry an origin of replication derived from a filamentous bacteriophage. Vectors of this type (phagemids) are discussed in detail in the introduction to Protocol 8. For the moment, however, it is worthwhile pointing out that phagemids are not a universal panacea: The quantities of single-stranded DNA produced by phagemids vary from one host strain to another and are often low.

In summary, the yield and stability of recombinants constructed in bacteriophage M13 and phagemid vectors are influenced by several variables: the structure and size of the foreign DNA, the type of vector, and the properties of the host strain, including its efficiency of transformation and ability to produce high yields of single-stranded DNA. The best course of action, therefore, is to try several combinations of vector and host cell. Start by using standard host strains such as TG1 or XL1-Blue. If problems arise, switch to a host cell such as DH11S that contains several additional genetic markers (please see Table 3-2). DH11S carries mutations in (1) the *recA* gene to enhance stability of inserts, (2) the restriction systems that attack methylated mammalian genomic DNA, and (3) the *deo<sup>r</sup>* gene that increases the efficiency of transformation by larger plasmids (Lin et al. 1992).

In this chapter, we describe methods for the propagation of bacteriophage M13, the uses of bacteriophage M13 vectors, the preparation of double-stranded DNAs from infected cells and single-stranded DNAs from virus particles, and methods to characterize bacteriophage recombinants. Methods for the use and propagation of phagemids complete the chapter.

*Once upon a time an honest fellow had the idea that men drowned in water only because they were possessed with the idea of gravity. If they were to knock this idea out of their heads, say by stating it a superstition, a religious idea, they would be sublimely resilient against any danger from water. His whole life long he fought against the illusion of gravity, of whose harmful results all statistics brought him new and manifold evidence.*

Karl Marx, preface to *The German Ideology* (Vol I. 1845–1846)

# Protocol 1

---

## Plating Bacteriophage M13

**A** PLAQUE OF BACTERIOPHAGE M13 DERIVES FROM INFECTION of a single bacterium by a single virus particle. The progeny particles infect neighboring bacteria, which in turn release another generation of daughter virus particles. If the bacteria are growing in semisolid medium (e.g., containing agar or agarose), then the diffusion of the progeny particles is limited. Because cells infected with bacteriophage M13 have a longer generation time than uninfected *E. coli*, plaques appear as areas of slower-growing cells on a faster-growing lawn of bacterial cells. Bacteriophage M13 plaques are therefore turbid, in contrast to the clear plaques of viruses such as the T bacteriophages that lyse the bacterial host. Very clear “plaques” are most likely to be small air bubbles trapped in the soft agar during mixing prior to plating.

Minimal (M9) agar plates can be used to advantage for plaque formation by bacteriophage M13. Not only are plaques formed on minimal media easier to see than those on richer media, but infected cultures established from a plaque formed on minimal medium are unlikely to contain a significant number of female cells. Plaques formed on richer medium (YT or LB) may be overgrown by auxotrophic female cells that are resistant to infection by bacteriophage M13. Fortunately, the danger is slight since the spontaneous loss of F' plasmids from bacteria grown for a limited period in rich medium is rarely high enough to cause problems. Because plaques form more rapidly on richer medium than on minimal medium, we recommend that YT or LB medium be used for routine plating of bacteriophage M13 stocks.

Bacteriophage M13 can be propagated by infecting a susceptible strain of *E. coli* and plating the infected cells in soft agar. After 4–8 hours, “plaques,” or zones of slowed cellular growth, are readily detectable in the top agar. Infection is carried out with either a bacteriophage stock or freshly picked plaques and freshly grown colonies of the appropriate strain of *E. coli*.

## MATERIALS

---

**CAUTION:** Please see Appendix 12 for appropriate handling of materials marked with <!>.

### Buffers and Solutions

Please see Appendix 1 for components of stock solutions, buffers, and reagents. Dilute stock solutions to the appropriate concentrations.

*IPTG solution (20% w/v)*

*X-gal solution (2% w/v) <!>*

### Media

*LB agar plates containing tetracycline or kanamycin*

These plates are needed only if a tetracycline-resistant strain of *E. coli*, such as XL1-Blue, or a kanamycin-resistant strain of *E. coli*, such as XL1-Blue MRF' Kan, is used to propagate the virus.

or

*Supplemented M9 minimal agar plates*

When using *E. coli* strains that carry a deletion of the proline biosynthetic operon ( $\Delta[lac-proAB]$ ) in the bacterial chromosome and the complementing *proAB* genes on the F' plasmid, use supplemented M9 minimal medium.

*LB or YT medium*

*LB or YT medium agar plates containing 5 mM MgCl<sub>2</sub>*

*LB or YT medium top agar or agarose containing 5 mM MgCl<sub>2</sub>*

The addition of Mg<sup>2+</sup> (5 mM) to media (Reddy and McKenney 1996) is reported to improve the yield of bacteriophage M13 cultures infected at low multiplicity.

### Special Equipment

*Heating block or water bath preset to 47°C*

*Ice-water bath*

### Vectors and Bacterial Strains

*Bacteriophage M13 stock in LB or YT medium*

or

*Bacteriophage M13 plaque in 1 ml of LB or YT medium*

Medium from a fully grown liquid culture of bacteria infected with bacteriophage M13 contains between 10<sup>10</sup> and 10<sup>12</sup> pfu/ml. A bacteriophage M13 plaque contains between 10<sup>6</sup> and 10<sup>8</sup> pfu.

*E. coli F' strain, prepared as a master culture*

Preparation of a master culture is described in Chapter 1, Protocol 1. For a list of *E. coli* strains suitable for the propagation of bacteriophage M13, please see Table 3-2 in the introduction to this chapter.

## METHOD

---

1. Streak a master culture of a bacterial strain carrying an F' plasmid onto either a supplemented minimal (M9) agar plate or an LB plate containing tetracycline (XL1-Blue) or kanamycin (XL1-Blue MRF' Kan). Incubate the plate for 24–36 hours at 37°C.
2. To prepare plating bacteria, inoculate 5 ml of LB or YT medium in a 20-ml sterile culture tube with a single, well-isolated colony picked from the agar plate prepared in Step 1. Agitate the culture for 6–8 hours at 37°C in a rotary shaker. Chill the culture in an ice bath for 20 minutes and then store it at 4°C. These plating bacteria can be stored for periods of up to 1 week at 4°C.

▲ **IMPORTANT** Do not grow the cells to saturation, as this will increase the risk of losing the pili encoded by the F' plasmid.

3. Prepare sterile tubes (13 × 100 mm or 17 × 100 mm) containing 3 ml of melted LB or YT medium top agar or agarose, supplemented with 5 mM MgCl<sub>2</sub>. Allow the tubes to equilibrate to 47°C in a heating block or water bath.
4. Label a series of sterile tubes (13 × 100 mm or 17 × 100 mm) according to the dilution factor and amount of bacteriophage stock to be added (please see Step 5), and deliver 100 µl of plating bacteria from Step 2 into each of these tubes.
5. Prepare tenfold serial dilutions (10<sup>-6</sup> to 10<sup>-9</sup>) of the bacteriophage stock in LB or YT medium. Dispense 10 µl or 100 µl of each dilution to be assayed into a sterile tube containing plating bacteria from Step 4. Mix the bacteriophage particles with the bacterial culture by vortexing gently.

Unlike bacteriophage λ, M13 adsorbs rapidly to bacteria; there is thus no need to incubate the plating bacteria with the bacteriophage suspension before adding top agar.
6. Add 40 µl of 2% X-gal solution and 4 µl of 20% IPTG solution to each of the tubes containing top agar. Immediately pour the contents of one of these tubes into one of the infected cultures. Mix the culture with the agar/agarose by gently vortexing for 3 seconds, and then pour the mixture onto a labeled plate containing LB or YT agar medium supplemented with 5 mM MgCl<sub>2</sub> and equilibrated to room temperature. Swirl the plate gently to ensure an even distribution of bacteria and top agar.

Work quickly so that the top agar spreads over the entire surface of the agar before it sets.
7. Repeat the addition of top agar with X-gal and IPTG for each tube of infected culture prepared in Step 5.
8. Replace the lids on the plates and allow the top agar/agarose to harden for 5 minutes at room temperature. Wipe excess condensation off the lids with Kimwipes. Invert the plates and incubate them at 37°C.

Pale blue plaques begin to appear after 4 hours. The color gradually intensifies as the plaques enlarge. Development of both plaques and color is complete after 8–12 hours of incubation. The blue color will intensify further if the plates are placed for several hours at 4°C or examined against a canary yellow background.

# Protocol 2

---

## Growing Bacteriophage M13 in Liquid Culture

**S**TOCKS OF BACTERIOPHAGE M13 ARE USUALLY GROWN in liquid culture. The infected bacteria do not lyse but instead grow at a slower than normal rate to form a dilute suspension. The inoculum of bacteriophage is almost always a freshly picked plaque or a suspension of bacteriophage particles obtained from a single plaque. Infected cells contain up to 200 copies of double-stranded RF DNA and extrude several hundred bacteriophage particles per generation. Thus, a 1-ml culture of infected cells can produce enough double-stranded viral DNA (1–2  $\mu\text{g}$ ) for restriction mapping and recovery of cloned DNA inserts and sufficient single-stranded DNA (~5–10  $\mu\text{g}$ ) for site-directed mutagenesis, DNA sequencing, or synthesis of radiolabeled probes. The titer of bacteriophages in the supernatant from infected cells is so high ( $\sim 10^{12}$  pfu/ml) that a small aliquot serves as a permanent stock of the starting plaque. Alternatively, larger volumes of the supernatant can be used to scale up the production of virus, RF DNA, and single-stranded DNA (please see Protocol 5).

Most manipulations involving bacteriophage M13, including preparation of viral stocks and isolation of single- and double-stranded DNAs, begin with small-scale liquid cultures. Typically, a plaque is picked from an agar plate and added to a 1–2-ml aliquot of medium containing uninfected *E. coli* cells. After a 4–6-hour period of growth (please see the information panel on **GROWTH TIMES**), the titer of bacteriophage particles in the medium reaches  $\sim 10^{12}$  pfu/ml, which is sufficient for the subsequent isolation of viral DNA or for storage as a stock solution.

---

### MATERIALS

---

#### Media

*LB medium containing tetracycline or kanamycin*

These media are needed only if a tetracycline-resistant strain of *E. coli*, such as XL1-Blue, or a kanamycin-resistant strain of *E. coli*, such as XL1-Blue MRF<sup>+</sup> Kan, is used to propagate the virus.

or

*Supplemented M9 minimal medium*

When using *E. coli* strains that carry a deletion of the proline biosynthetic operon ( $\Delta[lac-proAB]$ ) in the bacterial chromosome and the complementing *proAB* genes on the F' plasmid, use supplemented M9 minimal medium.

*YT or LB medium*

*2x YT medium containing 5 mM MgCl<sub>2</sub>*

#### Special Equipment

*Sterile toothpicks or Inoculating needles or Glass capillary tubes (50  $\mu\text{l}$ )*

## Vectors and Bacterial Strains

### *Bacteriophage M13 plaques plated onto an agar or agarose plate*

For methods to produce bacteriophage M13 plaques in top agar or agarose, please see either Protocol 1 or 6 of this chapter.

### *E. coli F' strain, grown as well-isolated colonies on an agar plate*

For a list of *E. coli* strains suitable for the propagation of bacteriophage M13, please see Table 3-2 in the introduction to this chapter.

Streak a master culture of an appropriate host onto an M9 minimal agar plate or, for antibiotic-resistant strains, onto an LB plate containing the appropriate antibiotic. Incubate for 24–36 hours at 37°C. Bacteriophage M13 single-stranded DNA to be used as a template for oligonucleotide-directed mutagenesis should be propagated in *E. coli* F' strains bearing mutations in the *dut* and *ung* genes. For a detailed protocol for growth of bacteriophage in these strains, please see Chapter 13, Protocol 1.

## METHOD

1. Inoculate 5 ml of supplemented M9 medium (or, for antibiotic-resistant strains, LB medium with the appropriate antibiotic) with a single freshly grown colony of *E. coli* carrying an F' plasmid. Incubate the culture for 12 hours at 37°C with moderate shaking.
 

Avoid growing the culture to stationary phase, which increases the risk of losing the pili encoded by the F' plasmid.
2. Transfer 0.1 ml of the *E. coli* culture into 5 ml of 2x YT medium containing 5 mM MgCl<sub>2</sub>. Incubate the culture for 2 hours at 37°C with vigorous shaking.
3. Dilute the 5-ml culture into 45 ml of 2x YT containing 5 mM MgCl<sub>2</sub> and dispense 1-ml aliquots into as many sterile tubes (13 × 100 mm or 17 × 100 mm) as there are plaques to be propagated. Dispense two additional aliquots for use as positive and negative controls for bacteriophage growth. Set these cultures aside for use at Step 7.
4. Dispense 1 ml of YT or LB medium into sterile 13 × 100-mm tubes. Prepare as many tubes as there are plaques. Dispense two additional aliquots for use as positive and negative controls for bacteriophage growth.
5. Prepare a dilute suspension of bacteriophage M13 by touching the surface of a plaque with the end of a sterile inoculating needle and immersing the end of the needle into the YT or LB medium. Pick one blue M13 plaque as a positive control for bacteriophage growth. Also pick an area of the *E. coli* lawn from the plate that does not contain a plaque as a negative control. Please see the panel on **PICKING PLAQUES** on the following page.
6. Allow the suspension to stand for 1–2 hours at room temperature to allow the bacteriophage particles to diffuse from the agar.
 

An average plaque contains between 10<sup>6</sup> and 10<sup>8</sup> pfu. The suspension of bacteriophage particles can be stored indefinitely in LB medium at 4°C or –20°C without loss of viability.
7. Use 0.1 ml of the bacteriophage suspension (Step 6) as an inoculum to infect 1-ml cultures of *E. coli* (Step 3) for isolation of viral DNA. Incubate the inoculated tubes for 5 hours at 37°C with moderate shaking.
 

Alternatively, transfer a plaque directly into the *E. coli* culture: Touch the surface of the chosen plaque with the end of a sterile inoculating needle, and immediately immerse the end of the needle into the tube containing the 2x YT medium (Step 3). Shake the tube vigorously to dislodge small fragments of agar (or agarose).

▲ **IMPORTANT** To minimize the possibility of selecting deletion mutants, grow cultures infected with recombinant M13 bacteriophages for the shortest time that will produce a workable amount of single-stranded DNA (usually 5 hours). For additional information, please see the information panel on **GROWTH TIMES**.

**PICKING PLAQUES**

Bacteriophage M13 can diffuse considerable distances through top agar. To minimize the possibility of cross contamination, pick plaques that are well separated (ideally by ~0.5 cm) from their nearest neighbors. Do not pick plaques that have been grown for more than 16 hours at 37°C or stored for extended periods at 4°C. The following are several alternative methods for picking plaques:

- Use an inoculating loop or sterile applicator stick.
- Attach a bulb to a sterile, disposable Pasteur or capillary pipette and stab through the plaque into the underlying agar. Then expel the plug of agar from the pipette into the liquid culture.
- Touch the surface of the plaque with a sterile toothpick, and then drop the toothpick into the liquid culture. This method violates the rules of sterile technique, since a nonsterile hand has held the toothpick. However, in practice, few problems arise, perhaps because the "dirty" end of the toothpick usually does not come into contact with the medium. This method may be used when picking plaques that will be used immediately (e.g., to generate templates for sequencing), but it is not recommended when picking plaques that will be stored for long periods of time or that will be used to make master stocks of valuable recombinants.
- Attach a sterile 50- $\mu$ l glass capillary tube to a mouth pipette plugged with cotton. Core the plaque with the capillary tube and use gentle suction to dislodge the plug containing the plaque from the plate. Expel the core into the aliquot of 2x YT medium containing bacteria.

8. Transfer the culture to a sterile microfuge tube and centrifuge at maximum speed for 5 minutes at room temperature. Transfer the supernatant to a fresh microfuge tube without disturbing the bacterial pellet.
9. Transfer 0.1 ml of the supernatant to a sterile microfuge tube.  
This high-titer stock can be stored indefinitely at 4°C or -20°C without loss of infectivity.
10. Use the remaining 1 ml of the culture supernatant to prepare single-stranded bacteriophage DNA (Protocol 4). Use the bacterial cell pellet to prepare double-stranded RF DNA (Protocol 3).

Alternatively, the culture supernatant may be stored at 4°C for large-scale preparation of M13 (Protocol 5).

# Protocol 3

---

## Preparation of Double-stranded (Replicative Form) Bacteriophage M13 DNA

**B**ACTERIA INFECTED WITH BACTERIOPHAGE M13 contain the double-stranded RF of the viral DNA and extrude virus particles containing single-stranded progeny DNA into the medium. The double-stranded RF DNA can be isolated from small cultures of infected cells using methods similar to those used to purify plasmid DNA. Several micrograms of RF DNA can be isolated from a 1–2-ml culture of infected cells, which is enough for subcloning and restriction enzyme mapping.

Minipreparations or midipreparations (described in Chapter 1, Protocols 1 and 2) for plasmid purification may be used to prepare RF DNA. The method described here was devised by Birnboim and Doly (1979) and subsequently modified by Ish-Horowicz and Burke (1981). It was originally used to isolate closed circular plasmid and cosmid DNAs from bacterial cultures. Bacteriophage M13 RF DNA prepared with this method generally is used in two ways:

- To confirm the presence of a desired insert in the bacteriophage M13 vector by restriction analysis and Southern hybridization of recombinant bacteriophage RF DNA.
- To recover double-stranded DNA from recombinant bacteriophage M13 clones that have been subjected to site-directed mutagenesis (Chapter 13, Protocol 2). The mutated DNA can then be subcloned into a bacterial or eukaryotic expression vector.

Preparations of bacteriophage M13 RF DNA are rarely as clean as small-scale preparations of plasmid DNA. The former are often contaminated with single-stranded viral DNA that can confuse the pattern of DNA fragments obtained by digestion with restriction enzymes. This problem can be alleviated by analyzing in parallel an aliquot of RF DNA that has not been digested. Linear and circular single-stranded viral DNAs (which usually appear as fuzzy bands migrating faster than the double-stranded RF DNA) are not cleaved by most of the restriction enzymes commonly used for cloning in bacteriophage M13. Fragments of double-stranded DNA with recessed 3' termini can also be distinguished from single-stranded DNAs by end-labeling using the Klenow fragment of *E. coli* DNA polymerase I (please see Chapter 10, Protocol 7).



## MATERIALS

---

**CAUTION:** Please see Appendix 12 for appropriate handling of materials marked with <!>.

### Buffers and Solutions

Please see Appendix 1 for components of stock solutions, buffers, and reagents. Dilute stock solutions to the appropriate concentrations.

*Alkaline lysis solution I*

*Alkaline lysis solution II*

Prepare fresh for each use from standard stocks; use at room temperature.

*Alkaline lysis solution III*

*Ethanol*

*Phenol:chloroform (1:1, v/v) <!>*

*TE (pH 8.0) containing 20 µg/ml RNase A*

### Enzymes and Buffers

*Restriction endonucleases*

### Gels

*Agarose gel (0.8%) cast in 0.5x TBE, containing 0.5 µg/ml ethidium bromide <!>*

Please see Step 13.

### Vectors and Bacterial Strains

*E. coli culture infected with bacteriophage M13*

Prepared as described in Protocol 2 of this chapter.

## METHOD

---

### Lysis of the Infected Cells

1. Centrifuge 1 ml of the M13-infected cell culture at maximum speed for 5 minutes at room temperature in a microfuge to separate the infected cells from the medium. Transfer the supernatant to a fresh microfuge tube and store at 4°C. Keep the infected bacterial cell pellet on ice.

The supernatant contains M13 bacteriophage housing single-stranded DNA. If desired, prepare M13 DNA from this supernatant at a later stage (Protocol 4).

2. Centrifuge the bacterial cell pellet for 5 seconds at 4°C and remove residual medium with an automatic pipetting device.
3. Resuspend the cell pellet in 100 µl of ice-cold Alkaline lysis solution I by vigorous vortexing.

Make sure that the bacterial pellet is completely dispersed in Alkaline lysis solution I. Vortexing two microfuge tubes simultaneously with their bases touching increases the rate and efficiency with which the bacterial pellets are resuspended.

Some strains of bacteria shed cell-wall components into the medium that can inhibit the action of restriction enzymes. This problem can be avoided by resuspending the bacterial cell pellet in 0.5 ml of STE (0.1 M NaCl, 10 mM Tris-Cl [pH 8.0], 1 mM EDTA [pH 8.0]) before Step 3 and centrifuging again. After removal of the STE, resuspend the pellet in Alkaline lysis solution I as described above.

Some protocols for the preparation of bacteriophage M13 RF DNA include digestion of the cell walls with lysozyme. This step is generally not necessary but does no harm. To include this step, add 90 µl of Alkaline lysis solution I to the bacterial cell pellet and resuspend the cells by vortexing. To the resuspended cells, add 10 µl of Alkaline lysis solution I containing freshly prepared 10 mg/ml lysozyme. Mix the components by tapping the side of the tube and incubate on ice for 5 minutes. Continue with Step 4.

4. Add 200  $\mu$ l of freshly prepared Alkaline lysis solution II to the tube. Close the tube tightly and mix by inverting the tube rapidly five times. *Do not vortex*. Store the tube on ice for 2 minutes after mixing.
5. Add 150  $\mu$ l of ice-cold Alkaline lysis solution III to the tube. Close the tube to disperse Alkaline lysis solution III through the viscous bacterial lysate by inverting the tube several times. Store the tube on ice for 3–5 minutes.
6. Centrifuge the bacterial lysate at maximum speed for 5 minutes at 4°C in a microfuge. Transfer the supernatant to a fresh tube.

### Purification of RF Bacteriophage M13 DNA

7. Add an equal volume of phenol:chloroform. Mix the organic and aqueous phases by vortexing and then centrifuge the tube at maximum speed for 2–5 minutes. Transfer the aqueous (upper) phase to a fresh tube.
8. Precipitate the double-stranded DNA by adding 2 volumes of ethanol. Mix the contents of the tube by vortexing and then allow the mixture to stand for 2 minutes at room temperature.
9. Recover the DNA by centrifugation at maximum speed for 5 minutes at 4°C in a microfuge.
10. Remove the supernatant by gentle aspiration. Stand the tube in an inverted position on a paper towel to allow all of the fluid to drain away. Remove any drops of fluid adhering to the walls of the tube.

This step can be conveniently accomplished with a disposable pipette tip attached to a vacuum line. Use a gentle vacuum and touch the tip to the surface of the liquid. Keep the tip as far away from the pellet of nucleic acid as possible as the fluid is withdrawn from the tube. Use the pipette tip to vacuum the walls of the tube to remove any adherent droplets of fluid.

An additional ethanol precipitation step here helps to ensure that the double-stranded DNA is efficiently cleaved by restriction enzymes.

- Dissolve the pellet of RF DNA in 100  $\mu$ l of TE (pH 8.0).
- Add 50  $\mu$ l of 7.5 M ammonium acetate (please see Appendix 1), mix well, and add 300  $\mu$ l of ice-cold ethanol.
- Store the tube for 15 minutes at room temperature or overnight at –20°C and then collect the precipitated DNA by centrifugation at maximum speed for 5–10 minutes at 4°C in a microfuge. Remove the supernatant by gentle aspiration.
- Rinse the pellet with 250  $\mu$ l of ice-cold 70% ethanol, centrifuge again for 2–3 minutes, and discard the supernatant.
- Allow the pellet of DNA to dry in the air for 10 minutes and then dissolve the DNA as described in Step 12.

11. Add 1 ml of 70% ethanol at 4°C and centrifuge again for 2 minutes. Remove the supernatant as described in Step 10, and allow the pellet of nucleic acid to dry in the air for 10 minutes.
12. To remove RNA, resuspend the pellet in 25  $\mu$ l of TE (pH 8.0) with RNase. Vortex briefly.
13. Analyze the double-stranded RF DNA by digestion with appropriate restriction endonucleases followed by electrophoresis through an agarose gel.

The yield of RF DNA expected from 1 ml of an infected bacterial culture is usually several micrograms, which is enough for 5–10 restriction digests.

# Protocol 4

---

## Preparation of Single-stranded Bacteriophage M13 DNA

**B**ACTERIOPHAGE M13 SINGLE-STRANDED DNA IS PREPARED from virus particles secreted by infected cells into the surrounding medium. The filamentous virus is first concentrated by precipitation with polyethylene glycol (PEG) in the presence of high salt. Subsequent extraction with phenol releases the single-stranded DNA, which is then collected by precipitation with ethanol. The resulting preparation is pure enough to be used as a template for DNA sequencing by the dideoxy chain termination method (Chapter 12, Protocol 3 or 4), for oligonucleotide-directed mutagenesis (Chapter 13, Protocol 1), or for synthesis of radioactive probes (Chapter 9, Protocols 4 and 5). The following protocol, adapted from Sanger et al. (1980) and Messing (1983), is the simplest and most widely used method for preparing single-stranded DNA from a small number of bacteriophage M13 isolates. A yield of 5–10 µg of single-stranded DNA/ml of infected cells may be expected from recombinant bacteriophages bearing inserts of 300–1000 nucleotides. This amount is enough for 10–20 cycle-sequencing reactions or 5–10 Sequenase reactions (Chen et al. 1991; Halloran et al. 1993).

The standard method for purification of bacteriophage M13 DNA described in this protocol is not appropriate for large-scale sequencing projects, which typically require many thousands of DNA templates. For a method to produce these templates in large numbers, see Chapter 12, Protocol 2.

### MATERIALS

---

**CAUTION:** Please see Appendix 12 for appropriate handling of materials marked with <!.>.

#### Buffers and Solutions

Please see Appendix 1 for components of stock solutions, buffers, and reagents. Dilute stock solutions to the appropriate concentrations.

*Chloroform* <!.>

Please see note at Step 7.

*Ethanol*

*Phenol* <!.>

*Polyethylene glycol 8000 (20% w/v PEG 8000)* <!.> in 2.5 M NaCl

Please see the information panel on **POLYETHYLENE GLYCOL**.

Sodium acetate (3 M, pH 5.2)

Sucrose gel-loading buffer

TE (pH 8.0)

## Gels

Agarose gel (1.2%), cast in 0.5x TBE and containing 0.5 µg/ml ethidium bromide <!-->

Please see Step 13.

## Nucleic Acids and Oligonucleotides

Single-stranded bacteriophage M13 vector of recombinant DNA

Use preparations of bacteriophage M13 DNA of known concentration as controls during gel electrophoresis. Please see Step 13.

## Special Equipment

Multitube vortexing machine (optional)

## Vectors and Bacterial Strains

### *E. coli* cultures infected with bacteriophage M13

Prepare an infected culture as described in Protocol 2. These cultures should be infected with both the hoped-for recombinant bacteriophage and a control culture infected with nonrecombinant bacteriophage. Please see note to Step 4. To minimize the possibility of selecting deletion mutants, grow culture infected with recombinant M13 bacteriophages for the shortest possible time required to achieve an adequate yield (≤5 hours). For further details, please see the information panel on **GROWTH TIMES**.

Bacteriophage M13 single-stranded DNA to be used as a template for certain types of oligonucleotide-directed mutagenesis should be propagated in *E. coli* F' strains bearing mutations in the *dut* and *ung* genes. For a detailed protocol for bacteriophage growth in these strains, please see Chapter 13, Protocol 1.

### *E. coli* cultures, uninfected

Prepare a mock-infected culture by picking an area of the *E. coli* lawn from the plate that does not contain a plaque as a negative control. Use this culture to monitor the recovery of bacteriophage M13 particles. Please see Step 4.

## METHOD

---

### Precipitation of Bacteriophage Particles with PEG

1. Transfer 1 ml of the infected and uninfected cultures to separate microfuge tubes and centrifuge the tubes at maximum speed for 5 minutes at room temperature. Transfer each supernatant to a fresh microfuge tube at room temperature.  
If desired, set aside 0.1 ml of the supernatant as a master stock of the bacteriophage particles.
2. To the supernatant add 200 µl of 20% PEG in 2.5 M NaCl. Mix the solution well by inverting the tube several times, followed by gentle vortexing. Allow the tube to stand for 15 minutes at room temperature.  
Make sure that all of the dense PEG/NaCl solution is mixed with the infected cell medium.
3. Recover the precipitated bacteriophage particles by centrifugation at maximum speed for 5 minutes at 4°C in a microfuge.

- Carefully remove all of the supernatant using a disposable pipette tip linked to a vacuum line or a drawn-out Pasteur pipette attached to a rubber bulb. Centrifuge the tube again for 30 seconds and remove any residual supernatant.

A tiny, pinhead-sized, pellet of precipitated bacteriophage particles should be visible at the bottom of the tube. No pellet should be visible in the negative control tube in which a portion of the uninfected *E. coli* lawn was inoculated. If no bacteriophage pellet is visible, it is unlikely that sufficient single-stranded DNA will be obtained to justify proceeding further. In this case, the best course of action is to pick more recombinant plaques, using them to infect cultures at different multiplicities, and then to grow the infected cultures for longer periods of time (6–12 hours). Remember, however, that longer growth periods can result in deletions and rearrangements in the cloned insert DNA (please see Protocol 2). Also be sure that true plaques (not air bubbles) were picked.

### Extraction of Single-stranded DNA with Phenol

- Resuspend the pellet of bacteriophage particles in 100  $\mu$ l of TE (pH 8.0) by vortexing.  
The best method to accomplish resuspension is to allow the bacteriophage pellet to soak in the TE buffer for 15–30 minutes at room temperature. Subsequent low-speed vortexing will dissolve the now clear pellet. It is important to resuspend the bacteriophage pellet completely to allow efficient extraction of the single-stranded DNA by phenol in the next step. A multitube vortexing machine saves time and effort when multiple samples are processed.
- To the resuspended pellet add 100  $\mu$ l of equilibrated phenol. Mix well by vortexing for 30 seconds. Allow the sample to stand for 1 minute at room temperature, and then vortex for another 30 seconds.
- Centrifuge the sample at maximum speed for 3–5 minutes at room temperature in a microfuge. Transfer as much as is easily possible of the upper, aqueous phase to a fresh microfuge tube.

To facilitate separation of the phases, add 30  $\mu$ l of silicone lubricant (Phase-Lock Gel, 5'→3'). This step sometimes improves yields but is generally not necessary. Do not try to transfer all of the aqueous phase. Much cleaner preparations of single-stranded DNA are obtained when ~5  $\mu$ l of the aqueous phase is left at the interface.

The templates prepared with a single phenol extraction are adequate for most purposes (including DNA sequencing), and there is generally no need to use other extraction steps. However, contamination of the bacteriophage pellet with components in the PEG/NaCl supernatant in Step 3 can affect the reproducibility of the dideoxy sequencing reactions and can reduce the length of reliable sequence to 300 bases per reaction or less. These problems can be avoided by taking special care to extract all traces of supernatant material from the microfuge tube. To this end, some investigators either (i) add 100  $\mu$ l of chloroform to each tube after Step 6 and re-vortex the tubes before separating the phases by centrifugation or (ii) transfer the aqueous phase to a fresh tube as described in Step 7, and then extract the aqueous phase once with 100  $\mu$ l of chloroform. Separate the phases by centrifugation and transfer the aqueous phase to a fresh tube.

### Precipitation of the Bacteriophage DNA with Ethanol

- Recover the M13 DNA by standard precipitation with ethanol in the presence of 0.3 M sodium acetate. Vortex briefly to mix, and incubate the tubes for 15–30 minutes at room temperature or overnight at  $-20^{\circ}\text{C}$ .

The aqueous phase of the phenol extraction may be cloudy upon transfer to the fresh microfuge tube, but it should clear up when the sodium acetate solution is added.

Precipitation of the single-stranded DNA can also be accomplished by adding 300  $\mu$ l of a 25:1 mixture of absolute ethanol:3 M sodium acetate (pH 5.2) followed by an incubation for 15 minutes at room temperature. This alteration saves independent pipetting of the sodium acetate and ethanol and can speed up the step when large numbers of single-stranded DNAs are being purified.

M13 DNAs can be stored in ethanol at  $-20^{\circ}\text{C}$  for several months.

9. Recover the precipitated single-stranded bacteriophage DNA by centrifugation at maximum speed for 10 minutes at  $4^{\circ}\text{C}$  in a microfuge.
10. Remove the supernatant by gentle aspiration, being careful not to disturb the DNA pellet (which is often only visible as a haze on the side of the tube). Centrifuge the tube again for 15 seconds and remove any residual supernatant.
11. Add 200  $\mu$ l of cold 70% ethanol and centrifuge at maximum speed for 5–10 minutes at  $4^{\circ}\text{C}$ . Immediately remove the supernatant by gentle aspiration.

▲ **IMPORTANT** At this stage, the pellet is not firmly attached to the wall of the tube. It is therefore important to work quickly and carefully to avoid losing the DNA.

12. Invert the open tube on the bench for 10 minutes to allow any residual ethanol to drain and evaporate. Dissolve the pellet in 40  $\mu$ l of TE (pH 8.0). Warm the solution to  $37^{\circ}\text{C}$  for 5 minutes to speed dissolution of the DNA. Store the DNA solutions at  $-20^{\circ}\text{C}$ .

The yield of single-stranded DNA is usually 5–10  $\mu\text{g}/\text{ml}$  of the original infected culture.

13. Estimate the DNA concentration of a few of the samples by mixing 2- $\mu$ l aliquots of the DNA from Step 12 each with 1  $\mu$ l of sucrose gel-loading buffer. Load the samples into the wells of a 1.2% agarose gel cast in 0.5 $\times$  TBE and containing 0.5  $\mu\text{g}/\text{ml}$  ethidium bromide. As controls, use varying amounts of M13 DNA preparations of known concentrations. Examine the gel after electrophoresis for 1 hour at 6 V/cm. Estimate the amount of DNA from the intensity of the fluorescence.

Usually 2–3  $\mu$ l of a standard bacteriophage M13 DNA preparation is required for each set of four dideoxy cycle sequencing reactions using dye primers.

# Protocol 5

---

## Large-scale Preparation of Single-stranded and Double-stranded Bacteriophage M13 DNA

**T**HIS PROTOCOL, A SCALED-UP VERSION OF PROTOCOLS 3 AND 4, is used chiefly to generate large stocks of double-stranded DNA of strains of bacteriophage M13 that are routinely used as cloning vectors in the laboratory. Large amounts of single-stranded bacteriophage DNAs are needed for specialized purposes, for example, when a particular recombinant is to be used many times to generate radiolabeled probes or to construct large numbers of site-directed mutants. Most importantly, perhaps, large-scale preparations of both double- and single-stranded DNAs can be divided into small aliquots and used as standardized controls in dideoxy sequencing reactions and transfections by everyone in the laboratory.

In general, the yields of double- and single-stranded viral DNAs are not as high as those obtained from small-scale (1–2 ml) cultures of bacteriophage M13. The problems encountered with this method are similar to those outlined in Protocols 3 and 4.

### MATERIALS

---

**CAUTION:** Please see Appendix 12 for appropriate handling of materials marked with <!.>.

#### Buffers and Solutions

Please see Appendix 1 for components of stock solutions, buffers, and reagents. Dilute stock solutions to the appropriate concentrations.

*Ethanol*

*NaCl (solid)*

*Phenol <!.>*

*Phenol:chloroform (1:1, v/v) <!.>*

*Polyethylene glycol (20% w/v PEG 8000) <!.> in H<sub>2</sub>O*

*Sodium acetate (3 M, pH 5.2)*

*STE*

*TE (pH 8.0)*

*Tris-Cl (10 mM, pH 8.0)*

#### Gels

*Agarose gels (0.8%) cast in 0.5x TBE, containing 0.5 µg/ml ethidium bromide <!.>*

*Please see Steps 6 and 17.*

#### Media

*LB or YT medium containing 5 mM MgCl<sub>2</sub>*

*Transfer 250 ml of the medium into a 2-liter flask and warm to 37°C before Step 2.*

## Centrifuges and Rotors

*Sorvall GSA rotor or equivalent*  
*Sorvall SS-34 rotor or equivalent*

## Special Equipment

*Corex centrifuge tubes (30 ml)*  
*Silicon rubber band*  
*Sterile culture tubes (13 × 100 mm or 17 × 100 mm)*

## Additional Reagents

Step 5 of this protocol requires the reagents listed in Protocols 3, 8, 9, and 10 of Chapter 1.

## Vectors and Bacterial Strains

### *E. coli F'* plating bacteria

Please see Table 3-2 for a list of *E. coli* strains suitable for the propagation of bacteriophage M13. Pick a single colony of an appropriate host from a freshly streaked M9 minimal agar plate (or from an LB plate containing tetracycline or kanamycin for XL1-Blue strains) into 5 ml of LB in a 20-ml sterile culture tube. Incubate the culture for 6–8 hours at 37°C with moderate agitation. The aim here is to avoid growing the culture to stationary phase, which increases the risk of losing the pili encoded by the F' plasmid. Bacteriophage M13 single-stranded DNA to be used as a template for certain types of oligonucleotide-directed mutagenesis should be propagated in *E. coli* F' strains bearing mutations in the *dut* and *ung* genes. For a detailed protocol for medium-scale growth of bacteriophage in these strains, please see Chapter 13, Protocol 1.

### *Bacteriophage M13 Stock*

Prepared as described in Protocol 2 of this chapter.

## METHOD

---

### Preparation of Bacteriophage M13 RF DNA

1. Transfer 2.5 ml of plating bacteria (please see Protocol 1) to a sterile tube (13 × 100 mm or 17 × 100 mm). Add 0.5 ml of bacteriophage M13 stock ( $\sim 5 \times 10^{11}$  pfu) and mix by tapping the side of the tube. Incubate the infected cells for 5 minutes at room temperature.
2. Dilute the infected cells into 250 ml of fresh LB or YT medium containing 5 mM MgCl<sub>2</sub> prewarmed to 37°C in a 2-liter flask. Incubate for 5 hours at 37°C with constant, vigorous shaking.
3. Harvest the infected cells by centrifugation at 4000g (5000 rpm in a Sorvall GSA rotor) for 15 minutes at 4°C. Recover the supernatant, which may be used for large-scale preparations of single-stranded bacteriophage M13 DNA, as described in Steps 7–17 below.
4. Resuspend the bacterial pellet in 100 ml of ice-cold STE. Recover the washed cells by centrifugation at 4000g (5000 rpm in a Sorvall GSA rotor) for 15 minutes at 4°C.
5. Isolate the bacteriophage M13 closed circular RF DNA by the alkaline lysis method (please see Chapter 1, Protocol 3). Scale up the volumes of lysis solutions appropriately. Purify the DNA either by precipitation with PEG, by column chromatography, or by equilibrium centrifugation in CsCl-ethidium bromide gradients.
6. Measure the concentration of the DNA spectrophotometrically and confirm its integrity by agarose gel electrophoresis. Store the closed circular DNA in small (1–5 µg) aliquots at –20°C.  
 The yield of RF DNA expected from 250 ml of infected cells is ~200 µg.



### Preparation of Single-stranded Bacteriophage M13 DNA

7. To isolate single-stranded DNA from the bacteriophage particles in the infected cell medium, transfer the 250-ml supernatant from Step 3 to a 500-ml beaker containing a magnetic stirring bar.
8. Add 10 g of PEG and 7.5 g of NaCl to the supernatant. Stir the solution for 30–60 minutes at room temperature.

Do not stir for longer periods of time or at lower temperature because undesired bacterial debris may precipitate.
9. Collect the precipitate by centrifugation at 10,000g (7800 rpm in a Sorvall GSA rotor) for 20 minutes at 4°C. Invert the centrifuge bottle for 2–3 minutes to allow the supernatant to drain, and then use Kimwipes to remove the last traces of supernatant from the walls and neck of the bottle.

Avoid touching the thin whitish film of precipitated bacteriophage particles on the side and bottom of the centrifuge bottle.
10. Add 10 ml of 10 mM Tris-Cl (pH 8.0) to the bottle. Swirl the solution in the bottle and use a Pasteur pipette to rinse the sides of the bottle thoroughly. When the bacteriophage pellet is dissolved, transfer the solution to a 30-ml Corex centrifuge tube.
11. To the bacteriophage suspension, add an equal volume of equilibrated phenol, seal the tube with a silicon rubber stopper, and mix the contents by vortexing vigorously for 2 minutes.
12. Centrifuge the solution at 3000g (5000 rpm in a Sorvall SS-34 rotor) for 5 minutes at room temperature. Transfer the upper aqueous phase to a fresh tube and repeat the extraction with 10 ml of phenol:chloroform.

If there is a visible interface between the organic and aqueous layers, then extract the aqueous supernatant once more with chloroform.
13. Transfer equal amounts of the aqueous phase to each of two 30-ml Corex tubes. Add 0.5 ml of 3 M sodium acetate (pH 5.2) and 11 ml of ethanol to each tube. Mix the solutions well and then store them for 15 minutes at room temperature.
14. Recover the precipitate of single-stranded DNA by centrifugation at 12,000g (10,000 rpm in a Sorvall SS-34 rotor) for 20 minutes at 4°C. Carefully remove all of the supernatant.

Most of the precipitated DNA will collect in a thin film along the walls of the centrifuge tubes. To avoid discarding the DNA accidentally, it is best to mark the outside of the tubes with a permanent marker and to place the tubes in the centrifuge rotor with the marks facing outward from the axis of rotation.
15. Add 30 ml of 70% ethanol at 4°C to each tube, and centrifuge at 12,000g (10,000 rpm in a Sorvall SS-34 rotor) for 10 minutes at 4°C. Carefully remove as much of the supernatant as possible, invert the tubes to allow the last traces of supernatant to drain away from the precipitate, and wipe the neck of the tubes with Kimwipes.

Make sure that the precipitate does not slide out of the tubes.
16. Allow the residual ethanol to evaporate at room temperature. Dissolve the pellets in 1 ml of TE (pH 8.0). Store the DNA at –20°C.
17. Measure the concentration of the DNA spectrophotometrically and confirm its integrity by agarose gel electrophoresis. Store the closed circular DNA in small (10–50 µg) aliquots at –20°C.

The yield of single-stranded DNA expected from 250 ml of infected culture is 250 µg to 1 mg.

# Protocol 6

---

## Cloning into Bacteriophage M13 Vectors

**C** LONING FRAGMENTS OF FOREIGN DNA INTO BACTERIOPHAGE M13 vectors takes little effort:

- Ligate double-stranded segments of DNA with blunt or cohesive termini into compatible sites in double-stranded M13 RF DNAs.
- Use the products of the ligation reaction to transform competent male *E. coli* cells, which are plated in top agar containing IPTG and X-gal.
- Pick and propagate blue (nonrecombinant) and white (recombinant) plaques appearing after 6–8 hours as described in Protocol 2.

This blue-white test is an excellent indicator, but it is not infallible: Rare recombinant viruses retain the ability to generate blue plaques. On analysis, the segment of foreign DNA in these anomalous recombinants is generally found to be very small — perhaps <100 bases — and inserted in-frame into the *lacZ* sequences of the vector (e.g., please see Close et al. 1983). The resulting fusion peptide retains sufficient  $\alpha$ -complementing activity to generate a blue plaque in media containing IPTG and X-gal.

Although there is no limit in theory to the size of the fragment of foreign DNA that can be carried in bacteriophage M13 recombinants, there are restrictions in practice: Larger segments of foreign DNA are far more likely to suffer deletions and rearrangements than smaller fragments. For this reason, it is best wherever possible to clone into bacteriophage M13 pieces of foreign DNA that are no more than 1000 bases in length. In addition, the central regions of larger fragments may lie outside the range that can be reached in DNA sequencing reactions primed by the universal “forward” and “reverse” sequencing primers. Limit the opportunities for deletion and other rearrangements of cloned DNAs as follows:

- Keep the fragments of foreign DNA as small as the experiment will allow.
- Do not propagate recombinant bacteriophages for more than one or two serial passages in culture.
- Recover double-stranded DNA fragments from M13 recombinants as soon as possible after site-directed mutagenesis.

Described below are three different methods commonly used to construct bacteriophage M13 recombinants.

- ***Cloning by ligation of insert to linearized vector.*** A site within the multiple cloning region of the vector is cleaved with a single restriction enzyme, and the resulting linear DNA is ligated with a three- to fivefold molar excess of foreign DNA that has compatible termini. No effort is made to reduce the background of nonrecombinant viruses formed by recircularization of the vector or to suppress the formation of chimeric clones. This method is best suited to cloning a single segment of DNA — perhaps purified from a gel — in preparation for site-directed mutagenesis, DNA sequencing, or synthesis of radiolabeled probes.

Recombinant bacteriophages made in this way can in theory carry the foreign DNA sequences in two possible orientations. Sometimes, however, it happens that most of the population of recombinants carry the insert in the same orientation. This phenomenon occurs because sequences on opposite strands of the foreign DNA interfere to varying extents with the functioning of the intergenic region. The problem can be overcome by cloning the foreign DNA at a different site within the multiple cloning site or by using a combination of restriction enzymes that will allow directional cloning (please see below). Alternatively, a reversal experiment can be attempted in which RF DNA from the original recombinant is digested with the restriction enzyme used for cloning, religated, and used to transform *E. coli*. Screening of the resulting white plaques may yield clones carrying the insert in the opposite orientation. In general, however, it is not advisable to force bacteriophage M13 vectors to propagate unwelcome sequences of foreign DNA. The resulting recombinants are often unstable and give rise to progeny that carry deleted or rearranged versions of the foreign sequences. A possible solution to this problem is to propagate the foreign DNA in plasmid vectors that carry an origin of replication derived from a filamentous bacteriophage (phagemids; please see Protocol 8).

- ***Treatment of vector DNA with alkaline phosphatase.*** After linearization with a single restriction enzyme, the vector is dephosphorylated to reduce its ability to recircularize during ligation and to increase the proportion of recombinant clones (please see Chapter 1, Protocol 20, and Chapter 9, Protocol 13). This is the method of choice when the amount of foreign DNA is limiting or when ligating blunt-ended DNA fragments into bacteriophage M13 vectors, for example, when creating libraries of M13 subclones for sequencing (please see Chapter 12, Protocol 1).
- ***Forced or directional cloning.*** The multiple cloning site of the vector can be cleaved with two different restriction enzymes, generating molecules with incompatible termini that do not need to be dephosphorylated before use. The vector is ligated to a one- to threefold molar excess of foreign DNA whose termini are compatible with those of the vector. This strategy works well when cloning a single segment of foreign DNA in a desired orientation within M13. However, it is clearly unsuitable for the construction in M13 of libraries of large DNAs cloned in YACs, P1 vectors, or cosmids. Directional cloning may also prove to be a liability when single-stranded templates are used to determine the sequence of a segment of foreign DNA or to generate radiolabeled strand-specific probes. If a “universal primer” is used in the reaction, the sequences obtained will be restricted to the 200–700 nucleotides of foreign DNA immediately downstream from the primer-binding site; radioactive probes will correspond to only one of the strands of the foreign DNA. One solution to this problem is to insert the foreign DNA separately into each member of a pair of bacteriophage M13 vectors (e.g., M13mp18 and M13mp19) that carry the polycloning site in opposite orientations. Single-stranded templates prepared from these recombinants will yield the terminal sequences of each of the two strands of the foreign DNA; radiolabeled probes can be generated that will hybridize specifically to one strand or the other of the foreign DNA.

## MATERIALS

---

**CAUTION:** Please see Appendix 12 for appropriate handling of materials marked with <!.>.

### Buffers and Solutions

Please see Appendix 1 for components of stock solutions, buffers, and reagents. Dilute stock solutions to the appropriate concentrations.

*ATP (10 mM)*

*Ethanol*

*IPTG (20% w/v)*

*Phenol:chloroform (1:1, v/v) <!.>*

*Sodium acetate (3 M, pH 5.2)*

*TE (pH 7.6 and pH 8.0)*

*X-gal (2% w/v) <!.>*

### Enzymes and Buffers

*Bacteriophage T4 DNA ligase*

*Restriction endonucleases*

The choice of restriction enzymes to be used in Steps 1 and 6 depends on the cloning strategy.

### Gels

*Agarose gels (0.8%) cast in 1x TBE, containing 0.5 µg/ml ethidium bromide <!.>*

Please see Steps 2, 6, and 9.

### Nucleic Acids and Oligonucleotides

*Foreign DNA*

Individual fragments of foreign DNA to be cloned in M13 vectors are usually derived from a larger segment of DNA that has already been cloned and characterized in another vector. For methods to construct M13 libraries of DNA segments cloned in YACs or other genomic vectors, please see Chapter 12, Protocol 1.

*Test DNA*

Please see note at Step 7.

### Media

*YT or LB agar plates*

*YT or LB medium*

*YT or LB top agar or agarose*

### Special Equipment

*Culture tubes (5 ml or 15 ml, e.g., Falcon 2054 or 2006, Becton Dickinson), chilled to 0°C*

*Heating block preset to 47°C*

*Ice-water bath*

*Water baths preset to 12–16°C and 42°C*

### Additional Reagents

*Step 4 of this protocol requires the reagents listed in Chapter 1, Protocol 20.*

### Vectors and Bacterial Strains

*Bacteriophage M13 vector DNA (RF)*

A large number of bacteriophage M13 vectors, equipped with a wide variety of cloning sites, are available from both commercial and academic sources (please see Figure 3-4 and Appendix 3).

- E. coli* competent cells of an appropriate strain carrying an  $F'$  plasmid  
Competent cells may be prepared in the laboratory as described in Chapter 1, Protocol 25 or purchased from commercial suppliers.
- E. coli*  $F'$  plating bacteria  
Plating bacteria may be prepared in the laboratory as described in Protocol 1 or purchased from commercial suppliers.

## METHOD

---

### Preparation of Vector DNA

1. Digest 1–2  $\mu\text{g}$  of the bacteriophage M13 vector RF DNA to completion with a three- to five-fold excess of the appropriate restriction enzyme(s). Set up a control reaction containing M13 RF DNA but no restriction enzyme(s).
2. At the end of the incubation period, remove a small sample of DNA (50 ng) from each of the reactions and analyze the extent of digestion by electrophoresis through an 0.8% agarose gel. If digestion is incomplete (i.e., if any closed circular DNA is visible), add more restriction enzyme(s) and continue the incubation.  

Preparations of M13 RF DNA can contain significant amounts of single-stranded M13 DNA, which are visible as fuzzy, faster-migrating bands in agarose gel electrophoresis. Because single-stranded DNA is not cleaved efficiently by most restriction enzymes, the appearance and mobility of these bands should be identical in the control and test lanes.
3. When digestion is complete, purify the M13 DNA by extraction with phenol:chloroform followed by standard precipitation with ethanol in the presence of 0.3 M sodium acetate (pH 5.2). Dissolve the DNA in TE (pH 8.0) at a concentration of 50  $\mu\text{g}/\text{ml}$ .
4. If required, dephosphorylate the linearized vector DNA by treatment with calf alkaline phosphatase or shrimp alkaline phosphatase. At the end of the dephosphorylation reaction, inactivate the alkaline phosphatase by heat and/or by digestion with proteinase K, followed by extraction with phenol:chloroform (for details, please see Chapter 1, Protocol 20).
5. Recover the linearized M13 DNA as outlined in Step 3. Dissolve the dephosphorylated DNA in TE (pH 7.6) at a concentration of 50  $\mu\text{g}/\text{ml}$ .

### Preparation of Foreign DNA to be Cloned

6. Generate individual restriction fragments of foreign DNA by cleavage with the appropriate restriction enzymes and purify them by agarose gel electrophoresis. Dissolve the final preparation of foreign DNA in TE (pH 7.6) at a concentration of 50  $\mu\text{g}/\text{ml}$ .

### Ligation

When ligating DNAs with complementary cohesive termini, please follow Steps 7–9 below. For methods to set up blunt-ended ligation reactions, please see Chapter 1, Protocol 19.

7. In a microfuge tube (Tube A), mix together ~50 ng of vector DNA and a one- to fivefold molar excess of the target (foreign) DNA fragment(s). The combined volume of the two

DNAs should not exceed 8  $\mu$ l. If necessary, add TE (pH 7.6) to adjust the volume to 7.5–8.0  $\mu$ l. As controls, set up three ligation reactions containing:

Tube	DNA
B	the same amount of vector DNA, but no foreign DNA
C	the same amount of vector DNA and a one- to fivefold molar excess of the target DNA fragment(s)
D	the same amount of vector DNA together with an equal amount by weight of a test DNA that has been successfully cloned into bacteriophage M13 on previous occasions

As a test DNA, we routinely use a standard preparation of bacteriophage  $\lambda$  DNA cleaved with restriction enzymes that recognize tetranucleotide sequences and generate termini that are complementary to the M13 vectors to be used.

8. Add 1  $\mu$ l of 10 $\times$  ligation buffer and 1  $\mu$ l of 10 mM ATP to all four reactions (Tubes A–D). Omit ATP if using a commercial buffer that contains ATP.
9. Add 0.5 Weiss unit of bacteriophage T4 DNA ligase to Tubes A, B, and D. Mix the components by gently tapping the side of each tube for several seconds. Incubate the ligation reactions for 4–16 hours at 12–16°C.

At the end of the ligation reaction, analyze 1  $\mu$ l of each ligation reaction by electrophoresis through an 0.8% agarose gel. Bands of circular recombinant molecules containing vector and fragment(s) of foreign DNA should be visible in the test reaction (Tube A) but not in the control (Tube C).

After ligation, the reactions may be stored at –20°C until transformation.

## Transformation

10. Prepare and grow an overnight culture of plating bacteria (please see Protocol 1) in YT or LB medium at 37°C with constant shaking.
11. Remove from the –70°C freezer an aliquot of frozen competent cells of the desired strain carrying an F' plasmid, allow the cells to thaw at room temperature, and then place them on ice for 10 minutes.
12. Transfer 50–100  $\mu$ l of the competent F' bacteria to each of 16 sterile 5-ml culture tubes (Falcon 2054, Becton Dickinson) that have been chilled to 0°C.
 

Tubes other than Falcon 2054 (Becton Dickinson) may be used in the plating reaction, but in this case, it will be necessary to adjust the time and temperature of heat shock. For example, if 15-cm plates are preferred for some reason, larger tubes (17  $\times$  150 mm) should be used (e.g., Falcon 2006, Becton Dickinson). Falcon 2006 tubes require 2 minutes of heat shock (Step 15) and larger amounts of top agar, 2% X-gal, and 20% IPTG (7 ml, 120  $\mu$ l, and 20  $\mu$ l, respectively).
13. Immediately add 0.1-, 1.0-, and 5- $\mu$ l aliquots of the ligation reactions and controls (Tubes A–D) to separate tubes of competent cells. Mix the DNAs with the bacteria by tapping the sides of the tubes gently for a few seconds. Store on ice for 30–40 minutes. Include two transformation controls, one containing 5 pg of bacteriophage M13 RF DNA and the other containing no added DNA.
14. While the ligated DNA is incubating with the competent cells, prepare a set of 16 sterile culture tubes containing 3 ml of melted YT or LB top agar. Store the tubes at 47°C in a heating block or water bath until needed in Step 16.

15. Transfer the tubes containing the competent bacteria and DNA to a water bath equilibrated to 42°C. Incubate the tubes for exactly 90 seconds. Immediately return the tubes to an ice-water bath.

In this protocol, all of the transfected cultures of competent *E. coli* cells are exposed to heat shock simultaneously. An alternative is to administer heat shock to each culture in turn and thus avoid leaving the cells on ice. In this approach, the plating cells, X-gal, and IPTG are added to the top agar/agarose during the heat shock step. At the end of the heat shock, the top agar/agarose, plating cells, X-gal, etc., are immediately mixed with the transfected cells and poured directly onto an agar plate. This approach requires careful timing and exact knowledge of the length of time required for each step.

### Plating the Transformed Cells

16. Add 40 µl of 2% X-gal, 4 µl of 20% IPTG, and 200 µl of the overnight culture of *E. coli* cells (Step 10) to the tubes containing the melted top agar prepared in Step 14, and mix the contents of the tubes by gentle vortexing for a few seconds. Transfer each sample of the transformed bacteria to the tubes. Cap the tubes and mix the contents by gently inverting the tubes three times. Pour the contents of each tube in turn onto a separate labeled LB agar plate. Swirl the plate to ensure an even distribution of bacteria and top agar.

It may be difficult to obtain an even distribution of the top agar across the agar plate, especially when larger plates (15-cm diameter) are used for the first time. The speed with which the top agar solidifies can be decreased (thereby allowing more time for the swirling step) by preheating the agar plates for 30–60 minutes at 37°C before the plating step. Top agar that is hotter than 47°C will kill the competent bacteria (and dramatically decrease the transfection frequency!).

17. Close the plates and allow the top agar to harden for 5 minutes at room temperature. Use a Kimwipe to remove any condensation from the top of the plate, invert the plates, and incubate at 37°C.

Plaques will be fully developed after 8–12 hours. Plaques formed by nonrecombinant bacteriophage M13 will be deep blue; those formed by recombinants will be colorless in most cases. For details on efficiencies and expected results, please see Table 3-3.

**TABLE 3-3 Typical Transformation Results Using a Frozen Preparation of Competent Cultures of *E. coli* Strain TG1**

RF DNA	NUMBER OF PLAQUES/µg VECTOR DNA	
	BLUE	WHITE
Closed circular	$3 \times 10^7$	$3 \times 10^3$ <sup>a</sup>
Linearized by cleavage with one restriction enzyme	$1 \times 10^5$	$\sim 5 \times 10^4$
Linearized by cleavage with one restriction enzyme and self-ligated	$2 \times 10^7$	$\sim 1 \times 10^4$
Linearized by cleavage with one restriction enzyme, phosphatase-treated, and self-ligated	$3 \times 10^4$	$\sim 5 \times 10^4$
Cleaved by two different restriction enzymes	$< 5 \times 10^3$	$\sim 1 \times 10^3$
Linearized by cleavage with one restriction enzyme and ligated in the presence of molar excess of foreign DNA cleaved with a compatible restriction enzyme	$\sim 1 \times 10^5$	$\sim 4 \times 10^6$
Cleaved by two different restriction enzymes and ligated in the presence of molar excess of foreign DNA carrying compatible termini	$< 5 \times 10^3$	$\sim 2 \times 10^6$

The method used to prepare the competent cells can dramatically influence the number of bacteriophage M13 plaques. The frequencies in the above table are those obtained using preparations of competent bacterial cells that produce  $\sim 10^7$  plaques/µg of RF DNA. Lower or higher transfection efficiencies will require more or less of the ligation reaction to obtain equivalent numbers of recombinant plaques. For example, if electroporation is used (Chapter 1, Protocol 26), then the ligation reactions should be diluted substantially ( $10^{-1}$  to  $10^{-3}$ ) to obtain well-separated plaques.

<sup>a</sup>The small proportion of colorless plaques is formed by spontaneous mutants that have lost the ability to accomplish  $\alpha$ -complementation.

# Protocol 7

---

## Analysis of Recombinant Bacteriophage M13 Clones

**S**EVERAL METHODS ARE USED TO ANALYZE THE SIZE AND ORIENTATION of foreign DNA sequences carried in M13 recombinants.

- screening *lac*<sup>-</sup> (white) bacteriophage M13 plaques by hybridization (please see the panel on **ALTERNATIVE PROCOTOL: SCREENING BACTERIOPHAGE M13 PLAQUES BY HYBRIDIZATION** at the end of this protocol)
- analysis of *lac*<sup>-</sup> plaques by PCR (please see Chapter 8, Protocol 7)
- analysis of small-scale RF DNA preparations (Protocol 3) by restriction enzyme digestion, gel electrophoresis, and Southern hybridization
- electrophoretic analysis of the size of single-stranded DNA in putative recombinant clones (this protocol)

In this protocol, recombinant bacteriophage M13 clones carrying sequences of foreign DNA longer than 200–300 nucleotides are detected by gel electrophoresis of single-stranded DNA released from infected bacteria into the surrounding medium.

### MATERIALS

---

**CAUTION:** Please see Appendix 12 for appropriate handling of materials marked with <!>.

#### Buffers and Solutions

Please see Appendix 1 for components of stock solutions, buffers, and reagents. Dilute stock solutions to the appropriate concentrations.

*SDS (2% w/v)*

*20x SSC*

*Sucrose gel-loading buffer*

#### Gels

*Agarose gel (0.7%) cast in 0.5x TBE, containing 0.5 µg/ml ethidium bromide <!>*

Please see Step 4.



## Nucleic Acids and Oligonucleotides

### *Single-stranded recombinant bacteriophage M13 DNA*

Choose previously characterized recombinants that carry foreign sequences of known size to use as positive controls during gel electrophoresis. Please see Step 4 note.

## Special Equipment

Water bath preset to 65°C

## Additional Reagents

Step 1 of this protocol requires the reagents listed in Protocol 2 of this chapter.

Step 7 of this protocol may require the reagents listed in Chapter 2, Protocols 21 and 22.

## Vectors and Bacterial Strains

### *Bacteriophage M13 recombinants plaques in top agarose*

Prepared as described in Protocol 6 of this chapter.

### *Bacteriophage M13 nonrecombinant vector, grown as well-isolated plaques in top agarose*

Prepared as described in Protocol 1 of this chapter.

### *E. coli F' strain*

For a listing of strains suitable for the propagation of bacteriophage M13, please see Table 3-2 in the introduction to this chapter.

## METHOD

---

1. Prepare stocks of putative recombinant bacteriophages from single plaques, grown in an appropriate F' host, as described in Protocol 2.  
As controls, prepare stocks of several nonrecombinant bacteriophages (picked from well-isolated dark blue plaques).
2. Use a micropipettor with a sterile tip to transfer 20  $\mu$ l of each of the supernatants into a fresh microfuge tube. Store the remainder of the supernatants at 4°C until needed.
3. To each 20- $\mu$ l aliquot of supernatant, add 1  $\mu$ l of 2% SDS. Tap the sides of the tubes to mix the contents, and then incubate the tubes for 5 minutes at 65°C.
4. To each tube, add 5  $\mu$ l of sucrose gel-loading buffer. Again mix the contents of the tubes by tapping and then analyze each sample by electrophoresis through an 0.7% agarose gel. Run the gel at 5 V/cm. As positive controls, use single-stranded DNA preparations of previously characterized M13 recombinants that carry foreign sequences of known size.  
Electrophoresis at low voltage eliminates problems associated with salt fronts created in the gel by the large volume of sample.
5. When the bromophenol blue has traveled the full length of the gel, photograph the DNA under UV illumination.
6. Compare the electrophoretic mobilities of the single-stranded DNAs liberated from the putative recombinants with those of the DNAs liberated from the control nonrecombinant bacteriophages.  
The single-stranded DNAs of recombinants carrying sequences of foreign DNA longer than 200–300 nucleotides migrate slightly more slowly than empty vector through 0.7% agarose gels. Once recombinants of the desired size have been identified, single-stranded DNAs can be prepared from supernatants stored at 4°C (Step 2).
7. If necessary, confirm the presence of foreign DNA sequences by transferring single-stranded DNAs from the gel to a nitrocellulose or nylon membrane (please see Chapter 2, Protocol 21)

and hybridizing to an appropriate radiolabeled probe (please see Chapter 2, Protocol 22). Soak the gel in 10 volumes of 20x SSC for 45 minutes, and then transfer the DNA directly to the membrane.

There is no need to denature the DNA by soaking the gel in alkali.

Southern blotting using oligonucleotide probes is particularly useful in identifying recombinants carrying different strands of a target DNA.

#### **ALTERNATIVE PROTOCOL: SCREENING BACTERIOPHAGE M13 PLAQUES BY HYBRIDIZATION**

Bacteriophage M13 plaques can be screened by hybridization to <sup>32</sup>P-labeled probes by following essentially the same methods devised for screening bacteriophage λ.

##### **Method**

1. Transfer the bacteriophage DNA to a nitrocellulose or nylon filter as described in Chapter 2, Protocol 21.
2. After removing the filter from the surface of the agar or agarose, allow it to dry (DNA side up) at room temperature.

The single-stranded bacteriophage M13 DNA transferred to the filter does not need to be denatured with alkali.

3. Bake the filter under vacuum for 2 hours at 80°C or autoclave for 3 minutes, or, in the case of nylon filters, expose to UV irradiation to fix the DNA to the filter (please see Chapter 2, Protocol 21).
4. Hybridize the immobilized DNAs to an appropriate <sup>32</sup>P-labeled DNA probe as described in Chapter 2, Protocol 22.

Double-stranded DNA probes will hybridize to all M13 recombinants that carry the target sequence irrespective of the orientation of the segment of foreign DNA within the vector. Single-stranded probes will hybridize only to recombinants that carry complementary sequences attached to the (+) strand of M13 bacteriophage DNA.

If the filter is treated with alkali, as in conventional Benton-Davis screening of plaques, double-stranded M13 RF DNA released from the infected bacteria will be denatured. Both the (+) and (-) strands of M13 recombinants therefore become available for hybridization. Since the amount of (+) strand attached to the filter is much greater than the amount of RF DNA, single-stranded probes complementary to the (+) strand will generate a much stronger hybridization signal than probes complementary to the (-) strand. A weak hybridization signal with a single-stranded probe usually results from hybridization of the probe to denatured M13 RF DNA in plaques that contain the insert in the opposite orientation. This difference in intensity of hybridization has been used as a method to assay the orientation of cloned inserts (Picken 1990).

# Protocol 8

## Producing Single-stranded DNA with Phagemid Vectors

**P**HAGEMIDS FELICITOUSLY COMBINE FEATURES OF PLASMIDS and filamentous bacteriophages. Stripped to their bare essentials, these vectors are conventional high-copy-number plasmids that carry a modified version of the major intergenic region of a filamentous bacteriophage (please see Table 3-4). This region (508 bp in its wild-type form) encodes no proteins but contains all of the *cis*-acting sequences that are indispensable for initiation and termination of viral DNA synthesis and for morphogenesis of bacteriophage particles.

**TABLE 3-4 Phagemids**

PLASMID	INTERGENIC REGION	HELPER VIRUS	HOST BACTERIA <sup>a</sup>	REFERENCE
pEMBL (derived from pUC8)	fl	IR1, an interference-resistant variant of fl <sup>b</sup>	71/18	Dente et al. (1983)
pRSA101 (derived from $\pi$ VX <sup>c</sup> )	M13	a variant of M13 resistant to interference by plasmids containing the M13 intergenic region	XS127, XS101	Levinson et al. (1984)
pUC118/119 (derived from pUC18/19)	M13	M13K07 carries a mutated version of gene II that works less well on its own intergenic region than on that cloned in pUC118/119	MV1184	Vieira and Messing (1987)
pBluescript	fl	M13K07	XL1-Blue	Short et al. (1988)
pBluescript II SK +/-	fl	R408 or M13K07	XL1-Blue MRF <sup>d</sup>	Short et al. (1988)
pBS +/-	fl	R408 or M13K07	XL1-Blue MRF <sup>d</sup>	Alting-Mees and Short (1989)
pBC SK +/-	fl	R408 or M13K07	XL1-Blue MRF <sup>d</sup>	Alting-Mees and Short (1989)
pGEM 11Zf(t)	fl	M13K07 or R408	DH11S, JM109	
pGEM 13Zf(t)	fl	M13K07 or R408	DH11S, JM109	

Other more complicated phagemid systems have been devised (e.g., please see Geider et al. 1985; Mead et al. 1985; Peeters et al. 1986).

<sup>a</sup>Please see Table 3-2.

<sup>b</sup>Fnea and Zinder (1982).

<sup>c</sup>Seed (1983).

Segments of foreign DNA can be cloned in phagemids and propagated as plasmids in the usual way. However, when a male strain of *E. coli* carrying a phagemid is infected with a suitable filamentous bacteriophage, the mode of replication of the phagemid changes in response to gene products expressed by the incoming virus. The gene II protein encoded by the helper virus introduces a nick at a specific site in the intergenic region of the phagemid and hence initiates rolling circle replication (Beck and Zink 1981; Dotto et al. 1981a), which generates copies of one strand of the plasmid DNA. These single-stranded copies of the plasmid DNA are packaged into progeny bacteriophage particles, which are then extruded into the medium (Dotto et al. 1981b; Dente et al. 1983; Levinson et al. 1984; Zagursky and Berman 1984; Geider et al. 1985; Mead et al. 1985). The secreted particles can easily be recovered by precipitation with polyethylene glycol and the single-stranded DNA purified by extraction with phenol (Protocol 4).

Single-stranded DNAs produced by phagemids are used for the same purposes as single-stranded DNAs of bacteriophage M13 recombinants: for DNA sequencing, for the synthesis of strand-specific radiolabeled probes, for subtractive hybridization, and for oligonucleotide-directed mutagenesis. In addition, phagemid vectors can be used in appropriate strains of *E. coli* (e.g., BW313) to produce single-stranded DNAs that contain uracil in place of a proportion of the thymine residues. These uracil-substituted DNAs are excellent substrates for certain types of oligonucleotide-directed mutagenesis (please see Chapter 13, Protocol 1; McClary et al. 1989).

Phagemids have several attractive features that overcome problems commonly encountered with cloning in bacteriophage M13, including:

- a positive selectable marker that can be used to select bacteria transformed by the phagemid
- higher yields of double-stranded DNA
- elimination of the time-consuming process of subcloning DNA fragments from plasmids to filamentous bacteriophage vectors
- a significant reduction in the frequency and extent of deletions and rearrangements in single-stranded DNA
- the ability to allow segments of DNA several kilobases in length to be isolated in single-stranded form

In addition, it is possible to construct a complete expression cassette in a phagemid, containing, for example, a strong promoter, the gene or cDNA of interest, and a transcription terminator (e.g., please see Kunapuli and Colman 1993). Expression phagemids of this type can be isolated in single-stranded DNA form, subjected to site-directed mutagenesis, and then used to transform *E. coli* or yeast for phenotypic expression.

## IMPROVEMENTS IN PHAGEMIDS AND HELPER VIRUSES

---

The first generation of vectors, the pEMBL vectors, gave phagemids a bad name because, after superinfection with a helper virus, the yield of single-stranded DNA was generally poor and was influenced by many factors, including the density of the culture at the time of infection, the multiplicity of infection, and the length of time after infection. Even when superinfection was carried out under optimal conditions, the yield of progeny virus all too often consisted predominantly of helper viruses rather than packaged single-stranded phagemid DNA. These problems were ameliorated by constructing helper viruses encoding a mutated version of gene II that preferentially

activates the phagemid origin of replication (please see the panel on **HELPER BACTERIOPHAGES**). In addition, novel strains of *E. coli* have been engineered (e.g., DH11S, TG2, and MV1184) that are efficiently transformed by plasmids, are easily infected by commonly used helper viruses, and yield preparations of single-stranded phagemid DNA that are free from contamination with bacterial DNA and helper phages (e.g., please see Lin et al. 1992).

The particular strand of the foreign DNA that is packaged into the bacteriophage particles depends on its orientation in the polylinker site of the phagemid vector and on the orientation of the bacteriophage origin of DNA replication carried in the vector. As a consequence, most commercially available phagemid vectors (e.g., pBluescript II from Stratagene and pGEMZf from Promega) come in four chiralities in which the orientation of the polylinker sequence is opposite in one pair of vectors (e.g., pBluescript II SK and pBluescript II KS), and the orientation of the intergenic region is opposite in the other pair (e.g., pBluescript II SK [+] and pBluescript II SK [-]). The (+) and (-) orientations of the intergenic region allow the rescue by helper bacteriophages of sense and antisense single-stranded DNAs. For a list of phagemid vectors and helper bacteriophages, please see Table 3-4. For first-time users of phagemids, the safest choices for helper virus, phagemid vector, and host are a well-tested and reliable helper virus such as M13K07 and a dependable phagemid (e.g., one or more of the Stratagene SK or Promega pGemZ series) in an *E. coli* strain such as DH11S (Lin et al. 1992).

#### HELPER BACTERIOPHAGES

Several helper viruses have been engineered to maximize the yield of single-stranded phagemid DNA packaged into filamentous particles after superinfection of a phagemid-transformed culture. When working well, the ratio of phagemid to helper genomes in the bacteriophage particles released into the medium should be ~20:1. A small-scale (1.5 ml) culture should provide enough single-stranded phagemid DNA for four to eight sequencing reactions.

- **M13K07** is a derivative (Vieira and Messing 1987) of bacteriophage M13 that carries a plasmid origin of replication (derived from p15A), the kanamycin-resistance gene from the transposon Tn903, and a mutated version of gene II (derived from M13mp1), in which the G residue at 6125 has been replaced by a T (Vieira and Messing 1987). When M13K07 infects cells carrying phagemids, the incoming single-stranded DNA of the helper bacteriophage is converted by cellular enzymes to a double-stranded form that then uses the plasmid p15A origin to replicate. Because the accumulation of double-stranded M13K07 DNA does not require viral gene products, there is little opportunity for the resident phagemids to interfere with the early stages of replication of the incoming helper bacteriophage genome. With time, the pool of double-stranded M13K07 genomes expresses all of the proteins required to generate progeny single-stranded DNA. However, the mutated gene II product encoded by M13K07 interacts less efficiently with the bacteriophage origin of replication carried on its own genome (due to the insertion of *lacZ* sequences) than with the origin cloned into the phagemid vector (Vieira and Messing 1987). This preference results in the production of more (+) strands from the phagemid than from the helper virus and ensures that the virus particles produced by the cell contain a preponderance of single-stranded DNA derived from the phagemid. When M13K07 is grown in the absence of a phagemid vector (Steps 1–3 in this protocol), the mutant gene II protein interacts well enough with the disrupted origin of replication to produce sufficient bacteriophage for superinfection.
- **R408** is a derivative (Russel et al. 1986) of bacteriophage f1 from which an internal 24-bp segment of the signal required for packaging of bacteriophage particles has been deleted. The resulting helper bacteriophage packages single-stranded DNAs containing a complete packaging signal better than it packages its own single-stranded DNA. In addition to a modified packaging signal, R408 carries (1) a mutation known as IR1 that renders R408 insensitive to interference by defective viruses (Enea and Zinder 1982) and (2) the *gtrxA* mutation that improves the efficiency of bacteriophage assembly by altering an amino acid in a morphogenetic protein. Unlike M13K07, R408 does not carry an antibiotic resistance marker.
- **Other Helper Viruses:** Although M13K07 and R408 are the most widely used helper viruses, companies that sell phagemids may recommend other helper viruses, for example, ExAssist (Stratagene) and VCSM13, which is a derivative of M13K07 (Vieira and Messing 1987). However, both in our experience and that of others, the yield and proportion of filamentous particles containing single-stranded phagemid genomes are usually higher with M13K07 (e.g., please see Lin et al. 1992) than with other helper viruses.

## MATERIALS

---

**CAUTION:** Please see Appendix 12 for appropriate handling of materials marked with <!>.

### Buffers and Solutions

Please see Appendix 1 for components of stock solutions, buffers, and reagents. Dilute stock solutions to the appropriate concentrations.

#### *Kanamycin (10 mg/ml)*

Kanamycin is used in this protocol to ensure that all bacterial cells containing a phagemid genome are infected by the helper M13K07 bacteriophage. During propagation of M13K07 (e.g., Steps 1–3), there is selection for bacteriophage genomes that have lost the p15A origin and the Tn903 transposon. For this reason, it is essential to include kanamycin in the medium used to prepare the stock of helper virus (Step 3).

#### *SDS solution (2% w/v)*

#### *Sucrose gel-loading buffer*

### Gels

*Agarose gel (0.7%) cast in 0.5× TBE, containing 0.5 µg/ml ethidium bromide <!>*

Please see Step 12.

### Media

#### *Supplemented M9 minimal agar plates*

When using *E. coli* strains that carry a deletion of the proline biosynthetic operon ( $\Delta[lac-proAB]$ ) in the bacterial chromosome and the complementing *proAB* genes on the F' plasmid, use supplemented M9 minimal medium.

#### *YT agar plates containing 60 µg/ml ampicillin*

#### *2× YT medium*

#### *2× YT medium containing 60 µg/ml ampicillin*

#### *2× YT medium containing 25 µg/ml kanamycin*

The addition of Mg<sup>2+</sup> (5 mM) to media (Reddy and McKenney 1996) is reported to improve the yield of bacteriophage M13 cultures infected at low multiplicity.

### Special Equipment

*Water bath preset to 65°C*

### Additional Reagents

*Steps 2 and 5 of this protocol require the reagents listed in Protocol 1 of this chapter.*

*Step 14 of this protocol requires the reagents listed in Protocol 4 of this chapter.*

### Vectors and Bacterial Strains

#### *Bacteriophage M13K07 (helper)*

M13K07 may be obtained commercially (e.g., from Pharmacia or New England Biolabs) and propagated as described in Steps 1–3 below. Store stocks of helper virus at 4°C in growth medium or at –20°C in growth medium containing 50% (v/v) glycerol. M13K07 should not be used to superinfect cultures of *E. coli* JM109 transformed with phagemid vectors. For reasons that are not understood, this strain undergoes significant lysis when infected with M13K07. The recommended strain for M13K07 is DH11S (Lin et al. 1992).

#### *E. coli F' strain*

For a listing of strains suitable for the propagation of bacteriophage M13, please see Table 3-2 in the introduction to this chapter.

In principle, it should be possible to produce bacteriophage particles that contain single-stranded copies of phagemid DNA in any male strain of *E. coli*. Unfortunately, the yield of single-stranded DNA can be greatly affected by the bacterial strain used to propagate the plasmid. For example, *E. coli* strains MV1184 (derived from JM83) and MV1190 (derived from JM101) produce satisfactory yields, whereas MV1304 (derived from JM105) does not. The biological reasons for varying yields are poorly understood. Several strains (MV1184, DH11S, XL1-Blue, XL1-Blue MRF<sup>+</sup>; for more complete details, please see Table 3-2) have been used by many laboratories and generally yield workable quantities of single-stranded phagemid DNAs (Vieira and Messing 1987; Lin et al. 1992). With all strains, maximum yields of phagemid DNA are obtained when infected cultures are well-aerated.

*E. coli* strain DH11S

DH11S (Lin et al. 1992) is available from Life Technologies. MV1184, a less-preferred option, can be obtained from J. Messing. Both strains should be plated on supplemented minimal agar plates.

*E. coli* strain DH11S, transformed with bacteriophage M13 phagemid vector

Transform *E. coli* with the phagemid vector as described in Protocol 6. The transformed strain may be propagated as a culture as described in Protocol 2.

*E. coli* strain DH11S, transformed with bacteriophage M13 recombinant phagemid vector clone carrying foreign DNA

Transform *E. coli* with the recombinant phagemid vector as described in Protocol 6. The transformed strain may be propagated as a culture as described in Protocol 2.

## METHOD

---

### Preparation of a High-titer Stock of Helper Bacteriophage

The key to success in using phagemids is to prepare a stock of helper virus whose titer is accurately known.

1. In 20 ml of 2x YT medium, establish a culture of *E. coli* strain DH11S from a single colony freshly picked from supplemented minimal agar plates. Incubate the culture at 37°C with moderate agitation until the OD<sub>600</sub> reaches 0.8.
2. Prepare a series of tenfold dilutions of bacteriophage M13K07 in 2x YT medium, and plate aliquots of the bacteriophage as described in Protocol 1 to obtain well-isolated plaques on a lawn of DH11S cells.
3. Pick well-separated, single plaques and place each plaque in 2–3 ml of 2x YT medium containing kanamycin (25 µg/ml) in a 15-ml culture tube. Incubate the infected cultures for 12–16 hours at 37°C with moderate agitation (250 cycles/minute).
  - ▲ **IMPORTANT** Use stocks of M13K07 derived from single freshly picked plaques in the following steps.
4. Transfer the infected cultures to 1.5-ml sterile microfuge tubes and centrifuge them at maximum speed for 2 minutes at 4°C in a microfuge. Transfer the supernatants to fresh tubes and store them at 4°C.
5. Measure the titer of each of the bacteriophage stocks by plaque formation (Protocol 1) on a strain of *E. coli* F' (TG1, DH11S, NM522, or XL1-Blue) that supports the growth of bacteriophage M13.

The titer of infectious bacteriophage particles in the stocks should be 10<sup>10</sup> pfu/ml. Discard any stock with a lower titer.

## Growth of Recombinant Phagemids with Helper Virus

6. Streak DH11S cells transformed by (i) the recombinant phagemid and (ii) the empty (parent) phagemid vector onto two separate YT agar plates containing 60 µg/ml ampicillin. Incubate the plates for 16 hours at 37°C.
7. Pick (i) several colonies transformed by the recombinant phagemid and (ii) one or two colonies transformed by the parent vector into sterile 15-ml culture tubes that contain 2–3 ml of 2x YT medium containing 60 µg/ml ampicillin.
8. To each culture, add M13K07 helper bacteriophage to achieve a final concentration of  $2 \times 10^7$  pfu/ml. Incubate the cultures for 1.0–1.5 hours at 37°C with strong agitation (300 cycles/minute).

Because the variables that affect the yield of single-stranded DNA are poorly defined, pick multiple isolates from each phagemid recombinant to increase the chances of success.

The bacterial cultures should be only slightly turbid after this short incubation. If growth is too florid, dilute the cultures with prewarmed 2x YT medium until the turbidity is only just visible.

### ALTERNATIVE PROCEDURES FOR SUPERINFECTION BY HELPER VIRUS

#### Using Neglected Colonies for Superinfection

The standard protocol works best with cultures established directly from freshly picked colonies of DH11S, i.e., colonies that have been grown for 18 hours or less and have not been stored at 4°C. Colonies that have been stored at 4°C or otherwise neglected need to be restored to full health before superinfection.

1. Inoculate 2 ml of 2x YT medium containing ampicillin (100 µg/ml) with a bacterial colony transformed by the recombinant plasmid.
2. Incubate the culture at 37°C with strong agitation (300 cycles/minute) until the culture reaches saturation.
3. Dilute 20 µl of the saturated culture into 2 ml of 2x YT medium containing M13K07 helper bacteriophage at a concentration of  $2 \times 10^8$  to  $4 \times 10^8$  pfu/ml.
4. Incubate the culture for 1 hour at 37°C with strong agitation. (Please see the note in Step 8 regarding turbidity at this stage.) Proceed as described in Steps 9–14 of the standard protocol.

#### Using Frozen Cultures for Superinfection

Some investigators find that the yield of single-stranded phagemid DNA is highest when a saturated culture of DH11S is used in Step 6. Saturated cultures may be prepared ahead of time and stored at –70°C. Lin et al. (1992) recommend growing the cells containing the phagemid to saturation and then adding sterile glycerol to a final concentration of 20% (v/v). The cells are divided into small aliquots, quick-frozen in a dry ice–ethanol bath, and stored at –70°C. Thawed cells (20 µl) are then used to inoculate 2 ml of 2x YT medium containing M13K07 helper bacteriophage. The optimum amount of helper bacteriophage should be determined empirically for each culture, but usually lies in the range of  $10^7$  to  $4 \times 10^8$  pfu/ml. The infected cultures are grown at 37°C with strong agitation (300 cycles/minute) until the  $OD_{600}$  reaches 0.5. Then proceed as described in Steps 9–14 of the standard protocol.

9. Add kanamycin to the cultures to a final concentration of 25 µg/ml. Continue incubation for a further 14–18 hours at 37°C.
 

Because the bacteriophage M13K07 contains a kanamycin resistance gene, only those cells that are infected will survive the addition of this antibiotic in this step.

Other helper bacteriophages (e.g., R408) do not carry an antibiotic resistance marker. Check the genotype of the helper virus before adding antibiotic to the medium!
10. Transfer the cell suspensions to microfuge tubes and separate the bacterial cells from the growth medium by centrifugation at maximum speed for 5 minutes at room temperature in a microfuge. Transfer the supernatants to fresh tubes and store them at 4°C.



### Estimation of the Yield of Single-stranded Phagemid DNA by Gel Electrophoresis

11. Combine 40  $\mu\text{l}$  of each supernatant with 2  $\mu\text{l}$  of 2% SDS in 0.5-ml microfuge tubes. Mix the contents of the tubes by tapping and then incubate the tubes for 5 minutes at 65°C.

Alternatively, estimate the yield of virus particles containing single-stranded copies of the phagemid by infecting *E. coli* DH11S cells with dilutions of the supernatants (please see Protocol 1) and then plating the infected cells on YT agar containing ampicillin (60  $\mu\text{g}/\text{ml}$ ). The number of ampicillin-resistant colonies that arise after 24 hours incubation at 37°C is a measure of the number of virus particles in the supernatant that contain single-stranded phagemid DNA. Supernatants that contain  $2 \times 10^{11}$  to  $5 \times 10^{11}$  cfu/ml will generate satisfactory yields of purified single-stranded phagemid DNA.

12. Add 5  $\mu\text{l}$  of sucrose gel-loading buffer to each sample of the phagemid DNA, mix the samples, and load them into separate wells of an 0.7% agarose gel.
13. Carry out electrophoresis for several hours at 6 V/cm until the bromophenol blue has migrated approximately half the length of the gel. Examine and photograph the gel by UV light.

Yields vary depending on the size and nature of foreign DNA in the phagemid, but are generally  $\sim 1 \mu\text{g}/\text{ml}$  of culture volume.

14. Isolate single-stranded phagemid DNA from the supernatants containing the largest amount of single-stranded DNA. Follow the steps outlined in Protocol 4, scaling up the volumes two- to threefold.

In phagemids, as in bacteriophage M13 vectors, the yield of single-stranded DNA can vary over a five- to tenfold range depending on the size and nature of the foreign DNA. In general, the larger the fragment, the poorer the yield. Furthermore, for reasons that are not understood, foreign DNAs of equivalent size can suppress the yield of single-stranded DNA to varying extents. For example, most segments of yeast DNA seem to be amenable to propagation in phagemids, whereas human genomic DNAs of equivalent size may produce disappointing yields of single-stranded DNA. The orientation of both the foreign DNA insert and the bacteriophage origin of DNA replication in the phagemid vector can also dramatically affect yields. Thus, recloning a fragment in the opposite orientation or in a vector with the bacteriophage origin of replication in the opposite orientation will sometimes solve a problem of low yields.

---

**GROWTH TIMES**

---

Deletion or rearrangement of part of the foreign DNA segment can be a problem with some bacteriophage M13 clones. The larger the insert, the greater the rate at which deletions occur. This problem can be minimized (although not eliminated) by taking care never to propagate the bacteriophage by serial growth of infected cells in liquid culture. Instead, stocks of recombinant bacteriophages stored at  $-20^{\circ}\text{C}$  should be plated on an appropriate host, and a single, well-isolated plaque be used to establish a small-scale culture. This culture should provide enough single-stranded DNA (Protocol 4) for most purposes. The culture should be grown for the shortest possible time (5 hours is usually optimal) and not be used to seed further cultures. Recombinant bacteriophages carrying larger segments of foreign DNA almost always grow more slowly than those carrying smaller inserts. Cultures of these slower-growing recombinants may require up to 8 hours of incubation to produce a satisfactory yield of single-stranded DNA. Deletion of foreign DNA sequences confers a selective advantage that is frequently strong enough to result in the elimination of bacteria synthesizing the original recombinant within a few serial passages. Recombinant bacteriophages that harbor DNA inserts with long tracts of a single nucleotide (such as a segment of a eukaryotic cDNA containing the 3' poly(A) sequence or a fragment of DNA containing multiple copies of a short repeated sequence) are very susceptible to rearrangement. These bacteriophages should be grown for the shortest possible periods of time and never for more than 8 hours.

---

**POLYETHYLENE GLYCOL**

---

Polyethylene glycol (PEG) is a straight-chain polymer of a simple repeating unit  $\text{H}(\text{OCH}_2\text{CH}_2)_n\text{OH}$ . PEG is available in a range of molecular weights whose names reflect the number ( $n$ ) of repeating units in each molecule. In PEG 400, for example,  $n = 8-9$ , whereas in PEG 4000,  $n$  ranges from 68 to 84.

PEG induces macromolecular crowding of solutes in aqueous solution (Zimmerman and Minton 1993) and has a range of uses in molecular cloning, including:

- Precipitation of DNA molecules according to their size (Lis and Schleif 1975a,b; Ogata and Gilbert 1977; Lis 1980).
- Precipitation and purification of bacteriophage particles (Yamamoto et al. 1970).
- Increasing the efficiency of reassociation of complementary chains of nucleic acids during hybridization, blunt-end ligation of DNA molecules, and end-labeling of DNA with bacteriophage T4 polynucleotide kinase (Zimmerman and Minton 1993).
- Fusion of cultured cells with each other or with bacterial protoplasts (Schaffner 1980; Rassoulzadegan et al. 1982).

## REFERENCES

- Achtman M., Willetts N., and Clark A.J. 1971. Beginning a genetic analysis of conjugational transfer determined by the F factor in *Escherichia coli* by isolation and characterization of transfer-deficient mutants. *J. Bacteriol.* **106**: 529–538.
- Alting-Mees M.A. and Short J.M. 1989. pBluescript II: Gene mapping vectors. *Nucleic Acids Res.* **17**: 9494.
- . 1993. Polycos vectors: A system for packaging filamentous phage and phagemid vectors using lambda phage packaging extracts. *Gene* **137**: 93–100.
- Banner D.W., Nave C., and Marvin D.A. 1981. Structure of the protein and DNA in fd filamentous bacteriophages. *Nature* **289**: 814–816.
- Barnes W.M. 1979. Construction of an M13 histidine-transducing phage: A single-stranded cloning vehicle with one *EcoRI* site. *Gene* **5**: 127–139.
- . 1980. DNA cloning with single-stranded phage cloning vectors. *Genet. Eng.* **2**: 185–200.
- Bauer M. and Smith G.P. 1988. Filamentous phage morphogenetic signal sequence and orientation of DNA in the virion and gene-V protein complex. *Virology* **167**: 166–175.
- Beck E. and Zink B. 1981. Nucleotide sequence and genome organization of filamentous bacteriophages f1 and fd. *Gene* **16**: 35–58.
- Beck E., Sommer R., Auerswald E.A., Kurz C., Zink B., Osterburg G., Schaller H., Sugimoto K., Sugisaki H., Okamoto T., and Takanami M. 1978. Nucleotide sequence of bacteriophage fd DNA. *Nucleic Acids Res.* **5**: 4495–4503.
- Beckwith J.R. 1964. Deletion analysis of *lac* operator region in *Escherichia coli*. *J. Mol. Biol.* **8**: 427–430.
- Bedbrook J.R. and Ausubel F.M. 1976. Recombination between bacterial plasmids leading to the formation of plasmid multimers. *Cell* **9**: 707–716.
- Birnboim H.C. and Doly J. 1979. A rapid extraction procedure for screening recombinant plasmid DNA. *Nucleic Acids Res.* **7**: 1513–1523.
- Bullock W.O., Fernandez J.M., and Short J.M. 1987. XL1-Blue: A high efficiency plasmid transforming *recA* *Escherichia coli* strain with beta-galactosidase selection. *BioTechniques* **5**: 376–379.
- Chen E.Y., Kuang W.J., and Lee A.L. 1991. Overview of manual and automated DNA sequencing by the dideoxy chain termination method. *Methods* **3**: 3–19.
- Close T.J., Christmann J.L., and Rodriguez R.L. 1983. M13 bacteriophage and pUC plasmids containing DNA inserts but still capable of beta-galactosidase alpha-complementation. *Gene* **23**: 131–136.
- Dente L., Cesareni G., and Cortese R. 1983. pEMBL: A new family of single-stranded plasmids. *Nucleic Acids Res.* **11**: 1645–1655.
- Dotto G.P. and Zinder N.D. 1983. The morphogenetic signal of bacteriophage f1. *Virology* **130**: 252–256.
- . 1984a. Reduction of the minimal sequence for initiation of DNA synthesis by qualitative or quantitative changes of an initiator protein. *Nature* **311**: 279–280.
- . 1984b. Increased intracellular concentration of an initiator protein markedly reduces the minimal sequence required for initiation of DNA synthesis. *Proc. Natl. Acad. Sci.* **81**: 1336–1340.
- Dotto G.P., Enea V., and Zinder N.D. 1981a. Gene II of phage f1: Its functions and products. *Proc. Natl. Acad. Sci.* **78**: 5421–5424.
- . 1981b. Functional analysis of bacteriophage f1 intergenic region. *Virology* **114**: 463–473.
- Dotto G.P., Horiuchi K., Jakes K.S., and Zinder N.D. 1983. Signals for the initiation and termination of synthesis of the viral strand of bacteriophage f1. *Cold Spring Harbor Symp. Quant. Biol.* **47**: 717–722.
- Endemann H. and Model P. 1995. Location of filamentous phage minor coat proteins in phage and in infected cells. *J. Mol. Biol.* **250**: 496–506.
- Enea V. and Zinder N.D. 1982. Interference-resistant mutants of phage f1. *Virology* **122**: 222–226.
- Felton J. 1983. M13 host strain JM103 contains two restriction systems. *BioTechniques* **1**: 42–43.
- Fulford W. and Model P. 1984. Gene X of bacteriophage f1 is required for phage DNA synthesis. Mutagenesis of in-frame overlapping genes. *J. Mol. Biol.* **78**: 137–153.
- . 1988. Regulation of bacteriophage f1 DNA replication. I. New functions for genes II and X. *J. Mol. Biol.* **203**: 49–62.
- Geider K. and Kornberg A. 1974. Conversion of the M13 viral single-strand to the double-stranded replicative form by purified proteins. *J. Biol. Chem.* **249**: 3999–4005.
- Geider K., Hohmeyer C., Haas R., and Meyer T.F. 1985. A plasmid cloning system utilizing replication and packaging functions of the filamentous bacteriophage fd. *Gene* **33**: 341–349.
- Gibson T.J. 1984. "Studies on the Epstein-Barr virus genome." Ph.D. thesis, Cambridge University, England.
- Glucksman M.J., Bhattacharjee S., and Makowski L. 1992. Three-dimensional structure of a cloning vector. X-ray diffraction studies of filamentous bacteriophage M13 at 7 Å resolution. *J. Mol. Biol.* **226**: 455–470.
- Gough J.A. and Murray N.E. 1983. Sequence diversity among related genes for recognition of specific targets in DNA molecules. *J. Mol. Biol.* **166**: 1–19.
- Gray C.W. 1989. Three-dimensional structure of complexes of single-stranded DNA-binding proteins with DNA. I. Ke and fd gene 5 proteins form left-handed helices with single-stranded DNA. *J. Mol. Biol.* **208**: 57–64.
- Gronenborn B. and Messing J. 1978. Methylation of single-stranded DNA in vitro introduces new restriction endonuclease cleavage sites. *Nature* **272**: 375–377.
- Guilfoyle R.A. and Smith L.M. 1994. A direct selection strategy for shotgun cloning and sequencing in the bacteriophage M13. *Nucleic Acids Res.* **22**: 100–107.
- Halloran N., Du Z., and Wilson R.K. 1993. Sequencing reactions for the applied biosystems 393A Automated DNA Sequence. *Methods Mol. Biol.* **23**: 297–315.
- Herrmann R., Neugebauer E., Pirkl E., Zentgraf H., and Schaller H. 1980. Conversion of bacteriophage fd into an efficient single-stranded DNA vector system. *Mol. Gen. Genet.* **177**: 231–242.
- Higashitani N., Higashitani A., and Horiuchi K. 1993. Nucleotide sequence of the primer RNA for DNA replication of filamentous bacteriophages. *J. Virol.* **67**: 2175–2181.
- Hofschneider P.-H. 1963. Untersuchungen über 'kleine' *E. coli* K-12 Bacteriophagen M12, M13, und M20. *Z. Naturforsch.* **18**: 203–205.
- Horiuchi K. 1980. Origin of DNA replication of bacteriophage f1 as the signal for termination. *Proc. Natl. Acad. Sci.* **77**: 5226–5229.
- Ish-Horowicz D. and Burke J.F. 1981. Rapid and efficient cosmid

- cloning. *Nucleic Acids Res.* **9**: 2989–2998.
- Ierpseth B., Greener A., Short J.M., Viola J., and Kretz P.L. 1992. XL1-Blue MRF *E. coli* cells: McrA<sup>-</sup>, McrCB<sup>-</sup>, McrF<sup>-</sup>, Mrr<sup>-</sup>, HsdR<sup>-</sup> derivative of XL1-Blue cells. *Strategies Newsletter* **5**: 81–83. Stratagene, La Jolla, California.
- Konings R.N.H. and Schoenmakers J.G.G. 1978. Transcription of the filamentous phage genome. In *The single-stranded DNA phages* (ed. D.T. Denhardt et al.), pp. 507–530. Cold Spring Harbor Laboratory, Cold Spring Harbor, New York.
- Kunapuli S.P. and Colman R.W. 1993. Two new phagemid vectors for site-directed mutagenesis and expression in *E. coli*. *BioTechniques* **3**: 332, 336–338.
- Lerner T.J. and Model P. 1981. The “steady-state” of coliphage f1: DNA synthesis late in infection. *Virology* **115**: 282–294.
- Levinson A., Silver D., and Seed B. 1984. Minimal size plasmids containing an M13 origin for production of single-stranded transducing particles. *J. Mol. Appl. Genet.* **2**: 507–517.
- Lin J.-J., Smith M., Jessee J., and Bloom F. 1992. DH11S: An *Escherichia coli* strain for preparation of single-stranded DNA from phagemid vectors. *BioTechniques* **12**: 718–721.
- Lis J.T. 1980. Fractionation of DNA fragments by polyethylene glycol induced precipitation. *Methods Enzymol.* **65**: 347–352.
- Lis J.T. and Schleif R. 1975a. Size fractionation of double-stranded DNA by precipitation with polyethylene glycol. *Nucleic Acids Res.* **2**: 383–389.
- . 1975b. The regulatory region of the L-arabinose operon: Its isolation on a 1000 base-pair fragment from DNA heteroduplexes. *J. Mol. Biol.* **95**: 409–416.
- Loeb T. 1960. Isolation of a bacteriophage specific for the F<sup>+</sup> and Hfr mating types of *Escherichia coli* K12. *Science* **131**: 932–933.
- Loeb T. and Zinder N.D. 1961. A bacteriophage containing RNA. *Proc. Natl. Acad. Sci.* **47**: 282–289.
- Lopez J. and Webster R.E. 1983. Morphogenesis of filamentous bacteriophage f1: Orientation of extrusion and production of polyphage. *Virology* **127**: 177–193.
- . 1985. Assembly site of bacteriophage f1 corresponds to adhesion zones between the inner and outer membrane of the host. *J. Bacteriol.* **163**: 1270–1274.
- Lyons L.B. and Zinder N.D. 1972. The genetic map of the filamentous bacteriophage f1. *Virology* **49**: 45–60.
- Makowski L. 1984. Structural diversity in filamentous bacteriophages. In *Biological macromolecules and assemblies. I. Virus structures* (ed. F.A. Journak and A. MacPherson), pp. 203–253. Wiley, New York.
- . 1994. Phage display: Structure assembly and engineering of filamentous bacteriophage M13. *Curr. Opin. Struct. Biol.* **4**: 225–230.
- Marvin D.A. and Hoffman-Berling H. 1963. Physical and chemical properties of two new small bacteriophages. *Nature* **197**: 517–518.
- Marvin D.A. and Hohn B. 1969. Filamentous bacterial viruses. *Bacteriol. Rev.* **33**: 172–209.
- Marvin D.A., Hale R.D., Nave C., and Citterich M.H. 1994. Molecular models and structural comparisons of native and mutant class I filamentous bacteriophages Ff (fd, f1, M13), fI1 and fIc. *J. Mol. Biol.* **235**: 260–286.
- Mazur B.J. and Model P. 1973. Regulation of coliphage f1 single-stranded DNA synthesis by a DNA-binding protein. *J. Mol. Biol.* **78**: 285–300.
- Mazur B.J. and Zinder N.D. 1975. The role of gene V protein in f1 single-strand synthesis. *Virology* **68**: 490–502.
- McClary J.A., Witney F., and Geisselsoder J. 1989. Efficient site-directed in vitro mutagenesis using phagemid vectors. *BioTechniques* **7**: 282–289.
- McDonnell P.A., Shon K., Kim Y., and Opella S.J. 1993. fd coat protein structure in membrane environments. *J. Mol. Biol.* **223**: 447–463.
- Mead D.A., Szczesna-Skorupa E.S., and Kemper B. 1985. Single-stranded DNA SP6 promoter plasmids for engineering mutant RNAs and proteins: Synthesis of a “stretched” preproprathyroid hormone. *Nucleic Acids Res.* **13**: 1103–1118.
- Messing J. 1979. A multipurpose cloning system based on the single-stranded DNA bacteriophage M13. *Recomb. DNA Tech. Bull.* **2**: 43–48.
- . 1981. M13mp2 and derivatives: A molecular cloning system for DNA sequencing, strand-specific hybridization and in vitro mutagenesis. In *Recombinant DNA: Proceedings of the 3rd Cleveland Symposium on Macromolecules* (ed. A.G. Walton), pp. 22–36. Elsevier, Amsterdam, The Netherlands.
- . 1983. New M13 vectors for cloning. *Methods Enzymol.* **101**: 20–78.
- . 1991. Cloning in M13 phage or how to use biology at its best. *Gene* **100**: 3–12.
- . 1993. M13 cloning vehicles. Their contribution to DNA sequencing. *Methods Mol. Biol.* **23**: 9–22.
- . 1996. Cloning single-stranded DNA. *Mol. Biotechnol.* **5**: 39–47.
- Messing J., Crea R., and Seeburg P.H. 1981. A system for shotgun sequencing. *Nucleic Acids Res.* **9**: 309–321.
- Messing J., Gronenborn B., Müller-Hill B., and Hofschneider P.H. 1977. Filamentous coliphage M13 as a cloning vehicle: Insertion of a HindII fragment of the lac regulatory region in M13 replicative form in vitro. *Proc. Natl. Acad. Sci.* **74**: 3642–3246.
- Meyer T.F., Geider K., Kurz C., and Schaller H. 1979. Cleavage site of bacteriophage fd gene II-protein in the origin of viral strand replication. *Nature* **278**: 365–367.
- Model P. and Russel M. 1988. Filamentous bacteriophage. In *The bacteriophages* (ed. R. Calendar), vol. 2, pp. 375–456. Plenum Press, New York.
- Model P., McGill C., Mazur B., and Fulford W.D. 1982. The replication of bacteriophage f1: Gene V protein regulates the synthesis of gene II protein. *Cell* **29**: 329–335.
- Müller-Hill B., Crapo L., and Gilbert W. 1968. Mutants that make more lac repressor. *Proc. Natl. Acad. Sci.* **59**: 1259–1264.
- Ogata R. and Gilbert W. 1977. Contacts between the lac repressor and the thymines in the lac operator. *Proc. Natl. Acad. Sci.* **74**: 4973–4976.
- Opella S.J., Cross T.A., DiVerdi J.A., and Sturm C.F. 1980. Nuclear magnetic resonance of the filamentous bacteriophage fd. *Biophys. J.* **32**: 531–548.
- Peeters B.P.H., Schoenmakers J.G.G., and Konings R.N.H. 1986. Plasmid pKUN9, a versatile vector for the selective packaging of both DNA strands into single-stranded DNA-containing phage-like particles. *Gene* **41**: 39–46.
- Picken R.N. 1990. Method for the direct detection of both orientations of an insert in M13. *BioTechniques* **9**: 412–413.
- Pratt D., Tzagaloff H., and Beaudoin J. 1969. Conditional lethal mutants of the small filamentous coliphage M13. II. Two genes for coat proteins. *Virology* **39**: 42–53.
- Radding C.M. 1982. Homologous pairing and strand exchange in genetic recombination. *Annu. Rev. Genet.* **16**: 405–437.
- Rasched I. and Oberer E. 1986. Ff coliphages: Structural and functional relationships. *Microbiol. Rev.* **50**: 401–427.
- Rassoulzadegan M., Binetruy B., and Cuzin F. 1982. High frequency of gene transfer after fusion between bacteria and

- eukaryotic cells. *Nature* **295**: 257–259.
- Reddy P. and McKenney K. 1996. Improved method for the production of M13 phage and single-stranded DNA for DNA sequencing. *BioTechniques* **20**: 854–860.
- Russel M. 1991. Filamentous phage assembly. *Mol. Microbiol.* **5**: 1607–1613.
- . 1994. Phage assembly: A paradigm for bacterial virulence factor export? *Science* **265**: 612–614.
- . 1995. Moving through the membrane with filamentous phages. *Trends Microbiol.* **3**: 223–228.
- Russel M., Kidd S., and Kelley M.R. 1986. An improved filamentous helper phage for generating single-stranded plasmid DNA. *Gene* **45**: 333–338.
- Salivar W.O., Henry T.J., and Pratt D. 1967. Purification and properties of diploid particles of coliphage M13. *Virology* **32**: 41–51.
- Salstrom J.D. and Pratt D. 1971. Role of coliphage M13 gene 5 in single-stranded DNA production. *J. Mol. Biol.* **61**: 489–501.
- Sanger F., Coulson A.R., Barrell B.G., Smith A.J., and Roe B.A. 1980. Cloning in single-stranded bacteriophage as an aid to rapid DNA sequencing. *J. Mol. Biol.* **143**: 161–178.
- Sanger F., Donelson J.E., Coulson A.R., Kossel H., and Fischer H. 1973. Use of DNA polymerase I primed by a synthetic oligonucleotide to determine a nucleotide sequence in phage f1 DNA. *Proc. Natl. Acad. Sci.* **70**: 1209–1213.
- Schaffner W. 1980. Direct transfer of cloned genes from bacteria to mammalian cells. *Proc. Natl. Acad. Sci.* **77**: 2163–2167.
- Scott J.R. and Zinder N.D. 1967. Heterozygotes of phage f1. In *The molecular biology of viruses* (ed. J.S. Colter and W. Paranchych), pp. 212–281. Academic Press, New York.
- Seed B. 1983. Purification of genomic sequences from bacteriophage libraries by recombination and selection *in vivo*. *Nucleic Acids Res.* **11**: 2427–2445.
- Short J.M., Fernandez J.M., Sorge J.A., and Huse W.D. 1988.  $\lambda$ ZAP: A bacteriophage  $\lambda$  expression vector with *in vivo* excision properties. *Nucleic Acids Res.* **16**: 7583–7600.
- Ullmann A. and Perrin D. 1970. Complementation in  $\beta$ -galactosidase. In *The lactose operon* (ed. J.R. Beckwith and D. Zipser), pp. 143–172. Cold Spring Harbor Laboratory, Cold Spring Harbor, New York.
- Ullmann A., Jacob F., and Monod J. 1967. Characterization by *in vitro* complementation of a peptide corresponding to an operator-proximal segment of the  $\beta$ -galactosidase structural gene of *Escherichia coli*. *J. Mol. Biol.* **24**: 339–343.
- van Wezenbeek P.M.G.F., Hulsebos T.J.M., and Schoenmakers J.G.G. 1980. Nucleotide sequence of the filamentous bacteriophage M13 DNA genome: Comparison with phage fd. *Gene* **11**: 129–148.
- Vieira J. and Messing J. 1987. Production of single-stranded plasmid DNA. *Methods Enzymol.* **153**: 3–11.
- . 1991. New pUC-derived cloning vectors with different selectable markers and DNA replication origins. *Gene* **100**: 189–194.
- Webster R.E. 1991. The *tol* gene products and the import of macromolecules into *Escherichia coli*. *Mol. Microbiol.* **5**: 1005–1011.
- Webster R.E. and Lopez J. 1985. Structure and assembly of the class I filamentous bacteriophages. In *Virus structure and assembly* (ed. S. Casjens), pp. 235–267. Jones and Bartlett, Boston, Massachusetts.
- Webster R.E., Grant R.A., and Hamilton L.A.W. 1981. Orientation of the DNA in the filamentous bacteriophage f1. *J. Mol. Biol.* **152**: 357–374.
- Yamamoto K.R., Alberts B.M., Benzinger R., Lawhorne L., and Treiber G. 1970. Rapid bacteriophage sedimentation in the presence of polyethylene glycol and its application to large-scale virus purification. *Virology* **40**: 734–744.
- Yanisch-Perron C., Vieira J., and Messing J. 1985. Improved M13 phage cloning vectors and host strains: Nucleotide sequences of the M13mp18 and pUC19 vectors. *Gene* **33**: 103–119.
- Yen T.S.B. and Webster R.E. 1982. Translational control of bacteriophage f1 gene II and gene X proteins by gene V protein. *Cell* **29**: 337–345.
- Zacher III, A.N., Stock III, C.A., Golden II, J.W., and Smith G.P. 1980. A new filamentous phage cloning vector: fd-tet. *Gene* **9**: 127–140.
- Zagursky R.J. and Berman M.L. 1984. Cloning vectors that yield high levels of single-stranded DNA for rapid DNA sequencing. *Gene* **27**: 183–191.
- Zaman G.J.R., Schoenmakers J.G.G., and Konings R.N.H. 1990. Translational regulation of M13 gene II protein by its cognate single-stranded DNA binding protein. *Eur. J. Biochem.* **189**: 119–124.
- Zimmerman S.B. and Minton A.P. 1993. Macromolecular crowding: Biochemical, biophysical and physiological consequences. *Annu. Rev. Biophys. Biomol. Struct.* **22**: 27–65.

# Chapter 4

## Working with High-capacity Vectors

### INTRODUCTION

### PROTOCOLS

1	Construction of Genomic DNA Libraries in Cosmid Vectors	4.11
2	Screening an Unamplified Cosmid Library by Hybridization: Plating the Library onto Filters	4.24
	• Additional Protocol: Reducing Cross-hybridization	4.27
3	Amplification and Storage of a Cosmid Library: Amplification in Liquid Culture	4.28
4	Amplification and Storage of a Cosmid Library: Amplification on Filters	4.31
	• Alternative Protocol: Amplification on Plates	4.34
5	Working with Bacteriophage P1 and Its Cloning Systems	4.35
	• Additional Protocol: Purification of High-molecular-weight DNA by Drop Dialysis	4.44
	• Alternative Protocol: Purification of High-molecular-weight Circular DNA by Chromatography on Qiagen Resin	4.45
6	Transferring P1 Clones between <i>E. coli</i> Hosts	4.46
7	Working with Bacterial Artificial Chromosomes	4.48
8	Isolation of BAC DNA from Small-scale Cultures	4.53
9	Isolation of BAC DNA from Large-scale Cultures	4.55
10	Working with Yeast Artificial Chromosomes	4.58
11	Growth of <i>S. cerevisiae</i> and Preparation of DNA	4.67
12	Small-scale Preparations of Yeast DNA	4.70
13	Analyzing Yeast Colonies by PCR	4.72
14	Isolating the Ends of Genomic DNA Fragments Cloned in High-capacity Vectors: Vectorette Polymerase Chain Reactions	4.74

### INFORMATION PANELS

<i>Cre-loxP</i>	4.82
Large-fragment Cloning Products and Services	4.86

**T**HE REASON THAT WE KNEW SO LITTLE FOR SO LONG OF THE HUMAN GENOME is its immense scale: 3 billion or more base pairs containing ~1 million exons grouped into an estimated 40,000 to 60,000 genes distributed among 23 pairs of chromosomes. However, if current estimates are correct, we have moved in less than 50 years from the discovery of the structure of DNA in 1953 to

**TABLE 4-1 High-capacity Vectors for Genomic Cloning**

VECTOR	CAPACITY (KB)	REPLICON	HOST	COPY NUMBER	INTRODUCTION INTO CELLS	SCREENING FOR RECOMBINANTS	RECOVERY OF CLONED DNA
Cosmid	30–45	colE1	<i>E. coli</i>	high	transduction	not necessary	alkaline extraction
P1	70–100	P1	<i>E. coli</i>	1 (amplifiable)	transduction	<i>sacB</i>	alkaline extraction
PAC	130–150	P1	<i>E. coli</i>	1	electroporation	<i>sacB</i>	alkaline extraction
BAC	120–300	F	<i>E. coli</i>	1	electroporation	$\alpha$ -complementation	alkaline extraction
YAC	250–400	ARS	yeast	1	transformation	<i>ade2</i>	pulse-field gels

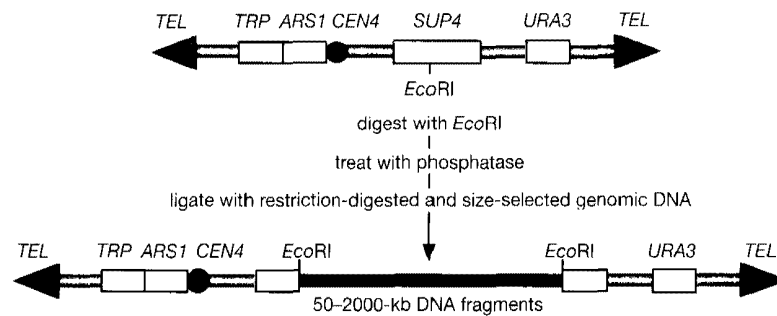
the elucidation of the complete sequence of the human genome in the year 2000. That we have learned so much about the human genome during the last decade is in part due to the development of a series of vectors with the capacity to propagate large segments of genomic DNA. These vectors have been instrumental in the rapid assembly of overlapping arrays of individual clones (contigs) in which each recombinant contains a piece of genomic DNA that partially overlaps DNA carried by its neighbor. Such physical maps grant access to genes that in their entirety may sprawl over several hundred kilobases; they fuel DNA sequencing mills; and they provide points through which physical and genetic maps may be riveted together.

There are five major types of high-capacity vectors. Because physical maps of eukaryotic chromosomes are built by linking together overlapping clones, it might seem that the vector with the largest capacity would be preferred for construction of framework maps. However, it turns out that each vector has its own set of advantages and disadvantages (please see below and Table 4-1), and, in consequence, physical maps of chromosomal regions are typically constructed from a mosaic of DNA fragments cloned in different vectors.

- **Yeast artificial chromosomes (YACs)** are linear DNA molecules whose architecture mimics that of authentic yeast chromosomes (Burke et al. 1987). Recombinant YACs are created by ligating large fragments of genomic DNA to two “arms” of a YAC vector, and the ligation mixture is then introduced into yeast by transformation. Each of the arms carries a selectable marker, as well as appropriately oriented DNA sequences that function as telomeres. In addition, one of the two arms carries centromeric DNA segments and an origin of replication (also called an autonomously replicating sequence or ARS). In recombinant YACs, therefore, a segment of foreign genomic DNA becomes flanked on one side by a centromere, an origin of replication, and a selectable marker and on the other side by the second selectable marker. Yeast transformants that have taken up and stably maintained an artificial chromosome are identified as colonies on selective agar plates.

Most YAC vectors in current use are designed to allow facile distinction between clones that are empty and those that carry inserts of genomic DNA (please see Figure 4-1). For example, in several YAC vectors, insertion of DNA into the cloning site interrupts a suppressor tRNA gene and results in the formation of red rather than white colonies by yeast strains that carry an ochre mutation in the *ade2* gene. Because YACs have no packaging constraints that limit their cloning capacity, the average size of the inserts is determined chiefly by the quality of the preparation of genomic DNA. Most YAC libraries contain between 250 kb and 400 kb of foreign DNA per clone. However, libraries of mammalian genomic DNA have been constructed containing clones whose size exceeds 1 Mb.

- **Bacterial artificial chromosomes (BACs)** are circular DNA molecules that carry an antibiotic resistance marker, a stringently controlled replicon derived from the F factor (fertility factor) of *Escherichia coli* (Shizuya et al. 1992), an ATP-driven helicase (*repE*) to facilitate DNA replication, and three loci (*parA*, *parB*, and *parC*) to ensure accurate partitioning of low-copy-number plasmids to daughter cells. Segments of foreign genomic DNA are ligated to the ~7-

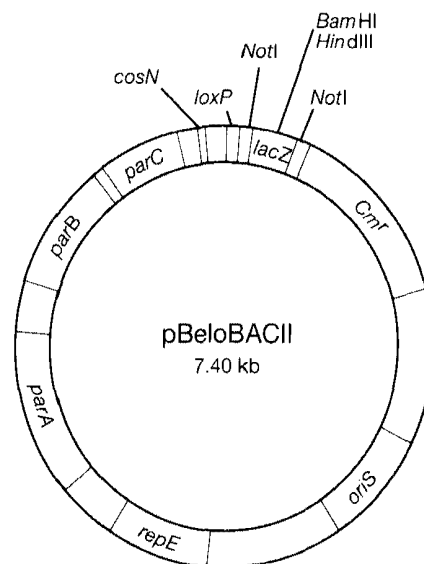


**FIGURE 4-1 Cloning in YAC Vectors**

The genome of the YAC vector includes two selectable markers (*TRP* and *URA*), an autonomously replicating sequence (*ARS1*), a centromere (*CEN4*), a suppressor tRNA gene (*SUP4*), and telomeric sequences (*TEL*) at the termini.

kb BAC vector *in vitro*, and the ligation mixture is introduced by electroporation into well-characterized recombination-deficient strains of *E. coli*, where they become established as single-copy plasmids.

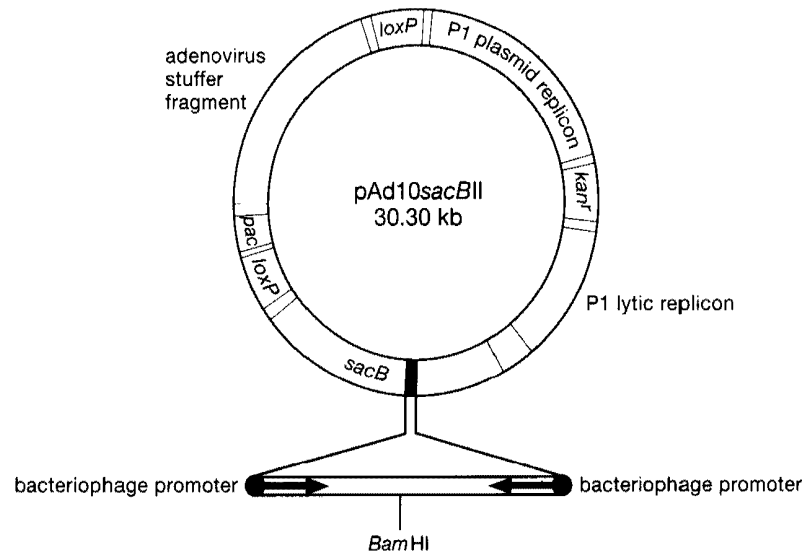
The first generation of BAC vectors (Shizuya et al. 1992) carried no markers that could be used to distinguish between antibiotic-resistant bacterial colonies carrying recombinants and those carrying empty vectors. Newer BAC vectors allow screening by  $\alpha$ -complementation to identify recombinants with inserts and are equipped with sites to facilitate recovery and manipulation of cloned DNAs (see Figure 4-2) (Kim et al. 1996; Asakawa et al. 1997). BACs, like YACs and PACs (P1 artificial chromosomes), have no packaging constraints and there is no fixed limit to the size of genomic DNA that they can accept. The median size of clones in most



**FIGURE 4-2 Diagram of pBeloBACII**

The circular vector contains genes *parA*, *parB*, and *parC* derived from the fertility factor (*F* factor) of *E. coli* to ensure that the low-copy-number plasmid is accurately partitioned to daughter cells during division of its bacterial host. In addition, the vector carries genes (*oriS* and *repC*) involved in initiation and orientation of DNA replication; a chloramphenicol resistance gene (*Cm<sup>r</sup>*); an element (*lacZ*) that allows color-based identification of recombinants; *loxP* and *cosN* sites that facilitate recovery of cloned sequences; and restriction sites that can be used to clone large fragments of genomic DNA.



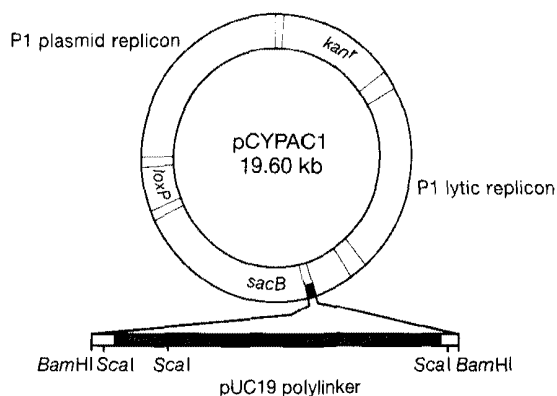


**FIGURE 4-3** Diagram of pAd10sacBII

The left-hand side of the circular vector contains two *loxP* sites, a plasmid origin of DNA replication, a minimal signal (*pac*) for packaging into P1 particles, and a stuffer fragment derived from adenovirus DNA. The right-hand side contains a kanamycin resistance gene (*kan<sup>r</sup>*); a replicon (P1 plasmid replicon) derived from bacteriophage P1 that allows the vector to replicate as a low-copy-number plasmid in *E. coli*; an inducible replicon (P1 lytic replicon) that can be used to increase the copy number of the plasmid; and a selectable marker (*sacB*) containing a cloning site (*Bam*HI) flanked by promoters derived from bacteriophages SP6 and T7.

BAC libraries is ~120 kb, whereas the largest individual recombinant BACs contain ~300 kb of genomic DNA.

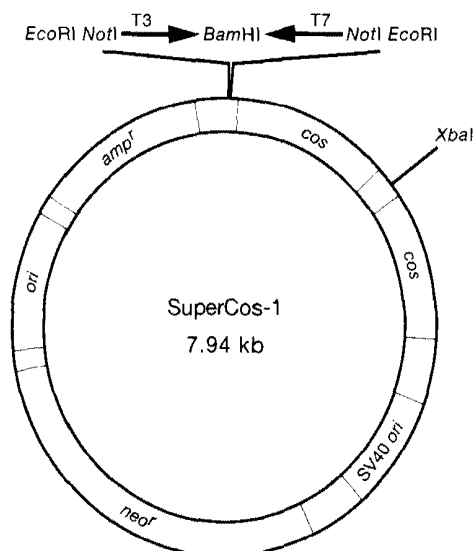
- **Bacteriophage P1 vectors** contain many *cis*-acting elements derived from bacteriophage P1 and will accommodate fragments of genomic DNA between 70 kb and 100 kb (Figure 4-3) (Sternberg 1990, 1992, 1994). In this system, linear recombinant molecules consisting of genomic and vector sequences are packaged *in vitro* into bacteriophage P1 particles, which have a total capacity (vector plus insert) of 115 kb. After injection into a strain of *E. coli* expressing Cre recombinase, the linear DNA molecules are circularized by recombination between two *loxP* sites present in the vector. The vector carries, in addition, a general selectable marker (*kan<sup>r</sup>*), a positive selection marker (*sacB*) for clones that carry inserts of foreign DNA, and a P1 plasmid replicon, which maintains the circular recombinant plasmids at ~1 copy per cell. A second P1 replicon (the P1 lytic replicon), under the control of the inducible *lac* promoter, can be used to amplify the plasmid before isolation of DNA.
- **P1 artificial chromosomes** combine the best features of P1 vectors and BACs, including the positive selection marker (*sacB*) and the plasmid and lytic replicons of bacteriophage P1 (please see Figure 4-4). However, instead of packaging ligation products into bacteriophage particles, and instead of using site-specific recombination at *cre-loxP* sites to generate plasmid molecules, circular recombinant PACs generated during ligation *in vitro* are introduced into *E. coli* by electroporation and are then maintained as single-copy plasmids (Ioannou et al. 1994). The inserts in PAC-based libraries of human genomic DNA range in size from 60 kb to 150 kb (Ioannou et al. 1994; Strong et al. 1997).
- **Cosmids**, the oldest of the five types of vectors used for analysis of complex genomes (Collins and Hohn 1978), also have the smallest capacity: 43–45 kb of foreign DNA stretches cosmids to their limit. Cosmid vectors are conventional plasmids that contain one or two copies of a



**FIGURE 4-4** Diagram of pCYPAC1

The vector contains a subset of the genetic elements contained in pAd10sacBII (Figure 4-3), a kanamycin resistance gene (*kan<sup>r</sup>*), a *loxP* site, a replicon (P1 plasmid replicon) derived from bacteriophage P1 that allows the vector to replicate as a low-copy-number plasmid in *E. coli*; an inducible replicon (P1 lytic replicon) that can be used to increase the copy number of the plasmid; and a selectable marker (*sacB*) containing a variety of cloning sites.

small region of bacteriophage  $\lambda$  DNA—the cohesive end site (*cos*)—which contains all of the *cis*-acting elements required for packaging of viral DNA into bacteriophage  $\lambda$  particles (please see Figure 4-5) (for review, please see Hohn 1979; Hohn et al. 1988). Linear concatenated DNA substrates, suitable for packaging in vitro, are generated by ligating restriction fragments containing a *cos* sequence to each end of a genomic DNA molecule. During packaging, the two flanking *cos* sequences are cleaved by the bacteriophage  $\lambda$  *ter* function to generate a linear molecule with termini that are complementary to one another but not identical (Feiss et al. 1983; please see the panel on  $\lambda$  **TERMINASE** in the introduction to Chapter 2). After injection into susceptible bacterial cells, the complementary termini anneal to one another and are sealed by the host's DNA ligase, generating circular DNA molecules carrying a colicin E1 (*colE1*) plasmid replicon and a selectable marker. Bacterial colonies selected on plates containing the appropriate antibiotic carry multiple copies of recombinant cosmids.



**FIGURE 4-5** Diagram of SuperCos-1 (Stratagene)

This cosmid vector contains two *cos* sites separated by a unique *XbaI* restriction site, an SV40 origin of replication (SV40 *ori*), two antibiotic resistance genes (*neo<sup>r</sup>* and *amp<sup>r</sup>*), a *colE1* origin of replication (*ori*), and a cloning site flanked by bacteriophage promoters.

## CONSTRUCTING LIBRARIES OF GENOMIC DNA

Genomic libraries are constructed by cloning segments of DNA generated by partial digestion of high-molecular-weight genomic DNA with restriction enzymes (Maniatis et al. 1978). In some cases, these fragments are fractionated by preparative gel electrophoresis or density gradient centrifugation to select those of a size suitable for insertion into the vector.

In theory, every DNA sequence in the target genome should be proportionally represented in a library of recombinant clones. In practice, this ideal is never realized. Instead, in libraries of complex genomes, some DNA sequences are missing entirely and others may be overrepresented to varying degrees. Such bias is the inevitable result of the methods that are used to construct genomic libraries.

Gaps in coverage arise in part because there is no truly random method to shear complex genomes, irrespective of their sequence and base composition. Since genomic libraries are typically generated by partial digestion of high-molecular-weight DNA, the composition of the resulting population of size-selected fragments depends on the distribution of restriction sites within the genomic DNA and on the relative rates at which these sites are cleaved. Unfortunately, the distribution of restriction sites is far from normal and the efficiency of digestion at different sites is influenced by surrounding sequences (for review, please see Brooks 1987). Regions rich in restriction sites tend to be underrepresented because they are quickly reduced to an unacceptably small size. Conversely, impoverished regions may be excluded because they generate fragments that are too large. For theoretical treatment of these problems, please see Seed (1982), Seed et al. (1982), and Tang and Waterman (1990). Although there is no general solution, juggling with digestion conditions can sometimes be used to correct underrepresentation of specific sequences in genomic libraries (e.g., please see Wong et al. 1993).

Gaps in coverage are inevitable because libraries are at best a statistical sampling of a population of restriction fragments. The size and number of these "statistical" gaps depend on the number of genome equivalents carried in the entire library (please see the panel on **GENOMIC LIBRARIES**). For example, a cosmid library of human genomic DNA consisting of 75,000 clones of ~40-kb DNA fragments would contain a total of  $3 \times 10^9$  bp of human DNA, or one haploid equivalent. Even if the 40-kb cloned fragments were generated by entirely random cleavage of the original DNA preparation, and even if the packaging of these fragments into bacteriophage heads were also entirely random, the library would be far from complete. In this case, the probability that any DNA sequence of interest would not be represented in the library is ~37%. This problem can be ameliorated by increasing the depth of coverage of the library. For example, in a library of 750,000 cosmids that covers the genome ten times, there is an ~99.995% chance that

### GENOMIC LIBRARIES

The probability that any given DNA sequence will be represented in a genomic library can be calculated from the equation

$$N = \frac{\ln(1-P)}{\ln(1-f)}$$

where  $P$  is the desired probability,  $f$  is the fractional proportion of the genome in a single recombinant, and  $N$  is the necessary number of clones in the library (Clarke and Carbon 1976). For example, to achieve a 99% probability ( $P = 0.99$ ) of having a given DNA sequence represented in a library of 17-kb fragments of mammalian DNA ( $3 \times 10^9$  bp

$$N = \frac{\ln(1-0.99)}{\ln\left(1 - \frac{1.7 \times 10^4}{3 \times 10^9}\right)} = 8.1 \times 10^5$$

For more detailed mathematical treatments of genomic library construction and probability calculations, please see Seed (1982) and Seed et al. (1982).

the human DNA sequence of interest would be represented at least once. Unfortunately, because some genomic clones replicate better than others, additional bias in representation may occur as the library is replicated and expanded. Finally, because cloned sequences may undergo rearrangements during passage, there is no guarantee that any given recombinant clone isolated from a genomic library would necessarily carry an accurate copy of the corresponding genomic sequence.

Knowing that genomic libraries are always imperfect, pessimists and purists might throw up their hands and say "Enough." However, given the size, quality, number, depth of coverage, and proven performance of currently available libraries, optimists and pragmatists can remain confident knowing that the odds of isolating the desired genomic clones are stacked very much in their favor.

## CHOOSING AMONG VECTORS

---

The major variables that influence the choice of a vector for construction of genomic libraries are the size of the target region and the capacity of the vector, the ease of screening libraries, whether the vector is designed to facilitate chromosome walking, whether cloned DNA sequences can easily be purified and recovered, and, finally, whether instability of cloned sequences is likely to be a problem.

### Size of the Target Region

If the target region of the genome is very small (<50 kb), then bacteriophage  $\lambda$  or cosmids are the vectors of choice for the construction of genomic libraries. Unless the investigator works on an esoteric organism or wants to construct a library from a particular mutant strain, there is a good chance that a suitable cosmid library of genomic DNA already exists. If such a library is not available, well-defined cosmid vectors, highly efficient packaging mixtures, and suitable strains of *E. coli* are readily available from commercial sources. Preparation of the necessary high-molecular-weight genomic DNA should be within the capacity of any experienced laboratory (please see Chapter 6).

If the region of interest is too large to fit into a single cosmid or if there is good reason to believe that the region may be difficult to clone, a possible alternative is bacteriophage P1, PAC, or BAC libraries. Genomic libraries of many species are now available in these vectors. For a listing of companies that provide libraries and various cloning services, please see the information panel on **LARGE-FRAGMENT CLONING PRODUCTS AND SERVICES**. Although screening of existing libraries is straightforward, and generation of small P1 libraries is well within the capacity of most laboratories, de novo construction of large genomic libraries in P1 vectors remains a difficult undertaking. This is because the efficiency of packaging of DNA into bacteriophage P1 particles is relatively low and preparation of sufficient quantities of 75–90-kb fragments of genomic DNA is laborious. Until the efficiency (and cost) of P1 packaging improves, the PAC system may be a more reasonable alternative because it requires no experience with bacteriophage P1 or specialized reagents such as packaging mixtures.

If the region of interest is >250 kb in size, then YACs are the vectors of choice. However, as with bacteriophage P1, construction of new large genomic libraries in YAC vectors is probably best left to experts.

### The Ease of Screening Libraries

For cloning of small (<50 kb) sequences, genomic libraries in cosmid or bacteriophage  $\lambda$  vectors are generally prepared and maintained as a single pool of clones that are plated anew when screening by conventional hybridization. However, this process is too laborious and expensive for the construction of regional maps and contigs. More and more, genomic libraries are being maintained as two-dimensional arrays that can be screened for specific sequences, either by conventional hybridization with single-copy probes (for review, please see Bentley and Dunham 1995) or

as pools in microtiter dishes that can be screened by polymerase chain reaction (PCR)-based protocols. In the latter case, a pair of oligonucleotide primers, designed to amplify a specific target segment of DNA, are used to screen pools of clones. The number of clones in the pools decreases with each round of screening until the clone of interest is identified (Green and Olson 1990; Anand et al. 1991; for review, please see Evans et al. 1992; also see the panel on **ARRAYED LIBRARIES**). Reference libraries constructed in high-capacity vectors such as bacteriophage P1, BAC, and YAC are archived in this way as a resource that can be used by many groups (e.g., please see Francis et al. 1994; Shepherd et al. 1994; Zehetner and Lehrach 1994). Copies of the libraries are maintained at Human Genome Centers in the United States, Europe, Asia and Australasia, and some libraries may be accessible through commercial screening companies (please see Table 4-2 and the information panel on **LARGE-FRAGMENT CLONING PRODUCTS AND SERVICES**).

## Chromosome Walking

Chromosomal regions or individual genes that are too large to be isolated as a single segment of DNA can be cloned by chromosome walking as a series of overlapping fragments. In this technique, a segment of nonrepetitive DNA isolated from one end of a cloned segment of genomic DNA is used to rescreen the library for additional recombinant clones containing overlapping

### ARRAYED LIBRARIES

The idea of storing libraries as individually picked clones in microtiter dishes goes back to the very early days of cloning when the few available cDNA libraries were small in size and high in value. Transformed bacterial clones carrying recombinant plasmids were picked from the initial selective plates and transferred to wells of microtiter dishes containing liquid medium. Arraying libraries in this fashion eliminated competition between clones, reduced contamination by molds, and facilitated storage, replication, and screening.

The major disadvantage of arrayed libraries is the sheer number of clones that must be picked and stored in microtiter plates in order to accommodate a representative set. In the case of cDNA libraries, arraying is only worthwhile when a particular cDNA library is to be screened many times (Lennon and Lehrach 1991). However, arraying is certainly a cost-effective method for storing libraries of genomic DNA that have been constructed in "difficult" vectors such as YACs, BACs, and bacteriophage P1. Some YAC libraries are arrayed in microtiter dishes at a density of 1 clone/well, and others are arrayed as pools of specific size. P1 libraries are often stored as pools of 10–20 clones/well. The work involved in picking recombinant clones by hand and transferring them one at a time into microtiter dishes is formidable in its scale and depressing in its nature. However, several research groups and commercial companies have developed mechanical colony and plaque pickers that considerably ease the effort required to establish arrayed libraries. Furthermore, the use of higher-density arrays that compress several hundred clones onto a microscope slide reduces storage space at  $-70^{\circ}\text{C}$  (please see Appendix 10).

Arraying P1, BAC, and YAC genomic libraries has four advantages that together outweigh the problems of picking and storage.

- Each clone has a specific set of coordinates (dish number, row, and column) and can therefore be easily located and recovered. This feature is especially important when several laboratories are working on the same set of arrayed clones, since sharing of clones merely involves sharing of coordinates within the reference library.
- The arrayed format allows libraries to be screened in a combinatorial fashion. Individual clones are pooled into overlapping  $N$ -dimensional sets, which are then screened hierarchically by hybridization or PCR. The pattern of positive and negative results obtained from these pools can then be deciphered to identify the location of an individual clone that carries the sequences of interest (Kwiatkowski et al. 1990; Barillot et al. 1991; Amemiya et al. 1992). Once the appropriate pools are established, this combinatorial approach can greatly reduce the amount of labor involved in screening genomic libraries with many different probes. For example, in the scheme devised by Barillot et al. (1991), only 258 pools and 282 tests are needed to screen the 72,000 clones of a human genomic YAC library.
- The arrayed format naturally leads to an elimination of redundancy and a detection of overlapping clones during screening. Since a clone is always at the same address, its detection by two different probes is immediately obvious.
- The ordered layout of the library allows simple robotic devices to carry out many of the routine steps involved in the replication and screening.

TABLE 4-2 Widely Used Large-insert Human Genomic Libraries

LIBRARY AND CHARACTERISTICS	CONTACT INFORMATION
<b>CEPH Mega YAC Library<sup>d</sup></b> Number of clones: 23,808 Average insert length: 918 kb Genome equivalents: ~7 Estimated chimera frequency: 30–40% Constructed in yeast strain AB1380 using 46, XY cell line DNA Cohen et al. (1993)	Fondation Jean Dausset–CEPH (clones) E-mail: <a href="mailto:yac_manager@cephb.fr">yac_manager@cephb.fr</a> URL: <a href="http://www.cephb.fr/services/">http://www.cephb.fr/services/</a>  Research Genetics, Inc. (screening resources and clones) Fax: (205) 536-9016 E-mail: <a href="mailto:info@resgen.com">info@resgen.com</a> URL: <a href="http://www.resgen.com">http://www.resgen.com</a>  Genome Systems, Inc. (screening resources and clones) Fax: (314) 692-0044 E-mail: <a href="mailto:sales@genomesystems.com">sales@genomesystems.com</a> URL: <a href="http://www.genomesystems.com">http://www.genomesystems.com</a>  HGMP Resource Centre (screening resources and clones) E-mail: <a href="mailto:biohelp@hgmp.mrc.ac.uk">biohelp@hgmp.mrc.ac.uk</a> URL: <a href="http://www.hgmp.mrc.ac.uk">http://www.hgmp.mrc.ac.uk</a>
<b>Human PAC Library</b> Number of clones: ~500,000 Average insert length: 115 kb Genome equivalents: ~20 Estimated chimera frequency: <5% Constructed in PAC vector pCYPAC-1 using HSF1 fibroblast cell line DNA Ioannou et al. (1994)	Roswell Park Cancer Institute Contact: Pieter deJong E-mail: <a href="mailto:pieter@dejong.med.buffalo.edu">pieter@dejong.med.buffalo.edu</a> URL: <a href="http://bacpac.med.buffalo.edu">http://bacpac.med.buffalo.edu</a>  Research Genetics, Inc. (screening resources and clones) Fax: (205) 536-9016 E-mail: <a href="mailto:info@resgen.com">info@resgen.com</a> URL: <a href="http://www.resgen.com">http://www.resgen.com</a>  Genome Systems, Inc. (screening resources and clones) Fax: (314) 692-0044 E-mail: <a href="mailto:sales@genomesystems.com">sales@genomesystems.com</a> URL: <a href="http://www.genomesystems.com">http://www.genomesystems.com</a>  HGMP Resource Centre (screening resources and clones) E-mail: <a href="mailto:biohelp@hgmp.mrc.ac.uk">biohelp@hgmp.mrc.ac.uk</a> URL: <a href="http://www.hgmp.mrc.ac.uk">http://www.hgmp.mrc.ac.uk</a>
<b>CIT Human BAC Library</b> Number of clones: total ~680,000 (segment B: ~74,000, segment C: ~216,000, segment D: ~390,000) Average insert length: ~130 kb Genome equivalents: ~30 Estimated chimera frequency: <5% Constructed with DH10B/r using XY-fibroblast cell line DNA Shizuya et al. (1992)	Research Genetics, Inc. (screening resources, services, clones, and other specialized services) Fax: (205) 536-9016 E-mail: <a href="mailto:info@resgen.com">info@resgen.com</a> URL: <a href="http://www.resgen.com">http://www.resgen.com</a>
<b>RPCI-11 Human BAC Library</b> Number of clones: ~437,000 (four subsets with ~109,000 clones) Average insert length: ~175 kb Genome equivalents: 25 Estimated chimera frequency: <5% Constructed in BAC vector pBACe3.6 using male blood lymphocyte DNA K. Osoegawa et al. (unpubl.)	Roswell Park Cancer Institute (screening resources and clones) E-mail: <a href="mailto:pieter@dejong.med.buffalo.edu">pieter@dejong.med.buffalo.edu</a> URL: <a href="http://bacpac.med.buffalo.edu">http://bacpac.med.buffalo.edu</a>  Research Genetics, Inc. (screening resources, services, and clones) Fax: (205) 536-9016 E-mail: <a href="mailto:info@resgen.com">info@resgen.com</a> URL: <a href="http://www.resgen.com">http://www.resgen.com</a>

The libraries listed here are widely used by the human genome research community. Several other large-insert human libraries are available through the Roswell Park Cancer Institute, Research Genetics, Genome Systems, and the HGMP Resource Centre. Additional large-insert libraries are available from at least one of these suppliers for baboon, mouse, rat, dog, zebrafish, pufferfish (*Fugu* and *Spheroides*), maize, *Arabidopsis*, *Drosophila*, filaria, mosquito, *C. elegans*, *C. briggsae*, *Chlamydomonas*, *Cryptosporidium*, and *Halobacterium*.

<sup>d</sup>Copies of this library are maintained by many laboratories in the United States but are generally not available for outside screening. Copies for redistribution were sent to: Eric Lander, Fax: (617) 252-1933 (for U.S. distribution); Hans Lehrach, Fax: (49) (30) 8413 1380 (Berlin); M. Muramatsu, Fax: (81) (298) 36-9140 (Japan); Y. Nakamura, Fax: (81) (3) 3918-0342 (Japan); Z. Chen, Fax: (86) (21) 3180-300 (China).

(Reprinted, with permission, from *Current Protocols in Human Genetics* [ed. N.C. Dracopoli et al.] 1994 [©Wiley, New York].)

sequences. The new set of clones is then mapped and the sequences furthest away from the starting point are used to screen the library for a third time. This process (walking) is repeated until the entire region of interest has been recovered in a series of overlapping clones.

Most vectors used in recent years to construct genomic libraries carry promoters for bacteriophage-encoded RNA polymerases in regions immediately flanking the foreign DNA. This advance, and the development of PCR methods that use oligonucleotide cassettes, "vectorette" or "splinkerette," to amplify insert sequences immediately adjacent to each vector arm, has greatly simplified the task of generating end-specific probes (for reviews, please see Arnold and Hodgson 1991; Hengen 1995; Ogilvie and James 1996). However, chromosome walking remains a laborious process. High-capacity vectors that accommodate large segments of DNA are greatly preferred because they decrease the number of steps that are required to complete a chromosomal walk.

### Recovery of Cloned Sequences

Cosmids, bacteriophage P1, PAC, and BAC clones can be separated easily from *E. coli* chromosomal DNA by alkaline extraction. However, recovery of pure YACs from *Saccharomyces cerevisiae* is a major problem because there is no simple method to separate YAC DNA from the background of natural yeast chromosomal DNA. Purifying inserts of mammalian genomic DNA from YACs usually requires pulsed-field gel electrophoresis (PFGE) and/or direct subcloning of the entire yeast genome into bacteriophage  $\lambda$  or cosmid vectors. The subclones carrying mammalian sequences are then identified by their ability to hybridize to repetitive DNA probes.

### Stability of Cloned Sequences

Serious concerns have been raised over the years about the fidelity and stability of genomic sequences cloned in cosmids and YACs. In the case of cosmids, rearrangement of cloned DNA occurs because the recombinants are carried at high copy number in *E. coli*, a situation that often favors the emergence of shorter, deleted clones that can replicate faster than their parent. Genomic sequences cloned in YACs also undergo rearrangements, but for a different reason. Unlike cosmids, YACs do not exclude one another during transformation, and it is fairly common to find two or more YACs coexisting in the same cell. This provides opportunities for recombination between repetitive DNA sequences in the genomic DNA of different YACs. The products of this type of rearrangement are chimeric inserts that consist of DNA from two different chromosomal regions. More than 40% of the clones in YAC libraries may be chimeric, as judged from fluorescent in situ hybridization of individual YAC clones to spreads of mammalian chromosomes (Green et al. 1991; Selleri et al. 1992) or from characterizing subcloned YAC ends (Nagaraja et al. 1994).

### Summary

In summary, no single genomic vector is ideal for all purposes (please see Table 4-1, p. 4.2) and no single genomic library contains a perfect representation of the genome from which it is derived. For some investigators, the best option will be to screen a copy of an existing arrayed or pooled genomic library; for others, the only way forward may be to generate their own libraries; for an increasing number, the best course is to use the services of commercial organizations such as Genome Systems Inc., who, for a fee, will use oligonucleotides provided by the investigator to screen BAC and YAC libraries for clones that contain the desired sequences. Cloners who take pride in doing everything for themselves should take solace from the fact that it is considerably less expensive and by far quicker to use a commercial service than to set up screening of large-insert libraries in the laboratory. With these considerations in mind, we describe in this chapter methods for the construction and screening of cosmid libraries containing genomic DNA inserts, and the manipulation of individual bacteriophage P1, BAC, and YAC clones containing a gene or region of interest.

# Protocol 1

---

## Construction of Genomic DNA Libraries in Cosmid Vectors

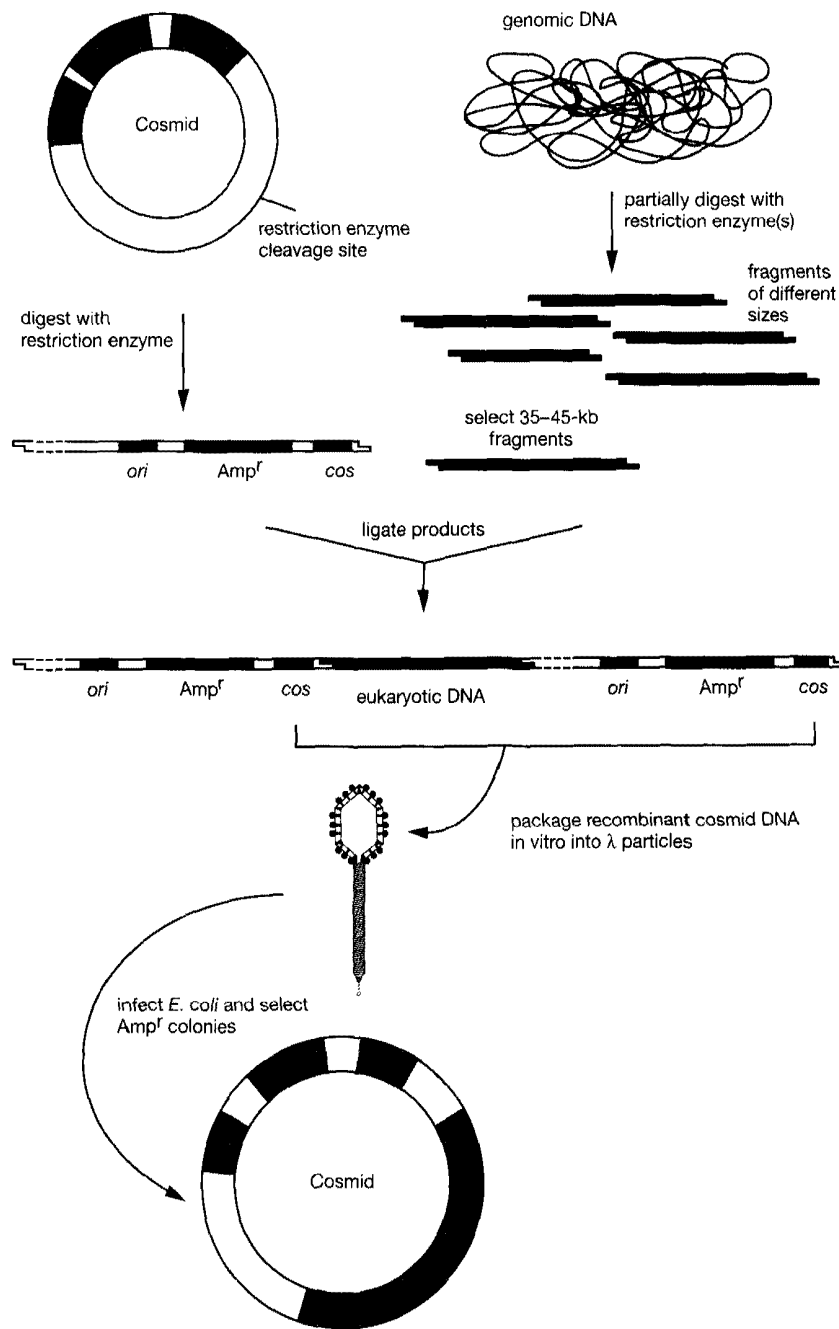
**E**SENTIALLY THE SAME PROCEDURES ARE USED TO CONSTRUCT genomic DNA libraries in both bacteriophage  $\lambda$  and cosmid vectors. In each system, segments of eukaryotic DNA are ligated in vitro to vector DNA, forming concatemers that can be packaged into bacteriophage  $\lambda$  particles. Libraries constructed in  $\lambda$  vectors are stored and propagated as infectious recombinant bacteriophages (please see Chapter 2). In cosmid cloning, however, bacteriophage particles generated by in vitro packaging serve merely as Trojan horses that deliver recombinant DNA molecules efficiently into bacteria, where the DNA circularizes and is propagated as large plasmids (please see Figure 4-6). Because cosmids are subject to the same packaging constraints as bacteriophage  $\lambda$  vectors and because cosmid vectors are typically ~5–7 kb in size, recombinant cosmids can contain no less than ~28 kb and no more than ~45 kb of foreign genomic DNA. Genomic fragments of a size appropriate for cloning are generally obtained by partial digestion of high-molecular-weight chromosomal DNA with a restriction enzyme that recognizes a 4-bp sequence and generates a cohesive terminus. The enzymes most widely used for this purpose are *Mbo*I and *Sau*3AI, which generate DNA fragments that can be cloned into a *Bam*HI site.

The aim when constructing a genomic DNA library in cosmids should be to generate recombinants in numbers sufficient to encompass five to seven equivalents of the target genome. A good cosmid library of a mammalian genome, with a haploid complement of  $\sim 3 \times 10^9$  bp of DNA, should therefore contain  $\geq 500,000$  individual transformants (please see the introduction to this chapter). Once created, the library is generally amplified and then stored frozen either as a single pool of transformed bacteria that is plated afresh for screening (Protocol 3), as a population of transformed colonies on nitrocellulose filters or LB-glycerol plates (Hanahan and Meselson 1980), or as an array of single or pooled transformants in wells of microtiter plates (Protocol 4) (Evans et al. 1992). Alternatively, and less frequently, the recombinant cosmids are rescued from the population of primary transformants by transduction and maintained as a stock of transducing bacteriophage particles.

Cosmid vectors can contain either one or two *cos* sites. Cloning into older, single *cos* vectors requires many steps, including the isolation of fragments of genomic DNA of the appropriate size (please see Figure 4-7). Because of the inefficiency of this and several other steps, generating representative libraries of complex genomes in single *cos* vectors has always been a challenging task.

A great improvement in cosmid design came with the inclusion of two *cos* sites in the vector (Bates and Swift 1983). These dual *cos* vectors have a singular advantage: They no longer require fractionation of partial digests of genomic DNA before ligation and packaging. Figure 4-8 shows how a cosmid vector with two *cos* sites (in this example, SuperCos-1; Evans et al. 1989) can be used to generate genomic libraries.

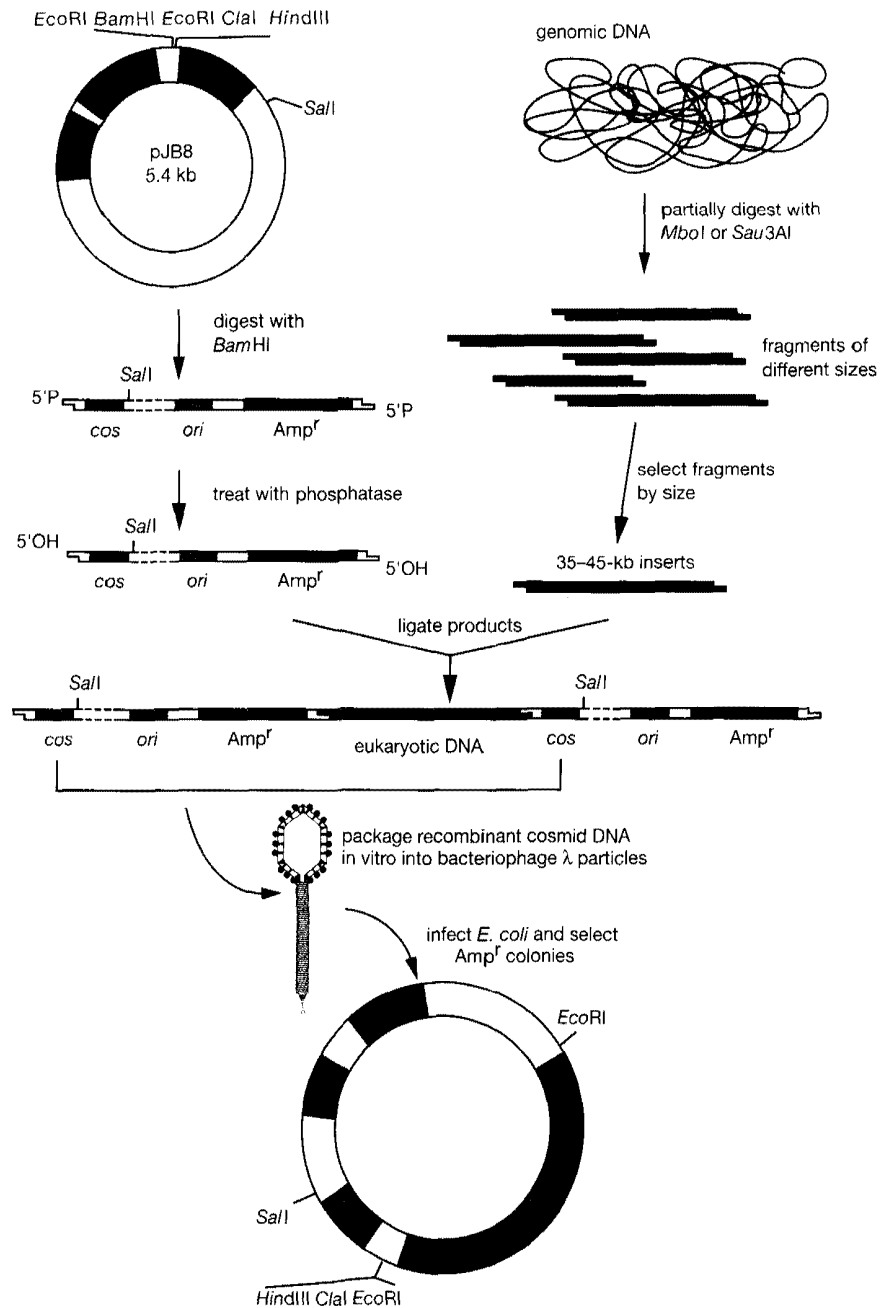




**FIGURE 4-6 Cloning in Cosmid Vectors**

Shown in diagrammatic form are the steps involved in cloning in cosmid vectors. The steps are discussed in detail in the text.

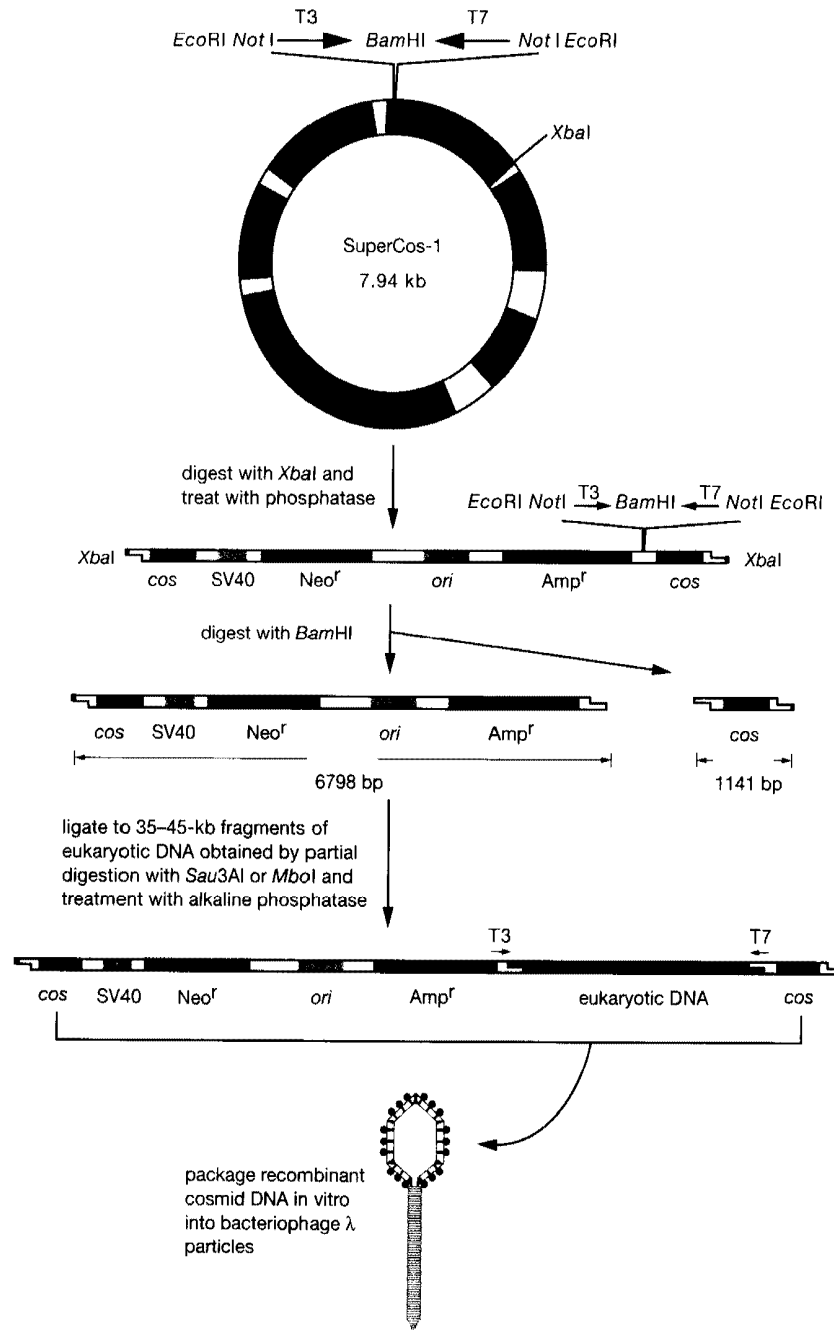
In vectors such as SuperCos-1, two *cos* sites are separated by a recognition site for a restriction enzyme that cleaves the vector only once (in this case, *Xba*I). The vector arms are prepared by first digesting the DNA with *Xba*I and then removing the 5'-terminal phosphate residues from the linearized cosmid by treatment with alkaline phosphatase. In a second digestion, the linearized double *cos* vector is digested with *Bam*HI to produce two arms, each of which carries a *cos* site. The two arms are then ligated to partially digested genomic DNA, generating, inter alia, molecules in which the two *cos* sites are oriented in the same manner and separated by eukaryotic DNA inserts.



**FIGURE 4-7 Cloning into Single *cos* Site Vectors (pJB8)**

The DNA of cosmid pJB8 is digested with *Bam*HI and dephosphorylated with alkaline phosphatase to yield a vector with protruding 5' termini that can be ligated to 35-45-kb fragments of eukaryotic DNA generated by partial digestion with *Mbo*I or *Sau*3AI. The resultant concatemers serve as substrate for in vitro packaging of bacteriophage  $\lambda$  particles. Following introduction into *E. coli*, the cosmid DNA recircularizes and replicates in the form of a large plasmid. The plasmid contains the  $\beta$ -lactamase gene that confers resistance to ampicillin on the host bacterium.

Although at best, only 50% of the concatemers can have the correct arrangement of *cos* sites, such molecules are packaged into bacteriophage  $\lambda$  heads with very high efficiency, provided they are between 35 kb and 52 kb in length (Feiss et al. 1977). When all is working well, between  $10^5$  and



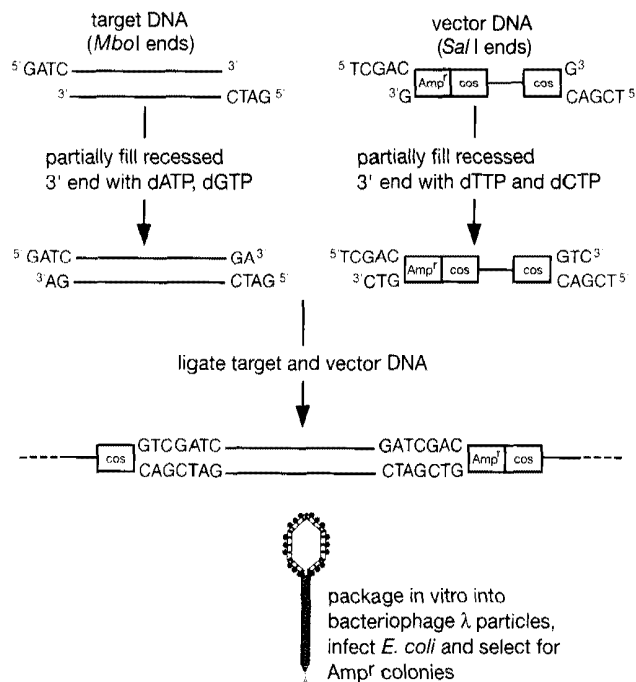
**FIGURE 4-8 Cloning into Double *cos* Site Vectors (SuperCos-1)**

Following digestion with *Xba*I and treatment with alkaline phosphatase, the cosmid DNA is further digested with *Bam*HI to separate the *cos* sequences that are now carried on separate fragments. The resulting cosmid DNA is ligated to dephosphorylated fragments of eukaryotic DNA obtained by partial digestion with *Mbo*I and treatment with alkaline phosphatase. These eukaryotic fragments carry termini that are compatible only with the *Bam*HI cohesive termini of the vector. The concatenated DNA is then packaged into bacteriophage  $\lambda$  particles that are used to infect a *recA*<sup>-</sup> strain of *E. coli*.

$2 \times 10^7$  transformed colonies are generated per microgram of genomic DNA (Bates 1987; Evans et al. 1992). With this level of efficiency, only 5  $\mu$ g of partially digested genomic DNA is needed to generate a library that is a reasonable representation of a mammalian genome.

During ligation, there is a risk that smaller fragments of eukaryotic DNA in the preparation will ligate to one another and to the cosmid vector producing recombinants that contain sequences derived from two or more noncontiguous segments of the genome. A population of DNA fragments with an average size of 42 kb will contain many molecules that are shorter than the mean. Although these shorter molecules may comprise only a fraction of the total weight of the DNA, they make a more substantial contribution to the number of molecules in the population. As the kinetics of ligation are determined by the concentration of reactive termini of DNA, these smaller molecules become preferentially incorporated into concatemers, which may be of a size suitable for packaging *in vitro*. Three methods are available to reduce the number of undesirable chimeric clones in cosmid libraries:

- As described in the following protocol, the partially digested genomic DNA may be treated with alkaline phosphatase before ligation.
- The cohesive ends of the genomic and cosmid DNAs may be partially filled so that they ligate only to each other and not to themselves (Hung and Wensink 1984; Zabarovsky and Allikmets 1986; Loftus et al. 1992). In this technique, genomic DNA is partially digested with *Mbo*I (GATC) and cosmid arms are prepared by cleavage with *Sal*I (GTCGAC). The cohesive termini generated by *Mbo*I and *Sal*I are not normally compatible, but partial filling of the recessed 3' termini in controlled reactions using the Klenow fragment of *E. coli* DNA polymerase I generates complementary termini and simultaneously destroys the ability of the original termini to self-anneal (please see Figure 4-9). Partial filling of the recessed termini therefore suppresses self-ligation and prevents formation of chimeric molecules of genomic DNA.



**FIGURE 4-9 Cloning into cos Vectors with Partial Filling in of Ends**

The strategy illustrated in this diagram allows the conversion of noncompatible termini of target and vector to compatible termini. Fragments of target DNA generated by digestion with *Mbo*I are partially filled with dATP, resulting in fragments carrying a 5' overhang of "GA." Similarly, vector DNA digested with *Sal*I is filled with dTTP and dCTP to generate termini, now complementary to the ends of the target fragments, carrying the 5' overhang of "TC." The ligated product is packaged into bacteriophage λ particles and used to infect an appropriate strain of *E. coli*.

- The partially digested genomic DNA can be fractionated according to size by agarose gel electrophoresis or centrifugation through sucrose or NaCl gradients before ligation to the cosmid arms. However, because of the inevitable losses associated with these techniques, sizing of partial digestion products can be used only when high-molecular-weight genomic DNA is available in abundance. Even then, most laboratories have difficulty in recovering sufficient DNA of the proper size for cloning. For this reason, sizing is nowadays the least favored of the three available options to reduce the number of chimeric clones in cosmid libraries.

A great variety of cosmid vectors are available, many of them carrying specialized functions. Among these are selectable genes for drug resistance, which may be used to establish mammalian cell lines that have incorporated cosmid sequences after transfection. Other features include bacteriophage promoters for the production of RNA probes complementary to the termini of the cloned genomic DNA sequences, recognition sites for restriction enzymes that cleave mammalian DNA very rarely (e.g., *NotI*, *Sall*, *SacII*, *PacI*; please see Table 4-3) and may allow the cloned segment to be isolated from the cosmid in one piece, sequences that facilitate homologous recombination between cosmids, multiple cloning sites, and replicons of several different types. For examples of these vectors, please see the Appendix 3 and Hohn et al. (1988).

**TABLE 4-3 Frequency of Restriction Endonuclease Sites in the Human Genome**

ENZYME	SEQUENCE	AVERAGE FRAGMENT SIZE (KB)	ESTIMATED NUMBER OF SITES
<i>Apal</i>	GGGCC	2	$1.5 \times 10^6$
<i>Ascl</i>	GGCGCGCC	80	$3.75 \times 10^4$
<i>AvrII</i>	CCTAGG	8	$3.75 \times 10^5$
<i>BamHI</i>	GGATCC	5	$6 \times 10^5$
<i>BglI</i>	GCCN <sub>2</sub> GGC	3	$1 \times 10^6$
<i>BglII</i>	AGATCT	3	$1 \times 10^6$
<i>BssHII</i>	GCGCGC	10	$3 \times 10^5$
<i>DraI</i>	TTTAAA	2	$1.5 \times 10^6$
<i>EagI</i>	CGGCCG	10	$3 \times 10^5$
<i>EcoRI</i>	GAATTC	5	$6 \times 10^5$
<i>HindIII</i>	AAGCTT	4	$7.5 \times 10^5$
<i>NaeI</i>	GCCGGC	4	$7.5 \times 10^5$
<i>NarI</i>	GGCGCC	4	$7.5 \times 10^5$
<i>NheI</i>	GCTAGC	10	$3 \times 10^5$
<i>NotI</i>	GCGGCCGC	100	$3 \times 10^4$
<i>PacI</i>	TTAATTAA	60	$5 \times 10^4$
<i>PmeI</i>	GTTTAAAC	70	$4.3 \times 10^4$
<i>RsrI</i>	CGGWCCG	60	$5 \times 10^4$
<i>SacI</i>	GAGCTC	3	$1 \times 10^6$
<i>SacII</i>	CCGCGG	6	$5 \times 10^5$
<i>Sall</i>	GTCGAC	20	$1.5 \times 10^5$
<i>SbfI</i>	CCTGCAGG	15	$2 \times 10^5$
<i>SfiI</i>	GGCCN <sub>2</sub> GGCC	30	$1 \times 10^5$
<i>SgrAI</i>	CRCCGGYC	70	$4.3 \times 10^4$
<i>SmaI</i>	CCCGGG	4	$7.5 \times 10^5$
<i>SpeI</i>	ACTAGT	10	$3 \times 10^5$
<i>SphI</i>	GCATGC	6	$5 \times 10^5$
<i>SrfI</i>	GCCCCGGC	50	$6 \times 10^4$
<i>SspI</i>	AATATT	2	$1.5 \times 10^6$
<i>SwaI</i>	ATTTAAAT	30	$1 \times 10^5$
<i>XbaI</i>	TCTAGA	5	$6 \times 10^5$
<i>XhoI</i>	CTCGAG	7	$4.3 \times 10^5$

Adapted with permission, 1998/99 New England Biolabs Catalog (©NEB).

The following protocol, describing the construction of a genomic DNA library, has been written with SuperCos-1 in mind. However, the procedure can easily be adapted for use with other cosmid vectors that contain two *cos* sites (e.g., please see Evans et al. 1989) and for use with different combinations of restriction enzymes. Procedures for screening libraries are presented in Protocol 2, and for amplifying libraries in Protocols 3 and 4.

## MATERIALS

---

**CAUTION:** Please see Appendix 12 for appropriate for appropriate handling of materials marked with <!.>.

### Buffers and Solutions

Please see Appendix 1 for components of stock solutions, buffers, and reagents. Dilute stock solutions to the appropriate concentrations.

Chloroform <!.>  
 10x Dephosphorylation buffer (CIP buffer)  
 Ethanol  
 Phenol:chloroform (1:1, v/v) <!.>  
 SM  
 Sodium acetate (3 M, pH 5.2)  
 TE (pH 8.0)

### Enzymes and Buffers

Bacteriophage T4 DNA ligase  
 Calf intestinal phosphatase (CIP)  
 Restriction endonucleases: BamHI, MboI, XbaI  
 Restriction endonucleases that cleave cosmid vector but not the genomic insert DNA

### Gels

Agarose gels (0.7%) cast in 0.5x TBE, containing 0.5 µg/ml of ethidium bromide <!.>  
 Please see Step 24.  
 Agarose gel (0.8%) cast in 0.5x TBE, containing 0.5 µg/ml of ethidium bromide  
 Please see Steps 2 and 8, and the panel following Step 6.  
 Pulsed-field gels (or 0.5% agarose gels)  
 Please see Steps 10, 11, and 26, and the panel on PULSED-FIELD GEL ELECTROPHORESIS on the following page.

### Media

TB agar plates containing 25 µg/ml kanamycin  
 TB medium  
 TB medium containing 25 µg/ml kanamycin

### Nucleic Acids and Oligonucleotides

Control DNA: bacteriophage λ DNA digested with HindIII  
 Control DNA: superhelical SuperCos-1 DNA  
 High-molecular-weight genomic DNA  
 Linearized plasmid in 1x dephosphorylation buffer  
 Please see the panel after Step 6.  
 Marker DNA: linear bacteriophage λ DNA

## Special Equipment

Water baths preset to 16°C and 65°C

## Additional Reagents

Step 10 of this protocol requires the reagents listed in Chapter 2, Protocol 17.

Step 23 of this protocol requires the reagents listed in Chapter 1, Protocol 1.

## Vectors and Bacterial Strains

### *Bacteriophage λ packaging mixtures*

Packaging mixtures may be purchased in a kit form from any of several companies (e.g., Gigapack III XL Packaging Extract, Stratagene). Please see note to Step 19 and the information panel on **IN VITRO PACKAGING** in Chapter 2.

### *Bacteriophage λ stock*

Please see panel following Step 6.

*E. coli* plating bacteria of the appropriate strain for titering packaged cosmid (e.g., XL1-Blue, ED8767, NM554, DH5αMCR)

For a complete listing of appropriate strains, please see Appendix 3.

*SuperCos-1 DNA* (Stratagene)

### **PULSED-FIELD GEL ELECTROPHORESIS**

PFGE is the preferred method to measure the size of an insert in a high-capacity vector. After digestion with a restriction enzyme (e.g., *NotI*), the DNA fragments are separated by pulsed-field electrophoresis through a 1% agarose gel. Transverse alternating field electrophoresis (TAFE, please see Chapter 5, Protocol 17) resolves DNA fragments between 50 kb and 500 kb in a program in which switch times are ramped from 7 to 50 seconds/pulse at 9 V/cm for 20–24 hours at 15°C (Shizuya et al. 1992). Alternatively, a CHEF hexagonal array system can be used with switch times ramping from 1 to 150 seconds/pulse at 9 V/cm for 20 hours at 15°C (Zimmer and Verrinder Gibbins 1997). For additional information on PFGE, please see Chapter 5.

## METHOD

### Linearization and Dephosphorylation of SuperCos-1 DNA

1. Combine 20 µg of SuperCos-1 DNA with 50 units of *XbaI* in a volume of 200 µl of 1x *XbaI* digestion buffer and incubate the reaction mixture for 2–3 hours at 37°C.
2. After 2 hours of incubation, transfer an aliquot (~1 µl) of the reaction mixture to a fresh tube. Analyze the aliquot of cosmid DNA by electrophoresis through an 0.8% agarose gel, using as controls (i) 50–100 ng of superhelical SuperCos-1 DNA and (ii) 50–100 ng of a bacteriophage λ DNA digested with *HindIII*.
  - If the digestion with the restriction enzyme is complete, all of the superhelical SuperCos-1 DNA will have been converted to a linear 7.9-kb fragment of DNA.
  - If superhelical or nicked forms of SuperCos-1 DNA are still visible, add 10 more units of *XbaI* to the digest and continue incubation at 37°C until the reaction has gone to completion.
  - If the *XbaI* digestion is not complete, the library will contain a significant number of colonies generated by concatemerization of the vector.
3. Extract the digestion reaction once with phenol:chloroform and once with chloroform.
4. Transfer the aqueous phase to a fresh tube and recover the linearized cosmid DNA by standard precipitation with ethanol and subsequent washing in 70% ethanol. Store the open tube

in an inverted position on a bed of paper towels to allow the ethanol to drain and evaporate. Dissolve the damp pellet of DNA in 180  $\mu$ l of H<sub>2</sub>O. Remove a 100-ng aliquot of the DNA for use as a control (please see the panel on **DEPHOSPHORYLATION REACTIONS**).

In some cosmid vectors (e.g., 2CRB), the two *cos* sites are separated by cleavage with a restriction enzyme that creates blunt ends. In this case, dephosphorylation of the linearized vector (Step 5) is no longer necessary. This is because concatemerization of the vector can be suppressed very effectively by including high concentrations of ATP (5 mM) in the ligation buffer (Ferretti and Sgaramella 1981). Dephosphorylation of the genomic DNA must still be carried out to prevent creation of chimeric clones.

5. Add 20  $\mu$ l of 10 $\times$  dephosphorylation buffer to the remainder of the DNA solution. Add 0.1 unit of CIP and incubate the reaction for 30 minutes at 37°C. Add a second aliquot (0.1 unit) of CIP and continue digestion for an additional 30 minutes. Transfer the reaction to a water bath set at 65°C and incubate for 30 minutes to inactivate CIP. Remove two 100-ng aliquots of the DNA for use as controls (please see the panel on **DEPHOSPHORYLATION REACTIONS**).
6. Extract the reaction mixture once with phenol:chloroform and once with chloroform. Recover the linearized, dephosphorylated SuperCos-1 DNA by standard precipitation with ethanol and subsequent washing in 70% ethanol. Dissolve the damp pellet of DNA in 180  $\mu$ l of H<sub>2</sub>O.

#### DEPHOSPHORYLATION REACTIONS

Successful construction of a genomic library in double *cos* vectors requires that the linearized vector be completely dephosphorylated. Unfortunately, there is no simple way to monitor the progress of the dephosphorylation reaction catalyzed by alkaline phosphatases. However, since DNA molecules lacking 5'-terminal phosphate residues cannot be ligated together, the success or failure of the dephosphorylation reaction can be assessed by testing whether the linearized DNA can serve as a substrate in ligation reactions catalyzed by bacteriophage T4 DNA ligase. The outcome of the ligation reaction can be checked either by agarose gel electrophoresis (please see below) or by comparing the efficiency with which dephosphorylated and phosphorylated cosmid DNAs can, after ligation, transform *E. coli*. Dephosphorylation should reduce the efficiency of transformation by at least 100-fold.

1. At the completion of Step 4, transfer a 100-ng aliquot of *Xba*I-digested DNA to a fresh microfuge tube (Tube 1).
2. At the completion of Step 5, transfer two 100-ng aliquots of *Xba*I-digested/CIP treated vector DNA to separate microfuge tubes (Tubes 2 and 3).
3. To all three tubes, add 18  $\mu$ l of H<sub>2</sub>O followed by 2  $\mu$ l of 10 $\times$  ligase buffer.
4. To Tubes 1 and 2, add 0.2 Weiss units of bacteriophage T4 DNA ligase. Incubate all three tubes for 3 hours at room temperature.
5. Analyze the DNAs by electrophoresis through an 0.8% agarose gel.

The DNA digested with *Xba*I alone (Tube 1) should ligate to itself, forming dimers, closed circular monomers, and higher-order multimers. After removal of 5'-terminal phosphate residues, the DNA should no longer be capable of ligation (Tube 2) and should therefore display an electrophoretic pattern similar to that of the DNA of Tube 3 (no ligase control). If any ligation products are visible in the DNA of Tube 2, the dephosphorylation reaction (Step 5) must be repeated.

#### Isolation of the Cosmid Arms

7. Transfer an aliquot of the dephosphorylated DNA (50–100 ng) to a fresh microfuge tube and store it on ice. Add 20  $\mu$ l of 10 $\times$  *Bam*HI restriction buffer to the remainder of the desphosphorylated DNA. Add 40 units of *Bam*HI and incubate the reaction for 2–3 hours at 37°C.
8. After 2 hours of incubation, remove a second aliquot of DNA to a separate microfuge tube. Analyze both aliquots of DNA by agarose gel electrophoresis. After digestion with *Bam*HI, the



linear 7.9-kb fragment of dephosphorylated SuperCos-1 DNA should be quantitatively cleaved into two DNA fragments of ~1.1 and ~6.8 kb.

If traces of the 7.9-kb DNA are still visible, add 10 more units of *Bam*HI to the digest and continue incubation at 37°C until the reaction has gone to completion.

9. Extract the digestion reaction once with phenol:chloroform and once with chloroform. Recover the DNA by standard precipitation with ethanol followed by washing with 70% ethanol. Dissolve the damp pellet of DNA in 20  $\mu$ l of H<sub>2</sub>O and store the solution at 4°C until needed.

### Partial Digestion of High-molecular-weight Genomic DNA

10. Establish the conditions for partial digestion of a 30- $\mu$ g sample of high-molecular-weight genomic DNA with *Mbo*I. The aim is to establish conditions that produce the highest yield of DNA fragments with a modal size of 38–52 kb.

For guidance in establishing conditions for partial digestion of genomic DNA, please see Chapter 2, Protocol 17. The progress of the digestion can be followed by PFGE or, less desirably, by electrophoresis through a 0.5% agarose gel using as markers (i) unit-length bacteriophage  $\lambda$  DNAs and/or (ii) multimers of bacteriophage  $\lambda$  DNA ligated at the *cos* site and then partially digested with a restriction enzyme that cleaves the linear  $\lambda$  DNA once. The 0.5% agarose gels are very sloppy and are best poured and run at 4°C at low voltage (1–2 V/cm) for long periods of time (15–24 hours).

When only small amounts of the genomic DNA are available (e.g., when constructing libraries of flow-sorted chromosomes or gel-purified YAC DNAs), conditions for partial digestion can be established in small-scale reactions containing 50–100 ng of genomic DNA and different amounts (0.0005–0.001 unit) of restriction enzyme. After digestion for 15 minutes, aliquots (10–20 ng) of each reaction are analyzed by PFGE and Southern blotting with a repetitive DNA probe. For further details, please see Longmire et al. (1993).

11. Using the conditions for partial digestion established in Step 10, set up three large-scale reactions each containing 100  $\mu$ g of high-molecular-weight genomic DNA and amounts of *Mbo*I that bracket the optimal concentration, as determined in Step 10. At the end of the incubation period, check the size of an aliquot of each partially digested DNA by agarose gel electrophoresis, as described in the note to Step 10.
12. Pool the two samples of partially digested genomic DNA that contain the highest amounts of DNA in the 38–52-kb range. Extract the pooled DNAs once with phenol:chloroform and once with chloroform. Recover the DNA by standard precipitation with ethanol and subsequent washing in 70% ethanol. Dissolve the damp pellet of DNA in 180  $\mu$ l of TE (pH 8.0).

Resuspension is best accomplished by allowing the DNA pellet to soak in TE overnight at 4°C. Do not vortex the DNA. Instead, mix the DNA by gently tapping the sides of the tube (please see the information panel on **MINIMIZING DAMAGE TO LARGE DNA MOLECULES** in Chapter 2). If only small amounts of DNA are available, as is the case when constructing cosmid libraries from flow-sorted eukaryotic chromosomes or from purified YACs, then, instead of ethanol precipitation, purify the DNA by drop dialysis against TE (pH 8.0) with floating membranes, as described in Protocol 5.

### Dephosphorylation of High-molecular-weight Genomic DNA

13. To the resuspended partially digested genomic DNA, add 20  $\mu$ l of 10 $\times$  dephosphorylation buffer and 2 units of CIP. Immediately withdraw a sample of DNA for use as a control:
  - a. Remove an aliquot of the reaction containing 0.1–1.0  $\mu$ g of DNA to a small (0.5 ml) microfuge tube containing 0.3  $\mu$ g of a linearized plasmid in 1 $\times$  dephosphorylation buffer (e.g., pUC cleaved with *Bam*HI).

- b. Set up a second control that contains 0.3  $\mu\text{g}$  of the same linearized plasmid in 10  $\mu\text{l}$  of 1x dephosphorylation buffer.  
Do not add CIP to this control.
- c. Follow the instructions in Steps 14–16.
14. Incubate the large-scale dephosphorylation reaction and the two controls for 30 minutes at 37°C. Then transfer the three reactions to a water bath set at 65°C and incubate them for 30 minutes to inactivate CIP.
15. Cool the reactions to room temperature. Purify the DNAs by extracting once with phenol:chloroform and once with chloroform. Recover the DNA by standard precipitation with ethanol and subsequent washing in 70% ethanol.  
If only small amounts (<1  $\mu\text{g}$ ) of genomic DNA are present in the test dephosphorylation reaction, dialyze the extracted DNA against TE (pH 7.6) with floating membranes as described in the panel on **ADDITIONAL PROTOCOL: PURIFICATION OF HIGH-MOLECULAR-WEIGHT DNA BY DROP DIALYSIS** in Protocol 5.
16. Dissolve the two control DNAs in 10  $\mu\text{l}$  of 1x ligation buffer. Add 0.1 Weiss unit of bacteriophage T4 DNA ligase to each tube and incubate them for 3 hours at room temperature. Examine the ligated DNAs by agarose gel electrophoresis.  
There should be no evidence of ligation in the control reaction containing genomic and plasmid DNAs that was subject to phosphatase treatment, whereas the untreated plasmid DNA should be converted to multimers and closed circular molecules.
17. Allow the DNA in the large-scale reaction to dissolve overnight at 4°C in a small volume of  $\text{H}_2\text{O}$ . Aim for a final concentration of ~500  $\mu\text{g}$  of DNA/ml. Estimate the concentration of DNA by agarose gel electrophoresis, or better, by measuring  $A_{260}$ .

### Ligation of Cosmid Arms to Genomic DNA: Packaging and Plating Recombinants

18. Set up a series of ligation reactions (final volume 20  $\mu\text{l}$ ) containing:
- |  |                              |
|--|------------------------------|
| cosmid arms DNA (Step 9)               | 2 $\mu\text{g}$              |
| dephosphorylated genomic DNA (Step 17) | 0.5, 1, or 2.5 $\mu\text{g}$ |
| 10x ligation buffer                    | 2 $\mu\text{l}$              |
| bacteriophage T4 DNA ligase            | 2 Weiss units                |

Incubate the ligation reactions for 12–16 hours at 16°C.

When using vectors in which the two *cos* sites are separated by cleavage with a restriction enzyme that creates blunt ends, the ligation buffer should be supplemented with ATP to a final concentration of 5 mM. This addition inhibits ligation of blunt ends (Ferretti and Sgarrella 1981) and thereby suppresses concatemerization of the vector.

19. Package 5  $\mu\text{l}$  of each of the ligation reactions in bacteriophage  $\lambda$  particles (equivalent to 0.5  $\mu\text{g}$  of vector arms) using a commercial packaging kit and following the conditions recommended by the supplier. After packaging, add 500  $\mu\text{l}$  of SM and 20  $\mu\text{l}$  of chloroform to the reactions and then store the diluted reactions at 4°C.

The size of the inserts that can be cloned in cosmids is affected by the method used to prepare packaging extracts (Bates and Swift 1983). Ideally, extracts used to package cosmids should be prepared using a buffer that contains spermidine but not putrescine. When putrescine is omitted from the packaging extract and the packaging reaction, the system exhibits selectivity in the size of DNA molecules that are packaged. Thus, DNA that is 80% of wild-type bacteriophage DNA in length is packaged 200-fold less efficiently than wild-type bacteriophage  $\lambda$  DNA itself. In the absence of putrescine, cosmids that contain large inserts (~45 kb) will be preferentially packaged. For unknown reasons, possibly because of a shortage of *ter* function, some preparations of packaging extracts that work well with bacteriophage  $\lambda$  DNA are not suitable for packaging cosmids. Some

commercially available packaging extracts, such as the Gigapack III XL extract from Stratagene, are better than others for construction of cosmid libraries.

20. Measure the titer of the packaged cosmids in each of the packaging reactions by transduction into an appropriate *E. coli* host. Mix 0.1 ml of a  $10^{-2}$  dilution of an aliquot of each reaction with 0.1 ml of SM and 0.1 ml of fresh plating bacteria. Allow the bacteriophage particles containing the recombinant cosmids to adsorb by incubating the infected bacterial cultures for 20 minutes at 37°C. Add 1 ml of TB medium and continue the incubation for a further 45 minutes at 37°C to allow expression of the kanamycin resistance gene in the SuperCos-1 vector.

Store the remainder of the packaging mixtures at 4°C until Steps 21–24 have been completed (2–3 days).

The ability of a strain of *E. coli* to be infected efficiently with bacteriophage  $\lambda$  should always be tested before it is used to propagate the cosmid library. This control is best done by measuring the infectivity of a bacteriophage  $\lambda$  stock of known titer on the plating bacteria.

21. Spread 0.5 ml and 0.1 ml of the bacterial culture onto TB agar plates containing kanamycin (25  $\mu$ g/ml). After incubating the plates overnight at 37°C, count the number of bacterial colonies.

Each microgram of ligated cosmid-eukaryotic DNA should yield between  $10^5$  and  $10^7$  bacterial colonies.

22. Pick 12 individual colonies and grow small-scale (2.5 ml) cultures in TB containing 25  $\mu$ g/ml kanamycin for periods of no longer than 6–8 hours. Shake the cultures vigorously during incubation.

For unknown reasons, the yield of some recombinant cosmids is poor when cultures of the host bacteria are grown to late log phase.

### Isolation and Analysis of Recombinant Cosmids: Validation of the Library

23. Isolate cosmid DNA from 1.5 ml of each of the 12 small-scale bacterial cultures using the alkaline lysis method, described in Chapter 1, Protocol 1.

For some applications, it may be necessary to purify minipreparations of cosmid DNA further. For details, please see the panel on **CLEANING UP COSMID DNA**.

24. Digest 2–4  $\mu$ l of each of the DNA preparations with restriction enzymes (e.g., *NotI* and *Sall*) that cleave the cosmid vector but are unlikely to cleave the cloned insert of genomic DNA. Analyze the sizes of the resulting fragments by electrophoresis through a 0.7% agarose gel.

Use as markers linear bacteriophage  $\lambda$  DNA and *HindIII* fragments of bacteriophage  $\lambda$  DNA, which can be prepared easily in the laboratory and are also available commercially.

25. Calculate the proportion of colonies that carry inserts.
26. Estimate the average size of the inserts by isolating a few dozen clones and measuring the size of inserts by PFGE (for details, please see Chapter 5, Protocol 17 or 18).
27. Calculate the “depth” of the library, i.e., how many genome equivalents it contains (please see the panel on **GENOMIC LIBRARIES**, in the chapter introduction).

If the library is satisfactory in size and quality, proceed to plate and screen the library by hybridization (Protocol 2) or, alternatively, to amplify and store the library (Protocols 3 and 4)

If difficulties are encountered during construction of the library, try to work out the most likely reasons for the failure of the experiment. For example, a high proportion of “empty” clones might indicate that the vector DNA was not completely dephosphorylated (Step 5). A disappointingly small number of recombinants might indicate that insufficient amounts of genomic DNA or cosmid arms were present in the ligation reaction or that packaging of concatemers into bacteriophage  $\lambda$  particles was inefficient.

#### **CLEANING UP COSMID DNA**

Small-scale preparations of cosmid DNA are sometimes not suitable for use as a template for *in vitro* transcription by bacteriophage DNA-dependent RNA polymerases, for labeling with biotin- or digoxigenin-modified dNTPs, or for use as a probe in fluorescent *in situ* hybridization (FISH) experiments. Additional purification steps are required for these and other fastidious techniques:

1. Extract the DNA once with phenol:chloroform and once with chloroform.
2. Collect the DNA by standard precipitation with ethanol and subsequent washing in 70% ethanol.
3. Dissolve the DNA in 100  $\mu$ l of TE (pH 7.6) and then precipitate the DNA again by adding NaCl and PEG 8000 to final concentrations of 0.4 M and 6.5% (w/v), respectively. Incubate the reaction for 2 hours at 0°C.
4. Collect the DNA by standard ethanol precipitation and subsequent washing in 70% ethanol. Dissolve the damp pellet of DNA in a small volume of DEPC-treated H<sub>2</sub>O.

# Protocol 2

---

## Screening an Unamplified Cosmid Library by Hybridization: Plating the Library onto Filters

**D**ENSE POPULATIONS OF BACTERIAL COLONIES TRANSFORMED BY COSMIDS may be screened by hybridization using a method originally devised for mass screening of plasmid-transformed colonies (Hanahan and Meselson 1980). The following protocol is a variant of the original method (DiLella and Woo 1987; please see Chapter 1, Protocol 30), adapted for plating and screening unamplified libraries. Colonies may be plated onto either nitrocellulose or nylon filters. In certain cases, it may be desirable to amplify the library before screening. Methods for amplification of cosmid libraries are given in Protocols 3 and 4.

---

### MATERIALS

#### Media

*TB agar plates (150 mm) containing 25 µg/ml kanamycin*  
*TB medium*

#### Special Equipment

*Glass plates (thick)*  
Sterilize two plates by swabbing with ethanol and allowing them to dry in a laminar flow hood.  
*Hypodermic needle (17 gauge)*  
*Nitrocellulose or Nylon filters (137 mm), sterile*  
*Whatman No. 1 filter papers, sterile*

#### Additional Reagents

Step 16 of this protocol requires the reagents listed in Chapter 1, Protocols 31 and 32.

#### Vectors and Bacterial Strains

*Bacteriophage λ packaging reaction*  
Please see Protocol 1, Step 19 of this chapter.  
*E. coli plating bacteria of the appropriate strain (e.g., XL1-Blue, ED8767, NM554, DH5αMCR)*  
For a complete listing of appropriate strains, please see Appendix 3.

## METHOD

### Transformation of *E. coli* by Cosmid DNA Packaged in Bacteriophage $\lambda$ Particles

1. Calculate the volume of the packaging reaction (Protocol 1, Steps 20–21) that will generate 30,000–50,000 transformed bacterial colonies.
2. Set up a series of sterile test tubes containing this volume of packaging reaction and 0.2 ml of plating bacteria.
 

The actual number of tubes to set up for plating the packaging reaction depends on the genome size, average size of fragments cloned, and the coverage of the genome required to find the particular clone of interest. In most cases, 15–20 tubes should be sufficient. For a further discussion of this issue, please refer to the chapter introduction and the panel on **GENOMIC LIBRARIES** (p. 4.6).
3. Incubate the tubes for 20 minutes at 37°C.
4. To each tube, add 0.5 ml of TB. Continue the incubation for a further 45 minutes.
5. Place sterile filters onto a series (equal in number to the series of tubes in Step 2) of 150-mm TB agar plates containing kanamycin (25  $\mu$ g/ml).
6. Use a sterile spreader to smear the contents of each tube over the surface of a filter on an agar plate. After the inoculum has been absorbed into each filter, transfer the plates to a 37°C incubator for several hours to overnight (12–15 hours).
 

Try to avoid spreading the inoculum within 3 mm of the edge of the master filters.

Transformed colonies first become visible on the master filters after 8–10 hours of incubation. The plates are usually incubated for a total of 12–15 hours before the colonies are screened by hybridization to a radiolabeled probe.
7. Place a sterile, numbered 137-mm filter on a fresh TB agar plate containing kanamycin (25  $\mu$ g/ml).
 

Filters may be numbered using a soft-lead pencil. This filter will become a replica of one of the master filters.
8. Place a sterile Whatman No. 1 filter on a thick, sterile glass plate.
9. Use blunt-ended forceps to remove the replica filter from the fresh TB agar plate (Step 7) and place it on the Whatman No. 1 filter.
10. Again use forceps to remove a master filter now carrying transformed colonies from its TB agar plate (Step 6) and place it, colony side down, exactly on top of the numbered replica filter on the Whatman No. 1 filter. Cover the two filters with another sterile Whatman No. 1 filter.
11. Place a second sterile glass plate on top of the stack of filters. Press the plates together.
12. Remove the upper glass plate and the upper Whatman No. 1 filter. Use a 17-gauge hypodermic needle to key the two nitrocellulose or nylon filters to each other by making a series of holes (~5 will do), placed asymmetrically around the edge of the filters.

### Growth of the Replica Filters

13. Peel the two nitrocellulose or nylon filters apart, and working quickly, replace them on their TB agar plates containing kanamycin (25  $\mu$ g/ml).
14. Incubate the master and replica filters for a few hours at 37°C, until the bacterial colonies are 0.5–1.0 mm in diameter.

15. Seal the master plates in Parafilm and store them at 4°C in an inverted position.
16. Lyse the colonies on the replica filter (Chapter 1, Protocol 31), and process the filters for hybridization to radiolabeled probes (Chapter 1, Protocol 32).

Replica filters can be used to replicate the library again or may be stored frozen at -70°C.

- Labeled probes used for screening must be free of plasmid vector sequences and bacteriophage  $\lambda$  *cos* sequences. Otherwise, every recombinant cosmid will hybridize to the probe.
- Because of their lower copy number, cosmids generate weaker hybridization signals than plasmids. Care must therefore be taken to reduce the level of nonspecific background hybridization to a minimum. This is best done by using Church buffer (please see recipe below) as a solvent for hybridization and, if necessary, including a competitor DNA in the hybridization mixture (usually 50  $\mu$ g/ml of denatured *E. coli* DNA).

**Church Buffer**

- BSA (1%)
- EDTA (1 mM)
- Phosphate buffer (0.5 M)\*
- SDS (7%)

\*Phosphate buffer (2 M) (pH 7.2) is made up by dissolving 142 g of  $\text{Na}_2\text{HPO}_4 \cdot 7\text{H}_2\text{O}$  in 999 ml of  $\text{H}_2\text{O}$  and adding 1 ml of 85% (w/v)  $\text{H}_3\text{PO}_4$ .

- The genomic DNA of most species contains amounts of repetitive sequences that can cause enormous problems in hybridization experiments and chromosome walking experiments. For example, a radiolabeled probe containing an *Alu* sequence will hybridize to the majority of recombinants in a cosmid library of human genomic DNA. Repetitive elements are also present in mRNAs, albeit at lower frequency (e.g., please see Yamamoto et al. 1984). When using a cloned segment of genomic DNA or cDNA to screen a cosmid library, first ascertain whether the probe contains repetitive elements. This is best done by hybridizing the radiolabeled probe to a Southern blot of genomic DNA. If highly repetitive sequences are present, the autoradiograph will display a complex series of bands or a continuous smear of hybridization along the length of the gel track.

**ADDITIONAL PROTOCOL: REDUCING CROSS-HYBRIDIZATION**

Cross-hybridization between repetitive DNAs can be substantially reduced by prehybridizing the radiolabeled probe with a competitor DNA. The following protocol is designed for use with human genomic DNA and may be readily modified for use with DNA from other species. Commercial preparations of DNA enriched for repetitive sequences (e.g.,  $C_{0t1}$  DNAs from Life Technologies) may be used in place of total placental DNA in this protocol.

**Additional Materials**

*Ethanol*

*Plasmid pBLUR8*

*Solution A*

0.9 M NaCl  
50 mM sodium phosphate (pH 8.0)  
5 mM EDTA  
0.1% (w/v) SDS

*Solution B*

50 mM sodium phosphate (pH 8.0)  
5 mM EDTA  
0.1% (w/v) SDS

*Sonicator, probe or bath type*

*TE (pH 7.6)*

*Total human genomic DNA*

*Water baths preset to 42°C and boiling*

**Method**

1. In 10 ml of TE (pH 7.6), dissolve 25 mg of total human genomic DNA and 50 mg of the plasmid pBLUR8 that contains a member of the *Alu* family of repetitive DNAs (Deininger et al. 1981).
2. Sonicate the DNA mixture to an average length of 50–100 bp using a probe or bath type sonicator (please see Appendix 8).  
Store the blocking mixture in 1-ml aliquots at 4°C.
3. To set up a hybridization reaction, add 100  $\mu$ l of blocking mixture (from Step 2) to the radiolabeled probe. Denature the mixture of probe and blocking DNAs by heating to 100°C for 5 minutes, and then plunge the tube into ice water.
4. To the hybridization reaction, add 20  $\mu$ l of Solution A. Mix well, and add 600  $\mu$ l of ice-cold ethanol.
5. Collect the precipitated nucleic acids by centrifugation at maximum speed for 10 minutes in a microfuge, and allow the pellet to dry in the air until no more traces of ethanol are visible. Dissolve the damp pellet in Solution B. Incubate the mixture for 10 minutes at 42°C to allow the repetitive DNA sequences to reanneal.
6. Immediately add the partially annealed mixture of radiolabeled probe and blocking solution to hybridization buffer and continue with the standard protocol for in situ hybridization of colonies to radiolabeled probes (Chapter 1, Protocol 32).



# Protocol 3

---

## Amplification and Storage of a Cosmid Library: Amplification in Liquid Culture

**O**VERENTHUSIASTIC AMPLIFICATION OF COSMID LIBRARIES is not recommended, because it inevitably results in a distorted representation of the original genome. Faster-growing clones become overrepresented; unstable clones undergo rearrangement (please see the panel on **DEALING WITH UNSTABLE RECOMBINANT COSMID CLONES**); slow-growing clones may disappear completely from the library.

Undesirable though it may be, amplification is generally necessary and sometimes unavoidable. For example, if the library is to be screened with several different probes and transported to other laboratories, or if there is a chance that the library will be used for chromosome walking, then the library must be expanded and copied several times. This protocol and Protocol 4 describe several options for amplification and storage of cosmid libraries. Amplification of the library during growth in TB medium is presented here, whereas Protocol 4 deals with amplification during growth on filters or on plates. (An alternative means of cosmid library amplification and storage is outlined in the panel on **AMPLIFICATION BY RESCUING COSMID DNA IN TRANSDUCING PARTICLES OF BACTERIOPHAGE  $\lambda$**  at the end of this protocol.) In our hands, the method of amplification in liquid culture introduces less distortion of cosmid libraries than any other method, perhaps because the shock to the host cells associated with plating is avoided. This experience is documented by Longmire et al. (1993), who report that plating cosmid libraries on filters reduces the complexity of the library.

### **DEALING WITH UNSTABLE RECOMBINANT COSMID CLONES**

Repeated sequences, palindromic sequences, and methylated bases can all trigger rearrangement of genomic DNAs cloned in cosmids. The first outward sign of rearrangement is usually the appearance of extra bands, often in submolar amounts, in restriction digests of a cosmid. Although there is no guaranteed cure for instability, two methods are available to ameliorate the problem:

- If the problematic cosmid is between 38 kb and 52 kb in size, it can be transferred to a different host strain by packaging in vitro using commercial packaging extracts (Yokobata et al. 1991) or by packaging in vivo using a helper bacteriophage (Vollenweider et al. 1980; Little and Jackson 1987). In both cases, improvements in stability have been reported.
- Cosmid DNA, isolated from a series of individual bacterial colonies, can be analyzed by digestion with restriction enzymes. In many cases, some colonies will be identified that contain a high proportion of full-length cosmid DNAs. These intact molecules can be transferred to a new bacterial strain by electroporation or rescued with high efficiency by in vitro packaging and then transferred to a different strain.

Strains of *E. coli* that have been reported to improve stability of individual cosmids include DH5 $\alpha$ MCR and NM554.

## MATERIALS

---

### Buffers and Solutions

*Glycerol*

### Media

*TB agar plates containing 25 µg/ml kanamycin*

*TB medium*

*TB medium containing 25 µg/ml kanamycin*

### Centrifuges and Rotors

*Sorvall GSA rotor or equivalent*

### Special Equipment

*Freezing vials*

### Additional Reagents

*Step 9 of this protocol requires reagents listed in Protocol 2 of this chapter.*

*Step 9 of this protocol also requires the reagents listed in Chapter 1, Protocols 31 and 32.*

### Vectors and Bacterial Strains

*Bacteriophage λ packaging reaction*

*Please see Protocol 1, Step 19 of this chapter.*

*E. coli plating bacteria of the appropriate strain (e.g., XL1-Blue, ED8767, NM554, DH5αMCR)*

*For a complete listing of appropriate strains, please see Appendix 3.*

## METHOD

---

### Preliminary Growth

1. Calculate the volume of the packaging reaction (Protocol 1, Steps 20–21) that will generate 30,000–50,000 transformed bacterial colonies.
2. Set up a series of sterile test tubes and into each tube deliver 0.2 ml of plating bacteria followed by the volume of packaging reaction determined in Step 1.

The actual number of tubes to set up for plating the packaging reaction depends on the genome size, average size of fragments cloned, and the coverage of the genome required to find the particular clone of interest. In most cases, 15–20 tubes should be sufficient. For a further discussion of this issue, please refer to the chapter introduction and the panel on **GENOMIC LIBRARIES** (p. 4.6).
3. Incubate the tubes for 20 minutes at 37°C.

Large amounts of packaging mixture can inhibit attachment of the bacteriophage particles to the plating bacteria. If the concentration of packaged bacteriophages is low (<10<sup>4</sup> transducing units/ml of packaging mixture), use more plating bacteria, e.g., 5 ml/ml of packaging reaction. After incubating the cells for 20 minutes at 37°C, recover the bacteria by centrifugation at 5000g (6500 rpm in a Sorvall SS-34 rotor) for 10 minutes at 4°C. Resuspend the cells in 0.5 ml of TB and proceed to Step 4.
4. Add 0.5 ml of TB to each tube. Continue incubation for a further 45 minutes.

### Amplification in TB Medium Containing 25 µg/ml Kanamycin

5. Inoculate 0.25-ml aliquots of each culture of infected cells into 100-ml volumes of TB medium containing 25 µg/ml kanamycin in 250-ml flasks.
6. Incubate the inoculated cultures with vigorous shaking at 37°C until the cells reach an optimal density of 0.5–1.0 OD<sub>600</sub>.
7. Pool the cultures and recover the cells by centrifugation at 5000g (5500 rpm in a Sorvall GSA rotor) for 15 minutes at 4°C. Resuspend the cells in a volume of TB that is equal to 0.1x the volume of the original pooled cultures.

Cosmid DNA can be isolated (please see Step 23 in Protocol 1) from aliquots of cells taken before the addition of glycerol. This stock of DNA can be used as a template in PCR to determine whether a particular DNA sequence of interest is present in the library (please see Chapter 8).

8. Add sterile glycerol to the cell suspension to a final concentration of 15% (v/v). Mix the suspension well by inverting the closed tube several times. Dispense aliquots (0.5–1.0 ml) of the bacterial suspension into sterile vials. Store the tightly closed vials at –70°C.
9. To screen the library, thaw an aliquot of frozen cells rapidly at 37°C and plate 30,000–50,000 bacteria onto each of a series of numbered filters as described in Protocol 2 beginning with Step 5. Proceed with lysing the colonies on the replica filters (Chapter 1, Protocol 31) and processing the filters for hybridization to labeled probes (Chapter 1, Protocol 32).

Once some likely clones of interest are identified by hybridization, they may be further analyzed by restriction enzyme digestion (please see the panel on **CONSTRUCTING RESTRICTION MAPS OF RECOMBINANT PLASMIDS** in Protocol 4).

#### **AMPLIFICATION BY RESCUING COSMID DNA IN TRANSDUCING PARTICLES OF BACTERIOPHAGE λ**

Because circular cosmid molecules carried in bacterial cells contain a *cos* sequence, they can be efficiently packaged into bacteriophage λ particles. When cosmid-containing bacteria are infected with bacteriophage λ (or when a resident prophage is induced), the *cos* site in the cosmid DNA is cleaved by the bacteriophage λ terminase function (*ter*). The linearized cosmid DNA is then packaged into the heads of newly formed bacteriophage λ particles, which can be readily isolated, stored for long periods of time, and used at the investigator's convenience to transduce the cosmid genome into other bacterial strains. Although this method of storage is in little use today, the ability to rescue the cosmid DNA in the form of bacteriophage particles provides a convenient method to amplify cosmid libraries. For a transduction protocol, please see Sambrook et al. (1989; pages 3.52–3.53).

# Protocol 4

---

## Amplification and Storage of a Cosmid Library: Amplification on Filters

**I**N THIS METHOD OF AMPLIFICATION, DISTORTION OF THE LIBRARY is rarely a problem: At no stage are mixed populations of bacteria containing different recombinant cosmids grown in competition with one another. However, amplification is tedious and is sometimes compromised by the loss of colonies that do not grow after storage of the master filters. An alternative method is provided for amplification on TB plates (please see the panel on **ALTERNATIVE PROTOCOL: AMPLIFICATION ON PLATES** at the end of this protocol). This alternative amplification protocol is vulnerable to the loss of cosmid clones that grow poorly. The best of all options may be to obtain a cosmid library that has been arrayed in microtiter plates; such libraries may then be used to generate high-density arrays (for review, please see Evans et al. 1992).

For the vast majority of laboratories, arraying is not a realistic option. However, arrayed libraries are becoming available to an increasing extent from commercial sources. In addition, copies of arrayed libraries are stored in most of the major academic Genome Centers in the United States and Europe and in some commercial organizations. Access to these libraries is sometimes possible by setting up appropriate collaborative arrangements.

---

### MATERIALS

---

#### Media

*TB agar plates (150 mm) containing 25 µg/ml kanamycin*  
*TB medium*

#### Special Equipment

*Nitrocellulose or Nylon filters (137 mm), detergent-free, sterile*

#### Additional Reagents

*Step 7 of this protocol requires reagents listed in Protocol 2 of this chapter.*  
*Step 8 of this protocol requires the reagents listed in Chapter 1, Protocols 31 and 32.*

#### Vectors and Bacterial Strains

*Bacteriophage λ packaging reaction*

*Please see Protocol 1, Step 19 of this chapter.*

*E. coli plating bacteria of the appropriate strain (e.g., XL1-Blue, ED8767, NM554, DH5αMCR)*

*For a complete listing of appropriate strains, please see Appendix 3.*

## METHOD

---

### Preliminary Growth

1. Calculate the volume of the packaging reaction (Protocol 1, Steps 20–21) that will generate 30,000–50,000 transformed bacterial colonies.
2. Set up a series of sterile test tubes and into each tube deliver 0.2 ml of plating bacteria followed by the volume of packaging reaction determined in Step 1.

The actual number of tubes to set up for plating the packaging reaction depends on the genome size, average size of fragments cloned, and the coverage of the genome required to find the particular clone of interest. In most cases, 15–20 tubes should be sufficient. For a further discussion of this issue, please refer to the chapter introduction and the panel on **GENOMIC LIBRARIES** (p. 4.6).

3. Incubate the tubes for 20 minutes at 37°C.

Large amounts of packaging mixture can inhibit attachment of the bacteriophage particles to the plating bacteria. If the concentration of packaged bacteriophages is low ( $<10^4$  transducing units/ml of packaging mixture), use more plating bacteria, e.g., 5 ml/ml of packaging reaction. After incubating the cells for 20 minutes at 37°C, recover the bacteria by centrifugation at 5000g (5500 rpm in a Sorvall SS-34 rotor) for 10 minutes at 4°C. Resuspend the cells in 0.5 ml of TB and proceed to Step 4.

4. Add 0.5 ml of TB to each tube. Continue incubation for a further 45 minutes.

### Amplification on Filters

5. Place sterile, numbered filters onto a series (equal in number to the series of tubes in Step 2) of 150-mm TB agar plates containing kanamycin (25 µg/ml).

Filters may be numbered using a soft-lead pencil.

6. Use a sterile spreader to smear the contents of each tube over the surface of a filter on an agar plate. After the inoculum has absorbed into each filter, transfer the plates to a 37°C incubator for several hours to overnight (12–15 hours).

Try to avoid spreading the inoculum within 3 mm of the edge of the master filters.

Transformed colonies first become visible on the master filters after 8–10 hours of incubation. The plates are usually incubated for a total of 12–15 hours before the colonies are screened by hybridization to a radiolabeled probe.

7. Make a replica of each of the master filters as described beginning with Step 7 of Protocol 2. Store the filters at –70°C.

8. To screen the library, thaw the replica filters and proceed with lysing the colonies on the filters (Chapter 1, Protocol 31) and processing the filters for hybridization to labeled probes (Chapter 1, Protocol 32).

Once some likely clones of interest are identified by hybridization, they may be further analyzed by restriction enzyme digestion (please see the panel on **CONSTRUCTING RESTRICTION MAPS OF RECOMBINANT COSMIDS**).

**CONSTRUCTING RESTRICTION MAPS OF RECOMBINANT COSMIDS**

Several strategies are available to construct low-resolution restriction maps of segments of genomic DNA cloned in cosmids:

- The cloning sites of many cosmid vectors are flanked by restriction sites for enzymes that cleave mammalian DNA infrequently (e.g., *SacII*, *Sall*, *PacI*, and *NotI*). Digestion with these enzymes, singly or in combination, will generally yield a small number of DNA fragments that can be ordered into a map.
- If a restriction enzyme is identified that releases the insert from the vector but does not cleave within it, then a second strategy becomes available in cosmid vectors such as SuperCos-1. In vectors of this type, the promoters for the bacteriophage T3 and T7 RNA polymerases are located between the *BamHI* cloning site and the flanking *NotI* restriction sites. Restriction sites can be mapped by releasing the insert with *NotI*, setting up partial digestion with restriction enzymes, and analyzing the products by Southern hybridization using an oligonucleotide probe complementary to either the bacteriophage T3 or the bacteriophage T7 promoter sequence. A ladder of hybridizing bands is detected on the autoradiogram, with the smallest band generated by cleavage at the site nearest one of the termini of the cloned genomic fragment and progressively larger bands generated by cleavage at sites increasingly distant from the end. The difference in size between adjacent bands is a measure of the distance between restriction sites. This rapid mapping approach is a variation on the strategy originally developed by Smith and Birnstiel (1976).
- A similar method takes advantage of the ability of the terminase enzyme of bacteriophage  $\lambda$  to recognize and cleave at *cos* sites (Rackwitz et al. 1985). Cleavage of cosmid DNA in vitro with terminase yields a linear molecule carrying protruding single-stranded termini, 12 nucleotides in length (Wu and Taylor 1971). Partial digestion reactions can then be carried out as described above to map the sites of cleavage of other restriction enzymes. In single *cos* vectors, the terminase-digested DNA can be end-labeled with [ $\alpha$ -<sup>32</sup>P]dNTPs and the Klenow fragment of *E. coli* DNA polymerase I (please see Chapter 9, Protocol 10) before partial digestion with the restriction enzyme. In double *cos* vectors, the two *cos* sites can be distinguished by end labeling with different [ $\alpha$ -<sup>32</sup>P]dNTPs (Wu and Taylor 1971). Alternatively, oligonucleotide probes specific for the left *cos* site or right *cos* site can be used as probes in Southern hybridizations (Rackwitz et al. 1984).

### ALTERNATIVE PROTOCOL: AMPLIFICATION ON PLATES

#### Additional Materials

*Freezing vials*

*Glycerol*

*Step 10 of this protocol requires the reagents listed in Protocol 2 of this chapter and in Chapter 1, Protocols 31 and 32.*

*TB medium containing 25 µg/ml kanamycin*

#### Method

1. Follow Steps 1 through 3 of Protocol 4.
2. Add 0.5 ml of TB to each tube. Continue incubation for a further 45 minutes.
3. Use a sterile spreader to smear the contents of each tube over the surface of a TB agar plate containing kanamycin (25 µg/ml), and transfer the plates to a 37°C incubator for several hours to overnight (12–15 hours).
4. When the transformed bacterial colonies reach 0.1–0.2 mm in diameter, scrape them from each plate in turn into separate 10-ml aliquots of TB containing kanamycin (25 µg/ml).
5. Rinse each plate with an additional 5 ml of TB containing kanamycin (25 µg/ml), to ensure complete recovery of the bacteria. Pool the bacterial suspensions obtained from different plates.
6. Vortex the pooled suspension to disperse clumps of bacteria. Measure the exact volume of the suspension.
7. To the suspension, add sterile glycerol to a final concentration of 15% (v/v). Mix the suspension well by inverting the closed tube several times. Dispense aliquots (0.5–1.0 ml) of the bacterial suspension into sterile vials. Store the tightly closed vials overnight at –70°C.
8. The next day, remove an aliquot of the bacterial suspension from the freezer and thaw it rapidly at 37°C. Make a series of tenfold dilutions of the suspension in TB. Spread duplicate 0.1-ml aliquots of each dilution onto TB plates containing kanamycin (25 µg/ml). Incubate the plates overnight at 37°C.
9. Count the number of colonies and calculate the number of viable cells/ml of original suspension.  
The titer of the library should remain constant for at least 1 year during storage at –70°C.
10. To screen the library, thaw an aliquot of the suspension rapidly at 37°C and plate 30,000–50,000 bacteria onto each of a series of numbered filters as described in Protocol 2 beginning with Step 5. Proceed with lysing the colonies on the replica filters (Chapter 1, Protocol 31) and processing the filters for hybridization to labeled probes (Chapter 1, Protocol 32).

# Protocol 5

---

## Working with Bacteriophage P1 and Its Cloning Systems

**B**ACTERIOPHAGE P1 WAS DISCOVERED IN THE SAME YEAR as bacteriophage  $\lambda$  (Bertani 1951). Although both bacteriophages are temperate in their natural hosts, their histories in the laboratory could hardly be more different. Almost immediately after its discovery, bacteriophage  $\lambda$  was quickly adopted by the influential laboratories of the time as the type-species for molecular studies of lysogenic bacteriophages. The 30-year effort to understand its intricate control circuits became a lodestone for generations of graduate students and postdoctoral fellows. By the early 1970s, a huge amount of knowledge had been harvested and, as a consequence, bacteriophage  $\lambda$  was the natural first choice as a vector to clone fragments of genomic DNA.

It was to be another 20 years before the first bacteriophage P1 vector was developed as part of a deliberate effort to create a cloning vehicle that could efficiently propagate larger (90–100 kb) fragments of genomic DNA (Sternberg 1990). By then, it had become clear that the assembly of sets of large contiguous sequences (contigs) and the construction of physical maps of mammalian genomes could not readily be achieved with libraries constructed in either bacteriophage  $\lambda$  or cosmid vectors. Efforts to produce contigs longer than several hundred kilobases generally failed because of the slow rate of chromosome walking imposed by the small size of inserts in bacteriophage  $\lambda$  clones, by rearrangement of cloned genomic sequences during propagation of cosmids, or because of gaps in coverage in both kinds of libraries. YAC vectors (Burke et al. 1987) had their own sets of problems, chiefly, the high frequency of chimeric clones and the difficulty in manipulating and isolating YACs in a background of yeast genomic DNA.

### THE DESIGN OF P1 VECTORS

---

By contrast to bacteriophage  $\lambda$ , where vectors evolved from the work of many hundreds of investigators in traditional academic institutions, bacteriophage P1 vectors were the product of a single laboratory, that of Nat Sternberg at the Dupont Merck Pharmaceutical Company, located in the then wilderness of Wilmington, Delaware. Sternberg's goal was to "develop a system that would generate libraries that exhibit the desirable features of cosmid and YAC libraries but minimize their deficiencies." The resulting P1 cloning system, which is full of ingenious ideas, draws deeply on the biology of bacteriophage P1 (please see the panel on **THE LIFE CYCLE OF BACTERIOPHAGE P1**) but is similar in principle to cloning in cosmids:



- Genomic DNA is partially digested with a restriction enzyme such as *Sau3AI*, and molecules 70–100 kb in length are then purified by sucrose density centrifugation or pulsed-field gel electrophoresis.
- The fragments of genomic DNA are ligated to a vector that contains various genetic elements derived from P1 and a plasmid replicon/partition system.
- Linear recombinant molecules are packaged in vitro into bacteriophage P1 particles.
- The packaged DNA is transfected into bacteria where it circularizes and replicates autonomously under the control of the single-copy P1 plasmid replicon.
- The plasmid can be amplified to high copy number by adding isopropyl- $\beta$ -D-5-thiogalactoside (IPTG), which induces replication from the P1 lytic replicon (please see Step 1 of this protocol).

Although simple in principle, this scheme requires P1 vectors equipped with many accessory elements that assure a high efficiency of cloning and recovery of unrearranged genomic DNA

#### THE LIFE CYCLE OF BACTERIOPHAGE P1

- The DNA molecules extracted from a population of infectious P1 particles are ~110 kb in length, double-stranded, linear, terminally redundant, and circularly permuted. The nonredundant DNA sequences are ~90 kb in length.
- After injection into a permissive, recombination-proficient host, homologous recombination between the 10-kb redundant terminal sequences generates nonredundant circular DNA genomes, ~100 kb in length. In a *rec<sup>-</sup>* host, circularization can still occur if the viral DNAs contain *loxP* sites in the terminally redundant regions. *loxP* sites are 34-bp sequences that are substrates for the virally encoded Cre recombinase (please see the information panel on **CRE-*loxP***).
- Depending on the physiological state of the host cell, either the circularized viral DNA can enter a lysogenic state and become a prophage in which lytic functions are repressed by the viral *cl* repressor or it can unfurl the much larger set of viral functions required for lytic infection.
- In P1 lysogens, the viral DNA is maintained as a single-copy plasmid that replicates via the R replicon, which consists of an origin of replication and DNA encoding an essential replication protein (RepA) with its associated control region. Adjacent to the replicon is a 2.7-kb partitioning element (*par*) that ensures faithful segregation of the daughter prophage molecules at cell division.
- Lytic infection proceeds when the concentration of *cl* repressor is insufficient to establish or maintain the lysogenic state. DNA replication, which is driven by the lytic or L replicon, occurs first in Cairns or  $\theta$  structures but soon switches to a rolling circle mechanism, which produces head-to-tail tandemly repeated copies of the viral DNA. These concatemeric molecules are the templates for packaging into bacteriophage particles.
- Precursor head structures (proheads) bind to the concatemeric viral DNA at a specific 162-bp site (*pac*) that is cleaved by the P1-encoded *pacase* and two *E. coli* DNA-binding proteins, IHF and HU. Starting from the newly created end, the viral DNA is packaged unidirectionally until the prohead is full. The packaged DNA is then cleaved from the remainder of the concatemer by a sequence-independent cutting reaction and a second round of packaging is initiated from the end created by the “headful” cutting reaction.
- Because bacteriophage P1 heads can accommodate 110 kb of DNA, whereas the P1 genome is only 100 kb in length, the DNA packaged into each prohead is terminally redundant. Since the headful cutting reaction moves progressively along the viral genome, the population of packaged molecules is circularly permuted.
- Lytic infection of laboratory strains of *E. coli* with bacteriophage P1 generates 100–200 progeny particles per cell. Lysis of the infected cell requires expression of virally encoded lysis genes and occurs after ~60 minutes.

For references and further details, please see the comprehensive review of bacteriophage P1 biology by Yarmolinsky and Sternberg (1988). The detailed mechanism of cleavage at the *pac* site is discussed by Black (1989) and Skorupski et al. (1992, 1994).

from transformed bacteria. For the last several years, the vectors of choice for construction of genomic libraries have been pAd10*sacB*II (please see Figure 4-3, p. 4.4) and its derivatives (Pierce et al. 1992a; for reviews, please see Pierce and Sternberg 1992; Sternberg 1992, 1994; Shepherd and Smoller 1994). These vectors, which contain a marker that allows positive selection of recombinants (*sacB*<sup>-</sup>; please see below), have allowed the construction of genomic libraries of sufficient complexity to cover mammalian genomes with redundancy required for chromosome mapping and isolation of genes. The following are the chief features of the circular pAd10*sacB*II molecule (please see Figure 4-3):

- The vector is divided into two domains by *loxP* recombination sites (Hoess and Abremski 1984). The *loxP* sequences are substrates for the P1-encoded Cre recombinase, which can be used in vitro or in vivo to divide the vector into two circular plasmids (Abremski et al. 1983).
- The domain on the left-hand side of the vector contains:
  1. A *colE1* replicon derived from pBR322.
  2. The minimal P1 packaging site (162 bp) (*pac*) (Bächi and Arber 1977), within the coding sequence of the *pacA* gene (Skorupski et al. 1992).
  3. An 11-kb stuffer fragment of adenovirus DNA whose insertion into a *ScaI* site has inactivated an *amp<sup>r</sup>* gene while leaving intact the *ScaI* site immediately clockwise to *pac*. The stuffer fragment has a purely passive function: to fill the phage head when the insert DNA is of insufficient size (Sternberg et al. 1990).
- The “*kan*” domain on the right-hand side of the vector contains:
  1. The kanamycin gene from Tn903.
  2. The unit copy P1 plasmid replicon and a partition system *par*. The basic P1 replicon maintains P1 plasmids in *E. coli* at about one copy per host chromosome.
  3. A synthetic replicon, consisting of the lytic P1 replicon whose activity is driven by the *lac* promoter. The replicon is inactive in bacteria expressing the *lac* repressor but can be brought to life by adding the inducer IPTG to the medium. The plasmid DNA is then rapidly amplified (within 30 minutes) from a copy number of ~1 to ~20 copies per cell (Sternberg and Cohen 1989).
  4. A *tef* gene that has been deliberately inactivated by insertion of the *sacB* gene from *Bacillus amyloliquefaciens*. *sacB* encodes an exoenzyme, levan sucrase, which catalyzes the hydrolysis of sucrose. When expressed in *E. coli*, the SacB enzyme generates levan, which accumulates in the periplasmic space, with lethal effects (Gay et al. 1983, 1985; Tang et al. 1990). Expression of *sacB* in pAd10*sacB*II is controlled by a synthetic near-consensus *E. coli* promoter that overlaps with a consensus P1 *cI* repressor/operator site (Eliason and Sternberg 1987). The *sacB* gene is therefore repressed in cells that express the *cI* repressor, allowing the efficient production of vector DNA.

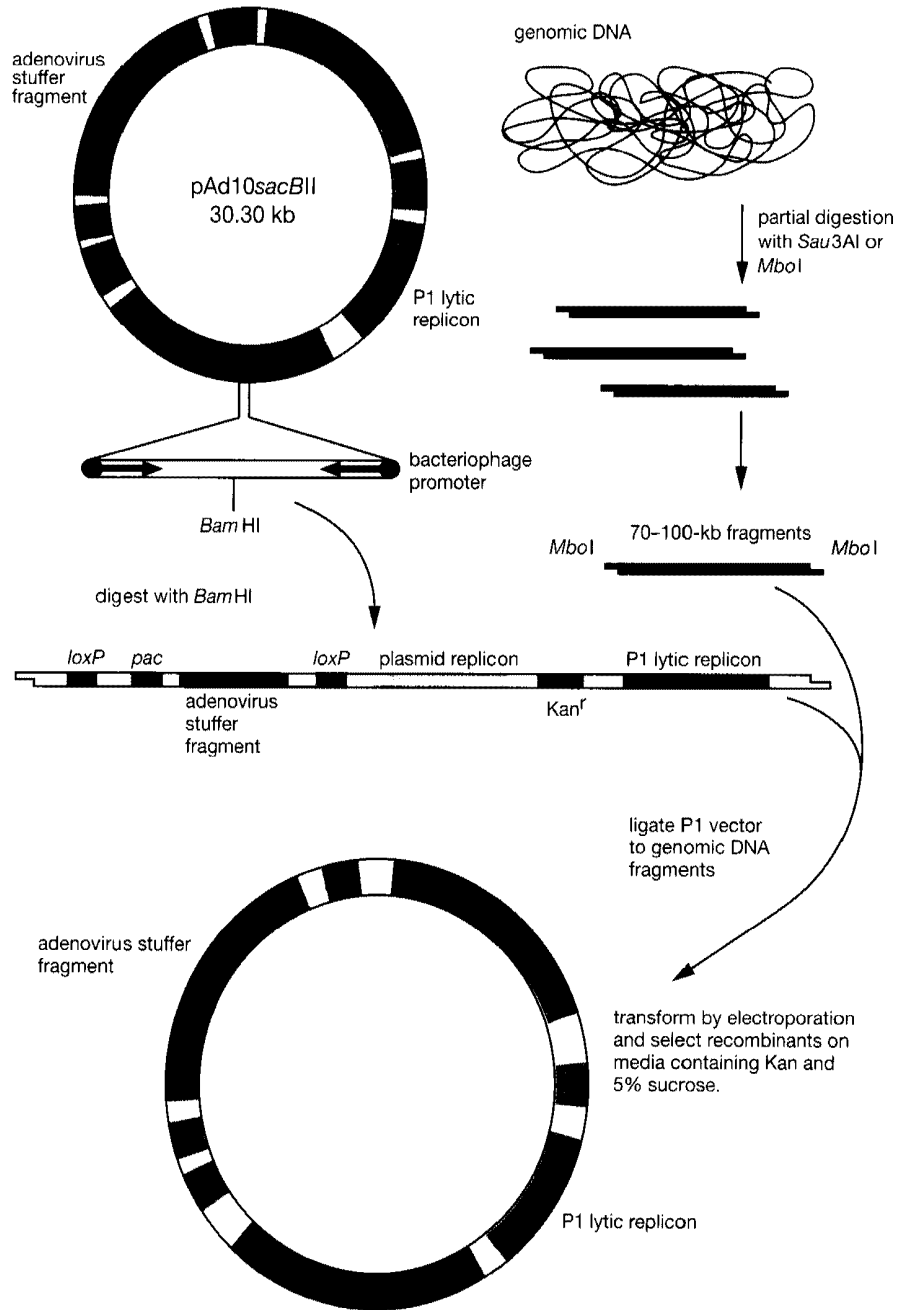
## CLONING INTO P1 VECTORS

---

P1 libraries are typically generated by cloning into the P1 vector pAd10*sacB*II (please see Figure 4-10). Cloning DNA into the *Bam*HI site of the *sacB* gene interrupts expression of levan sucrase and permits growth of plasmid-containing cells in the presence of 5% sucrose. This disruption provides a 50–75-fold discrimination of P1 clones that contain inserts from those that do not contain inserts (Pierce et al. 1992a; Ioannou et al. 1994). The *Bam*HI cloning site is flanked by

bacteriophage T7 and SP6 promoters to facilitate the synthesis of RNA probes from the termini of cloned DNA and by rare restriction sites that allow easy recovery of cloned DNA fragments.

The steps involved in generating libraries in pAd10*sacBII* are shown diagrammatically in Figure 4-10. The complete nucleotide sequence of the *sacBII kan* domain of pAd10*sacBII* cloning vector is available (Pan et al. 1994; Genbank numbers L19899, L119900, and L19898). We have not



**FIGURE 4-10 Cloning in P1 Vectors**

P1 vector DNA, digested with *Bam*HI, is ligated to 70–100-kb fragments of eukaryotic DNA obtained by partial digestion with *Mbo*I or *Sau*3A. The resulting products are packaged into bacteriophage P1 heads, and the recombinant virus particles are introduced into an appropriate host and selected as described in the text.

**TABLE 4-4 Screening Facilities for YAC, PAC, and P1 Libraries**

SCREENING CENTER	SCREENING SERVICES	CONTACT
Genome Systems, Inc. St. Louis, Missouri	PCR	E-mail: sales@genomesystems.com URL: <a href="http://www.genomesystems.com">http://www.genomesystems.com</a>
Research Genetics, Inc.	PCR, high-density membrane hybridization	E-mail: info@resgen.com URL: <a href="http://www.resgen.com">http://www.resgen.com</a>
Leiden YAC Center The Netherlands	PCR, high-density membrane hybridization	
Pavia YAC Center Italy	PCR, high-density grid screening	
CEPH Paris	PCR	E-mail: yac_manager@cephb.fr URL: <a href="http://www.cephb.fr/services">http://www.cephb.fr/services</a>
UK HGMP Resource Center London, England	PCR, high-density grid screening	E-mail: biohelp@hgmp.mrc.ac.uk URL: <a href="http://www.hgmp.mrc.ac.uk">http://www.hgmp.mrc.ac.uk</a>
ICRF London, England	Filter hybridization	

(Reprinted, with permission, from *Current Protocols in Human Genetics* [ed. N.C. Dacopoli et al.] 1994 [© Wiley, New York].)

provided a protocol for construction of a P1 library; the process is sufficiently complex that few investigators actually create their own libraries. For a listing of the facilities that provide available libraries, please see Table 4-2 (p. 4.3), and for contacts for facilities that provide screening options for the library, please see Table 4-4.

### The Organization and Screening of Genomic Libraries Constructed in P1 Vectors

Libraries in P1 vectors have been constructed using genomic DNA isolated from fission yeast (Hoheisel et al. 1993), *Drosophila* (Smoller et al. 1991, 1994; Hartl et al. 1994), pine (Gorman et al. 1992), mouse (Pierce et al. 1992a,b; Sternberg 1994; Francis et al. 1994), and human (Sternberg et al. 1990; Francis et al. 1994; Shepherd et al. 1994; Tanahashi 1994). In addition, a human genomic library has been constructed in a smaller derivative of pAd10*sac*BII, pCYPAC1, which was developed for electroporation of circular ligation products, rather than packaging and Cre-mediated recombination (Ioannou et al. 1994).

Most P1 libraries are arrayed, either as individual clones or, more commonly, as pools of clones in the wells of microtiter dishes. In the latter case, the pools are screened by PCR in a top-down approach (Green and Olson 1990; Pierce et al. 1992b). Individual clones, picked at random from the library, are pooled in various combinations of increasing complexity and screened for the presence of the desired target sequence. For example, the murine genomic P1 libraries described by Pierce et al. (1992a) and Sternberg (1994) are initially screened in six pools of 25,000 clones each. When a positive pool is identified, a second round of screening is carried out on 10 subpools, each containing 2500 clones. The third and final round of screening is carried out on 10 subsub pools containing 350–500 clones each. Once a positive third-level pool is identified, the desired clone is identified by colony hybridization. The plasmid DNA can then be amplified and isolated by standard methods, e.g., alkaline DNA extraction (Shepherd and Smoller 1994).

Although arrayed P1 libraries containing multiple clones per well can be screened efficiently, pooling of clones also carries risks. Because individual clones grow at different rates, there is a danger that slow-growing recombinants may be lost from the pools (Shepherd et al. 1994; Shovlin 1996). This possibility has led to the suggestion that libraries should be plated or maintained in a

one-clone-per-well format. However, screening such a library is beyond the capacity of most laboratories. For a full discussion of the advantages and disadvantages of pooled, arrayed P1 libraries, please see Shepherd and Smoller (1994).

## THE PAC CLONING SYSTEM

---

The PAC system combines the features of P1 vectors and bacterial artificial chromosomes (BAC). The PAC vector is derived from pAd10*sacBII* by deletion of the adenovirus stuffer and insertion of a pUC-based plasmid. These changes increase the yield of vector and reduce the toxicity of the *SacBII* protein in the absence of sucrose. The PAC vector retains all of the other features of pAd10*sacBII*, including the positive selection system and the two P1-encoded replicons. However, instead of packaging and site-specific recombination, recombinant PACs are introduced into *E. coli* by electroporation. The inserts in a PAC-based library of human genomic DNA range in size from 130 kb to 150 kb (Ioannou et al. 1994).

## ADVANTAGES AND DISADVANTAGES OF THE P1 AND PAC CLONING SYSTEMS

---

By contrast to cosmids and bacteriophage  $\lambda$ , a single P1 or PAC clone of genomic DNA is long enough to span the average mammalian gene, including introns and controlling elements. In theory at least, it should be possible to transfect such long DNA molecules into appropriate lines of mammalian cells and obtain expression of the target gene in its natural setting of 5' and 3' sequences. However, the existing P1 and PAC libraries are constructed in vectors that lack reporter genes and selectable markers for mammalian cells. At present, therefore, it is necessary to retrofit individual PAC and P1 clones containing the gene of interest with cassettes carrying the relevant markers and reporters (Chatterjee and Sternberg 1996; Mejia and Monaco 1997).

In addition to functional analysis of particular genes, P1 and PAC clones are used increasingly to generate contigs and to construct physical maps of genomic regions. In general, genomic sequences cloned in P1 and PAC vectors exhibit lower rates of rearrangement and chimerism (1–2%) (Sternberg 1994) than YACs. In addition, they are considerably more tolerant of repetitive and palindromic genomic sequences that are underrepresented or absent from YAC and cosmid libraries. The bacteriophage promoters flanking the cloned genomic DNA in pAd10*sacBII* facilitate the production of probes that can be used to build contigs by chromosome walking and to bridge gaps in cosmid and YAC contigs.

The chief disadvantage of the bacteriophage P1 system lies in the difficulty of constructing large libraries that cover the genome to a depth sufficient for chromosome walking. This remains a challenge even for laboratories such as those descended from Sternberg's that know the system intimately. Although packaging extracts are commercially available, a better option for most investigators is to use commercial bacteriophage P1 libraries, even though their depth of coverage (~3-fold) is generally smaller than one might wish.

Several companies and genome centers now offer services in which preexisting bacteriophage P1 and PAC libraries are screened for a gene of interest (please see Table 4-4). To take advantage of the service, an investigator typically submits proof that a pair of oligonucleotide primers can be used in a PCR to detect a particular target gene. The company then screens one or more P1 libraries to identify clones harboring the target gene, and aliquots of the *E. coli* cultures harboring the recombinant P1 or PAC clone(s) identified in the PCR screen are then returned to the investigator. At this point, the investigator carries out a detailed characterization of the target gene or region of DNA identified by the service.

## WORKING WITH BACTERIOPHAGE P1 AND PAC CLONES

The following protocol describes methods for recovery and purification of recombinant clones of closed circular bacteriophage P1 or PAC DNAs from bacteria. These methods are longer and somewhat more complicated than the techniques used to isolate cosmid DNA. The reason for this is that the large P1 or PAC DNAs are sensitive to shearing forces, which necessitates certain precautions during handling, including the use of wide-bore pipette tips to transfer DNAs and drop dialysis to exchange buffers. In addition, because P1 and PAC recombinants are maintained at much lower copy number than cosmids and plasmids, more stringent methods of purification are required to obtain clean DNA. Low yields, the presence of contaminating *E. coli* chromosomal DNA, and poor results in subsequent molecular cloning reactions are the typical outcomes of quick and dirty P1 purifications. This protocol, derived from Pierce and Sternberg (1992) and from methods supplied by David Smoller of Genome Systems, Inc., generally yields P1 DNA that is efficiently digested with many different restriction enzymes, is readily ligated, serves as a good template for DNA sequencing and amplification with thermostable DNA polymerases, and is an efficient template for in vitro transcription assays using bacteriophage RNA polymerases.

## MATERIALS

**CAUTION:** Please see Appendix 12 for appropriate handling of materials marked with <!>.

### Buffers and Solutions

Please see Appendix 1 for components of stock solutions, buffers, and reagents. Dilute stock solutions to the appropriate concentrations.

*Ammonium acetate (0.5 M)*

*Ethanol*

*IPTG (1 mM)*

Optional, please see note to Step 1.

*Isopropanol*

*MgCl<sub>2</sub> (1 mM)*

*Phenol:chloroform (1:1, v/v) <!>*

*Polyethylene glycol (40% w/v PEG 8000 solution) <!>*

Please see the information panel on **POLYETHYLENE GLYCOL** in Chapter 1.

*Sodium acetate (0.3 M, pH 5.2)*

*Solutions for DNA isolation:*

*Alkaline lysis solution I*

*Alkaline lysis solution II*

Solution II should be freshly prepared and used at room temperature.

*Alkaline lysis solution III*

*TE (pH 8.0)*

*TE (pH 8.0) containing 20 µg/ml RNase*

### Enzymes and Buffers

*Restriction endonucleases*

### Gels

*Pulsed-field gels (or 0.5% agarose gels)*

Please see Step 15 below and the panel on **PULSED-FIELD GEL ELECTROPHORESIS** in Protocol 1.

## Media

*LB medium containing 25 µg/ml kanamycin*

Optional, use with IPTG in Step 1.

*TB medium containing 25 µg/ml kanamycin*

## Centrifuges and Rotors

*Sorvall SS-34 rotor or equivalent*

## Special Equipment

*Corex centrifuge tubes (30 ml)*

*Water bath preset to 65°C*

## Vectors and Bacterial Strains

*E. coli strain transformed with a nonrecombinant bacteriophage P1 or PAC vector (culture)*

*E. coli strain transformed with a recombinant bacteriophage P1 or PAC vector (culture)*

## METHOD

---

### Preparation of Recombinant P1 or PAC DNA

1. Transfer 10 ml of TB containing 25 µg/ml kanamycin into each of two 50-ml Falcon tubes or Erlenmeyer flasks. Inoculate one tube with a single colony of bacteria containing the recombinant P1 or PAC. Inoculate the other tube with a single colony of bacteria transformed by the vector alone. Grow the cultures to saturation, with vigorous shaking for 12–16 hours at 37°C.

The addition of IPTG (1 mM) to cultures of cells carrying P1 recombinants inactivates the *lac* repressor and leads to induction of the P1 lytic replicon, which results in an increase in the copy number of the plasmid DNA from 1 to ~20 copies/cell. However, there are indications that amplification in the presence of IPTG can lead to instability in P1 recombinants that carry repetitive sequences of genomic DNA (Sternberg 1994). Most investigators therefore avoid the amplification step completely or induce the cultures only for short periods of time (2–3 hours). In the latter case, comparison of the restriction maps of clones before and after amplification with IPTG is recommended.

For induction with IPTG, cultures are grown in LB containing 25 µg/ml kanamycin until the OD<sub>600</sub> reaches ~0.8, at which point IPTG is added to a final concentration of 0.5–1 mM. The cells are incubated for a further 3 hours at 37°C and then harvested.

2. Transfer each culture to a 15-ml centrifuge tube. Harvest the cells by centrifugation at 3500g (5400 rpm in a Sorvall SS-34 rotor) for 5 minutes at 4°C. Resuspend each cell pellet in 3 ml of sterile H<sub>2</sub>O and repeat the centrifugation step.
3. Resuspend each cell pellet in 2 ml of Alkaline lysis solution I and place on ice.
4. Add 3 ml of Alkaline lysis solution II, and gently invert the tube several times to mix the solutions. Transfer the tube to an ice bath for 10 minutes.

**▲IMPORTANT** Because recombinant P1 and PAC clones are large enough to be sensitive to shearing, keep vortexing, pipetting, and shaking to a minimum during the isolation of DNA. Wherever possible, transfer by pouring the DNA from one tube to another. When pipetting cannot be avoided, use wide-bore pipette tips. Please see the information panel on **MINIMIZING DAMAGE TO LARGE DNA MOLECULES** in Chapter 2.

5. Add 3 ml of ice-cold Alkaline lysis solution III to each cell suspension, and mix the solution by gently inverting the tube several times. Store the tube on ice for 10 minutes.
6. Pellet the cellular debris by centrifugation at 12,000g (10,000 rpm in a Sorvall SS-34 rotor) for 10 minutes at 4°C.
7. Decant the supernatant (~7 ml) into a 30-ml Corex centrifuge tube and add an equal volume of isopropanol. Mix the solutions by gently inverting the tube several times and collect the precipitated nucleic acids by centrifugation at 12,000g (10,000 rpm in a Sorvall SS-34 rotor) for 10 minutes at 4°C.
8. Remove the supernatant by gentle aspiration. Invert the tube on a Kimwipe tissue until the last drops of fluid have drained away. Use a Pasteur pipette attached to a vacuum line to remove any drops remaining attached to the wall of the tube. Dissolve the pellet of nucleic acids in 0.4 ml of 0.3 M sodium acetate (pH 5.2). Heat the solution to 65°C briefly (for a few minutes) to assist in dissolving the nucleic acids.

### Purification of Recombinant P1 or PAC DNA

9. Transfer the DNA solution to a microfuge tube. Extract the solution once with an equal volume of phenol:chloroform. Separate the aqueous and organic phases by centrifugation at maximum speed for 5 minutes at room temperature in a microfuge. Transfer the upper aqueous phase to a fresh microfuge tube.
10. Add 1 ml of ice-cold ethanol. Mix the solutions by inverting the tube several times. Collect the precipitated DNA by centrifugation at maximum speed for 10 minutes at 4°C. Rinse the DNA pellet with 0.5 ml of 70% ethanol and centrifuge again for 2 minutes.
11. Carefully remove the supernatant. Store the open inverted tube at room temperature until no more traces of ethanol are visible. Add 0.4 ml of TE plus RNase to the pellet and place the closed tube at 37°C. Periodically during the next 15 minutes, shake the tube gently to assist in dissolving the DNA. Continue the incubation for a total of 2 hours.
12. Add 4 µl of 1 M MgCl<sub>2</sub> and 200 µl of 40% PEG solution. Mix well and collect the precipitated DNA by centrifugation at maximum speed for 15 minutes at 4°C in a microfuge.
13. Remove the supernatant by aspiration and resuspend the pellet in 0.5 ml of 0.5 M ammonium acetate. Add 1 ml of ethanol, mix the solutions by inverting the tube several times, and collect the precipitate by centrifugation at maximum speed for 15 minutes at 4°C in a microfuge.
14. Decant the supernatant and rinse the pellet twice with 0.5 ml of ice-cold 70% ethanol. Store the open inverted tube at room temperature until no more traces of ethanol are visible. Resuspend the damp pellet in 50 µl of TE (pH 8.0).

The yield of DNA varies between 2 µg and 5 µg per 10 ml of uninduced overnight culture.

15. For restriction enzyme analysis, digest 5–15 µl (~1 µg) of resuspended DNA and analyze the products either by 0.5% agarose gel electrophoresis or by PFGE.

Larger amounts of DNA are used in the enzymatic reactions to achieve adequate molar concentrations of substrate.



**ADDITIONAL PROTOCOL: PURIFICATION OF HIGH-MOLECULAR-WEIGHT DNA BY DROP DIALYSIS**

If high-molecular-weight (e.g., bacteriophage P1 or PAC) DNA will be used as a template in DNA sequencing reactions, or if restriction enzymes fail to digest the DNA to completion, then low-molecular-weight contaminants should be removed by drop dialysis.

**Additional Materials**

*Millipore Series V membranes (13-mm-diameter discs) pore size 0.025  $\mu$ m*  
*P1 DNA (prepared in Step 14 above)*

**Method**

1. Spot the remainder of the bacteriophage P1 DNA from Step 14 above in the center of a Millipore Series V membrane, floating shiny side up on 10 ml of sterile H<sub>2</sub>O in a 90-mm-diameter Petri dish.
2. Dialyze the DNA for 10 minutes.
3. Remove the drop to a clean microfuge tube and use aliquots of the dialyzed DNA for restriction enzyme digestion and/or DNA sequencing.

**ALTERNATIVE PROTOCOL: PURIFICATION OF HIGH-MOLECULAR-WEIGHT CIRCULAR DNA BY CHROMATOGRAPHY ON QIAGEN RESIN**

Qiagen resins have been used successfully to purify circular high-molecular-weight DNA (e.g., bacteriophage P1 DNA; e.g., please see Pierce and Sternberg 1992; MacLaren and Clarke 1996). However, this protocol will not work for linear high-molecular-weight DNA, which binds irreversibly to the column.

**CAUTION:** Please see Appendix 12 for appropriate handling of materials marked with <!>.

**Additional Materials**

*Cheesecloth*

*E. coli* host strain carrying P1 recombinant

*Elution buffer*

50 mM Tris-Cl (pH 8.1–8.2)

1.4 M NaCl

15% (v/v) ethanol

*Lysozyme*

Dissolve solid lysozyme at a concentration of 10 mg/ml in 10 mM Tris-Cl (pH 8.0) just before using.

*Qiagen-tip 500 or 2500 column with appropriate buffers (e.g., P3 and QBT, supplied in Qiagen kit).*

*Sorvall GSA rotor or equivalent*

*TB medium containing 25 µg/ml kanamycin*

*Wash buffer*

50 mM MOPS-KOH <!> (pH 7.5–7.6)

0.75 M NaCl

15% (v/v) ethanol

When making this buffer, adjust the pH of a MOPS/NaCl solution before adding the ethanol.

**Method**

1. Grow an overnight culture of the appropriate host strain carrying the P1 recombinant clone in 500 ml of TB containing 25 µg/ml kanamycin.
2. Recover the cells by centrifugation at 5000g (5500 rpm in a Sorvall GSA rotor) and digest them using lysozyme at a final concentration of 1 mg/ml and the modified alkaline procedure described in the Qiagen literature. After the addition of chilled P3 buffer and incubation on ice for 20 minutes, centrifuge the lysate at 15,000g (9600 rpm in a Sorvall GSA rotor) for 30 minutes at 4°C.
3. Promptly transfer the supernatant to a fresh tube, and filter the supernatant through several layers of cheesecloth.
4. Equilibrate a Qiagen-tip column with 10 ml of QBT buffer (supplied in Qiagen kit).
5. Apply the filtered lysate from Step 3 to the column.
6. Wash the column with 30 ml of wash buffer.  
Do not wash the column with more than 30 ml of this buffer.
7. Elute the P1 DNA from the column with 15 ml of elution buffer.
8. Precipitate the eluted DNA with 0.7 volume of isopropanol. Collect the precipitated DNA by centrifugation at 10,000g (12,000 rpm in a Sorvall SS-34 rotor) for 30 minutes at 4°C.
9. Rinse the pellet with 70% ethanol. Remove as much ethanol as possible, and resuspend the DNA in 200 µl of TE (pH 8.0).
10. Analyze samples of the DNA (2.0 µl or ~1 µg) by restriction enzyme digestion and electrophoresis through a conventional agarose gel or a pulsed-field agarose gel.

# Protocol 6

---

## Transferring Bacteriophage P1 Clones between *E. coli* Hosts

**T**HE YIELD AND QUALITY OF BACTERIOPHAGE P1 DNA OBTAINED from different strains of *E. coli* vary depending on the genotype of the host bacterium and the particular sequence of foreign DNA carried in the recombinant. Problems with low yield or poor quality can sometimes be overcome by transferring the P1 or PAC recombinant into a strain of *E. coli* that does not express Cre recombinase (e.g., NS3516; Sternberg et al. 1994). Two methods are commonly used to transfer recombinant P1 clones from one host strain to another:

- **Transduction** of the P1 recombinant plasmid involves superinfection of the strain originally carrying the P1 clone with wild-type P1 bacteriophage. During the ensuing cycle of lytic infection, the P1 plasmid is packaged into P1 particles, which can be used to infect another strain of *E. coli*. Transformed cells containing the P1 clone in plasmid form are then selected on plates containing kanamycin. Stocks of wild-type P1 bacteriophage, together with protocols for transduction, are often supplied by commercial companies as part of their service to screen P1 libraries.
- **Electroporation** of purified P1 DNA into a different strain of host cells is a simple method, but some of the recombinant genomes may suffer deletions during electroporation. The restriction patterns of the original recombinant and DNAs from a series of independent transformants should be compared to identify clones that have not suffered rearrangements during electroporation.

The following protocol for transfer of P1 clones by electroporation was supplied by Ray MacDonald (University of Texas Southwestern Medical Center, Dallas) and describes the electroporation of a commercially available strain of *E. coli* (JS-5, Bio-Rad). In the MacDonald laboratory, the yields of bacteriophage P1 DNA were increased as much as tenfold after transfer into strains JS-5 or DH10B from NS3529. Similar results have been reported after transfer into *E. coli* strain NS3516 (MacLaren and Clarke 1996).

### MATERIALS

---

#### Enzymes and Buffers

*Restriction endonucleases*

#### Gels

*Agarose gel*

Please see Step 10.

**Media**

*LB agar plates containing 25 µg/ml kanamycin*

*SOC medium*

Warm the SOC medium to 37°C before use.

*TB medium containing 25 µg/ml kanamycin*

**Special Equipment**

*Equipment for electroporation*

Please see Chapter 1, Protocol 26.

**Additional Reagents**

*Step 9 of this protocol requires reagents listed in Protocol 5 of this chapter.*

**Vectors and Bacterial Strains**

*Closed circular recombinant P1 DNA*

Prepared as described in Protocol 5 of this chapter.

*E. coli strain (e.g., DH10B) as frozen electrocompetent cells*

Please see Chapter 1, Protocol 26.

**METHOD**

---

1. Dilute 2–3 µg of P1 plasmid DNA to a concentration of 60 ng/µl in sterile H<sub>2</sub>O. Set up a control lacking P1 DNA (sterile H<sub>2</sub>O only), and carry the control through the electroporation procedure in parallel with the DNA sample.
2. Thaw vials of electrocompetent cells on ice and prechill 0.1-cm electroporation cuvettes.  
For information on electroporation, please see Chapter 1, Protocol 26.
3. Combine 20 µl of cells and 1 µl of P1 DNA in the cold cuvette.
4. Set the electroporation device to 1.8 kV, 200 ohms, and 25 µF.
5. Shock the cells. The optimum time constant is usually ~5 milliseconds.
6. Immediately add 0.5 ml of prewarmed (37°C) SOC medium to the cell suspension. Transfer the suspension to a culture tube and incubate the suspension for 1 hour at 37°C with moderate agitation.
7. Plate 100-µl aliquots of the cell suspensions on LB plates containing 25 µg/ml kanamycin. Incubate the plates overnight at 37°C.  
The control plates (no P1 DNA) should remain sterile; plates from the culture treated with P1 DNA should contain several hundred transformed colonies.
8. Transfer 10–12 colonies into separate 11-ml aliquots of TB containing 25 µg/ml kanamycin. Incubate the cultures overnight at 37°C with vigorous agitation.
9. Prepare P1 DNA as described in Protocol 5.  
The remainder of the overnight cultures can be stored at –80°C in TB/kanamycin containing 30% (v/v) glycerol.
10. Perform digestions with several different restriction endonucleases and compare the patterns of the newly isolated DNAs with that of the original recombinant by agarose gel electrophoresis.

# Protocol 7

---

## Working with Bacterial Artificial Chromosomes

**B**ACTERIAL ARTIFICIAL CHROMOSOMES, OR BACs, ARE SYNTHETIC VECTORS based on the fertility (F) factor of *E. coli*. Among the properties that make the F factor so attractive as a high-capacity vector for genomic DNA are the following:

- A low copy number (1–2 molecules/cell; Frame and Bishop 1971) and the presence of two genes (*parA* and *parB*) ensure the accurate partitioning of F-factor DNA molecules to daughter cells during cell division. *parB* is also responsible for excluding extraneous F plasmids from cells. This combination of low copy number and an insulated environment limits the opportunities for intermolecular recombination between plasmid molecules within cells. In practical terms, this limitation means that recombinant BACs display a lower level of rearrangement and chimerism of foreign DNA sequences than YACs.
- It has the ability to propagate very large segments of DNA. Naturally occurring F factors can carry up to one quarter of the *E. coli* chromosome without strain or instability.
- It is easy to manipulate. Because of its closed circular nature, F-factor DNA can be isolated from *E. coli* by straightforward, familiar techniques such as alkaline lysis, isopycnic centrifugation in CsCl-ethidium bromide gradients, and spun column chromatography through resins (Zimmer and Verrinder Gibbins 1997). Sufficient BAC DNA can usually be obtained from a 5-ml bacterial culture for restriction analysis, PCR, and fluorescent in situ hybridization.

For more information on F factors, please see the panel on **F FACTORS**.

### BAC CLONING VECTORS

---

The features described here were exploited by Mel Simon and colleagues in the early 1990s to develop BAC vectors that contain, in addition to *parA* and *parB*, genes (*oriS* and *repE*) involved in the initiation and orientation of F-factor DNA replication. The vectors (~7.4 kb in length) are also equipped with a polycloning sequence and a selectable marker (chloramphenicol resistance). Newer BAC vectors contain additional elements that (1) allow color-based identification (*lacZ*,  $\alpha$ -complementation) of recombinants carrying inserts and (2) contain elements to facilitate recovery and manipulation of cloned DNAs (Kim et al. 1996; Asakawa et al. 1997) (please see Figure 4-2 in the introduction to this chapter).

**F FACTORS**

Fertility or F factors were discovered through the independent work of Cavalli-Sforza (1950) and Hayes (1952) on the unidirectional transfer of chromosomal markers during conjugal mating of *E. coli*. The ability to serve as a donor of chromosomal markers (the F<sup>+</sup> character) was transferred to recipient cells (F<sup>-</sup>) with very high efficiency (Cavalli-Sforza et al. 1953; Hayes 1953), suggesting that conjugative transfer required a transmissible fertility factor, which was designated F. We now know that this original F-factor plasmid was a naturally occurring variant that could integrate into the host chromosome and transfer genetic markers at an abnormally high frequency. The development of conjugative transfer of markers was therefore advanced several years by this happy chance.

The F factor of *E. coli* is an ~100-kb plasmid encoding more than 60 proteins involved in replication, partition, and conjugation (for review, please see Willetts and Skurray 1987). Usually carried in the form of a double-stranded, closed circular DNA (1–2 copies/cell), the F factor can nevertheless integrate at random into at least 30 sites on the *E. coli* chromosome (for review, please see Low 1987). Cells carrying F, either episomally or in an integrated state, express up to three hair-like F pili, which are flexible hollow cylinders ~8 nm in diameter with a 2-nm axial lumen. The pili are composed largely of a single protein, pilin, which is the processed product of the plasmid *traA* gene (for reviews, please see Ippen-Ihler and Minkley 1986; Paranchych and Frost 1988). F-pili not only are required for productive physical contact between donor and recipient cells, but also provide sites for the attachment of male-specific, filamentous bacteriophages such as M13 and fd (for more information, please see the introduction to Chapter 3).

**CONSTRUCTION OF GENOMIC LIBRARIES IN BAC VECTORS**

Genomic libraries are constructed in BAC vectors essentially the same way as in PAC vectors (please see Figure 4-11). In brief, closed circular vector DNA is linearized by digestion with a restriction enzyme, treated with alkaline phosphatase and ligated to genomic DNA that has been partially digested with an appropriate restriction enzyme, and fractionated by PFGE. To prevent formation of chimeric clones, the ligation reaction contains a tenfold molar excess of vector DNA. The ligation products are introduced into *E. coli* by electroporation, and transformants are selected on agar plates containing chloramphenicol, IPTG, and X-gal. White colonies carrying recombinant BACs are transferred to a second plate containing the same additives to confirm the color selection. White colonies are again picked and arrayed in the wells of microtiter plates. These steps are described in more detail in papers describing the establishment of libraries of genomic DNA of various species (e.g., human, Shizuya et al. 1992; Kim et al. 1996; sorghum, Woo et al. 1994; rice, Wang et al. 1995; bovine, Cai et al. 1995; chicken, Zimmer and Verrinder Gibbins 1997).

Unlike bacteriophage  $\lambda$ , cosmid, and bacteriophage P1 vectors, BACs have no packaging limitations, and recombinants may contain segments of genomic DNA that exceed 300 kb in size (Shizuya et al. 1992). However, the average size of the inserts in many BAC libraries is considerably smaller, between 100 kb and 140 kb (Kim et al. 1996). Nevertheless, libraries with much larger inserts can be generated by careful sizing of the genomic DNA before cloning and by optimizing conditions for electroporation that favor transformation of *E. coli* with very large plasmids (Zimmer and Verrinder Gibbins 1997). To prevent intrachromosomal recombination between repetitive sequences commonly found in eukaryotic DNAs, BACs are propagated in recombination-defective hosts such as *E. coli* DH10B (*mcrA*  $\Delta$ [*mrr-hsd RMS-mcrBC*] *recA1*). Large plasmid DNAs can be introduced into this strain with high efficiency by electroporation (Sheng et al. 1995), a property that facilitates both construction of libraries and retrofitting of individual BAC recombinants with accessory elements that facilitate manipulation of large cloned DNAs (Mejia and Monaco 1997).

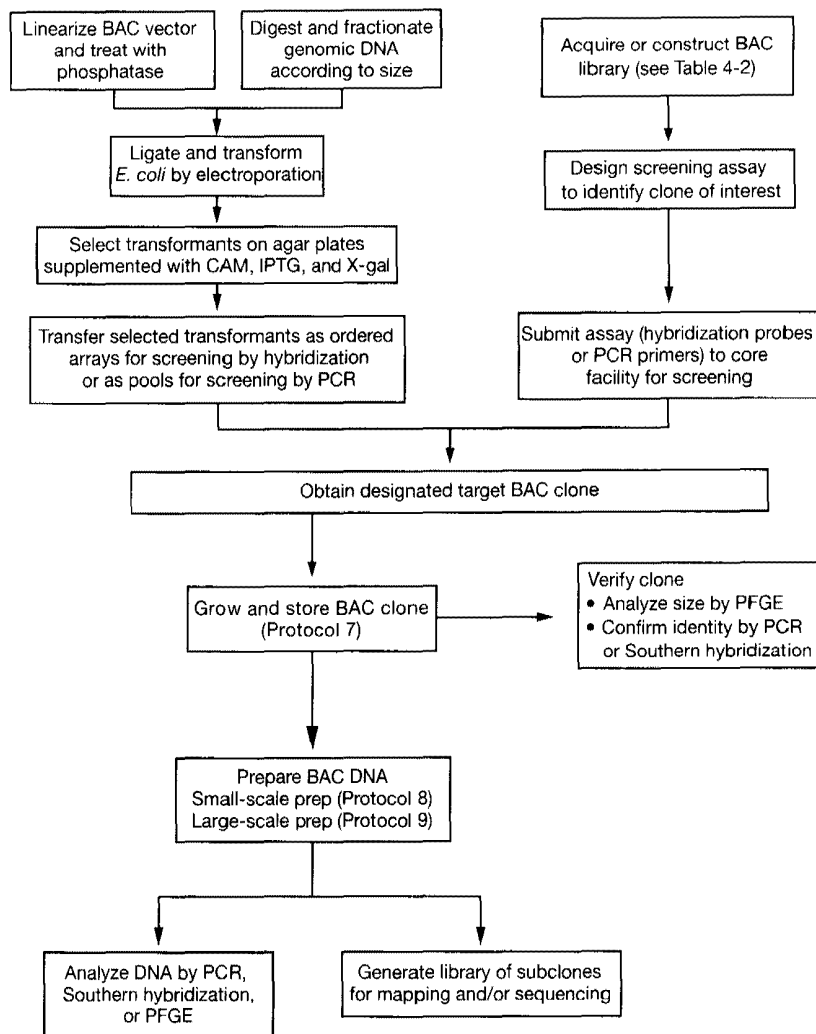


FIGURE 4-11 Flowchart: Cloning in BAC Vectors

## SCREENING BAC LIBRARIES

Genomic libraries constructed in BACs are routinely gridded into ordered arrays for screening by hybridization, or they are combined into bins, pools, and subpools for rapid screening by PCR. Many of these arrayed libraries are not readily available from academic sources but are instead maintained by commercial companies such as Research Genetics, Inc., or Genome Systems, Inc. (please see Table 4-2). For most investigators, it is by far less expensive and faster to obtain recombinant BAC clones from these commercial suppliers than to construct their own libraries. In most cases, a hybridization probe or a pair of oligonucleotides specific for the chromosomal region of interest is sent to a commercial supplier, who screens genomic BAC libraries of the appropriate species and returns individual positive clones as transformed bacteria or BAC DNA. In our experience, at least 50% of these positive clones actually contain the region of interest, in all or part. The remainder are false positives of one sort or another. For this reason, it is essential to confirm by independent methods the identity and chromosomal location of newly isolated BAC clones. These methods include PCR analysis with multiple primer pairs, DNA sequencing, Southern

hybridization with more than one probe, genetic mapping by analysis of radiation hybrid panels, and physical mapping by fluorescent in situ hybridization (for a more detailed discussion of these techniques, please see Green et al. 1997–1999).

BAC DNA is generally isolated from individual clones of transformed *E. coli* by alkaline lysis and may be further purified by column chromatography. Depending on the size and nature of the insert, a 5.0-ml culture of transformed bacterial cells will yield 0.1–0.4 µg of BAC DNA, suitable for analytical restriction enzyme digestions, PCR, and Southern blotting (Protocol 8). More extensive characterization (e.g., detailed restriction mapping, DNA sequencing, or subcloning) requires purification of BAC DNA from larger-scale cultures (250–500 ml) by column chromatography (Protocol 9). In this and the following two protocols, we outline methods for the propagation and storage of BAC-transformed bacteria and the isolation of BAC DNA.

## WHEN A NEW BAC APPEARS IN THE LABORATORY

---

BACs are supplied by commercial companies as purified DNA or as cultures of transformed bacteria. In general, BACs should be maintained as frozen, transformed bacteria and not as stocks of DNA. DNA stored at 4°C is susceptible to degradation by contaminating enzymes; DNA stored at –20°C is damaged by freezing and thawing.

## MATERIALS

---

**CAUTION:** Please see Appendix 12 for appropriate handling of materials marked with <!.>.

### Buffers and Solutions

Please see Appendix 1 for components of stock solutions, buffers, and reagents. Dilute stock solutions to the appropriate concentrations.

*LB freezing buffer*

### Enzymes and Buffers

*Restriction endonucleases*

Please see Step 5. Choose restriction endonucleases appropriate for measuring insert size in BACs.

### Gels

*Equipment for pulsed-field gel electrophoresis*

Please see the panel on **PULSED-FIELD GEL ELECTROPHORESIS** in Protocol 1.

### Media

*LB agar plates containing 12.5 µg/ml chloramphenicol <!.>*

*LB medium containing 12.5 µg/ml chloramphenicol*

Dissolve solid chloramphenicol in ethanol to a final concentration of 34 mg/ml. Prepare and add the chloramphenicol just before use.

### Special Equipment

*Equipment for electroporation (optional)*

Required only if the BAC isolate is supplied as purified DNA (please see Step 1). Please see Chapter 1, Protocol 26.



## Additional Reagents

Step 4 of this protocol requires reagents listed in Protocol 8 of this chapter.

Step 5 of this protocol requires either reagents listed in Chapter 8, Protocol 12 or reagents listed in Chapter 6, Protocol 10.

## Vectors and Bacterial Strains

BAC DNA

or

Culture of *E. coli* strain transformed with BAC isolate

*E. coli* strain (e.g., DH10B) as frozen electrocompetent cells

Required only if the BAC isolate is supplied as purified DNA. Please see Chapter 1, Protocol 26.

## METHOD

---

1. Prepare fresh BAC transformants.

### IF THE BAC IS SUPPLIED IN THE FORM OF DNA

- a. Transform *E. coli* (strain DH10B) with BAC DNA by electroporation.

Because the efficiency of transformation by large BACs decreases dramatically as a function of the voltage applied during electroporation, it is best to set up a series of electroporation reactions at voltages ranging from 13 kV/cm to 25 kV/cm (Sheng et al. 1995; Zimmer and Verrinder Gibbins 1997).

- b. Plate 2.5, 25, and 250  $\mu$ l of each batch of electroporated bacteria onto LB agar plates containing 12.5  $\mu$ g/ml chloramphenicol. Incubate the plates for 16–24 hours at 37°C.

### IF THE BAC IS SUPPLIED AS A TRANSFORMED BACTERIAL STOCK

- a. Streak the culture without delay onto LB agar plates containing 12.5  $\mu$ g/ml chloramphenicol.
- b. Incubate the plates for 12–16 hours at 37°C.
2. Select 12 individual transformants and inoculate these into 5-ml aliquots of LB medium containing chloramphenicol (12.5  $\mu$ g/ml). Grow the cultures overnight at 37°C with vigorous shaking.
3. Use a loopful of each 5-ml culture to set up cultures of the 12 transformants in LB freezing medium. When these cultures have grown, transfer them to a –20°C freezer for storage.
4. Purify the BAC DNA from 4.5 ml of each 5-ml culture from Step 2, as described in Protocol 8.
5. Analyze the BAC DNA.
  - a. Confirm by PCR that the BACs contain the chromosomal region of interest (please see Chapter 8, Protocol 12) or Southern hybridization (please see Chapter 6, Protocol 10).
  - b. Measure the size of the inserts by digestion with restriction enzymes and PFGE.
6. On the basis of the results, select one or more of the BACs for further analysis.

# Protocol 8

---

## Isolation of BAC DNA from Small-scale Cultures

**S**MALL AMOUNTS OF BAC DNAs ARE PREPARED from 5-ml cultures of BAC transformed cells. DNA is isolated by an adaptation of the alkaline lysis method described in Chapter 1, Protocol 1. The yield of the preparation is 0.1–0.4  $\mu\text{g}$  of BAC DNA, which is suitable for analysis by restriction enzyme digestion, PCR, or Southern blotting.

### MATERIALS

---

**CAUTION:** Please see Appendix 12 for appropriate handling of materials marked with <!>.

#### Buffers and Solutions

Please see Appendix 1 for components of stock solutions, buffers, and reagents. Dilute stock solutions to the appropriate concentrations.

*Ethanol*

*Isopropanol*

*Solutions for DNA isolation:*

*Alkaline lysis solution I, ice cold*

*Alkaline lysis solution II*

Solution II should be freshly prepared and used at room temperature.

*Alkaline lysis solution III, ice cold*

Place the solution on ice just before use.

*STE solution, ice cold*

Place the solution on ice just before use.

*TE (pH 8.0)*

#### Enzymes and Buffers

*Restriction endonucleases*

#### Gels

*Equipment for pulsed-field gel electrophoresis*

Please see the panel on **PULSED-FIELD GEL ELECTROPHORESIS** in Protocol 1.

#### Media

*LB medium containing 12.5  $\mu\text{g}/\text{ml}$  chloramphenicol <!>*

Dissolve solid chloramphenicol in ethanol to a final concentration of 34 mg/ml. Prepare and add the chloroamphenicol just before use.

#### Nucleic Acids and Oligonucleotides

*DNA markers for pulsed-field gel electrophoresis*

Obtain megabase markers from Life Technologies or use BACs whose sizes have been previously established.

## Centrifuges and Rotors

*Sorvall SS-34 rotor or equivalent*

## Special Equipment

*Chromatography resin*

Chromatography resin may be required to facilitate restriction endonuclease digestion of BAC DNA (please see Step 9). Resins can be purchased from Qiagen Inc. (Qiaprep Spin Plasmid MiniPrep kit works very nicely) or from Genome Systems, Inc. (KB-100 columns).

## Vectors and Bacterial Strains

*E. coli strain transformed with BAC isolate*

Please see Protocol 7 of this chapter.

## METHOD

---

1. Prepare 5-ml cultures of BAC-transformed *E. coli* in LB medium containing 12.5 µg/ml chloramphenicol, and grow the cultures overnight at 37°C with vigorous shaking.
2. Collect the bacterial cells by centrifugation at 2000g (4100 rpm in a Sorvall SS-34 rotor) for 5 minutes at 4°C. Decant the medium carefully and remove any residual drops by aspiration.
3. Add 5 ml of ice-cold STE to each tube, and resuspend the bacterial pellet by pipetting. Recover the cells by centrifugation as in Step 2.  
Cleaner preparations of BAC DNA are obtained if the cells are washed briefly in ice-cold STE at this stage.
4. Resuspend the cells in 200 µl of ice-cold Alkaline lysis solution I. Transfer the cells to an ice-cold microfuge tube. Place the tube on ice.  
The cell suspension may be gently vortexed to break up clumps of cells.
5. Add 400 µl of freshly prepared Alkaline lysis solution II to the tube. Gently invert the closed tube several times. Place the tube on ice.
6. Add 300 µl of ice-cold Alkaline lysis solution III to the tube. Gently invert the closed tube several times. Place the tube on ice for 5 minutes.
7. Remove the precipitated cell debris by centrifugation at maximum speed for 5 minutes at 4°C in a microfuge. Decant the supernatant into a fresh microfuge tube. Add 900 µl of isopropanol at room temperature and mix the contents of the tube by gentle inversion.
8. Immediately collect the precipitated nucleic acids by centrifugation at maximum speed for 5 minutes at room temperature in a microfuge. Discard the supernatant and carefully rinse the pellet with 1 ml of 70% ethanol. Centrifuge the tube for 2 minutes at room temperature and remove the ethanol by aspiration. Allow the pellet of nucleic acid to dry in the air for 5–10 minutes. Dissolve the damp pellet in 50 µl of TE (pH 8.0).  
The usual yield of BAC DNA from a 5-ml culture is 0.1–0.4 µg.
9. Digest the BAC DNA with restriction endonucleases.  
Occasional preparations are resistant to cleavage and must be purified further by column chromatography on Qiagen resin or KB-100 columns. In each case, follow the manufacturer's directions precisely.
10. Analyze the digested BAC DNA by PFGE, using DNA markers of an appropriate size.

# Protocol 9

---

## Isolation of BAC DNA from Large-scale Cultures

**E**XTENSIVE ANALYSIS OF BAC RECOMBINANTS, including detailed restriction mapping, DNA sequencing, or subcloning, requires more DNA than is provided by a small-scale culture (Protocol 8). In this protocol, the isolation procedure is scaled up to accommodate large-scale cultures carrying a recombinant BAC. The average yield from a 500-ml culture of BAC-transformed cells is 20–25 µg of BAC DNA. The DNA may be further purified by column chromatography.

### MATERIALS

---

**CAUTION:** Please see Appendix 12 for appropriate handling of materials marked with <!.>.

#### Buffers and Solutions

Please see Appendix 1 for components of stock solutions, buffers, and reagents. Dilute stock solutions to the appropriate concentrations.

*Ethanol*

*Isopropanol*

*Phenol:chloroform (1:1, v/v) <!.>*

*Solutions for DNA isolation:*

*Alkaline lysis solution I, ice cold*

For large-scale preparations of BAC DNA, sterile Alkaline lysis solution I should be supplemented just before use with DNase-free RNase at a concentration of 100 µg/ml.

*Alkaline lysis solution II*

Solution II should be freshly prepared and used at room temperature.

*Alkaline lysis solution III, ice cold*

Place the solution on ice just before use.

*STE solution, ice cold*

Place the solution on ice just before use.

*TE (pH 8.0)*

#### Enzymes and Buffers

*Lysozyme*

*Restriction endonucleases*

#### Nucleic Acids and Oligonucleotides

*DNA markers for pulsed-field gel electrophoresis*

Obtain megabase markers from Life Technologies or use BACs whose sizes have been previously established.

## Gels

### *Equipment for pulsed-field gel electrophoresis*

Please see the panel on **PULSED-FIELD GEL ELECTROPHORESIS** in Protocol 1.

## Media

### *LB medium containing 12.5 µg/ml chloramphenicol <math>\langle ! \rangle</math>*

Dissolve solid chloramphenicol in ethanol to a final concentration of 34 mg/ml. Prepare and add the chloroamphenicol just before use.

## Centrifuges and Rotors

*Sorvall GSA rotor or equivalent, with Oakridge tubes (Nalgene)*

## Special Equipment

### *Chromatography resin*

Chromatography resin may be required to facilitate restriction endonuclease digestion of BAC DNA (please see Step 13). Resins can be purchased from Qiagen Inc. or from Genome Systems, Inc. (KB-100 columns).

## Vectors and Bacterial Strains

### *E. coli strain transformed with BAC isolate*

Please see Protocol 7 of this chapter. Prepare a fresh overnight culture; please see Step 1.

## METHOD

---

1. Inoculate 500 ml of LB medium containing 12.5 µg/ml of chloramphenicol with 50 µl of a saturated overnight culture of BAC-transformed cells. Incubate the 500-ml culture for 12–16 hours at 37°C with vigorous agitation (300 cycles/minute) until the cells reach saturation.
2. Harvest the cells from the culture by centrifugation at 2500g (3900 rpm in a Sorvall GSA rotor) for 15 minutes at 4°C. Pour off the supernatant, and invert the open centrifuge bottle to allow the last drops of the supernatant to drain away.
3. Resuspend the bacterial pellet in 100 ml of ice-cold STE. Collect the bacterial cells by centrifugation as described in Step 2.  
If necessary, the washed cell pellet may be stored for several days in the sealed centrifuge bottle at -20°C.
4. Resuspend the bacterial pellet in 24 ml of Alkaline lysis solution I containing DNase-free RNase (100 µg/ml). Add lysozyme to a final concentration of 1 mg/ml.  
Make sure that the cells are completely resuspended and that the suspension is free of clumps.
5. Add 24 ml of freshly prepared Alkaline lysis solution II. Close the top of the centrifuge bottle and mix the contents thoroughly by gently inverting the bottle several times. Incubate the bottle for 5 minutes on ice.
6. Add 24 ml of ice-cold Alkaline lysis solution III. Close the top of the centrifuge bottle and mix the contents gently but thoroughly by swirling the bottle until there are no longer two distinguishable liquid phases. Place the bottle on ice for 5 minutes.

7. Centrifuge the bacterial lysate at 15,000g (9600 rpm in a Sorvall GSA rotor) for 10 minutes at 4°C. At the end of the centrifugation step, decant the clear supernatant into a polypropylene centrifuge bottle. Discard the pellet remaining in the centrifuge bottle.

The failure to form a compact pellet after centrifugation is usually a consequence of inadequate mixing of the bacterial lysate with Alkaline lysis solution III (Step 6). If the bacterial debris does not form a tightly packed pellet, centrifuge again at 15,000g for a further 15 minutes, and then transfer as much of the supernatant as possible to a fresh tube.
8. Add an equal volume of phenol:chloroform. Mix the aqueous and organic phases by gently inverting the tube several times. Separate the phases by centrifugation at 3000g (4300 rpm in a Sorvall GSA rotor) for 15 minutes at room temperature.
9. Use a wide-bore pipette to transfer the aqueous layer to a fresh centrifuge bottle and add an equal volume of isopropanol. Invert the bottle several times to mix well.
10. Mark the tube on one side and place it in a centrifuge rotor with the marked side facing away from the center of the rotor. Marking in this way will aid in the subsequent identification of the nucleic acid pellet. Recover the precipitated nucleic acids by centrifugation at 15,000g (9600 rpm in a Sorvall GSA rotor) for 15 minutes at *room temperature*.

▲**IMPORTANT** Salt may precipitate if centrifugation is carried out at 4°C.
11. Decant the supernatant carefully, and invert the bottle on a paper towel to allow the last drops of supernatant to drain away. Rinse the pellet and the walls of the bottle with 20 ml of 70% ethanol at room temperature. Drain off the ethanol, and place the inverted tube on a pad of paper towels for a few minutes at room temperature to allow the ethanol to evaporate.

▲**WARNING** The DNA pellet is easily dislodged and lost at this step.
12. Gently dissolve the pellet of BAC DNA in 0.2 ml of TE (pH 8.0). Assist in the dissolution of the DNA by tapping the sides of the bottle rather than vortexing. Measure the concentration of DNA by absorption spectroscopy (please see Appendix 8).

The average yield of BAC DNA is 20–25 µg per 500-ml culture.
13. Digest the BAC DNA with restriction endonucleases.

Occasional preparations are resistant to cleavage and must be purified further by column chromatography on Qiagen resin or KB-100 columns. In each case, follow the manufacturer's directions precisely.
14. Analyze the digested BAC DNA by PFGE, using DNA markers of an appropriate size.

# Protocol 10

---

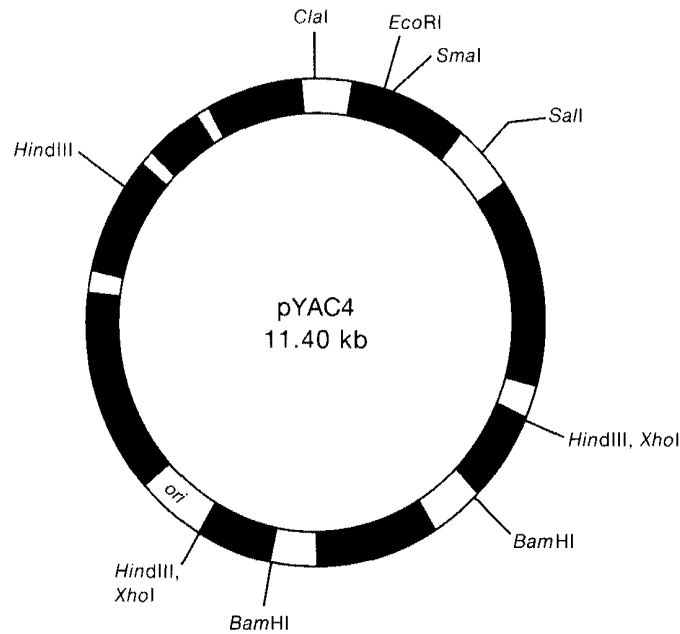
## Working with Yeast Artificial Chromosomes

**U**NTIL THE MID 1980S, NO TECHNIQUES WERE AVAILABLE to isolate, propagate, and analyze coherent large segments of genomic DNA. Before then, detailed physical and functional studies were of necessity carried out on segments of DNA of a size that could fit into the shells of bacteriophage  $\lambda$  or cosmid vectors. Two separate advances were required to break free from this constraint: the widespread acceptance of PFGE as a method to separate large DNA molecules (please see the introduction to Chapter 5) and the development of yeast artificial chromosomes (YACs) as vehicles to clone and propagate much larger segments of genomic DNA. The basic theory of YACs was first published in 1983 (Murray and Szostak 1983), but the importance of the technique was not fully realized until David Burke, working in Maynard Olson's group, developed YAC vectors that were capable of propagating several hundred kilobases of DNA and showed that they could be used to generate entire libraries of mammalian genomic DNA (please see Burke et al. 1987).

Construction of genomic libraries in YACs is time-consuming, expensive, and demanding, requiring not only expertise in handling large DNA molecules, but also familiarity with the genetics and molecular biology of a different type of microbial host, *S. cerevisiae*. Furthermore, efficient storage of genomic YAC libraries involves arraying clones into the wells of microtiter plates, whereas library screening often necessitates generating a hierarchy of pools of YAC clones from within the library. This combination of skills and resources—manipulation of fragile molecules of DNA, fluency in yeast genetics, and access to robotic devices—is rarely found in a single laboratory. The construction of new YAC libraries is therefore best left to specialists, whereas screening of existing YAC libraries is generally carried out in collaboration with Genome Centers or, with increasing frequency, on a commercial basis. YAC libraries of the genomes of many species are now available from these sources (e.g., please see Burke 1991; van Ommen 1992; see also Table 4-2 in the introduction to this chapter).

### YAC Cloning Vectors

Modern YAC vectors are mosaics of *cis*-acting components and functional units drawn from several different organisms. They are propagated as conventional plasmids in *E. coli* and are con-



**FIGURE 4-12 pYAC4**

The general features important for construction of YAC libraries are depicted: the arrangement of genes in the circular vector, as well as important sequence elements, and key restriction sites (for further details, please see Burke et al. 1987; Burke and Olson 1991).

verted into two arms by restriction enzyme cleavage during the cloning process. Genomic YAC libraries are created *in vitro* by inserting very high-molecular-weight segments of genomic DNA between these two arms, generating linear molecules whose structure and topology resemble that of an authentic yeast chromosome. Because YAC vectors contain elements required for autonomous replication, for segregation of chromosomes between daughter cells, and for chromosome stability, recombinant YACs introduced into *S. cerevisiae* become part of the organism's complement of chromosomes.

An example of a vector (pYAC4) belonging to the commonly used pYAC series is shown in Figure 4-12. For descriptions of other vectors of this series, please see Reeves et al. (1992). Vectors of the pYAC series contain the following:

- Two sets of telomeric repeat (*TEL*) sequences, separated by a stuffer fragment, are required for the formation of stable chromosome ends. In most YAC vectors, the telomeric sequences are derived from *Tetrahymena*. Before cloning, the vector DNA is digested with *Bam*HI to release the stuffer fragment carrying the *HIS3* gene, which encodes imidazoleglycerolphosphate (IGP) dehydratase, an enzyme that catalyzes a step in the histidine biosynthetic pathway.
- A cloning site located within the *SUP4* gene that upon cleavage separates the vector DNA into two arms. The *SUP4* gene product (a tRNA) suppresses a mutation at the *ade* locus of appropriate strains of yeast, resulting in a change in the color of colonies from red to white in the presence of limiting concentrations of adenine. Transformants carrying recombinant YACs, in which the *SUP4* gene is interrupted by insertion, grow as red colonies (Hieter et al. 1985) (please see the panel on **SCREENING YAC RECOMBINANTS** on the following page).



**SCREENING YAC RECOMBINANTS**

The *ade2* allele contains a nonsense mutation that can be suppressed by *SUP4* carried in YAC vectors such as pYAC4. Cloning sites for the vector lie within the *SUP4* gene. If no insert is present in the YAC vector, the *SUP4* gene is intact (active) and the *ade2* mutation is suppressed. Transformants carrying this parent vector grow as white colonies on acid-hydrolyzed casein (AHC) medium. Conversely, if an insert is present in the pYAC4 vector, then the *SUP4* gene is inactivated and the nonsense mutation in the *ade2* allele prevents synthesis of the phosphoribosylaminoimidazole carboxylase enzyme in the host. In the absence of this enzyme, phosphoribosylglycinamide accumulates in the yeast, which grow as red or pink colonies, depending on the amount of enzyme that builds up. The use of this simple color screen was initially reported in the late 1950s by Herschel Roman (1957), a leading light in corn and yeast genetics. Since that time, the scheme has been used with great elegance to monitor gene recombination events (Fogel et al. 1981) and to examine chromosome instability (Hieter et al. 1985; Koshland et al. 1985).

The left arm contains:

- One of the telomeric sequences.
- A centromeric (*CEN4*) sequence that attaches to the mitotic spindle and is required for efficient segregation of chromosomes between daughter cells. This segment of DNA also maintains the artificial chromosome at a copy number of one in the cell.
- An autonomously replicating sequence (*ARS1*) that contains signals required for bidirectional replication of DNA in yeast.
- An ampicillin resistance marker and the *colE1* origin of replication for propagation of the vector in *E. coli*.
- An auxotrophic marker, *TRP1*, that confers on *trp* auxotrophs of *S. cerevisiae* the ability to grow on media lacking tryptophan.

The right arm contains:

- The second telomeric sequence.
- An auxotrophic marker, *URA3*, that confers on *ura* auxotrophs of *S. cerevisiae* the ability to grow on media lacking uracil.

## CONSTRUCTION OF GENOMIC LIBRARIES IN YAC VECTORS

High-molecular-weight genomic DNA is extracted from the target organism and partially digested with a restriction enzyme that generates cohesive termini compatible with those of the cloning site in the YAC vector. The DNA is fractionated by PFGE to remove fragments <200 kb in size before ligation to a large molar excess of dephosphorylated vector (Anand et al. 1990). The recipient yeast strain, auxotrophic for uracil and tryptophan, is grown in rich medium and converted to spheroplasts by digestion of cell walls with lyticase or Zymolyase. The spheroplasts are transformed with the products of the ligation reaction in the presence of polyamines (to prevent degradation of DNA; Larin et al. 1991) and plated in agar medium lacking uracil and tryptophan. After regeneration of the cell walls, the transformed cells form colonies that carry a recombinant YAC and are prototrophic for uracil and tryptophan. Regeneration of transformed colonies is generally carried out in 2% sodium alginate in the presence of  $\text{Ca}^{2+}$ , which ensures that the colonies grow on the surface of the plate (Lai and Cantrell 1989).

For more information on construction of YAC libraries, please see Burke et al. (1987), Albertsen et al. (1990), Feingold et al. (1990), McCormick et al. (1990), Schlessinger (1990), Burke and Olson (1991), Anand (1992), Reeves et al. (1992), Riley et al. (1992), and Ramsay (1994). Yeast strains commonly used to construct and propagate YAC libraries are described by Reeves et al. (1992).

## CHARACTERIZATION OF YAC LIBRARIES

---

The quality and complexity of a YAC library are generally assessed by isolating a few dozen random clones and measuring the size of the inserts by PFGE. The depth of coverage may then be calculated by multiplying the average insert size (in kb) by the number of full clones in the library and dividing the product by the size of the genome (also in kb). A library containing four genome equivalents is required to cover 95% of the genomic DNA sequence (Riley et al. 1992; please see the panel on **GENOMIC LIBRARIES** in the introduction to this chapter).

All YAC libraries contain chimeric clones, whose inserts consist of more than one fragment of genomic DNA (please see Problems with YACs below). Chimerism is best detected by fluorescent in situ hybridization of individual YACs to preparations of metaphase chromosomes (e.g., please see Lichter and Ward 1990; Wada et al. 1990; Montanaro et al. 1991). If positive signals are detected at more than one chromosomal location, the original YAC must be a composite of DNA sequences from different genomic regions.

## SCREENING OF YAC LIBRARIES

---

In earlier times, unordered YAC libraries were screened by hybridization of radiolabeled probes to the DNA of lysed transformed colonies immobilized on filters (Little et al. 1989; Traver et al. 1989). Today, transformants are generally picked, either manually or by robot, and assembled into ordered arrays in the wells of microtiter dishes. Copies of the arrayed library may be stored at  $-70^{\circ}\text{C}$ , replicated at high density to membranes as needed, and screened by hybridization (Brownstein et al. 1989; Anand et al. 1990; Bentley et al. 1992). Alternatively, the arrayed transformants may be organized into a hierarchy of pools that can be screened by multiple rounds of PCR. The number of individual clones decreases with every round of screening (Anand et al. 1990, 1991; Green and Olson 1990; Barillot et al. 1991; MacMurray et al. 1991). For an overall scheme for the construction of libraries in YAC vectors, please see Figure 4-13, and for special considerations of YAC libraries, please see the following section on Problems with YACs.

## PROBLEMS WITH YACS

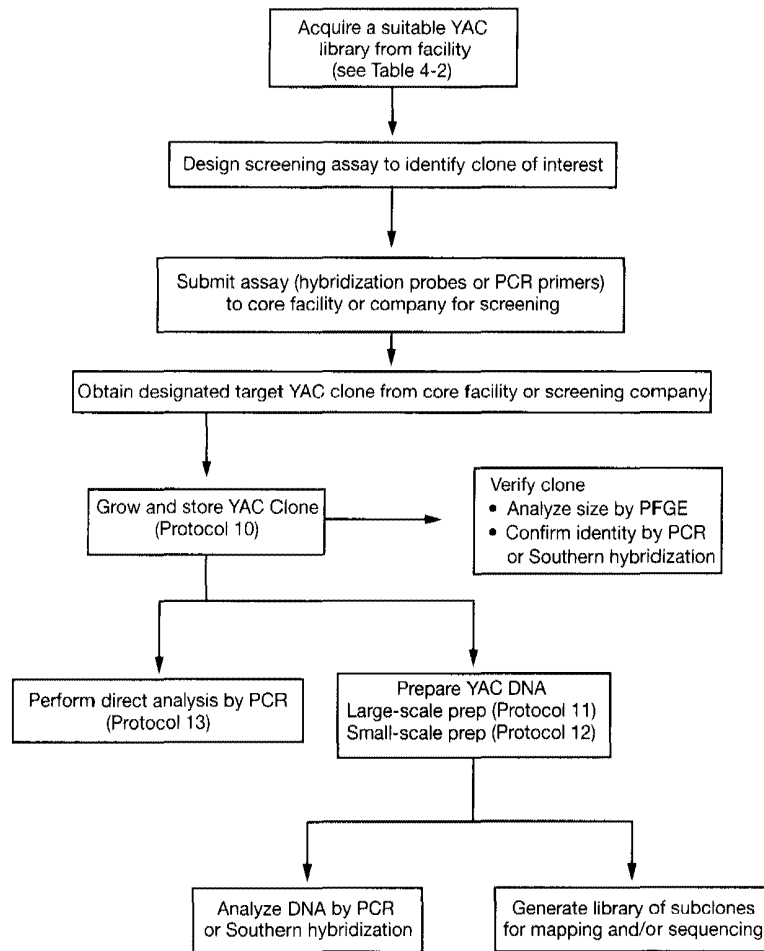
---

### Small Inserts

Many of the early YAC libraries contained inserts whose average size was only 100–200 kb, not much bigger than a P1 or PAC clone. This problem was overcome by using PFGE rather than sucrose gradient centrifugation to fractionate the genomic DNA before cloning, by devising gentle methods to prepare and manipulate large fragments of genomic DNA, and by including polyamines and/or high-molecular-weight carrier DNA in the ligation and transformation reactions. Carrier DNA, whose ends are incompatible with those of the cloning vector, increases the viscosity of the solution and thereby offers passive protection to the target DNA molecules against damage by shearing.

### Instability and Rearrangement of Cloned Genomic Sequences

Instability usually results in the appearance of submolar bands of DNA of lower molecular weight when YACs from individual clones are analyzed by PFGE. These deletions, which range in size from a few kilobases to  $>250$  kb, are generated both during the transformation process and dur-



**FIGURE 4-13** Flowchart: Screening YAC Libraries

ing subsequent mitotic growth of transformants (Kouprina et al. 1994). One cause of the instability is recombination between repetitive sequences in the cloned DNA, which can be suppressed to some extent by transforming a strain of yeast that is recombination-deficient (Vilageliu and Tyler-Smith 1992; Ling et al. 1993).

## Chimerism

Chimeric YACs are artifacts in which DNA fragments from distant regions of the target genome become joined together and propagated in a single YAC. Chimeras can be generated either during *in vitro* ligation of genomic DNA to YAC arms or, more rarely, by mitotic recombination between different YAC clones introduced into the same yeast spheroplast by cotransformation (Heale et al. 1994). Depending on the methods used to construct YAC libraries, between 10% and 60% of clones may be chimeric.

## Purification of YACs

A major problem is that YAC clones are carried at low copy number and cannot easily be separated from authentic yeast chromosomes. Purification of intact YAC clones can be achieved only by PFGE. Alternatively, the cloned segment of genomic DNA can be recovered in fragmented form by subcloning the total DNA extracted from an individual yeast transformant into cosmid

or bacteriophage vectors. Subclones carrying genomic sequences are then identified, for example, by hybridization to probes containing highly repetitive segments of mammalian DNA (please see Subcloning Genomic DNA Sequences Cloned in YACs, page 4.64).

### **MAPPING GENOMIC INSERTS CLONED IN INDIVIDUAL YACs**

---

In most cases, screening a YAC genomic library will yield several positive clones carrying overlapping inserts that span the region corresponding to the probe. These clones should be checked for chimerism, and their sizes should be measured by PFGE. Groups of YACs can sometimes be aligned by their content of polymorphic markers, by their content of recognition sites for rare restriction enzymes, or, more frequently, by DNA fingerprinting. The latter is best carried out by digesting the total DNA (yeast plus YAC) isolated from each of the positive clones with several restriction enzymes. The products of the digestion are analyzed by Southern hybridization using repetitive DNA as a probe (e.g., *Alu* DNA in the case of YACs containing human sequences, and LINE DNA in the case of mouse).

Clones to be analyzed in detail should be mapped with additional restriction enzymes. This can be done by partial digestion and Southern hybridization using probes specific to the pBR322 sequences in the left and right arms of the YAC vector. Most restriction sites can be mapped from both ends of the YAC, enabling sites to be located with accuracy (Schlessinger 1990). Because yeast DNA is unmethylated, the restriction map of the YAC will not necessarily correspond to that of the homologous region of genomic DNA.

### **RESCUING THE TERMINI OF GENOMIC DNAs CLONED IN YACs**

---

Several well-validated techniques exist to identify and subclone the ends of genomic sequences cloned in YACs. All of these techniques take advantage of the YAC vector sequences that lie immediately proximal to the cloned DNA. For example, the left arm of pYAC4 and its derivatives contain the pBR322 origin of replication and a selectable marker. The genomic sequences immediately adjacent to the left arm can therefore be recovered by end-rescue subcloning (Burke et al. 1987; Garza et al. 1989; McCormick et al. 1989). Alternatively, libraries of subclones can be screened by hybridization using probes specific for the plasmid sequences carried in the right and left ends of the vector (Bellane-Chantelot et al. 1991).

Among the PCR-based methods that can be used to amplify and clone genomic sequences adjacent to the left and right arms are inverse PCR, which uses vector sequences in outward orientation as primers (Ochman et al. 1988; Triglia et al. 1988; Silverman et al. 1989), and vectorette or bubble PCR, which uses an oligonucleotide cassette as a primer (Riley et al. 1990, 1992). Vectorette PCR is the better method since it not only amplifies insert sequences immediately proximal to each arm, but also provides templates for DNA sequencing (Anand 1992). Vectorette PCR is described in greater detail in Protocol 14.

### **RETROFITTING YACs**

---

An advantage of YACs over other genomic vectors is the ability to accommodate the complete sequences of large mammalian genes. This has led to the growing use of YACs as vehicles to transfect mammalian cells (for reviews, please see Gnirke and Huxley 1991; Huxley 1994) and to generate transgenic animals, in which for some, the YACs complement mutations in mouse chromosomal genes (for reviews, please see Capecchi 1993; Forget 1993; Montoliu et al. 1993, 1994; Peterson 1997).

The efficient introduction of YACs into mammalian cells in tissue culture requires the presence of a dominant selectable marker in the YAC vector that can be used to select rare trans-

formed cells. Many of the older YAC vectors do not carry a suitable selectable marker. However, recombinant YACs carrying the gene of interest can be retrofitted with a selectable marker such as neomycin resistance by homologous recombination in yeast cells. Similarly, homologous recombination can be used to introduce specific mutations at defined sites in segments of genomic DNA cloned in YACs (for review, please see Huxley 1994; Monaco and Larin 1994).

The methods used for transfer of YACs into cultured mammalian cells include fusion with yeast spheroplasts, calcium phosphate precipitation, electroporation, lipofection, and microinjection of total yeast DNA or YAC DNA, purified by PFGE (for review, please see Huxley 1994; Montoliu et al. 1994).

## SUBCLONING GENOMIC DNA SEQUENCES CLONED IN YACs

---

The genome of wild-type haploid *S. cerevisiae* consists of 12,057,495 bp of DNA packaged into 16 chromosomes (please see <http://genome-www.stanford.edu/Saccharomyces/>). The presence of an extra chromosome in the form of a YAC increases the size of the genome by 1–2 Mb or less. A bacteriophage  $\lambda$  library of just 2500 clones with inserts of ~20 kb will therefore provide a theoretical fourfold coverage of the genome of the host yeast and its artificial chromosome. Between 1% and 10% of the clones will contain foreign DNA sequences. These can be recognized by their ability to hybridize to mammalian probes containing highly repetitive DNA sequences. Cloning of yeast plus YAC DNA into cosmid or bacteriophage  $\lambda$  vectors is generally used to isolate a region of the YAC DNA containing a desired DNA element (promoter, exon, etc.) or to provide templates for the construction of high-resolution restriction maps.

An entirely different strategy is required when YACs are subcloned into plasmid or bacteriophage M13 vectors for DNA sequencing. In this case, the aim is to produce YAC DNA that is free of contaminating yeast sequences. The YAC DNA must therefore be purified by PFGE and then sheared into fragments of suitable size either by sonication or by nebulization. The termini of the sheared DNA molecules are repaired, and the fragments are fractionated according to size and ligated into the desired vector. The proportion of clones containing yeast sequences is greatly reduced if the YAC DNA is subjected to two cycles of purification by PFGE.

A major difficulty is to obtain sufficient, purified YAC DNA to generate libraries with reasonable depth of coverage. However, efficient methods have been described to construct in bacteriophage M13 and plasmid vectors one- to fivefold deep libraries of segments of gel-purified YAC DNA (Chen et al. 1993; Vaudin et al. 1995). Overlapping sequences obtained from single sequencing reactions of subclones chosen at random from these libraries can be used to construct small contigs, which then can be confirmed and extended by further rounds of directed sequencing.

## WHEN A NEW YAC APPEARS IN THE LABORATORY

---

The following protocol describes how to make an initial analysis and how to store newly received YAC clones. YAC clones are usually shipped by screening companies as slant cultures of *S. cerevisiae* harboring the YAC of interest. Most YAC libraries are constructed in pYAC4 or a YAC vector derived from it. Because these vectors confer prototrophy to tryptophan and uracil, they are propagated in a yeast strain that is auxotrophic for these markers. The cultures of *S. cerevisiae* should therefore be plated on agar media lacking uracil and tryptophan (please see the panel on **YEAST MEDIA**). Cultures should be dealt with immediately upon arrival.

Subsequent protocols in this chapter describe the growth of *S. cerevisiae* and preparation of DNA (Protocol 11), preparation of DNA from small-scale cultures (Protocol 12), and direct analysis of yeast colonies by PCR (Protocol 13).

**YEAST MEDIA**

This protocol recommends the use of rich YPD medium to propagate YAC-bearing yeast strains before isolation of genomic DNA. Because YPD contains uracil and tryptophan, there is no selection for retention of the YAC. However, provided the culture is grown for a short period of time (overnight) and that the yeast strain grows well, there is little danger of selecting variants that have lost their YAC. However, when working with a strain that grows slowly, either because of the particular YAC carried or because of the genotype of the host, it is a good idea to grow the yeast in uracil tryptophan drop-out medium (also known as  $\bar{\text{Ura}} \bar{\text{Trp}}$  drop-out medium, referring to minimal medium lacking uracil and tryptophan) or acid-hydrolyzed casein (AHC) medium to apply selection for the retention of YAC DNA.

Some strains of yeast harboring YAC clones grow better in AHC medium (Burke and Olson 1991). This is a complete medium containing adenine, which inhibits the reversion of *ade* mutants. Adenine is added at either a low concentration (20 mg/liter) or a high concentration (100 mg/liter) depending on the experiment. Low concentrations are used in the initial construction of YAC libraries to select for insert-containing YAC vectors. High concentrations of adenine are used when a YAC strain is to be grown for DNA isolation.

**MATERIALS****Buffers and Solutions**

Please see Appendix 1 for components of stock solutions, buffers, and reagents. Dilute stock solutions to the appropriate concentrations.

*Glycerol (30% v/v) in YPD medium*

**Gels**

*Equipment for pulsed-field gel electrophoresis*

Please see the panel on **PULSED-FIELD GEL ELECTROPHORESIS** in Protocol 1.

**Media**

*Selective medium*

Please see the panel on **YEAST MEDIA**.

*YPD agar plates*

*YPD medium*

**Special Equipment**

*Vials (2 ml)*

**Additional Reagents**

*Step 3 of this protocol requires reagents listed in Chapter 6, Protocol 7.*

*Step 4 of this protocol requires reagents listed in Chapter 5, Protocol 17 or 18.*

*Step 5 of this protocol requires either reagents listed in Chapter 6, Protocol 10, or reagents listed in Chapter 8, Protocol 12.*

**Vectors and Yeast Strains**

*S. cerevisiae carrying recombinant YAC clone*

These are most often obtained from a screening company. Please see Appendix 3.

**METHOD**

---

1. Immediately upon the arrival of clones in the laboratory, streak the cultures onto selective media and incubate for 48 hours at 30°C to obtain single colonies.  
Yeast colonies may be analyzed directly by PCR (please see Protocol 13).
2. Transfer each of 6–12 individual colonies into 10 ml of YPD medium. Incubate the cultures with vigorous agitation (300 cycles/minute) at 30°C overnight. The cells should reach saturation ( $OD_{600} = 2.0\text{--}3.0$ ,  $\sim 3 \times 10^7$  cells/ml) during this time.
3. Extract yeast DNA from 9 ml of each of the cultures following the steps described in Chapter 6, Protocol 7.  
Store the unused portions of the cultures at 4°C.
4. Analyze the size of the YAC in each of the DNA preparations by PFGE.
5. Confirm by either Southern hybridization (please see Chapter 6, Protocol 10) or PCR (please see Chapter 8, Protocol 12) that the target sequence is present in the YAC DNA.
6. If the results are satisfactory, i.e., if the cultures contain YACs of the same size, if there is no sign of instability or rearrangement, and if the target sequences are present, then choose one or two of the cultures for long-term storage (please see the panel on **STORAGE OF YEAST CULTURES**).

**STORAGE OF YEAST CULTURES**

Yeast cultures can be stored indefinitely at  $-70^\circ\text{C}$  in growth medium containing 15% (v/v) glycerol (Well and Stewart 1973). For storage:

1. Prepare 2-ml vials containing 0.5 ml of sterile 30% (v/v) glycerol in YPD medium.
2. Add 0.5 ml of the yeast culture and mix the contents of the tube by gentle vortexing.
3. Transfer the vials to  $-70^\circ\text{C}$ .

Yeast can be recovered from storage by transferring a small frozen sample to a YPD agar plate.

▲ **WARNING** Yeast cultures lose viability if stored at temperatures higher than  $-55^\circ\text{C}$ .

# Protocol 11

---

## Growth of *S. cerevisiae* and Preparation of DNA

**T**HE FOLLOWING PROTOCOL DESCRIBES METHODS FOR ISOLATION of total DNA from a strain of *S. cerevisiae* carrying a recombinant YAC. This method is appropriate for preparing DNA that will be subjected to regular agarose gel electrophoresis, Southern blotting, subcloning, genomic library construction, PCR, or other methods that do not require intact high-molecular-weight DNA. If the DNA is used in PFGE, follow the preparation method given in Chapter 5, Protocol 14. The small-scale preparation of YAC DNA is presented in Protocol 12 of this chapter. Because the linear YAC DNAs are sensitive to shearing forces, pipettes with wide-bore tips should be used to transfer DNAs. Drop dialysis should be used to exchange buffers. The expected yield from a 10-ml culture is 2–4 µg of yeast DNA.

### MATERIALS

---

**CAUTION:** Please see Appendix 12 for appropriate handling of materials marked with <!.>.

#### Buffers and Solutions

Please see Appendix 1 for components of stock solutions, buffers, and reagents. Dilute stock solutions to the appropriate concentrations.

*Ammonium acetate (10 M)*

*Ethanol*

*Phenol:chloroform (1:1, v/v) <!.>*

*TE (pH 8.0)*

*TE (pH 8.0) containing 20 µg/ml RNase*

*Triton/SDS solution*

#### Media

*YPD medium*

Please see the panel on **YEAST MEDIA** in Protocol 10.

#### Centrifuges and Rotors

*Sorvall SS-34 rotor or equivalent*



## Special Equipment

### *Glass beads*

Acid-washed glass beads should be used (e.g., Sigma). Unwashed beads are *not* recommended.

## Vectors and Yeast Strains

*Yeast colony carrying the YAC clone of interest*

## METHOD

---

### Growth of Cells

1. Inoculate a yeast colony containing the YAC clone of interest into 10 ml of YPD medium and incubate overnight with shaking at 30°C.  
The cells should reach saturation ( $OD_{600} = 2.0-3.0$ ,  $\sim 3 \times 10^7$  cells/ml) during this time.  
If the DNA to be extracted will be used in PFGE, follow the steps described in Chapter 5, Protocol 14.
2. Collect the cells by centrifugation at 2000g (4100 rpm in a Sorvall SS-34 rotor) for 5 minutes.
3. Remove the medium, replace with 1 ml of sterile H<sub>2</sub>O, and resuspend the cells by gentle vortexing.
4. Collect the cells by centrifugation as in Step 2.
5. Remove the wash, resuspend cells in 0.5 ml of sterile H<sub>2</sub>O, and transfer to a sterile 1.5-ml microfuge tube.
6. Collect the cells by centrifugation at maximum speed for 5 seconds at room temperature in a microfuge, and remove the supernatant.

### Extraction of DNA

7. Add 0.2 ml of Triton/SDS solution to the cells and resuspend the cell pellet by tapping the side of the tube.
8. Add 0.2 ml of phenol:chloroform and 0.3 g of glass beads to the cells, and vortex the cell suspension for 2 minutes at room temperature. Add 0.2 ml of TE (pH 8.0), and mix the solution by vortexing briefly.
9. Separate the organic and aqueous phases by centrifugation at maximum speed for 5 minutes at room temperature in a microfuge. Transfer the aqueous upper layer to a fresh microfuge tube, taking care to avoid carrying over any of the material at the interface.

### Isolation of DNA

10. Add 1 ml of ethanol to the aqueous solution, cap the centrifuge tube, and gently mix the contents by inversion.

11. Collect the precipitated DNA by centrifugation at maximum speed for 2–5 minutes at 4°C in a microfuge. Remove the supernatant with a drawn out Pasteur pipette. Centrifuge the tube briefly (2 seconds) and remove the last traces of ethanol from the bottom of the tube.
12. Resuspend the nucleic acid pellet in 0.4 ml of TE (pH 8.0) with RNase and incubate the solution for 5 minutes at 37°C.
13. Add to the solution an equal volume of phenol:chloroform and extract the RNase-digested solution, mixing by inversion rather than vortexing. Separate the aqueous and organic phases by centrifugation at maximum speed for 5 minutes at room temperature in a microfuge and transfer the aqueous layer to a fresh microfuge tube.
14. Add 80 µl of 10 M ammonium acetate and 1 ml of ethanol to the aqueous layer. Mix the solution by gently inversion and store the tube for 5 minutes at room temperature.
15. Collect the precipitated DNA by centrifugation for 5 minutes in a microfuge. Decant the supernatant and rinse the nucleic acid pellet with 0.5 ml of 70% ethanol. Centrifuge at maximum speed for 2 minutes and remove the ethanol rinse with a drawn out Pasteur pipette. Centrifuge the tube briefly (2 seconds) and remove the last traces of ethanol from the bottom of the tube. Allow the pellet of DNA to dry in the air for 5 minutes and then dissolve the pellet in 50 µl of TE (pH 8.0).

The preparation should contain 2–4 µg of yeast DNA.

At this stage, the DNA can be analyzed by PCR and Southern hybridization and may be used to generate libraries of subclones for DNA sequencing or other purposes.

# Protocol 12

---

## Small-scale Preparations of Yeast DNA

**Y**EAST DNA IS PREPARED BY DIGESTION OF THE CELL WALL and lysis of the resulting spheroplasts with SDS. This method reproducibly yields several micrograms of yeast DNA that can be efficiently cleaved by restriction enzymes and used as a template in PCR. Note that the following protocol (Protocol 13) describes a method for analyzing yeast colonies directly by PCR, without purifying yeast DNA. An alternative method for preparing yeast DNA is given in Chapter 6, Protocol 7.

### MATERIALS

---

#### Buffers and Solutions

Please see **Appendix 1** for components of stock solutions, buffers, and reagents. Dilute stock solutions to the appropriate concentrations.

*Isopropanol*

*Potassium acetate (5 M)*

*SDS (10% w/v)*

*Sodium acetate (3 M, pH 7.0)*

*Sorbitol buffer*

*TE (pH 7.4)*

*TE (pH 8.0) containing 20 µg/ml RNase*

*Yeast resuspension buffer*

#### Enzymes and Buffers

*Zymolyase 100T*

#### Media

*YPD medium*

Please see the panel on **YEAST MEDIA** in Protocol 10.

#### Centrifuges and Rotors

*Sorvall SS-34 rotor or equivalent*

#### Special Equipment

*Water bath preset to 65°C*

#### Vectors and Yeast Strains

*Yeast cells*

## METHOD

---

### Growth of Cells and Extraction of DNA

1. Set up 10-ml cultures of yeast in YPD medium. Incubate the cultures overnight at 30°C with moderate agitation.
2. Transfer 5 ml of the cells to a centrifuge tube. Collect the cells by centrifugation at 2000g (4100 rpm in a Sorvall SS-34 rotor) for 5 minutes. Store the unused portion of the culture at 4°C.
3. Resuspend the cells in 0.5 ml of sorbitol buffer. Transfer the suspension to a microfuge tube.
4. Add 20 µl of a solution of Zymolyase 100T (2.5 mg/ml in sorbitol buffer), and incubate the cell suspension for 1 hour at 37°C.
5. Collect the cells by centrifugation in a microfuge for 1 minute. Remove the supernatant by aspiration.
6. Resuspend the cells in 0.5 ml of yeast resuspension buffer.
7. Add 50 µl of 10% SDS. Close the top of the tube and mix the contents by rapidly inverting the tube several times. Incubate the tube for 30 minutes at 65°C.
8. Add 0.2 ml of 5 M potassium acetate and store the tube for 1 hour on ice.

### Isolation of DNA

9. Pellet the cell debris by centrifugation at maximum speed for 5 minutes at 4°C in a microfuge.
10. Use a wide-bore pipette tip to transfer the supernatant to a fresh microfuge tube at room temperature.
11. Precipitate the nucleic acids by adding an equal volume of room-temperature isopropanol. Mix the contents of the tube and store it for 5 minutes at room temperature.  
**▲IMPORTANT** Do not allow the precipitation reaction to proceed for >5 minutes.
12. Recover the precipitated nucleic acids by centrifugation at maximum speed for 10 *seconds* in a microfuge. Remove the supernatant by aspiration and allow the pellet to dry in the air for 10 minutes.
13. Dissolve the pellet in 300 µl of TE (pH 8.0) containing 20 µg/ml pancreatic RNase. Incubate the digestion mixture for 30 minutes at 37°C.
14. Add 30 µl of 3 M sodium acetate (pH 7.0). Mix the solution and then add 0.2 ml of isopropanol. Mix once again and recover the precipitated DNA by centrifugation at maximum speed for 20 seconds in a microfuge.
15. Remove the supernatant by aspiration and allow the pellet to dry in the air for 10 minutes. Dissolve the DNA in 150 µl of TE (pH 7.4).

# Protocol 13

---

## Analyzing Yeast Colonies by PCR

**T**HERE IS NO NEED TO PURIFY DNA FROM YEAST FOR ANALYSIS in PCR. The following protocol, which uses crude lysates of individual yeast colonies as templates for amplification, is used to ascertain whether DNA sequences of interest are present in YACs. The method can also be used to check whether genetic manipulations in yeast, e.g., gene disruptions, have been successful. For additional details on performing PCR, please see Chapter 8, Protocol 1.

- As in all PCR amplifications, it is essential to include appropriate negative controls, e.g., reactions to which no yeast material is added and reactions containing wild-type yeast that does not carry a YAC.
- Positive controls include yeast strains already carrying the DNA sequence targeted for amplification and/or reconstruction reactions containing wild-type yeast colonies and 10–100 pg of plasmid DNA containing the target DNA sequence.

### MATERIALS

---

**CAUTION:** Please see Appendix 12 for appropriate handling of materials marked with <!>.

#### Buffers and Solutions

Please see Appendix 1 for components of stock solutions, buffers, and reagents. Dilute stock solutions to the appropriate concentrations.

*10x Colony PCR buffer*

0.125 M Tris-Cl (pH 8.5)

0.56 M KCl

*dNTP solution (10 mM) containing all four dNTPs (pH 8.0; PCR grade)*

*MgCl<sub>2</sub> (25 mM)*

#### Enzymes and Buffers

*Taq DNA polymerase*

Please see the information panel on **TAQ DNA POLYMERASE** in Chapter 8.

#### Gels

*Agarose or Polyacrylamide gel <!>*

Please see Step 4.

## Nucleic Acids and Oligonucleotides

### Oligonucleotide primers

The oligonucleotides should be 20–24 nucleotides in length, specific for the target DNA sequences, free of potential secondary structures, and contain no less than 10 and no more than 15 G and C residues. For advice on the design of oligonucleotide primers used in PCR, please see the introduction to Chapter 8.

### Marker DNA

## Special Equipment

### Microfuge tubes (0.5 ml)

Use thin-walled amplification tubes designed for use in a thermal cycler.

### Thermal cycler programmed with desired amplification protocol

If the thermal cycler is not equipped with a heated lid, use either mineral oil or paraffin wax to prevent evaporation of liquid from the reaction mixture during PCR.

## Vectors and Yeast Strains

### Yeast strain carrying recombinant YAC of interest

## METHOD

1. In a sterile 0.5-ml microfuge tube, mix in the following order:

10x colony PCR buffer	2 $\mu$ l
25 mM MgCl <sub>2</sub>	1.2 $\mu$ l
10 mM dNTPs	0.4 $\mu$ l
oligonucleotide primers	10 pmoles of each primer
<i>Taq</i> polymerase	5 units (0.2 $\mu$ l)
H <sub>2</sub> O	to 20 $\mu$ l

2. Use a disposable yellow pipette tip to transfer a small amount of a yeast colony (0.10–0.25  $\mu$ l) to the reaction mixture.

It is important not to be too greedy when sampling the yeast colony because cell wall components inhibit the PCR.

3. Transfer the PCR tube to the thermocycler, programmed as follows, and start the program.

Cycle Number	Denaturation	Annealing	Polymerization
1	4 min at 95°C		
2–35	1 min at 95°C	1 min at 55°C	1 min at 72°C
Last			10 min at 72°C

These times are suitable for 50- $\mu$ l reactions assembled in thin-walled 0.5-ml tubes and incubated in thermal cyclers such as the Perkin-Elmer 9600 or 9700, Master cycler (Eppendorf), and PTC 100 (MJ Research). Times and temperatures may need to be adapted to suit other types of equipment and reaction volumes.

4. Analyze the products of the PCR by electrophoresis through an agarose or polyacrylamide gel, using markers of suitable size.

If amplification of the target sequence is weak or erratic, repeat the reactions using a polymerization temperature 2–3°C below the calculated melting temperature of the oligonucleotide primer that is richer in A+T. (For methods to calculate melting temperatures of oligonucleotide duplexes, please see the information panel on **MELTING TEMPERATURES** in Chapter 10.) If the results are still unsatisfactory, convert the yeast cells to spheroplasts by removing the cell walls with Zymolyase 100T before beginning the protocol. This takes only 1 hour and almost always clears up any problems. Alternatively, grow 10-ml liquid (YPD) cultures of the colonies under test and make small-scale preparations of yeast DNA (please see Protocol 12).

# Protocol 14

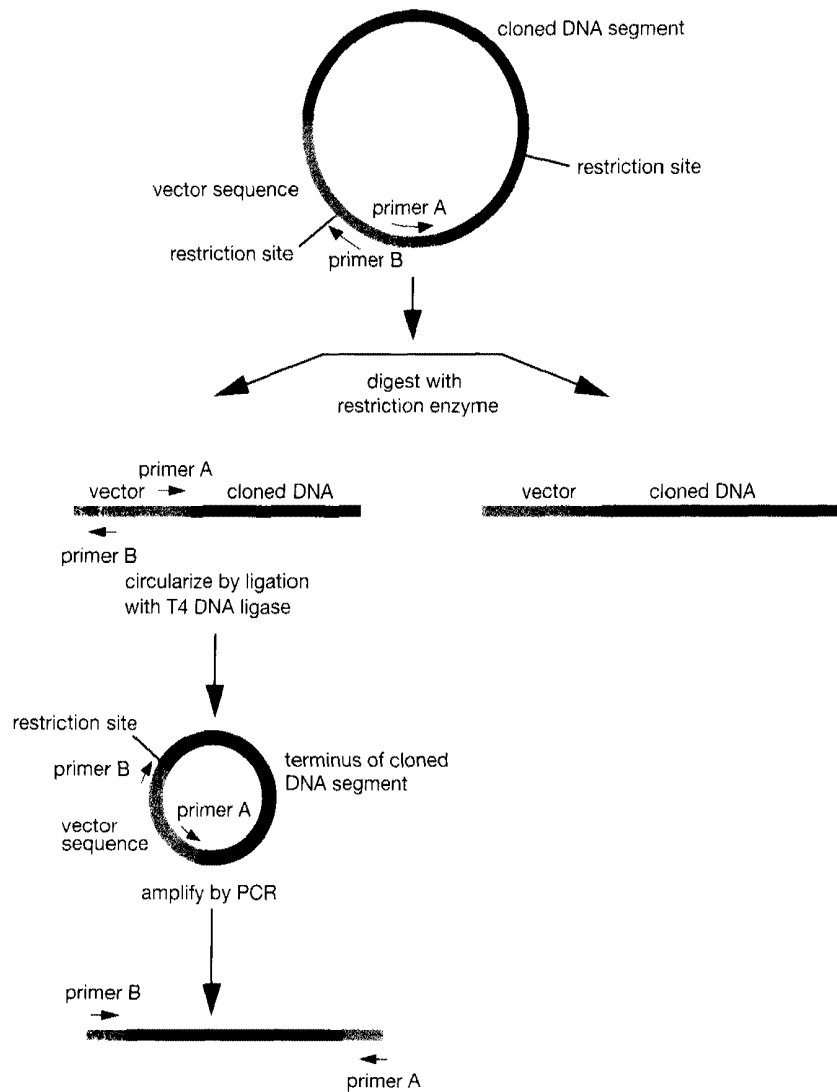
---

## Isolating the Ends of Genomic DNA Fragments Cloned in High-capacity Vectors: Vectorette Polymerase Chain Reactions

**M**ANY EUKARYOTIC GENES, AND CERTAINLY MOST CHROMOSOMES, encompass more DNA than can be accommodated within a single recombinant. For this reason, it is often necessary to establish an overlapping set of cloned DNAs that can be ordered into a contiguous sequence (contig) spanning a large gene or region of interest. A convenient method for identifying members of a contig is to screen genomic libraries by hybridization or PCR, using probes or primers derived from the extreme 5' and 3' ends of an initial isolate. These probes identify sets of recombinants that overlap with the termini of the original isolate and extend in both directions along the chromosome. The process of end-recovery and screening is repeated until the entire region of interest has been captured.

Extension of clones into contigs requires genomic libraries that are deep in coverage and free from large gaps. However, the success of the method also depends on the efficient characterization of the 5' and 3' termini of large, nonchimeric, genomic clones whose DNA sequence is unknown. A number of techniques have been devised to facilitate this process and to obviate the need to clone the junctions between vector and cloned DNAs:

- ***In vitro* transcription.** Many bacteriophage  $\lambda$  and cosmid vectors, and some BAC vectors, contain promoters for bacteriophage DNA-dependent RNA polymerases adjacent to their cloning sites. These can be used to transcribe the terminal sequences of the cloned genomic fragment, as described in Chapter 9, Protocol 6. The RNA can be used directly as hybridization probes or sequenced and used to generate oligonucleotide primers.
- ***Inverse PCR.*** To prepare the DNA for inverse PCR, the initial clone is digested with a restriction enzyme that cleaves at a specific site within the vector DNA and at one or more sites within the cloned DNA sequence, and the resulting fragments are circularized. Sequences located at the terminus of the cloned segment thereby become flanked by vector DNA whose sequence is known. Amplification is carried out using two oligonucleotide primers that anneal to the vector and point away from each other (please see Figure 4-14). Inverse PCR (Ochman et al. 1988; Triglia et al. 1988), when working at its best, has sufficient sensitivity and specificity to, for example, amplify the termini of YAC clones in preparations of total yeast genomic DNA (Silverman et al. 1989; Arveiler and Porteous 1991). However, success with inverse PCR is not easily achieved: The critical circularization step is difficult to control and the circular DNA templates must be of a size that can be amplified efficiently.



**FIGURE 4-14 Inverse PCR**

The strategy for inverse PCR is described in the accompanying text.

- **PCR using repetitive or random primers.** A variety of methods have been devised that use one vector-specific primer and a second primer that is either specific for highly repetitive elements such as *Alu* or LINE (long interspersed nuclear element) sequences (Nelson et al. 1989) or of random sequence (Wesley et al. 1994). Success in both cases depends on the serendipitous occurrence of repetitive elements or priming sequences in the correct orientation within 1–2 kb of the appropriate terminus of the cloned genomic fragment.
- **TAIL PCR.** Thermal asymmetric interlaced (TAIL) PCR may be used to amplify the insert ends from YAC or P1 clones (Liu and Whittier 1995) or, with some modification, to recover and amplify genomic sequences flanking T-DNA and transposon insertions (Liu et al. 1995). The strategy for TAIL PCR relies upon the use of nested, sequence-specific primers (derived from the cloning vector or insertion element) in conjunction with a short arbitrary degenerate primer of low melting temperature. Alternating cycles of high and low stringency during the reaction allow the preferential amplification of the target sequences.



- **PCR using synthetic oligonucleotide cassettes.** In these techniques, cloned DNA sequences are amplified using one primer complementary to sequences in the vector and a second primer that recognizes an oligonucleotide cassette ligated to a nearby restriction site in the foreign DNA (for review, please see Rosenthal 1992). The best of these techniques are vectorette PCR (Riley et al. 1990; Allen et al. 1994) and single-site PCR (MacGregor and Overbeek 1991), which are described in the following protocol.

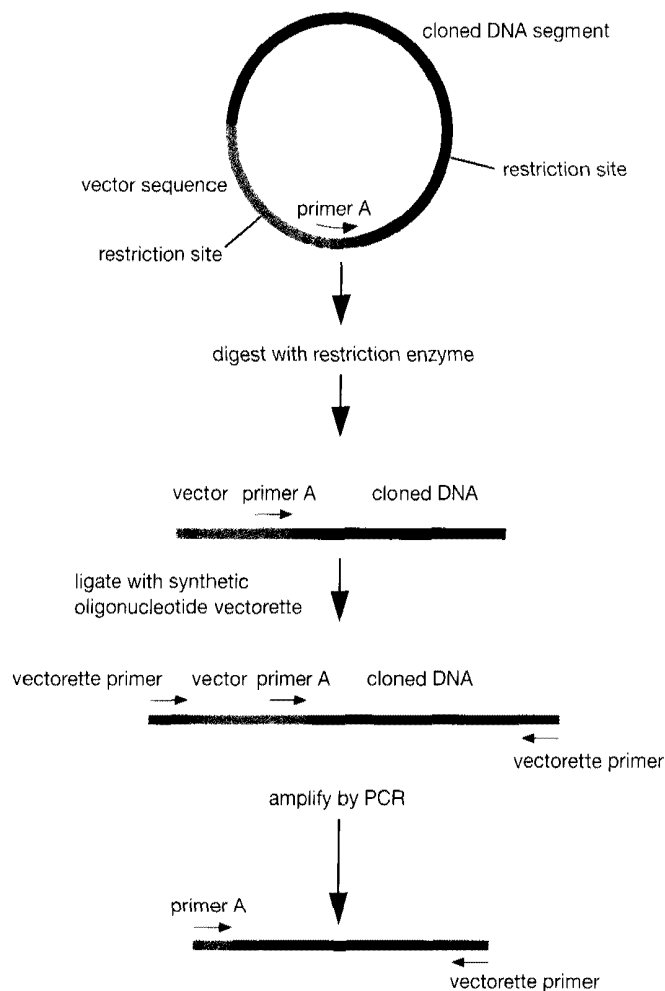
In both vectorette PCR (Figure 4-15) and single-site PCR (Figure 4-16), the DNA to be amplified is first digested with a restriction enzyme that cleaves within the cloned DNA. The restriction enzyme must not cleave between the priming site on the vector and the cloned sequences, and it should produce a junction fragment of a suitable size for amplification (typically 200–2000 bp). In pYAC4, suitable enzymes that do not cleave between the vector-specific priming site and the cloning site are *RsaI*, *PvuII*, and *StuI*. However, because the detailed distribution of restriction sites in the cloned DNA is usually unknown, it may be best to test several enzymes to find one that generates a target fragment whose size is optimal for PCR. After digestion, a synthetic oligonucleotide cassette is ligated to the ends of the cleaved DNA, and purified products of ligation are amplified using a vector-specific primer and a primer that is complementary to one strand of the attached cassette.

Vectorette and single-site PCRs differ in the design of the cassettes that are attached to the digested DNA. In single-site PCR, a single-stranded oligonucleotide is ligated to the ends of the fragments of cleaved DNA. Amplification is primed by a locus-specific oligonucleotide that binds specifically to the flanking vector sequences and a second oligonucleotide that has the same sequence as the synthetic single-stranded termini (Figure 4-16). Extension from the locus-specific oligonucleotide in the first cycle of PCR provides a complementary sequence to which the second primer can bind (for review, please see Rosenthal 1992).

Vectorettes can be amplified only if they are attached to the DNA of interest, in this case, the junction fragment between the vector and the cloned DNA. The vectorette is only partially double-stranded and contains a central mismatched region (Riley et al. 1990; Allen et al. 1994). The priming oligonucleotide has the same sequence as one of the strands in the mismatched region and therefore has no complementary sequence until the first cycle of PCR is completed. This cycle is primed by the oligonucleotide that binds specifically to the flanking vector sequences (Figure 4-15). Thus, although vectorettes can ligate to themselves and to all fragments of DNA with compatible termini, only DNA containing both the flanking vector sequences and the vectorette can be amplified. For reviews of vectorettes, please see Arnold and Hodgson (1991), Hengen (1995), McAleer et al. (1996), and Ogilvie and James (1996).

Theoretically, in both vectorette PCR and single-site PCR, only the end fragment from the starting clone will amplify. However, in practice, there is often more than one product due to priming on imperfectly matched templates. In addition, illegitimate products may arise from repair of recessed termini of vectorette and cloned DNA fragments (Tadokoro et al. 1992). After denaturation, these termini can anneal to form primer:templates that may be extended in subsequent cycles of the PCR. The synthesis of unwanted amplification products may be suppressed by the use of primers with a relatively high content of G+C (54–58%) and high annealing temperatures (65–67°C) or by the use of improved vectorettes—splinkerettes—containing hairpin structures rather than mismatches (Devon et al. 1995).

Both vectorette and single-site PCRs have been used successfully to recover the termini of genomic DNAs cloned into YACs, using total yeast DNA as a substrate for library construction (e.g., please see McAleer et al. 1996; Ogilvie and James 1996). Vectorette and single-site PCR methods are also useful for isolating DNA that lies adjacent to a cloned DNA or known DNA

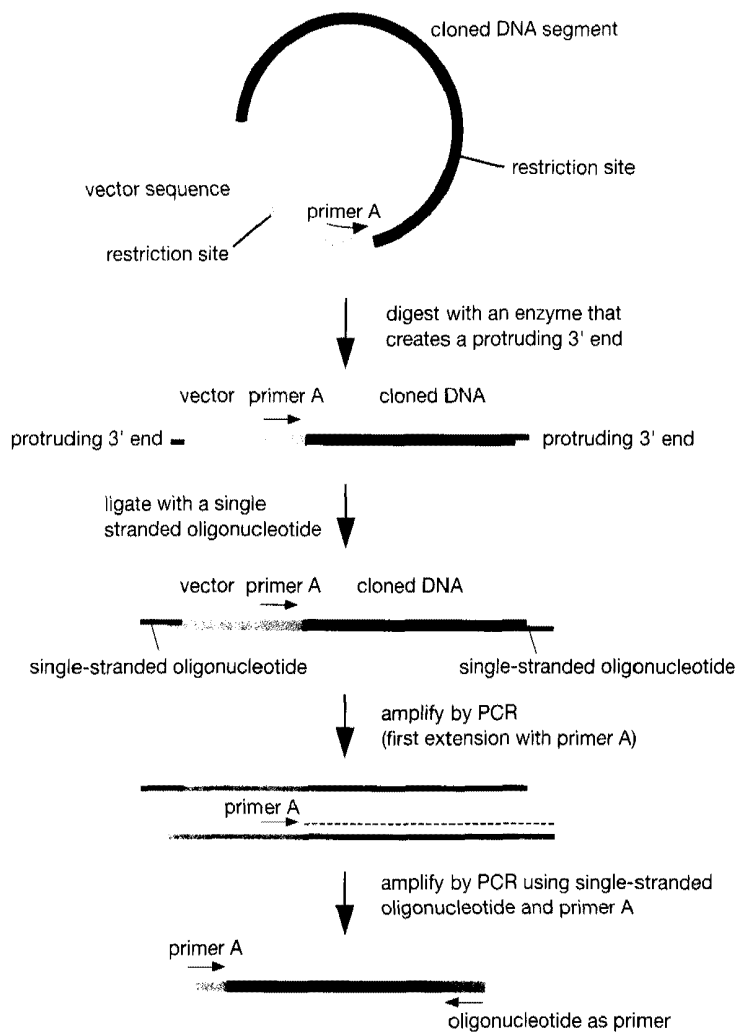


**FIGURE 4-15 Vectorette Scheme**

The strategy for identifying the ends of cloned fragments using the vectorette scheme for PCR is described in the text.

sequence. For example, sequences flanking an integrated transgene (MacGregor and Overbeek 1991; Allen et al. 1994) or a retrovirus have been isolated by these procedures. Finally, both techniques can be used to recover sequences from uncloned mammalian genomic DNA. However, success is often elusive and requires the use of size-fractionated DNA templates or nested primer pairs to provide sufficient product for cloning, sequencing, or hybridization (please see the panel on **ENHANCEMENTS OF VECTORETTE REACTIONS WHEN USING GENOMIC DNA TEMPLATES** at the end of this protocol).

No comparison of the efficiencies of the two methods has been published. However, single-site PCR is the simpler and less expensive option, requiring fewer steps and synthetic oligonucleotides. Below, we describe a protocol for single-site PCR that works well in our hands. The method may be easily adapted to vectorette PCR by changing the oligonucleotide cassette. For details of vectorettes that may be used to recover the terminal sequences of pYAC4, please see Riley et al. (1990), McAleer et al. (1996), and Ogilvie and James (1996). Vectorettes are available commercially from Genosys Biotechnology (Woodlands, Texas).



**FIGURE 4-16 Single-site Scheme**

The strategy for using single-site PCR to identify the ends of cloned fragments is described in the text.

## MATERIALS

**CAUTION:** Please see Appendix 12 for appropriate handling of materials marked with <!.>.

### Buffers and Solutions

Please see Appendix 1 for components of stock solutions, buffers, and reagents. Dilute stock solutions to the appropriate concentrations.

10x Amplification buffer

dNTP solution (1 mM) containing all four dNTPs (pH 8.0; PCR grade)

Ethanol

Phenol:chloroform (1:1, v/v) <!.>

Sodium acetate (3 M, pH 5.2)

10x T4 DNA ligase buffer

### Enzymes and Buffers

Bacteriophage T4 DNA ligase

Restriction endonucleases PstI or NsiI

Thermostable DNA polymerase

## Gels

### Agarose gels

Please see Steps 1 and 8.

## Nucleic Acids and Oligonucleotides

### Oligonucleotide cassette (5.0 OD<sub>260</sub>/ml [ $\sim$ 8.5 $\mu$ M]) in TE (pH 7.6)

5' CATGCTCGGTCGGGATAGGCACTGGTCTAGAGGGTTAGGTTCTGCTACATCTCCAGCCTTGCA3'

This 64-nucleotide single-stranded cassette is designed for ligation to target DNAs carrying termini generated by *Pst*I or *Nsi*I. The four 3'-terminal nucleotides (underlined) are complementary to the protruding termini of fragments of DNA generated by cleavage with these enzymes. If another restriction enzyme is used, the nucleotides at the 3' end of the linker must be changed so as to complement the protruding terminus generated by the enzyme.

Before use, the oligonucleotide should be purified by C<sub>18</sub> chromatography or electrophoresis through a 12% polyacrylamide gel, as outlined in Chapter 10, Protocol 1. The 5' terminus of the oligonucleotide should not be phosphorylated.

### Oligonucleotide (linker) primer (5.0 OD<sub>260</sub>/ml [ $\sim$ 17 $\mu$ M]) in TE (pH 7.6)

5' CATGCTCGGTCGGGATAGGCACTGGTCTAGAG3'

This oligonucleotide is identical in sequence to the 32 nucleotides at the 5' end of the oligonucleotide cassette and is used as an amplimer in the PCR.

There is no need to purify or phosphorylate the deprotected oligonucleotide before use. Dissolve the oligonucleotide in TE (pH 7.6) at a concentration of 5.0 OD<sub>260</sub>/ml solution ( $\sim$ 17  $\mu$ M).

### Sequence-specific oligonucleotide (vector) primer (5.0 OD<sub>260</sub>/ml [ $\sim$ 17 $\mu$ M]) in TE (pH 7.6)

This primer is complementary to the vector when terminal sequences of a cloned segment of DNA are to be amplified or to cloned DNA sequences when a neighboring segment of genomic DNA is to be recovered. The primer should be 28–32 nucleotides in length and its predicted melting temperature should be approximately equal to that of the 32-nucleotide oligonucleotide primer. For sequences of primers specific for the left and right arms of pYAC4, please see McAleer et al. (1996).

There is no need to purify or phosphorylate the deprotected oligonucleotide before use. Dissolve the oligonucleotide in TE (pH 7.6) at a concentration of 5.0 OD<sub>260</sub>/ml solution ( $\sim$ 17  $\mu$ M).

### Template DNAs: recombinant BAC, YAC, or cosmid DNA

YACs can either be embedded in an agarose plug (2  $\mu$ g in 100- $\mu$ l plug) or in solution. Unless the yeast strain is carrying more than one YAC, there is no need to purify YAC DNA by PFGE before use in vectorette or single-site PCR.

DNAs should be purified by column chromatography using, e.g. Qiagen resin or GeneClean II (please see Chapter 1, Protocol 9), and resuspended at a concentration of 1  $\mu$ g/ $\mu$ l in TE (pH 7.6).

## Special Equipment

### Barrier tips for automatic pipettes

### Microfuge tubes (0.5 ml), thin-walled for amplification

### Positive displacement pipette

### Thermal cycler programmed with desired amplification protocol

If the thermal cycler is not equipped with a heated lid, use either mineral oil or paraffin wax to prevent evaporation of liquid from the reaction mixture during PCR.

### Water bath or cooling block preset to 15°C

## METHOD

1. Digest  $\sim$ 5  $\mu$ g of template DNA with *Pst*I or *Nsi*I. Check a small aliquot of the reaction by agarose gel electrophoresis to ensure that all of the DNA has been cleaved.
2. Extract the reaction mixture with phenol:chloroform, and recover the DNA by standard precipitation with ethanol and subsequent washing in 70% ethanol. Store the open tube in an inverted position on a bed of paper towels to allow the last traces of ethanol to evaporate, and then dissolve the damp pellet of DNA in 50  $\mu$ l of H<sub>2</sub>O.

3. In a sterile 0.5-ml microfuge tube, mix in the following order:

10x T4 DNA ligase buffer	10 $\mu$ l
digested template DNA	20 $\mu$ l
oligonucleotide cassette, 5.0 OD <sub>260</sub> /ml	2 $\mu$ l
T4 bacteriophage DNA ligase, 5 Weiss units/ $\mu$ l	2 $\mu$ l
H <sub>2</sub> O	to 100 $\mu$ l

Set up three control reactions as described above but without template DNA in one tube, without linker oligonucleotide in another, and without T4 DNA ligase in the third.

4. Incubate the test ligation reaction and controls for 12–16 hours at 15°C.

5. In a sterile 0.5-ml microfuge tube, mix in the following order:

10x amplification buffer	2 $\mu$ l
1 mM solution of four dNTPs (pH 7.0)	2 $\mu$ l
linker primer oligonucleotide, 5.0 OD <sub>260</sub> /ml	1 $\mu$ l
vector primer oligonucleotide, 5.0 OD <sub>260</sub> /ml	1 $\mu$ l
test DNA ligation reaction, from Step 4	1 $\mu$ l
thermostable DNA polymerase, 5.0 units/ $\mu$ l	0.5 $\mu$ l
H <sub>2</sub> O	to 20 $\mu$ l

Set up three control PCRs that contain 1  $\mu$ l of the control ligation reactions instead of the test ligation reaction.

6. If the thermocycler is not fitted with a heated lid, overlay the reaction mixtures with 1 drop (~50  $\mu$ l) of light mineral oil to prevent evaporation of the samples during repeated cycles of heating and cooling. Alternatively, place a bead of wax into the tube if using a hot-start approach.
7. Place the PCR tubes in the thermocycler, programmed as follows, and start the amplification program.

Cycle Number	Denaturation	Annealing	Polymerization
1	2 min at 95°C		
2–35	30 sec at 94°C	30 sec at 60°C	3 min at 72°C
Last			5 min at 72°C

8. Analyze aliquots (25%) of each amplification reaction on an agarose gel.

A prominent DNA product visible by ethidium bromide staining should be present in the PCR containing the products of the test ligation. This DNA should be absent from the control reactions. The size of the product depends on the distance between the vector primer and the first cleavage site in the cloned insert. For *Pst*I and *Nsi*I, the amplified product is typically between 0.5 kb and 2 kb.

PCR products spanning the junction of genomic and vector sequences should, in most cases, be cleaved within the cloning site by one or more restriction enzymes. In pYAC4, for example, the amplified DNA should contain an *Eco*RI site that divides the vector sequences from the cloned genomic sequences. Confirmation that the PCR product is correct can therefore be obtained by digestion with *Eco*RI, agarose gel electrophoresis, and Southern blotting, using an oligonucleotide primer specific to the appropriate YAC arm as probes.

The amplified DNA can be sequenced directly, cloned, radiolabeled by random hexamer priming or PCR, and even used as a transcription template if a bacteriophage promoter is added to the linker or is present in the amplified segment of vector DNA.

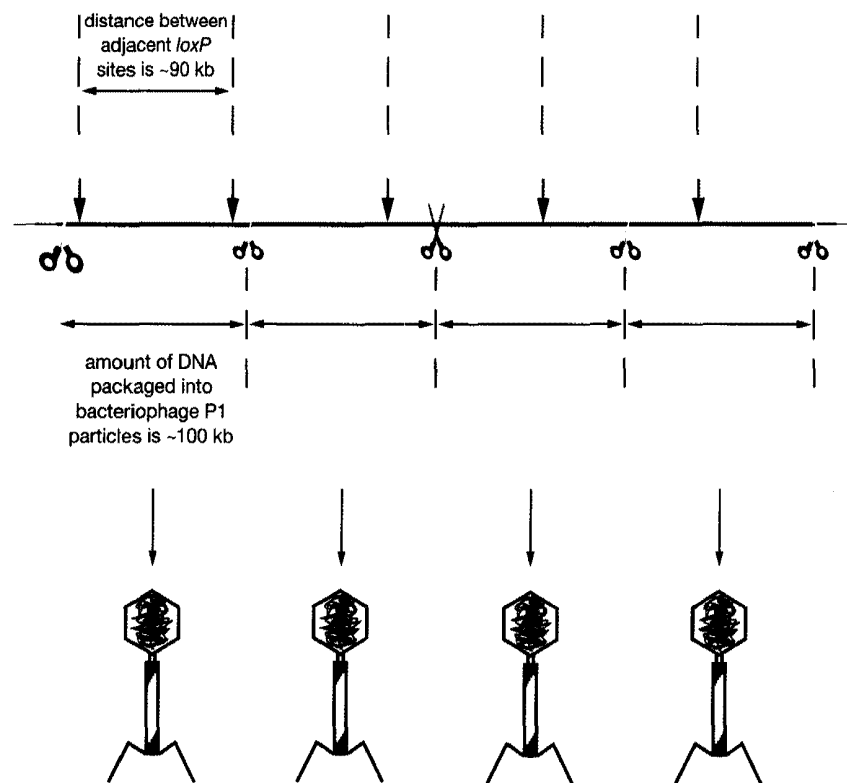
#### **ENHANCEMENTS OF VECTORETTE REACTIONS WHEN USING GENOMIC DNA TEMPLATES**

If amplification is inefficient and/or if more than one amplification product is detected, repeat the protocol using one or more of the enhancements outlined below. These are particularly useful when the concentration of target sequences is low, e.g., when using total eukaryotic DNA as a template rather than an individual clone of genomic DNA.

- In a preliminary experiment, determine the size of the desired DNA fragment by Southern hybridization using a probe derived from the neighboring, known DNA sequence. Then fractionate the digested DNA by agarose gel electrophoresis in readiness for Step 2 (please see Chapter 5, Protocol 1).
- After Step 1, heat the digested template DNA for 10 minutes at 65°C to melt any annealed complexes that may have formed.
- After Step 3, remove excess oligonucleotide cassette by spun column chromatography.
- Increase the time of the denaturation step in the first cycle of PCR to 10 minutes. This change ensures complete inactivation of the T4 DNA ligase and guarantees that all template DNAs are fully denatured. Thorough denaturation prevents end repair of recessed 3' termini and therefore suppresses unwanted PCR products (please see protocol introduction).
- Use hot-start PCR, in which the thermostable DNA polymerase is denied access to the template before complete denaturation (for details, please see Chapter 8 introduction).
- Use a nested vector primer(s) to enhance specificity and yield. This enhancement requires the synthesis of an additional vector primer, which can be used either in an additional amplification reaction or be added to the initial amplification after 5–10 cycles. Alternatively, the products of the initial PCR can be fractionated by electrophoresis through an agarose gel and analyzed by Southern hybridization, using the nested primer as a probe. A second PCR can then be performed using as templates DNAs of the appropriate size.
- The addition of Perfect Match (Stratagene) to a concentration of 0.1 units/μl of reaction mixture may sometimes help to reduce the number of nonspecific PCR products (McAleer et al. 1996).
- The use of GC-Melt (CLONTECH) may improve the efficiency of the PCR.

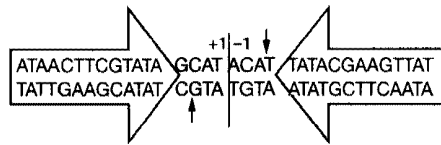
**CRE-*loxP***

The genome of bacteriophage P1 is both circularly permuted and terminally redundant. The genetic map, however, is linear (Scott 1968; Walker and Walker 1975, 1976). This paradox was resolved by the discovery that P1 contains a recombinational hot spot, *loxP* (locus of crossing-over [X] in P1), that defines the ends of the genetic map (Sternberg et al. 1978, 1983); recombination at this site is mediated by a single phage-encoded protein, Cre (cyclization recombination protein) (Sternberg et al. 1986). The *loxP-cre* system is necessary for cyclization of linear P1 DNA, which occurs within the first minutes after infection of *E. coli* (Segev et al. 1980; Segev and Cohen 1981; Hochman et al. 1983). Interestingly, because of the constraints imposed by the packaging process, only one in every four or five bacteriophage particles contains a DNA molecule with *loxP* sites in its terminally redundant regions (please see Figure 4-17). Only this subset of bacteriophage genomes are substrates for the *cre-loxP* system and only these bacteriophage genomes are capable of circularization and replication in *recA*-deficient strains of *E. coli* (for review, please see Yarmolinsky and Sternberg 1988). The 34-bp *loxP* site consists of two 13-bp inverted repeats separated by an 8-bp spacer (Hoess et al. 1982).



**FIGURE 4-17 Packaging of Bacteriophage P1 DNA from Intracellular Concatemers**

The substrate for packaging is a linear concatemer of DNA (shown in bold), in which the individual P1 genomes are arranged in a head-to-tail tandem. Packaging is initiated at a site (*pac*, shown as large scissors) that lies ~5 kb from the nearest *loxP* site. Other *pac* sites (small scissors) in the concatemer are not used. Packaging occurs by a unidirectional processive "headful" mechanism in which successive 100-kb segments of DNA are reeled into the bacteriophage prohead. Because the size of the bacteriophage P1 genome is ~90 kb, whereas the capacity of the prohead is ~100 kb, the DNA packaged into each bacteriophage particle is terminally redundant. Because of this redundancy, the first bacteriophage particle to be formed from each concatemer contains two *loxP* sites. The DNA of this bacteriophage can therefore be cyclized by Cre recombinase after injection into a new bacterial cell. Approximately four bacteriophages are packaged from each concatemer. However, only one of these virions contains *loxP* sites in its terminally redundant regions.



**FIGURE 4-18 Structure of the 34-bp *loxP* Site**

The 34-bp *loxP* site consists of two perfect inverted repeats 13 bp in length (shown within arrows), separated by an 8-bp spacer. Vertical arrows mark the locations of the sites cleaved by the Cre protein on the upper and lower strands of DNA. By convention, the nucleotides in the *loxP* site are numbered from the center of the spacer (vertical line). Base pairs to the left are given leftward positive (+) numbers; base pairs to the right are given negative (–) numbers.

Recombination at the *loxP* site is catalyzed by Cre, a 343-amino-acid recombinase protein encoded by the *cre* gene of P1 (Sternberg et al. 1986) that is a member of the Int family of recombinases (Argos et al. 1986). Each *loxP* site consists of two nonidentical Cre-binding domains, composed of one of the 13-bp repeats and the adjacent 4 bp of spacer. The most distal 2 bp of each inverted repeat can be modified without altering recombination frequency: Larger deletions, however, generate recombinant products with abnormal topology (Abremski and Hoess 1985). At saturation, two molecules of Cre bind to a complete *loxP* site (one Cre molecule per inverted repeat) (Mack et al. 1992). The Cre-*loxP* complex then synapses with a second *loxP* site, which can be located on the same molecule of DNA or another. Whether or not the second *loxP* site is also occupied by Cre is not known (Mack et al. 1992). Strand exchange between the synapsed *loxP* partners is initiated following asymmetric cleavage of DNA in the spacer region (please see Figures 4-18 and 4-19). Because of the asymmetry of the spacer, recombination between *loxP* sites located on the same DNA molecule has a polarity: Recombination between *loxP* sites that are in the same orientation results in excision of the DNA between the two sites, whereas recombination between sites that are in the opposite orientation causes inversion of the intervening DNA (Abremski et al. 1983). Thus, linear plasmid DNAs containing directly repeated *loxP* sites are cyclized in *E. coli* strains expressing Cre. In addition, *cre*<sup>+</sup> strains of *E. coli* can efficiently excise and circularize segments of DNA that are flanked by *loxP* sites in large linear genomes (Sauer and Henderson 1988a).

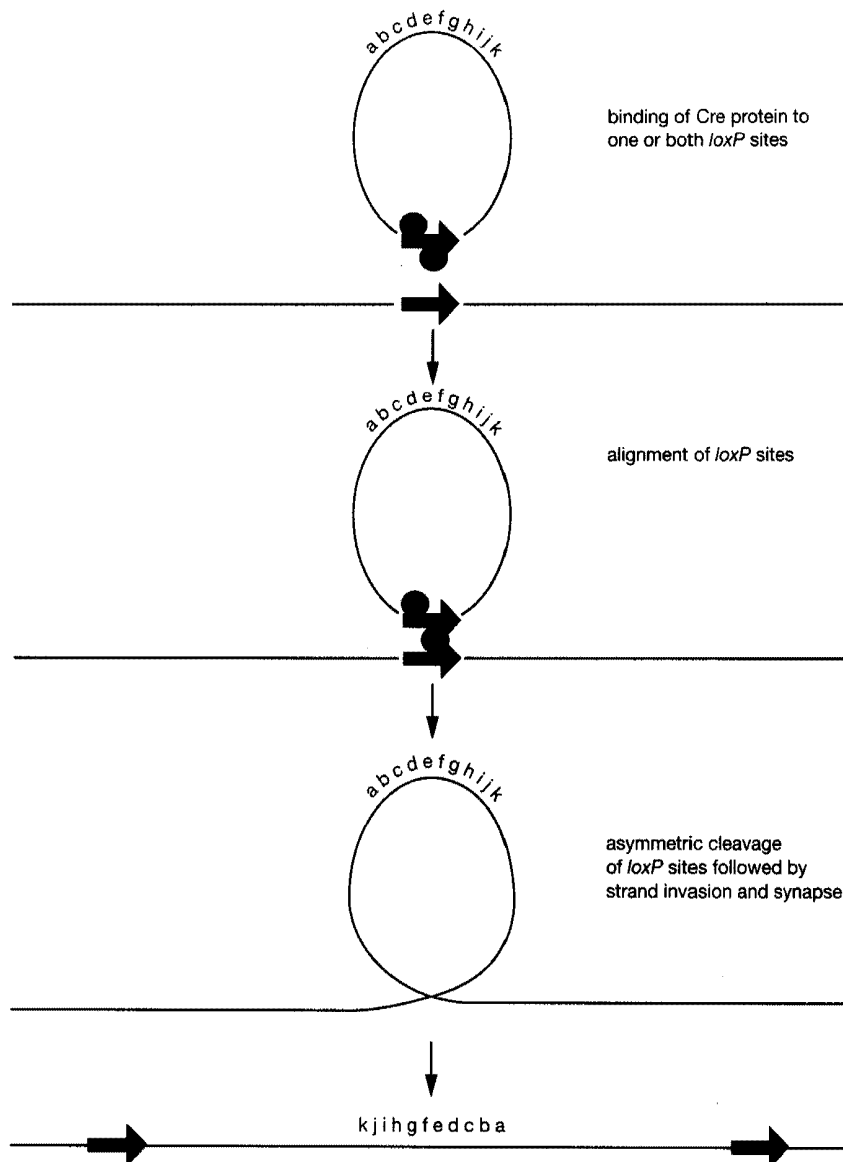
### Vectors Containing Cre-*loxP* Sites

Several groups have constructed bacteriophage  $\lambda$  vectors whose arms have unique restriction sites positioned between two *loxP* sites (e.g., please see Palazzolo et al. 1990; Elledge et al. 1991; Brunelli and Pall 1993; Holt and May 1993). A number of different specialized plasmids have been inserted into these vectors that contain *cis*-acting sequences required for high-level expression of cloned cDNAs in *E. coli* (Palazzolo et al. 1990) and yeast (Elledge et al. 1991; Brunelli and Pall 1993, 1994). Bacteriophage  $\lambda$  expression vectors of this type have two advantages: (1) automatic subcloning, in which Cre-mediated recombination can be used to convert the DNA lying between the *loxP* sites into an autonomously replicating plasmid that (2) is equipped with the controlling elements required to express cloned DNAs in both yeast and *E. coli*.

In the case of  $\lambda$ YES vectors (Elledge et al. 1991), which are available from CLONTECH, phages are used to infect a strain of *E. coli* (BNN132) that expresses both  $\lambda$  repressor and Cre protein but does not express the P1 restriction-modification system. The  $\lambda$  repressor ensures that the infecting phage enters the lysogenic pathway, whereas the Cre protein causes excision of the plasmid portion of the vector. This automatic subcloning system is extremely efficient with ~50% of the infecting phage giving rise to ampicillin-resistant colonies.  $\lambda$ EXlox (available commercially from Novagen) and  $\lambda$ ZipLox (available from Life Technologies) also work efficiently as automatic subcloning vectors (Palazzolo et al. 1990; D'Alessio et al. 1992). A potential advantage of these vectors is that the excised plasmids carry a bacteriophage f1 origin of replication and can function as phagemids.

Vectors with properties similar to those of  $\lambda$ YES are available that are suitable for construction of genomic libraries (Holt and May 1993). These vectors are useful chiefly for constructing genomic libraries of yeast, *Aspergillus*, and other eukaryotes whose genes are comparatively small and relatively free from





**FIGURE 4-19 Cre-mediated Recombination at *loxP* Sites**

Please see the text for details.

introns. In such cases, the genomic inserts rescued by automatic subcloning can be used to isolate extragenic suppressor mutations.

Rescue of plasmids from  $\lambda$  Cre-*loxP* vectors requires a source of Cre protein (such as *E. coli* strain BNN132, see above). However, there is some evidence that the presence of this protein suppresses the yield of multicopy plasmids carrying a *loxP* site and that plasmids with large cDNA inserts may be prone to deletion during propagation in *cre*<sup>+</sup> strains of *E. coli*. It is therefore advisable to move the rescued plasmids as quickly as possible into a strain of *E. coli* that does not express Cre (Palazzolo et al. 1990).

### Site-specific Integration and Excision of Transgenes Mediated by the Cre-*loxP* System

The Cre protein can catalyze recombination events not only in *E. coli*, but also in yeast (Sauer 1987) and mammalian cells (Sauer 1987; Sauer and Henderson 1988b; Fukushige and Sauer 1992). Thus, the Cre

recombinase can both drive site-specific integration of plasmids into the chromosomes of yeast and mammalian cells and catalyze precise excision of DNA segments flanked by *loxP* sites (see Figure 4-19). The integration event results from recombination between a plasmid-borne *loxP* site and a second *loxP* site that has been installed into the eukaryotic genome. The Cre protein can be supplied either from a cloned copy of the *cre* gene or, in the case of cultured mammalian cells, by using lipofection to introduce the purified recombinase (Baubonis and Sauer 1993). The latter method, although perhaps not everyone's cup of tea, has the advantage of (1) preventing integration of a transfected *cre* gene and (2) confining Cre-mediated recombination to a particular window of time. Extended expression of Cre results in a second round of recombination that removes the targeting vector from the chromosome. As far as is known, the genomes of yeast and mouse cells do not contain any *loxP* sites. Furthermore, the expression of Cre is not toxic to eukaryotic cells, nor does it affect the development, growth, or fertility of transgenic mice that carry the *cre* gene under the control of the mouse metallothionein I promoter or a cytomegalovirus promoter (Lakso et al. 1992; Orban et al. 1992). (Note: The *cre* gene lacks an optimal initiation signal for translation in mammalian cells [Kozak 1986, 1987]. Changing the -3 nucleotide from T to G results in a substantial increase in recombination ability in transfected mammalian cells [Sauer and Henderson 1990].)

Excision of chromosomal DNA segments flanked by *loxP* sites occurs with higher efficiency than integration of *loxP* plasmids into chromosomal *loxP* sites. By crossing genetically engineered strains of mice containing *loxP* sites at chosen chromosomal locations with transgenic animals that express Cre, the Cre-*loxP* system can be used to generate null alleles (Gu et al. 1994) and to activate oncogenes in a tissue-specific and developmentally regulated manner (Lakso et al. 1992). Other possible uses include the generation of specific chromosomal inversions and deletions, the ablation of specific cell lineages, and the generation of mice hemizygous for particular genes in preselected tissues.

The Cre-*loxP* system is not unique. Several other recombinase/target combinations are known that are capable of directing recombination events in a defined spatial and temporal fashion in eukaryotic organisms. These include the (1) the FLP recombinase of *Saccharomyces cerevisiae* that can catalyze recombination in both cultured mammalian cells and *Drosophila* and (2) the pSR1 recombinase of *Zygosaccharomyces rouxii* that can function efficiently in *S. cerevisiae* (Matsuzaki et al. 1990). However, at present, none of these site-specific recombination systems are as well developed as Cre-*loxP*.

---

**LARGE-FRAGMENT CLONING PRODUCTS AND SERVICES**


---

COMPANY	PRODUCTS/SERVICES	YAC PRODUCTS <sup>a</sup>			BAC PRODUCTS			CUSTOM SERVICES (AC) <sup>a</sup>		
		VEC.	LIB.	ISO. KITS	VEC.	LIB.	ISO. KITS	ISO.	LIB. CONSTR.	LIB. SCR.
Ana-Gen Technologies Inc. Tele: 800-654-4671 Web Site: www.ana-gen.com	Custom services							√		
AutoGen Tele: 800-654-4671 Web Site: www.autogen.com	AutoGen 740, 850, 850 Alpha			√			√			
CLONTECH Laboratories Inc. Tele: 800-662-2566 Web Site: www.clontech.com	NucleoBond Plasmid Kits			√			√			
Commonwealth Biotechnologies Inc. Tele: 800-735-9224 Web Site: www.cbi-biotech.com	Custom services							√	√	
CPG Inc. Tele: 800-362-2740 Web Site: www.cpg-biotech.com	DNA-Pure Yeast Genomic Kit			√						
Genome Systems Inc Tele: 800-430-0030 Web Site: www.genomesystems.com	P1 & PAC Plasmid Purification Kit						√			
	BAC Large Plasmid Purification Kit pBeloBAC11 YAC/BAC filter screening sets Custom service		√		√	√			√	√
Life Technologies Inc. Tele: 800-828-6686 Web Site: www.lifetech.com	CONCERT High Purity Plasmid Purification System						√			
Princeton Separations Inc. Tele: 800-223-0902 Web Site: www.prinsep.com	PSI CLONE BAC DNA Kit						√			
QIAGEN Tele: 800-426-8157 Web Site: www.qiagen.com	QIAGEN Large-Construct Kit R.E.A.L. Prep 96 Plasmid and BioRobot Kits						√			
Research Genetics Inc. Tele: 800-533-4363 Web Site: www.resgen.com	pBeloBAC11 BAC/YAC libraries Custom services		√		√	√		√	√	√
Sigma Tele: 800-325-3010 Web Site: www.sigma-aldrich.com	pYAC4	√								
Tetra-Link International Tele: 800-747-5170, Web Site: www.tetra-link.com	TrueBlue-BAC				√					

Reprinted, with permission, from J.D. Cortese (The Scientist 13[24]: 28 [1999]).

<sup>a</sup>(Vec.) vectors; (Lib.) libraries; (Iso. Kits) isolation kits; (Lib. Const.) library construction; (Lib. Scr.) library screening.

## REFERENCES

- Abremski K. and Hoess R. 1985. Phage P1 Cre-*loxP* site-specific recombination. Effects of DNA supercoiling on catenation and knotting of recombinant products. *J. Mol. Biol.* **184**: 211–220.
- Abremski K., Hoess R., and Sternberg N. 1983. Studies on the properties of P1 site-specific recombination: Evidence for topological unlinked products following recombination. *Cell* **32**: 1301–1311.
- Albertsen H.M., Abderrahim H., Cann H.M., Dausset J., Le Paslier D., and Cohen D. 1990. Construction and characterization of a yeast artificial chromosome library containing seven haploid human genome equivalents. *Proc. Natl. Acad. Sci.* **87**: 4256–4260.
- Allen M.J., Collick A., and Jeffreys A.J. 1994. Use of vectorette and subvectorette PCR to isolate transgene flanking DNA. *PCR Methods Appl.* **4**: 71–75.
- Amemiya C.T., Alegria-Hartman M.J., Aslanidis C., Chen C., Nikolic J., Gingrich J.C., and de Jong P.J. 1992. A two-dimensional YAC pooling strategy for library screening via STS and *Alu*-PCR methods. *Nucleic Acids Res.* **20**: 2559–2563.
- Anand R. 1992. Yeast artificial chromosomes (YACs) and the analysis of complex genomes. *Trends Biotechnol.* **10**: 35–40.
- Anand R., Riley J.H., Butler R., Smith J.C., and Markham A.F. 1990. A 3.5 genome equivalent multi access YAC library: Construction, characterisation, screening and storage. *Nucleic Acids Res.* **18**: 1951–1956.
- Anand R., Ogilvie D., Butler R., Riley J.H., Finiear R.S., Powell S.J., Smith J.C., and Markham A.F. 1991. A yeast artificial chromosome contig encompassing the cystic fibrosis locus. *Genomics* **9**: 124–130.
- Argos P., Landy A., Abremski K., Egan J.B., Haggard-Ljungquist E., Hoess R.H., Kahn M.L., Kalionis B., Narayana S.V., Pierson L.S.D. et al. 1986. The integrase family of site-specific recombinases: Regional similarities and global diversity. *EMBO J.* **5**: 433–440.
- Arnold C. and Hodgson I.J. 1991. Vectorette PCR: A novel approach to genomic walking. *PCR Methods Appl.* **1**: 39–42.
- Arweiler B. and Porteous D.J. 1991. Amplification of end fragments of YAC recombinants by inverse-polymerase chain reaction. *Technique* **3**: 24–28.
- Asakawa S., Abe I., Kudoh Y., Kishi N., Wang Y., Kubota R., Kudoh J., Kawasaki K., Minoshima S., and Shimizu N. 1997. Human BAC library: Construction and rapid screening. *Gene* **191**: 69–79.
- Bächi B. and Arber W. 1977. Physical mapping of *Bgl*III, *Bam*HI, *Eco*RI, *Hind*III and *Pst*I restriction fragments of bacteriophage P1 DNA. *Mol. Gen. Genet.* **153**: 311–324.
- Barillot E., Lacroix B., and Cohen D. 1991. Theoretical analysis of library screening using an N-dimensional pooling strategy. *Nucleic Acids Res.* **19**: 6241–6247.
- Bates P. 1987. Double *cos* site vectors: Simplified cosmid cloning. *Methods Enzymol.* **153**: 82–94.
- Bates P.F. and Swift R.A. 1983. Double *cos* site vectors: Simplified cosmid cloning. *Gene* **26**: 137–146.
- Baubonis W. and Sauer B. 1993. Genomic targeting with purified Cre recombinase. *Nucleic Acids Res.* **21**: 2025–2029.
- Bellane-Chantelot C., Barillot E., Lacroix B., Le Paslier D., and Cohen D. 1991. A test case for physical mapping of human genome by repetitive sequence fingerprints: Construction of a physical map of a 420 kb YAC subcloned into cosmids. *Nucleic Acids Res.* **19**: 505–510.
- Bentley D.R. and Dunham I. 1995. Mapping human chromosomes. *Curr. Opin. Genet. Dev.* **5**: 328–334.
- Bentley D.R., Todd C., Collins C., Holland J., Dunham I., Hassock S., Bankier A., and Gianelli F. 1992. The development and application of automated gridding for the efficient screening of yeast and bacterial ordered libraries. *Genomics* **12**: 534–541.
- Bertani G. 1951. Studies in lysogeny. I. The mode of phage liberation by lysogenic *Escherichia coli*. *J. Bacteriol.* **62**: 293–300.
- Black L.W. 1989. DNA packaging in dsDNA bacteriophages. *Annu. Rev. Microbiol.* **43**: 267–292.
- Brooks J.E. 1987. Properties and uses of restriction endonucleases. *Methods Enzymol.* **152**: 113–129.
- Brownstein B.H., Silverman G.A., Little R.D., Burke D.T., Korsmeyer S.J., Schlessinger D., and Olson M.V. 1989. Isolation of single-copy human genes from a library of yeast artificial-chromosome clones. *Science* **244**: 1348–1351.
- Brunelli J.P. and Pall M.L. 1993. A series of yeast/*Escherichia coli* lambda expression vectors designed for directional cloning of cDNAs and *cre/lox*-mediated plasmid excision. *Yeast* **9**: 1309–1318.
- . 1994. Lambda/plasmid vector construction by in vivo *cre/lox*-mediated recombination. *BioTechniques* **16**: 1060–1064.
- Burke D.T. 1991. The role of yeast artificial chromosome clones in generating genome maps. *Curr. Opin. Genet. Dev.* **1**: 69–74.
- Burke D.T. and Olson M.V. 1991. Preparation of clone libraries in yeast artificial chromosome vectors. *Methods Enzymol.* **194**: 251–270.
- Burke D.T., Carle G.F., and Olson M.V. 1987. Cloning of large segments of exogenous DNA into yeast by means of artificial chromosome vectors. *Science* **236**: 806–812.
- Cai L., Taylor J.F., Wing R.A., Gallagher D.S., Woo S.-S., and Davis S.K. 1995. Construction and characterization of a bovine bacterial artificial chromosome library. *Genomics* **29**: 413–425.
- Capecchi M. 1993. Mouse genetics. YACs to the rescue. *Nature* **362**: 205–206.
- Cavalli-Sforza L.L. 1950. La sessualita nei batteri. *Boll. Inst. Sieroter. Milan* **29**: 281–289.
- Cavalli-Sforza L., Lederberg J., and Lederberg E. 1953. An infective factor controlling sex compatibility in *B. coli*. *J. Gen. Microbiol.* **8**: 89–103.
- Chatterjee P.K. and Sternberg N.L. 1996. Retrofitting high molecular weight DNA cloned in P1: Introduction of reporter genes, markers selectable in mammalian cells and generation of nested deletions. *Genet. Anal.* **13**: 33–42.
- Chen E.Y., Schlessinger D., and Kere J. 1993. Ordered shotgun sequencing, a strategy for integrated mapping and sequencing of YAC clones. *Genomics* **17**: 651–656.
- Clarke L. and Carbon J. 1976. A colony bank containing synthetic Col E1 hybrid plasmids representative of the entire *E. coli* genome. *Cell* **9**: 91–99.
- Cohen D., Chumakov I., and Weissenbach J. 1993. A first generation physical map of the human genome. *Nature* **366**: 698–701.
- Collins J. and Hohn B. 1978. Cosmids: A type of plasmid gene-cloning vector that is packageable *in vitro* in bacteriophage lambda heads. *Proc. Natl. Acad. Sci.* **75**: 4242–4246.
- D'Alessio J.M., Bebee R., Hartley J.L., Noon M.C., and Polayes D.

1992. Lambda ZipLox: Automatic subcloning of cDNA. *Focus* (Life Technologies) **14**: 76–79.
- Deininger P.L., Jolly D.J., Rubin C.M., Friedmann T., and Schmid C.W. 1981. Base sequence studies of 300 nucleotide renatured repeated human DNA clones. *J. Mol. Biol.* **151**: 17–33.
- Devon R.S., Porteous D.J., and Brookes A.J. 1995. Splinkerettes—Improved vectorettes for greater efficiency in PCR walking. *Nucleic Acids Res.* **23**: 1644–1645.
- DiLella A.G. and Woo S.L.C. 1987. Cloning large segments of genomic DNA using cosmid vectors. *Methods Enzymol.* **152**: 199–212.
- Eliason J.L. and Sternberg N. 1987. Characterization of the binding sites of  $\text{cI}$  repressor of bacteriophage P1: Evidence for multiple asymmetric sites. *J. Mol. Biol.* **198**: 281–293.
- Elledge S.J., Mulligan J.T., Ramer S.W., Spottswood M., and Davis R.W. 1991. Lambda YES: A multifunctional cDNA expression vector for the isolation of genes by complementation of yeast and *Escherichia coli* mutations. *Proc. Natl. Acad. Sci.* **88**: 1731–1735.
- Evans G.A., Lewis K., and Rothenberg B.E. 1989. High efficiency vectors for cosmid microcloning and genomic analysis. *Gene* **79**: 9–20.
- Evans G.A., Snyder K., and Hermanson G.G. 1992. Use of cosmids and arrayed clone libraries for genome analysis. *Methods Enzymol.* **216**: 530–548.
- Feingold J.M., Ogden S.D., and Denny C.T. 1990. Streamlined approach to creating yeast artificial chromosome libraries from specialized cell sources. *Proc. Natl. Acad. Sci.* **87**: 8637–8641.
- Feiss M., Fisher R.A., Crayton M.A., and Egner C. 1977. Packaging of the bacteriophage lambda chromosome: Effect of chromosome length. *Virology* **77**: 281–293.
- Feiss M., Widner W., Miller G., Johnson G., and Christiansen S. 1983. Structure of the bacteriophage-lambda cohesive end site—Location of the sites of terminase binding (*cosB*) and nicking (*cosN*). *Gene* **24**: 207–218.
- Ferretti L. and Sgaramella V. 1981. Temperature dependence of the joining by T4 DNA ligase of termini produced by type II restriction endonucleases. *Nucleic Acids Res.* **9**: 85–93.
- Fogel S., Mortimer R.K., and Lusnak K. 1981. Mechanisms of meiotic gene conversion, or “Wanderings on a foreign strand.” In *The molecular biology of the yeast Saccharomyces: Life cycle and inheritance* (ed. J.N. Strathern et al.), pp. 289–339. Cold Spring Harbor Laboratory, Cold Spring Harbor, New York.
- Forget B.G. 1993. YAC transgenes: Bigger is probably better. *Proc. Natl. Acad. Sci.* **90**: 7909–7911.
- Frame R. and Bishop J.O. 1971. The number of sex-factors per chromosome in *Escherichia coli*. *Biochem. J.* **121**: 93–103.
- Francis F., Zehetner G., Hoglund M., and Lehrach H. 1994. Construction and preliminary analysis of the ICRF human P1 library. *Genet. Anal. Tech. Appl.* **11**: 148–157.
- Fukushige S. and Sauer B. 1992. Genomic targeting with a positive-selection *lox* integration vector allows highly reproducible gene expression in mammalian cells. *Proc. Natl. Acad. Sci.* **89**: 7905–7909.
- Garza D., Ajioka J.W., Burke D.T., and Hartl D.L. 1989. Mapping the *Drosophila* genome with yeast artificial chromosomes. *Science* **246**: 641–646.
- Gay P., Le Coq D., Steinmetz M., Berkelman T., and Kado C.I. 1985. Positive selection procedure for entrapment of insertion sequence elements in gram-negative bacteria. *J. Bacteriol.* **164**: 918–921.
- Gav P., Le Coq D., Steinmetz M., Ferrari E., and Hoch J.A. 1983. Cloning the structural gene *sacB*, which codes for the exoenzyme levan sucrase of *Bacillus subtilis*: Expression of the gene in *Escherichia coli*. *J. Bacteriol.* **153**: 1424–1431.
- Gnirke A. and Huxley C. 1991. Transfer of the human HPRT and GART genes from yeast to mammalian cells by microinjection of DNA. *Somat. Cell Mol. Genet.* **17**: 573–580.
- Gorman S.W., Roberts-Oehlschlager S.L., Cullis C.A., and Teasdale R.D. 1992. Producing a P1 bacteriophage library from pine: Isolation and cloning of very high molecular weight DNA. *BioTechniques* **12**: 722–727.
- Green E.D. and Olson M.V. 1990. Systematic screening of yeast artificial chromosome libraries by use of the polymerase chain reaction. *Proc. Natl. Acad. Sci.* **87**: 1213–1217.
- Green E.D., Riethman H.C., Dutchik J.E., and Olson M.V. 1991. Detection and characterization of chimeric yeast artificial-chromosome clones. *Genomics* **11**: 658–669.
- Green E.D., Birren B., Klapholz S., Myers R.M., and Heiter P., eds. 1997–1999. *Genome analysis: A laboratory manual*, vols. 1–4. Cold Spring Harbor Laboratory Press, Cold Spring Harbor, New York.
- Gu H., Marth J.D., Orban P.C., Mossmann H., and Rajewsky K. 1994. Deletion of a DNA polymerase  $\beta$  gene segment in T cells using cell-type specific gene targeting. *Science* **265**: 103–106.
- Hanahan D. and Meselson M. 1980. Plasmid screening at high colony density. *Gene* **10**: 63–67.
- Hartl D.L., Nurminsky D.I., Jones R.W., and Lozovskaya E.R. 1994. Genome structure and evolution in *Drosophila*: Application of the framework P1 map. *Proc. Natl. Acad. Sci.* **91**: 6824–6829.
- Hayes W. 1952. Recombination in *Bact. coli* K-12: Unidirectional transfer of genetic material. *Nature* **169**: 118–119.
- . 1953. Observations on a transmissible agent determining sexual differentiation in *B. coli*. *J. Gen. Microbiol.* **8**: 72–88.
- Heale S.M., Stateva L.I., and Oliver S.G. 1994. Introduction of YACs into intact yeast cells by a procedure which shows low levels of recombinogenicity and co-transformation. *Nucleic Acids Res.* **22**: 5011–5015.
- Hengen P.N. 1995. Vectorette, splinkerette and boomerang DNA amplification. *Trends Biochem. Sci.* **20**: 372–373.
- Hieter P., Mann C., Snyder M., and Davis R.W. 1985. Mitotic stability of yeast chromosomes: A colony color assay that measures nondisjunction and chromosome loss. *Cell* **40**: 381–392.
- Hochman L., Segev N., Sternberg N., and Cohen G. 1983. Site-specific recombinational circularization of bacteriophage P1 DNA. *Virology* **131**: 11–17.
- Hoess R.H. and Abremski K. 1984. Interaction of the bacteriophage P1 recombinase Cre with the recombining site *loxP*. *Proc. Natl. Acad. Sci.* **81**: 1026–1029.
- Hoess R.H., Ziese M., and Sternberg N. 1982. P1 site-specific recombination: Nucleotide sequence of the recombining sites. *Proc. Natl. Acad. Sci.* **79**: 3398–3402.
- Hoheisel J.D., Maier E., Mott R., McCarthy L., Grigoriev A.V., Schalkwyk L.C., Nizetic D., Francis F., and Lehrach H. 1993. High resolution cosmid map and P1 maps spanning the 14 Mb genome of the fission yeast *S. pombe*. *Cell* **73**: 109–120.
- Hohn B. 1979. In vitro packaging of lambda and cosmid DNA. *Methods Enzymol.* **68**: 299–309.
- Hohn B., Koukolikova-Nicola Z., Lindenmaier W., and Collins J. 1988. Cosmids. *BioTechnology* **10**: 113–127.
- Holt C.L. and May G.S. 1993. A novel phage lambda replacement Cre-*lox* vector that has automatic subcloning capabilities.

- Gene* **133**: 95–97.
- Hung M.-C. and Wensink P.C. 1984. Different restriction enzyme-generated sticky DNA ends can be joined in vitro. *Nucleic Acids Res.* **12**: 1863–1874.
- Huxley C. 1994. Transfer of YACs to mammalian cells and transgenic mice. *Genet. Eng.* **16**: 65–91.
- Ioannou P.A., Amemiya C.T., Garnes J., Kroisel P.M., Shizuya H., Chen C., Batzer M.A., and de Jong P.J. 1994. A new bacteriophage P1-derived vector for the propagation of large human DNA fragments. *Nat. Genet.* **6**: 84–89.
- Ippen-Ihler K. and Minkley Jr., N.G. 1986. The conjugation system of F, the fertility factor of *Escherichia coli*. *Annu. Rev. Genet.* **20**: 593–624.
- Kim U.J., Birren B.W., Slepak T., Mancino V., Boysen C., Kang H.L., Simon M.L., and Shizuya H. 1996. Construction and characterization of a human bacterial chromosome library. *Genomics* **34**: 213–218.
- Koshland D., Kent J.C., and Hartwell L.H. 1985. Genetic analysis of the mitotic transmission of minichromosomes. *Cell* **40**: 393–403.
- Kouprina N., Eldarov M., Moyzis R., Resnick M., and Larionov V. 1994. A model system to assess the integrity of mammalian YACs during transformation and propagation in yeast. *Genomics* **21**: 7–17.
- Kozak M. 1986. Influences of mRNA secondary structure on initiation by eukaryotic ribosomes. *Proc. Natl. Acad. Sci.* **83**: 2850–2854.
- . 1987. An analysis of 5'-noncoding sequences from 699 vertebrate messenger RNAs. *Nucleic Acids Res.* **15**: 8125–8148.
- Kwiatkowski Jr., T.J., Zoghbi H.Y., Ledbetter S.A., Ellison K.A., and Chinault A.C. 1990. Rapid identification of yeast artificial chromosome clones by matrix pooling and crude lysate PCR. *Nucleic Acids Res.* **18**: 7191–7192.
- Lai E. and Cantrell C. 1989. Rapid colony screening of YAC libraries by using alginate as matrix support. *Nucleic Acids Res.* **17**: 8008.
- Lakso M., Sauer B., Mosinger Jr., B., Lee E.J., Manning R.W., Yu S.H., Mulder K.L., and Westphal H. 1992. Targeted oncogene activation by site-specific recombination in transgenic mice. *Proc. Natl. Acad. Sci.* **89**: 6232–6236.
- Larin Z., Monaco A.P., and Lehrach H. 1991. Yeast artificial chromosome libraries containing large inserts from mouse and human DNA. *Proc. Natl. Acad. Sci.* **88**: 4123–4127.
- Lennon G.G. and Lehrach H. 1991. Hybridization analyses of arrayed cDNA libraries. *Trends Genet.* **7**: 314–317.
- Lichter P. and Ward D.C. 1990. Is non-isotopic *in situ* hybridization finally coming of age? *Nature* **345**: 93–94.
- Ling L.L., Ma N.S., Smith D.R., Miller D.D., and Moir D.T. 1993. Reduced occurrence of chimeric YACs in recombination-deficient hosts. *Nucleic Acids Res.* **21**: 6045–6046.
- Little P.F.R. and Jackson I.J. 1987. Application of plasmids containing promoters specific for phage-encoded RNA polymerases. In *DNA cloning: A practical approach* (ed. D.M. Glover), vol. 3, pp. 1–18. IRL Press, Oxford, United Kingdom.
- Little R.D., Porta G., Carle G.F., Schlessinger D., and D'Urso M. 1989. Yeast artificial chromosomes with 200- to 800-kilobase inserts of human DNA containing HLA, V kappa, 5S, and Xq24-Xq28. *Proc. Natl. Acad. Sci.* **86**: 1598–1602.
- Liu Y.-G. and Whittier R.F. 1995. Thermal asymmetric interlaced PCR: Automatable amplification and sequencing of insert end fragments from P1 and YAC clones for chromosome walking. *Genomics* **25**: 674–681.
- Liu Y.-G., Mitsukawa N., Oosumi T., and Whittier R.F. 1995. Efficient isolation and mapping of *Arabidopsis thaliana* T-DNA insert junctions by thermal asymmetric interlaced PCR. *Plant J.* **8**: 457–463.
- Loftus M.G., Foster L.M., and Ross I.K. 1992. A rapid method for cosmid cloning. *BioTechniques* **12**: 172–176.
- Longmire J.L., Brown N.C., Meincke L.J., Campbell M.L., Albright K.L., Fawcett J.J., Campbell E.W., Moyzis R.K., Hildebrand C.E., Evans G.A. et al. 1993. Construction and characterization of partial digest DNA libraries made from flow-sorted human chromosome 16. *Genet. Anal. Tech. Appl.* **10**: 69–76.
- Low K.B. 1987. Hfr strains of *Escherichia coli* K-12. In *Escherichia coli and Salmonella typhimurium* (ed. F.C. Neidhardt et al.), vol. 2, pp. 1134–1137. American Society for Microbiology, Washington, D.C.
- MacGregor G.R. and Overbeek P.A. 1991. Use of a simplified single-site PCR to facilitate cloning of genomic DNA sequences flanking a transgene integration site. *PCR Methods Appl.* **1**: 129–135.
- Mack A., Sauer B., Abremski K., and Hoess R. 1992. Stoichiometry of the Cre recombinase bound to the *lox* recombining site. *Nucleic Acids Res.* **20**: 4451–4455.
- MacLaren D.C. and Clarke S. 1996. Rapid mapping of genomic P1 clones: The mouse L-isoaspartyl/D-aspartyl methyltransferase gene. *Genomics* **35**: 299–307.
- MacMurray A.J., Weaver A., Shin H.-S., and Lander E.S. 1991. An automated method for DNA preparation from thousands of YAC clones. *Nucleic Acids Res.* **19**: 385–390.
- Maniatis T., Hardison R.C., Lacy E., Lauer J., O'Connell C., Quon D., Sim G.K., and Efstratiadis A. 1978. The isolation of structural genes from libraries of eucaryotic DNA. *Cell* **15**: 687–701.
- Matsuzaki H., Nakajima R., Nishiyama J., Araki H., and Oshima Y. 1990. Chromosome engineering in *Saccharomyces cerevisiae* by using a site-specific recombination system of a yeast plasmid. *J. Bacteriol.* **172**: 610–618.
- McAleer M.A., Coffey A., and Dunham I. 1996. DNA rescue by the vectorette method. *Methods Mol. Biol.* **65**: 201–208.
- McCormick M.K., Antonarakis S.E., and Hieter P. 1990. YAC cloning of DNA embedded in an agarose matrix. *Genet. Anal. Tech. Appl.* **7**: 114–118.
- McCormick M.K., Shero J.H., Cheung M.C., Kan Y.W., Hieter P.A., and Antonarakis S.E. 1989. Construction of human chromosome 21-specific yeast artificial chromosome library. *Proc. Natl. Acad. Sci.* **86**: 9991–9995.
- Mejia J.E. and Monaco A.P. 1997. Retrofitting vectors for *Escherichia coli*-based artificial chromosomes (PACs and BACs) with markers for transfection studies. *Genome Res.* **7**: 179–186.
- Monaco A.P. and Larin Z. 1994. YACs, BACs, PACs and MACs: Artificial chromosomes as research tools. *Trends Biotechnol.* **12**: 280–286.
- Montanaro V., Casamassimi A., D'Urso M., Yoon J.-Y., Freije W., Schlessinger D., Muenke M., Nussbaum R.L., Saccone S., Maugeri S., Santoro A.M., Motta S., and Della Valle G. 1991. In situ hybridization to cytogenetic bands of yeast artificial chromosome covering 50% of human Xq24-Xq28 DNA. *Am. J. Hum. Genet.* **48**: 183–194.
- Montoliu L., Schedl A., Kelsey G., Zentgraf H., Lichter P., and Schütz G. 1994. Germ line transmission of yeast artificial chromosomes in transgenic mice. *Reprod. Fertil. Dev.* **6**: 577–584.
- Montoliu L., Schedl A., Kelsey G., Lichter P., Larin Z., Lehrach H.,

- and Schütz G. 1993. Generation of transgenic mice with yeast artificial chromosomes. *Cold Spring Harbor Symp. Quant. Biol.* **58**: 55–62.
- Murray A.W. and Szostak J.W. 1983. Construction of artificial chromosomes in yeast. *Nature* **305**: 189–193.
- Nagaraja R., Kere J., MacMillan S., Masisi M.J., Johnson D., Molini B.J., Halley G.R., Wein K., Trusgnich M., Eble B. et al. 1994. Characterization of 4 human YAC libraries for clone size, chimerism and X-chromosome sequence representation. *Nucleic Acids Res.* **22**: 3406–3411.
- Nelson D.L., Ledbetter S.A., Corbo L., Victoria M.F., Ramirez-Solis R., Webster T.D., Ledbetter D.H., and Caskey C.T. 1989. *Alu* polymerase chain reaction: A method for rapid isolation of human-specific sequences from complex DNA sources. *Proc. Natl. Acad. Sci.* **86**: 6686–6690.
- Ochman H., Gerber A.S., and Hartl D.L. 1988. Genetic applications of an inverse polymerase chain reaction. *Genetics* **120**: 621–623.
- Ogilvie D.J. and James L.A. 1996. End rescue from YACs using the vectorette. *Methods Mol. Biol.* **54**: 131–138.
- Orban P.C., Chui D., and Marth J.D. 1992. Tissue- and site-specific DNA recombination in transgenic mice. *Proc. Natl. Acad. Sci.* **89**: 6861–6865.
- Palazzolo M.J., Hamilton B.A., Ding D.L., Martin C.H., Mead D.A., Mierendorf R.C., Raghavan K.V., Meyerowitz E.M., and Lipshitz H.D. 1990. Phage lambda cDNA cloning vectors for subtractive hybridization, fusion-protein synthesis and Cre-loxP automatic plasmid subcloning. *Gene* **88**: 25–36.
- Pan H.-Q., Wang Y.-P., Chisoe S.L., Bodenteich A., Wang Z., Iyer K., Clifton S.W., Crabtree J.S., and Roe B.A. 1994. The complete nucleotide sequences of the SacBII Kan domain of the P1 pAD10-SacBII cloning vector and three cosmid cloning vectors: pTCF, svPHEP, and LAWRIST16. *Genet. Anal. Tech. Appl.* **11**: 181–186.
- Paranchych W. and Frost L.S. 1988. The physiology and biochemistry of pili. *Adv. Microb. Physiol.* **29**: 53–114.
- Peterson K.R. 1997. Production and analysis of transgenic mice containing yeast artificial chromosomes. *Genet. Eng.* **19**: 235–255.
- Pierce J.C. and Sternberg N.L. 1992. Using the bacteriophage P1 system to clone high molecular weight genomic DNA. *Methods Enzymol.* **216**: 549–574.
- Pierce J.C., Sauer B., and Sternberg N. 1992a. A positive selection vector for cloning high molecular weight DNA in the bacteriophage P1 system: Improved cloning efficiency. *Proc. Natl. Acad. Sci.* **89**: 2056–2060.
- Pierce J.C., Sternberg N., and Sauer B. 1992b. A mouse genomic library in the bacteriophage P1 cloning system: Organization and characterization. *Mamm. Genome* **3**: 550–558.
- Rackwitz H.R., Zehetner G., Frischauf A.M., and Lehrach H. 1984. Rapid restriction mapping of DNA cloned in lambda phage vectors. *Gene* **30**: 195–200.
- Rackwitz H.R., Zehetner G., Murialdo H., Delius H., Chai J.H., Poustka A., Frischauf A., and Lehrach H. 1985. Analysis of cosmids using linearization by phage lambda terminase. *Gene* **40**: 259–266.
- Ramsay M. 1994. Yeast artificial chromosome cloning. *Mol. Biotechnol.* **1**: 181–201.
- Reeves R.H., Pavan W.J., and Hieter P. 1992. Yeast artificial chromosome modification and manipulation. *Methods Enzymol.* **216**: 584–603.
- Riley J.H., Ogilvie D., and Anand R. 1992. Construction, characterization and screening of YAC libraries. In *Techniques for analysis of complex genomes* (ed. R. Anand), pp. 59–80. Academic Press, London, United Kingdom.
- Riley J., Butler R., Ogilvie D., Finniear R., Jenner D., Powell S., Anand R., Smith J.C., and Markham A.F. 1990. A novel rapid method for the isolation of terminal sequences from yeast artificial chromosome (YAC) clones. *Nucleic Acids Res.* **18**: 2887–2890.
- Roman H. 1957. Studies of gene mutation in *Saccharomyces*. *Cold Spring Harbor Symp. Quant. Biol.* **21**: 175–185.
- Rosenthal A. 1992. PCR amplification techniques for chromosome walking. *Trends Biotechnol.* **10**: 44–48.
- Sambrook J., Fritsch E., and Maniatis T. 1989. *Molecular cloning: A laboratory manual*, 2nd edition. Cold Spring Harbor Laboratory Press, Cold Spring Harbor, New York.
- Sauer B. 1987. Functional expression of the cre-lox site-specific recombination system in the yeast *Saccharomyces cerevisiae*. *Mol. Cell. Biol.* **7**: 2087–2096.
- Sauer B. and Henderson N. 1988a. Site-specific DNA recombination in mammalian cells by the Cre recombinase of bacteriophage P1. *Proc. Natl. Acad. Sci.* **85**: 5166–5170.
- . 1988b. The cyclization of linear DNA in *Escherichia coli* by site-specific recombination. *Gene* **70**: 331–341.
- . 1990. Targeted insertion of exogenous DNA into the eukaryotic genome by the Cre recombinase. *New Biol.* **2**: 441–449.
- Schlessinger D. 1990. Yeast artificial chromosomes: Tools for mapping and analysis of complex genomes. *Trends Genet.* **6**: 248–258.
- Scott J.R. 1968. Genetic studies on bacteriophage P1. *Virology* **36**: 564–574.
- Seed B. 1982. Theoretical study of the fraction of a long-chain DNA that can be incorporated in a recombinant DNA partial-digest library. *Biopolymers* **21**: 1793–1810.
- Seed B., Parker R.C., and Davidson N. 1982. Representation of DNA sequences in recombinant DNA libraries prepared by restriction enzyme partial digestion. *Gene* **19**: 201–209.
- Segev N. and Cohen G. 1981. Control of circularization of bacteriophage P1 DNA in *Escherichia coli*. *Virology* **114**: 333–342.
- Segev N., Laub A., and Cohen G. 1980. A circular form of bacteriophage P1 DNA made in lytically infected cells of *Escherichia coli*. Characterization and kinetics of formation. *Virology* **101**: 261–271.
- Selleri L., Eubanks J.H., Giovannini M., Hermanson G.G., Romo A., Djabali M., Maurer S., McElligott D.L., Smith M.W., and Evans G.A. 1992. Detection and characterization of “chimeric” yeast artificial chromosome clones by fluorescent in situ suppression hybridization. *Genomics* **14**: 536–541.
- Sheng Y., Mancina V., and Birren B. 1995. Transformation of *Escherichia coli* with large DNA molecules by electroporation. *Nucleic Acids Res.* **23**: 1990–1996.
- Shepherd N.S. and Smoller D. 1994. The P1 vector system for the preparation and screening of genomic libraries. *Genet. Eng.* **16**: 213–228.
- Shepherd N.S., Pfrogner B.D., Coulby J.N., Ackerman S.L., Vaidyanathan G., Sauer R.H., Balkenhol T.C., and Sternberg N. 1994. Preparation and screening of an arrayed human genomic library generated with the P1 cloning system. *Proc. Natl. Acad. Sci.* **91**: 2629–2633.
- Shizuya H., Birren B., Kim U.J., Mancino V., Slepak T., Tachiiri Y., and Simon M. 1992. Cloning and stable maintenance of 300-kilobase-pair fragments of human DNA in *Escherichia coli* using an F-factor-based vector. *Proc. Natl. Acad. Sci.* **89**: 8794–8797.

- Shovlin C.L. 1996. Streamlined procedures for screening a P1 library. *BioTechniques* **21**: 388–390.
- Silverman G.A., Ye R.D., Pollock K.M., Sadler J.E., and Korsmeyer S.J. 1989. Use of yeast artificial chromosome clones for mapping and walking within human chromosome segment 18q21.3. *Proc. Natl. Acad. Sci.* **86**: 7485–7489.
- Skorupski K., Sauer B., and Sternberg N. 1994. Faithful cleavage of the P1 packaging site (*pac*) requires two phage proteins, PacA and PacB, and two *Escherichia coli* proteins, IHF and HU. *J. Mol. Biol.* **243**: 268–282.
- Skorupski K., Pierce J.C., Sauer B., and Sternberg N. 1992. Bacteriophage P1 genes involved in the recognition and cleavage of the phage packaging site (*pac*). *J. Mol. Biol.* **223**: 977–989.
- Smith H.O. and Birnstiel M.L. 1976. A simple method for DNA restriction site mapping. *Nucleic Acids Res.* **3**: 2387–2398.
- Smoller D.A., Petrov D., and Hartl D.L. 1991. Characterization of a bacteriophage P1 library containing inserts of *Drosophila* DNA of 75–100 kilobase pairs. *Chromosoma* **100**: 487–494.
- Smoller D.A., Kimmerly W.J., Hubbard O., Ericsson C., Martin C.H., and Palazzolo M.J. 1994. A role for the P1 cloning system in genome analysis. In *Automated DNA sequencing and analysis techniques* (ed. M.D. Adams et al.), pp. 89–101. Academic Press, London, United Kingdom.
- Sternberg N. 1990. Bacteriophage-P1 cloning system for the isolation, amplification, and recovery of DNA fragments as large as 100 kilobase pairs. *Proc. Natl. Acad. Sci.* **87**: 103–107.
- . 1992. Cloning high molecular weight DNA fragments by the bacteriophage P1 system. *Trends Genet.* **8**: 11–16.
- . 1994. The P1 cloning system: Past and future. *Mamm. Genome* **5**: 397–404.
- Sternberg N. and Cohen G. 1989. Genetic analysis of the lytic replicon of bacteriophage P1. II. Organization of the replicon elements. *J. Mol. Biol.* **207**: 111–133.
- Sternberg N., Hoess R., and Abremski K. 1983. The P1 *lox*-Cre site-specific recombination system: Properties of *lox* sites and biochemistry of *lox*-Cre interactions. *UCLA Symp. Mol. Cell. Biol. New Ser.* **10**: 671–684.
- Sternberg N., Ruether J., and deRiel K. 1990. Generation of a 50,000-member human DNA library with an average insert size of 75–100 kbp in a bacteriophage P1 cloning vector. *New Biol.* **2**: 151–162.
- Sternberg N., Smoller D., and Braden T. 1994. Three new developments in P1 cloning. Increased cloning efficiency, improved clone recovery, and a new P1 mouse library. *Genet. Anal. Tech. Appl.* **11**: 171–180.
- Sternberg N., Austin S., Hamilton D., and Yarmolinsky M. 1978. Analysis of bacteriophage P1 immunity by using lambda-P1 recombinants constructed in vitro. *Proc. Natl. Acad. Sci.* **75**: 5594–5598.
- Sternberg N., Sauer B., Hoess R., and Abremski K. 1986. Bacteriophage P1 *cre* gene and its regulatory region. Evidence for multiple promoters and for regulation by DNA methylation. *J. Mol. Biol.* **187**: 197–212.
- Strong S.J., Ohta Y., Litman G.W., and Amemiya C.T. 1997. Marked improvement of PAC and BAC cloning is achieved using electroelution of pulsed-field gel-separated partial digests of genomic DNA. *Nucleic Acids Res.* **25**: 3959–3961.
- Iadokoro K., Oki N., Fijii H., Ohshima A., Inoue T., and Yamada M. 1992. Genomic organization of the human WT1 gene. *Jpn. J. Cancer Res.* **83**: 1198–1203.
- Tanahashi H. 1994. Analysis of human chromosome 21q: Isolation of linking clones and generation of STSs, and construction of P1 phage library. *Nippon Rinsho* **52**: 515–525.
- Tang B. and Waterman M.S. 1990. The expected fraction of cloneable genomic DNA. *Bull. Math. Biol.* **52**: 455–475.
- Tang L.B., Lenstra R., Bochert T.V., and Nagarajan V. 1990. Isolation and characterization of levansucrase-encoding gene from *Bacillus amyloliquefaciens*. *Gene* **96**: 89–93.
- Traver C.N., Klapholz S., Hyman R.W., and Davis R.W. 1989. Rapid screening of a human genome library in yeast artificial chromosomes for single copy sequences. *Proc. Natl. Acad. Sci.* **86**: 5898–5902.
- Triglia T., Peterson M.G., and Kemp D.J. 1988. A procedure for in vitro amplification of DNA sequences that lie outside the boundaries of known sequences. *Nucleic Acids Res.* **16**: 8186.
- van Ommen G.-J. 1992. First report of the HUGO YAC committee. In *Genome priority reports: Chromosome coordinating meeting* (ed. A.J. Cuticchia et al.), vol. 1, pp. 885–888. Karger, Basel, Switzerland.
- Vaudin M., Roopra A., Hillier L., Brinkman R., Sulston J., Wilson R.K., and Waterston R.H. 1995. The construction and analysis of M13 libraries prepared from YAC DNA. *Nucleic Acids Res.* **23**: 670–674.
- Vilageliu L. and Tyler-Smith C. 1992. Structural instability of YAC clones and the use of recombination-deficient host strains. In *Techniques for the analysis of complex genomes* (ed. R. Anand), pp. 93–112. Academic Press, London, United Kingdom.
- Vollenweider H.J., Fiantt M., Rosenvold E.C., and Szybalski W. 1980. Packaging of plasmid DNA containing the cohesive ends of coliphage lambda. *Gene* **9**: 171–174.
- Wada M., Little R.D., Abidi F., Porta G., Labella T., Cooper T., Della Valle G., D'Urso M., and Schlessinger D. 1990. Human Xq24-Xq28: Approaches to mapping with yeast artificial chromosomes. *Am. J. Hum. Genet.* **46**: 95–106.
- Walker Jr., D.H. and Walker J.T. 1975. Genetic studies of coliphage P1. I. Mapping by use of prophage deletions. *J. Virol.* **16**: 525–534.
- . 1976. Genetic studies of coliphage P1. II. Relatedness to P7. *J. Virol.* **19**: 271–274.
- Wang G.-L., Holsten T.E., Song W.-Y., Wang H.P., and Ronald P.C. 1995. Construction of a rice bacterial artificial chromosome library and identification of clones linked to the Xa-21 disease resistance locus. *Plant J.* **7**: 525–533.
- Well A.M. and Stewart G.G. 1973. Storage of brewing yeasts by liquid nitrogen refrigeration. *Appl. Microbiol.* **26**: 577.
- Wesley C.S., Myers M.P., and Young M.W. 1994. Rapid sequential walking from termini of cosmid, P1 and YAC inserts. *Nucleic Acids Res.* **22**: 538–539.
- Willets N. and Skurray R. 1987. Structure and function of the F factor and mechanisms of conjugation. In *Escherichia coli and Salmonella typhimurium* (ed. F.C. Neidhardt et al.), vol. 2, pp. 1110–1133. American Society for Microbiology, Washington, D.C.
- Wong P., Myal Y., Shui R., and Tenniswood M. 1993. Identification and cloning of a new category of DNA fragments which are poorly represented in human genomic libraries. *Biochem. Biophys. Res. Commun.* **190**: 453–461.
- Woo S.-S., Jiang J., Gill B.S., Paterson A.H., and Wing R.A. 1994. Construction and characterization of a bacterial artificial chromosome library of sorghum bicolor. *Nucleic Acids Res.* **22**: 4922–4931.
- Wu R. and Taylor E. 1971. Nucleotide sequence analysis of DNA. II. Complete nucleotide sequence of the cohesive ends of bacteriophage lambda DNA. *J. Mol. Biol.* **57**: 491–511.



- Yamamoto T., Davis C.G., Brown M.S., Schneider W.J., Casey M.L., Goldstein J.L., and Russell D.W. 1984. The human LDL receptor: A cysteine-rich protein with multiple *Alu* sequences in its mRNA. *Cell* 39: 27–38.
- Yarmolinsky M.B. and Sternberg N. 1988. Bacteriophage P1. In *The bacteriophages* (ed. R. Calendar), vol. 1, pp. 291–438. Plenum Press, New York.
- Yokobata K., Trenchak B., and de Jong P.J. 1991. Rescue of unstable cosmids by in vitro packaging. *Nucleic Acids Res.* 19: 403–404.
- Zabarovsky E.R. and Allikmets R.L. 1986. An improved technique for the efficient construction of gene libraries by partial filling in of cohesive ends. *Gene* 42: 119–123.
- Zehetner G. and Lehrach H. 1994. The reference library system-sharing biological material and experimental data. *Nature* 367: 489–491.
- Zimmer R. and Verrinder Gibbins A.M. 1997. Construction and characterization of a large-fragment chicken bacterial artificial chromosome library. *Genomics* 42: 217–226.

# Chapter 5

---

## Gel Electrophoresis of DNA and Pulsed-field Agarose Gel Electrophoresis

### INTRODUCTION

### PROTOCOLS

1	Agarose Gel Electrophoresis	5.4
2	Detection of DNA in Agarose Gels	5.14
3	Recovery of DNA from Agarose Gels: Electrophoresis onto DEAE-cellulose Membranes	5.18
4	Recovery of DNA from Agarose and Polyacrylamide Gels: Electroelution into Dialysis Bags	5.23
5	Purification of DNA Recovered from Agarose and Polyacrylamide Gels by Anion-exchange Chromatography	5.26
6	Recovery of DNA from Low-melting-temperature Agarose Gels: Organic Extraction	5.29
	• Alternative Protocol: Recovery of DNA from Agarose Gels Using Glass Beads	5.32
7	Recovery of DNA from Low-melting-temperature Agarose Gels: Enzymatic Digestion with Agarase	5.33
8	Alkaline Agarose Gel Electrophoresis	5.36
	• Additional Protocol: Autoradiography of Alkaline Agarose Gels	5.39
9	Neutral Polyacrylamide Gel Electrophoresis	5.40
10	Detection of DNA in Polyacrylamide Gels by Staining	5.47
11	Detection of DNA in Polyacrylamide Gels by Autoradiography	5.49
12	Isolation of DNA Fragments from Polyacrylamide Gels by the Crush and Soak Method	5.51
	Introduction to Pulsed-field Gel Electrophoresis (Protocols 13–20)	5.55
13	Preparation of DNA for Pulsed-field Gel Electrophoresis: Isolation of DNA from Mammalian Cells and Tissues	5.61
14	Preparation of DNA for Pulsed-field Gel Electrophoresis: Isolation of Intact DNA from Yeast	5.65
15	Restriction Endonuclease Digestion of DNA in Agarose Plugs	5.68
16	Markers for Pulsed-field Gel Electrophoresis	5.71
17	Pulsed-field Gel Electrophoresis via Transverse Alternating Field Electrophoresis Gels	5.74
	• Alternative Protocol: Silver Staining PFGE Gels	5.77
18	Pulsed-field Gel Electrophoresis via Contour-clamped Homogeneous Electric Field Gels	5.79
19	Direct Retrieval of DNA Fragments from Pulsed-field Gels	5.83
20	Retrieval of DNA Fragments from Pulsed-field Gels following DNA Concentration	5.86
		<b>5.1</b>

**E**LECTROPHORESIS THROUGH AGAROSE OR POLYACRYLAMIDE GELS lies near the heart of molecular cloning and is used to separate, identify, and purify DNA fragments. The technique is simple, rapid to perform, and capable of resolving fragments of DNA that cannot be separated adequately by other procedures, such as density gradient centrifugation. Furthermore, the location of DNA within the gel can be determined directly by staining with low concentrations of fluorescent intercalating dyes, such as ethidium bromide or SYBR Gold; bands containing as little as 20 pg of double-stranded DNA can be detected by direct examination of the gel in UV. If necessary, these bands of DNA can be recovered from the gel and used for a variety of purposes.

Agarose and polyacrylamide gels can be poured in a variety of shapes, sizes, and porosities and can be run in a number of different configurations. The choices within these parameters depend primarily on the sizes of the fragments being separated. Polyacrylamide gels are most effective for separating small fragments of DNA (5–500 bp). Their resolving power is extremely high, and fragments of DNA that differ in size by as little as 1 bp in length or by as little as 0.1% of their mass can be separated from one another. Although they can be run very rapidly and can accommodate comparatively large quantities of DNA, polyacrylamide gels have the disadvantage of being more difficult to prepare and handle than agarose gels. Polyacrylamide gels are run in a vertical configuration in a constant electric field.

Agarose gels have a lower resolving power than polyacrylamide gels, but they have a greater range of separation. DNAs from 50 bp to several megabases in length can be separated on agarose gels of various concentrations and configurations. Small DNA fragments (50–20,000 bp) are best resolved in agarose gels run in a horizontal configuration in an electric field of constant strength and direction. Under these conditions, the velocity of the DNA fragments decreases as their length increases and is proportional to electric field strength (McDonnell et al. 1977; Fangman 1978; Calladine et al. 1991). However, this simple relationship breaks down once the size of DNA fragments exceeds a maximum value, which is defined chiefly by the composition of the gel and the strength of the electric field (Hervet and Bean 1987). This limit of resolution is reached when the radius of gyration of the linear DNA duplex exceeds the pore size of the gel. The DNA can then no longer be sieved by the gel according to its size but must instead migrate “end-on” through the matrix as if through a sinuous tube. This mode of migration is known as “reptation.” Several mathematical descriptions of reptation have been published previously (please see Lerman and Frisch 1982; Lumpkin and Zimm 1982; Stellwagen 1983; Edmondson and Gray 1984; Slater and Noolandi 1985, 1986; Lalande et al. 1987).

The greater the pore size of the gel, the larger the DNA that can be sieved. Thus, agarose gels cast with low concentrations of agarose (0.1–0.2% w/v) are capable of resolving extremely large DNA molecules (Fangman 1978; Serwer 1980). However, such gels are extremely fragile and must be run for several days. Even then, they are incapable of resolving linear DNA molecules larger than 750 kb in length. The importance of this limitation becomes apparent with the realization that a single genetic locus (e.g., the human dystrophin locus) may occupy several thousand kilobases (several megabases) of DNA and that DNA molecules in the individual chromosomes of lower eukaryotes may be 7000 kb or more in length.

A solution to this problem was found in 1984, when Schwartz and Cantor reported the development of pulsed-field gel electrophoresis (PFGE). In this method, alternating orthogonal electric fields are applied to a gel. Large DNA molecules become trapped in their reptation tubes every time the direction of the electric field is altered and can make no further progress through the gel until they have reoriented themselves along the new axis of the electric field. The larger the DNA molecule, the longer the time required for this realignment. Molecules of DNA whose

reorientation times are less than the period of the electric pulse will therefore be fractionated according to size. The limit of resolution of PFGE depends on several factors, including:

- the degree of uniformity of the two electric fields
- the absolute lengths of the electric pulses
- the angles between the two electric fields
- the relative strength of the electric field

The original PFGE method described by Schwartz and Cantor (1984) was capable of resolving DNAs up to 2000 kb in length. However, as a consequence of improvements to the technique, resolution of DNA molecules larger than 6000 kb can now be achieved. These developments mean that PFGE can be used to determine the size of bacterial genomes and the numbers and sizes of chromosomes of simpler eukaryotes (e.g., *Neurospora crassa*, *Saccharomyces cerevisiae*, and *Schizosaccharomyces pombe*). For all organisms, from bacteria to humans, PFGE is used to study genome organization and to clone and analyze large fragments.

#### EARLY ANALYSIS OF DNA USING ELECTROPHORESIS

The idea of using electrophoresis through a supporting matrix to analyze DNA came from Vin Thorne, a biochemist/virologist who in the mid-1960s was working at the Institute of Virology in Glasgow. Thorne was interested in finding better ways to characterize the multiple forms of DNA that could be extracted from purified particles of polyomavirus. He reasoned that a combination of frictional and electrical forces would allow separation of DNA molecules that differed in shape or size. Using electrophoresis through agar gels, he was able to separate superhelical, nicked, and linear forms of polyomavirus DNA that had been radiolabeled with [<sup>3</sup>H]thymidine (Thorne 1966, 1967). In those days, viral and mitochondrial DNAs were the only intact genomes that could be prepared in pure form. Thorne's work therefore attracted little general interest until the early 1970s when restriction enzymes opened the possibility of analyzing larger DNAs, and a way was found to detect small quantities of nonradioactive DNA in gels.

The notion of using ethidium bromide to stain unlabeled DNA in gels seems to have occurred independently to two groups. The procedure used by Aaij and Borst (1972) involved immersing the gel in concentrated dye solution and a lengthy destaining process to reduce the background fluorescence. At Cold Spring Harbor Laboratory, a group of investigators had found that *Haemophilus parainfluenzae* contained two restriction activities and were attempting to separate the enzymes by ion-exchange chromatography. Searching for ways to assay column fractions rapidly, they decided to stain agarose gels containing fragments of SV40 DNA with low concentrations of ethidium bromide. They soon realized that the dye could be incorporated into the gel and running buffer without significantly affecting the migration of linear DNA fragments through the gel. The technique described in their paper (Sharp et al. 1973) is still widely used in an essentially unaltered form today.

Between 1972 and 1975, there was a vast increase in the use of agarose gels as investigators mapped cleavage sites on their favorite DNAs with the rapidly expanding suite of restriction enzymes. In those days, gels were cast in sawn-off glass pipettes and were run vertically in electrophoresis tanks attached to home-made Heathkit power packs. Each DNA sample was analyzed on a separate little cylindrical gel. The first modern electrophoresis apparatus was developed by Walter Schaffner, who was then a graduate student at Zurich. Realizing that the electrical resistance of an agarose gel is essentially the same as that of the surrounding buffer, Schaffner constructed horizontal tanks to hold submerged gels that could accommodate more than a dozen samples. Schaffner distributed the plans for these machines to anyone who asked for them. Once people got over their incredulity that his machines actually worked, cylindrical gels cast in little glass tubes rapidly disappeared, and the newer "submarine" gels took hold.

# Protocol 1

---

## Agarose Gel Electrophoresis

**A**GAROSE IS A LINEAR POLYMER COMPOSED OF ALTERNATING RESIDUES of D- and L-galactose joined by  $\alpha$ -(1 $\rightarrow$ 3) and  $\beta$ -(1 $\rightarrow$ 4) glycosidic linkages. The L-galactose residue has an anhydro bridge between the three and six positions (please see Figure 5-1). Chains of agarose form helical fibers that aggregate into supercoiled structures with a radius of 20–30 nm. Gelation of agarose results in a three-dimensional mesh of channels whose diameters range from 50 nm to >200 nm (Norton et al. 1986; for review, please see Kirkpatrick 1990).

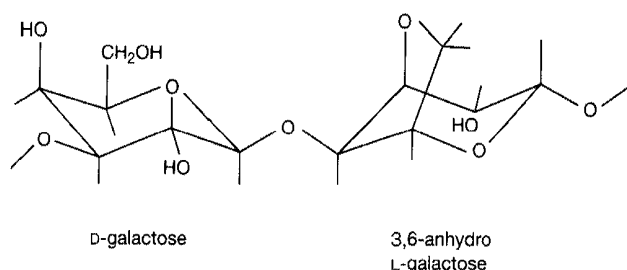
Commercially prepared agarose polymers are believed to contain ~800 galactose residues per chain. However, agarose is not homogeneous: The average length of the polysaccharide chains varies from batch to batch and from manufacturer to manufacturer. In addition, lower grades of agarose may be contaminated with other polysaccharides, as well as salts and proteins. This variability can affect the gelling/melting temperature of agarose solutions, the sieving of DNA, and the ability of the DNA recovered from the gel to serve as a substrate in enzymatic reactions. These potential problems can be minimized by using special grades of agarose that are screened for the presence of inhibitors and nucleases and for minimal background fluorescence after staining with ethidium bromide.

### THE RATE OF MIGRATION OF DNA THROUGH AGAROSE GELS

---

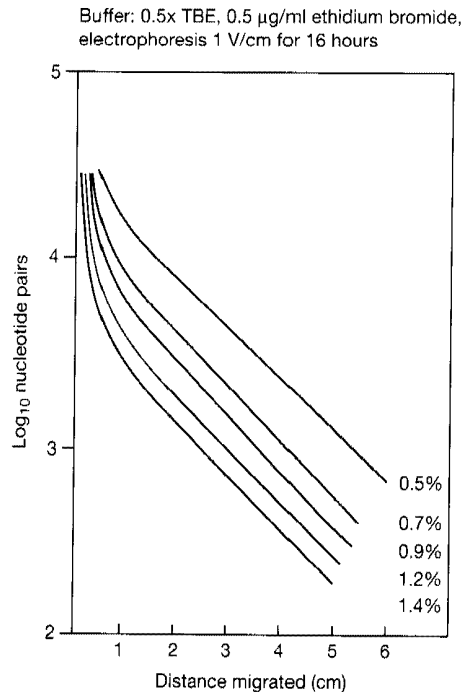
The following factors determine the rate of migration of DNA through agarose gels:

- **The molecular size of the DNA.** Molecules of double-stranded DNA migrate through gel matrices at rates that are inversely proportional to the  $\log_{10}$  of the number of base pairs (Helling et al. 1974). Larger molecules migrate more slowly because of greater frictional drag and because they worm their way through the pores of the gel less efficiently than smaller molecules.



**FIGURE 5.1** Chemical Structure of Agarose

---



**FIGURE 5-2** The Relationship between the Size of DNA and Its Electrophoretic Mobility

- **The concentration of agarose.** A linear DNA fragment of a given size migrates at different rates through gels containing different concentrations of agarose (please see Figure 5-2). There is a linear relationship between the logarithm of the electrophoretic mobility of the DNA ( $\mu$ ) and the gel concentration ( $t$ ) that is described by the equation:

$$\log \mu = \log \mu_0 - K_r t$$

where  $\mu_0$  is the free electrophoretic mobility of DNA and  $K_r$  is the retardation coefficient, a constant related to the properties of the gel and the size and shape of the migrating molecules.

- **The conformation of the DNA.** Superhelical circular (form I), nicked circular (form II), and linear (form III) DNAs migrate through agarose gels at different rates (Thorne 1966, 1967). The relative mobilities of the three forms depend primarily on the concentration and type of agarose used to make the gel, but they are also influenced by the strength of the applied current, the ionic strength of the buffer, and the density of superhelical twists in the form I DNA (Johnson and Grossman 1977). Under some conditions, form I DNA migrates faster than form III DNA; under other conditions, the order is reversed. In most cases, the best way to distinguish between the different conformational forms of DNA is simply to include in the gel a sample of untreated circular DNA and a sample of the same DNA that has been linearized by digestion with a restriction enzyme that cleaves the DNA in only one place.
- **The presence of ethidium bromide in the gel and electrophoresis buffer.** Intercalation of ethidium bromide causes a decrease in the negative charge of the double-stranded DNA and an increase in both its stiffness and length. The rate of migration of the linear DNA-dye complex through gels is consequently retarded by a factor of ~15% (Sharp et al. 1973).
- **The applied voltage.** At low voltages, the rate of migration of linear DNA fragments is proportional to the voltage applied. However, as the strength of the electric field is raised, the mobility of high-molecular-weight fragments increases differentially. Thus, the effective range

TABLE 5-1 Properties of Different Types of Agaroses

TYPE OF AGAROSE	GELLING TEMPERATURE (°C)	MELTING TEMPERATURE (°C)	COMMERCIAL NAMES
<i>Standard agaroses</i>			
low EEO isolated from <i>Gelidium</i> spp.	35–38	90–95	SeaKem LE (BioWhittaker) Agarose-LE (USB) Low EEO Agarose (Stratagene) Molecular Biology Certified Grade (Bio-Rad)
<i>Standard agaroses</i>			
low EEO isolated from <i>Gracilaria</i> spp.	40–42	85–90	SeaKem HGT (BioWhittaker) Agarose-HGT (USB)
<i>High-gel-strength agaroses</i>			
	34–43	85–95	FastLane (BioWhittaker) SeaKem Gold (BioWhittaker) Chromosomal Grade Agarose (Bio-Rad)
<i>Low melting/gelling temperature (modified) agaroses</i>			
low melting	25–35	63–65	SeaPlaque (BioWhittaker)
	35	65	NuSieve GTG (BioWhittaker)
ultra-low melting	8–15	40–45	SeaPrep (BioWhittaker)
<i>Low-viscosity, low melting/gelling temperature agaroses</i>			
	25–30	70	InCert (BioWhittaker)
	38	85	NuSieve 3:1 (BioWhittaker)
	30	75	Agarose HS (BioWhittaker)

of separation in agarose gels decreases as the voltage is increased. To obtain maximum resolution of DNA fragments >2 kb in size, agarose gels should be run at no more than 5–8 V/cm.

- **The type of agarose.** The two major classes of agarose are standard agaroses and low-melting-temperature agaroses (Kirkpatrick 1990). A third and growing class consists of intermediate melting/gelling temperature agaroses, exhibiting properties of each of the two major classes. Within each class are various types of agaroses that are used for specialized applications, please

TABLE 5-2 Range of Separation of DNA Fragments through Different Types of Agaroses

AGAROSE (%)	SIZE RANGE OF DNA FRAGMENTS RESOLVED BY VARIOUS TYPES OF AGAROSSES			
	STANDARD	HIGH GEL STRENGTH	LOW GELLING/MELTING TEMPERATURE	LOW GELLING/MELTING TEMPERATURE LOW VISCOSITY
0.3				
0.5	700 bp to 25 kb			
0.8	500 bp to 15 kb	800 bp to 10 kb	800 bp to 10 kb	
1.0	250 bp to 12 kb	400 bp to 8 kb	400 bp to 8 kb	
1.2	150 bp to 6 kb	300 bp to 7 kb	300 bp to 7 kb	
1.5	80 bp to 4 kb	200 bp to 4 kb	200 bp to 4 kb	
2.0		100 bp to 3 kb	100 bp to 3 kb	
3.0			500 bp to 1 kb	
4.0				500 bp to 1 kb
4.0				100 bp to 500 bp
6.0				10 bp to 100 bp

see Tables 5-1 and 5-2 and the accompanying panel, **CLASSES OF AGAROSE AND THEIR PROPERTIES**.

- **The electrophoresis buffer.** The electrophoretic mobility of DNA is affected by the composition and ionic strength of the electrophoresis buffer. In the absence of ions (e.g., if water is substituted for electrophoresis buffer in the gel or in the reservoirs), electrical conductivity is minimal

#### CLASSES OF AGAROSE AND THEIR PROPERTIES

- **Standard (high-melting-temperature) agaroses** are manufactured from two species of seaweed: *Gelidium* and *Gracilaria*. These agaroses differ in their gelling and melting temperatures, but, for practical purposes, agaroses from either source can be used to analyze and isolate fragments of DNA ranging in size from 1 kb to 25 kb. Several commercial grades of agaroses have been tested that (1) display minimal background fluorescence after staining with ethidium bromide, (2) are free of DNase and RNase, (3) display minimal inhibition of restriction endonucleases and ligase, and (4) generate modest amounts of electroendo-osmotic flow (EEO; please see below).

Newer types of standard agarose combine high gel strength with low EEO, allowing gels to be cast with agarose concentrations as low as 0.3%. These gels can be used in conventional electrophoresis to separate high-molecular-weight DNA (up to 60 kb). At any concentration of these new agaroses, the speed of migration of the DNA is increased by 10–20% over that achieved using the former standard agaroses, depending on buffer type and concentration. This increase can lead to significant savings of time in PFGE of megabase-sized DNA.

- **Low melting/gelling temperature agaroses** have been modified by hydroxyethylation and therefore melt at temperatures lower than those of standard agaroses. The degree of substitution determines the exact melting and gelling temperature. Low melting/gelling temperature agaroses are used chiefly for rapid recovery of DNA, as most agaroses of this type melt at temperatures (~65°C) that are significantly lower than the melting temperature of duplex DNA. This feature allows for simple purification, enzymatic processing (restriction endonuclease digestion/ligation) of DNA; and allows bacterial transformation with nucleic acids directly in the remelted gel. As is the case with standard agaroses, manufacturers provide grades of low-melting-temperature agaroses that have been tested to display minimal background fluorescence after staining with ethidium bromide, to be free of DNase and RNase activity, and to display minimal inhibition of restriction endonucleases and ligase. Low-melting-temperature agaroses not only melt, but also gel at low temperatures. This property allows them to be held as liquids in the 30–35°C range, so that cells can be embedded without damage. This treatment is useful in preparing and embedding chromosomal DNA in agarose blocks before analysis by PFGE (please see Protocols 13 and 14).

Chemically modified agarose has significantly more sieving capacity than an equivalent concentration of standard agarose (please see Tables 5-1 and 5-2). This finding has been exploited to make agaroses that approach polyacrylamide in their resolving power and are therefore useful for separation of polymerase chain reaction (PCR) products, small DNA fragments, and small RNAs <1 kb. It is now possible to resolve DNA down to 4 bp and to separate DNAs in the 200–800-bp range that differ in size by 2% (please see Table 5-2).

Because of the variation in products from manufacturer to manufacturer, it is advisable to read the supplier's catalog to obtain more precise information about specific brands of agarose.

- **Electroendo-osmosis.** In agarose gels, the speed at which nucleic acids migrate toward the positive electrode is affected by a electroendo-osmosis. This process is due to ionized acidic groups (usually sulfate) attached to the polysaccharide matrix of the agarose gel. The acidic groups induce positively charged counterions in the buffer that migrate through the gel toward the negative electrode, causing a bulk flow of liquid that migrates in a direction opposite to that of the DNA.

The higher the density of negative charge on the agarose, the greater the EEO flow and the poorer the separation of nucleic acid fragments. Retardation of small DNA fragments (<10 kb) is minor, but larger DNA molecules can be significantly retarded, especially in PFGE. To avoid problems, it is best to purchase agarose from reputable merchants and to use types of agarose that display low levels of EEO. Agaroses that are sold as "zero" EEO are undesirable for two reasons: They have been chemically modified by adding positively charged groups, which neutralize the sulfated polysaccharides in the gel but may inhibit subsequent enzyme reactions, and they have been adulterated by adding locust bean gum, which retards expulsion of water from the gel (Kirkpatrick 1990).



and DNA migrates slowly, if at all. In buffer of high ionic strength (e.g., if 10x electrophoresis buffer is mistakenly used), electrical conductance is very efficient and significant amounts of heat are generated, even when moderate voltages are applied. In the worst case, the gel melts and the DNA denatures. For details of commonly used electrophoresis buffers, please see Table 5-3.

## ELECTROPHORESIS BUFFERS

Several different buffers are available for electrophoresis of native, double-stranded DNA. These contain Tris-acetate and EDTA (pH 8.0; TAE) (also called E buffer), Tris-borate (TBE), or Tris-phosphate (TPE) at a concentration of ~50 mM (pH 7.5–7.8). Electrophoresis buffers are usually made up as concentrated solutions and stored at room temperature (please see Table 5-3).

All of these buffers work well, and the choice among them is largely a matter of personal preference. TAE has the lowest buffering capacity of the three and will become exhausted if electrophoresis is carried out for prolonged periods of time. When this happens, the anodic portion of the gel becomes acidic and the bromophenol blue migrating through the gel toward the anode changes in color from bluish-purple to yellow. This change begins at pH 4.6 and is complete at pH 3.0. Exhaustion of TAE can be avoided by periodic replacement of the buffer during electrophoresis or by recirculation of the buffer between the two reservoirs. Both TBE and TPE are slightly more expensive than TAE, but they have significantly higher buffering capacity. Double-stranded linear DNA fragments migrate ~10% faster through TAE than through TBE or TPE; the resolving power of TAE is slightly better than TBE or TPE for high-molecular-weight DNAs and worse for low-molecular-weight DNAs. This difference probably explains the observation that electrophoresis in TAE yields better resolution of DNA fragments in highly complex mixtures such as mammalian DNA. For this reason, Southern blots used to analyze complex genomes are generally derived from gels prepared in and run with TAE as the electrophoresis buffer. The resolution of supercoiled DNAs is better in TAE than in TBE.

**TABLE 5-3 Electrophoresis Buffers**

BUFFER	WORKING SOLUTION	STOCK SOLUTION/LITER
TAE	1x 40 mM Tris-acetate 1 mM EDTA	50x 242 g of Tris base 57.1 ml of glacial acetic acid 100 ml of 0.5 M EDTA (pH 8.0)
TPE	1x 90 mM Tris-phosphate 2 mM EDTA	10x 108 g of Tris base 15.5 ml of phosphoric acid (85%, 1.679 g/ml) 40 ml of 0.5 M EDTA (pH 8.0)
TBE <sup>a</sup>	0.5x 45 mM Tris-borate 1 mM EDTA	5x 54 g of Tris base 27.5 g of boric acid 20 ml of 0.5 M EDTA (pH 8.0)

<sup>a</sup>TBE is usually made and stored as a 5x or 10x stock solution. The pH of the concentrated stock buffer should be ~8.3. Dilute the concentrated stock buffer just before use and make the gel solution and the electrophoresis buffer from the same concentrated stock solution. Some investigators prefer to use more concentrated stock solutions of TBE (10x as opposed to 5x). However, 5x stock solution is more stable because the solutes do not precipitate during storage. Passing the concentrated buffer stocks through a 0.45- $\mu$ m filter can prevent or delay formation of precipitates.

**TABLE 5-4 6x Gel-loading Buffers**

BUFFER TYPE	6X BUFFER	STORAGE TEMPERATURE
I	0.25% bromophenol blue 0.25% xylene cyanol FF 40% (w/v) sucrose in H <sub>2</sub> O	4°C
II	0.25% bromophenol blue 0.25% xylene cyanol FF 15% Ficoll (Type 400; Pharmacia) in H <sub>2</sub> O	room temperature
III	0.25% bromophenol blue 0.25% xylene cyanol FF 30% glycerol in H <sub>2</sub> O	4°C
IV	0.25% bromophenol blue 40% (w/v) sucrose in H <sub>2</sub> O	4°C

## GEL-LOADING BUFFERS

Gel-loading buffers are mixed with the samples before loading into the slots of the gel. These buffers serve three purposes: They increase the density of the sample, ensuring that the DNA sinks evenly into the well; they add color to the sample, thereby simplifying the loading process; and they contain dyes that, in an electric field, move toward the anode at predictable rates. Bromophenol blue migrates through agarose gels ~2.2-fold faster than xylene cyanol FF, independent of the agarose concentration. Bromophenol blue migrates through agarose gels run in 0.5x TBE at approximately the same rate as linear double-stranded DNA 300 bp in length, whereas xylene cyanol FF migrates at approximately the same rate as linear double-stranded DNA 4 kb in length. These relationships are not significantly affected by the concentration of agarose in the gel over the range of 0.5–1.4%. Which type of loading dye to use is a matter of personal preference; various recipes are presented in Table 5-4.

## MATERIALS

**CAUTION:** Please see Appendix 12 for appropriate handling of materials marked with <!.>.

### Buffers and Solutions

**Please see Appendix 1 for components of stock solutions, buffers, and reagents. Dilute stock solutions to the appropriate concentrations.**

#### *Agarose solutions (Tables 5-1 and 5-2)*

Agarose gels are cast by melting the agarose in the presence of the desired buffer until a clear, transparent solution is achieved. The melted solution is then poured into a mold and allowed to harden. Upon hardening, the agarose forms a matrix, the density of which is determined by the concentration of the agarose. For rapid analysis of DNA samples, the use of a minigel is recommended (please see the panel on **ELECTROPHORESIS THROUGH MINIGELS** below Step 13).

#### *Electrophoresis buffer (usually 1x TAE or 0.5x TBE)*

Please see Table 5-3 for recipes.

#### *Ethidium bromide <!.> or SYBR Gold staining solution <!.>*

For a discussion of staining DNA in agarose gels, please see Protocol 2.

#### *6x Gel-loading buffer*

Please see Table 5-4 for recipes.

## Nucleic Acids and Oligonucleotides

### *DNA samples*

### *DNA size standards*

Samples of DNAs of known size are typically generated by restriction enzyme digestion of a plasmid or bacteriophage DNA of known sequence. Alternatively, they are produced by ligating a monomer DNA fragment of known size into a ladder of polymeric forms. Size standards for both agarose and polyacrylamide gel electrophoresis may be purchased from commercial sources or they can be prepared easily in the laboratory. It is a good idea to have two size ranges of standards, including a high-molecular-weight range from 1 kb to >20 kb and a low-molecular-weight range from 100 bp to 1000 bp. A stock solution of size standards can be prepared by dilution with a gel-loading buffer and then used as needed in individual electrophoresis experiments.

## Special Equipment

### *Equipment for agarose gel electrophoresis*

Clean, dry horizontal electrophoresis apparatus with chamber and comb, or clean dry glass plates with appropriate comb.

### *Gel-sealing tape*

Common types of lab tape, such as Time tape or VWR lab tape, are appropriate for sealing the ends of the agarose gel during pouring.

### *Microwave oven or Boiling water bath*

Power supply device capable of up to 500 V and 200 mA.

Water bath preset to 55°C

## METHOD

---

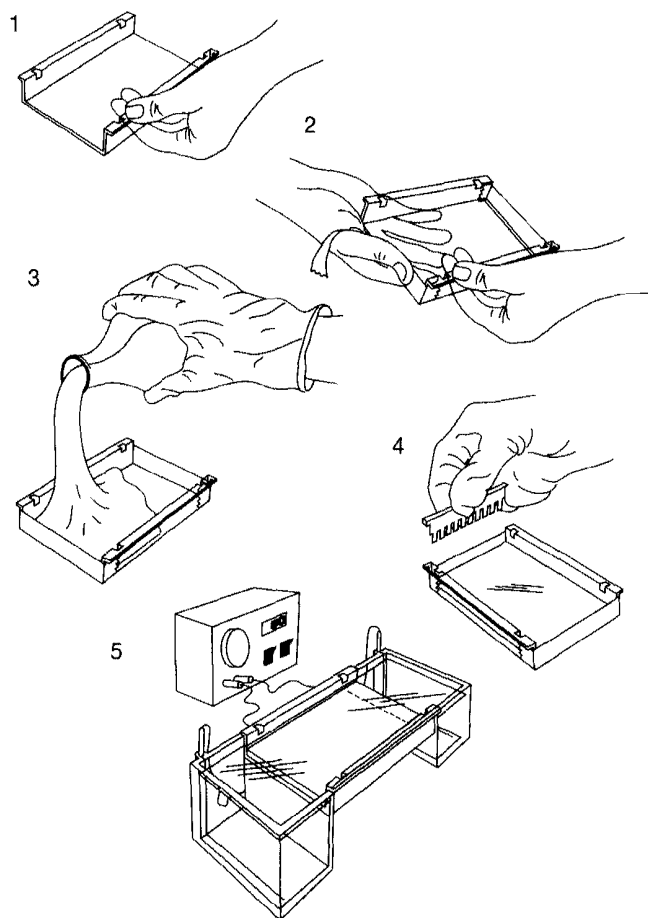
1. Seal the edges of a clean, dry glass plate (or the open ends of the plastic tray supplied with the electrophoresis apparatus) with tape to form a mold (Figure 5-3). Set the mold on a horizontal section of the bench.
2. Prepare sufficient electrophoresis buffer (usually 1× TAE or 0.5× TBE) to fill the electrophoresis tank and to cast the gel.

It is important to use the same batch of electrophoresis buffer in both the electrophoresis tank and the gel. Small differences in ionic strength or pH create fronts in the gel that can greatly affect the mobility of DNA fragments. When measuring the sizes of unknown DNAs, ensure that all samples are applied to the gel in the same buffer. The high concentrations of salt in certain restriction enzyme buffers (e.g., *Bam*HI and *Eco*RI) retard the migration of DNA and distort the electrophoresis of DNA in the adjacent wells.

3. Prepare a solution of agarose in electrophoresis buffer at a concentration appropriate for separating the particular size fragments expected in the DNA sample(s): Add the correct amount of powdered agarose (please see Table 5-5) to a measured quantity of electrophoresis buffer in an Erlenmeyer flask or a glass bottle.

The buffer should occupy less than 50% of the volume of the flask or bottle.

The concentrations of agarose required to separate DNAs in different size ranges is given in Table 5-2. DNAs differing in size by only a few base pairs can be separated when certain high-resolution agaroses (e.g., MetaPhor agarose, BioWhittaker) are used to cast the gel. Alternatively, modified polysaccharides (commercially available) can be added to regular agarose to enhance separation. This substance, used at a concentration of 0.5–2.0% (w/v), together with agarose, increases resolution, renders the cast gel more clear, and increases the strength of the gel.



**FIGURE 5-3 Pouring a Horizontal Agarose Gel**

- Loosely plug the neck of the Erlenmeyer flask with Kimwipes. If using a glass bottle, make certain the cap is loose. Heat the slurry in a boiling-water bath or a microwave oven until the agarose dissolves.

▲ **WARNING** The agarose solution can become superheated and may boil violently if it is heated for too long in the microwave oven.

Heat the slurry for the minimum time required to allow all of the grains of agarose to dissolve. Undissolved agarose appears as small “lenses” or translucent chips floating in the solution. Wear an oven mitt and carefully swirl the bottle or flask from time to time to make sure that any unmelted grains of agarose sticking to the walls enter the solution. Longer heating times are required to dissolve higher concentrations of agarose completely. Check that the volume of the solution has not been decreased by evaporation during boiling; replenish with H<sub>2</sub>O if necessary.

- Use insulated gloves or tongs to transfer the flask/bottle into a water bath at 55°C. When the molten gel has cooled, add ethidium bromide to a final concentration of 0.5 µg/ml. Mix the gel solution thoroughly by gentle swirling.

▲ **IMPORTANT** SYBR Gold should not be added to the molten gel solution. Please see Protocol 2 for further discussion.

When preparing gels in plastic (lucite) trays, it is important to cool the melted agarose solution to <60°C before casting the gel. Hotter solutions warp and craze the trays. At one time, solutions con-

**TABLE 5-5** Range of Separation in Gels Containing Different Amounts of Standard Low-EEO Agarose

AGAROSE CONCENTRATION IN GEL (% [W/V])	RANGE OF SEPARATION OF LINEAR DNA MOLECULES (kb)
0.3	5–60
0.6	1–20
0.7	0.8–10
0.9	0.5–7
1.2	0.4–6
1.5	0.2–3
2.0	0.1–2

taining high concentrations of agarose (2% or above) were stored at 70°C to prevent premature gelling. However, this treatment has become unnecessary because of improvements in the methods used to purify and prepare standard agaroses.

6. While the agarose solution is cooling, choose an appropriate comb for forming the sample slots in the gel. Position the comb 0.5–1.0 mm above the plate so that a complete well is formed when the agarose is added to the mold.

Most apparatuses have side walls or outside “legs” that allow appropriate placement of the comb. If this is not the case, and if the comb is too close to the glass plate, the base of the well may tear when the comb is withdrawn, causing samples to leak between the gel and the glass plate. This problem is more common when low concentrations of agarose (<0.6%) or low-gelling-temperature agarose are used.

7. Pour the warm agarose solution into the mold.

The gel should be between 3 mm and 5 mm thick. Check that no air bubbles are under or between the teeth of the comb. Air bubbles present in the molten gel can be removed easily by poking them with the corner of a Kimwipe.

When preparing gels that contain low concentrations of agarose (<0.5%), first pour a supporting gel (1% agarose) without wells. Allow this gel to harden at room temperature on the glass plate or plastic tray, and then pour the lower-percentage gel directly on top of the supporting gel. Stacking the gels in this way reduces the chance that the lower-percentage gel will fracture during subsequent manipulations (e.g., photography and processing for Southern hybridization). Make sure that both gels are made from the same batch of buffer and contain the same concentration of ethidium bromide. Gels cast with low-melting-temperature agarose and gels that contain less than 0.5% agarose can also be chilled to 4°C and run in a cold room to reduce the chance of fracture.

8. Allow the gel to set completely (30–45 minutes at room temperature), then pour a small amount of electrophoresis buffer on the top of the gel, and carefully remove the comb. Pour off the electrophoresis buffer and carefully remove the tape. Mount the gel in the electrophoresis tank.

9. Add just enough electrophoresis buffer to cover the gel to a depth of ~1 mm.

It is not necessary to prerun an agarose gel before the samples are loaded.

10. Mix the samples of DNA with 0.20 volume of the desired 6x gel-loading buffer (please see Table 5-4).

The maximum amount of DNA that can be applied to a slot depends on the number of fragments in the sample and their sizes. The minimum amount of DNA that can be detected by photography of ethidium-bromide-stained gels is ~2 ng in a 0.5-cm-wide band (the usual width of a slot). More sensitive dyes such as SYBR Gold can detect as little as 20 pg of DNA in a band. If there is more than 500 ng of DNA in a band of 0.5 cm, the slot will be overloaded, resulting in trailing, smearing, and smearing — problems that become more severe as the size of the DNA increases. When simple populations of DNA molecules (e.g., bacteriophage  $\lambda$  or plasmid DNAs) are to be analyzed, 100–500 ng of DNA should be loaded per 0.5-cm slot. When the sample consists of a very large number of DNA fragments of different sizes (e.g., restriction digests of mammalian DNA), however, it is possible to load 20–30  $\mu$ g of DNA per slot without significant loss of resolution.

The maximum volume of solution that can be loaded is determined by the dimensions of the slot. (A typical slot [0.5 × 0.5 × 0.15 cm] will hold about 40 µl). Do not overfill a slot with a DNA sample solution. To reduce the possibility of contaminating neighboring samples, it is best to make the gel a little thicker or to concentrate the DNA by ethanol precipitation rather than to fill the slot completely.

11. Slowly load the sample mixture into the slots of the submerged gel using a disposable micropipette, an automatic micropipettor, or a drawn-out Pasteur pipette or glass capillary tube. Load size standards into slots on both the right and left sides of the gel.

For many purposes, it is not necessary to use a fresh pipette tip for every sample as long as the tip is thoroughly washed with buffer from the anodic chamber between samples. However, if the gel is to be analyzed by Southern hybridization or if bands of DNA are to be recovered from the gel, it is sensible to use a separate pipette tip for every sample.

12. Close the lid of the gel tank and attach the electrical leads so that the DNA will migrate toward the positive anode (red lead). Apply a voltage of 1–5 V/cm (measured as the distance between the positive and negative electrodes). If the leads have been attached correctly, bubbles should be generated at the anode and cathode (due to electrolysis), and within a few minutes, the bromophenol blue should migrate from the wells into the body of the gel. Run the gel until the bromophenol blue and xylene cyanol FF have migrated an appropriate distance through the gel.

The presence of ethidium bromide allows the gel to be examined by UV illumination at any stage during electrophoresis. The gel tray may be removed and placed directly on a transilluminator. Alternatively, the gel may be examined using a hand-held source of UV light. In either case, turn off the power supply before examining the gel!

During electrophoresis, the ethidium bromide migrates toward the cathode (in the direction opposite to that of the DNA). Electrophoresis for protracted periods of time can result in the loss of significant amounts of ethidium bromide from the gel, making detection of small fragments difficult. In this case, restain the gel by soaking it for 30–45 minutes in a solution of ethidium bromide (0.5 µg/ml) as described in Protocol 2.

13. When the DNA samples or dyes have migrated a sufficient distance through the gel, turn off the electric current and remove the leads and lid from the gel tank. If ethidium bromide is present in the gel and electrophoresis buffer, examine the gel by UV light and photograph the gel as described in Protocol 2 and as shown in Figure 5-4. Otherwise, stain the gel by immersing it in electrophoresis buffer or H<sub>2</sub>O containing ethidium bromide (0.5 µg/ml) for 30–45 minutes at room temperature or by soaking in a 1:10,000-fold dilution of SYBR Gold stock solution in electrophoresis buffer.

For further details on staining and photography of DNA in gels, please see Protocol 2.

#### **ELECTROPHORESIS THROUGH MINIGELS**

During the last several years, methods have been developed for analyzing small quantities of DNA very rapidly using agarose minigels. Several types of miniature electrophoresis tanks are manufactured commercially, typically as smaller versions of the companies' larger electrophoresis models. Each gel slot holds 3–12 µl of sample, depending on the thickness of the gel and the width of the teeth of the comb. Usually, 10–100 ng of DNA in the gel-loading buffer of choice is applied to a slot. The gel is then run for 30–60 minutes at high voltage (5–20 V/cm) until the bromophenol blue and xylene cyanol FF have migrated the appropriate distance. The gel is then photographed as described in Protocol 2.

Minigels are particularly useful when a rapid answer is required before the next step in a cloning protocol can be undertaken. Because the wells are smaller and the gels thinner, less DNA than normal is required for visualization. In addition, because the gels can be prepared in advance and run rapidly, and because they require smaller amounts of reagents, there are considerable savings in both time and money. Many investigators prepare one gel at the beginning of the week, and use it over and over again through the course of an experiment. Thus, a particular set of samples may be loaded, run out onto the gel, and visualized. The gel then may be "erased" by running the samples off the gel into the buffer. Note that minigels are best suited for the analysis of small DNA fragments (<3 kb). Larger fragments resolve poorly because of the high voltages that are generally used and the comparatively short length of the gel.

# Protocol 2

---

## Detection of DNA in Agarose Gels

**N**UCLEIC ACIDS THAT HAVE BEEN SUBJECTED TO ELECTROPHORESIS through agarose gels may be detected by staining and visualized by illumination with 300-nm UV light. Methods for staining and visualization of DNA using either ethidium bromide or SYBR Gold are described here; for further details on detection of nucleic acids, please see the discussion on the Quantitation of Nucleic Acids in Appendix 8.

### STAINING DNA IN GELS USING ETHIDIUM BROMIDE

---

The most convenient and commonly used method to visualize DNA in agarose gels is staining with the fluorescent dye ethidium bromide (Sharp et al. 1973), which contains a tricyclic planar group that intercalates between the stacked bases of DNA. Ethidium bromide binds to DNA with little or no sequence preference. At saturation in solutions of high ionic strength, approximately one ethidium molecule is intercalated per 2.5 bp (Waring 1965). After insertion into the helix, the dye lies perpendicular to the helical axis and makes van der Waals contacts with the base pairs above and below. The fixed position of the planar group and its close proximity to the bases cause dye bound to DNA to display an increased fluorescent yield compared to that of dye in free solution. UV radiation at 254 nm is absorbed by the DNA and transmitted to the dye; radiation at 302 nm and 366 nm is absorbed by the bound dye itself. In both cases, the energy is re-emitted at 590 nm in the red-orange region of the visible spectrum (LePecq and Paoletti 1967). Because the fluorescent yield of ethidium bromide–DNA complexes is ~20–30-fold greater than that of unbound dye, bands containing as little as ~10 ng of DNA can be detected in the presence of free ethidium bromide (0.5 µg/ml) in the gel.

Ethidium bromide was synthesized in the 1950s in an effort to develop phenanthridine compounds as effective trypanocidal agents. Ethidium emerged from the screening program with flying colors. It was 10–50-fold more effective against trypanosomes than the parent compound, was no more toxic to mice, and, unlike earlier phenanthridines, did not induce photosensitization in cattle (Watkins and Woolfe 1952). Ethidium bromide is still used for the treatment and prophylaxis of trypanomiasis in cattle in tropical and subtropical countries.

Ethidium bromide can be used to detect both single- and double-stranded nucleic acids (both DNA and RNA). However, the affinity of the dye for single-stranded nucleic acid is relatively low and the fluorescent yield is comparatively poor. In fact, most fluorescence associated with staining single-stranded DNA or RNA is attributable to binding of the dye to short

intrastrand duplexes in the molecules. For additional details on ethidium bromide, please see the information panel on **ETHIDIUM BROMIDE** in Chapter 1.

Ethidium bromide is prepared as a stock solution of 10 mg/ml in H<sub>2</sub>O, which is stored at room temperature in dark bottles or bottles wrapped in aluminum foil. The dye is usually incorporated into agarose gels and electrophoresis buffers at a concentration of 0.5 µg/ml. Note that polyacrylamide gels cannot be cast with ethidium bromide because it inhibits polymerization of the acrylamide. Acrylamide gels are therefore stained with the ethidium solution after the gel has been run (please see Protocol 10).

Although the electrophoretic mobility of linear double-stranded DNA is reduced by ~15% in the presence of the dye, the ability to examine the agarose gels directly under UV illumination during or at the end of the run is a great advantage. However, sharper DNA bands are obtained when electrophoresis is carried out in the absence of ethidium bromide. Thus, when an accurate size of a particular fragment of DNA is to be established (e.g., when a restriction endonuclease map is being determined for a fragment of DNA), the agarose gel should be run in the absence of ethidium bromide and stained after electrophoresis is complete. Staining is accomplished by immersing the gel in electrophoresis buffer or H<sub>2</sub>O containing ethidium bromide (0.5 µg/ml) for 30–45 minutes at room temperature. Destaining is not usually required. However, detection of very small amounts (<10 ng) of DNA is made easier if the background fluorescence caused by unbound ethidium bromide is reduced by soaking the stained gel in H<sub>2</sub>O or 1 mM MgSO<sub>4</sub> for 20 minutes at room temperature.

## STAINING DNA IN GELS USING SYBR GOLD

SYBR Gold is the trade name of a new ultrasensitive dye with high affinity for DNA and a large fluorescence enhancement upon binding to nucleic acid. The quantum yield of the SYBR Gold–DNA complex is greater than that of the equivalent ethidium bromide–DNA complex and the fluorescence enhancement is >1000 times greater. As a result, <20 pg of double-stranded DNA can be detected in an agarose gel (up to 25 times less than the amount visible after ethidium bromide staining). In addition, staining of agarose or polyacrylamide gels with this dye can reveal as little as 100 pg of single-stranded DNA in a band or 300 pg of RNA. SYBR Gold shows maximum excitation at 495 nm and has a secondary excitation peak at 300 nm. Fluorescent emission occurs at 537 nm. For additional details on SYBR Gold, please see the panel below.

### SYBR GOLD

SYBR Gold is a proprietary fluorescent unsymmetrical cyanine dye, sold by Molecular Probes, that is used to stain single- and double-stranded nucleic acids in gels. Although far more expensive, SYBR Gold has several advantages over phenanthridine dyes such as ethidium bromide. It is more sensitive and can be used to stain both DNA and RNA in conventional neutral polyacrylamide and agarose gels and in gels containing denaturants, such as urea, glyoxal, and formaldehyde. When excited by standard transillumination at 300 nm, SYBR Gold gives rise to bright gold fluorescent signals that can be captured on conventional black and white Polaroid film or on charged couple device (CCD)-based image detection systems. Gels are stained with SYBR Gold after electrophoresis is complete. The level of background fluorescence is so low that no destaining is required. The stained nucleic acid can be transferred directly to membranes for northern or Southern hybridization. SYBR Gold may be removed from nucleic acids recovered from gels by ethanol precipitation.

SYBR Gold is supplied as a 10,000x concentrate in anhydrous dimethylsulfoxide (DMSO). The high cost of the dye precludes its use for routine staining of gels. However, the dye may be cost-effective as an alternative to using radiolabeled DNAs in techniques such as single-strand conformation polymorphism (SSCP) and denaturing gradient gel electrophoresis (DGGE).



SYBR Gold is used to stain DNA by soaking the gel, after separation of the DNA fragments, in a 1:10,000-fold dilution of the stock dye solution. SYBR Gold should not be added to the molten agarose or to the gel before electrophoresis, because its presence in the hardened gel will cause severe distortions in the electrophoretic properties of the DNA and RNA.

The greatest sensitivity is obtained when the gel is illuminated with UV light at 300 nm. Photography is carried out as described below with green or yellow filters. The dye is sensitive to fluorescent light, and working solutions containing SYBR Gold (1:10,000 dilution of the stock solution supplied by Molecular Probes) should be freshly made daily in electrophoresis buffer and stored at room temperature.

## PHOTOGRAPHY OF DNA IN GELS

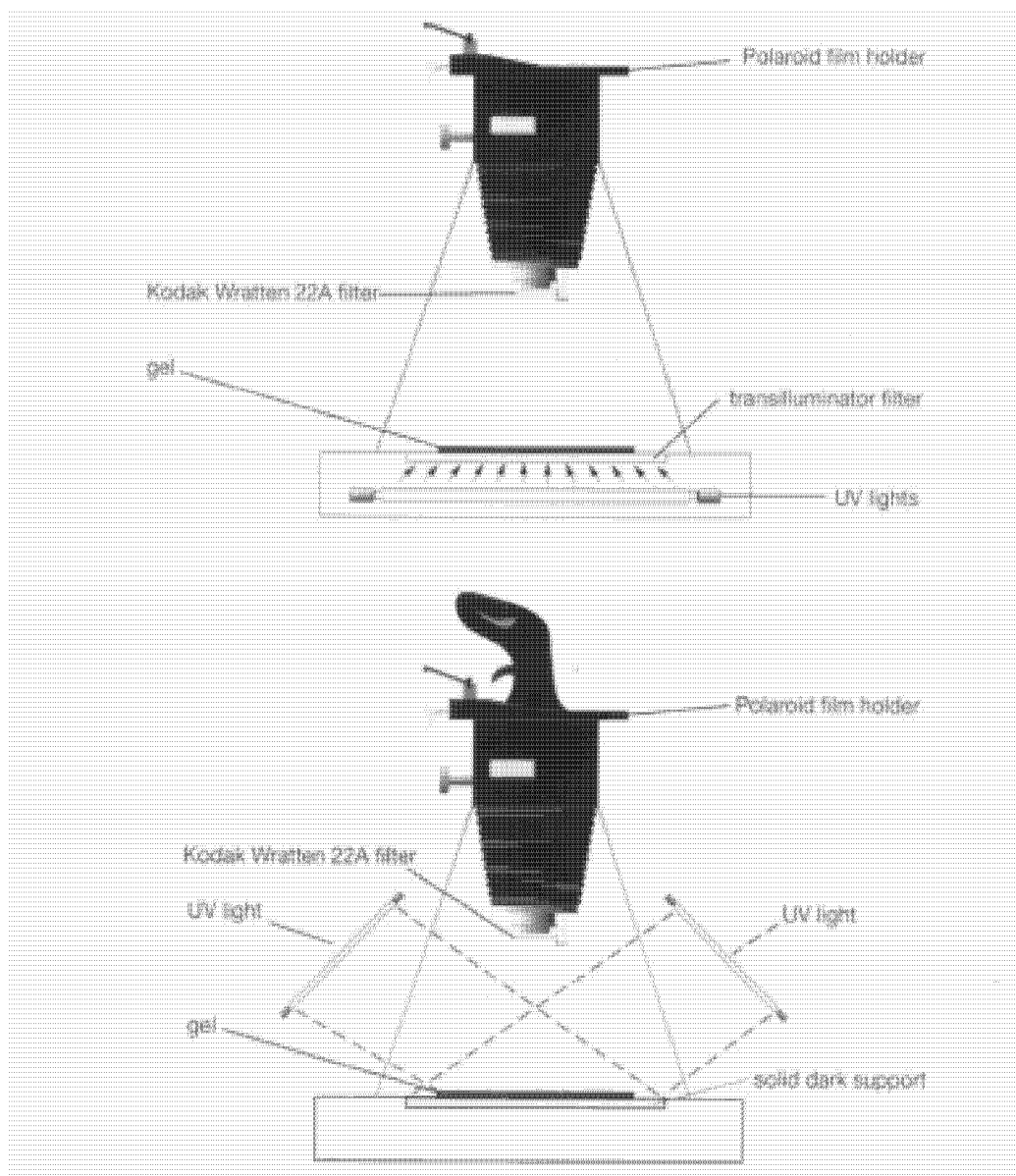
---

Photographs of ethidium-bromide-stained gels may be made using transmitted or incident UV light (please see Figure 5-4). Most commercially available devices (transilluminators) emit UV light at 302 nm. The fluorescent yield of ethidium bromide-DNA complexes is considerably greater at this wavelength than at 366 nm and slightly less than at short-wavelength (254 nm) light. However, the amount of nicking of the DNA is much less at 302 nm than at 254 nm (Brunk and Simpson 1977).

Today, images of ethidium-bromide-stained gels may be captured by integrated systems containing light sources, fixed-focus digital cameras, and thermal printers. The CCD cameras of these systems use a wide-angle zoom lens ( $f = 75$  mm) that allows the detection of very small amounts of ethidium-bromide-stained DNA (0.01–0.5 ng is claimed). In the more advanced systems, gel images are directly transmitted to a computer and visualized in real time. The image can be manipulated on screen with respect to field, focus, and cumulative exposure time prior to printing. Individual images can be printed, saved, and stored electronically in several file formats and further manipulated with image analysis software programs. The average file size for a stained agarose gel image is ~0.3 Mb; thus, extensive archiving requires large-capacity storage systems. Although individual printouts cost only a few pennies compared to ~1 dollar for a Polaroid photograph (please see below), the hardware for a minimum integrated system can cost several thousand dollars and considerably more for a setup with a large assortment of accessories. Vendors that sell gel documentation systems include Alpha Innotech (San Leandro, California), Fotodyne (Hartland, Wisconsin), and Stratagene (La Jolla, California).

Although the results obtained with these documentation systems are entirely satisfactory for immediate analysis, the printed images fade during storage and are devoid of esthetic appeal. More pleasing and durable results are obtained from highly sensitive Polaroid film Type 57 or 667 (ASA 3000). With an efficient UV light source ( $>2500$  mW/cm<sup>2</sup>), a Wratten 22A (red/orange) filter, and a good lens ( $f = 135$  mm), an exposure of a few seconds is sufficient to obtain images of bands containing as little as 10 ng of DNA. With a long exposure time and a strong UV light source, the fluorescence emitted by as little as 1 ng of ethidium-bromide-stained DNA can be recorded on film. For detection of extremely faint DNA bands stained with this dye, a lens with a shorter focal length ( $f = 75$  mm) should be used in combination with a conventional wet-process film (e.g., Kodak no. 4155). This setup allows the lens to be moved closer to the gel, concentrates the image on a smaller area of film, and allows for flexibility in developing and printing the image.

A further 10–20-fold increase in the sensitivity of conventional photography can be obtained by staining DNA with SYBR Gold (Molecular Probes). Of course, the price of this



**FIGURE 5-4** Photography of Gels by Ultraviolet Illumination

The top diagram shows the arrangement of the UV light source, the gel, and the camera that is used for photography by transmitted light. The bottom diagram shows the arrangement that is used for photography by incident light.

increase in sensitivity is steep: 10 liters of working solution of SYBR Gold stain costs more than 100 dollars, whereas the same amount of ethidium bromide costs ~5 cents. Detection of DNAs stained with this dye requires the use of a yellow or green gelatin or cellophane filter (S-7569, available from Molecular Probes or Kodak) with the camera and illumination with 300-nm UV light.

# Protocol 3

---

## Recovery of DNA from Agarose Gels: Electrophoresis onto DEAE-cellulose Membranes

**M**ANY METHODS HAVE BEEN DEVELOPED OVER THE YEARS to recover DNA from agarose and polyacrylamide gels. Even now, scarcely an issue of technically oriented molecular cloning journals is printed without some variation on this general procedure. Despite the plethora of methods, none of these have proven satisfactory in all hands. The problems associated with the efficient recovery of DNA from agarose gels include:

- ***DNA recovered from agarose gels is frequently difficult to ligate, digest, or radiolabel.*** This difficulty is usually caused by charged polysaccharide inhibitors in the eluted DNA. In the past, most grades of agarose were contaminated with poorly characterized polysaccharides, which are extracted from the gel along with the DNA. These substances are potent inhibitors of many of the enzymes commonly used in molecular cloning. Although improvements in the quality of agarose have reduced this problem considerably, there are still occasions when DNA is recovered in a nonreactive form.
- ***Inefficient recovery of large fragments of DNA.*** The efficiency with which DNA is recovered from agarose gels is a function of its molecular weight. Although most methods give reasonable yields of DNA fragments that are <5 kb in length (>50%), none of them are entirely satisfactory for the recovery of larger fragments. As the size of the DNA fragments increases, the yield progressively decreases, especially when the DNA is purified by methods that involve binding to a solid matrix such as a diethylaminoethyl (DEAE)-cellulose membrane. Larger fragments bind more tenaciously to such supports and are more difficult to elute.
- ***Inefficient recovery of small amounts of DNA.*** The smaller the amount of DNA in the band, the lower the yield of purified fragments. In some methods, the loss of material is so great that it is not worthwhile to attempt to recover bands that contain <500 ng of DNA.
- ***Inability to recover a number of different fragments simultaneously.*** Several of the techniques are labor-intensive and consist of many individual manipulations. The number of fragments that can be processed at any one time is therefore limited.

In this protocol, DNA is recovered from an agarose gel by electrophoresis onto a positively charged DEAE-cellulose membrane. Fragments of DNA are first separated by electrophoresis through an agarose gel of the appropriate concentration. A slit is then cut in the gel immediately

ahead of the DNA band(s) of interest, and a sliver of DEAE-cellulose membrane is inserted into the slit. The method can also be adapted for eluting DNA from a slice of polyacrylamide gel by introducing the polyacrylamide slice into the slit in an agarose gel, just ahead of the DEAE-cellulose membrane. Electrophoresis is continued until all of the DNA in the band has been collected onto the membrane. The membrane is then removed from the slit and washed free of contaminants in a buffer of low ionic strength. The DNA is finally eluted from the membrane in a buffer of high ionic strength. The DNA recovered from the membrane is of high purity and can be used for the most demanding tasks (e.g., transformation of mammalian cell lines).

The following method is based on the procedure of Girvitz et al. (1980), who used a dialysis membrane to trap bands of DNA. The original procedure was later modified by Dretzen et al. (1981), who replaced the dialysis membrane with DEAE paper (the recovery of DNA is much more efficient when a DEAE membrane is used). However, because DNAs larger than 5 kb are eluted from the positively charged membrane with progressively decreasing efficiency, the method is unsuitable for DNA fragments larger than ~10 kb in size. Electrophoresis onto a DEAE-cellulose membrane cannot be used to isolate single-stranded DNAs, which bind tenaciously to the membrane.

The protocols in the following pages describe methods for extracting and purifying DNA from agarose and polyacrylamide gels that have worked well in several laboratories and, in our hands, are consistent and reliable.

- Electrophoresis onto a DEAE-cellulose membrane (this protocol) is a relatively simple technique that can be performed simultaneously on many samples and consistently gives high yields of fragments between 500 bp and 5 kb in length.
- Electroelution into dialysis bags (Protocol 4) is an inconvenient but effective technique for the recovery of large fragments of DNA (>5 kb in length) and can be used to elute DNA from polyacrylamide gels. Purification of DNA recovered from gels by anion-exchange chromatography (Protocol 5) is an efficient but labor-intensive procedure.
- The recovery of DNA from gels cast with low-melting-temperature agarose (Protocols 6 and 7) can be less reproducible than other methods but has the advantage that certain enzyme reactions (e.g., digestion with restriction enzymes and ligation) can be carried out directly in the melted gel.
- DNA may also be recovered from agarose gels by adsorption onto glass beads (please see the panel on **ALTERNATIVE PROTOCOL: RECOVERY OF DNA FROM AGAROSE GELS USING GLASS BEADS** in Protocol 6).

## MATERIALS

---

**CAUTION:** Please see Appendix 12 for appropriate handling of materials marked with <!>.

### Buffers and Solutions

**Please see Appendix 1 for components of stock solutions, buffers, and reagents. Dilute stock solutions to the appropriate concentrations.**

*Ammonium acetate (10 M)*

*DEAE high-salt elution buffer*

50 mM Tris-Cl (pH 8.0)

1 M NaCl

10 mM EDTA (pH 8.0)

*DEAE low-salt wash buffer*

50 mM Tris-Cl (pH 8.0)

0.15 M NaCl

10 mM EDTA (pH 8.0)

*EDTA (10 mM, pH 8.0)*

*Ethanol*

*6x Gel-loading buffer*

For a list of gel-loading buffers and recipes, please see Table 5-4 in Protocol 1.

*NaOH (0.5 N) <!>*

*Phenol:chloroform (1:1, v/v) <!>*

*Sodium acetate (3 M, pH 5.2)*

*TE (pH 8.0)*

## Enzymes and Buffers

*Restriction endonucleases*

## Gels

*Agarose gels, containing 0.5 µg/ml ethidium bromide <!>*

Prepare gels containing a concentration of agarose (Protocol 1) appropriate for separating the fragments in the DNA sample. One of the gels is used for isolation of DNA and the other is used for analysis of the DNA recovered from the gel.

## Nucleic Acids and Oligonucleotides

*DNA sample*

*DNA standards*

*RNA, yeast carrier tRNA*

Optional: Use to improve recovery of DNA during precipitation. Please see Step 10.

Prepare a solution containing yeast tRNA (Boehringer Mannheim or Sigma) at a concentration of 10 mg/ml in sterile TE (pH 7.6), 0.1 M NaCl. Extract the solution twice with phenol (equilibrated in Tris-Cl at pH 7.6) and twice with chloroform. Precipitate the RNA with 2.5 volumes of ethanol at room temperature, and recover the RNA by centrifugation at 5000g (6500 rpm in a Sorvall SS-34 rotor) for 15 minutes at 4°C. Dissolve the pellet of RNA at a concentration of 10 mg/ml in sterile TE (pH 7.6). Store the carrier RNA in small aliquots at -20°C.

## Special Equipment

*DEAE-cellulose membranes*

These membranes can be obtained from Schleicher & Schuell (NA-45) or from Whatman.

*Ultraviolet lamp, hand-held, long-wavelength (302 nm) <!>*

*Water bath preset to 65°C*

## METHOD

---

1. Digest an amount of DNA that will yield at least 100 ng of the fragment(s) of interest. Separate the fragments by electrophoresis through an agarose gel of the appropriate concentration that contains 0.5 µg/ml ethidium bromide, and locate the band of interest with a hand-held, long-wavelength UV lamp.

Excitation of the ethidium bromide-DNA complex may cause photobleaching of the dye and single-strand breaks. Use of a light source that emits at 302 nm instead of 254 nm will minimize both effects.

2. Use a sharp scalpel or razor blade to make an incision in the gel directly in front of the leading edge of the band of interest and ~2 mm wider than the band on each side.

If DNA is to be eluted from an entire lane of an agarose gel (e.g., a restriction digest of mammalian genomic DNA), make the incision in the gel *parallel* to the lane of interest and place a single long piece of DEAE-cellulose membrane (prepared as in Step 3) into the incision. *Reorient* the gel so that the DNA can be transferred electrophoretically from the gel to the membrane. After electrophoresis, remove the membrane and cut it into segments. Elute DNA of the desired size from the appropriate segment(s) of the membrane as described in Steps 7–11.

3. Wearing gloves, cut a piece of DEAE-cellulose membrane that is the same width as the incision and slightly deeper (1 mm) than the gel. Soak the membrane in 10 mM EDTA (pH 8.0) for 5 minutes at room temperature. To activate the membrane, replace the EDTA with 0.5 N NaOH, and soak the membrane for a further 5 minutes. Wash the membrane six times in sterile H<sub>2</sub>O.

Do not use larger pieces of membrane than necessary, as this excess reduces the efficiency with which DNA can be eluted.

The strips may be stored at 4°C in sterile H<sub>2</sub>O for several weeks after they have been activated.

4. Use blunt-ended forceps or tweezers to hold apart the walls of the incision on the agarose gel and insert the membrane into the slit. Remove the forceps and close the incision, being careful not to trap air bubbles.

Minimize the chance of contamination with unwanted species of DNA by either

- cutting out a segment of gel containing the band of interest and transferring it to a hole of the appropriate size cut in another region of the gel far from any other species of DNA
- or*
- inserting a second piece of membrane above the band of interest to trap unwanted species of DNA

5. Resume electrophoresis (5 V/cm) until the band of DNA has just migrated onto the membrane. Follow the progress of the electrophoresis with a hand-held, long-wavelength (302 nm) UV lamp.

Electrophoresis should be continued for the minimum time necessary to transfer the DNA from the gel to the membrane. Extended electrophoresis can result in cross-contamination with other DNA fragments (see above) or unnecessary accumulation of contaminants from the agarose.

6. When all of the DNA has left the gel and is trapped on the membrane, turn off the electric current. Use blunt-ended forceps to recover the membrane and rinse it in 5–10 ml of DEAE low-salt wash buffer at room temperature to remove any agarose pieces from the membrane.

Do not allow the membrane to dry; otherwise, the DNA becomes irreversibly bound.

7. Transfer the membrane to a microfuge tube. Add enough DEAE high-salt elution buffer to cover the membrane completely. The membrane should be crushed or folded gently, but not tightly packed. Close the lid of the tube and incubate it for 30 minutes at 65°C.

Check the tube from time to time to ensure that the membrane does not expand above the level of the buffer.

8. While the DNA is eluting from the membrane, photograph the gel as described in Protocol 2 to establish a record of which bands were isolated.

9. Transfer the fluid from Step 7 to a fresh microfuge tube. Add a second aliquot of DEAE high-salt elution buffer to the membrane, and incubate the tube for a further 15 minutes at 65°C. Combine the two aliquots of DEAE high-salt elution buffer.

Check under UV illumination that the membrane no longer contains a visible smear of ethidium-bromide-stained DNA. Discard the used membrane.

10. Extract the high-salt eluate once with phenol:chloroform. Transfer the aqueous phase to a fresh microfuge tube, and add 0.2 volume of 10 M ammonium acetate and 2 volumes of ethanol at 4°C. Store the mixture for 10 minutes at room temperature, and recover the DNA by centrifugation at maximum speed for 10 minutes at room temperature in a microfuge. Carefully rinse the pellet with 70% ethanol, store the open tube on the bench for a few minutes to allow the ethanol to evaporate, and then redissolve the DNA in 3–5 µl of TE (pH 8.0).

The addition of 10 µg of carrier RNA before precipitation may improve the recovery of small amounts of DNA. However, before adding the RNA, make sure that the presence of RNA will not compromise any subsequent enzymatic reactions in which the DNA is used as a substrate or template.

11. If exceptionally pure DNA is required (e.g., for microinjection of fertilized mouse eggs or electroporation of cultured cells), reprecipitate the DNA with ethanol as follows.
  - a. Suspend the DNA in 200 µl of TE (pH 8.0), add 25 µl of 3 M sodium acetate (pH 5.2), and precipitate the DNA once more with 2 volumes of ethanol at 4°C.
  - b. Recover the DNA by centrifugation at maximum speed for 5–15 minutes at 4°C in a microfuge.
  - c. Carefully rinse the pellet with 70% ethanol. Store the open tube on the bench for a few minutes to allow the ethanol to evaporate, and then dissolve the DNA in 3–5 µl of TE (pH 8.0).
12. Check the amount and quality of the DNA by gel electrophoresis. Mix a small aliquot (~10–50 ng) of the final preparation of the fragment with 10 µl of TE (pH 8.0), and add 2 µl of the desired gel-loading buffer (please see Table 5-4 in Protocol 1). Load and run an agarose gel of the appropriate concentration, using as markers restriction digests of known quantities of the original DNA and the appropriate DNA size standards. The isolated fragment should comigrate with the correct fragment in the restriction digest. Examine the gel carefully for the presence of faint fluorescent bands that signify the presence of contaminating species of DNA.

It is often possible to estimate the amount of DNA in the final preparation from the relative intensities of fluorescence of the fragment and the markers.

# Protocol 4

---

## Recovery of DNA from Agarose and Polyacrylamide Gels: Electroelution into Dialysis Bags

**T**HIS TECHNIQUE (MCDONELL ET AL. 1977) ALLOWS THE RECOVERY in high yield of double-stranded DNAs of a wide range of sizes from slices of agarose and polyacrylamide gels. The method is somewhat tedious, requiring the insertion of individual gel slices into dialysis bags and is therefore inefficient when recovering large numbers of fragments. However, electroelution works well and is the technique of first resort should difficulties arise with other methods.

### MATERIALS

---

**CAUTION:** Please see Appendix 12 for appropriate handling of materials marked with <!.>.

#### Buffers and Solutions

Please see Appendix 1 for components of stock solutions, buffers, and reagents. Dilute stock solutions to the appropriate concentrations.

*Ethanol*

*Ethidium bromide <!.> or SYBR Gold staining solution <!.>*

*Phenol:chloroform (1:1, v/v) <!.>*

*Sodium acetate (3 M, pH 5.2)*

*0.25x TBE electrophoresis buffer*

For a list of recipes, please see Table 5-3 in Protocol 1.

Other electrophoresis buffers such as TAE (please see Table 5-3) or 0.5x TBE can be used for electroelution of DNA fragments from agarose and polyacrylamide gels. Buffers are used at reduced strength (0.25–0.5x) to increase the rate at which the DNA migrates through the gel.

*0.25x TBE electrophoresis buffer containing 0.5 µg/ml ethidium bromide <!.>*

#### Enzymes and Buffers

*Restriction endonucleases*

#### Gels

*Agarose or polyacrylamide gel <!.>*

Prepare a gel containing a concentration of agarose (Protocol 1) or acrylamide (Protocol 9) appropriate for separating the fragments in the DNA sample.



## Nucleic Acids and Oligonucleotides

*DNA sample*

### Special Equipment

*Dialysis tubing, boiled*

For the preparation of dialysis tubing for use with DNA, please see Appendix 8 or use a commercial preparation of molecular biology grade dialysis tubing (e.g., Life Technologies).

*Dialysis tubing clips*

Spectra Por closures from Spectrum Medical Industries.

*Horizontal electrophoresis tank*

*Ultraviolet lamp, hand-held, long-wavelength (302 nm)*

### Additional Reagents

*Step 3 of this protocol requires reagents listed in Protocol 2 of this chapter.*

*Step 10 of this protocol may require reagents listed in Protocol 5 of this chapter.*

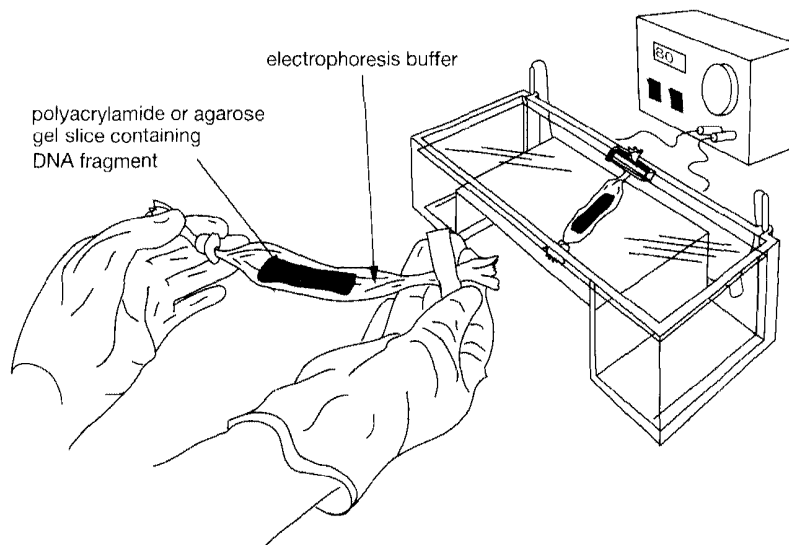
## METHOD

---

1. Digest an amount of the sample DNA that will yield at least 100 ng of the fragment(s) of interest. Separate the fragments by electrophoresis through an agarose or polyacrylamide gel of the appropriate concentration, stain with 0.5 µg/ml ethidium bromide or SYBR Gold, and locate the band(s) of interest with a hand-held, long-wavelength UV lamp.

Agarose gels may be cast with ethidium bromide or run and subsequently stained either with ethidium bromide or with SYBR Gold (please see Protocol 2). If the DNA is separated by electrophoresis through acrylamide, the gel is subsequently stained either with ethidium bromide or with SYBR Gold (please see Protocols 9 and 10). Excitation of the ethidium bromide–DNA complex may cause photobleaching of the dye and single-strand breaks. Use of a source that emits at 302 nm instead of 254 nm will minimize both effects.

2. Use a sharp scalpel or razor blade to cut out a slice of agarose or polyacrylamide containing the band of interest, and place it on a square of Parafilm wetted with 0.25× TBE. Cut the smallest slice of gel possible to reduce the amount of contamination of DNA with inhibitors, to minimize the distance the DNA need migrate to exit the gel, and to ensure an easy fit into the dialysis tubing on hand.
3. After excising the band, photograph the gel as described in Protocol 2 to establish a record of which band was removed.
4. Wearing gloves, seal one end of a piece of dialysis tubing with a secure knot. Fill the dialysis bag to overflowing with 0.25× TBE. Holding the neck of the bag and slightly squeezing the tubing to open it, use a thin spatula to transfer the gel slice into the buffer-filled bag.
5. Allow the gel slice to sink to the bottom of the bag. Squeeze out most of the buffer, leaving just enough to keep the gel slice in constant contact with the buffer. Place a dialysis clip just above the gel slice to seal the bag. Avoid trapping air bubbles and clipping the gel slice itself (Figure 5-5). Use a permanent felt-tipped marker to label the dialysis clip with the name of the DNA fragment.
6. Immerse the bag in a shallow layer of 0.25× TBE in a horizontal electrophoresis tank. Use a glass rod or pipette to prevent the dialysis bag from floating and to maintain the gel fragment in an orientation that is parallel to the electrodes. Pass an electric current through the bag (7.5



**FIGURE 5-5 Electroelution of DNA from the Gel Slice**

This method of recovering DNA from gels was originally described by McDonnell et al. (1977).

V/cm) for 45–60 minutes. Use a hand-held, long-wavelength UV lamp to monitor the movement of the DNA fragment out of the gel slice.

If the dialysis bag containing the DNA fragment is subjected to an electric field for too short a period of time, not all of the DNA will migrate out of the gel slice and the yield will be reduced. Similarly, if the electrophoresis time is too long, the DNA becomes attached to the wall of the dialysis bag. Typically, 45–60 minutes at 7.5 V/cm in 0.25x TBE buffer is sufficient to electroelute ~85% of a DNA fragment of 0.1–2.0 kb from the gel slice. Other buffers, larger DNA fragments, and gels containing high concentrations of agarose require different electrophoresis times.

7. Reverse the polarity of the current for 20 seconds to release the DNA from the wall of the bag. Turn off the electric current and recover the bag from the electrophoresis chamber. Gently massage the bag to mix the eluted DNA into the buffer.
8. After the reverse electrophoresis, remove the dialysis clip, and transfer the buffer surrounding the gel slice to a plastic tube. Remove the gel slice from the bag and stain it as described in Step 9. Use a Pasteur pipette to wash out the empty bag with a small quantity of 0.25x TBE after the initial transfer, and add the wash to the tube.
9. Stain the gel slice by immersing it in 0.25x TBE containing ethidium bromide (0.5 µg/ml) for 30–45 minutes at room temperature. Examine the stained slice by UV illumination to confirm that all of the DNA has eluted.
10. Purify the DNA either by passage through DEAE-Sephacel (please see Protocol 5), by chromatography on commercial resins, or by extraction with phenol:chloroform and standard ethanol precipitation.

# Protocol 5

---

## Purification of DNA Recovered from Agarose and Polyacrylamide Gels by Anion-exchange Chromatography

**D**NA FRAGMENTS PURIFIED FROM AGAROSE GELS, generated by the polymerase chain reaction (PCR) (Chapter 8), or even produced by digestion with restriction enzymes, are often resistant to further enzymatic manipulation. The reasons for this resistance are manifold but are generally ascribed to the presence of “inhibitors.” Purification of double-stranded DNA by ion-exchange chromatography on positively charged resins can be used to rid a sample of these poorly defined inhibitors. The negatively charged DNA is bound to a matrix, such as DEAE-Sephacel or DEAE-Sephadex in buffer of low ionic strength, the contaminants are washed away, and the DNA is then eluted from the matrix by raising the ionic strength of the buffer. Plasmid DNAs and single-stranded DNAs should not be purified on DEAE resins since they are difficult to elute once bound.

### ALTERNATIVE RESINS

Disposable columns containing reversed-phase resins (e.g., Elutip-d columns, Schleicher & Schuell; NACS, Life Technologies), silica matrices (Wizard PCR Preps Resin, Promega; StrataClean Resin, Stratagene), or glass powder (e.g., Sephaglas, Pharmacia-LKB; GENE CLEAN, Q•BIOgene) are available from several suppliers (for more information, please see Chapter 1, Protocol 9). These resins have different elution protocols that can vary dramatically from the method described in the current protocol. For example, double-stranded DNA is bound to glass powder at high ionic strength and eluted in low salt, exactly the opposite to anion-exchange chromatography. It is thus important to follow the instructions provided by the individual manufacturers of the different columns.

### MATERIALS

---

**CAUTION:** Please see Appendix 12 for appropriate handling of materials marked with <!>.

#### Buffers and Solutions

Please see Appendix 1 for components of stock solutions, buffers, and reagents. Dilute stock solutions to the appropriate concentrations.

*Ethanol*

*Isopropanol*

Phenol:chloroform (1:1, v/v) <!\>

TE (pH 7.6)

TE (pH 7.6) containing 0.1 M NaCl

TE (pH 7.6) containing 0.2 M NaCl

TE (pH 7.6) containing 0.3 M NaCl

TE (pH 7.6) containing 0.6 M NaCl

These four buffers should be sterilized by autoclaving or filtration and stored at room temperature.

## Nucleic Acids and Oligonucleotides

DNA samples in TE (pH 7.6)

## Special Equipment

*Column (small disposable) or Barrel of 2-cc syringe*

Small disposable columns are commercially available (e.g., Bio-Rad, Dispo Columns). However, the barrel of a 2-cc syringe containing a small circle of filter paper to retain the DEAE-Sephacel can also be used. If plastic columns are not available, a siliconized Pasteur pipette plugged with siliconized glass wool can be substituted. For advice on siliconizing glassware, please see Appendix 8.

*Resin, preswollen DEAE-cellulose or DEAE-Sephacel*

DEAE-substituted celluloses are commercially available from several manufacturers, including Whatman (DE-52), Pharmacia-LKB, and Sigma. DEAE celluloses have been used to purify both proteins and nucleic acids for many years. They are typically obtained from manufacturers as preswollen resins, such as Whatman DE-52 and Pharmacia-LKB DEAE-Sephacel, in buffers that contain antibacterial agents (e.g., sodium azide, pyridine-*N*-oxide, and benzalkonium chloride). These substances are toxic and can inhibit enzymes. For this reason, it is important to equilibrate the DEAE resin with TE buffer containing 0.6 M NaCl as described in Step 1. Both DEAE-cellulose and DEAE-Sephacel can be sedimented in a microfuge, allowing batch elution methods to be used.

## Additional Reagents

Step 10 of this protocol requires reagents listed in Protocol 12 of this chapter.

## METHOD

1. Suspend the DEAE resin in 20 volumes of TE (pH 7.6) containing 0.6 M NaCl. Allow the resin to settle, and then remove the supernatant by aspiration. Add another 20 volumes of TE (pH 7.6) containing 0.6 M NaCl, and gently resuspend the resin. Allow the resin to settle once more, and then remove most of the supernatant by aspiration. Store the equilibrated resin at 4°C.
2. Pack 0.6 ml (sufficient to bind 20 µg of DNA) of the slurry of DEAE resin into a small column or into the barrel of a 2-cc syringe.
3. Wash the column as follows:
 

TE (pH 7.6) containing 0.6 M NaCl	3 ml
TE (pH 7.6)	3 ml
TE (pH 7.6) containing 0.1 M NaCl	3 ml
4. Mix the DNA (in TE at pH 7.6) with an equal volume of TE (pH 7.6) containing 0.2 M NaCl. Load the mixture directly onto the column. Collect the flow-through and reapply it to the column.
5. Wash the column twice with 1.5 ml of TE (pH 7.6) containing 0.3 M NaCl.
6. Elute the DNA with three 0.5-ml washes of TE (pH 7.6) containing 0.6 M NaCl.
7. Extract the eluate once with phenol:chloroform.

8. Divide the aqueous phase equally between two microfuge tubes, and add an equal volume of isopropanol to each tube. Store the mixtures for 15 minutes at room temperature, and then recover the DNA by centrifugation at maximum speed for 10 minutes at 4°C in a microfuge.
9. Wash the pellets carefully with 70% ethanol, store the open tube on the bench for a few minutes to allow the ethanol to evaporate, and then redissolve the DNA in a small volume (3–5 µl) of TE (pH 7.6).
10. Check the amount and quality of the fragment by polyacrylamide or high-resolution agarose gel electrophoresis.
  - a. Mix a small aliquot (~20 ng) of the final preparation of the fragment with 10 µl of TE (pH 8.0), and add 2 µl of the desired gel-loading buffer (please see Table 5-4).
  - b. Load and run a polyacrylamide or high-resolution agarose gel of the appropriate concentration, using as markers restriction digests of known quantities of the original DNA. The isolated fragment should comigrate with the correct fragment in the restriction digest.
  - c. Examine the gel carefully for the presence of faint fluorescent bands that signify the presence of contaminating species of DNA. It is often possible to estimate the amount of DNA in the final preparation from the relative intensities of fluorescence of the fragment and the markers.

Only rarely is further purification of the recovered DNA required. The best option is to use chromatography on DEAE-Sephacel columns again, or to use any of a wide variety of specialty resins that are available commercially (please see Chapter 1, Protocol 9). Many of the specialty resins come in prepacked columns that are appropriate for purifying small amounts of DNA using a microfuge. Make sure that the resin chosen is appropriate for purifying linear DNA molecules as opposed to circular plasmids.

# Protocol 6

---

## Recovery of DNA from Low-melting-temperature Agarose Gels: Organic Extraction

**A** GAROSE THAT HAS BEEN MODIFIED BY HYDROXYETHYLATION, a substitution that reduces the number of intrastrand hydrogen bonds, melts and sets at lower temperatures than standard agaroses. The degree of substitution within the polysaccharide chain determines the exact melting and gelling temperature. These properties form the basis of techniques to recover and manipulate DNA fragments in gels (Wieslander 1979; Parker and Seed 1980). Many brands of low-melting-temperature agarose can be held as liquids in the 30–35°C range, so that enzymatic reactions (restriction endonuclease digestion/ligation) can be performed at a reasonable temperature without the agarose solidifying. In addition to enzymatic reactions, low melting/gelling temperature agaroses may be used for rapid recovery of DNA from gels and for bacterial transformation with nucleic acids in the remelted gel.

Because low-melting-temperature agarose remains fluid at 37°C, enzymatic manipulations such as ligation, synthesis of radioactive probes, and digestion with restriction enzymes can be carried out by adding portions of the melted gel slice containing the DNA of interest directly to the reaction mixture (Parker and Seed 1980; Struhl 1985). In general, however, polymerases, ligases, and restriction enzymes work less efficiently in the presence of melted gel than in conventional aqueous buffers. The magnitude of the decrease in enzymatic efficiency can be estimated by setting up control reactions containing different amounts of enzyme and (1) DNA fragments purified from conventional agarose gels (Protocols 3 and 4) or (2) DNA fragments extracted from low-melting-temperature gels (Protocols 6 and 7).

As is the case with standard agaroses used for preparative purposes, manufacturers provide grades of low-melting-temperature agaroses that have been tested to display minimal background fluorescence after staining with ethidium bromide, to be free of DNase and RNase activity, and to display minimal inhibition of restriction endonucleases and ligase.

In the current protocol, DNA fragments are separated according to size by electrophoresis through low-melting-temperature agarose, located by staining with ethidium bromide and UV light illumination, and then recovered by melting the agarose and extracting with phenol:chloroform. The protocol works best for DNA fragments ranging in size from 0.5 kb to 5.0 kb. Yields of DNA fragments outside this range are usually lower, but often are sufficient for many purposes.

An alternative method for recovering DNA from gels is described in the panel **ALTERNATIVE PROTOCOL: RECOVERY OF DNA FROM AGAROSE GELS USING GLASS BEADS** at the end of this protocol. Recovery by digestion with agarase is described in Protocol 7. A more detailed method for ligation in the presence of low-melting-temperature agarose is described in Chapter 1, Protocol 22.

## MATERIALS

---

**CAUTION:** Please see Appendix 12 for appropriate handling of materials marked with <!.>.

### Buffers and Solutions

Please see Appendix 1 for components of stock solutions, buffers, and reagents. Dilute stock solutions to the appropriate concentrations.

*Ammonium acetate (10 M)*

*Chloroform <!.>*

*Ethanol*

*Ethidium bromide <!.> or SYBR Gold staining solution <!.>*

For a discussion of staining agarose gels, please see Protocol 2.

*6x Gel-loading buffer*

For a list of gel-loading buffers and recipes, please see Table 5-4 in Protocol 1.

*LMT elution buffer*

20 mM Tris-Cl (pH 8.0)

1 mM EDTA (pH 8.0)

*Phenol:chloroform (1:1, v/v) <!.>*

*Phenol, equilibrated to pH 8.0 <!.>*

*1x TAE electrophoresis buffer*

For a list of electrophoresis buffers and recipes, please see Table 5-3 in Protocol 1.

*TE (pH 8.0)*

### Gels

*Agarose gel made with low-melting-temperature agarose*

This agarose is available from numerous commercial manufacturers (please see Table 5-1 in Protocol 1).

Prepare gels of a percentage of agarose appropriate for separating the fragments in the DNA sample. For details on preparing agarose gels, please see Protocol 1.

### Nucleic Acids and Oligonucleotides

*DNA sample*

### Centrifuges and Rotors

*Sorvall SS-34 rotor or equivalent*

### Special Equipment

*Ultraviolet lamp, hand-held, long-wavelength (302 nm) <!.>*

*Water bath preset to 65°C*

## METHOD

---

1. Prepare a gel containing the appropriate concentration of low-melting-temperature agarose in 1xTAE buffer.

There are several reasons to use TAE buffer instead of TBE buffer. In particular, borate ions inhibit ligation reactions and can interfere with subsequent purification of the eluted DNA fragment on glass beads (please see the panel on **ALTERNATIVE PROTOCOL: RECOVERY OF DNA FROM AGAROSE GELS USING GLASS BEADS**).

Ethidium bromide may be added to the gel before casting (0.5 µg/ml) or the gel can be stained after the electrophoresis run with ethidium bromide or with SYBR Gold.

- Cool the gel to room temperature, and then transfer it and its supporting glass plate to a horizontal surface in a gel box.

The gel may be placed in a cold room to ensure complete setting.

- Mix the samples of DNA with gel-loading buffer, load them into the slots of the gel, and carry out electrophoresis at 3–6 V/cm.

DNA of a given size runs slightly faster through gels cast with low-melting-temperature agarose than through conventional agarose gels. For this reason, the voltage applied to low-melting-temperature agarose gels should be lower than that applied to standard agarose gels.

- If needed, stain the agarose gel with ethidium bromide or with SYBR Gold as described in Protocol 2, and locate the DNA band of interest using a hand-held, long-wavelength (302 nm) UV lamp.

- Use a sharp scalpel or razor blade to cut out a slice of agarose containing the band of interest and transfer it to a clean, disposable plastic tube.

Cut the smallest slice of agarose possible to minimize the amount of contamination of DNA with inhibitors.

- After cutting out the band, photograph the gel as described in Protocol 2 to record which band of DNA was removed.

- Add ~5 volumes of LMT elution buffer to the slice of agarose, close the top of the tube, and melt the gel by incubation for 5 minutes at 65°C.

- Cool the solution to room temperature, and then add an equal volume of equilibrated phenol. Vortex the mixture for 20 seconds, and then recover the aqueous phase by centrifugation at 4000g (5800 rpm in a Sorvall SS-34 rotor) for 10 minutes at 20°C.

The white substance at the interface is agarose.

- Extract the aqueous phase once with phenol:chloroform and once with chloroform.

- Transfer the aqueous phase to a fresh centrifuge tube. Add 0.2 volume of 10 M ammonium acetate and 2 volumes of absolute ethanol at 4°C. Store the mixture for 10 minutes at room temperature, and then recover the DNA by centrifugation, for example, at 5000g (6500 rpm in a Sorvall SS-34 rotor) for 20 minutes at 4°C.

- Wash the DNA pellet with 70% ethanol and dissolve in an appropriate volume of TE (pH 8.0).

DNA purified from low-melting-temperature agarose gels is suitable for use in most enzymatic reactions of molecular cloning. Occasionally, more demanding experiments such as transfections, injections, or multifragment ligations require highly purified DNA. Fragments recovered from low-melting-temperature agarose can be purified by chromatography on small DEAE-Sephacel columns (please see Protocol 5) or any of a wide variety of specialty resins that are available commercially as prepacked columns (please see Chapter 1, Protocol 9). Make sure that the resin chosen is appropriate for purifying linear DNA molecules as opposed to circular plasmids.



**ALTERNATIVE PROTOCOL: RECOVERY OF DNA FROM AGAROSE GELS USING GLASS BEADS**

The recovery of DNA from low-melting-temperature agarose may also be achieved by adsorbing DNA in the melted gel slice to glass beads (or powder) in the presence of high salt. After washing, the DNA is eluted from the beads with a low-salt buffer. This method, although more rapid than organic extraction, may result in somewhat lowered yields. An alternative is to use a commercial kit (Qiaex gel extraction kit and GENECLEAN from Q-BIOgene). These commercial kits provide the necessary materials in prepackaged form.

**Additional Materials***Glass beads suspension*

In a microfuge tube, suspend 200  $\mu$ l of acid-washed glass beads (0.2 mm) by vortexing in an equal volume of H<sub>2</sub>O. Acid-washed glass beads may be purchased (e.g., from Sigma). Unwashed beads are not recommended.

*Sodium iodide solution (6 M)*

Dissolve 0.75 g of Na<sub>2</sub>SO<sub>3</sub> in 40 ml of H<sub>2</sub>O. To this solution add 45 g of sodium iodide and stir to dissolve. Filter the solution through Whatman paper or nitrocellulose and store in the dark (wrap in aluminum foil). The solution should remain stable for up to 2–3 months. If a precipitate is observed, discard the solution.

*Wash solution*

20 mM Tris-Cl (pH 7.4)

1 mM EDTA

100 mM NaCl

Add an equal volume of ethanol to this solution and store for 3–4 months at 0°C.

**Method**

1. Follow Steps 1 through 5 of Protocol 6, transferring the gel slice into a polypropylene tube in Step 5.
2. To the gel slice, add ~3–5 volumes of sodium iodide solution, and melt the agarose by incubating for 5 minutes at 55°C.  
Do not heat the solution longer than necessary to dissolve all of the agarose.
3. For DNA samples  $\leq 5$   $\mu$ g, add 5  $\mu$ l of glass beads. For DNA samples  $> 5$   $\mu$ g, add an additional 2  $\mu$ l/ $\mu$ g glass beads. Incubate the mixture for 5 minutes at room temperature with occasional shaking.
4. Centrifuge the mixture at maximum speed for 5 seconds in a microfuge, and discard the supernatant.
5. Wash the pellet three times with 500  $\mu$ l of wash solution, and resuspend in TE (pH 8.0) at  $\sim 0.5$   $\mu$ g/ $\mu$ l.
6. Incubate the resuspended DNA/glass beads complex for 3 minutes at 45°C to elute the DNA from the beads.
7. Centrifuge the mixture at maximum speed for 1 minute in a microfuge, transfer the DNA-containing supernatant to a fresh tube, and store at 4°C.

# Protocol 7

---

## Recovery of DNA from Low-melting-temperature Agarose Gels: Enzymatic Digestion with Agarase

**A**N ENZYMATIC METHOD MAY BE USED TO RECOVER DNA from gels cast with low-melting-temperature agarose (Burmeister and Lehrach 1989). In this technique, the fragment containing the DNA is excised from the gel and digested with the enzyme agarase, which hydrolyzes the agarose polymer to disaccharide subunits. The released DNA is then purified by phenol extraction and ethanol precipitation. Because this method is extremely gentle, it is particularly useful for the recovery of high-molecular-weight DNAs extracted from pulsed-field agarose gels (Protocols 19 and 20). However, it also works well for recovery of smaller DNA fragments from agarose gels run in constant electrical fields.

### MATERIALS

---

**CAUTION:** Please see Appendix 12 for appropriate handling of materials marked with <!.>.

#### Buffers and Solutions

Please see Appendix 1 for components of stock solutions, buffers, and reagents. Dilute stock solutions to the appropriate concentrations.

##### *Ethanol*

*Ethidium bromide <!.> or SYBR Gold staining solution <!.>*

For a discussion of staining agarose gels, please see Protocol 2.

##### *Gel equilibration buffer*

10 mM Bis Tris-Cl (pH 6.5)

5 mM EDTA (pH 8.0)

0.1 M NaCl

Bis Tris-Cl, a component of gel equilibration buffer, is Bis(2-hydroxyethyl)iminotris(hydroxymethyl)methane hydrochloride. It is one of a large series of zwitterionic buffers developed in the mid 1960s by Norman Good and his colleagues in response to the need for compounds with strong buffering capacity at biologically relevant pHs (Good et al. 1966; Ferguson et al. 1980). The  $pK_a$  of Bis Tris-Cl is 6.5 at 25°C, and it is effective as a buffer between pH 5.8 and 7.2 (please see Appendix 1).

*NaCl (5 M)*

*Phenol, equilibrated to pH 8.0 <!.>*

*TE (pH 8.0)*

## Enzymes and Buffers

### *Agarase*

Agarase is available from a number of manufacturers (e.g., GELase from Epicenter Technologies,  $\beta$ -Agarase I from New England Biolabs, and  $\beta$ -Agarase I from Calbiochem).

## Nucleic Acids and Oligonucleotides

### *DNA sample*

## Special Equipment

### *Dialysis tubing, boiled*

For the preparation of dialysis tubing for use with DNA, please see Appendix 8 or use a commercial preparation of molecular biology grade dialysis tubing (e.g., Life Technologies).

### *Microdialysis system (Life Technologies)*

Optional, please see Step 6.

### *Ultraviolet lamp, hand-held, long-wavelength (302 nm) <!\>*

### *Water baths preset to 40°C and 65°C*

## Additional Reagents

Step 1 of this protocol requires the reagents listed in Protocol 6 of this chapter.

## METHOD

---

1. Follow Steps 1 through 4 of Protocol 6 to prepare a gel cast with low-melting-temperature agarose, to load the DNA sample, and to perform electrophoresis.
2. Excise a segment of gel containing the DNA of interest and incubate the gel slice for 30 minutes at room temperature in 20 volumes of gel equilibration buffer.
3. After cutting out the band, photograph the gel as described in Protocol 2 to record which band of DNA was removed.
4. Transfer the segment of gel to a fresh tube containing a volume of gel equilibration buffer approximately equal to that of the gel slice.
5. Melt the gel slice by incubation for 10 minutes at 65°C. Cool the solution to 40°C and add DNase-free agarase, using 1–2 units of agarase per 200- $\mu$ l gel slice. Incubate the sample for 1 hour at 40°C.

During this time, the agarose is digested to oligo- and disaccharides. If desired, the DNA solution may be used directly at this stage for ligation, restriction enzyme digestion, and transformation. Alternatively, the DNA may be purified further and concentrated as described in Step 6.

6. Purify and concentrate the DNA:

### TO PURIFY SMALL DNA FRAGMENTS (<20 KB)

- a. Extract the DNA solution twice with equilibrated phenol.
- b. After the second extraction, transfer the aqueous phase to a fresh tube and add 2 volumes of TE (pH 8.0).

This step helps to prevent precipitation of oligosaccharides.
- c. Add 0.05 volume of 5 M NaCl followed by 2 volumes of ethanol. (Here, 1 volume is equal to the volume of DNA at the end of Step 6b.) Incubate the tube for 15 minutes at 0°C and then collect the precipitate by centrifugation at maximum speed for 15 minutes at 4°C in a microfuge.

- d. Carefully remove the ethanol and add 0.5 ml of 70% ethanol at room temperature. Vortex the mixture and then centrifuge as described in Step c.
- e. Remove the supernatant and store the open tube on the bench for a few minutes at room temperature to allow the ethanol to evaporate. Dissolve the DNA in an appropriate volume of TE (pH 8.0).

#### TO PURIFY LARGE DNA FRAGMENTS (> 20 kb)

- a. Transfer the agarase-digested sample to a dialysis bag, seal, and place the bag in a beaker or flask containing 100 ml of TE (pH 8.0).
- b. Dialyze the sample for several hours at 4°C.

Alternatively, dialyze the solubilized gel against TE (pH 8.0) in a drop-dialysis apparatus (e.g., Microdialysis System, Life Technologies).

To prevent shearing, larger DNA fragments should not be subjected to phenol extraction, vortexing, or ethanol precipitation (please see the information panel on **MINIMIZING DAMAGE TO LARGE DNA MOLECULES** in Chapter 2). The inclusion of 30  $\mu$ M spermine and 70  $\mu$ M spermidine in the dialysis buffer can enhance recovery of large DNA fragments (>15 kb).

# Protocol 8

---

## Alkaline Agarose Gel Electrophoresis

**A**LKALINE AGAROSE GELS ARE RUN AT HIGH PH, WHICH CAUSES EACH THYMIDINE and guanine residue to lose a proton, and thus prevents the formation of hydrogen bonds with their adenine and cytosine partners. The denatured DNA is maintained in a single-stranded state and migrates through an alkaline agarose gel as a function of its size. Other denaturants such as formamide and urea do not work well because they cause the agarose to become rubbery. Since their invention (McDonnell et al. 1977), alkaline agarose gels have been used chiefly to

- measure the size of first and second strands of cDNA synthesized by reverse transcriptase (Chapter 11, Protocol 1)
- analyze the size of the DNA strand after digestion of DNA-RNA hybrids with nuclease S1 (Favaloro et al. 1980)

The use of alkaline agarose gel electrophoresis reached its maximum in the early 1980s when reagents and enzymes were less reliable than today and cloners were of necessity more vigilant about quality control. At that time, alkaline agarose electrophoresis was used routinely to

- check for nicking activity in enzyme preparations used for molecular cloning
- calibrate the reagents used in nick translation of DNA.

Nowadays, only the most compulsive investigators would use alkaline agarose electrophoresis to monitor the quality of enzymes. Nevertheless, the technique remains important because of its speed and accuracy in measuring the length of DNA strands in DNA-RNA hybrids and of first- and second-strand cDNAs.

### HISTORICAL FOOTNOTE

Alkaline agarose electrophoresis was developed in Bill Studier's laboratory at Brookhaven National Laboratory as a replacement for laborious alkaline gradient centrifugation of bacteriophage T7 DNA. The first alkaline horizontal gels were equipped with agarose wicks, but later, Studier developed a gel box with removable slot-formers that allowed the gel to be poured, soaked, stained, and viewed in situ. This type of apparatus was simple to construct and became extremely popular for both alkaline and neutral electrophoreses in the years before commercially manufactured gel boxes became available.

Bromophenol blue is quickly bleached by incubation at high pH and is therefore unsatisfactory as a tracking dye in alkaline agarose gels. The superior qualities of bromocresol green were discovered in a systematic screen of an ancient collection of dyes languishing in the Brookhaven Laboratory chemical store.

## MATERIALS

**CAUTION:** Please see Appendix 12 for appropriate handling of materials marked with <!.>.

### Buffers and Solutions

Please see Appendix 1 for components of stock solutions, buffers, and reagents. Dilute stock solutions to the appropriate concentrations.

#### Agarose

##### 10x Alkaline agarose gel electrophoresis buffer

500 mM NaOH <!.>

10 mM EDTA

Add 50 ml of 10 N NaOH and 20 ml of 0.5 M EDTA (pH 8.0) to 800 ml of H<sub>2</sub>O and then adjust final volume to 1 liter. Dilute the 10x alkaline agarose gel electrophoresis buffer with H<sub>2</sub>O to generate a 1x working solution immediately before use in Step 3 below. Use the same stock of 10x alkaline agarose gel electrophoresis buffer to prepare the alkaline agarose gel and the 1x working solution of alkaline electrophoresis buffer.

##### 6x Alkaline gel-loading buffer

300 mM NaOH

6 mM EDTA

18% (w/v) Ficoll (Type 400, Pharmacia)

0.15% (w/v) bromocresol green

0.25% (w/v) xylene cyanol

#### Ethanol

##### Ethidium bromide <!.> or SYBR Gold staining solution <!.>

For a discussion of staining agarose gels, please see Protocol 2.

##### Neutralizing solution for alkaline agarose gels

1 M Tris-Cl (pH 7.6)

1.5 M NaCl

##### Sodium acetate (3 M, pH 5.2)

##### 1x TAE electrophoresis buffer

For a list of electrophoresis buffers and recipes, please see Table 5-3 in Protocol 1.

### Nucleic Acids and Oligonucleotides

*DNA samples (usually radiolabeled) <!.>*

### Special Equipment

*Glass plate*

*Water bath preset to 55°C*

### Additional Reagents

*Step 3 of this protocol requires the special equipment listed in Protocol 1 of this chapter.*

#### NOTES

- Alkaline gels draw more current than neutral gels at comparable voltages and heat up during the run. Alkaline agarose electrophoresis should therefore be carried out at <3.5 V/cm. A glass plate placed on top of the gel after the run is started slows the diffusion of the bromocresol green dye out of the gel and prevents the gel from detaching and floating in the buffer.
- Partial base hydrolysis of the agarose causes single-stranded DNA to migrate as an uneven band, often at slower rates toward the bottom of the gel and at faster rates toward the top of the gel (Favaloro et al. 1980). If this is a problem, check the buffer to ensure that the final NaOH concentration is 50 mM; make sure that the gel solution is cooled to 60°C before adding the 10x alkaline agarose gel electrophoresis buffer, and cool the gel to room temperature before installing it in the electrophoresis tank and covering it with alkaline electrophoresis buffer.
- It is not strictly necessary to denature the DNA with base before electrophoresis. The exposure of the samples to the alkaline conditions in the gel is usually enough to render the DNA single-stranded.

## METHOD

---

1. Prepare the agarose solution by adding the appropriate amount of powdered agarose (please see Protocol 1) to a measured quantity of H<sub>2</sub>O in an Erlenmeyer flask or a glass bottle.
2. Loosely plug the neck of the Erlenmeyer flask with Kimwipes. When using a glass bottle, make sure that the cap is loose. Heat the slurry in a boiling-water bath or a microwave oven until the agarose dissolves.

Heat the slurry for the minimum time required to allow all of the grains of agarose to dissolve. Undissolved agarose appears as small "lenses" or translucent chips floating in the solution. Wearing an oven mitt, carefully swirl the bottle or flask from time to time to make sure that any grains sticking to the walls enter the solution. Check that the volume of the solution has not been decreased by evaporation during boiling; replenish with H<sub>2</sub>O if necessary.

3. Cool the clear solution to 55°C. Add 0.1 volume of 10x alkaline agarose gel electrophoresis buffer, and immediately pour the gel as described in Protocol 1. After the gel is completely set, mount it in the electrophoresis tank and add freshly made 1x alkaline electrophoresis buffer until the gel is just covered.

Do not add ethidium bromide because the dye will not bind to DNA at high pH.

The addition of NaOH to a hot agarose solution causes hydrolysis of the polysaccharide. For this reason, the agarose is first melted in H<sub>2</sub>O and then made alkaline by the addition of NaOH just before the gel is poured.

4. Collect the DNA samples by standard precipitation with ethanol. Dissolve the damp precipitates of DNA in 10–20 µl of 1x gel buffer. Add 0.2 volume of 6x alkaline gel-loading buffer.

Alternatively, if the volumes of the original DNA samples are small (<15 µl), add 0.5 M EDTA (pH 8.0) to a final concentration of 10 mM, followed by 0.2 volume of 6x alkaline gel-loading buffer.

It is important to chelate all Mg<sup>2+</sup> with EDTA before adjusting the electrophoresis samples to alkaline conditions. In solutions of high pH, Mg<sup>2+</sup> forms insoluble Mg(OH)<sub>2</sub> precipitates that entrap DNA.

5. Load the DNA samples dissolved in 6x alkaline gel-loading buffer into the wells of the gel as described in Protocol 1. Start the electrophoresis at <3.5 V/cm and, when the bromocresol green has migrated into the gel ~0.5–1 cm, turn off the power supply, and place a glass plate on top of the gel. Continue electrophoresis until the bromocresol green has migrated approximately two thirds of the length of the gel.
6. Process the gel according to one of the procedures described below, as appropriate for the goal of the experiment:

### SOUTHERN HYBRIDIZATION

- a. Soak the gel in neutralizing solution for 45 minutes at room temperature, and transfer the DNA to an uncharged nitrocellulose or nylon membrane as described in Chapter 6, Protocol 8.

Alternatively, transfer the DNA directly (without soaking the gel) from the alkaline agarose gel to a charged nylon membrane (please see Chapter 6, Protocol 8).

- b. Detect the target sequences in the immobilized DNA by hybridization to an appropriate labeled probe (please see Chapter 6, Protocol 10).

### STAINING

- a. Soak the gel in neutralizing solution for 45 minutes at room temperature.
- b. Stain the neutralized gel with 0.5 µg/ml ethidium bromide in 1x TAE or with SYBR Gold.

A band of interest can be sliced from the gel and subsequently eluted by one of the procedures described in Protocol 3 or 4.

**AUTORADIOGRAPHY OF WET GELS:** Follow one of the methods described in the panel below

#### **ADDITIONAL PROTOCOL: AUTORADIOGRAPHY OF ALKALINE AGAROSE GELS**

In many cases, DNA analyzed by alkaline agarose gel electrophoresis is labeled with  $^{32}\text{P}$ , which can be detected by autoradiography. Drying the gel (please see below) greatly improves the sharpness of the autoradiographic image and slightly increases the sensitivity by reducing quenching. However, if there is sufficient radiolabel in the DNA and the sharpness of the bands is not a major concern, or if the DNA band is to be recovered from the gel, the gel can be autoradiographed without drying.

**CAUTION:** Please see Appendix 12 for appropriate handling of materials marked with  $\langle ! \rangle$ .

#### **Additional Materials**

*Glass plate (the same size as the gel)*

*Hybridization bags*

Hybridization bags are available from Fisher or VWR; however, Seal-a-Meal bags from either Sears or Cheswick work just as well and are much less expensive alternatives.

*Radiolabeled ink  $\langle ! \rangle$  or luminescent markers*

*Thermal sealer (e.g., Sears)*

*Trichloroacetic acid (7% TCA)*

*Whatman 3MM filter papers*

#### **Method**

##### **FOR AUTORADIOGRAPHY OF WET GELS**

1. After completion of electrophoresis, place the gel on a glass plate.
2. Slide the gel and plate carefully into a thin plastic hybridization bag, squeeze the air from the bag, and seal the top of the bag in a heat sealer. Alternatively, wrap the gel and backing plate in Saran Wrap.
 

The use of Saran Wrap is less satisfactory because radioactive fluid tends to ooze out of the wrap during autoradiography.
3. Apply adhesive labels marked with radioactive ink or luminescent markers to the outside of the plastic bag or Saran Wrap. Cover the labels with cellophane tape to prevent contamination of the film holder or intensifying screen.
4. In a darkroom, tape the sealed gel to a piece of X-ray film cut to the same size as the glass plate. Wrap the gel and film in light-tight aluminum foil.
 

Do not use a metal film cassette; it may break the glass plate and crush the gel.
5. Expose the film for an appropriate period of time (for more information on autoradiography, please see Appendix 8).
 

The band of interest can be sliced from the gel and subsequently eluted by one of the procedures described in Protocols 3 through 5.

##### **FOR AUTORADIOGRAPHY OF DRIED GELS**

1. Soak the gel in 7% TCA for 30 minutes at room temperature. Agitate the solution every few minutes to ensure that the gel remains covered with fluid.
2. Mount the gel on a glass plate and dry it for several hours under layers of paper towels weighted with another glass plate, or place the gel on two sheets of Whatman 3MM filter paper and dry it under vacuum on a gel dryer.
 

Heat should not be used because the gel may melt.
3. Cover the dried gel with Saran Wrap and attach adhesive dot labels marked with radioactive ink or luminescent markers to align the film with the gel. Cover the labels with cellophane tape to prevent radioactive contamination of the film holder or intensifying screen.
4. Place the dried gel and film in a light-tight X-ray film holder. Expose the film to the gel for an appropriate length of time at room temperature or at  $-70^{\circ}\text{C}$  with an intensifying screen (for more information on autoradiography, please see Appendix 8).



# Protocol 9

---

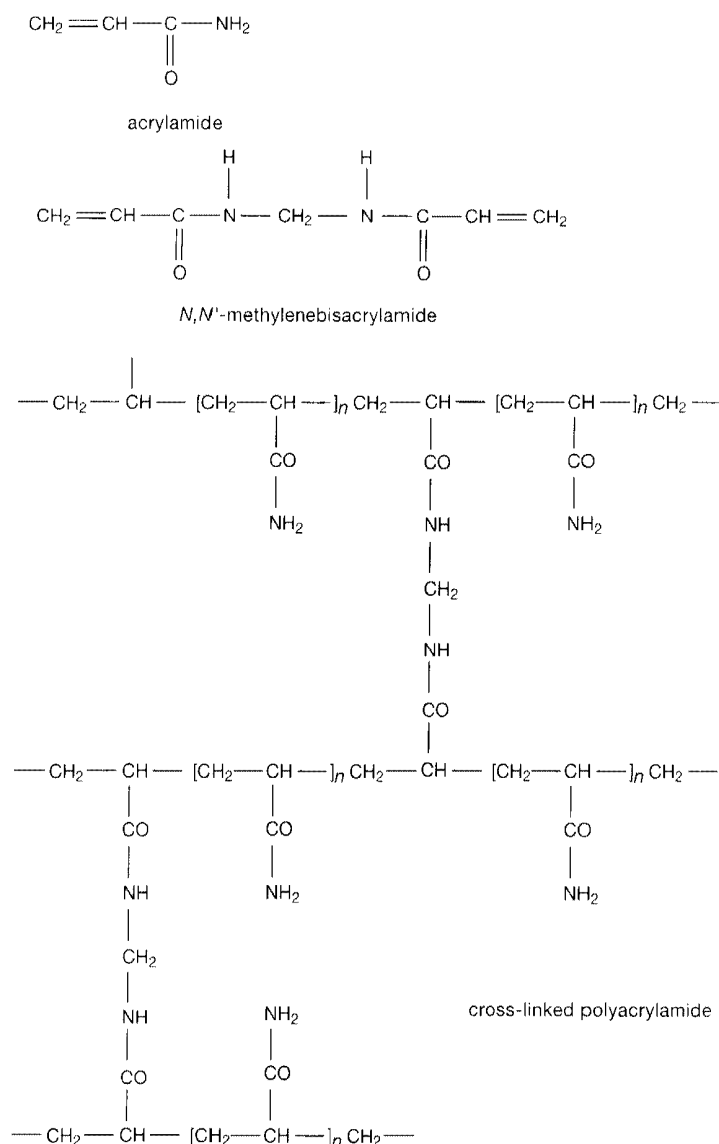
## Neutral Polyacrylamide Gel Electrophoresis

**C**ROSS-LINKED CHAINS OF POLYACRYLAMIDE, INTRODUCED AS MATRICES for electrophoresis by Raymond and Weintraub (1959), are used as electrically neutral matrices to separate double-stranded DNA fragments according to size and single-stranded DNAs according to size and conformation (please see Figure 5-6 and the panel on **POLYACRYLAMIDE**). Polyacrylamide gels have the following three major advantages over agarose gels: (1) Their resolving power is so great that they can separate molecules of DNA whose lengths differ by as little as 0.1% (i.e., 1 bp in 1000 bp). (2) They can accommodate much larger quantities of DNA than agarose gels. Up to 10  $\mu$ g of DNA can be applied to a single slot (1 cm  $\times$  1 mm) of a typical polyacrylamide gel without significant loss of resolution. (3) DNA recovered from polyacrylamide gels is extremely pure and can be used for the most demanding purposes (e.g., microinjection of mouse embryos). The following are two types of polyacrylamide gels that are in common use.

- **Denaturing polyacrylamide gels** are used for the separation and purification of single-stranded fragments of DNA. These gels are polymerized in the presence of an agent (urea and/or, less frequently, formamide) that suppresses base pairing in nucleic acids. Denatured DNA migrates through these gels at a rate that is almost completely independent of its base composition and sequence. Among the uses of denaturing polyacrylamide gels are the isolation of radiolabeled DNA probes, analysis of the products of nuclease S1 digestions, and analysis of the products of DNA sequencing reactions. For methods of preparing and running denaturing polyacrylamide gels, please see Chapter 10, Protocol 1 and Chapter 12, Protocol 8.
- **Nondenaturing polyacrylamide gels** are used for the separation and purification of fragments of double-stranded DNA. As a general rule, double-stranded DNAs migrate through nondenaturing polyacrylamide gels at rates that are inversely proportional to the  $\log_{10}$  of their size. However, electrophoretic mobility is also affected by their base composition and sequence, so that duplex DNAs of exactly the same size can differ in mobility by up to 10%. Nondenaturing polyacrylamide gels are used chiefly to prepare highly purified fragments of DNA (this protocol) and to detect protein-DNA complexes (please see Chapter 17).

Methods are presented here for preparing and running nondenaturing polyacrylamide gels (this protocol), for detection of DNA in these gels by staining (Protocol 10), and for autoradiography (Protocol 11). A more specialized application is described in Chapter 13, Protocol 8, in which polyacrylamide gels are used to detect conformational changes in single-stranded DNA resulting from the presence of mutation(s).

This protocol describes procedures for the preparation and casting of polyacrylamide gels, with subsequent assembly and processing for electrophoresis. The percentage of acrylamide



**FIGURE 5-6 Structure of Polyacrylamide**

Monomers of acrylamide are polymerized into long chains in a reaction initiated by free radicals. In the presence of *N,N'*-methylenebisacrylamide, these chains become cross-linked to form a gel. The porosity of the resulting gel is determined by the length of chains and degree of cross-linking that occurs during the polymerization reaction.

#### POLYACRYLAMIDE

In the presence of free radicals, which are usually generated by reduction of ammonium persulfate by TEMED (*N,N,N',N'*-tetramethylethylenediamine), vinyl polymerization of acrylamide monomers results in the formation of linear chains of polyacrylamide. When bifunctional cross-linking agents (e.g., *N,N'*-methylenebisacrylamide) are included, the copolymerization reaction generates three-dimensional ribbon-like networks of cross-linked polyacrylamide chains with a statistical distribution of pore sizes. Because the mean diameter of the pores formed in these networks is determined by the concentrations of the acrylamide monomer and the bifunctional cross-linker, investigators can adjust the pore size and hence expand the separation range of the gel (Margolis and Wrigley 1975; Campbell et al. 1983; for review, please see Chiari and Righetti 1995). However, a number of other factors also affect the efficiency of separation, including gel thickness, Joulic heating, and electric field strength. Investigators who wish to optimize the separation of DNA fragments, should see Grossman et al. (1992), where these factors are analyzed in a systematic way.

monomer to be used in preparing the gel is determined by the size of DNA fragments to be resolved (please see Table 5-6). The cross-linker *N,N'*-methylenebisacrylamide is usually included at 1/30th the concentration of acrylamide monomer.

**TABLE 5-6 Effective Range of Separation of DNAs in Polyacrylamide Gels**

CONCENTRATION OF ACRYLAMIDE MONOMER (%) <sup>a</sup>	EFFECTIVE RANGE OF SEPARATION (bp)	XYLENE CYANOL FF <sup>b</sup>	BROMOPHENOL BLUE <sup>b</sup>
3.5	1000–2000	460	100
5.0	80–500	260	65
8.0	60–400	160	45
12.0	40–200	70	20
15.0	25–150	60	15
20.0	6–100	45	12

<sup>a</sup>*N,N'*-methylenebisacrylamide is included at 1/30th the concentration of acrylamide.

<sup>b</sup>The numbers given are the approximate sizes (in nucleotide pairs) of fragments of double-stranded DNA with which the dye comigrates.

**TABLE 5-7 Volume of Reagents Used to Cast Polyacrylamide Gels**

REAGENTS TO CAST POLYACRYLAMIDE GELS OF INDICATED CONCENTRATIONS IN 1X TBE <sup>a</sup>				
POLYACRYLAMIDE GEL (%)	29% ACRYLAMIDE PLUS 1% <i>N,N'</i> - METHYLENEBISACRYLAMIDE (ml)	H <sub>2</sub> O (ml)	5X TBE (ml)	10% AMMONIUM PERSULFATE (ml)
3.5	11.6	67.7	20.0	0.7
5.0	16.6	62.7	20.0	0.7
8.0	26.6	52.7	20.0	0.7
12.0	40.0	39.3	20.0	0.7
20.0	66.6	12.7	20.0	0.7

<sup>a</sup>Some investigators prefer to run acrylamide gels in 0.5x TBE. In this case, adjust the volumes of 5x TBE and H<sub>2</sub>O accordingly.

**TABLE 5-8 6x Gel-loading Buffers**

BUFFER TYPE	6X BUFFER	STORAGE TEMPERATURE
I	0.25% bromophenol blue 0.25% xylene cyanol FF 40% (w/v) sucrose in H <sub>2</sub> O	4°C
II	0.25% bromophenol blue 0.25% xylene cyanol FF 15% Ficoll (Type 400; Pharmacia) in H <sub>2</sub> O	room temperature
III	0.25% bromophenol blue 0.25% xylene cyanol FF 30% glycerol in H <sub>2</sub> O	4°C
IV	0.25% bromophenol blue 40% (w/v) sucrose in H <sub>2</sub> O	4°C

## MATERIALS

CAUTION: Please see Appendix 12 for appropriate handling of materials marked with <!.>.

### Buffers and Solutions

Please see Appendix 1 for components of stock solutions, buffers, and reagents. Dilute stock solutions to the appropriate concentrations.

#### *Acrylamide:bisacrylamide (29:1) (% w/v) <!.>*

Stock solutions other than 29:1 (% w/v) acrylamide:bisacrylamide can be used to cast polyacrylamide gels. However, it is then necessary to recalculate the appropriate amount of stock solution to use. Gels can be cast with acrylamide solutions containing different acrylamide:bisacrylamide (cross-link) ratios, such as 19:1 and 37.5:1, in place of the 29:1 ratio recommended here. The mobility of DNA and dyes in such gels will be different from those given in this protocol.

▲ **WARNING** Wear gloves while working with acrylamide.

#### *Ammonium persulfate (10% w/v) <!.>*

Ammonium persulfate is used as a catalyst for the copolymerization of acrylamide and bisacrylamide gels. The polymerization reaction is driven by free radicals that are generated by an oxido-reduction reaction in which a diamine (e.g., TEMED) is used as the adjunct catalyst (Chrambach and Rodbard 1972).

#### *Ethanol*

##### *6x Gel-loading buffer*

For a list of gel-loading buffers and recipes, please see Table 5-8.

#### *KOH/methanol <!.>*

#### *Siliconizing fluid (e.g., Sigmacote or Acrylease) (optional)*

##### *5x TBE electrophoresis buffer*

For a list of recipes, please see Table 5-3 in Protocol 1.

Polyacrylamide gels are poured and run in 0.5x or 1x TBE at low voltage (1–8 V/cm) to prevent denaturation of small fragments of DNA by Joulic heating. Other electrophoresis buffers such as 1x TAE (please see Protocol 1) can be used, but they are not as good as TBE. The gel must be run more slowly in 1x TAE, which does not provide as much buffering capacity as TBE. For electrophoresis runs greater than 8 hours, we recommend that 1x TBE buffer be used to ensure that adequate buffering capacity is available throughout the run.

#### *TEMED <!.>*

Electrophoresis grade TEMED is available from Bio-Rad, Sigma, and other suppliers. Store the solution at 4°C.

## Nucleic Acids and Oligonucleotides

### *DNA samples*

## Special Equipment

### *Binder or "bulldog" paper clips (6–8, 2 inch/5 cm width)*

### *Electrophoresis apparatus, glass plates, comb, and spacers*

Some vertical electrophoresis tanks obtained from commercial sources are constructed to hold glass plates of varying sizes. Spacers (usually Teflon, sometimes Lucite) vary in thickness from 0.5 mm to 2.0 mm. The thicker the gel, the hotter it will become during electrophoresis. Overheating results in "smiling" bands of DNA and other problems. Thicker gels must be used when preparing large quantities of DNA (>1 µg/band); however, in general, thinner gels are preferred, as they produce the sharpest and flattest bands of DNA.

### *Gel-sealing tape*

Common types of lab tape, such as Time tape or VWR lab tape, are appropriate for sealing the ends of the acrylamide gel during pouring.

### *Gel temperature-monitoring strips (optional)*

These strips are thermochromic liquid crystal (TLC) indicators that change color as the temperature of the gel rises during electrophoresis. Temperature-monitoring strips are sold by several commercial companies, including BioWhittaker. Temperature-monitoring strips are not needed if an electrophoresis apparatus that has an in-built thermal sensor is used.

*Micropipette with drawn-out plastic tip (e.g., Research Products International) or a Hamilton syringe*  
*Petroleum jelly*  
*Syringe (50 cc)*

## METHOD

---

### Assembling the Apparatus and Preparing the Gel Solution

1. If necessary, clean the glass plates and spacers with KOH/methanol.
2. Wash the glass plates and spacers in warm detergent solution and rinse them well, first in tap water and then in deionized H<sub>2</sub>O. Hold the plates by the edges or wear gloves, so that oils from the hands do not become deposited on the working surfaces of the plates. Rinse the plates with ethanol and set them aside to dry.
 

The glass plates must be free of grease spots to prevent air bubbles from forming in the gel.
3. (*Optional*) Treat one surface of one of the two plates with siliconizing fluid (e.g., Sigmacote or Acrylease): Place the glass on a pad of paper in a chemical fume hood and pour a small quantity of siliconizing fluid onto the surface. Wipe the fluid over the surface of the plate with a pad of Kimwipes, and then rinse the plate in deionized H<sub>2</sub>O. Dry the plate with paper towels.
 

This treatment prevents the gel from sticking tightly to one plate and reduces the possibility that the mold will tear when the mold is dismantled after electrophoresis.
4. Assemble the glass plates with spacers:
  - a. Lay the larger (or unnotched) plate flat on the bench and arrange the spacers at each side parallel to the two edges.
 

Typically, the two plates are of slightly different size and one of them is notched.
  - b. Apply minute dabs of petroleum jelly to keep the spacer bars in position during the next steps.
  - c. Lay the inner (notched) plate in position, resting on the spacer bars.
  - d. Clamp the plates together with binder or "bulldog" paper clips and bind the entire length of the two sides and the bottom of the plates with gel-sealing tape to make a watertight seal.
 

Take particular care with the bottom corners of the plates, as these are the places where leaks often occur. An extra band of tape around the bottom of the plates can help to prevent leaks.

There are many types of electrophoresis apparatuses available commercially, and the arrangement of the glass plates and spacers differs slightly from manufacturer to manufacturer. Whatever the design, the aim is to form a watertight seal between the plates and the spacers so that the *unpolymerized gel solution* does not leak out. Several manufacturers also sell precast polyacrylamide gels, which are foolproof but expensive and often can be used only in the manufacturer's gel apparatus.
5. Taking into account the size of the glass plates and the thickness of the spacers, calculate the volume of gel required. Prepare the gel solution with the desired polyacrylamide percentage according to Table 5-7, which gives the amount of each component required to make 100 ml.
6. (*Optional*) Place the required quantity of acrylamide:bis solution in a clean sidearm flask with a magnetic stir bar. De-aerate the solution by applying vacuum, gently at first. Swirl the flask during de-aeration until no more air bubbles are released.
 

De-aeration of the acrylamide solution is not essential, but it does reduce the chance that air bubbles will form when thick gels (>1 mm) are poured, as well as reduce the amount of time required for polymerization.

## Casting the Gel

7. Perform the following manipulations over a tray so that any spilled acrylamide:bis solution will not spread over the bench. Wear gloves. Work quickly to complete the gel before the acrylamide polymerizes.
  - a. Add 35  $\mu$ l of TEMED for each 100 ml of acrylamide:bis solution, and mix the solution by gentle swirling.
 

Vinyl polymerization of monomer to cross-linked polymer is 90% complete within 5–15 minutes. However, only a fraction of the bisacrylamide molecules become incorporated into cross-links. The rest of the molecules are quickly converted to a cyclic form by an intramolecular reaction between side chains.

Gels can be cast with as much as 1  $\mu$ l of TEMED per milliliter of gel solution to increase the rate of polymerization.
  - b. Draw the solution into the barrel of a 50-cc syringe. Invert the syringe and expel any air that has entered the barrel. Introduce the nozzle of the syringe into the space between the two glass plates. Expel the acrylamide gel solution from the syringe, filling the space almost to the top.
 

Keep the remaining acrylamide solution at 4°C to reduce the rate of polymerization. If the plates have been well cleaned and well sealed, there should be no trapped air bubbles and no leaks. If air bubbles form, they can sometimes be coaxed to the top of the mold by gentle tapping or may be snagged with a bubble hook made of thin polypropylene tubing. If these methods fail, empty the gel mold, thoroughly clean the glass plates, and pour a new gel.
  - c. Place the glass plates against a test tube rack at an angle of  $\sim 10^\circ$  to the bench top.
 

This positioning decreases the chance of leakage and minimizes distortion of the gel.
8. As shown in Figure 12-9 in Chapter 12, immediately insert the appropriate comb into the gel, being careful not to allow air bubbles to become trapped under the teeth. The tops of the teeth should be slightly higher than the top of the glass. Clamp the comb in place with bulldog paper clips. If necessary, use the remaining acrylamide gel solution to fill the gel mold completely. Make sure that no acrylamide solution is leaking from the gel mold.
9. Allow the acrylamide to polymerize for 30–60 minutes at room temperature, adding more acrylamide:bis gel solution if the gel retracts significantly.
 

When polymerization is complete, a Schlieren pattern will be visible just beneath the teeth of the comb.
10. After polymerization is complete, surround the comb and the top of the gel with paper towels that have been soaked in 1X TBE. Then seal the entire gel in Saran Wrap and store it at 4°C until needed.
 

Gels may be stored for 1–2 days in this state before they are used.
11. When ready to proceed with electrophoresis, squirt 1X TBE buffer around and on top of the comb and carefully pull the comb from the polymerized gel. Use a syringe to rinse out the wells with 1X TBE. Remove the gel-sealing tape from the bottom of the gel with a razor blade or scalpel.
 

Wash out the wells thoroughly as soon as the comb is removed. Otherwise, small amounts of acrylamide solution trapped by the comb will polymerize in the wells, producing irregularly shaped surfaces that give rise to distorted bands of DNA.

## Loading the Samples and Running the Gel

12. Attach the gel to the electrophoresis tank, using large bulldog clips on the sides or clamps built into the apparatus. The notched plate should face inward toward the buffer reservoir.

13. Fill the reservoirs of the electrophoresis tank with electrophoresis buffer prepared from the same batch of 5x TBE used to cast the gel. Use a bent Pasteur pipette or syringe needle to remove any air bubbles trapped beneath the bottom of the gel.

It is important to use the same batch of electrophoresis buffer in both of the reservoirs and in the gel. Small differences in ionic strength or pH produce buffer fronts that can greatly distort the migration of DNA.

14. Use a Pasteur pipette or a syringe to flush out the wells once more with 1x TBE. Mix the DNA samples with the appropriate amount of 6x gel-loading buffer. Load the mixture into the wells using a Hamilton syringe or a micropipette equipped with a drawn-out plastic tip.

Usually, ~20–100  $\mu$ l of DNA sample is loaded per well depending on the size of the slot. Do not attempt to expel all of the sample from the loading device, as this almost always produces air bubbles that blow the sample out of the well. In many cases, the same device can be used to load many samples, provided it is thoroughly washed between each loading. However, it is important not to take too long to complete loading of the gel; otherwise, the samples will diffuse from the wells.

15. Connect the electrodes to a power pack (positive electrode connected to the bottom reservoir), turn on the power, and begin the electrophoresis run.

Nondenaturing polyacrylamide gels are usually run at voltages between 1 V/cm and 8 V/cm. If electrophoresis is carried out at a higher voltage, differential heating in the center of the gel may cause bowing of the DNA bands or even melting of the strands of small DNA fragments. Therefore, with higher voltages, gel boxes that contain a metal plate or extended buffer chamber should be used to distribute the heat evenly. Many types of gel apparatuses are equipped with thermal sensors that monitor the temperature of the gel during the run. These are particularly useful when striving to minimize variation from one gel run to the next. Alternatively, use a gel-temperature-monitoring strip.

16. Run the gel until the marker dyes have migrated the desired distance (please see Table 5-6). Turn off the electric power, disconnect the leads, and discard the electrophoresis buffer from the reservoirs.

17. Detach the glass plates, and use a scalpel or razor blade to remove the gel-sealing tape. Lay the glass plates on the bench (siliconized plate uppermost). Use a spacer or plastic wedge to lift a corner of the upper glass plate. Check that the gel remains attached to the lower plate. Pull the upper plate smoothly away. Remove the spacers.

Occasionally, the gel remains attached to the siliconized plate. In this case, turn the glass plates over and remove the nonsiliconized plate.

18. Use one of the methods described in Protocols 10 or 11 to detect the positions of bands of DNA in the polyacrylamide gel.

# Protocol 10

---

## Detection of DNA in Polyacrylamide Gels by Staining

**U**NLIKE AGAROSE GELS, POLYACRYLAMIDE GELS CANNOT BE CAST in the presence of ethidium bromide because the dye inhibits polymerization of the acrylamide. However, ethidium bromide can be used to stain the polyacrylamide gel after electrophoresis. Because polyacrylamide quenches the fluorescence of the dye, the sensitivity with which DNA can be detected is diminished.

The nucleic acid stain SYBR Gold (Molecular Probes) also can be used to stain a polyacrylamide gel after electrophoresis. It should not be incorporated into the gel at the time of polymerization, as incorporation into the polyacrylamide gel retards and distorts the migration of DNA.

Methylene blue staining, although somewhat less sensitive, provides a less expensive alternative to ethidium bromide or SYBR Gold.

### MATERIALS

---

**CAUTION:** Please see Appendix 12 for appropriate handling of materials marked with <!.>.

#### Buffers and Solutions

Please see Appendix 1 for components of stock solutions, buffers, and reagents. Dilute stock solutions to the appropriate concentrations.

*Staining solution: ethidium bromide solution (0.5 µg/ml stock solution), SYBR Gold stock solution, or methylene blue solution (0.001–0.0025% in TAE buffer) <!.>*

For a discussion of staining DNA in gels, please see Protocol 2 and Appendix 9.

#### Gels

*Polyacrylamide gel <!.>*

Prepare and run the gel as described in Protocol 9.

### METHOD

---

1. Gently submerge the gel and its attached glass plate in the appropriate staining solution. Use just enough staining solution to cover the gel completely, and stain the gel for 30–45 minutes at room temperature.



Try to minimize the movement of the staining solution across the surface of the gel during staining. The aim is to keep the gel attached to its supporting glass plate. If the gel becomes completely detached, it can usually be rescued from the staining solution on a large glass plate and transferred to a shallow water bath. In most cases, the gel can then be carefully unfolded and restored to its original shape. To avoid problems, some investigators use a piece of plastic mesh (mesh size 1 cm, available from garden and hardware stores) to hold the gel in place during staining.

2. Remove the gel from the staining solution, using the glass plate as a support, rinse the gel with water, and carefully blot excess liquid from the surface of the gel with a pad of Kimwipes.

▲ **IMPORTANT** Do not use absorbent paper; it will stick to the gel.

3. Cover the gel with a piece of Saran Wrap. Smooth out any air bubbles or folds in the Saran Wrap with the broad end of a slot comb or a crumpled Kimwipe.
4. Place a piece of Saran Wrap on the surface of a UV transilluminator. Invert the gel, and place it on the transilluminator. Remove the glass plate, leaving the gel on the Saran Wrap.
5. Photograph the gel as described in Protocol 2.

Note that ethidium bromide requires an orange filter and SYBR Gold requires a yellow or green filter. Maximum sensitivity with SYBR Gold staining is obtained by illuminating the gel from above (epi-illumination) with 254-nm wavelength UV light. Gels stained with methylene blue can be photographed with ordinary illumination and without a filter.

# Protocol 11

---

## Detection of DNA in Polyacrylamide Gels by Autoradiography

**B**ANDS OF RADIOACTIVE DNA SEPARATED BY ACRYLAMIDE GEL ELECTROPHORESIS may be detected by autoradiography. Analytical polyacrylamide gels containing radioactive DNA are usually fixed and dried before autoradiography. However, if bands of radioactive DNA are to be recovered from the gel (please see Protocols 4 and 12), the gel should generally not be fixed or dried. In this case, omit Steps 1–3, and proceed directly to Step 4 to process the gel for autoradiography.

### MATERIALS

---

**CAUTION:** Please see Appendix 12 for appropriate handling of materials marked with <!>.

#### Buffer and Solutions

Please see Appendix 1 for components of stock solutions, buffers, and reagents. Dilute stock solutions to the appropriate concentrations.

*Acetic acid (7% v/v) <!>*

#### Gels

*Polyacrylamide gel <!>*

Prepare and run the gel as described in Protocol 9 of this chapter.

#### Special Equipment

*Commercial gel dryer (optional)*

*Plastic mesh piece (mesh size 1 cm, available from garden and hardware stores) (optional)*

*Radioactive ink or chemiluminescent markers <!>*

*Whatman 3MM filter paper*

### METHOD

---

1. Immerse the gel, together with its attached glass plate, in 7% acetic acid for 5 minutes. Remove the gel from the fixative by carefully lifting the glass plate from the fluid.

Try to minimize the movement of fluid across the surface of the gel during fixation. The aim is to keep the gel attached to its supporting glass plate. If the gel becomes completely detached, it can usually be rescued from the acetic acid on a larger glass plate and transferred to a shallow water

bath. In most cases, the gel can then be carefully unfolded and restored to its original shape. To avoid problems, some investigators use a piece of plastic mesh to hold the gel in place during fixation.

2. Rinse the gel briefly in deionized H<sub>2</sub>O. Remove excess fluid from the surface of the gel with a pad of Kimwipes.  
**▲ IMPORTANT** Do not use absorbent paper; it will stick to the gel.
3. (Optional) Dry the gel onto a piece of Whatman 3MM paper using a commercial gel dryer.  
Drying the gel is generally necessary only when the gel contains DNA labeled with weak  $\beta$ -emitting isotopes such as <sup>35</sup>S or such small amounts of <sup>32</sup>P-labeled DNA that long exposures (longer than 24 hours) are necessary to obtain an adequate autoradiographic image.
4. Wrap the gel, together with its supporting glass plate, in Saran Wrap. Smooth out any air bubbles or folds in the Saran Wrap with the broad end of a slot comb or a crumpled Kimwipe.  
If the DNA samples separated through the gel have been labeled with <sup>35</sup>S, it is better not to use Saran Wrap because the plastic film will block weak  $\beta$  particles. Make sure that the gel is very dry (in Step 3) and proceed to Step 5.
5. To align the gel and the film, attach adhesive dot labels marked with radioactive ink (please see Appendix 8) or with chemiluminescent markers to the surface of the Saran Wrap. Cover the radioactive ink labels with cellophane tape to prevent contamination of the film holder or intensifying screen.
6. Invert the gel and expose it to X-ray film (e.g., Kodak XAR-5 or equivalent) as follows:
  - a. In a darkroom, tape the sealed gel to a piece of X-ray film cut to the same size as the glass plate.  
The plate serves as a weight to ensure good contact between the Saran Wrap and the X-ray film.
  - b. Wrap the gel and film in light-tight aluminum foil.  
Do not use a metal film cassette; it may break the glass plate and crush the gel. If the gel has been dried onto a piece of Whatman 3MM paper (Step 3), a metal film cassette may be used.
  - c. Expose the film for the appropriate period of time at room temperature or at -70°C with or without an intensifying screen.
  - d. Develop, fix, and dry the X-ray film as recommended by the manufacturer.

# Protocol 12

---

## Isolation of DNA Fragments from Polyacrylamide Gels by the Crush and Soak Method

**T**HE STANDARD METHOD TO RECOVER DNA FROM POLYACRYLAMIDE GELS is the “crush and soak” technique originally described by Maxam and Gilbert (1977). The eluted DNA is generally free of contaminants that inhibit enzymes or that are toxic to transfected or microinjected cells. The method requires time but little labor and results in recovery of <30%–90% yield, depending on the size of the DNA fragment. It can be used to isolate both double- and single-stranded DNAs from neutral and denaturing polyacrylamide gels, respectively. The method is widely used to isolate synthetic oligonucleotides from denaturing polyacrylamide gels (please see Chapter 10, Protocol 1) and, occasionally, to recover end-labeled DNA for chemical DNA sequencing (please see Chapter 12, Protocols 8 and 9). DNA recovered from polyacrylamide gels by crushing and soaking is generally suitable for use as a hybridization probe, as a probe in gel-retention assays, or as a template in chemical sequencing and enzymatic reactions. The following procedure is a modification of the technique described by Maxam and Gilbert (1977, 1980). Faster methods to recover double-stranded DNA involve:

- embedding the piece of polyacrylamide containing the DNA of interest into a slit cut in an agarose gel, and then eluting the DNA onto a sliver of DEAE-cellulose membrane as described in Protocol 3
- electroeluting the DNA from the gel into a dialysis bag (Protocol 4)

### MATERIALS

---

**CAUTION:** Please see Appendix 12 for appropriate handling of materials marked with <!>.

### Buffers and Solutions

Please see Appendix 1 for components of stock solutions, buffers, and reagents. Dilute stock solutions to the appropriate concentrations.

#### *Acrylamide gel elution buffer*

- 0.5 M ammonium acetate
- 10 mM magnesium acetate tetrahydrate
- 1 mM EDTA (pH 8.0)
- 0.1% (w/v) SDS (optional)

SDS improves the efficiency of recovery, most probably by blocking nonspecific adsorption of DNA to the walls of the tube. However, SDS is tenacious and difficult to remove from the eluted DNA, especially when purifying oligonucleotides on Sep-Pak columns. Perhaps the best advice is to use SDS only when attempting to recover very small amounts (<20 ng) of DNAs >1 kb in size, where recovery is already inefficient and further losses may prejudice the success of the experiment. This is not usually the case when purifying synthetic oligonucleotides, which are always relatively small and usually available in abundance.

Other buffers may be substituted for acrylamide gel elution buffer. For example, if the DNA fragment is radiolabeled and is to be used as a hybridization probe, hybridization buffer can be substituted.

*Chloroform* <!>

*Ethanol*

*6x Gel-loading buffer*

For a list of gel-loading buffers and recipes, please see Table 5-8 in Protocol 9.

*Phenol:chloroform (1:1, v/v)* <!>

*Sodium acetate (3 M, pH 5.2)*

*TE (pH 8.0)*

## Gels

*Polyacrylamide gel* <!>

Prepare and run the gel as described in Protocol 9 of this chapter.

Please see Step 1.

*Polyacrylamide gel or high-resolution agarose gel of the appropriate concentration*

Prepare and run the gel as described in Protocols 9 and 1, respectively.

Please see Step 12.

## Nucleic Acids and Oligonucleotides

*DNA markers generated by restriction digests of known quantities of the DNA sample*

*DNA sample*

## Special Equipment

*Column (disposable plastic) equipped with a frit (e.g., Quik-Sep columns, Isolabs, Inc.), or a syringe barrel containing a Whatman GF/C filter or packed siliconized glass wool*

*Rotating wheel/rotary platform in an incubator preset to 37°C*

*Ultraviolet lamp, hand-held, long-wavelength (302 nm)*

## Additional Reagents

*Step 1 of this protocol requires the reagents listed in Protocol 9 of this chapter.*

*Step 1 of this protocol also requires the reagents listed in either Protocol 10 or 11 of this chapter.*

## METHOD

---

1. Carry out polyacrylamide gel electrophoresis of the DNA sample and markers as described in Protocol 9. Locate the DNA of interest by autoradiography (Protocol 11) or by examination of ethidium bromide- or SYBR Gold-stained gels in long-wavelength (302 nm) UV light (Protocol 10).
2. Use a clean sharp scalpel or razor blade to cut out the segment of the gel containing the band of interest, keeping the size of the polyacrylamide slice as small as possible. This can be achieved by any of the following methods:
  - While the DNA is illuminated with UV light, cut through both the gel and the Saran Wrap, and then peel the small piece of gel containing the DNA from the Saran Wrap.

- Use a permanent felt-tipped marker (e.g., Sharpie pen) to outline the DNA band on the back of the glass plate while the gel is illuminated from below with UV light. Invert the gel, remove the Saran Wrap, and cut out the band using the marker outline as a guide.
- In the case of a fragment of DNA identified by autoradiography, place the exposed autoradiographic film on the Saran Wrap and align it with the gel. Use a permanent marker to outline the position of the desired DNA fragment on the back of the glass plate. Remove the exposed film and Saran Wrap and cut out the band.

Photograph or autoradiograph the gel after the bands of DNA have been excised to produce a permanent record of the experiment.

3. Transfer the gel slice to a microfuge tube or a polypropylene tube. Use a disposable pipette tip or inoculating needle to crush the polyacrylamide gel against the wall of the tube.  
Alternatively, use a clean scalpel or razor blade to slice the gel into thin slivers prior to placement in the elution tube.
4. Calculate the approximate volume of the slice and add 1–2 volumes of acrylamide gel elution buffer to the microfuge tube.
5. Close the tube and incubate it at 37°C on a rotating wheel or rotary platform.  
At this temperature, small fragments of DNA (<500 bp) are eluted in 3–4 hours; larger fragments take 12–16 hours.
6. Centrifuge the sample at maximum speed for 1 minute at 4°C in a microfuge. Transfer the supernatant to a fresh microfuge tube, being extremely careful to avoid transferring fragments of polyacrylamide (a drawn-out Pasteur pipette works well).
7. Add an additional 0.5 volume of acrylamide gel elution buffer to the pellet of polyacrylamide, vortex briefly, and centrifuge again. Combine the supernatants.
8. (*Optional*) Remove any remaining fragments of polyacrylamide by passing the supernatant through a disposable plastic column equipped with a frit (e.g., Isolabs, Inc., Quick-Sep columns) or a syringe barrel plugged with a Whatman GF/C filter or siliconized glass wool.  
The eluted DNA can be extracted with phenol:chloroform and chloroform to remove SDS, which can inhibit subsequent enzymatic manipulation of the DNA. Precipitate the extracted DNA with ethanol as described in Step 9 and continue with the remainder of the protocol.
9. Add 2 volumes of ethanol at 4°C to the flow-through and store the solution on ice for 30 minutes. Recover the DNA by centrifugation at maximum speed for 10 minutes at 4°C in a microfuge.  
Even small quantities of DNA are efficiently precipitated by ethanol in this method, perhaps because of the presence of small amounts of polyacrylamide in the eluate (Gaillard and Strauss 1990). However, 10 µg of carrier RNA can be added before precipitation, which may improve even further the recovery of small amounts of DNA. Before adding the RNA, make sure that the presence of RNA will not compromise subsequent reactions with the DNA. (For preparation of carrier RNA, please see Protocol 3.)
10. Dissolve the DNA in 200 µl of TE (pH 8.0), add 25 µl of 3 M sodium acetate (pH 5.2), and again precipitate the DNA with 2 volumes of ethanol as described in Step 9.
11. Carefully rinse the pellet once with 70% ethanol, and dissolve the DNA in TE (pH 8.0) to a final volume of 10 µl.
12. Check the amount and quality of the fragment by polyacrylamide or high-resolution agarose gel electrophoresis:
  - a. Mix a small aliquot (~20 ng) of the final preparation of the fragment with 10 µl of TE (pH 8.0), and add 2 µl of the desired gel-loading buffer (please see Table 5-4).

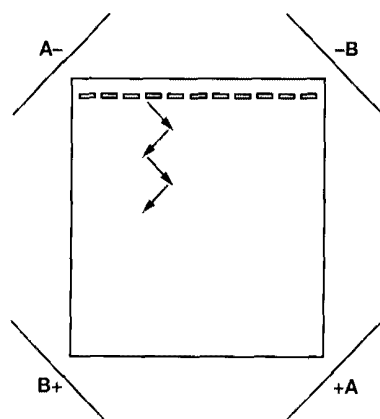
- b. Load and run a polyacrylamide or high-resolution agarose gel of the appropriate concentration, using as markers restriction digests of known quantities of the original DNA. The isolated fragment should comigrate with the correct fragment in the restriction digest.
- c. Examine the gel carefully for the presence of faint fluorescent bands that signify the presence of contaminating species of DNA. It is often possible to estimate the amount of DNA in the final preparation from the relative intensities of fluorescence of the fragment and the markers.

Only rarely is further purification of the recovered DNA required. The best option is chromatography on DEAE-Sephacel columns (please see Protocol 5), or any of a wide variety of specialty resins that are available commercially (please see Chapter 1, Protocol 9). Many of the specialty resins come in prepacked columns that are appropriate for purifying small amounts of DNA using a microfuge. Make sure that the resin chosen is appropriate for purifying linear DNA molecules as opposed to circular plasmids.

## Pulsed-field Gel Electrophoresis

**A**LL LINEAR DOUBLE-STRANDED DNA MOLECULES THAT ARE LARGER than a certain size migrate through agarose gels at the same rate. Above this critical length, the velocity of DNA molecules becomes almost independent of their size and depends chiefly on the strength of the electric field. In practical terms, this relationship means that DNAs greater than ~40 kb in length cannot be easily separated by applying a constant electrical field to horizontal agarose gels. This problem is solved by pulsed-field gel electrophoresis (Carle and Olson 1984, 1985; Schwartz and Cantor 1984; Carle et al. 1986; Chu et al. 1986), in which the electric field is switched periodically between two different directions with pulse times ranging from 0.1 to 1000 seconds or more. This method allows the separation of DNA molecules up to ~5 Mb in length. Fractionation occurs because the time required for a DNA molecule to change direction in response to the fluctuating electrical field depends on its size: Shorter molecules can reorient more quickly and can therefore move through the gel faster than longer molecules.

The general concept of PFGE apparatus design is shown schematically in Figure 5-7. This design, the original OFAGE (orthogonal field agarose gel electrophoresis) device of Carle and Olson (1984), is visually and conceptually simple. Two electrode pairs, A and B, are shown. When the A electrodes are activated, the negatively charged DNA migrates downward and to the right; when these electrodes are turned off, the B electrodes are activated, and the DNA now migrates downward and to the left. This regular alternation of A and B fields continues throughout the gel run and causes the DNA to follow a zigzag path as shown, with a net migration in the downward direction. Note that “pulsed” field electrophoresis is a slight misnomer; it is more accurately called “alternating” field electrophoresis. The interval at which the field direction is changed is termed the pulse time and may range from a few seconds to hours, with progressively larger DNA fragments resolving at longer pulse times.



**FIGURE 5-7** Concept of Pulsed-field Electrophoresis

An agarose gel is represented by the box; the series of short horizontal rectangles indicate the wells into which the DNA is loaded. A and B represent two sets of electrodes. When the A electrodes are activated, the DNA is driven anodically downward and to the right as indicated by the first arrow. When the A electrodes are turned off, the B electrodes are immediately activated. The DNA now moves downward and to the left. The path of a DNA molecule subjected to continued alternation of field direction is shown by the arrows.



As described earlier in the introduction to this chapter, the effect of alternating fields can be explained by considering that a DNA molecule stretches out and orients parallel to an electric field. It can then be moved through successive pores in the agarose gel by reptation. When the field direction changes, the DNA molecule must reorient before it can move in the new direction. As the field direction regularly changes, the DNA must regularly change directions. The larger the molecule, the more time required to reorient and turn corners, leaving proportionately less time (within each pulse) available to move in the new direction. For experiments illustrating this idea, please see Smith et al. (1989) and Schwartz and Koval (1989).

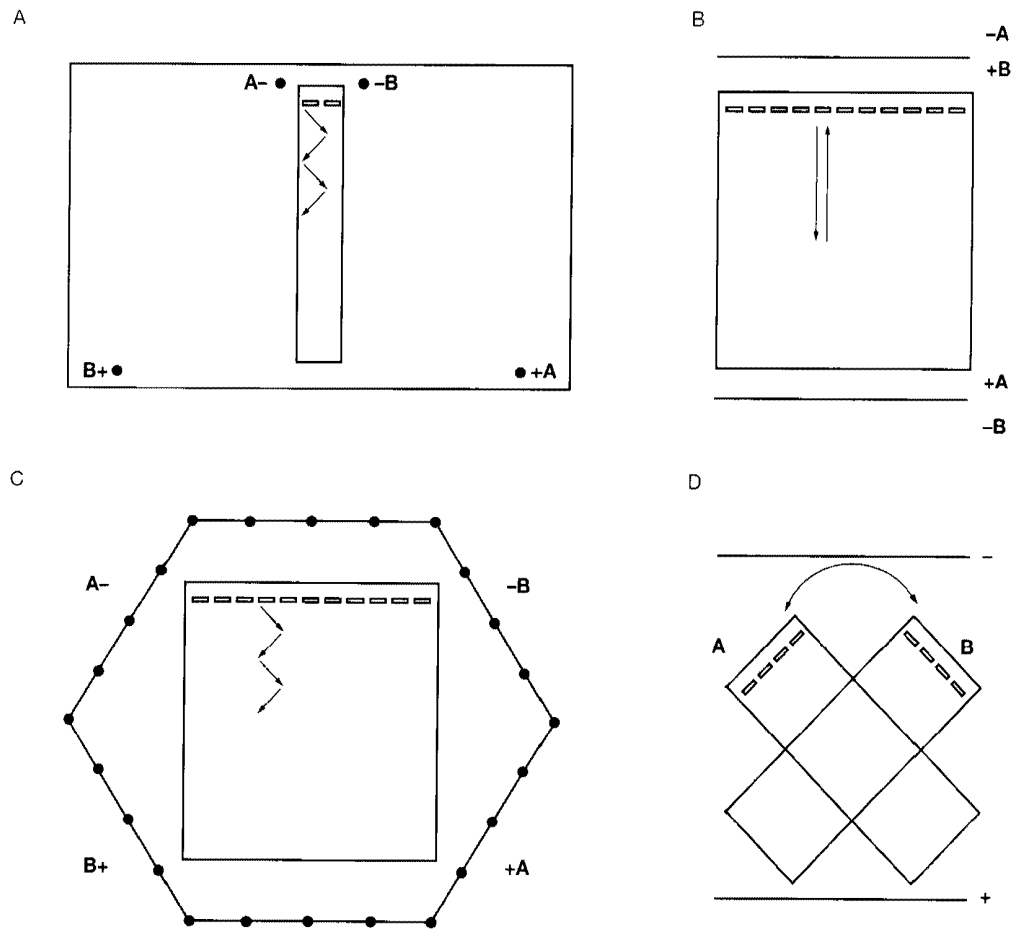
Schwartz et al. (1983) introduced the concept of field alternation in 1983 by demonstrating its effectiveness in separating the chromosomes of the yeast *Saccharomyces cerevisiae*. Within 1 year, two designs were proposed, using either two sets of diode arrays or two sets of linear electrodes (similar to that shown in Figure 5-7) to provide the alternating fields (Schwartz et al. 1983; Carle et al. 1986). Both separated molecules as large as 1500 kb. The major, and important, drawback to these designs, however, was that the electrode geometries produced nonhomogeneous electric fields (as can be inferred by inspection of Figure 5-7), causing lane-to-lane variations in the speed and trajectory of DNA fragments. For many applications, these distortions in the path hindered interpretation of band patterns. As a result, many different pulsed-field designs have been developed in attempts to generate uniform fields.

In the remainder of this chapter, we present protocols for extracting genomic DNA of very high molecular weight from lower and higher eukaryotes, a method to digest genomic DNA embedded in agarose and to generate size standards for use in PFGE, protocols for two different and popular forms of PFGE — TAFE and CHEF gels — and two methods for recovering DNA fragments from pulsed-field gels. These protocols were provided by Kathleen Gardiner (University of Colorado, Boulder).

## TYPES OF APPARATUSES

Four popular designs are illustrated schematically in Figure 5-8 and are described below. (A note on nomenclature: Acronyms abound. They are used to refer to some specific aspect of the particular pulsed-field apparatus. Commercial development has added additional catchy names, e.g., TAFE for transverse alternating field electrophoresis.)

- **The vertical pulsed field system** (now called TAFE) (Gardiner and Patterson 1989): This apparatus (Figure 5-8A) is essentially a three-dimensional model of the original OFAGE (Figure 5-8). The gel stands upright between two linear electrode pairs and is supported by two thin plastic strips and the buoyancy of the buffer. DNA runs in a straight path in all lanes because the field is uniform across the gel; quite sharp bands are obtained, relating to the field gradient down the gel. The angle between the alternate fields is  $110^\circ$  at the wells, but it is much greater further down the gel.
- **Field inversion (FIGE)** (Carle et al. 1986; Turmel and Lalande 1988): This simplest of the pulsed-field designs (Figure 5-8B) uses a single pair of electrodes and a standard submarine agarose gel electrophoresis box. During the gel run, the field regularly inverts, first driving the DNA out of the wells and then back toward the wells. Thus, the angle between the fields is  $180^\circ$ . Either the forward pulse time or the forward field must be greater than the reverse for net forward migration of the DNA. To avoid anomalies in migration of fragments  $>600$  kb, "ramping" is frequently used: The forward and reverse pulse times (and/or fields) are increased, either gradually or in a step fashion during the run.
- **Rotating gels** (Anand 1986; Southern et al. 1987): Instead of alternating the field direction, the gel (Figure 5-8D) is mounted on a rotating platform which then alternates between two ori-



**FIGURE 5-8 Pulsed-field Configurations Producing Electric Fields That Are Uniform in All Lanes of the Gel**

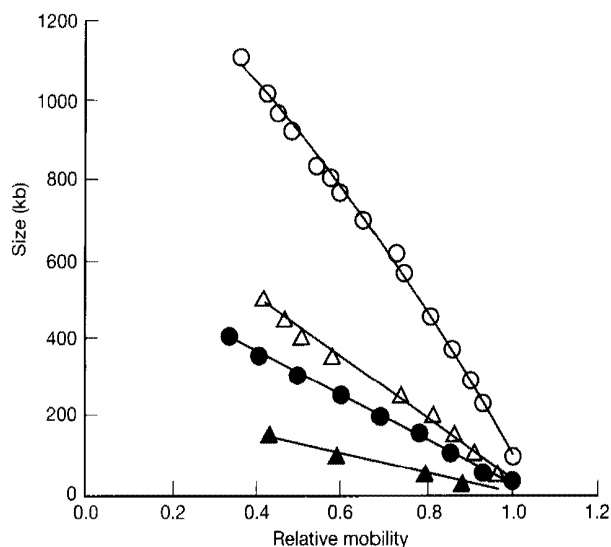
Components of electrode sets, A and B, are represented as dots or lines. (A) The vertical pulsed-field system or transverse alternating fields (TAFE). (B) Field inversion. (C) Contour-clamped homogeneous electric field apparatus (CHEF). (D) Rotating apparatus (the gel alternates between positions A and B).

entations ( $120^\circ$  apart) within a constant electric field. From the frame of reference of the DNA, this movement is the same as changing the field direction.

- **Contour-clamped homogeneous electric field (CHEF) device** (Chu et al. 1986; Orbach et al. 1988): A hexagonal array of point electrodes in a voltage divider circuit (Figure 5-8C) produces homogeneous fields (oriented at  $120^\circ$ ) approximating those of pairs of infinitely long parallel electrodes. The electrophoresis device (Schwartz et al. 1989) uses an effective and simpler array of diodes. Clark et al. (1988) modified the CHEF system to use computer-controlled digital/analog converters at each electrode. This system retains the hexagonal array and can generate an essentially unlimited variety of field strengths and angles.

## FACTORS AFFECTING RESOLUTION

All current PFGE designs, although differing in kind, number, and arrangement of electrodes, have eliminated major distortions, and all are capable of resolving fragments exceeding 6000 kb in size. Resolution in all systems also depends on the same set of electrophoretic parameters: pulse



**FIGURE 5-9** Effect of Pulse Time on Migration of DNA through a Pulsed-field Gel

Molecular weight vs. mobility is shown for bands of  $\lambda$  concatemers represented by triangles (4" and 15" pulse) or *S. cerevisiae* chromosomes represented by circles (15" and 60"). (Open circles) 60" 6 V/cm; (closed circles) 15" 6 V/cm; (open triangles) 15" 8 V/cm; (closed triangles) 4" 6 V/cm.

time, field strength, temperature, buffer composition, type and concentration of agarose, and an obtuse angle between the fields (Olson 1989). In practice, most of these variables are generally kept constant, and the size range to be resolved is manipulated by increasing the pulse time to separate larger molecules and by decreasing it for smaller molecules.

### Pulse Time

Figure 5-9 illustrates the relationship between molecular size and mobility (using  $\lambda$  concatemers and *S. cerevisiae* chromosomes as standards) for pulse times of 4", 15", and 60". In each case, the relationship is linear through a range where excellent calculation of unknown fragment sizes would be possible. (This contrasts with standard electrophoresis where mobility of DNA molecules is inversely proportional to the log of their molecular weight.) Larger fragments run above the linear range, in the "compression zone," a broad band of material up to 1500–2000 kb in size. No inference regarding size can be made at any pulse time for any fragment in the compression zone. Fragments >2000 kb may be retained within the wells or may run in the "zone of no resolution" between the wells and the compression zone. In this latter case, "trapping" of the DNA in multiple pores of the agarose has prevented resolution (Olson 1989). Different conditions for separation in this size class are required (see below).

### Voltage

Figure 5-9 also illustrates that if the pulse time is held constant (15"), increasing the field strength (from 6 to 8 V/cm) increases the size of the largest material resolved. Field strengths that are too high, however, result in trapping at progressively smaller fragment sizes. Thus, there is an upper limit to the speed with which PFGE separations can be carried out.

Voltage effects and trapping are particularly important considerations for resolution of >2000 kb. First, as expected from the results above, a long pulse time must be used. However,

because the DNA is so very large, the voltage must also be lowered to prevent trapping. This in turn requires a further increase in the pulse time. Thus, to achieve resolution in the megabase range, long slow gel runs are required, ~1–2 V/cm, with a 30–90-minute pulse time, for several days. Such conditions resolve the chromosomes of *S. pombe*, *Candida albicans*, and *N. crassa*, which range from ~1600 kb to >6000 kb. Under these conditions, however, fragments of 2–1100 kb all migrate in a broad diffuse band, reminiscent of standard constant field electrophoresis. Long pulse times mimic constant electric fields from the viewpoint of smaller DNA fragments. There are conditions that separate the full range from 50 kb to 6000 kb on a single gel (Southern et al. 1987; Clark et al. 1988), but these generally sacrifice optimum resolution of all size classes.

### Field Angle

The angle between fields is typically 110–120°, and it has been shown that varying the angle from 105° to 165° has small effects on performance (Birren et al. 1988). Effective use of a 90° field angle has been demonstrated by Bancroft and Wolk (1988). This system uses the following field pattern: downward, right, downward, left. Pulses in the right and left directions are at 90° to, and of twice the duration of, those in the downward direction. This straightforward system produces homogeneous fields and therefore (relatively) straight migration of the DNA.

### Temperature

Unlike standard agarose gel electrophoresis, which is generally carried out at room temperature, PFGE is generally done at 4–15°C. DNA migrates faster at higher temperatures; however, higher temperatures also cause trapping at lower fragment sizes and significant band broadening. Control of the temperature throughout the gel run also aids in controlling the reproducibility of the separations and the mobilities.

## SPECIAL CONSIDERATIONS

---

### DNA Preparation

Standard procedures for DNA isolation in solution are not appropriate for preparing DNA for PFGE analysis. To prevent shearing of the long DNA fragments, PFGE DNA is prepared by embedding live cells in agarose (Schwartz and Cantor 1984). Prior quantitation of cells is an important consideration, because the mobility of DNA in PFGE is more sensitive to concentration than it is on standard gels. Typical quantities of mammalian DNA loaded per lane on the latter range from 3 µg to 20 µg; on pulsed-field gels, amounts must be restricted to <1–2 µg to prevent anomalous slowing of migration.

### Molecular-weight Markers

Lower eukaryotes, with their small genomes and small number of chromosomes, together with bacteriophage λ, have provided a valuable source of accurately sized standards in the size range required in PFGE.

- **50-kb ladder:** λ DNA (~50 kb), embedded in agarose, can be ligated to produce a mixture of monomers, dimers, trimers, etc. These concatemers separate on PFGE to produce a “ladder” of bands, each successive “rung” corresponding to a 50-kb increment. Ladders spanning 50–1000 kb (20 bands) can be formed (please see Protocol 16).

- **200–2000-kb range:** *S. cerevisiae* has 16 chromosomes ranging in size from ~200 kb to >2000 kb. These can be prepared intact from cells embedded in agarose. Different strains of *S. cerevisiae* will give slightly different patterns because of small variations in chromosome sizes. Fewer than 16 bands will be seen when two or more chromosomes are very close in size.
- **Megabase range:** *S. pombe* has three chromosomes, 3.5, 4.6, and 5.7 Mb in size. *C. albicans* and *N. crassa* also have chromosomes in this size class.

## Restriction Enzymes

The ability to exploit the resolving power of PFGE depends on the ability to generate fragments reproducibly in the range of 100–1000 kb average size. Weil and McClelland (1989) have shown that in bacterial genomes of >45% G+C content, enzymes whose recognition sequence contains the tetranucleotide CTAG cut less than once in 100 kb. In those of <45% G+C, enzymes with recognition sites containing CCG and CGG cut less than once in 100 kb. Mammalian genomes are ~40% G+C and are depleted for the dinucleotide CpG (Swartz et al. 1962). Therefore, enzymes such as *NotI*, *EagI*, *SstII*, and *BssHII*, with 8- and 6-bp G-C-rich recognition sequences, generate fragments in a complete digest averaging >500 kb (Swartz et al. 1962; Drmanac et al. 1986).

## Miscellaneous

Several procedures require little or no modification for use with PFGE.

- **Southern transfers:** Capillary and alkaline transfer procedures are the same as those for standard gels, with the addition of a brief (3–20 minute) HCl acid treatment before the denaturation step. The acid treatment ensures depurination and sufficient breakage of the large fragments to allow their passive transfer from the gel.
- **Agarose:** The use of high-quality agarose is recommended for pulsed-field gels. For making plugs, low-melting-temperature agarose is required.
- **Buffer:** Standard Tris-borate buffer (TBE) is most widely used in PFGE.
- **Preparative gels:** Preparative electrophoresis using low-melting-temperature agarose is equally effective for the 50-kb to >1000-kb size range as it is for the standard <25-kb range.

# Protocol 13

---

## Preparation of DNA for Pulsed-field Gel Electrophoresis: Isolation of DNA from Mammalian Cells and Tissues

**T**O AVOID SHEARING DURING THE EXTRACTION OF LARGE DNA MOLECULES, cells are lysed in situ in an agarose plug (Schwartz and Cantor 1984) or a bead (Cook 1984). Most investigators now use agarose plugs because of their higher efficiency (Anand 1986). Intact cells or nuclei are resuspended in molten, low-melting-temperature agarose and solidified in blocks whose size matches the thickness of the loading slot of the gel. Depending on the organism, any of a variety of substances are infused into the plug to cause lysis of the cells and removal of proteins from the DNA. These procedures yield DNA that is both intact and susceptible to cleavage by restriction enzymes in situ. Following digestion with the appropriate restriction enzyme(s), the plug can be loaded directly into the well of a pulsed-field gel or it can be melted before loading. Procedures for the lysis of mammalian cells are described in this protocol; procedures for yeast are described in Protocol 14.

This protocol describes the preparation of samples from cultured cells and tissue samples. White blood cells isolated from patients or animals also can be used as a source of high-molecular-weight DNA for PFGE. If desired, DNA can be prepared from nuclei isolated from mammalian cells (please see Chapter 17, Protocol 1). However, it is our experience that no advantage is gained from preparing DNA from nuclei, as DNA isolated from intact cells is equally susceptible to cleavage by restriction enzymes.

### MATERIALS

---

**CAUTION:** Please see Appendix 12 for appropriate handling of materials marked with <!>.

#### Buffers and Solutions

Please see Appendix 1 for components of stock solutions, buffers, and reagents. Dilute stock solutions to the appropriate concentrations.

*EDTA (0.5 M, pH 8.0)*

*L buffer*

0.1 M EDTA (pH 8.0)

0.01 M Tris-Cl (pH 7.6)

0.02 M NaCl

Store at 4°C.

*L buffer with proteinase K and Sarkosyl*

Amend the L buffer to a final concentration of 1% (w/v) Sarkosyl. Store L buffer with Sarkosyl at room temperature, and add proteinase K to 0.1 mg/ml just before use. (For additional information, please see Appendix 4.)

Some investigators substitute 0.5 M EDTA/1% (w/v) SDS/2 mg/ml proteinase K for the L buffer containing Sarkosyl and proteinase K. However, using high concentrations of proteinase K can become expensive and is unnecessary.

*Phosphate-buffered saline (PBS)*

Use ice-cold PBS for all cell and tissue preparations, except white blood cells. In the latter case, the PBS should be at room temperature.

*Red blood cell lysis buffer*

155 mM NH<sub>4</sub>Cl

0.1 mM EDTA

12 mM NaHCO<sub>3</sub>

Use this buffer for the isolation of white blood cells.

*TE (pH 7.6)*

*TE (pH 7.6) containing 40 µg/ml PMSF <!>*

Purchase phenylmethylsulfonyl fluoride (PMSF) as a solid, and store at room temperature. Dissolve the appropriate amount in TE just before use.

## Gels

*Low-melting-temperature agarose (1%)*

Use a grade of agarose that is suitable for PFGE (e.g., SeaPlaque GTG, BioWhittaker, or regular LMP, GIBCO-BRL).

## Centrifuges and Rotors

*Sorvall SS-34 rotor or equivalent*

## Special Equipment

*Cheesecloth*

Use for the preparation of fresh or frozen tissue samples.

*Glass homogenizer with a tight-fitting pestle, chilled in ice*

Use for the preparation of fresh tissue samples.

*Hemocytometer*

*LeucoPrep cell separation tubes (Becton Dickinson)*

Use for the isolation of white blood cells.

*Mortar and pestle, chilled to -70°C*

Use for the preparation of frozen tissue samples.

*Preformed Plexiglas molds (50–100 µl, Pharmacia or Bio-Rad), or a length of Tygon tubing (1/8 inch or 3.2-mm internal diameter), or a plastic syringe barrel (1 ml)*

Please see Step 4.

*Water baths preset to 42°C and 50°C*

## Cells and Tissues

*Cell or tissue sample*

This protocol describes methods for dealing with cultured cell lines, fresh or frozen tissue samples, or white blood cells.

## METHOD

---

1. Prepare cells or tissue samples.

### FOR CULTURED CELLS

- a. Wash cells that have been growing in culture three times in ice-cold PBS.
- b. Harvest the cells by scraping into a small volume of ice-cold PBS using a sterilized rubber policeman. Collect the cells by low-speed centrifugation.
- c. Resuspend the cells at a concentration of  $\sim 2 \times 10^7$  cells/ml in ice-cold L buffer.

### FOR FRESH TISSUE SAMPLES

- a. In a Petri dish, use a clean scalpel to mince freshly excised tissue into small cubes (1–2 mm<sup>3</sup>) and then homogenize the cubes in ice-cold PBS in a chilled glass homogenizer with a tight-fitting pestle.
- b. Remove fragments of connective tissue by filtration through two layers of cheesecloth.
- c. Wash the suspended cells three times in ice-cold PBS and resuspend them at a concentration of  $2 \times 10^7$  cells/ml in ice-cold L buffer.

Use a hemacytometer to count the cells (please see Appendix 8).

### FOR FROZEN TISSUE SAMPLES

- a. Grind frozen tissue to a fine powder using a mortar and pestle chilled to  $-70^\circ\text{C}$  and suspend the powdered tissue in ice-cold PBS.
- b. Remove fragments of connective tissue by filtration through two layers of cheesecloth.
- c. Wash the suspended cells three times in ice-cold PBS and resuspend them at a concentration of  $2 \times 10^7$  cells/ml in ice-cold L buffer.

### FOR WHITE BLOOD CELLS

- a. Fractionate 5–10 ml of starting blood by centrifugation in LeucoPrep cell separation tubes to grossly separate white and red blood cells.
  - b. To the white blood cell layer (buffy coat) add 4 volumes of red blood cell lysis buffer and gently mix by two to three inversions of the tube.
  - c. Incubate the cells in buffer for 5 minutes at room temperature, and then centrifuge the tube at 3000g (5000 rpm in a Sorvall SS-34 rotor) for 5 minutes at room temperature.
  - d. Resuspend the pellet in 1 ml of PBS at room temperature.
2. Prepare a volume of 1% low-melting-temperature agarose in L buffer that is equal to the volume of the cell preparation in Step 1. Cool the melted agarose to  $42^\circ\text{C}$ .
  3. When the agarose has cooled to  $42^\circ\text{C}$ , warm the cell suspension (Step 1) to the same temperature. Mix the melted agarose with the suspended cells. Stir the mixture with a sealed Pasteur pipette to ensure that the cells are evenly dispersed throughout the agarose.



4. Pipette or pour the molten mixture into preformed Plexiglas molds (50–100  $\mu$ l, Pharmacia or Bio-Rad), or draw the mixture into an appropriate length of Tygon tubing (1/8-inch or 3.2-mm internal diameter), or a 1-ml plastic syringe barrel. Store the molds for 15 minutes at room temperature, and then transfer them to 4°C for 15–30 minutes.
5. When the agarose has set, gently collect the plugs from the Plexiglas molds or gently blow out the agarose from the Tygon tubing or syringe barrel into a Petri dish. Cut the cylindrical plugs into 1-cm sections.

Each 1-cm length of agarose (45  $\mu$ l) should contain  $\sim 0.5 \times 10^6$  cells and yield  $\sim 2$ – $5 \mu$ g of DNA. Analysis of larger amounts of DNA in the individual lanes of a pulsed-field gel will distort the calculated molecular weights of the DNA fragments. The migration of large DNA fragments is significantly slowed when electrophoresis is carried out at high DNA concentrations. In turn, this slowing will lead to an overestimate of the size of an individual DNA fragment.

6. Transfer the plugs to 3 volumes of L buffer containing 0.1 mg/ml proteinase K and 1% (w/v) Sarkosyl. Incubate the plugs for 3 hours at 50°C. Replace the original digestion mixture with two volumes of fresh digestion mixture and continue the incubation for 12–16 hours at 50°C.

Be as careful as possible not to scar the agarose plugs when changing buffer solutions.

Some DNA isolation protocols include very long incubations (24–48 hours) at 50°C when treating the embedded cells with proteinase K in the presence of Sarkosyl. These extended incubation times are not required (Mortimer et al. 1990) and may lead to degradation of the high-molecular-weight DNA.

7. Incubate the plugs at room temperature in 50 volumes of TE (pH 7.6) with three to five changes of buffer over a period of 3 hours.
8. Remove the TE and replace with 2 volumes of TE (pH 7.6) containing 40  $\mu$ g/ml PMSE. Incubate for 30 minutes at 50°C.
9. Incubate the plugs at room temperature in 50 volumes of TE (pH 7.6) with three to five changes of buffer over a period of 3 hours.

The agarose plugs can be stored for several years in TE (pH 7.6) at 4°C. Plugs are best stored for longer periods of time in 0.5 M EDTA (pH 8.0) at 4°C. When mailed to other laboratories, plugs should be shipped at room temperature in tubes filled with 0.5 M EDTA (pH 8.0).

# Protocol 14

---

## Preparation of DNA for Pulsed-field Gel Electrophoresis: Isolation of Intact DNA from Yeast

**P**REPARATION OF YEAST DNA FOR ELECTROPHORESIS requires that the cells first be treated enzymatically to break down the cell wall, and then resuspended in low-melting-temperature agarose plugs. The plugs are infused with lysis buffer and proteases to facilitate disruption of the cells and removal of proteins from the DNA. This method is a slight modification of that originally described by Schwartz and Cantor (1984) and can be used to prepare both high-molecular-weight yeast chromosomes as size markers and yeast artificial chromosomes (YACs).

### CHROMOSOME SIZE IN YEASTS AND BACTERIA

The sizes of the chromosomes present in several species of bacteria and yeast (*S. cerevisiae* and *S. pombe*) have been determined. The sizes below are taken from Chu (1990a).

- ***S. cerevisiae* (strain YNN 295):** 245, 290, 370, 460, 580, 630, 700, 770, 800, 850, 945, 1020, 1200, 1570, and 2190 kb. YACs vary in size up to 2000 kb in the background of the native yeast chromosomes. Other yeast strains may have variations in chromosome size. In addition, chromosome XII varies in size between 2 and 3 Mb in different isolates of the YNN 295 strain. This chromosome contains ~1.1 Mb of low-copy-number DNA and variable numbers of tandem repeats encoding the rRNAs.
- ***S. pombe*:** 3500, 4600, and 5700 kb.
- ***E. coli*:** 4700 kb. This is a circular chromosome and must be linearized with low-dose  $\gamma$  irradiation before use as a size standard.

### MATERIALS

---

**CAUTION:** Please see Appendix 12 for appropriate handling of materials marked with <!>.

### Buffers and Solutions

Please see Appendix 1 for components of stock solutions, buffers, and reagents. Dilute stock solutions to the appropriate concentrations.

#### *Cell wash buffer*

0.01 M Tris-Cl (pH 7.6)

0.05 M EDTA (pH 8.0)

Store at room temperature.

EDTA (0.05 M, pH 8.0)

L buffer

- 0.1 M EDTA (pH 8.0)
- 0.01 M Tris-Cl (pH 7.6)
- 0.02 M NaCl
- Store at 4°C.

L buffer with proteinase K and Sarkosyl

Amend the L buffer to a final concentration of 1% (w/v) Sarkosyl. Store L buffer with Sarkosyl at room temperature, and add proteinase K to 0.1 mg/ml just before use.

TE (pH 7.6)

TE (pH 7.6) containing 40 µg/ml PMSF <!>

Purchase PMSF as a solid, and store it at room temperature. Dissolve the appropriate amount of PMSF in TE just before use.

Yeast lysis buffer

- 0.01 M Tris-Cl (pH 7.6)
- 0.5 M EDTA (pH 8.0)
- β-mercaptoethanol (1% v/v) <!>
- Add β-mercaptoethanol just before use. Store the concentrated solution in a chemical fume hood.

Yeast cell wall digestion enzymes:

Zymolyase 5000 (Kirin Breweries)

Dissolve zymolyase at 2 mg/ml in 0.01 M sodium phosphate containing 50% glycerol just before use.

or

Lyticase (67 mg/ml) (Sigma)

Dissolve at 67 mg/ml (900 units/ml) in 0.01 M sodium phosphate containing 50% glycerol just before use.

## Gels

Low-melting-temperature agarose (1%)

Use a grade of agarose that is suitable for PFGE (e.g., SeaPlaque GTG, BioWhittaker, or regular LMP, GIBCO-BRL).

## Centrifuges and Rotors

Sorvall GSA rotor or equivalent

## Special Equipment

Preformed Plexiglas molds (50–100 µl, Pharmacia or Bio-Rad), or a length of Tygon tubing (1/8-inch or 3.2-mm internal diameter), or a plastic syringe barrel (1 ml)

Please see Step 6.

## Cells and Tissues

Yeast suspension culture

Prepare the yeast culture at a volume and cell density appropriate to yield the required number of plugs of embedded DNA.

## METHOD

---

1. Collect yeast cells growing in suspension by centrifugation at 3000g (4300 rpm in a Sorvall GSA rotor) for 5 minutes at 4°C. Wash the cell pellet twice with cell wash buffer.
2. Resuspend the cells at a concentration of  $3 \times 10^9$  cells/ml in 0.05 M EDTA (pH 8.0) at 0°C.
3. Prepare an equal volume of 1% low-melting-temperature agarose in L buffer. Cool the melted agarose to 42°C.

4. Add 75  $\mu$ l of zymolyase or lyticase solution to the cell suspension of Step 2. Mix well.
5. Warm the cell suspension to 42°C. Mix 5 ml of the melted agarose with 5 ml of the suspended cells. Stir the mixture with a sealed Pasteur pipette to ensure that the cells are evenly dispersed throughout the agarose.
6. Pipette or pour the molten mixture into preformed Plexiglas molds (50–100  $\mu$ l, Pharmacia or Bio-Rad), or draw the mixture into an appropriate length of Tygon tubing (3/32-inch internal diameter) or a 1-ml plastic syringe barrel. Store the molds for 15 minutes at room temperature, and then transfer them to 4°C for 15–30 minutes.
7. When the agarose has set, collect the plugs from the Plexiglas molds, or blow out the agarose from the Tygon tubing or syringe barrel into a Petri dish. Cut the cylindrical plugs into 1-cm blocks.

Each block (50  $\mu$ l) should contain ~5  $\mu$ g of yeast chromosomal DNA.
8. Incubate the blocks in a chemical fume hood for 3 hours at 37°C in 3 volumes of yeast lysis buffer.
9. Add 3 volumes of L buffer containing 0.1 mg/ml proteinase K and 1% (w/v) Sarkosyl into a fresh Petri dish. Transfer the blocks to this buffer, and incubate them for 3 hours at 50°C. Replace the original digestion mixture with an equal volume of fresh digestion mixture and continue incubation for 12–16 hours at 50°C.

Be as careful as possible not to scar the agarose plugs when changing buffer solutions.
10. Incubate the plugs at 50°C in 50 volumes of TE (pH 7.6) containing 40  $\mu$ g/ml PMSF. After 1 hour, replace the original rinse buffer (TE containing PMSF) with an equal volume of fresh rinse buffer and continue incubation for another hour at 50°C.
11. Remove the rinse buffer (TE containing PMSF), replace with an equal volume of fresh TE (pH 7.6), and continue incubation for another hour at room temperature.

The agarose plugs can be stored for several years in TE (pH 7.6) at 4°C. Plugs are best stored for longer periods of time in 0.5 M EDTA (pH 8.0) at 4°C. When mailed to other laboratories, plugs should be shipped at room temperature in tubes filled with 0.5 M EDTA (pH 8.0).

# Protocol 15

---

## Restriction Endonuclease Digestion of DNA in Agarose Plugs

**G**ENOMIC DNA ISOLATED FROM MAMMALIAN, YEAST, OR BACTERIAL CELLS can be digested with restriction endonucleases by incubating agarose plugs containing the DNA in the presence of the desired endonuclease. The pores of the low-melting-temperature agarose plug are large enough to allow a restriction enzyme access to the substrate genomic DNA. After digestion, the DNA can be fractionated by PFGE and either isolated from the gel or analyzed by Southern blotting. This protocol describes the use of restriction enzymes to cleave genomic DNA in agarose plugs.

### CHOOSING RESTRICTION ENDONUCLEASES FOR PFGE

---

Restriction endonucleases used in PFGE have several unique characteristics. First, they typically have one or more CpG dinucleotides in their recognition sequences. CpG dinucleotide sequences are rare in most eukaryotic genomes; thus, restriction enzymes that recognize this sequence cut the DNA infrequently. Furthermore, a majority of CpG sequences are methylated in mammalian DNAs, and most restriction enzymes with this dinucleotide in their recognition sequences will not cleave methylated DNA. However, CpG sequences located 5' of many transcribed regions of the DNA are unmethylated (so-called *HpaII* tiny fragment or HTF sequences, or CpG islands; Bird et al. 1985) and are thus cleaved by these enzymes. The arrangement of extensively methylated and unmethylated regions in the DNA of a particular organism or cell line leads to the generation of discrete DNA fragments after restriction enzyme digestion of a population of DNAs. The pattern of digestion can differ between cell types due to differential methylation of the DNA. Second, some of these restriction enzymes (*NotI*, *SfiI*, *AscI*, *PacI*, *PmeI*) recognize and cleave 8-bp DNA sequences, again leading to infrequent cutting of DNA. Third, the enzymes must be of high purity and specific activity for use in PFGE. The presence of even trace nuclease impurities leads to smearing of the DNA in the gels and further compromises an already difficult method. Enzymes with low specific activity require the addition of too much enzyme or incubation times that are too long to be practical. A fourth consideration is cost. If a considerable excess of enzyme must be added to each plug to ensure complete digestion, then each experiment will be very expensive.

Table 5-9 gives examples of restriction enzymes that have proven useful in long-range mapping of genomic DNAs. The catalogs of restriction enzyme manufacturers often contain additional information regarding the ability of a given enzyme to cleave genomic DNA embedded in agarose. Keep in mind that the expected fragment sizes are averages. The exact distribution of sites

TABLE 5-9 Average Fragment Size Generated by Endonucleases

ENZYME	RECOGNITION SITE	EXPECTED AVERAGE FRAGMENT LENGTH (IN kb) <sup>a</sup>
<i>AscI</i>	GGCGCGCC	n.d. <sup>b</sup>
<i>BssHII</i>	GCGCGC	189
<i>BstBI</i>	TTCGAA	10.9
<i>EagI</i>	CGGCCG	149
<i>EspI</i>	TGCGCA	149
<i>MluI</i>	ACGCGT	132
<i>NotI</i>	GCGGCCGC	3000
<i>NruI</i>	TCGCGA	100.5
<i>PacI</i>	TTAATTA	60
<i>PmeI</i>	GTTTAAAC	50
<i>RsrII</i>	CGGA/TCCG	50
<i>SstII</i>	CCGCGG	148.5
<i>Sall</i>	GTCGAC	38.6
<i>SfiI</i>	GGCCNNNNNGGCC	149
<i>SmaI</i>	CCCGGG	27.2
<i>XhoI</i>	CTCGAG	20.6

<sup>a</sup> Taken from Drmanac et al. (1986). See also Smith (1990).

<sup>b</sup> n.d. indicates not determined.

for a particular enzyme will vary depending on base composition, methylation status, localization within regions of the chromosome (e.g., within G bands vs. R bands), and the type of HTF/CpG island present in the immediate 5'-flanking region (Bird 1989).

The use of six to eight restriction enzymes is optimal for the determination of a locus map when combined with multiprobe Southern blotting. Each enzyme should be used singly and in all possible combinations to ensure accuracy. Intentional (and unintentional) partial digests with a limiting amount of restriction enzyme are also useful for generating a map. In species for which a large proportion of the genomic DNA has been sequenced, comparison of the expected and observed mapping results can reveal dynamic regions of a locus. For additional hints on the assembly of a long-range map of a genomic locus, please see Smith (1990) and Poustka (1990).

## MATERIALS

### Buffers and Solutions

Please see Appendix 1 for components of stock solutions, buffers, and reagents. Dilute stock solutions to the appropriate concentrations.

#### 1× Restriction enzyme buffer

Prepare buffer according to the manufacturer's suggestions or purchase with restriction enzymes. Individual buffers should be supplemented with spermidine to enhance the efficiency of restriction digestion. High-salt buffers (containing 100–150 mM salt) should be supplemented to a final concentration of 10 mM spermidine, medium-salt buffers (50–100 mM salt) to 5 mM spermidine, and low-salt buffers (<50 mM salt) to 3 mM spermidine. It is best to supplement the buffers from a 0.1 M spermidine stock (dissolved in H<sub>2</sub>O) just before use.

TE (pH 7.6)

### Enzymes and Buffers

#### Restriction endonuclease(s)

For help in determining the appropriate restriction endonuclease(s) to use, please see the discussion on Choosing Restriction Endonucleases for PFGE in the introduction to this protocol.

## Gels

### *Gel for pulsed-field electrophoresis*

Prepare an appropriate PFGE gel according to the methods described in Protocol 17 (for TAFE) or Protocol 18 (for CHEF).

## Nucleic Acids and Oligonucleotides

### *Genomic DNA embedded in low-melting-temperature agarose plugs*

Please see Protocol 13 for the preparation of low-melting-temperature agarose plugs containing mammalian cell DNA or Protocol 14 for the preparation of plugs containing yeast DNA.

## Special Equipment

*Water bath preset to the optimum temperature for restriction endonuclease digestion*

## METHOD

---

1. If plugs have not been stored in TE (e.g., plugs received through the mail or those that have been stored in 0.5 M EDTA [pH 8.0]), incubate them in 50 volumes of TE (pH 7.6) for 30 minutes at room temperature. Transfer the plugs to 50 volumes of fresh TE (pH 7.6) and continue incubation for a further 30 minutes. Otherwise, proceed directly to Step 2.
2. Transfer the plugs to individual microfuge tubes, and add 10 volumes of the appropriate 1X restriction enzyme buffer to each tube. Incubate the tubes for 30 minutes at room temperature.
3. Remove the buffer and replace it with 2–3 volumes of fresh 1X restriction enzyme buffer. Add 20–30 units of the appropriate restriction enzyme to each tube, and incubate the tubes at the optimal temperature for the restriction enzyme: 3 hours if YAC DNA is used or 5–6 hours if mammalian DNA is used.

The restriction enzyme can be added in two aliquots, at the start of the incubation and at the midpoint, to enhance complete digestion.
4. If the DNA is to be digested with only one restriction enzyme, then soak the plugs in 20 volumes of TE (pH 7.6) at 4°C. After 1 hour, proceed with Step 7. If the DNA is to be treated with more than one enzyme, skip the incubation in TE and proceed to Step 5.

This treatment allows any salt in the restriction enzyme buffer to diffuse from the blocks.
5. If the DNA is to be digested with more than one restriction enzyme, reequilibrate the plug buffer before adding the second enzyme. To reequilibrate, use automatic pipetting devices to remove as much as possible of the first restriction enzyme buffer from each tube and replace it with 1 ml of TE (pH 7.6). Remove the TE and replace it with a fresh 1 ml of TE. Store the plug for 30–60 minutes at room temperature. Gently remove the TE buffer.
6. Add 10 volumes of the appropriate second 1X restriction enzyme buffer to each tube. Incubate the tubes for 30 minutes at room temperature. Repeat the restriction enzyme digestion as described in Step 3. Finally, soak each plug in 20 volumes of TE (pH 7.6) for 1 hour at 4°C.
7. Use a disposable pipette tip to push the blocks directly into the slots of a pulsed-field gel, and separate the fragments of DNA by electrophoresis (Protocols 17 and 18).

# Protocol 16

---

## Markers for Pulsed-field Gel Electrophoresis

**B**ECAUSE OF ITS CAPACITY TO SEPARATE EXTREMELY LARGE MOLECULES of DNA, PFGE requires markers of extremely high molecular weight. These may be obtained by extracting DNAs from bacteriophages such as T7 (40 kb), T2 (166 kb), and G (758 kb) according to the method of Lauer et al. (1977). However, a better series of markers, which are evenly spaced over a wider range of molecular weights, can be generated by ligation of bacteriophage  $\lambda$  DNA into a nested series of concatemers. The following procedure is an adaptation of the method described by Vollrath and Davis (1987). Yeast chromosomes, prepared as described in Protocol 14, may be used as even higher-molecular-weight markers.

This procedure yields a series of concatemers that contain up to 20 tandemly arranged copies of bacteriophage  $\lambda$  DNA. The viral DNA is readily ligated into concatemers by virtue of the 12-bp sticky ends or *cos* sites that occur at both ends of the bacteriophage genome. The size of intact bacteriophage  $\lambda$  DNA is 48.5 kb; thus, the individual concatenates are multiples of this length. Usually, 400–600 ng of the concatenated DNA is loaded onto a single lane (1 cm in length) of a TAFE (Protocol 17) or CHEF (Protocol 18) agarose gel.

The method given here is slow, but it produces a series of concatemers that contain approximately equal amounts of DNA.

### MATERIALS

---

**CAUTION:** Please see Appendix 12 for appropriate handling of materials marked with <!>.

#### Buffers and Solutions

Please see Appendix 1 for components of stock solutions, buffers, and reagents. Dilute stock solutions to the appropriate concentrations.

*ATP (0.1 M)*

*Dithiothreitol (1 M)*

*EDTA (0.5 M, pH 8.0)*

*1× Ligation buffer with polyethylene glycol*

50 mM Tris-Cl (pH 7.6)

1 mM ATP

10 mM dithiothreitol

10 mM MgCl<sub>2</sub>

2% PEG 8000 <!>



*Low-melting-temperature (LMT) agarose buffer*  
100 mM Tris-Cl (pH 7.6)  
20 mM MgCl<sub>2</sub>  
MgCl<sub>2</sub> (20 mM)  
Polyethylene glycol (8% w/v PEG 8000 solution) <!>  
TE (pH 7.6)

## Enzymes and Buffers

*Bacteriophage T4 DNA ligase*

## Gels

*Low-melting-temperature agarose*  
Use a grade of agarose that is suitable for PFGE (e.g., SeaPlaque GTG, BioWhittaker).

## Nucleic Acids and Oligonucleotides

*Purified bacteriophage λ DNA*  
Please see Chapter 2, Protocols 11 and 12.

## Special Equipment

*Tygon tubing*  
Use tubing with a 3/32-inch internal diameter.  
*Water bath preset to 56°C*

## METHOD

---

1. Dissolve 0.1 g of low-melting-temperature agarose in 10 ml of LMT buffer by heating it in a boiling water bath or by microwaving. Cool the solution to 37°C.
2. Dissolve 10 µg of purified bacteriophage λ DNA in 172.5 µl of TE (pH 7.6) and heat the solution to 56°C for 5 minutes.  
This treatment denatures the cohesive termini of the bacteriophage λ DNA.
3. Cool the solution to 37°C, and rapidly add the following reagents in the order listed:

8% PEG 8000	62.5 µl
20 mM MgCl <sub>2</sub>	5.0 µl
0.1 M ATP	5.0 µl
1 M dithiothreitol	5.0 µl
bacteriophage T4 DNA ligase	0.5 Weiss unit
1% LMT agarose solution (Step 1)	250 µl

Polyethylene glycol acts like a crowding agent and increases the efficiency of ligation (please see the information panel on **CONDENSING AND CROWDING REAGENTS** in Chapter 1).
4. Draw the mixture into a short length of Tygon tubing, and chill the tubing on ice until the agarose has completely set.
5. Blow the agarose plug into a sterile, disposable plastic tube containing at least 3 volumes of 1× ligation buffer with polyethylene glycol.  
An alternative method to using Tygon tubing is to transfer the LMT solution from Step 3 directly to a disposable plastic tube. Allow the gel to harden and then add 3 volumes of 1× ligation buffer. Make sure to dislodge the agarose plug from the bottom of the tube to allow the ligation buffer equal access to the entire plug.

6. Incubate the plug in ligation buffer for 24 hours at room temperature and then transfer it to a tube containing 10 volumes of 20 mM EDTA (pH 8.0).
7. Incubate the plug in EDTA for 1 hour, then transfer the plug to a tube containing 10 volumes of fresh 20 mM EDTA (pH 8.0), and store at 4°C until needed for electrophoresis in Protocols 17 and 18.

# Protocol 17

---

## Pulsed-field Gel Electrophoresis via Transverse Alternating Field Electrophoresis Gels

**G**ARDINER ET AL. (1986; GARDINER AND PATTERSON 1989) USED A GEL APPARATUS with platinum wire electrodes positioned on opposite sides of a vertically oriented gel to separate large DNA fragments. In this form of transverse alternating field electrophoresis (TAFE), the DNA moves first toward one set of electrodes and then toward the other as the electric fields are switched. The net result of the zigzag movements is a straight line from the loading well toward the bottom of the gel. Because all of the lanes in the gel are exposed to equivalent electric fields, there is no horizontal distortion of the DNA bands. As with other PFGE systems, the size of the molecules resolved at a given voltage is a function of the pulse time. Variation in these parameters allows the separation of DNAs ranging in size from 2 kb up to >6000 kb. TAFE gels are thus very versatile: They can be adapted to the analysis of almost any locus or gene, and they can be used to establish accurate long-range restriction maps and are especially good at resolving DNA fragments in the <1000-kb range. Resolution of larger DNA fragments using contour-clamped field electrophoresis (CHEF) gels is presented in Protocol 18. For a more detailed discussion on preparing and running agarose gels, please refer to the introduction to Protocol 1.

The following protocol, supplied by Tommy Hyatt and Helen Hobbs (University of Texas, Southwestern Medical Center, Dallas), describes the resolution of genomic DNA by TAFE, followed by blotting and detection by hybridization. Protocols 19 and 20 describe methods for isolating and recovering a particular DNA fragment resolved by PFGE.

### PULSE TIMES IN TAFE GELS

---

In TAFE gels, voltage is applied to one set of electrodes for a period of time known as the pulse time and is then switched and applied to the other electrode pair for an equivalent time. In a TAFE apparatus in which the agarose gel is mounted in a vertical position, the resulting electric field moves through the thickness of the gel. The length of the pulse time determines the size range of DNA that is optimally resolved on the gel. Table 5-10 correlates pulse time with the fragment size range resolved. This table can be used with the protocol as a rough guide when setting up the initial TAFE gel experiments; the pulse time can then be customized to fit the needs of a particular experiment.

DNA fragments in the megabase range, such as the chromosomes of *S. pombe*, can also be resolved on TAFE gels but require a gel containing a low concentration of agarose (0.55%) and

**TABLE 5-10 TAFE Gel Conditions for Separating DNAs of Various Sizes**

SIZE RANGE (kb)	PULSE TIME (SECONDS)	TIME (HOURS)
5-50	1	10
20-100	3	10
50-250	10	14
100-400	20	14
200-1000	45	18
200-1600	70	20
Larger DNAs	see text	see text

the use of 2x TAFE gel buffer. A two-step electrophoresis program is run consisting of an initial electrophoresis of 12 hours of 30-minute pulses at 60 V, followed by a 60-hour run of 20-minute pulses at 50 V (K. Gardiner, pers. comm.).

The exact electrophoretic behavior of a DNA fragment in a TAFE gel is influenced by the electric field strength, pulse time, buffer concentration, temperature, and DNA topology. For a detailed analysis of how these parameters affect the migration of large DNAs in PFGE, please see Cantor et al. (1988) and Mathew et al. (1988a,b,c). In general, their conclusions are applicable to TAFE gels. However, a problem encountered during some TAFE gel experiments arises as a consequence of the vertical position of the agarose gel in the apparatus. If the gel box or the gel should warp, the DNA will be off-center in the electric field, causing the DNA to migrate out one face of the gel.

## MATERIALS

**CAUTION:** Please see Appendix 12 for appropriate handling of materials marked with <!>.

### Buffers and Solutions

Please see Appendix 1 for components of stock solutions, buffers, and reagents. Dilute stock solutions to the appropriate concentrations.

#### *Denaturing buffer*

0.5 N NaOH <!>

1.5 M NaCl

*TAFE gel electrophoresis buffer containing 0.5 µg/ml ethidium bromide or an appropriate dilution of SYBR Gold <!>*

For a discussion of staining agarose gels, please see Protocol 2.

#### *TAFE gel electrophoresis buffer*

20 mM Tris-acetate (pH 8.2)

0.5 mM EDTA

Use acetic acid to adjust the pH of the Tris solution to 8.2; use the free acid of EDTA, not the sodium salt. Concentrated solutions of TAFE buffer can also be purchased (e.g., from Beckman). A buffer of 0.045 M Tris-borate (pH 8.2) and 0.01 M EDTA has also been used successfully in this protocol.

▲ **IMPORTANT** The TAFE gel electrophoresis buffer must be cooled to 14°C before filling the gel apparatus.

*TE (pH 8.0)*

## Gels

### *High-quality agarose*

It is essential to use a grade of agarose appropriate for PFGE. Many specialty agaroses are commercially available for this purpose (e.g., Seakem LE, BioWhittaker). We have had success with Agarose LE from Beckman in this protocol and with regular LMP agarose from Life Technologies.

## Nucleic Acids and Oligonucleotides

### *DNA size standards*

Please see Step 2. Standards can also be purchased from commercial manufacturers (e.g., New England Biolabs, Bio-Rad, or GIBCO-BRL).

### *Genomic DNA of interest*

Please see Step 2.

## Special Equipment

### *Circulating water bath*

TAFE gels are run at 14°C and require a device that both circulates and cools the electrophoresis buffer. These devices are expensive (several thousand dollars each) and can be purchased either as part of the TAFE gel apparatus (commercially available) or as a separate piece of equipment (e.g., Lauda or Techne refrigeration immersion circulators or circulating baths).

### *TAFE gel apparatus*

This apparatus is available commercially or can be constructed as described by Gardiner et al. (1986; Gardiner and Patterson 1989).

### *Water bath preset to 14°C*

The water bath is required to cool the TAFE gel electrophoresis buffer before use.

## Additional Reagents

*Step 2 of this protocol requires the reagents listed in Protocols 13 or 14, 15, and 16 of this chapter.*

*Steps 9 and 10 of this protocol require the reagents listed in Chapter 6, Protocol 8.*

*Step 11 of this protocol requires the reagents listed in Chapter 6, Protocol 10.*

## METHOD

---

### Separation of DNA Fragments by TAFE

1. Cast a 1% agarose gel in 1x TAFE gel buffer without ethidium bromide and allow the gel to set. Pour the gel with the same buffer solution to be used to fill the gel apparatus.
2. Prepare agarose plugs containing the DNA of interest (please see Protocol 13 for preparation of mammalian DNA or Protocol 14 for preparation of yeast DNA embedded in plugs) and carry out digestion with restriction enzymes as described in Protocol 15. Prepare and embed the appropriate DNA size standards as described in Protocols 14 and 16.
3. Rinse all of the plugs in 10 volumes of TE (pH 8.0) for 30 minutes with two changes of buffer.
4. Embed the digested and rinsed DNA plugs in individual wells of the gel. Seal the plugs in the wells with molten 1% agarose in 1x TAFE gel buffer.
5. Place the gel in the TAFE apparatus filled with 1x TAFE gel buffer previously cooled to 14°C.
6. Connect the gel apparatus to the appropriate power supply set to deliver 4-second pulses at a constant current of 170–180 mA for 30 minutes. This setting forces the DNA to enter the gel rapidly. After this time period, decrease the current input to 150 mA, change the pulse time to a setting optimum for the size range of DNAs to be resolved (please see Table 5-10 of this protocol), and continue electrophoresis for 12–18 hours.

In a Tris-acetate/EDTA buffer, a pulse time of 15 seconds will separate DNA fragments in the 50–400-kb size range. This same range of fragments can be separated in the Tris-borate/EDTA buffer using a program of 8-second pulses at 350 mA for 12 hours followed by 15-second pulses at 350 mA for an additional 12 hours.

The rapid electrophoresis of the DNA into the gel at the start of the run is optional. Some investigators skip this step and simply use one constant current and pulse time setting for the entire run.

7. Disconnect the power supply, dismantle the gel apparatus, and stain the gel in 1x TAFE buffer containing 0.5 µg/ml ethidium bromide or an appropriate dilution of SYBR Gold. Photograph the gel under UV light.

The standard technique used to detect DNAs separated by PFGE is staining with ethidium bromide or SYBR Gold (please see Protocol 2). To facilitate the detection of minor species of DNA stained with ethidium bromide, the gels may be destained in H<sub>2</sub>O for up to 1 hour before photography. For details of methods that can be used to maximize the photographic detection of DNA stained with these dyes, please see Protocol 2. Alternatively, these gels may be stained with a silver solution as described in the panel below.

#### ALTERNATIVE PROTOCOL: SILVER STAINING PFGE GELS

An alternative, more sensitive method for detecting DNA in TAFE or CHEF gels is to stain the gel with silver (Cardiner et al. 1986). Unfortunately, the staining procedure prevents subsequent transfer of the DNA to a membrane for hybridization analysis.

**CAUTION:** Please see Appendix 12 for appropriate handling of materials marked with <!>.

#### Additional Materials

*Filter paper*

*Glutaraldehyde (3% v/v) in H<sub>2</sub>O <!>*

*Weight (500 g)*

*Paper towels*

*Silver nitrate solution*

*19 mM NaOH*

*0.2 N NH<sub>4</sub>OH*

*0.1% (w/v) AgNO<sub>3</sub> <!>*

#### Method

1. Dry the gel overnight between two sheets of filter paper and a 2-inch stack of paper towels weighed down with a 500-g mass.
2. Soak the dried gel in 100 ml of 3% (v/v) glutaraldehyde for 7 minutes at room temperature in a chemical fume hood.
3. Rinse the gel in H<sub>2</sub>O, pour off the H<sub>2</sub>O, and replace with 100 ml of freshly prepared silver nitrate solution. Leave the gel in this solution until the DNA bands are visible (typically 3–5 minutes).
4. Pour off the silver solution into a waste collection container and rinse the gel with H<sub>2</sub>O for an extended period of time.

## Denaturation and Transfer of DNA to a Nylon Membrane

8. Rinse the stained gel twice with H<sub>2</sub>O. Pour off the second H<sub>2</sub>O rinse and replace with denaturing buffer. Incubate with gentle shaking for 30 minutes. Change the denaturing buffer and incubate for an additional 30 minutes.

In general, standard methods of Southern blotting as described in Chapter 6 (please see Protocols 8 and 9) can be used to detect hybridizing gene sequences in TAFE gels. Some investigators find that the very large DNA fragments typically analyzed by PFGE transfer to nylon membranes more efficiently after partial hydrolysis of the DNA by acid treatment. This treatment causes partial depurination and nicking of larger DNA fragments and in so doing enhances capillary transfer. To include an acid hydrolysis step, after the electrophoresis is complete, rinse the gel twice with H<sub>2</sub>O in Step 8, pour off the second H<sub>2</sub>O rinse, and replace with 25 mM HCl. Soak the gel with gentle agitation for 3–5 minutes. Rinse the gel with H<sub>2</sub>O and continue with the denaturation protocol of Step 8 and onward.

When acid treatments are used in the protocol, it is important to stain the agarose gel after transfer of the DNA to the nylon membrane. A slight residual smear of DNA should be visible. If no residual DNA is detected, then the acid treatment may have been too harsh (i.e., too long or too strong). Too much depurination and nicking increases the transfer of the DNA but also tends to reduce the intensity of subsequent hybridization signals.

9. Transfer the DNA directly to a nylon membrane by capillary blotting in denaturing buffer (for details, please see Chapter 6, Protocol 8).

Some investigators find that transfer of larger DNA fragments is enhanced when 6x SSC buffer is used in capillary blotting rather than the more standard 10x SSC solution.

10. After transfer, affix the DNA to the nylon membrane by baking for 2 hours at 80°C, by UV cross-linking, or by microwaving.
11. Carry out prehybridization and hybridization with labeled probes in a formamide-containing buffer (for details, please see Chapter 6, Protocol 10).

We typically use <sup>32</sup>P-radiolabeled single-stranded bacteriophage M13 probes (please see Chapter 9, Protocol 5) at a concentration of  $5 \times 10^6$  to  $6 \times 10^6$  cpm/ml of hybridization buffer to detect a single-copy gene in a complex mammalian genome. A membrane hybridized for 12–16 hours in this fashion is washed in 500 ml of 2x SSC containing 1% (w/v) SDS for 15 minutes at room temperature, scrubbed gently with a sponge, then washed in 1 liter of 0.5x SSC containing 1% (w/v) SDS for 2 hours at 68°C, and then subjected to autoradiography.

#### TROUBLESHOOTING

In general, the mark of a good electrophoretic run when separating mammalian genomic DNA digested with a restriction endonuclease is the presence of a constant smear of stained DNA extending from just below the well to the lower reaches of the gel. A concentration of DNA at the bottom of the gel is indicative of nonspecific degradation of the genomic DNA. This degradation is usually caused by contamination of the preparation with a nonspecific DNase, which is quiescent when the DNA is stored in TE, but is activated upon incubation in an Mg<sup>2+</sup>-containing restriction enzyme buffer. Phenol:chloroform extraction of the DNA to remove the offending DNase is out of the question because the DNA is embedded in an agarose plug. However, retreatment of the plugs with proteinase K followed by the addition of PMSF as described for mammalian DNA in Protocol 13 (Steps 6–8) or for yeast DNA in Protocol 14 (Steps 9–11) can remove DNase from a batch of contaminated plugs. Along these lines, it is a good idea to check all preparations of agarose plugs prepared in this protocol by simply incubating the plug in the presence of a restriction buffer and absence of restriction enzyme. Thereafter, examine the DNA by separation through a TAFE gel in which 60-second pulse times are used over a 20-hour electrophoresis run. If the DNA in the plug is intact, then very little DNA will enter the gel during the electrophoresis. However, if there is a nonspecific DNase contaminant, a considerable amount of DNA will enter the gel and be visible after ethidium bromide staining.

If a focus of DNA is detected just below the well after restriction enzyme digestion and PFGE, then it may be assumed that the restriction enzyme did not digest the DNA to completion. Many of the restriction enzymes used in analyzing DNA by PFGE have strict buffer requirements for maximum activity. Make sure that the buffer recommended by the enzyme's manufacturer was used and that the digestion was carried out at the proper temperature. Alternatively, poor digestion by more than one enzyme can indicate a dirty DNA preparation. In this case as well, the contaminant may be removed by retreating the genomic DNA plugs with proteinase K and PMSF as described for mammalian DNA in Protocol 13 (Steps 6–8) or for yeast DNA in Protocol 14 (Steps 9–11).

# Protocol 18

---

## Pulsed-field Gel Electrophoresis via Contour-clamped Homogeneous Electric Field Gels

**I**N CONTOUR-CLAMPED HOMOGENEOUS ELECTRIC FIELD (CHEF) gels, the electric field is generated from multiple electrodes that are arranged in a square or hexagonal contour around the horizontal gel and are clamped to predetermined potentials (Chu et al. 1986; Vollrath and Davis 1987; Chu 1990a). A square contour generates electric fields that are oriented at right angles to each other; a hexagonal array of electrodes generates fields at angles of 120° or 60°, depending on the placement of the gel and the polarity of the electrodes. By using a combination of low field strengths (1.3 V/cm), low concentrations of agarose (0.6%), long switching intervals (1 hour), and extended periods of electrophoresis (130 hours), it is possible to resolve DNA molecules up to 5000 kb in length (Vollrath and Davis 1987). CHEF gels can be used to size DNA fragments accurately in genomic DNA and do not suffer from the problems of vertical gel positioning that are endemic to TAFE gels.

The following protocol, supplied by Elsy Jones (University of Texas Southwestern Medical Center, Dallas), describes the resolution of large genomic DNA molecules by CHEF gel electrophoresis, followed by blotting and detection by hybridization. Protocols 19 and 20 describe methods for isolating and recovering a particular DNA fragment resolved by PFGE.

### CONDITIONS FOR CHEF ELECTROPHORESIS

---

The size range in which maximum resolution of DNA fragments is achieved on CHEF gels depends on the pulse time. In general, shorter pulse times are used to separate smaller DNA fragments and longer pulse times are used to separate larger DNAs. Table 5-11 presents empirically determined pulse and electrophoresis times for a given size range of DNAs using a CHEF apparatus from Bio-Rad. Other devices may yield slightly different separations for a given set of conditions.

The orientation of the electric field relative to the plane of the agarose gel, called the field angle, can be varied between 90° and 120°. In general, the smaller the field angle, the faster a DNA fragment of a given size migrates through the gel. Smaller angles (<105°) are best for resolving very large DNA fragments (>1000 kb), whereas larger angles are best for resolving smaller DNA fragments.



**TABLE 5-11 Conditions for Separating DNAs of Various Sizes in CHEF Gels**

% AGAROSE	SIZE RANGE (kb)	SWITCH TIMES	V/CM	TIME (HOURS)
1% Fast Lane	6–500	ramped, 3–80 seconds	6	18
	10–800	ramped, 6–80 seconds	6	20
	100–1000	60 seconds, then 90 seconds	6	15
0.8% Fast Lane	150–2000	ramped, 30–180 seconds	6	9
			5	24

All gels are run in 0.5x TBE. When very high resolution is required in the 800–2000-kb range, a lower voltage and a longer run time than those indicated above are used. If the gels are cast with Seakem GTG agarose, add 10% to the electrophoresis time indicated.

The use of ramped switching permits greater resolution of DNA fragments within a given size range. In ramping, the switch time at the beginning of the electrophoresis run is different from that at the end of the run. Ramping decreases the occurrence of a peculiar phenomenon in the electrophoresis of large DNAs, in which very large fragments sometimes migrate faster than smaller DNAs (Carle et al. 1986; Chu 1990a).

## MATERIALS

**CAUTION:** Please see Appendix 12 for appropriate handling of materials marked with <!.>.

### Buffers and Solutions

Please see Appendix 1 for components of stock solutions, buffers, and reagents. Dilute stock solutions to the appropriate concentrations.

#### Denaturing buffer

0.5 N NaOH

1.5 M NaCl

#### Ethidium bromide <!.> (1 µg/ml) or an appropriate dilution of SYBR Gold <!.>

For a discussion of staining agarose gels, please see Protocol 2.

#### 0.5x TBE gel electrophoresis buffer

Please see Table 5-3 for 5x recipe.

## Gels

### High-quality agarose

The following agaroses from the BioWhittaker have been used successfully with this protocol:

- Seakem GTG Agarose
- Seakem Gold Agarose: A more expensive agarose that hardens into a stronger gel matrix than Seakem GTG agarose and reduces electrophoretic run times ~10% relative to Seakem GTG.
- Fast Lane Agarose: A high-grade agarose that is slightly less expensive than Seakem Gold and maintains the faster electrophoretic character of this agarose. Gels cast with Fast Lane agarose are not as tough as those made with Seakem Gold and must be handled with more care.

1% agarose gels resolve DNA fragments in a range of 10–1000 kb, whereas 0.8% agarose gels resolve DNA fragments larger than 1000 kb. For further details, please see above Conditions for CHEF Electrophoresis and Table 5-11.

## Nucleic Acids and Oligonucleotides

### DNA size standards

Please see Step 3. Standards can also be purchased from commercial manufacturers (e.g., New England Biolabs, Bio-Rad, or GIBCO-BRL).

### Genomic DNA of interest

Please see Step 3.

## Special Equipment

### *CHEF gel apparatus*

The apparatus can be constructed as described by Chu (1990b) or purchased commercially. The following protocol was developed for use with either the CHEF DR or CHEF Mapper apparatus from Bio-Rad.

### *Circulating water bath*

CHEF gels are run at 14°C and require a device that both circulates and cools the electrophoresis buffer.

*Water bath preset to 14°C*

## Additional Reagents

*Step 3 of this protocol requires the reagents listed in Protocols 13 or 14, 15, and 16 of this chapter.*

*Steps 10 and 11 of this protocol require the reagents listed in Chapter 6, Protocol 8.*

*Step 12 of this protocol requires the reagents listed in Chapter 6, Protocol 10.*

## METHOD

---

### Separation of DNA Fragments by CHEF

1. Cast an agarose gel of the appropriate concentration in 0.5x TBE buffer as described in Protocol 1. Use a bubble level to ensure that the casting tray is completely flat on the laboratory bench. Allow the gel to harden for 1 hour at room temperature.
2. Place the agarose gel in the CHEF apparatus, add enough 0.5x TBE to just cover the gel, and cool the remaining buffer to 14°C.
3. Prepare agarose plugs containing the DNA of interest (please see Protocol 13 for preparation of mammalian DNA or Protocol 14 for preparation of yeast DNA embedded in plugs) and carry out digestion with restriction enzymes as described in Protocol 15. Prepare and embed the appropriate DNA size standards as described in Protocol 14 or 16.
4. Gently place the plugs in individual microfuge tubes and add 200 µl of 0.5x TBE to each. Incubate the plugs for 15 minutes at room temperature.
5. Embed the digested and rinsed DNA plugs in individual wells of the gel. Seal the plugs in the wells with the same solution of molten agarose used to pour the gel.
6. Allow the sealed plugs to harden in the gel for ~5 minutes, and then add additional 0.5x TBE buffer (previously cooled to 14°C in Step 2) to the apparatus to cover the agarose gel completely.
7. Start the buffer circulating and begin the electrophoresis run using power supply settings as described in Table 5-11.
8. After electrophoresis, stain the gel in a 1 µg/ml solution of ethidium bromide or an appropriate dilution of SYBR Gold for 30 minutes at room temperature. Destain the gel in H<sub>2</sub>O for 30 minutes and photograph the gel under UV light.

For details of methods that can be used to maximize the photographic detection of DNA stained with these dyes, please see Protocol 2. If no transfer of the DNA to a membrane is planned, these gels may be stained with a silver solution as described in the panel on **ALTERNATIVE PROTOCOL: SILVER STAINING PFGE GELS** in Protocol 17.

## Denaturation and Transfer of DNA to a Nylon Membrane

9. After photography, incubate the gel in 250 ml of denaturing buffer with gentle shaking for 30 minutes. Change the denaturing buffer and incubate for an additional 30 minutes.
10. Transfer the DNA directly to a nylon membrane by capillary blotting in denaturing buffer (for details, please see Chapter 6, Protocol 8).
  - Enhanced transfer of larger DNA fragments has also been noted when 6x SSC buffer is used in capillary blotting rather than the more standard 10x SSC solution.
11. After transfer, affix the DNA to the nylon membrane by baking for 2 hours at 80°C, by UV cross-linking, or by microwaving.
12. Carry out prehybridization and hybridization with labeled probes in a formamide-containing buffer (for details, please see Chapter 6, Protocol 10).

We typically use <sup>32</sup>P-radiolabeled single-stranded bacteriophage M13 probes (please see Chapter 9, Protocol 5) at a concentration of  $5 \times 10^6$  to  $6 \times 10^6$  cpm/ml of hybridization buffer to detect a single-copy gene in a complex mammalian genome. A membrane hybridized for 12–16 hours in this fashion is washed in 500 ml of 2x SSC containing 1% (w/v) SDS for 15 minutes at room temperature, scrubbed gently with a sponge, and then washed in 1 liter of 0.5x SSC containing 1% (w/v) SDS for 2 hours at 68°C, and then subjected to autoradiography.

# Protocol 19

---

## Direct Retrieval of DNA Fragments from Pulsed-field Gels

**P**REPARATIVE SCALE PFGE IN LOW-MELTING-TEMPERATURE AGAROSE (please see Protocols 17 and 18) is often used to isolate a large DNA fragment for subsequent manipulation. Size-fractionated DNAs can be digested with restriction endonucleases to generate a high-resolution cleavage map or to produce fragments for ligation into bacteriophage or plasmid vectors. Additionally, DNAs isolated from pulsed-field gels can be ligated directly into cosmid or yeast artificial chromosome (YAC) vectors, or if already cloned into YAC vectors, fractionated DNA can be injected into fertilized mouse embryos or transfected into murine embryonic stem cells. Working with size-fractionated high-molecular-weight DNAs requires that extra precautions be taken to maximize recovery of the desired DNA molecules and to avoid shearing the DNA. This protocol presents a method for the direct recovery of DNA from a low-melting-point PFGE. Protocol 20 first concentrates the fractionated DNA by electrophoresis into a high-percentage gel, followed by recovery of the DNA molecules. Both protocols rely on the use of agarase to release high-molecular-weight DNA enzymatically from agarose.

In this protocol, a gel slice containing a fragment of DNA resolved by PFGE is treated directly with agarase. The released DNA can be used as a substrate for ligation or restriction without further purification.

### MATERIALS

---

**CAUTION:** Please see Appendix 12 for appropriate handling of materials marked with <!.>.

#### Buffers and Solutions

Please see Appendix 1 for components of stock solutions, buffers, and reagents. Dilute stock solutions to the appropriate concentrations.

*Ethidium bromide* <!.> (1 µg/ml) or an appropriate dilution of *SYBR Gold* <!.>

For a discussion of staining agarose gels, please see Protocol 2.

*Phenol:chloroform* (1:1, v/v) (optional) <!.>

#### Enzymes and Buffers

Agarase is available from a number of manufacturers (GELase from Epicenter Technologies, β-Agarase I from New England Biolabs, and β-Agarase I from Calbiochem). Use the buffer supplied with the enzyme. We recommend that all buffers be supplemented with 100 mM NaCl, 30 µM spermine, 70 µM spermidine to enhance recovery of the DNA.

## Nucleic Acids and Oligonucleotides

### *DNA size standards*

For the preparation of two different ranges of sizing standards, please see Protocols 14 and 16. Standards can also be purchased from commercial manufacturers (e.g., New England Biolabs, Bio-Rad, or GIBCO-BRL).

### *Genomic DNA embedded in low-melting-temperature agarose plugs*

Please see Protocol 13 for preparation of mammalian DNA or Protocol 14 for preparation of yeast DNA embedded in plugs. Carry out digestion with restriction enzymes as described in Protocol 15 of this chapter.

## Special Equipment

*Water baths preset to 65–68°C and to temperature appropriate for agarase digestion*

## Additional Reagents

*Steps 1 and 2 of this protocol require the reagents listed in Protocol 17 or 18 of this chapter.*

## METHOD

---

1. Prepare a preparative low-melting-point agarose PFGE that will provide optimum resolution of the DNA fragment or size fraction of interest.
2. Load the DNA size standards and single plugs of the digested genomic DNA in lanes located on both sides of the preparative slot. Load the preparative sample into the preparative slot. Carry out electrophoresis as described in Protocol 17 (for TAFE gel) or Protocol 18 (for CHEF gel).

As many as 20 plugs containing DNA digested with a restriction enzyme can be loaded into a single "preparative" slot on the gel (van de Pol et al. 1990).
3. After electrophoresis, cut the lanes containing the size standards and single genomic DNA plugs from the gel and stain them with ethidium bromide or SYBR Gold for 30 minutes at room temperature. If necessary, destain the gel slices in H<sub>2</sub>O for 30 minutes. Do not stain the preparative lane.
4. Examine the stained slices by UV illumination and make notches on the slices to mark the locations of markers flanking the position of DNA of interest.
5. Reassemble the gel with the lanes containing the stained size standards and single plugs and locate the approximate region of the unstained preparative lane containing the DNA of interest. Carefully excise this region with a clean razor blade, and transfer the gel slice to a snap-cap polypropylene tube.

For long-term storage, the fragment should be placed in an airtight tube and stored at 4°C. Dot blotting or Southern blotting can be used to obtain a more precise determination of the location of the fragment of interest in the preparative gel (van de Pol et al. 1990).
6. Cover the gel fragment with agarase buffer, and incubate for 1 hour at room temperature with occasional agitation. Discard the buffer, and repeat the procedure twice more.
7. After the buffer exchange is complete, melt the agarose slice containing the fractionated DNA at 65–68°C. During the melting step, swirl the tube to ensure complete melting.

Agarases digest denatured/melted agarose, not chunks of agarose.

8. Add an appropriate amount of agarase to the melted gel and digest the gel at the temperature recommended by the manufacturer.

Digestions are usually carried out at temperatures between 37°C and 45°C and for times ranging from 1 hour to overnight.

9. After digestion, inactivate the agarase by heating (according to the manufacturer's instructions) or remove by phenol:chloroform extraction.

Heat inactivation is preferred to avoid possible shearing of the DNA during extraction with organic solvents. Ligation or restriction enzyme digestion of the released DNA can be carried out in the presence of the agarose monomers produced by the agarase. Alternatively, the DNA can be precipitated in the presence of 0.3 M sodium acetate (pH 5.2) and 2 volumes of isopropanol.

# Protocol 20

---

## Retrieval of DNA Fragments from Pulsed-field Gels following DNA Concentration

**D**NA CONTAINED IN A SLICE OF LOW-MELTING-TEMPERATURE AGAROSE is first concentrated by electrophoresis into a high-percentage agarose gel, and then isolated by treatment with agarase. The resulting DNA preparation is purified by microdialysis. This method is especially useful if the size-fractionated DNA is to be injected into fertilized mouse eggs (Schedl et al. 1993) or used for transfection of murine embryonic stem cells (Choi et al. 1993).

The presence of spermine and spermidine in the buffers used in this protocol is crucial to obtaining high recoveries of high-molecular-weight biologically active DNA. Their use should be considered whenever large DNA fragments (>15 kb) are to be isolated from low-melting-temperature agarose. The direct retrieval of DNA from pulsed-field gels (without prior concentration) is described in Protocol 19.

### MATERIALS

---

**CAUTION:** Please see Appendix 12 for appropriate handling of materials marked with <!.>.

#### Buffers and Solutions

Please see Appendix 1 for components of stock solutions, buffers, and reagents. Dilute stock solutions to the appropriate concentrations.

##### *Equilibration buffer*

1x TBE  
100 mM NaCl  
30  $\mu$ M spermine  
70  $\mu$ M spermidine

*Ethidium bromide* <!.> (1  $\mu$ g/ml) or an appropriate dilution of *SYBR Gold* <!.>

For a discussion of staining agarose gels, please see Protocol 2.

##### *Injection/transfection buffer*

10 mM Tris-Cl (pH 7.5)  
0.1 mM EDTA  
100 mM NaCl  
30  $\mu$ M spermine  
70  $\mu$ M spermidine

#### Enzymes and Buffers

##### *Agarase*

Agarase is available from a number of manufacturers (GELase from Epicenter Technologies,  $\beta$ -Agarase I from New England Biolabs, and  $\beta$ -Agarase I from Calbiochem). Use the buffer supplied with the enzyme.

It is critical that all buffers be supplemented with 100 mM NaCl, 30  $\mu$ M spermine, and 70  $\mu$ M spermidine to enhance recovery of the DNA.

## Gels

### *NuSieve GTG Agarose minigel (5%)*

Prepare the gel without a comb and in a taped gel mold.

## Nucleic Acids and Oligonucleotides

### *DNA size standards*

Please see Protocols 14 and 16 for the preparation of two different ranges of sizing standards. Standards can also be purchased from commercial manufacturers (e.g., New England Biolabs, Bio-Rad, or GIBCO-BRL).

### *Genomic DNA embedded in low-melting-temperature agarose plugs*

Please see Protocol 13 for preparation of mammalian DNA or Protocol 14 for preparation of yeast DNA embedded in plugs. Carry out digestion with restriction enzymes as described in Protocol 15 of this chapter.

## Special Equipment

### *Membranes for drop dialysis (0.05 $\mu$ m pore size)*

These membranes are available from Millipore.

### *Water baths preset to 65–68°C and to temperature appropriate for agarose digestion*

## Additional Reagents

Steps 1 and 2 of this protocol require the reagents listed in Protocol 17 or 18 of this chapter.

## METHOD

---

1. Prepare a preparative low-melting-point agarose PFGE that will provide optimum resolution of the DNA fragment or size fraction of interest.
2. Load the DNA size standards and single plugs of the digested genomic DNA in lanes located on both sides of the preparative slot. Load the preparative sample into the preparative slot. Carry out electrophoresis as described in Protocol 17 (TAFE gel) or Protocol 18 (for CHEF gel).  
As many as 20 plugs containing DNA digested with a restriction enzyme can be loaded into a single "preparative" slot on the gel (van de Pol et al. 1990).
3. After electrophoresis, cut the lanes containing the size standards and single genomic DNA plugs from the gel and stain them with ethidium bromide or SYBR Gold for 30 minutes at room temperature. If necessary, destain the gel slices in H<sub>2</sub>O for 30 minutes. Do not stain the preparative lane.
4. Examine the stained slices by UV illumination and make notches on the slices to mark the locations of markers flanking the position of DNA of interest.
5. Under normal illumination, reassemble the gel with the lanes containing the stained size standards and single plugs and locate the approximate region of the unstained preparative lane containing the DNA of interest. Carefully excise this region with a clean razor blade, and transfer the gel slice to a snap-cap polypropylene tube.  
For long-term storage, the fragment should be placed in an airtight tube and stored at 4°C. Dot blotting or Southern blotting can be used to obtain a more precise determination of the location of the fragment of interest in the preparative gel (van de Pol et al. 1990).
6. Equilibrate the gel slice containing the size-fractionated DNA in 40 ml of equilibration buffer for 20–30 minutes at room temperature. Agitate the mixture gently throughout this period.



7. Pour off the buffer and melt the gel slice at 65–68°C, gently swirling the tube periodically to ensure complete melting. Record the volume of the melted gel slice.
8. While the 5% NuSieve GTG minigel is still in the taped casting tray, slice off enough of the top of the gel to accommodate the volume of the melted gel slice that contains DNA.
9. Pour the melted gel slice into the casting tray and allow it to harden. Concentrate the size-fractionated DNA in the 5% gel by applying 60 V for 12 minutes per millimeter of low-melting-temperature gel.

For example, if the low-melting-temperature agarose portion of the gel is 10 mm long, apply a voltage across the gel for 120 minutes.
10. When electrophoresis is complete, slice a very thin section from the *center* of the gel and stain it with ethidium bromide. Determine how far into the gel the DNA has migrated (usually ~2 mm).

It is important to stain a sliver from the center of the gel as some smiling occurs during electrophoresis.
11. Remove the low-melting portion of the gel and trim as small a portion as possible of the 5% gel containing the concentrated DNA.
12. Equilibrate the gel slice containing the DNA in 12 ml of 1× agarase digestion buffer containing 100 mM NaCl, 30 μM spermine, and 70 μM spermidine. Incubate the gel slice in this buffer for 20 minutes at room temperature with gentle agitation.
13. Drain off the buffer, transfer the gel slice to a microfuge tube, and melt the DNA slice at 65–68°C. Transfer the melted gel to a water bath set at a temperature optimal for the agarase preparation (recommended by the manufacturer).
14. Incubate the melted gel slice for 15 minutes, and then add an appropriate amount of agarase to digest the starting volume of 5% gel.

Digestions are usually carried out at temperatures between 37°C and 45°C and for times ranging from 1 hour to overnight.
15. After digestion, centrifuge the tube at maximum speed for 5 minutes in a microfuge to pellet debris, and transfer the supernatant to a fresh microfuge tube.
16. Set up a drop dialysis of the supernatant using membranes with a 0.05-μm pore size:
  - a. Spot the supernatant onto the center of the membrane, floating shiny side up on 100 ml of injection/transfection buffer.

One membrane can easily support 100 μl of supernatant.
  - b. Dialyze for 1 hour at room temperature. Replace the original buffer with 100 ml of fresh injection/transfection buffer and dialyze for an additional hour.
  - c. Transfer the DNA to a clean microfuge tube.

Drop dialysis removes the agarase enzyme and the digested carbohydrates released from the agarose.  
After drop dialysis, the concentration of the DNA can be estimated by gel electrophoresis.  
The DNA can be injected directly or combined with a lipofection reagent for transfection into cultured cells.

## REFERENCES

- Aaij C. and Borst P. 1972. The gel electrophoresis of DNA. *Biochim. Biophys. Acta* **269**: 192–200.
- Anand R. 1986. Pulsed field gel electrophoresis: A technique for fractionating large DNA molecules. *Trends Genet.* **2**: 278–283.
- Bancroft I. and Wolk C.P. 1988. Pulsed homogeneous orthogonal field gel electrophoresis (PHOGE). *Nucleic Acids Res.* **16**: 7405–7418.
- Bird A.P. 1989. Two classes of observed frequency for rare-cutter sites in CpG islands. *Nucleic Acids Res.* **17**: 9485.
- Bird A.P., Taggart M., Frommer M., Miller O.J., and Macleod D. 1985. A fraction of the mouse genome that is derived from islands of nonmethylated, CpG-rich DNA. *Cell* **40**: 91–99.
- Birren B.W., Lai E., Clark S.M., Hood L., and Simon M.I. 1988. Optimized conditions for pulsed field gel electrophoretic separations of DNA. *Nucleic Acids Res.* **16**: 7563–7582.
- Brunk C.E. and Simpson L. 1977. Comparison of various ultraviolet sources for fluorescent detection of ethidium bromide-DNA complexes in polyacrylamide gels. *Anal. Biochem.* **82**: 455–462.
- Burmeister M. and Lehrach H. 1989. Isolation of large DNA fragments from agarose gels using agarase. *Trends Genet.* **5**: 41.
- Calladine C.R., Collis C.M., Drew H.R., and Mott M.R. 1991. A study of electrophoretic mobility of DNA in agarose and polyacrylamide gels. *J. Mol. Biol.* **221**: 981–1005.
- Campbell W.P., Wrigley C.W., and Margolis J. 1983. Electrophoresis of small proteins in highly concentrated and crosslinked polyacrylamide gradient gels. *Anal. Biochem.* **129**: 31–36.
- Cantor C.R., Gaal A., and Smith C.L. 1988. High-resolution separation and accurate size determination in pulsed-field gel electrophoresis of DNA. 3. Effect of electrical field shape. *Biochemistry* **27**: 9216–9221.
- Carle G.F. and Olson M.V. 1984. Separation of chromosomal DNA molecules from yeast by orthogonal-field-alternation gel electrophoresis. *Nucleic Acids Res.* **12**: 5647–5664.
- . 1985. An electrophoretic karyotype for yeast. *Proc. Natl. Acad. Sci.* **82**: 3756–3760.
- Carle G.F., Frank M., and Olson M.V. 1986. Electrophoretic separations of large DNA molecules by periodic inversion of the electric field. *Science* **232**: 65–68.
- Chiari M. and Righetti P.G. 1995. New types of separation matrices for electrophoresis. *Electrophoresis* **16**: 1815–1829.
- Choi T.K., Hollenbach P.W., Pearson B.E., Ueda R.M., Weddell G.N., Kurahara C.G., Woodhouse C.S., Kay R.M., and Loring J.E. 1993. Transgenic mice containing a human heavy chain immunoglobulin gene fragment cloned in a yeast artificial chromosome. *Nat. Genet.* **4**: 117–123.
- Chrambach A. and Rodbard D. 1972. Polymerization of polyacrylamide gels: Efficiency and reproducibility as a function of catalyst concentrations. *Sep. Sci.* **7**: 663–703.
- Chu G. 1990a. Pulsed-field gel electrophoresis: Theory and practice. *Methods* **1**: 129–142.
- . 1990b. Apparatus for contour-clamped homogeneous electric fields. *Methods* **1**: 212–214.
- Chu G., Vollrath D., and Davis R.W. 1986. Separation of large DNA molecules by contour-clamped homogeneous electric fields. *Science* **234**: 1582–1585.
- Clark S.M., Lai E., Birren B.W., and Hood L. 1988. A novel instrument for separating large DNA molecules with pulsed homogeneous electric fields. *Science* **241**: 1203–1205.
- Cook P.R. 1984. A general method for preparing intact nuclear DNA. *EMBO J.* **3**: 1837–1842.
- Dretzen G., Bellard M., Sassone-Corsi P., and Chambon P. 1981. A reliable method for the recovery of DNA fragments from agarose and acrylamide gels. *Anal. Biochem.* **112**: 295–298.
- Drmanac R., Petrovic M., Glisin V., and Crkvenjakov R. 1986. A calculation of fragment lengths obtainable from human DNA with 78 restriction enzymes: An aid for cloning and mapping. *Nucleic Acids Res.* **14**: 4691–4692.
- Edmondson S.P. and Gray D.M. 1984. Analysis of the electrophoretic properties of double-stranded DNA and RNA in agarose gels at a finite voltage gradient. *Biopolymers* **23**: 2725–2742.
- Fangman W.L. 1978. Separation of very large DNA molecules by gel electrophoresis. *Nucleic Acids Res.* **5**: 653–665.
- Favaloro J., Treisman R., and Kamen R. 1980. Transcription maps of polyoma virus-specific RNA: Analysis by two-dimensional nuclease S1 gel mapping. *Methods Enzymol.* **65**: 718–749.
- Ferguson W.J., Braunschweiger K.I., Braunschweiger W.R., Smith J.R., McCormick J.J., Wasmann C.C., Jarvis N.P., Bell D.H., and Good N.E. 1980. Hydrogen ion buffers for biological research. *Anal. Biochem.* **104**: 300–310.
- Gaillard C. and Strauss E. 1990. Ethanol precipitation of DNA with linear polyacrylamide as carrier. *Nucleic Acids Res.* **18**: 378–383.
- Gardiner K. and Patterson D. 1989. Transverse alternating field electrophoresis and applications to mammalian genome mapping. *Electrophoresis* **10**: 296–302.
- Gardiner K., Laas W., and Patterson D. 1986. Fractionation of large mammalian DNA restriction fragments using vertical pulsed-field gradient gel electrophoresis. *Somat. Cell Mol. Genet.* **12**: 185–195.
- Girvitz S.C., Bacchetti S., Rainbow A.J., and Graham F.L. 1980. A rapid and efficient procedure for the purification of DNA from agarose gels. *Anal. Biochem.* **106**: 492–496.
- Good N.E., Winget G.D., Winter W., Connolly T.N., Izawa S., and Singh R.M.M. 1966. Hydrogen ion buffers for biological research. *Biochemistry* **5**: 467–477.
- Grossman P.D., Menche S., and Hershey D. 1992. Quantitative analysis of DNA sequencing electrophoresis. *Genet. Anal. Tech. Appl.* **9**: 9–16.
- Helling R.B., Goodman H.M., and Boyer H.W. 1974. Analysis of endonuclease R-EcoRI fragments of DNA from lambda-doid bacteriophages and other viruses by agarose-gel electrophoresis. *J. Virol.* **14**: 1235–1244.
- Hervet H. and Bean C.P. 1987. Electrophoretic mobility of lambda-phage HindIII and HaeIII DNA fragments in agarose gels: A detailed study. *Biopolymers* **26**: 727–742.
- Johnson P.H. and Grossman L.I. 1977. Electrophoresis of DNA in agarose gels. Optimizing separations of conformational isomers of double- and single-stranded DNAs. *Biochemistry* **16**: 4217–4225.
- Kirkpatrick F.H. 1990. Overview of agarose gel properties. *Curr. Commun. Cell Mol. Biol.* **1**: 9–22.
- Lalande M., Noolandi J., Turmel C., Rousseau J., and Slater G.W. 1987. Pulsed-field electrophoresis: Application of a computer model to the separation of large DNA molecules. *Proc. Natl. Acad. Sci.* **84**: 8011–8015.
- Lauer G.D., Roberts T.M., and Klotz L.C. 1977. Determination of the nuclear DNA content of *Saccharomyces cerevisiae* and implications for the organization of DNA in yeast chromosomes. *J. Mol. Biol.* **114**: 507–526.
- LePecq J.B. and Paoletti C. 1967. A fluorescent complex between

- ethidium bromide and nucleic acids. Physical-chemical characterization. *J. Mol. Biol.* **27**: 87–106.
- Lerman L.S. and Frisch H.L. 1982. Why does the electrophoretic mobility of DNA in gels vary with the length of the molecule? *Biopolymers* **21**: 995–997.
- Lumpkin O.J. and Zimm B.H. 1982. Mobility of DNA in gel electrophoresis. *Biopolymers* **21**: 2315–2316.
- Margolis J. and Wrigley C.W. 1975. Improvement of pore gradient electrophoresis by increasing the degree of cross-linking at high acrylamide concentrations. *J. Chromatogr.* **106**: 204–209.
- Mathew M.K., Smith C.L., and Cantor C.R. 1988a. High-resolution separation and accurate size determination in pulsed-field gel electrophoresis of DNA. 1. DNA size standards and the effect of agarose and temperature. *Biochemistry*. **27**: 9204–9210.
- . 1988b. High-resolution separation and accurate size determination in pulsed-field gel electrophoresis of DNA. 2. Effect of pulse time and electric field strength and implications for models of the separation process. *Biochemistry* **27**: 9210–9216.
- Mathew M.K., Hui C.-F., Smith C.L., and Cantor C.R. 1988c. High-resolution separation and accurate size determination in pulsed-field gel electrophoresis of DNA. 4. Influence of DNA topology. *Biochemistry* **27**: 9222–9226.
- Maxam A.M. and Gilbert W. 1977. A new method for sequencing DNA. *Proc. Natl. Acad. Sci.* **74**: 560–564.
- . 1980. Sequencing end-labeled DNA with base-specific chemical cleavages. *Methods Enzymol.* **65**: 499–560.
- McDonnell M.W., Simon M.N., and Studier F.W. 1977. Analysis of restriction fragments of T7 DNA and determination of molecular weights by electrophoresis in neutral and alkaline gels. *J. Mol. Biol.* **110**: 119–146.
- Mortimer R.K., Game J.C., Bell M., and Contopoulou C.R. 1990. Use of pulsed-field gel electrophoresis to study the chromosomes of *Saccharomyces* and other yeasts. *Methods* **1**: 169–179.
- Norton I.T., Goodall D.M., Anstren K.R.J., Morris E.R., and Rees D.A. 1986. Dynamics of molecular organization in agarose sulfate. *Biopolymers* **25**: 1009–1030.
- Olson M.V. 1989. Pulsed-field gel electrophoresis. *Genet. Eng.* **11**: 183–227.
- Orbach M.J., Vollrath D., Davis R.W., and Yanofsky C. 1988. An electrophoretic karyotype of *Neurospora crassa*. *Nucleic Acids Res.* **8**: 1469–1473.
- Parker R.C. and Seed B. 1980. Two-dimensional agarose gel electrophoresis. "SeaPlaque" agarose dimension. *Methods Enzymol.* **65**: 358–363.
- Poustka A. 1990. Physical mapping by PFGE. *Methods* **1**: 204–211.
- Raymond S. and Weintraub L. 1959. Acrylamide gel as a supporting medium for zone electrophoresis. *Science* **130**: 711–712.
- Schedl A., Montoliu L., Kelsey G., and Schütz G. 1993. A yeast artificial chromosome covering the tyrosinase gene confers copy number-dependent expression in transgenic mice. *Nature* **362**: 258–261.
- Schwartz D.C. and Cantor C.R. 1984. Separation of yeast chromosome-sized DNAs by pulsed field gradient gel electrophoresis. *Cell* **37**: 67–75.
- Schwartz D.C. and Koval M. 1989. Conformational dynamics of individual DNA molecules during gel electrophoresis. *Nature* **338**: 520–522.
- Schwartz D.C., Smith L.C., Baker M., and Hsu M. 1989. ED: Pulsed electrophoresis instrument. *Nature* **342**: 575–576.
- Schwartz D.C., Saffran W., Welsh J., Haas R., Goldenberg M., and Cantor C.R. 1983. New techniques for purifying large DNAs and studying their properties and packaging. *Cold Spring Harbor Symp. Quant. Biol.* **47**: 189–195.
- Serwer P. 1980. Electrophoresis of duplex deoxyribonucleic acid in multiple-concentration agarose gels: Fractionation of molecules with molecular weights between  $2 \times 10^6$  and  $110 \times 10^6$ . *Biochemistry* **19**: 3001–3004.
- Sharp P.A., Sugden B., and Sambrook J. 1973. Detection of two restriction endonuclease activities in *Haemophilus parainfluenzae* using analytical agarose-ethidium bromide electrophoresis. *Biochemistry* **12**: 3055–3063.
- Slater G.W. and Noolandi J. 1985. New biased-reptation model for charged polymers. *Phys. Rev. Lett.* **55**: 1579–1582.
- . 1986. On the reptation theory of gel electrophoresis. *Biopolymers* **25**: 431–454.
- Smith D.R. 1990. Genomic long-range restriction mapping. *Methods* **1**: 195–203.
- Smith S.B., Aldridge P.K., and Callis J.B. 1989. Observation of individual DNA molecules undergoing gel electrophoresis. *Science* **243**: 203–206.
- Southern E.M., Anand R., Brown W.R.A., and Fletcher D.S. 1987. A model for the separation of large DNA molecules by crossed field gel electrophoresis. *Nucleic Acids Res.* **15**: 5925–5943.
- Stellwagen N.C. 1983. Anomalous electrophoresis of deoxyribonucleic acid restriction fragments on polyacrylamide gels. *Biochemistry* **22**: 6186–6193.
- Struhl K. 1985. A rapid method for creating recombinant DNA molecules. *BioTechniques* **3**: 452–453.
- Swartz M.N., Trautner T.A., and Kornberg A. 1962. Enzymatic synthesis of deoxyribonucleic acid. XI. Further studies on nearest neighbor base sequences in deoxyribonucleic acids. *J. Biol. Chem.* **237**: 1961–1967.
- Thorne H.V. 1966. Electrophoretic separation of polyoma virus DNA from host cell DNA. *Virology* **29**: 234–239.
- . 1967. Electrophoretic characterization and fractionation of polyoma virus DNA. *J. Mol. Biol.* **24**: 203–211.
- Turmel C. and Lalande M. 1988. Resolution of *Schizosaccharomyces pombe* chromosomes by field inversion gel electrophoresis. *Nucleic Acids Res.* **16**: 4727.
- van de Pol T.J.R., Cremers F.P.M., Brohet R.M., Wieringa B., and Ropers H.-H. 1990. Derivation of clones from the choroideremia locus by preparative field inversion gel electrophoresis. *Nucleic Acids Res.* **18**: 725–731.
- Vollrath D. and Davis R.W. 1987. Resolution of DNA molecules greater than 5 megabases by contour-clamped homogeneous electric fields. *Nucleic Acids Res.* **15**: 7865–7876.
- Waring M.J. 1965. Complex formation between ethidium bromide and nucleic acids. *J. Mol. Biol.* **13**: 269–282.
- Watkins T.I. and Woolfe G. 1952. Effect of changing the quaternizing group on the trypanocidal activity of dimidium bromide. *Nature* **169**: 506.
- Weil M.D. and McClelland M. 1989. Enzymatic cleavage of a bacterial genome at a 10-base-pair recognition site. *Proc. Natl. Acad. Sci.* **86**: 51–55.
- Wieslander L. 1979. A simple method to recover intact high molecular weight RNA and DNA after electrophoretic separation in low gelling temperature agarose gels. *Anal. Biochem.* **98**: 305–309.

# Chapter 6

---

## Preparation and Analysis of Eukaryotic Genomic DNA

### INTRODUCTION

### PROTOCOLS

- |    |  |      |
|----|--|------|
| 1  | Isolation of High-molecular-weight DNA from Mammalian Cells Using Proteinase K and Phenol        | 6.4  |
|    | • Additional Protocol: Estimating the Concentration of DNA by Fluorometry                        | 6.12 |
| 2  | Isolation of High-molecular-weight DNA from Mammalian Cells Using Formamide                      | 6.13 |
| 3  | Isolation of DNA from Mammalian Cells by Spooling  | 6.16 |
| 4  | Isolation of DNA from Mammalian Cells Grown in 96-well Microtiter Plates                         | 6.19 |
|    | • Additional Protocol: Optimizing Genomic DNA Isolation for PCR                                  | 6.22 |
| 5  | Preparation of Genomic DNA from Mouse Tails and Other Small Samples                              | 6.23 |
|    | • Alternative Protocol: Isolation of DNA from Mouse Tails without Extraction by Organic Solvents | 6.26 |
|    | • Alternative Protocol: One-tube Isolation of DNA from Mouse Tails                               | 6.26 |
|    | • Alternative Protocol: DNA Extraction from Paraffin Blocks                                      | 6.27 |
| 6  | Rapid Isolation of Mammalian DNA   | 6.28 |
| 7  | Rapid Isolation of Yeast DNA   | 6.31 |
|    | Introduction to Southern Hybridization (Protocols 8–10)  | 6.33 |
| 8  | Southern Blotting: Capillary Transfer of DNA to Membranes  | 6.39 |
| 9  | Southern Blotting: Simultaneous Transfer of DNA from a Single Agarose Gel to Two Membranes       | 6.47 |
| 10 | Southern Hybridization of Radiolabeled Probes to Nucleic Acids Immobilized on Membranes          | 6.50 |
|    | • Additional Protocol: Stripping Probes from Membranes   | 6.57 |
|    | • Additional Protocol: Hybridization at Low Stringency   | 6.58 |

### INFORMATION PANELS

- |   |      |
|---|------|
| Formamide and Its Uses in Molecular Cloning | 6.59 |
| Spooling DNA (Historical Footnote)          | 6.61 |
| Rapid Hybridization Buffers                 | 6.61 |
| CTAB  | 6.62 |

*Cell DNA*

*I am the singular  
in free fall.  
I and my doubles  
carry it all:*

*life's slim volume  
spirally bound.  
It's what I'm about,  
it's what I'm around.*

*Presence and hungers  
imbue a sap mote  
with the world as they spin it.  
I teach it by rote*

*but its every command  
was once a miscue  
that something rose to,  
Presence and freedom*

*re-wording, re-beading  
strains on a strand  
making I and I more different  
than we could stand.*

Les Murray

**D**DOUBLE-STRANDED DNA IS A REMARKABLY INERT CHEMICAL. Its potentially reactive groups are buried within the central helix, tied up in hydrogen bonds. Its base pairs are protected on the outside by a formidable casing of phosphates and sugars and are reinforced internally by strong stacking forces. With such robust shielding and scaffolding, DNA outlasts most other intracellular components in locations as disparate as modern day crime scenes and ancient burial sites. The same chemical durability endows libraries of genomic DNA with both permanence and value, thereby enabling genetic engineering and sequencing projects, both large and small.

Despite its chemical stability, double-stranded DNA is nevertheless physically fragile. Long and snaky, with little lateral stability, high-molecular-weight DNA is vulnerable to hydrodynamic shearing forces of the most modest kind (please see Table 12-1 in Chapter 12). Double-stranded DNA behaves in solution as a random coil that is stiffened by stacking interactions between the base pairs and electrostatic repulsion between the charged phosphate groups in the DNA backbone. Hydrodynamic flow — resulting from pipetting, shaking, or stirring — generates drag on the stiffened coil and has the capacity to shear both strands of the DNA. The longer the DNA molecule, the weaker the force required for breakage. Genomic DNA is therefore easy to obtain in fragmented form but becomes progressively more difficult to isolate as the desired molecular weight increases. DNA molecules >150 kb are prone to breakage by forces generated during procedures commonly used to isolate genomic DNA.

The method described in Protocol 1 involves digesting eukaryotic cells or tissues with proteinase K in the presence of EDTA (to sequester divalent cations and thereby inhibit DNases) and solubilizing membranes and denaturing proteins with a detergent such as SDS. The nucleic acids are then purified by phase extractions with organic solvents. Contaminating RNA is eliminated by digestion with an RNase, and low-molecular-weight substances are removed by dialysis. This method can be scaled to yield amounts of DNA ranging from less than ten to more than hundreds of micrograms of DNA. However, shearing forces are generated at every step, with the result that the DNA molecules in the final preparation rarely exceed 100–150 kb in length. DNA of this size is adequate for Southern analysis on standard agarose gels, as a template in polymerase chain reactions (PCRs), and for the construction of genomic DNA libraries in bacteriophage  $\lambda$  vectors.

The successful construction of libraries in higher-capacity vectors and the analysis of genomic DNA by pulsed-field gel electrophoresis require DNAs >200 kb in size, which are well beyond the reach of methods that generate significant hydrodynamic shearing forces. Protocol 2 describes a method for isolating and purifying DNA that generates molecules of a size suitable for these specialized purposes. An alternative method for preparing genomic DNA in agarose plugs is described in Chapter 5, Protocol 13.

In this chapter, we also describe ways to isolate genomic DNA from different samples of cells and tissues (Protocol 3) and from many samples grown in microtiter dishes (Protocol 4). Other protocols describe the preparation of DNA from mouse tails (Protocol 5), the rapid isolation of mammalian DNA (Protocol 6), and the rapid isolation of yeast DNA (Protocol 7). Finally, we describe how to analyze purified genomic DNAs by Southern blotting and hybridization (Protocols 8 through 10). Note also that a number of commercial kits are available for purifying genomic DNA.

# Protocol 1

---

## Isolation of High-molecular-weight DNA from Mammalian Cells Using Proteinase K and Phenol

**T**HIS PROCEDURE IS DERIVED FROM A METHOD ORIGINALLY described by Daryl Stafford and colleagues (Blin and Stafford 1976). It is the method of choice when large amounts of mammalian DNA are required, for example, for Southern blotting (Protocol 8) or for construction of genomic libraries in bacteriophage  $\lambda$  vectors (Chapter 2, Protocol 19). Approximately 200  $\mu\text{g}$  of mammalian DNA, 100–150 kb in length, is obtained from  $5 \times 10^7$  cultured aneuploid cells (e.g., HeLa cells). The usual yield of DNA from 20 ml of normal blood is  $\sim 250 \mu\text{g}$ .

All of the materials listed below are required for purification of mammalian genomic DNA, irrespective of the type of sample. Additional materials that are needed for particular types of samples are listed under the subheads for the four Step 1 methods: lysis of cells growing in monolayers, lysis of cells growing in suspension, lysis of tissue samples, and lysis of blood cells in freshly drawn or frozen samples.

### MATERIALS

---

**CAUTION:** Please see Appendix 12 for appropriate handling of materials marked with <!>.

▲ **WARNING** Primate tissues and primary cultures of cells require special handling precautions.

### Buffers and Solutions

Please see Appendix 1 for components of stock solutions, buffers, and reagents. Dilute stock solutions to the appropriate concentrations.

*Ammonium acetate (10 M) (used as an alternative to dialysis, Step 9)*

*Dialysis buffer (used as an alternative to ethanol precipitation, Step 9)*

50 mM Tris-Cl (pH 8.0)

10 mM EDTA (pH 8.0)

Prepare four lots of 4 liters of dialysis solution and store at 4°C.

*Ethanol (used as an alternative to dialysis, Step 9)*

*Lysis buffer*

10 mM Tris-Cl (pH 8.0)

0.1 M EDTA (pH 8.0)

0.5% (w/v) SDS

20  $\mu\text{g}/\text{ml}$  DNase-free pancreatic RNase

The first three ingredients of the lysis buffer may be mixed in advance and stored at room temperature. RNase is added to an appropriate amount of the mixture just before use. Adding RNase to the lysis buffer

eliminates the need to remove RNA from semipurified DNA at a later stage in the preparation. Pancreatic RNase is not highly active in the presence of 0.5% SDS, but when added at high concentrations, it works well enough to degrade most of the cellular RNA.

*Phenol, equilibrated with 0.5 M Tris-Cl (pH 8.0) <math>\langle ! \rangle</math>*

▲ **IMPORTANT** The pH of the phenol must be ~8.0 to prevent DNA from becoming trapped at the interface between the organic and aqueous phases (please see Appendix 8).

*TE (pH 8.0)*

*Tris-buffered saline (TBS)*

## Enzymes and Buffers

*Proteinase K (20 mg/ml)*

For this protocol, we recommend the use of a genomic grade proteinase K that has been shown to be free of DNase and RNase activity. Please see Appendix 4.

## Gels

*Pulsed-field gel (please see Chapter 5, Protocols 17 and 18) or Conventional horizontal 0.6% agarose gel (Chapter 5, Protocol 1)*

## Nucleic Acids and Oligonucleotides

*Bacteriophage  $\lambda$  DNA, intact*

Purify  $\lambda$  DNA as described in Chapter 2, Protocol 11 or 12. The DNA is used as a size standard during gel electrophoresis (please see Step 11).

## Centrifuges and Rotors

*Sorvall centrifuge with H1000B and SS-34 rotors (or their equivalents)*

## Special Equipment

*Cut-off yellow tips*

Cut-off yellow tips can be generated rapidly with a scissors or a dog nail clipper (e.g., Fisher 05-401A). Alternatively, the pointed ends of the tips can be removed with a sharp razor blade. The cut-off tips should be sterilized before use, either by autoclaving or by immersion in 70% alcohol for 2 minutes followed by drying in air. Alternatively, presterilized wide-bore tips can be purchased from a number of commercial companies (e.g., Bio-Rad).

*Dialysis tubing clips*

Spectra Por closures from Spectrum Medical Industries, Houston, Texas.

*Rocking platform or Dialysis tubing*

Prepared as described in Appendix 8.

*Shepherd's crooks (used as an alternative to dialysis)*

Shepherd's crooks are Pasteur pipettes whose tip has been sealed in the flame of a Bunsen burner and shaped into a U with a hemostat. Wear safety glasses while molding the Shepherd's crooks. For further information, please see Steps 5–7 of Protocol 3.

*Spectrophotometer or Fluorometer*

*Tube mixer or Roller apparatus*

*Vacuum aspirator equipped with traps*

*Water bath, preset to 50°C*

*Wide-bore pipettes (0.3-cm diameter orifice)*

Wide-bore pipettes are available from several manufacturers. However, standard glass pipettes can be used if they are autoclaved in the wrong orientation without cotton plugs.

## Cells and Tissues

*Monolayers or suspensions of mammalian cells, or fresh tissue, or blood samples*



## METHOD

---

*Below are four alternative versions of Step 1 used to lyse different types of cells or tissue samples. Use the version appropriate for the material under study and then proceed to Step 2 on page 6.9.*

### Lysis of Cells Growing in Monolayers

#### Additional Materials

*Aspiration device attached to a vacuum line equipped with traps  
Bed of ice large enough to accommodate 10–12 culture dishes  
Erlenmeyer flask (50 or 100 ml)  
Rubber policeman  
Sorvall centrifuge, H1000B rotor (or equivalent) and centrifuge tubes cooled to 4°C  
Tris-buffered saline (TBS), ice cold*

#### 1. Lyse cells growing in monolayer cultures.

It is best to work with batches of 10–12 culture dishes at a time. Store the remaining culture dishes in the incubator until they are required.

- a. Take one batch of culture dishes, containing cells grown to confluency, from the incubator and immediately remove the medium by aspiration. Working quickly, wash the monolayers of cells twice with ice-cold TBS. This is most easily accomplished by gently pipetting ~10 ml of TBS onto the first monolayer. Swirl the dish gently for a few seconds and then tip the fluid into a 2-liter beaker. Add another 10 ml of ice-cold TBS and store the dish on a bed of ice. Repeat the procedure until the entire batch of monolayers has been processed.
- b. Tip the fluid from the first monolayer into the 2-liter beaker. Remove the last traces of TBS from the culture dish by aspiration. Add 1 ml of fresh ice-cold TBS and store the dish on a bed of ice. Repeat the procedure until the entire batch of monolayers has been processed.
- c. Use a rubber policeman to scrape the cells from the first culture dish into the 1 ml of TBS. Use a Pasteur pipette to transfer the cell suspension to a centrifuge tube on ice. Immediately wash the culture dish with 0.5 ml of ice-cold TBS, and combine the washings with the cell suspension in the centrifuge tube. Process the remaining monolayers in the same way.
- d. Recover the cells by centrifugation at 1500g (2700 rpm in a Sorvall H1000B rotor and swinging buckets) for 10 minutes at 4°C.
- e. Resuspend the cells in 5–10 volumes of ice-cold TBS and repeat the centrifugation.
- f. Resuspend the cells in TE (pH 8.0) at a concentration of  $5 \times 10^7$  cells/ml. Transfer the solution to an Erlenmeyer flask.

For 1 ml of cell suspension, use a 50-ml flask; for 2 ml, use a 100-ml flask, and so on. The density of cells grown as a monolayer culture (from Step a above) will vary with the cell type and culture conditions. As a rule of thumb, a confluent continuous culture (e.g., of HeLa or BHK cells) grown on a 90-mm culture dish contains on average  $1 \times 10^5$  to  $3 \times 10^5$  cells/cm<sup>2</sup>.

- g. Add 10 ml of lysis buffer for each milliliter of cell suspension. Incubate the suspension for 1 hour at 37°C, and then proceed immediately to Step 2 (p. 6.9).

Make sure that the cells are well dispersed over the inner surface of the Erlenmeyer flask when the lysis buffer is added. This dispersal minimizes the formation of intractable clumps of DNA.

## Lysis of Cells Growing in Suspension

### Additional Materials

Aspiration device attached to a vacuum line equipped with traps  
 Erlenmeyer flask (50 or 100 ml)  
 Sorvall centrifuge, H100B rotor (or equivalent) and centrifuge tubes or bottles cooled to 4°C  
 TE (pH 8.0), ice-cold  
 Tris-buffered saline (TBS), ice cold

1. Lyse cells growing in suspension cultures.
  - a. Transfer the cells to a centrifuge tube or bottle and recover them by centrifugation at 1500g (2700 rpm in a Sorvall H100B rotor and swinging buckets) for 10 minutes at 4°C. Remove the supernatant medium by aspiration.
  - b. Wash the cells by resuspending them in a volume of ice-cold TBS equal to the volume of the original culture. Repeat the centrifugation. Remove the supernatant by aspiration and then gently resuspend the cells once more in ice-cold TBS. Recover the cells by centrifugation.
  - c. Remove the supernatant by aspiration and gently suspend the cells in TE (pH 8.0) at a concentration of  $5 \times 10^7$  cells/ml. Transfer the suspension to an Erlenmeyer flask.  
 For 1 ml of cell suspension, use a 50-ml flask; for 2 ml, use a 100-ml flask, and so on. The density of cells grown in suspension (from Step a) will vary with the cell type and culture conditions. As a rule of thumb, a saturated suspension culture of a continuous cell line (e.g., of HeLa or BHK cells) grown in a 1-liter culture contains on average  $1 \times 10^6$  cells/ml.
  - d. Add 10 ml of lysis buffer for each milliliter of cell suspension. Incubate the solution for 1 hour at 37°C and then proceed immediately to Step 2 (p. 6.9).  
 Make sure that the cells are well dispersed over the inner surface of the Erlenmeyer flask when the lysis buffer is added. This dispersal minimizes the formation of intractable clumps of DNA.

## Lysis of Tissue Samples

Because tissues generally contain large amounts of fibrous material, it is difficult to extract genomic DNA from them in high yield. The efficiency of extraction is greatly improved if the tissue is reduced to powder before homogenization in lysis buffer. If a large amount of fresh tissue (>1 g) is available, powdering can be accomplished with a Waring blender.

### Additional Materials

Beaker (25 ml)  
 Liquid nitrogen <!>  
 Polypropylene centrifuge tube (50 ml; Falcon or equivalent)  
 Waring blender equipped with a stainless steel container  
 or  
 Mortar and pestle, prechilled with liquid nitrogen

It is important to cool the mortar slowly by adding small amounts of liquid nitrogen over a period of time. Filling the mortar to the brim or suddenly immersing the grinding part of the pestle in liquid nitrogen can cause fracturing. Placing the mortar in an ice bucket filled with dry ice is a good way to precool the mortar before adding the liquid nitrogen. Be careful when grinding human and primate tissues as powdered aerosols are readily generated, especially when adding liquid nitrogen to the mortar.

1. Pulverize tissue samples.
  - a. Drop ~1 g of freshly excised tissue into liquid nitrogen in the stainless-steel container of a Waring blender. Blend at top speed until the tissue is ground to a powder.  
Alternatively, smaller quantities of tissue can be snap-frozen in liquid nitrogen and then pulverized to a powder using a mortar and pestle precooled with liquid nitrogen.
  - b. Allow the liquid nitrogen to evaporate, and add the powdered tissue little by little to ~10 volumes (w/v) of lysis buffer in a beaker. Allow the powder to spread over the surface of the lysis buffer, and then shake the beaker to submerge the material.
  - c. When all of the material is in solution, transfer the suspension to a 50-ml centrifuge tube. Incubate the tube for 1 hour at 37°C, and then proceed to Step 2 (p. 6.9).

## Lysis of Blood Cells in Freshly Drawn or Frozen Samples

### Additional Materials

*Acid citrate dextrose solution B (ACD) (for freshly drawn or frozen blood samples)*

- 0.48% w/v citric acid
- 1.32% w/v sodium citrate
- 1.47% w/v glucose

*Aspiration device attached to a vacuum line equipped with traps*

*EDTA (an alternative to ACD, for freshly drawn or frozen blood samples)*

ACD, an anticoagulant that is used when preparing genomic DNA from whole blood, is superior to EDTA in preserving high-molecular-weight DNA (Gustafson et al. 1987). However, blood is more frequently collected in commercially available tubes that contain measured amounts of EDTA as an anticoagulant. In most hospitals in the United States, blood collection tubes are conveniently color-coded to indicate which contain anticoagulants and which do not: Purple-topped tubes contain anticoagulant, usually dried EDTA, whereas yellow-topped tubes do not. In molecular cloning, the former (purple) are used to collect blood from which genomic DNA will be extracted, whereas the latter (yellow) are typically used to collect blood that will be used as a source of lymphocytes for immortalization with Epstein-Barr virus. Such immortalized cells provide a renewable resource from which large amounts of DNA can be isolated for later use in, for example, genetic studies.

*Phosphate-buffered saline (PBS, for frozen blood samples)*

*Sorvall H1000B rotor (or equivalent) and centrifuge tubes cooled to 4°C for freshly drawn blood samples*

*Sorvall SS-34 rotor (or equivalent) and centrifuge tubes cooled to 4°C for frozen blood samples*  
*Water bath, at room temperature*

1. Collect blood cells from freshly drawn or frozen samples. Human blood must be collected by a trained phlebotomist under sterile conditions.

### TO COLLECT CELLS FROM FRESHLY DRAWN BLOOD

- a. Collect ~20 ml of fresh blood in tubes containing 3.5 ml of either acid citrate dextrose solution B (ACD) or EDTA (please see note to EDTA in the materials list).  
The blood may be stored for several days at 0°C or indefinitely at -70°C before the DNA is prepared. Blood should not be collected into heparin, which is an inhibitor of the polymerase chain reaction (Beutler et al. 1990).
- b. Transfer the blood to a centrifuge tube and centrifuge at 1300g (2500 rpm in a Sorvall H1000B rotor and 50-ml swinging buckets) for 15 minutes at 4°C.

- c. Remove the supernatant fluid by aspiration. Use a Pasteur pipette to transfer the buffy coat carefully to a fresh tube and repeat the centrifugation. Discard the pellet of red cells.  
The buffy coat is a broad band of white blood cells of heterogeneous density.
- d. Remove residual supernatant from the buffy coat by aspiration. Resuspend the buffy coat in 15 ml of lysis buffer. Incubate the solution for 1 hour at 37°C, and proceed to Step 2.

#### TO COLLECT CELLS FROM FROZEN BLOOD SAMPLES

- a. Collect ~20 ml of fresh blood in tubes containing 3.5 ml of either acid citrate dextrose solution B (ACD) or EDTA (please see note to EDTA in the materials list).  
The blood may be stored for several days at 0°C or indefinitely at -70°C before the DNA is prepared.
- b. Thaw the blood in a water bath at room temperature and then transfer it to a centrifuge tube. Add an equal volume of phosphate-buffered saline at room temperature.
- c. Centrifuge the blood at 3500g (5400 rpm in a Sorvall SS-34 rotor) for 15 minutes at room temperature.
- d. Remove the supernatant, which contains lysed red cells, by aspiration. Resuspend the pellet in 15 ml of lysis buffer. Incubate the solution for 1 hour at 37°C, and then proceed to Step 2.

*Method Continues with Step 2 Below*

### Treatment of Lysate with Proteinase K and Phenol

2. Transfer the lysate to one or more centrifuge tubes that fit into a Sorvall SS-34 rotor, or equivalent. The tubes should not be more than one-third full.
3. Add proteinase K (20 mg/ml) to a final concentration of 100 µg/ml. Use a glass rod to mix the enzyme solution gently into the viscous lysate of cells.
4. Incubate the lysate in a water bath for 3 hours at 50°C. Swirl the viscous solution from time to time.
5. Cool the solution to room temperature and add an equal volume of phenol equilibrated with 0.1 M Tris-Cl (pH 8.0). Gently mix the two phases by slowly turning the tube end-over-end for 10 minutes on a tube mixer or roller apparatus. If the two phases have not formed an emulsion at this stage, place the tube on a roller apparatus for 1 hour.  
Blin and Stafford (1976) recommend the use of 0.5 M EDTA (pH 8.0) in the lysis buffer. However, the density of the buffer almost equals that of phenol, which makes separation of the phases difficult. The lysis buffer used here contains EDTA at a concentration of 0.1 M, which permits easier separation of the phenolic and aqueous phases while maintaining a high degree of protection against degradation of the DNA by nucleases and heavy metals.
6. Separate the two phases by centrifugation at 5000g (6500 rpm in a Sorvall SS-34 rotor) for 15 minutes at room temperature.

7. Use a wide-bore pipette (0.3-cm diameter orifice) to transfer the viscous aqueous phase to a fresh centrifuge tube.

When transferring the aqueous (upper) phase, it is essential to draw the DNA into the pipette very slowly to avoid disturbing the material at the interface and to minimize hydrodynamic shearing forces. If the DNA solution is so viscous that it cannot easily be drawn into a wide-bore pipette, use a long pipette attached to an aspirator to remove the organic (lower) phase as follows:

- i. Before starting, make sure that the vacuum traps are empty and secure, so that phenol cannot enter the vacuum system.
  - ii. With the vacuum line closed, slowly lower the pipette to the bottom of the organic phase. Wait until the viscous thread of aqueous material detaches from the pipette, and then carefully open the vacuum line and gently withdraw all of the organic phase. Close the vacuum line and quickly withdraw the pipette through the aqueous phase. Immediately open the vacuum line to transfer the residual phenol into the trap.
  - iii. Centrifuge the DNA solution at 5000g (6500 rpm in a Sorvall SS-34 rotor) for 20 minutes at room temperature. Protein and clots of DNA will sediment to the bottom of the tube. Transfer the DNA solution (the supernatant) into a 50-ml centrifuge tube, leaving behind the protein and clots of DNA.
8. Repeat the extraction with phenol twice more and pool the aqueous phases.
  9. Isolate DNA by one of the following two methods.

#### TO ISOLATE DNA IN THE SIZE RANGE OF 150–200 KB

- a. Transfer the pooled aqueous phases to a dialysis bag. Close the top of the bag with a dialysis tubing clip, allowing room in the bag for the sample volume to increase 1.5–2-fold during dialysis.
- b. Dialyze the solution at 4°C against 4 liters of dialysis buffer. Change the buffer three times at intervals of  $\geq 6$  hours.

Because of the high viscosity of the DNA solution, dialysis generally takes  $\geq 24$  hours to complete.

#### TO ISOLATE DNA THAT HAS AN AVERAGE SIZE OF 100–150 KB

- a. After the third extraction with phenol, transfer the pooled aqueous phases to a fresh centrifuge tube and add 0.2 volume of 10 M ammonium acetate. Add 2 volumes of ethanol at room temperature and swirl the tube until the solution is thoroughly mixed.
- b. The DNA immediately forms a precipitate. Remove the precipitate in one piece from the ethanolic solution with a Shepherd's crook (a Pasteur pipette whose end has been sealed and shaped into a U; please see Steps 5–7 of Protocol 3). Contaminating oligonucleotides remain in the ethanolic phase.
- c. If the DNA precipitate becomes fragmented, abandon the Shepherd's crook and collect the precipitate by centrifugation at 5000g (6500 rpm in a Sorvall SS-34) for 5 minutes at room temperature.
- d. Wash the DNA precipitate twice with 70% ethanol, and collect the DNA by centrifugation as described in Step c.
- e. Remove as much of the 70% ethanol as possible, using an aspirator. Store the pellet of DNA in an open tube at room temperature until the last visible traces of ethanol have evaporated.

Do not allow the pellet of DNA to dry completely; desiccated DNA is very difficult to dissolve.

- f. Add 1 ml of TE (pH 8.0) for each 0.1 ml of cells (Step 1). Place the tube on a rocking platform and gently rock the solution for 12–24 hours at 4°C until the DNA has completely dissolved. Store the DNA solution at 4°C.

**10. Measure the concentration of the DNA.**

It is often difficult to measure the concentration of high-molecular-weight DNA by standard methods such as absorbance at 260 nm. This is because the DNA solution is frequently nonhomogeneous and is usually so viscous that it is impossible to withdraw a representative sample for analysis. These problems can be minimized by withdrawing a large sample (10–20  $\mu$ l) with an automatic pipetter equipped with a cut-off yellow tip. The sample is then diluted with ~0.5 ml of TE (pH 8.0) and vortexed vigorously for 1–2 minutes. The absorbance of the diluted sample can then be read at 260, 270, and 280 nm in the standard way.

A solution with an  $A_{260}$  of 1 contains ~50  $\mu$ g of DNA/ml. Note that estimates of purity of nucleic acids based on  $OD_{260}$ : $OD_{280}$  ratios are unreliable (Glasel 1995) and that estimates of concentration are inaccurate if the sample contains significant amounts of phenol.  $H_2O$  saturated with phenol absorbs with a characteristic peak at 270 nm and an  $OD_{260}$ : $OD_{280}$  ratio of 2 (Stulnig and Amberger 1994). Nucleic acid preparations free of phenol should have  $OD_{260}$ : $OD_{280}$  ratios of ~1.2. For further information, please see Appendix 8.

More accurate measurement of DNA concentrations can be made by fluorometry in the presence of fluorescent dyes such as SYBR Gold and Hoechst 33258, which bind DNA without intercalating and with specificity to double-stranded DNA (for further details, please see Appendix 8). For a method of fluorometric measurement of DNA concentrations using Hoechst 33258, please see the panel on **ADDITIONAL PROTOCOL: ESTIMATING THE CONCENTRATION OF DNA BY FLUOROMETRY** on the following page.

11. Analyze the quality of the preparation of high-molecular-weight DNA by pulsed-field gel electrophoresis (Chapter 5, Protocol 17 or 18) or by electrophoresis through a conventional 0.6% agarose gel (Chapter 5, Protocol 1). Use unit-length and/or linear concatemers of  $\lambda$  DNA as markers. A method to generate linear concatemers of  $\lambda$  DNA is described in Chapter 5, Protocol 16.

Do not be concerned if some of the DNA remains in the well, since DNA molecules >250 kb have difficulty entering the gel. This problem can usually be solved by embedding the DNA in a small amount of melted agarose (at 55°C) and transferring the molten solution to the well of a pre-formed agarose gel. The transfer should be done before the gel is submerged in electrophoresis buffer.

**ADDITIONAL PROTOCOL: ESTIMATING THE CONCENTRATION OF DNA BY FLUOROMETRY**

Measuring the concentration of DNA using fluorometry is more sensitive than spectrophotometry, allowing the detection of nanogram quantities of DNA. In this assay, DNA preparations of known and unknown concentrations are incubated with the fluorochrome Hoechst 33258. Absorption values for the unknown sample are compared with those observed for a known series, and the concentration of the unknown sample is estimated by interpolation.

**Additional Materials**

*NaCl (4 M)*

*Sodium phosphate (0.5 M, pH 7.4)*

*Fluorometry buffer*

2 M NaCl

50 mM sodium phosphate

Prepare 500 ml and sterilize the solution by filtration through a 0.45- $\mu$ m filter.

*Hoechst 33258 dye (0.2 mg/ml in H<sub>2</sub>O)*

The concentrated solution of dye can be stored at room temperature in a foil-wrapped test tube.

*High-molecular-weight DNA solution, reference standard (100  $\mu$ g/ml in TE)*

A DNA solution of known concentration is required to construct a standard curve. Because the binding of Hoechst 33258 dye to DNA is influenced by the base composition, the DNA used to construct the standard curve should be from the same species as the test sample.

*Fluorometer, either fixed wavelength or scanning model*

**Method**

1. Turn on the fluorometer 1 hour before the assay is carried out to allow the machine to warm up and stabilize.  
When bound to high-molecular-weight double-stranded DNA, Hoechst 33258 dye absorbs maximally at 365 nm and emits maximally at 458 nm.
2. Prepare an appropriate amount of diluted dye solution (50  $\mu$ l of concentrated dye solution per 100 ml of fluorometry buffer). Each tube in the DNA assay requires 3 ml of diluted Hoechst 33258 dye solution. Transfer 3 ml of diluted dye solution to an appropriate number of clean glass tubes. Include six extra tubes for a blank and the standard curve.
3. Prepare a standard curve by adding 100, 200, 300, 400, and 500 ng of genomic DNA from the reference stock solution to individual tubes. Mix and read the absorbance on the prewarmed fluorometer of each tube immediately after addition of the DNA.
4. Add 0.1  $\mu$ l (i.e., 1  $\mu$ l of a 1:10 dilution), 1.0  $\mu$ l, and 10  $\mu$ l of the preparation of genomic DNA, whose concentration is being determined, to individual tubes containing diluted dye solution. Immediately read the fluorescence.
5. Construct a standard curve plotting fluorescence on the ordinate (y axis) and weight of reference DNA (in ng) on the abscissa (x axis). Estimate the concentration of DNA in the unknown sample by interpolation.

If the reading for the unknown genomic DNA solution falls outside that of the standard curve, read the fluorescence of a more concentrated sample or make an appropriate dilution of the sample and repeat the assay.

Binding of Hoechst 33258 is adversely influenced by pH extremes, the presence of detergents near or above their critical micellar concentrations, and salt concentrations above 3 M. If these conditions or reagents are used to prepare the genomic DNA and improbable results are obtained in the fluorometry assay, precipitate an aliquot of the DNA preparation with ethanol, rinse the pellet of nucleic acid in 70% ethanol, dissolve the dried pellet in TE, and repeat the assay.

If the preparation of test DNA is highly viscous, sampling with standard yellow tips may be so inaccurate that the dilutions of unknown DNA will not track with the standard curve. In this case, the best solution is to withdraw two samples (10–20  $\mu$ l) with an automatic pipetter equipped with a cut-off yellow tip. Each sample is then diluted with ~0.5 ml of TE (pH 8.0) and vortexed vigorously for 1–2 minutes. Different amounts of the diluted samples can then be transferred to the individual tubes containing diluted dye solution. The results obtained from the two sets of samples should be consistent.

Use scissors or a dog nail clipper (e.g., Fisher) to generate cut-off yellow tips. Alternatively, the tips can be cut with a sharp razor blade. Sterilize the cut-off tips before use, either by autoclaving or by immersion in 70% alcohol for 2 minutes followed by drying in air. Presterilized, wide-bore tips can be purchased from a number of commercial companies (e.g., Bio-Rad).

The assay can be used to measure the concentration of DNAs whose sizes exceed ~1 kb. Hoechst 33258 binds poorly to smaller DNA fragments.

# Protocol 2

---

## Isolation of High-molecular-weight DNA from Mammalian Cells Using Formamide

**T**HIS PROTOCOL IS A MODIFICATION OF THE PROCEDURE OF KUPIEC et al. (1987) and involves digestion of cells and tissues with proteinase K, dissociation of DNA-protein complexes (chromatin) with high concentrations of formamide, and removal of the protease and organic solvent by extensive dialysis through collodion bags. Formamide is an ionizing solvent that both dissociates protein-DNA complexes and, subsequently, denatures the released proteins. However, it does not significantly affect the activity of proteinase K. The genomic DNA prepared by this procedure is large (>200 kb) and suitable for the construction of libraries in high-capacity vectors and for the analysis of large DNA fragments by pulsed-field gel electrophoresis. The method has two disadvantages: (1) It requires more time than other procedures and (2) the concentration of DNA in the final preparation is low (~10 µg/ml). Approximately 1 mg of high-molecular-weight DNA can be prepared from  $1 \times 10^8$  cultured aneuploid mammalian cells (e.g., HeLa cells).

### MATERIALS

---

**CAUTION:** Please see Appendix 12 for appropriate handling of materials marked with <!>.

### Buffers and Solutions

Please see Appendix 1 for components of stock solutions, buffers, and reagents. Dilute stock solutions to the appropriate concentrations.

#### *Dialysis buffer 1*

20 mM Tris-Cl (pH 8.0)

0.1 M NaCl

10 mM EDTA (pH 8.0)

Prepare 6 liters of Dialysis buffer 1. Store at 4°C.

#### *Dialysis buffer 2*

10 mM Tris-Cl (pH 8.0)

10 mM NaCl

0.5 mM EDTA (pH 8.0)

Prepare 6 liters of Dialysis buffer 2. Store at 4°C.



*Formamide denaturation buffer*

20 mM Tris-Cl (pH 8.0)  
0.8 M NaCl  
80% (v/v) formamide <math>\langle ! \rangle</math>

Many batches of reagent-grade formamide are sufficiently pure to be used without further treatment. However, if any yellow color is present, the formamide should be deionized (for protocol, please see Appendix 8).

*TE (pH 8.0)*

## Gels

*Pulsed-field gel (Chapter 5, Protocol 17 or 18) or 0.6% agarose gel*

## Nucleic Acids and Oligonucleotides

*Linear monomers and concatemers of bacteriophage  $\lambda$  DNA (please see Chapter 5, Protocol 16)*

## Special Equipment

*Blender with stainless steel container (for tissues)*

*Collodion Bags*

The pore size of these collodion bags is 8 nm, which is sufficient to allow denatured proteins of medium size to diffuse through the bags during dialysis. Collodion bags are supplied by Sartorius in 20% ethanol. Before use, they should be rinsed thoroughly in Dialysis buffer 2, and then immersed in 100 ml of the buffer for 30 minutes.

Collodion bags are made from pyroxylin, which is chiefly nitrocellulose, dissolved in ethanol/ether. When the syrupy solution is spread thinly over a surface and allowed to evaporate, it leaves a tough, transparent film that can be molded into bags. For many years, liquid collodion was used as a solvent for wart and corn removers such as salicylic acid.

*Cut-off yellow tips*

Cut-off yellow tips can be generated rapidly with a scissors or a dog nail clipper (Fisher 05-401A). Alternatively, the pointed ends of the tips can be removed with a sharp razor blade. The cut-off tips should be sterilized before use, either by autoclaving or by immersion in 70% alcohol for 2 minutes followed by drying in air. Presterilized, wide-bore tips can be purchased from a number of commercial companies (e.g., Bio-Rad).

*Dialysis tubing clips*

Spectra Por closures from Spectrum Medical Industries, Houston, Texas.

*Glass rod*

*Water bath or incubator preset to 15°C*

*Water bath preset to 50°C*

## Cells and Tissues

*Monolayers or suspensions of mammalian cells, or fresh tissue, or blood samples*

## Additional Reagents

*Materials and equipment used in Steps 1–4 of Protocol 1*

The materials and equipment required depend on the type of starting material: blood, cultured cells, or tissue (please see Protocol 1).

## METHOD

---

1. Prepare lysates of cell suspensions (or frozen cell powders) as described in Steps 1–4 of Protocol 1.
2. Cool the solution containing lysed cells and lysis buffer to 15°C. For every 1 ml of cell lysate, add 1.25 ml of formamide denaturation buffer, and mix the solution gently using a glass rod. Store the solution for 12 hours at 15°C.

3. Pour the viscous solution into one or more collodion bags. Secure the open end of the bag with a dialysis clip and dialyze the solution for 45 minutes at 4°C in 2 liters of Dialysis buffer 1. Replace the buffer with fresh Dialysis buffer 1 and continue the dialysis for at least 4 hours, followed by a further 4 hours in a third 2-liter aliquot of Dialysis buffer 1. Then dialyze the DNA against 2 liters of fresh Dialysis buffer 2, three times, for at least 4 hours each.

Dialysis intervals should be 45 minutes for the first buffer change and 4 hours for all subsequent changes.

A total dialysis time of 24 hours is required to remove proteins from the DNA effectively.

For a description of a convenient and inexpensive device for holding the collodion bags, please see Kupiec et al. (1987).

4. Measure the concentration of the DNA.

It is often difficult to measure the concentration of high-molecular-weight DNA by standard methods such as absorbance at 260 nm. This is because the DNA solution is nonhomogeneous and usually so viscous that it is impossible to withdraw a representative sample for analysis. These problems can be minimized by withdrawing a large sample (10–20  $\mu$ l) with an automatic pipetter equipped with a cut-off yellow tip. The sample is then diluted with ~0.5 ml of TE (pH 8.0) and vortexed vigorously for 1–2 minutes. The absorbance of the diluted sample can then be read at 260, 270, and 280 nm in the standard way.

A solution with a value of 1 ( $A_{260}$  measurement) contains ~50  $\mu$ g of DNA/ml. Note that estimates of purity of nucleic acids based on  $OD_{260}:OD_{280}$  ratios are unreliable (Glasel 1995) and that estimates of concentration are inaccurate if the sample contains significant amounts of phenol.  $H_2O$  saturated with phenol absorbs with a characteristic peak at 270 nm and an  $OD_{260}:OD_{280}$  ratio of 2 (Stulnig and Amberger 1994). Nucleic acid preparations free of phenol (as in this protocol) should have  $OD_{260}:OD_{280}$  ratios of ~1.2. For further information, please see Appendix 8.

More accurate measurement of DNA concentrations can be made by fluorometry in the presence of fluorescent dyes which bind DNA without intercalating and with specificity to double-stranded DNA. The most widely used dye for this purpose is Hoechst 33258, a bisbenzimidazole (for further details, please see Appendix 8). For a method of fluorometric measurement of DNA concentrations, please see the panel on **ADDITIONAL PROTOCOL: ESTIMATING THE CONCENTRATION OF DNA BY FLUOROMETRY** in Protocol 1.

5. Analyze the quality of the preparation of high-molecular-weight DNA by pulsed-field gel electrophoresis (Chapter 5, Protocol 17 or 18) or by electrophoresis through a conventional 0.6% agarose gel (Chapter 5, Protocol 1). Use unit-length and linear concatemers of  $\lambda$  DNA as markers (please see Chapter 5, Protocol 16). The genomic DNA should be more than 200 kb in size.

Do not be concerned if some of the DNA remains in the well, since DNA molecules >250 kb have difficulty in entering the gel. This problem can usually be solved by embedding the DNA in a small amount of melted agarose (at 55°C) and transferring the molten solution to the well of a preformed agarose gel. This transfer should be done before the gel is submerged in electrophoresis buffer.

#### CONCENTRATING SOLUTIONS CONTAINING HIGH-MOLECULAR-WEIGHT DNA

If the concentration of DNA in the preparation is too low to be workable, use a wide-bored pipette or cut-off yellow tip to transfer the DNA into a standard cellulose acetate dialysis bag (e.g., Spectra Por, m.w. cut-off 6000–8000 [VWR Scientific]) (for preparation of dialysis tubing, please see Appendix 8). Place the dialysis bag on a bed of solid sucrose (grade II, Sigma). Pack additional sucrose on top of the bag. This packing is best done at 4°C, on a piece of aluminum foil spread on the bench in a cold room. Allow dialysis to proceed until the volume of the fluid in the dialysis bag has been reduced by a factor of 5–10. Rinse the outside of the bag with TE to remove all of the adherent sucrose. Gently massage the solution of DNA to one end of the bag and then clamp the tubing just above the level of the fluid with a dialysis clip. Dialyze the sample against 4 liters of TE (pH 8.0) for 16–24 hours with at least two changes of buffer.

This method works more efficiently than concentration in Centricon devices or in collodion bags and results in smaller losses of DNA.

# Protocol 3

---

## Isolation of DNA from Mammalian Cells by Spooling

**T**HIS METHOD, ADAPTED FROM BOWTELL (1987), IS USED TO PREPARE DNA simultaneously from many different samples of cells or tissues. The key steps in the protocol are (1) precipitation of the genomic DNA at the interface between the cell lysate and a layer of ethanol, followed by (2) spooling of the precipitated DNA onto a Shepherd's crook. The DNA is then lifted from the ethanolic solution on the crook and dissolved in the aqueous buffer of choice. This method of collecting precipitates of high-molecular-weight DNA was first used in the 1930s (please see the information panel on **SPOOLING DNA** at the end of this chapter). Small fragments of DNA and RNA are not efficiently incorporated into the gelatinous spool. Although the DNA is generally too small (~80 kb) for efficient construction of genomic DNA libraries, it gives excellent results in Southern hybridizations and polymerase chain reactions and can be used to construct a size-fractionated library after limited digestion with a restriction enzyme. Cultured aneuploid mammalian cells ( $2.0 \times 10^7$ , e.g., HeLa cells) yield 100  $\mu\text{g}$  of DNA in a volume of ~1 ml.

---

### MATERIALS

**CAUTION:** Please see Appendix 12 for appropriate handling of materials marked with <!>.

#### Buffers and Solutions

Please see Appendix 1 for components of stock solutions, buffers, and reagents. Dilute stock solutions to the appropriate concentrations.

*Cell lysis solution*

6 M guanidinium hydrochloride <!>

0.1 M sodium acetate (pH 5.5)

*Ethanol (room temperature)*

*TE (pH 8.0)*

#### Gels

*Pulsed-field gel or 0.6% agarose gel*

## Nucleic Acids and Oligonucleotides

*Linear monomers and concatemers of bacteriophage  $\lambda$  DNA (please see Chapter 5, Protocol 16)*

Prepare  $\lambda$  DNA as described in Chapter 2, Protocol 11 or 12. The DNA is used as a size standard during gel electrophoresis.

## Special Equipment

*Kimwipes*

*Polypropylene tubes (50 ml)*

*Rocking platform*

*Shepherd's crooks (used as an alternative to dialysis)*

Shepherd's crooks are Pasteur pipettes whose tip has been sealed in the flame of a Bunsen burner and shaped into a U with a hemostat. Wear safety glasses while molding the Shepherd's crooks.

*Wide-bore pipettes (0.3-cm diameter orifice)*

Wide-bore pipettes are available from several manufacturers. However, standard pipettes can be used if they are autoclaved in the wrong orientation without cotton-wool plugs.

## Additional Reagents

*Materials and equipment used in Step 1 of Protocol 1*

The exact materials and equipment required will depend on the type of starting material: blood, cultured cells, or tissue (please see Protocol 1).

## Cells and Tissues

*Monolayers or suspensions of mammalian cells, fresh tissue, or blood samples*

## METHOD

---

1. Prepare cell suspensions (or frozen cell powders) as described in Step 1 of Protocol 1.
2. Lyse the cells by one of the following two methods.

### FOR LYSIS OF CELLS FROM SUSPENSIONS

- a. Transfer the cell suspensions to disposable 50-ml polypropylene centrifuge tubes.
- b. Add 7.5 volumes of cell lysis solution.

### FOR LYSIS OF CELLS FROM TISSUES

- a. Add the frozen cell powders little by little to ~7.5 volumes of cell lysis solution in beakers. Allow the powders to spread over the surface of the lysis solution, and then shake the beakers to submerge the material.
  - b. When all of the material is in solution, transfer the solutions to centrifuge tubes.
3. Close the tubes and incubate them for 1 hour at room temperature on a rocking platform.
 

Cells or tissue powders incubated with lysis solution as described in Steps 1–3 above can be stored for several months at 4°C before extracting the genomic DNA.
  4. Dispense 18 ml of ethanol at room temperature into each of a series of disposable 50-ml polypropylene centrifuge tubes. Use wide-bore pipettes to layer the cell suspensions carefully *under* the ethanol.

5. Recover the DNA from each tube by slowly stirring the interface between the cell lysate and the ethanol with a Shepherd's crook. The DNA will adhere to the crook, forming a gelatinous mass. Continue stirring until the ethanol and the aqueous phase are thoroughly mixed.
6. Transfer each Shepherd's crook, with its attached DNA, to a separate polypropylene tube containing 5 ml of ethanol at room temperature. Leave the DNA submerged in the ethanol until all of the samples have been processed.
7. Remove each crook, with its attached DNA, and allow as much ethanol as possible to drain away. By this stage, the DNA should have shrunk into a tightly packed, dehydrated mass; it is then possible to remove most of the free ethanol by capillary action by touching the U-shaped end of the crook to a stack of Kimwipes. Before all of the ethanol has evaporated from the DNA, transfer the crook into a fresh polypropylene tube containing 5 ml of ethanol at room temperature.
8. When all of the samples have been processed, again remove as much ethanol as possible (see Step 7).

Do not allow the DNA pellets to dry completely or they will be very difficult to dissolve.
9. Transfer each pipette to a fresh polypropylene tube containing 1 ml of TE (pH 8.0). Allow the DNAs to rehydrate by storing the tubes overnight at 4°C.

Some DNAs may require 24–48 hours to rehydrate completely.
10. During rehydration, the DNAs become highly gelatinous but remain attached to their pipettes. Use fresh Shepherd's crooks as scrapers to free the pellets of DNA gently from their pipettes. Discard the pipettes, leaving the DNA pellets floating in the TE. Close the tubes and incubate them at 4°C on a rocking platform until the pellets are completely dissolved (~24–48 hours).

The level of contamination by RNA is kept within acceptable limits if 1.5 ml or more of lysis solution is used per  $10^7$  cells. However, the amount of RNA contaminating the DNA sample can be further reduced by adding RNase (final concentration of 1 µg/ml) to the solution DNA.

The DNA prepared from homogenized tissues by this method often has a faint brownish-red color (presumably due to contamination with small amounts of hemoglobin). This contamination does not inhibit digestion with restriction enzymes.
11. Analyze an aliquot by pulsed-field gel electrophoresis (Chapter 5, Protocol 17 or 18) or by electrophoresis through a 0.6% agarose gel (Chapter 5, Protocol 1). Store the DNA at 4°C.

The DNA should be ~80 kb in size and should migrate more slowly than monomers of bacteriophage  $\lambda$  DNA.

Because DNA made by this procedure is always contaminated with a small amount of RNA, it is necessary to estimate the concentration of DNA in the final preparation either by fluorometry (please see the panel on **ADDITIONAL PROTOCOL: ESTIMATING THE CONCENTRATION OF DNA BY FLUOROMETRY** in Protocol 1) or by gel electrophoresis and staining with ethidium bromide (Chapter 5, Protocol 2).

# Protocol 4

---

## Isolation of DNA from Mammalian Cells Grown in 96-well Microtiter Plates

**T**HE FOLLOWING PROTOCOL, FROM RAMÍREZ-SOLIS ET AL. (1992, 1993), describes a simple and efficient method for extracting genomic DNA from eukaryotic cells grown in the individual wells of microtiter plates. Each well yields sufficient genomic DNA for several standard polymerase chain reactions (PCRs) or for analysis in a single lane of a Southern hybridization. For a method optimizing the preparations of genomic DNA for use in PCR, please see the panel on **ADDITIONAL PROTOCOL: OPTIMIZING GENOMIC DNA ISOLATION FOR PCR** at the end of this protocol.

### MATERIALS

---

#### Buffers and Solutions

Please see Appendix 1 for components of stock solutions, buffers, and reagents. Dilute stock solutions to the appropriate concentrations.

##### *Cell lysis buffer*

10 mM Tris-Cl (pH 7.5)  
10 mM NaCl  
10 mM EDTA (pH 8.0)  
0.5% (w/v) Sarkosyl

Add proteinase K to the lysis buffer to a final concentration of 1 mg/ml just before use.

Sarkosyl, an anionic detergent, is usually supplied by the manufacturer as a 30% solution in H<sub>2</sub>O. It is less prone than SDS to precipitate from solutions of high ionic strength. However, it is also a less effective detergent than SDS.

##### *Ethanol*

##### *NaCl/ethanol solution*

Add 150 µl of 5 M NaCl per 10 ml of absolute ethanol. Store the NaCl/ethanol solution at -20°C.

##### *Phosphate-buffered saline (PBS)*

##### *Sucrose gel-loading buffer*

##### *TE (pH 8.0)*

#### Enzymes and Buffers

*Appropriate restriction enzymes*

*DNase-free RNase*

## Special Equipment

*Aspiration device connected to a vacuum line fitted with traps*

*Multichannel pipettor, 8 or 12 channels*

Rainin EDP-Plus M8 from Rainin Inc.

These devices aid the addition of multiple reagents to individual wells of microtiter plates. If PCR will be used to screen the cell cultures, use plugged pipette tips. The barrels of multichannel pipettes should be disassembled and cleaned before use.

*Oven, preset to 60°C*

The oven should be capable of maintaining a temperature of 60°C for 12–16 hours.

*Rocking platform*

*Tupperware containers*

These containers should be able to withstand extended incubations at 60°C.

## Cells and Tissues

*Cells growing in 96-cell plates*

Cell cultures in individual flat-bottomed wells of 96-well tissue culture plates should be grown to confluence, or close to it. These plates are available from most suppliers of materials used for tissue culture. Label both the tops and the bottoms of the 96-well plates when working with more than one plate.

## METHOD

---

1. Remove the medium from confluent cultures of cells growing in individual wells of 96-well plates by aspiration through a blue pipette tip or a Pasteur pipette.  
As long as care is taken to avoid touching the cell layer, there is generally no need to use a fresh pipette tip for each well.
2. Rinse the monolayers of cells in the individual wells twice with 100  $\mu$ l of phosphate-buffered saline.
3. Use a multichannel pipettor to add 50  $\mu$ l of cell lysis buffer to each well of the microtiter plate. Place several wet paper towels in a polypropylene box (e.g., a Tupperware box) and then stack the microtiter plates containing the lysis buffer and cells on top of the towels. Seal the box tightly with the lid.
4. Incubate the sealed box for 12–16 hours in a 60°C oven.
5. Remove the box from the oven, place the plates on a flat bench top, and allow them to cool for a few minutes before adding 100  $\mu$ l of NaCl/ethanol solution per well. Store the plates for 30 minutes at room temperature without mixing. A stringy precipitate of nucleic acid should be visible at the end of the incubation.
6. Slowly invert each plate over a sink to decant the ethanolic solution. The precipitated nucleic acid should remain attached to the base of the wells. Place each plate in an upside down position on a bed of dry paper towels and allow the remaining ethanol to drain from the plate.
7. Add 150  $\mu$ l of 70% ethanol to each well, being careful not to dislodge the precipitate of nucleic acid. Discard the 70% ethanol by inverting the plate as in Step 6. Blot the excess liquid on a bed of paper towels. Rinse the precipitates of DNA twice more with 70% ethanol.
8. Allow the plates to dry at room temperature until the last traces of ethanol have evaporated. If the genomic DNA is to be analyzed by PCR, then proceed to Step 9. If the DNA is to be analyzed by Southern hybridization, proceed to Steps 10, 11, and 12.

9. Add 30–50  $\mu\text{l}$  of TE (pH 8.0) to each well and allow the DNA to dissolve during gentle rocking for 12–16 hours at room temperature.

Dissolution of the DNA can be accelerated by placing the microtiter dishes on the heating block of a thermal cycler that is programmed to cycle 10 times between 80°C and 50°C (1 minute at each temperature).

The DNA may now be used as template for standard PCR (please see Chapter 8, Protocol 1).

10. If the DNA is to be analyzed by Southern blotting, make up the following restriction enzyme mixture; 40  $\mu\text{l}$  of the mixture will be required for each well.

H <sub>2</sub> O	0.8 volume
10x restriction enzyme buffer	0.1 volume
DNase-free RNase	10 $\mu\text{g}/\text{ml}$

Just before use, add 10 units of restriction enzyme for each 40  $\mu\text{l}$  of mixture.

11. Use a multichannel pipettor to add 40  $\mu\text{l}$  of the restriction enzyme mixture to each well. Mix the contents of the wells by pipetting up and down several times, taking care to avoid air bubbles. Incubate the reactions at the appropriate digestion temperature for 12–16 hours in a humidified sealed Tupperware box as described in Step 3.
12. Stop the reactions by adding 5–10  $\mu\text{l}$  of sucrose gel-loading buffer and analyze the digested DNA by Southern blotting and hybridization as described in Protocols 8, 9, and 10.



**ADDITIONAL PROTOCOL: OPTIMIZING GENOMIC DNA ISOLATION FOR PCR**

Genomic DNA, isolated by the method given above, can be used as template in standard PCRs. However, for more demanding types of PCR (e.g., long PCR; see Chapter 8, Protocol 13), it is better to use a variation in which acetone and *N,N*-dimethylformamide are used to precipitate DNA in the 96-well plate (Udy and Evans 1994).

If the isolated DNAs will be used only as templates for PCR and not be analyzed by Southern hybridization, the cells in the wells of the microtiter plates can be lysed in a solution that is compatible with PCR. Lysis in such a buffer allows PCR to be carried out directly in the lysis solution and eliminates the need for ethanol precipitation and rinsing. The two protocols given below are robust and work well with a variety of thermostable DNA polymerases.

**CAUTION:** Please see Appendix 12 for appropriate handling of materials marked with <!.>.

**PROTOCOL A****Materials***PCR lysis solution A*

- 67 mM Tris-Cl (pH 8.8)
- 16.6 mM ammonium sulfate
- 5 mM  $\beta$ -mercaptoethanol <!.>
- 6.7 mM  $MgCl_2$
- 6.7  $\mu$ M EDTA (pH 8.0)
- 1.7  $\mu$ M SDS
- 50  $\mu$ g/ml proteinase K

**Method**

1. Remove the media from cultures of cells growing in 96-well plates.
2. Deliver 100  $\mu$ l of PCR lysis solution A into each well and lyse the cells by incubation for 1 hour at 37°C, followed by a 10-minute incubation at 80°C to inactivate the proteinase K.
3. Use 5–25- $\mu$ l aliquots of the DNA preparations as templates in PCRs.

**PROTOCOL B (Köntgen and Stewart 1993)****Materials***PCR lysis solution B*

- 10 mM Tris-Cl (pH 8.3)
- 50 mM KCl
- 2 mM  $MgCl_2$
- 0.45% (v/v) Nonidet P-40
- 0.45% (v/v) Tween-20
- 20  $\mu$ g/ml proteinase K

*Lysate buffer*

- 670 mM Tris-Cl (pH 8.8)
- 166 mM ammonium sulfate
- 1 mg/ml bovine serum albumin

**Method**

1. Remove the medium from cultures of cells growing in 96-well plates.
2. Deliver 50  $\mu$ l of PCR lysis solution B into each well and lyse the cells by incubation overnight at 37°C, followed by a 30-minute incubation at 95°C to inactivate the proteinase K.
3. To each lysate add an equal volume of a lysate buffer.
4. Use 10–50- $\mu$ l aliquots of the DNA preparations as templates in PCRs.

# Protocol 5

---

## Preparation of Genomic DNA from Mouse Tails and Other Small Samples

**O**VER THE YEARS, MANY PROTOCOLS FOR THE EXTRACTION OF DNA from mouse tails have been published, almost all of them descendants of the original method developed by Richard Palmiter and Ralph Brinster in 1985 (Palmiter et al. 1985). Palmiter's laboratory was in Seattle, while Brinster and his thousands of mice were 3000 miles away in Philadelphia. Brinster would snip fragments of tails from the mice, place them in a solution of SDS and proteinase K, and, in those pre-FedEx days, would ship them to Palmiter by U.S. Mail. After their 2–3-day journey at ambient temperature, the samples were extracted with phenol:chloroform, and the genomic DNA was recovered by precipitation with ethanol. Success with this method fortunately does not require entrusting semidigested mouse parts to the care of the U.S. postal system. Instead, the digestions can be more conveniently carried out overnight at 55°C, without transportation. Each tail snip-pet generates 50–100 µg of DNA that can be used in dot or slot blotting to detect a transgene of interest, in Southern hybridization to detect DNA fragments that are <20 kb in size, and, more expediently, as a template in PCRs. This simple protocol continues to be used in hundreds of laboratories for genotyping transgenic and knock-out mice and for extracting DNA from small numbers of cultured cells or from fragments of tissue.

Two variants of the basic protocol are useful when processing very large numbers of samples. The method of Laird et al. (1991) omits extraction with phenol:chloroform, whereas the protocols described by Thomas et al. (1989) and Couse et al. (1994) use commercially available gel-barrier tubes to eliminate the tedious transfer of samples during serial extraction with organic solvents. These variations are described in the alternative protocols at the end this protocol.

### MATERIALS

---

**CAUTION:** Please see Appendix 12 for appropriate handling of materials marked with <!>.

#### Buffers and Solutions

Please see Appendix 1 for components of stock solutions, buffers, and reagents. Dilute stock solutions to the appropriate concentrations.

*Ethanol*

*Isopropanol*

*Phenol:chloroform:isoamyl alcohol (25:24:1 v/v) <!>*

*Phosphate-buffered saline*

*SNET*

20 mM Tris-Cl (pH 8.0)

5 mM EDTA (pH 8.0)

400 mM NaCl

1% (w/v) SDS

Sterilize the solution by filtration through a 0.45- $\mu$ m nitrocellulose filter. Store the sterile solution in 50-ml aliquots at room temperature.

*TE (pH 8.0)*

## Enzymes and Buffers

*Proteinase K (20 mg/ml)*

Please see Appendix 4.

## Centrifuges and Rotors

*Sorvall H1000B and SH-3000 rotors or equivalents*

## Special Equipment

*Polypropylene tubes (17 x 100 mm)*

*Rocking platform at room temperature and 4°C*

*Rocking platform or shaking incubator, preset to 55°C*

*Shepherd's crook (for a description, please see Steps 5–7 of Protocol 3)*

## Cells and Tissues

### *Cultured Cells*

Monolayer cultures, grown to confluence or semiconfluence in 100-mm dishes, should be washed twice with ice-cold phosphate-buffered saline and then immediately lysed by addition of 1 ml of SNET containing 400  $\mu$ g/ml proteinase K, as described in Step 1.

Cells growing in suspension should be recovered by centrifugation, washed twice in ice-cold phosphate-buffered saline, and then resuspended in TE (pH 8.0) at a concentration of  $5 \times 10^7$ /ml. Aliquots of the suspension (0.2 ml) are then transferred to a series of 17 x 100-mm Falcon polypropylene tubes and the cells are immediately lysed with SNET containing 400  $\mu$ g/ml proteinase K, as described in Step 1.

### *Mouse tails or mouse tissue*

Samples of mouse tails are generally cut from 10-day old suckling animals or at the time of weaning (~3 weeks of age). In the former case, the distal one third of the tail is removed and transferred into a microfuge. In the latter case, 6–10 mm of the tail is removed under anesthesia and transferred to a 17 x 100-mm Falcon polypropylene tube. Under rare circumstances, where obtaining a result rapidly is of paramount importance, the entire tail can be removed from newborn animals and transferred to a microfuge tube.

To isolate DNA from mouse tissue (other than tail snippets), transfer ~100 mg of the freshly dissected tissue to a 17 x 100-mm Falcon polypropylene tube.

Mouse tails or other tissues can be stored for a few weeks at  $-70^\circ\text{C}$  in tightly closed tubes before adding SNET and proteinase K. However, it is better to proceed without delay to digest the samples with proteinase K (Steps 1 and 2). The completed digests can then be stored indefinitely at  $-20^\circ\text{C}$  before phenol:chloroform extraction.

All experiments carried out on laboratory mice, including removing sections of tail, require prior authorization from the appropriate institutional ethics committee.

## METHOD

---

1. Prepare the appropriate amount of lysis buffer (see Table 6-1) by adding proteinase K to a final concentration of 400  $\mu$ g/ml in SNET. Add lysis buffer to the mouse tails or other tissues.

This procedure also can be used to isolate DNA from monolayers of cultured mammalian cells. In this case, 1 ml of SNET containing 400  $\mu$ g/ml proteinase K is added directly to 100-mm monolay-

TABLE 6-1 SNET Lysis Buffer Volumes

AGE OF MOUSE	AMOUNT OF TISSUE	TYPE OF TUBE	VOLUME OF SNET LYSIS BUFFER (ml)
Newborn	entire tail (1 cm)	microfuge	0.5
10 days old	distal one-third	microfuge	0.5
Weanling (3–4 weeks)	6–10-mm	17 × 100-mm polypropylene	4.0
Any age	100 mg of fresh tissue	17 × 100-mm polypropylene	4.0

ers that have been rinsed twice in phosphate-buffered saline. The viscous cell slurry is scraped from the dish with a rubber policeman, and transferred to a 17 × 100-mm polypropylene Falcon tube.

Cells growing in suspension that have been washed twice in phosphate-buffered saline are resuspended in TE and lysed with SNET containing 400 µg of proteinase K (1 ml per 10<sup>9</sup> cells).

2. Incubate the tube overnight at 55°C in a horizontal position on a rocking platform or with agitation in a shaking incubator.

It is important that the sample be mixed adequately during digestion. After overnight incubation, the tissue/tails should no longer be visible and the buffer should be a milky-gray.

3. Add an equal volume of phenol:chloroform:isoamyl alcohol, seal the top of the tube, and place it on a rocking platform for 30 minutes at room temperature.

Protocols differ in their use of vortexing at various stages of the protocol. Some protocols state flatly not to vortex. Others say that vortexing ensures a greater yield of DNA composed of fragments up to 20 kb in length that can be detected by Southern hybridization, dot and slot blotting, and PCR analysis. If DNA of higher molecular weight is required, take care to minimize shearing forces (please see the information panel on **MINIMIZING DAMAGE TO LARGE DNA MOLECULES** in Chapter 2).

4. Separate the organic and aqueous phases by centrifugation. Centrifuge the samples in 17 × 100-mm polypropylene tubes at 666g (1800 rpm in a Sorvall H1000B rotor with swinging buckets or 1600 rpm in a Sorvall SH-3000 swinging bucket rotor) for 5 minutes at room temperature. Alternatively, for smaller sample volumes, centrifuge the samples in microfuge tubes at maximum speed for 5 minutes at room temperature in a microfuge. Transfer the upper aqueous phase to a fresh Falcon or microfuge tube.
5. Precipitate the DNA by adding an equal volume of isopropanol. Collect the precipitated DNA by centrifugation at 13,250g (8000 rpm in a Sorvall SH-3000 swinging bucket rotor or maximum speed in a microfuge) for 15 minutes at 4°C.
6. Carefully remove the isopropanol. Rinse the pellet of DNA with 1 ml of 70% ethanol. If the pellets are loose, centrifuge the samples again for 5 minutes. Remove the 70% ethanol, and allow the pellets to dry in air for 15–20 minutes at room temperature.

Do not allow the DNA pellets to dry completely or they will be very difficult to dissolve.

7. Dissolve the nucleic acid pellet by rocking it gently overnight in 0.5 ml of TE (pH 8.0) at 4°C.
8. Transfer the solution to a microfuge tube and store it at room temperature.

Between 100 µg and 250 µg of genomic DNA is typically isolated from 1 cm (~100 mg) of mouse tail.

The addition of bovine serum albumin at a concentration of 100 µg/ml to restriction enzyme digests of genomic DNA prepared by this method will absorb residual SDS and reduce the possibility of incomplete digestions. If problems persist, re-extract the samples once more with phenol:chloroform and precipitate the DNA with 2 volumes of ethanol.

**ALTERNATIVE PROTOCOL: ISOLATION OF DNA FROM MOUSE TAILS WITHOUT EXTRACTION BY ORGANIC SOLVENTS**

Laird et al. (1991) describe a variation of the preceding protocol that does not require extraction with phenol:chloroform and can also be applied to mammalian cells grown in 24-well culture dishes.

**Additional Materials***Mouse-tail lysis buffer I*

- 100 mM Tris-Cl (pH 8.5)
- 5 mM EDTA (pH 8.0)
- 200 mM NaCl
- 0.2% (w/v) SDS
- 100 µg/ml proteinase K

**Method**

1. Add 0.5 ml of Mouse-tail lysis buffer I to 1 cm of mouse tail in a microfuge tube.
2. Digest the tissue at 55°C as described in Step 2 of the main protocol.
3. Shake the digested sample vigorously, and centrifuge the tube at maximum speed for 10 minutes at room temperature in a microfuge to sediment undigested tissue.
4. Transfer the supernatant to a fresh microfuge tube containing 0.5 ml of isopropanol at room temperature. Mix the contents of the tube by inversion.
5. Fish out the stringy precipitate of DNA with a clean disposable micropipette tip or a Shepherd's crook. Briefly touch the precipitate to a Kimwipe to remove excess alcohol and then transfer the DNA to a fresh microfuge tube.
6. Store the open tube on the bench until the remaining alcohol has evaporated.
7. Dissolve the DNA in 200–500 µl of TE (pH 8.0), by rocking it gently overnight at 4°C.

The yield of DNA usually varies from 5 to 12 µg/mm of mouse tail.

**ALTERNATIVE PROTOCOL: ONE-TUBE ISOLATION OF DNA FROM MOUSE TAILS**

Couse et al. (1994) have described a method based on earlier work of Thomas et al. (1989) that uses serial extractions with organic solvents to extract DNA from mouse tails; the same method can be applied to mammalian cells grown in 24-well culture dishes. Serial extractions usually require transfer of the aqueous phase to fresh tubes — a process that can be lengthy and boring. These disadvantages can be overcome by using serum separation tubes (SST), sold by Becton Dickinson. The tubes are made of a glass, with an inert gel plug at the base and a silicon rubber stopper. During centrifugation, the gel plug migrates to the top of the organic phase, trapping the cellular proteins and debris in the lower part of the tube and leaving the aqueous phase on the top of the plug. Serial extractions with organic solvents can be carried out in the same SST because the gel plug will always migrate during centrifugation to a position between the organic and aqueous phases.

**Additional Reagents**

**CAUTION:** Please see Appendix 12 for appropriate handling of materials marked with <!>.

*Ethanol**Chloroform <!>**Mouse-tail lysis buffer II*

- 50 mM Tris-Cl (pH 8.0)
- 50 mM EDTA (pH 8.0)
- 0.125% (w/v) SDS
- 800 µg/ml proteinase K

*Sodium acetate (3 M, pH 6.0)**SST tubes (Becton Dickinson)***Method**

1. Add 1.0 ml of Mouse-tail lysis buffer II to 5 mm of mouse tail in an SST tube.
2. Digest the tissue overnight at 55°C as described in Step 2 of the main protocol.

(Continued on facing page.)

3. Add 1 ml of phenol:chloroform:isoamyl alcohol and mix the contents of the tube thoroughly by gentle inversion.
4. Centrifuge the tube at 2000g (3100 rpm in a Sorvall H1000B rotor) for 10 minutes at room temperature in a swinging bucket rotor. Repeat the centrifugation step if the aqueous phase is cloudy or if some of the protein interface remains trapped above the plug.
5. To the same tube, add 1 ml of chloroform and recentrifuge as described in Step 4.
6. Transfer 450- $\mu$ l aliquots of the aqueous layer above the plug to two microfuge tubes containing 50  $\mu$ l of 3 M sodium acetate (pH 6.0).

The use of sodium acetate at pH 6.0, rather than pH 5.2, is unusual. EDTA is used in the lysis buffer at high concentration (100 mM) and will precipitate at low pH. This problem can best be avoided by maintaining a pH >6.0 and by working quickly during Steps 6 and 7. Alternatively, the concentration of EDTA in the lysis buffer may be reduced to 20 mM. However, this may not be enough to chelate all of the  $Mg^{2+}$  in the sample, leaving the DNA open to attack by DNases.

7. Add 2 volumes (0.9 ml) of ethanol (room temperature) to each tube. Working quickly, mix the contents of the tube by inversion and immediately centrifuge the tube at maximum speed for 5 minutes at room temperature in a microfuge.
8. Wash the pellets of DNA with 70% ethanol and recentrifuge. Remove the ethanolic solution by aspiration and leave the open tubes on the bench until any remaining ethanol has evaporated.
9. Dissolve the DNA in 250  $\mu$ l of TE (pH 8.0) by rocking it gently overnight at 4°C.

The yield of DNA is usually 10  $\mu$ g/mm of mouse tail.

#### **ALTERNATIVE PROTOCOL: DNA EXTRACTION FROM PARAFFIN BLOCKS**

Archival tissue is often used as a source of DNA for the identification of mutations in human genetic diseases, in part because tissue samples are collected during a surgical operation and fixed, stained, and stored by pathologists. Although there are a number of publications that compare different methods for the extraction of DNA from paraffin blocks (e.g., please see Sepp et al. 1994), we have found that it is best to use one of the commercially available kits for DNA isolation from paraffin-embedded tissue. Kits from Intergen (EX-WAX DNA Extraction Kit) have proven to be efficient at extraction of DNA from tissues that have been embedded for as long as 17 years. Other investigators have reported the isolation of DNA from much older paraffin blocks. The extracted DNA is highly degraded and is useful only as a template in PCRs.

# Protocol 6

---

## Rapid Isolation of Mammalian DNA

**M**AMMALIAN DNA PREPARED ACCORDING TO THIS PROTOCOL is 20–50 kb in size and suitable for use as a template in PCRs. The yields of DNA vary between 0.5 and 3.0 µg/mg tissue or 5 and 15 µg per 300 µl of whole blood.

### MATERIALS

---

**CAUTION:** Please see Appendix 12 for appropriate handling of materials marked with <!.>.

#### Buffers and Solutions

Please see Appendix 1 for components of stock solutions, buffers, and reagents. Dilute stock solutions to the appropriate concentrations.

##### *Cell lysis buffer*

10 mM Tris-Cl (pH 8.0)

1 mM EDTA (pH 8.0)

0.1% (w/v) SDS

Store the buffer at room temperature, but chill an aliquot to 0°C in readiness for Step 2.

##### *Ethanol*

##### *Isopropanol*

##### *Potassium acetate solution*

60 ml of 5 M potassium acetate

11.5 ml of glacial acetic acid <!.>

28.5 ml of H<sub>2</sub>O

The resulting solution is 3 M with respect to potassium and 5 M with respect to acetate.

Store the buffer at room temperature.

##### *Red blood cell lysis buffer*

20 mM Tris-Cl (pH 7.6)

Store the buffer at room temperature.

##### *TE (pH 7.6)*

#### Enzymes and Buffers

*DNase-free RNase (4 mg/ml)*

*Proteinase K (20 mg/ml)*

Optional, please see Step 3 and Appendix 4.

## Special Equipment

*Aspiration device connected to a vacuum line*

*Microfuge pestle*

*This is available from Sigma in both hand-operated and motor-driven versions.*

*Mortar and pestle, prechilled with liquid nitrogen <!-->*

*Water bath preset to either 55°C or 65°C*

## Cells and Tissues

*Mammalian tissue or whole blood of interest*

## METHOD

---

1. Prepare tissue or whole blood for genomic DNA isolation.

### FOR TISSUE

- a. Dissect 10–20 mg of tissue.
- b. Either mince the tissue finely with a razor blade/scalpel or freeze the tissue in liquid nitrogen and then grind it to a powder in a mortar prechilled with liquid nitrogen, as described in Protocol 1.

### FOR BLOOD

- a. Transfer 300- $\mu$ l aliquots of whole blood to each of two microfuge tubes. Add 900  $\mu$ l of red blood cell lysis buffer to each tube and invert the capped tubes to mix the contents. Incubate the solution at room temperature for 10 minutes, occasionally inverting the tubes.
  - b. Centrifuge the tubes at maximum speed for 20 seconds at room temperature in a microfuge.
  - c. Discard all but 20  $\mu$ l of each supernatant.
  - d. Resuspend the pellets of white cells in the small amount of supernatant left in each tube. Combine the resuspended cell pellets in a single tube.
2. Transfer the minced tissue or the resuspended white blood cell pellets to a microfuge tube containing 600  $\mu$ l of ice-cold cell lysis buffer. Homogenize the suspension quickly with 30–50 strokes of a microfuge pestle.
 

*The SDS will precipitate from the ice-cold cell lysis buffer producing a cloudy solution. This precipitation will not affect isolation of DNA.*
  3. (*Optional*) Add 3  $\mu$ l of proteinase K solution to the lysate to increase the yield of genomic DNA. Incubate the digest for at least 3 hours but no more than 16 hours at 55°C.
  4. Allow the digest to cool to room temperature and then add 3  $\mu$ l of 4 mg/ml DNase-free RNase. Incubate the digest for 15–60 minutes at 37°C.
  5. Allow the sample to cool to room temperature. Add 200  $\mu$ l of potassium acetate solution and mix the contents of the tube by vortexing vigorously for 20 seconds.



6. Pellet the precipitated protein/SDS complex by centrifugation at maximum speed for 3 minutes at 4°C in a microfuge.  
A pellet of protein should be visible at the bottom of the microfuge tube after centrifugation. If not, incubate the lysate for 5 minutes on ice and repeat the centrifugation step.
7. Transfer the supernatant to a fresh microfuge tube containing 600 µl of isopropanol. Mix the solution well and then recover the precipitate of DNA by centrifuging the tube at maximum speed for 1 minute at room temperature in a microfuge.
8. Remove the supernatant by aspiration and add 600 µl of 70% ethanol to the DNA pellet. Invert the tube several times and centrifuge the tube at maximum speed for 1 minute at room temperature in a microfuge.
9. Carefully remove the supernatant by aspiration and allow the DNA pellet to dry in air for 15 minutes.
10. Redissolve the pellet of DNA in 100 µl of TE (pH 7.6).  
The solubilization of the genomic DNA pellet can be facilitated by incubation for 16 hours at room temperature or for 1 hour at 65°C.

# Protocol 7

---

## Rapid Isolation of Yeast DNA

**Y**EAST DNAs PREPARED ACCORDING THIS PROTOCOL can be used as templates in PCRs. Shuttle plasmids that replicate in both *Escherichia coli* and *Saccharomyces cerevisiae* can be extracted from yeast by this method and used to transform *E. coli*. The following protocol was provided by Peter Espenshade (University of Texas Southwestern Medical Center, Dallas). For an alternative method for preparing yeast DNA, please see Chapter 4, Protocol 12.

---

### MATERIALS

---

**CAUTION:** Please see Appendix 12 for appropriate handling of materials marked with <!.>.

#### Buffers and Solutions

Please see Appendix 1 for components of stock solutions, buffers, and reagents. Dilute stock solutions to the appropriate concentrations.

*Ethanol*

*Phenol:chloroform (1:1, v/v) <!.>*

*Sodium acetate (3 M, pH 5.2)*

*STES buffer*

0.2 M Tris-Cl (pH 7.6)

0.5 M NaCl

0.1 % (w/v) SDS

0.01 M EDTA

Store at room temperature.

*TE (pH 7.6)*

#### Special Equipment

*Acid-washed glass beads (0.4 mm)*

Washed glass beads may be purchased, for example, from Sigma. Unwashed beads are not recommended.

#### Cells and Tissues

*Yeast cells, freshly grown either as colonies on an agar plate or as an overnight culture*

## METHOD

---

1. Prepare the yeast cells for lysis.

### FOR YEAST COLONIES ON PLATES

Use a sterile inoculating loop to transfer one or more large, freshly grown colonies to a microfuge tube containing 50  $\mu$ l of STES buffer.

### FOR YEAST GROWN IN LIQUID CULTURE

- a. Transfer 1.5 ml from an overnight culture of yeast cells to a microfuge tube.
  - b. Pellet the cells by centrifuging at maximum speed for 1 minute at room temperature in a microfuge.
  - c. Remove the culture medium by aspiration and resuspend the pellet in 50  $\mu$ l of STES buffer.
2. Add ~50  $\mu$ l of acid-washed glass beads to each tube containing the resuspended yeast. Add 20  $\mu$ l of TE (pH 7.6) to each tube.
  3. Add 60  $\mu$ l of phenol:chloroform, cap the tubes, and mix the organic and aqueous phases by vortexing for 1 minute.
  4. Centrifuge the tubes at maximum speed for 5 minutes at room temperature in a microfuge.
  5. Transfer the upper aqueous phase to a fresh microfuge tube. Collect the DNA by standard precipitation with ethanol for 15 minutes at 0°C.
  6. Recover the precipitate of nucleic acids by centrifugation at maximum speed for 10 minutes at 4°C in a microfuge.
  7. Remove the supernatant by aspiration and rinse the pellet with 100  $\mu$ l of 70% ethanol in H<sub>2</sub>O. Centrifuge the tubes at maximum speed for 1 minute at room temperature in a microfuge.
  8. Remove the supernatant by aspiration and allow the pellet to dry in the air for 15 minutes. Redissolve the pellet in 40  $\mu$ l of TE (pH 7.6).

Use 1–10  $\mu$ l of the solution of DNA as template in PCRs. Shuttle plasmids can be recovered by transforming preparations of competent *E. coli* with 1  $\mu$ l of the DNA.

## Southern Hybridization

**S**OUTHERN TRANSFER AND HYBRIDIZATION (Southern 1975) is used to study how genes are organized within genomes by mapping restriction sites in and around segments of genomic DNA for which specific probes are available. Genomic DNA is first digested with one or more restriction enzymes, and the resulting fragments are separated according to size by electrophoresis through a standard agarose gel. The DNA is then denatured *in situ* and transferred from the gel to a solid support (usually a nylon or nitrocellulose membrane). The DNA attached to the membrane is hybridized to a labeled DNA, RNA, or oligonucleotide probe, and bands complementary to the probe are located by an appropriate detection system, for example, by autoradiography. By estimating the size and number of the bands generated after digestion of the genomic DNA with different restriction enzymes, singly or in combination, it is possible to place the target DNA within a context of restriction sites.

For 2 or 3 years after its introduction, the sensitivity of Southern blotting was barely sufficient to detect single-copy sequences in mammalian DNA, and the autoradiographs of the time were so speckled and streaked with background (e.g., please see Botchan et al. 1976) that they certainly could not be published today. However, significant advances over the years in several areas have brought increased sensitivity and reproducibility, so that immaculate results are now the general rule rather than the rare exception. The most significant of these improvements is the use of supported nylon membranes that are far more durable and have a higher binding capacity than the original nitrocellulose membranes. In addition, DNA can now be covalently fixed to the membrane after transfer, eliminating problems caused by leaching of nucleic acids from nitrocellulose membranes during incubation at elevated temperatures (Haas et al. 1972). Other advances include

- More efficient methods of transfer of DNA from gel to membrane, downward capillary transfer (Lichtenstein et al. 1990; Chomczynski 1992), vacuum blotting (Medveczky et al. 1987; Olszewska and Jones 1988; Trnovsky 1992), bidirectional blotting (please see Protocol 9), and transfer in alkaline buffers (Reed and Mann 1985).
- Facile labeling of probes *in vitro* to higher specific activity (Feinberg and Vogelstein 1983, 1984).
- More efficient blocking agents to prevent nonspecific attachment of radiolabeled probes to membranes (Church and Gilbert 1984).
- Use of sensitive phosphorimagers to capture images with high efficiency.

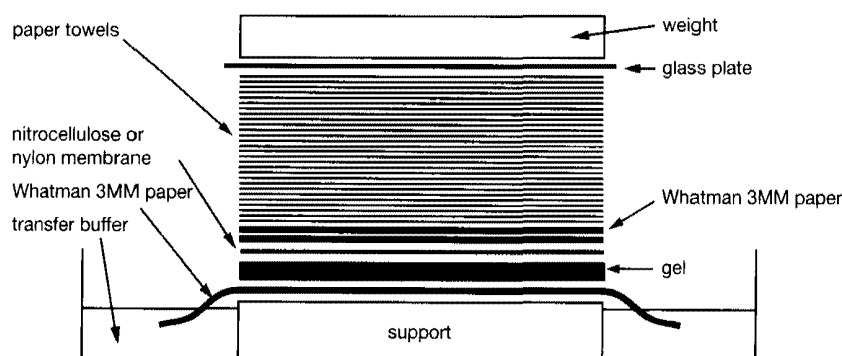
Many of these improvements have been incorporated into Protocols 8 and 9, which deal with transfer of DNA from gels to membranes, and Protocol 10, which describes hybridization of radiolabeled probes to immobilized DNAs. The techniques described are suitable for Southern analysis of restriction digests of mammalian genomic DNA but can easily be adapted to accommodate large DNA molecules separated by pulsed-field gels, as well as restriction digests of plasmids, cosmids,  $\lambda$  bacteriophages, bacterial artificial chromosomes (BACs), and yeast artificial chromosomes (YACs).

## METHODS OF TRANSFERRING DNA FROM AGAROSE GELS TO SOLID SUPPORTS

The transfer of electrophoretically separated DNA from gels to two-dimensional solid supports is a key step in Southern hybridization. Described below are five methods to transfer fragments of DNA from agarose gels to solid supports (nitrocellulose or nylon membranes).

### Upward Capillary Transfer

DNA fragments are carried from the gel in an upward flow of liquid and deposited on the surface of the solid support (Southern 1975). The liquid is drawn through the gel by capillary action that is established and maintained by a stack of dry absorbent paper towels (please see Figure 6-1). The rate of transfer of the DNA depends on the size of the DNA fragments and the concentration of agarose in the gel. Small fragments of DNA (<1 kb) are transferred almost quantitatively from a 0.7% agarose gel within 1 hour; larger fragments are transferred more slowly and less efficiently. For example, capillary transfer of DNAs >15 kb in length requires at least 18 hours, and even then the transfer is not complete. The efficiency of transfer of large DNA fragments is determined by the fraction of molecules that escape from the gel before it becomes dehydrated. As elution proceeds, fluid is drawn not only from the reservoir, but also from the interstices of the gel itself. This flow reduces the gel to a rubbery substance through which DNA molecules cannot easily pass. The problem of dehydration due to lengthy transfer can be alleviated by partial acid/base hydrolysis of the DNA before capillary transfer (Wahl et al. 1979; Meinkoth and Wahl 1984). The DNA in the gel is exposed to weak acid (which results in partial depurination), followed by strong base (which hydrolyzes the phosphodiester backbone at the sites of depurination). The resulting frag-



**FIGURE 6-1** Upward Capillary Transfer of DNA from Agarose Gels

Buffer drawn from a reservoir passes through the gel into a stack of paper towels. DNA eluted from the gel by the moving stream of buffer is deposited onto a nitrocellulose or nylon membrane. A weight applied to the top of the paper towels helps to ensure a tight connection between the layers of material used in the transfer system.

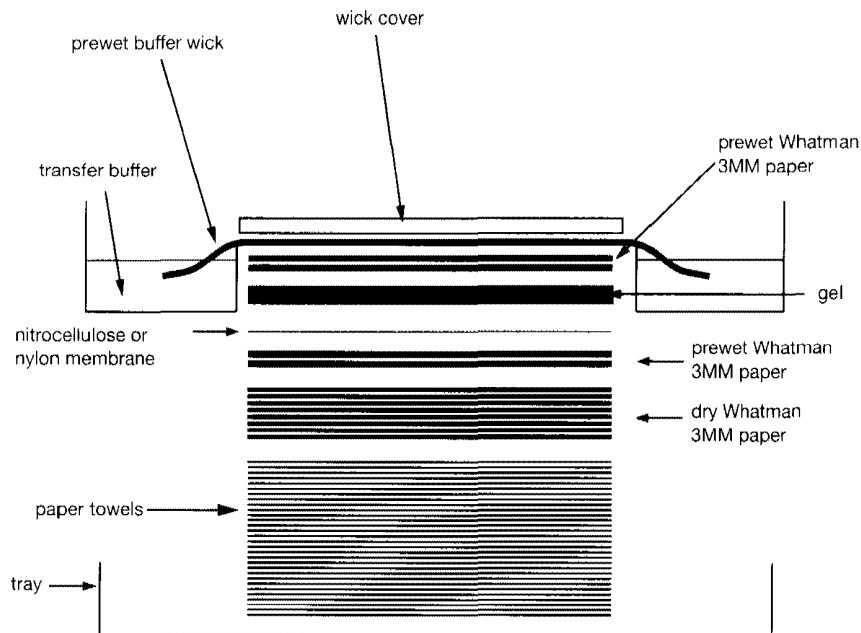
ments of DNA (~1 kb in length) can then be transferred rapidly from the gel with high efficiency. The depurination reaction must not proceed too far; otherwise, the DNA will be cleaved into small fragments that are too short to bind efficiently to the solid support. Depurination/hydrolysis can also cause the bands of the final autoradiograph to assume a "fuzzy" appearance, presumably because of increased diffusion of DNA during transfer. Therefore, depurination/hydrolysis is recommended only when it is known ahead of time that the target DNA fragments will exceed 15 kb in length.

### Downward Capillary Transfer

DNA fragments are carried in a downward direction in a flow of alkaline buffer and are deposited onto the surface of a charged nylon membrane. Various arrangements of wicks, reservoirs, and different formulations of transfer buffers have been described to achieve downward transfer (e.g., please see Lichtenstein et al. 1990; Chomczynski 1992). In our hands, the best results are achieved using 0.4 M NaOH and a setup in which the transfer buffer is drawn from reservoirs to the top of the gel through wicks and pulled through the gel by an underlying stack of paper towels (please see Figure 6-2) (Koetsier et al. 1993). Transfer of DNA fragments is rapid, and the intensity of signal is ~30% greater than can be achieved by conventional upward transfer. This improvement probably results from a more efficient migration of DNA fragments through the interstices of the gel, which is not under pressure from weights placed on top.

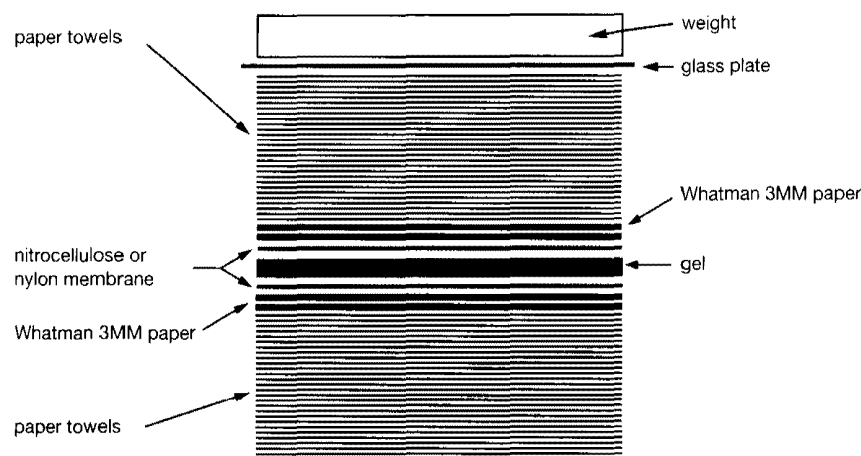
### Simultaneous Transfer to Two Membranes

When the target DNA fragments are present in high concentration (e.g., in restriction digests of cloned DNAs), the capillary method can be used to transfer DNA simultaneously and rapidly



**FIGURE 6-2 Downward Capillary Transfer**

Alkaline transfer buffer is drawn from reservoirs to the top of the gel through wicks and sucked through the gel by an underlying stack of paper towels. DNA fragments are thus carried in a downward direction with the flow of buffer and are deposited onto the surface of a charged nylon membrane. (Adapted, with permission, from Koetsier et al. 1993.)



**FIGURE 6-3 Capillary Transfer of DNA from Agarose Gels to Two Solid Supports Simultaneously**

This procedure is appropriate for analyzing cloned DNAs and the genomes of simple organisms, but it is not sensitive enough to be used when analyzing complex mammalian genomes.

from a single gel to two nitrocellulose or nylon membranes (please see Figure 6-3). The only source of transfer buffer is the liquid trapped in the gel itself, and thus the efficiency of transfer is relatively poor. This method is not recommended when high sensitivity is required (e.g., detection of single-copy sequences in mammalian DNA), but it is perfectly adequate for Southern analysis of plasmids, bacteriophages, or cosmids or the genomes of simple organisms (e.g., *S. cerevisiae* and *Drosophila*) by Southern hybridization. Too little mammalian genomic DNA is transferred by this method to allow signal detection routinely.

### Electrophoretic Transfer

This method is not practical when nitrocellulose is used as the solid support because of the high ionic strengths of the buffers that are required to bind nucleic acids to nitrocellulose. These buffers conduct electric current very efficiently, and it is necessary to use large volumes to ensure that the buffering power of the system does not become depleted by electrolysis. In addition, extensive external cooling is required to overcome the effects of ohmic heating.

Electrophoretic transfer has undergone a recent resurgence with the advent of charged nylon membranes and has become the method of choice for analysis of small fragments of DNA separated by electrophoresis through polyacrylamide gels (Stellwag and Dahlberg 1980; Church and Gilbert 1984). Nucleic acids as small as 50 bp will bind to charged nylon membranes in buffers of very low ionic strength (Reed and Mann 1985).

Although single-stranded DNA and RNA can be transferred directly, fragments of double-stranded DNA must first be denatured in situ as described in Protocol 8. The gel is then neutralized and soaked in electrophoresis buffer (e.g., 1x TBE; see Appendix 1) before being mounted between porous pads aligned between parallel electrodes in a large tank of buffer. The time required for complete transfer depends on the size of the fragments of DNA, the porosity of the gel, and the strength of the applied field. However, because even high-molecular-weight nucleic acids migrate relatively rapidly from the gel, depurination/hydrolysis is unnecessary and transfer is generally complete within 2–3 hours. Because electrophoretic transfer requires comparatively large electric currents, it is often difficult to maintain the electrophoresis buffer at a temperature compatible with efficient transfer of DNA. Many commercially available electrophoretic transfer machines are equipped with cooling devices, but others are effective only when used in a cold room.

## Vacuum Transfer

DNA and RNA can be transferred rapidly and quantitatively from gels under vacuum. Several vacuum transfer devices are now commercially available in which the gel is placed in contact with a nitrocellulose or nylon membrane supported on a porous screen over a vacuum chamber. Buffer, drawn from an upper reservoir, elutes nucleic acids from the gel and deposits them on the membrane.

Vacuum transfer is more efficient than capillary transfer and is extremely rapid. DNAs that have been partially depurinated and denatured with alkali are quantitatively transferred within 30 minutes from gels of normal thickness (4–5 mm) and normal agarose concentration (<1%). If carried out carefully, vacuum transfer can result in a two- to threefold enhancement of the hybridization signal obtained from Southern transfers (Medveczky et al. 1987; Olszewska and Jones 1988).

All of the commercially available apparatuses work well as long as care is taken to ensure that the vacuum is applied evenly over the entire surface of the gel. Special care should be taken with the wells of horizontal agarose gels, which tend to break during preparation of the gel for transfer. If this occurs, the wells should be trimmed from the gel before transfer. (The wells need not be trimmed from the gel as long as they are unbroken.) It is also important not to apply too much vacuum during transfer. When the vacuum exceeds 60 cm of water, the gels become compressed and the efficiency of transfer is reduced.

## MEMBRANES USED FOR SOUTHERN AND NORTHERN HYBRIDIZATION

For almost 20 years, the only available support for immobilization of DNA was nitrocellulose, which was first used in powder form (Hall and Spiegelman 1961) and later as sheets (Nygaard and Hall 1960; Gillespie and Spiegelman 1965; Southern 1975). Northern hybridization was initially carried out exclusively with RNA immobilized on activated cellulose papers (Alwine et al. 1977; Seed 1982a,b). However, it was soon realized that RNA denatured by glyoxal, formaldehyde, or methylmercuric hydroxide binds tightly to nitrocellulose. For several years, nitrocellulose therefore became the support of choice for both northern and Southern hybridization. Despite its evident success, nitrocellulose is not an ideal matrix for solid-phase hybridization.

- ***Its capacity to bind nucleic acids is low*** (~50–100 µg/cm<sup>2</sup>) and varies according to the size of the DNA and RNA. In particular, nucleic acids <400 bases in length are retained inefficiently by nitrocellulose.
- ***DNA and RNA are attached to nitrocellulose by hydrophobic interactions***, rather than covalent interactions, and therefore leach slowly from the matrix during hybridization and washing at high temperatures (Haas et al. 1972).
- ***Nitrocellulose membranes become brittle during baking under vacuum at 80°C***, which is usually an integral part of the process to immobilize nucleic acids. The friable membranes cannot subsequently survive more than one or two cycles of hybridization and washing at high temperatures. This problem can be alleviated but not completely solved by using supported membranes made from mixed ester nitrocellulose, which have a higher tensile strength.
- ***Care is required in storing nitrocellulose membranes*** if they are to be used successfully for nucleic acid hybridization and western blotting. When the humidity is high, the membrane will adsorb moisture from the air and expand, resulting in curling and wrinkling. When the humidity is low, nitrocellulose membranes will dry and become charged with static electricity. In this state, the membrane is prone to cracking and splitting and becomes very difficult to wet.



In most areas throughout the world, it is necessary to alter the conditions under which nitrocellulose is stored to suit seasonal changes in weather conditions. During the hot humid summers of New York, for example, nitrocellulose should be stored in a closed container over a dehydrating agent. In winter, the dehydrating agent is replaced by damp pads of paper. The aim is to have wrinkle-free membranes that wet evenly and quickly (30 seconds or less) and take on a bluish tinge when saturated with water.

The problems with nitrocellulose were solved by the introduction of various types of nylon membranes that bind nucleic acids irreversibly, are far more durable than nitrocellulose membranes (Reed and Mann 1985), and can be repaired if damaged (Pitas 1989). Immobilized nucleic acids can be hybridized sequentially to several different probes without damaging the membrane. Furthermore, because nucleic acids can be immobilized on nylon in buffers of low ionic strength, transfer of nucleic acids from gels to nylon can be carried out electrophoretically. This method can be useful when capillary or vacuum transfer of DNA is inefficient, for example, when fragments of DNA are transferred from polyacrylamide gels.

Two types of nylon membranes are available commercially: unmodified (or neutral) nylon and charge-modified nylon, which carries amine groups and is therefore also known as positively charged or (+) nylon. Both types of nylon can bind single- and double-stranded nucleic acids, and retention is quantitative in solvents as diverse as water, 0.25 N HCl, and 0.4 N NaOH. Charge-modified nylon has a greater capacity to bind nucleic acids (please see Table 6-2), but it has a tendency to give increased levels of background, which results, at least in part, from nonspecific binding of negatively charged phosphate groups in DNA and RNA to the positively charged groups on the surface of the polymer. However, this problem can usually be controlled by using increased quantities of blocking agents in the prehybridization and hybridization steps.

Many different types of nylon membranes are available that vary in the extent and type of charge, the method used to apply it, and the density of the nylon mesh. Each manufacturer provides specific instructions for the transfer of nucleic acids to their particular product. These instructions should be followed exactly since they presumably have been shown to yield the best results.

**TABLE 6-2 Properties of Membranes Used for Southern Blotting and Hybridization**

PROPERTY	TYPE OF MEMBRANE		
	NITROCELLULOSE	NEUTRAL NYLON	CHARGED NYLON
Capacity ( $\mu\text{g}$ nucleic acid/ $\text{cm}^2$ )	80–120	~100	400–500
Size of nucleic acid required for maximal binding	>400 bp	>50 bp	>50 bp
Transfer buffer	high ionic strength at neutral pH	low ionic strength over a wide range of pH	
Immobilization	baking at 80°C under vacuum for 2 hours	baking at 70°C for 1 hour; no vacuum required or mild alkali or UV irradiation at 254 nm; damp membranes are generally exposed to 1.6 kJ/m <sup>2</sup> ; dried membranes require 160 kJ/m <sup>2</sup>	
Commercial products		Hybond-N Gene-Screen	Hybond-N+ Zeta-Probe Nytran+ Gene-Screen Plus

Polyvinylidene difluoride (PVDF) membranes are not routinely used for northern or Southern transfers. However, PVDF membranes, by virtue of their higher mechanical strength and greater capacity to bind proteins, are preferred to nitrocellulose for western blotting. Nylon membranes should not be used for western blotting because the level of nonspecific absorption of immunological probes is unacceptably high.

# Protocol 8

---

## Southern Blotting: Capillary Transfer of DNA to Membranes

**T**HE PREPARATION OF GENOMIC DNA IS FIRST DIGESTED with one or more restriction enzymes and the resulting fragments are separated according to size by electrophoresis through a standard agarose gel. The DNA is then denatured in situ and transferred from the gel to a solid support (usually a nylon or nitrocellulose membrane). The relative positions of the DNA fragments are preserved during their transfer to the membrane. The DNA is then fixed to the membrane and prepared for hybridization as described in Protocol 10. An alternative method of simultaneous transfer is presented in Protocol 9. The procedure for upward transfer of DNA in Southern blotting is performed essentially as described for upward transfer of RNA in Chapter 7, Protocol 7.

### SETTING UP RESTRICTION DIGESTIONS OF DNA FOR SOUTHERN ANALYSIS

---

The following are the cardinal points to remember when setting up restriction digests of genomic DNA for standard Southern analysis.

- **The amount of DNA digested must be sufficient to generate a signal.** For Southern analysis of mammalian genomic DNA, ~10 µg of DNA must be loaded into each slot of the gel when probes of standard length (>500 bp) and high specific activity (>10<sup>9</sup> cpm/µg) are used to detect single-copy sequences. Proportionately lower amounts of DNA may be used when the preparation of DNA contains higher molar concentrations of the sequences of interest.
- **The restriction enzymes used are likely to be informative.** For example, there is little point in digesting DNA whose median size is 50 kb with a restriction enzyme that cleaves on average every 100 kb. As a general rule, the median size of the DNA before digestion should be at least three times greater than the median size of fragments generated during the digestion. The frequency of cleavage by different restriction enzymes of various species of genomic DNAs is discussed in Chapter 4, Protocol 1 (please see Table 4-3).
- **The amount of DNA loaded into each lane of the gel is known with accuracy.** This does not necessarily mean that restriction digests must contain equal amounts of DNA. Measuring small volumes of extremely viscous preparations of high-molecular-weight genomic DNA is very difficult, and inaccuracies lead to overloading or underloading of lanes in the gel. If it is essential to analyze the same amount of DNA from multiple samples (e.g., when comparing genomic DNAs isolated from normal individuals and those affected with a genetic disease, or when attempting to determine the copy number of a gene), then it is best to digest a sufficient-

cy of each of the DNAs without worrying too much about whether each digest contains the same amount of DNA. The exact concentration of DNA in each sample can be measured by fluorometry after digestion is complete before loading the agarose gel. A method for fluorometric determination of DNA concentration is given at the end of Protocol 1.

In many cases, the volumes of restriction digests are defined by the concentration of DNA in the preparations under analysis. The concentrations of DNA in preparations of high-molecular-weight mammalian genomic DNA are often so low that it is necessary to carry out restriction digests in large volumes. There is no reason why restriction digests of a comparative series of genomic DNAs need be carried out in equal volumes. As long as all digests are complete, the volume of each restriction digest is immaterial. After digestion, the fragments of DNA may be concentrated by precipitation with ethanol, measured by fluorometry, and then applied to the gel in a small volume of gel-loading buffer (see Step 2).

- **The digests are complete.** The chief problem encountered during digestion of high-molecular-weight DNA is unevenness of digestion caused by variations in the local concentrations of DNA. Clumps of DNA are relatively inaccessible to restriction enzymes and can be digested only from the exterior of the aggregate. To ensure homogeneous dispersion of the DNA:
  1. If possible, set up the reactions in a total volume of at least 45  $\mu\text{l}$ . Before adding the restriction enzyme, store reactions at 4°C for several hours after dilution of the DNA and addition of 10x restriction enzyme buffer.
  2. Gently stir the DNA solution from time to time using a sealed glass capillary.
  3. After addition of the restriction enzyme (5 units/ $\mu\text{g}$  of DNA), gently stir the solution for 2–3 minutes at 4°C before warming the reaction to the appropriate temperature.
  4. After digestion for 15–30 minutes, add a second aliquot of restriction enzyme (5 units/ $\mu\text{g}$  of DNA) and stir the reaction as described above.
  5. Incubate the reaction at the appropriate temperature for 8–12 hours.

It is important to include controls to show whether digestion with the restriction enzyme(s) is complete and whether transfer and hybridization of the DNA have worked efficiently. This goal can be accomplished by setting up a series of digests containing high-molecular-weight genomic DNA and a very small amount of a plasmid carrying a sequence complementary to the probe (e.g., 10  $\mu\text{g}$  of mammalian DNA and  $10^{-5}$ ,  $10^{-6}$ , and  $10^{-7}$   $\mu\text{g}$  of plasmid). During digestion, the plasmid will be cleaved into a series of bands that may be invisible when the gel is examined by staining with ethidium bromide or SYBR Gold. However, fragments of the correct size should be detected by subsequent hybridization to the probe. To reduce the chance of accidental contamination and to minimize the possibility that the hybridization signal from the controls will obscure that from the test samples, the controls should be loaded into wells that lie toward one side of the gel, well away from the test samples of mammalian DNA.

## MATERIALS

**CAUTION:** Please see Appendix 12 for appropriate handling of materials marked with <!>.

### Buffers and Solutions

Please see Appendix 1 for components of stock solutions, buffers, and reagents. Dilute stock solutions to the appropriate concentrations.

*Alkaline transfer buffer (for alkaline transfer to nylon membranes)*

0.4 N NaOH <!>

1 M NaCl

*Denaturation solution (for neutral transfer)*

1.5 M NaCl  
0.5 M NaOH <!>

*HCl (0.2 N), for depurination of DNA <!>*

Optional, please see note to Step 6.

*Neutralization buffer I (for transfer to uncharged membranes)*

1 M Tris (pH 7.4)  
1.5 M NaCl

*Neutralization buffer II (for alkaline transfer to nylon membranes)*

0.5 M Tris-Cl (pH 7.2)  
1 M NaCl

*Neutral transfer buffer, either 10x SSC or 10x SSPE*

6x SSC

6x Sucrose gel-loading buffer

SYBR Gold <!> or Ethidium bromide <!>

TE (pH 8.0)

**Enzymes and Buffers**

*Appropriate restriction enzymes*

**Gels***Agarose gel (0.7%) cast in 0.5x TBE or 1x TAE in the absence of ethidium bromide*

For analysis of mammalian genomic DNA, most investigators use large gels (20 x 20 x 0.5 cm) containing 20 standard slots large enough to hold ~50–60  $\mu$ l. This capacity allows the entire digestion reaction to be loaded without spillage. The gel may be cast and run in the usual way in buffers containing 0.5  $\mu$ g/ml ethidium bromide. However, a more accurate measurement of the size of DNA fragments may be obtained by staining the gel after electrophoresis with ethidium bromide or SYBR Gold. The inclusion of SYBR Gold in the gel matrix may cause distortion of the DNA bands and may retard the migration of the DNA fragments to varying degrees. Please see Chapter 5, Protocol 2 and Appendix 9.

**Nucleic Acids and Oligonucleotides***DNA size markers*

Sets of size markers are available from many commercial manufacturers, or they can be prepared by digesting cloning vectors with appropriate restriction enzymes. We recommend using a 1-kb ladder (Life Technologies) in the lane closest to one side of the gel and a *Hind*III digest of bacteriophage  $\lambda$  DNA in the lane on the opposite side of the gel.

Markers radiolabeled with  $^{35}$ S or  $^{33}$ P are not recommended because they usually require exposure times different from those optimal for the target bands.

*Genomic DNA***Special Equipment**

*Cross-linking device (e.g., Stratalinker, Stratagene; GS Gene Linker, Bio-Rad), or Microwave oven, or Vacuum oven*

*Glass baking dishes*

*Glass rod*

*Large-bore yellow tips*

Large-bore yellow tips can be purchased or generated rapidly with a scissors or a dog nail clipper (Fisher 05-401A). Alternatively, the pointed ends of the tips can be removed with a sharp razor blade. The cut-off tips should be sterilized before use, either by autoclaving or by immersion in 70% alcohol for 2 minutes followed by -drying in air.

*Neoprene stoppers*

*Nylon or nitrocellulose membrane*

Please see discussion on Membranes Used for Southern and Northern Hybridization in the introduction to Protocols 8–10.

*Plexiglas sheets or Glass plates**Rotary platform shaker**Thick blotting paper (e.g., Whatman 3MM, Schleicher & Schuell GB004, or Sigma QuickDraw)**Transparent ruler with fluorescent markings*

The ruler is used to measure the distance traveled by the marker DNAs. A ruler placed alongside the gel during photography allows the distances traveled from the loading wells by DNA markers of known size to be measured on the photographic image and plotted graphically. The sizes of radiolabeled bands detected by hybridization can then be estimated by interpolation.

*Weight (400 g)*

## METHOD

---

### Digestion and Electrophoresis of the DNA

1. Digest an appropriate amount of genomic DNA with one or more restriction enzymes (please see the discussion on Setting up Restriction Digestions of DNA for Southern Analysis in the introduction to this protocol).

Use large-bore yellow pipette tips to handle high-molecular-weight DNA.

2. If necessary, concentrate the DNA fragments at the end of the digestion by ethanol precipitation. Dissolve the DNAs in ~25  $\mu$ l of TE (pH 8.0).

Make sure that the ethanol is removed from the DNA solution before it is loaded on the gel. If significant quantities of ethanol remain, the DNA "crawls" out of the slot of the gel. Heating the solution of dissolved DNA to 70°C in an open tube for 10 minutes is usually sufficient to drive off most of the ethanol. This treatment also disrupts base pairing between cohesive termini of restriction fragments.

3. Measure the concentrations of the digested DNAs by fluorometry or by the ethidium bromide or SYBR Gold spot test (please see Appendix 8). Transfer the appropriate amount of each digest to a fresh microfuge tube. Add 0.15 volume of 6x sucrose gel-loading buffer and separate the fragments of DNA by electrophoresis through an agarose gel (for most genomic DNAs, a 0.7% gel cast in 0.5x TBE or 1x TAE may be used; please see Chapter 5, Protocol 1). Maintain a low voltage through the gel (about <1 V/cm) to allow the DNA to migrate slowly.

If the digested DNAs have been stored at 4°C, they should be heated to 56°C for 2–3 minutes before they are applied to the gel. This heating disrupts any base pairing that may have occurred between protruding cohesive termini.

Occasionally, problems arise during loading of the gel because the DNA solution will not sink to the bottom of the well. This floating occurs when very high-molecular-weight DNA is present at the end of the digest, for example, when the digest is incomplete or when mammalian DNA has been digested with enzymes such as *NotI* that generate very large fragments of DNA. To minimize the problem, make sure that the DNA is homogeneously dispersed, and load the samples very slowly into the wells of the gel. After loading, allow the gel to stand for a few minutes so that the DNA can diffuse evenly throughout the wells.

4. After electrophoresis is complete, stain the gel with ethidium bromide or SYBR Gold and photograph the gel as described in Chapter 5, Protocol 2. Place a transparent ruler alongside

the gel so that the distance that any band of DNA has migrated can be read directly from the photographic image.

If desired, the gel may be stored at this stage before the DNA is denatured and transferred to the membrane. Wrap the gel in Saran Wrap and store it on a flat surface at 4°C. Because the bands of DNA diffuse during storage, the gel should not be put aside for more than 1 day before being processed.

5. Denature the DNA and transfer it from the agarose gel to a nitrocellulose or a neutral or charged-nylon membrane using one of the methods described below.

### Preparation of the Gel for Transfer

6. After fractionating the DNA by gel electrophoresis, transfer the gel to a glass baking dish. Use a razor blade to trim away unused areas of the gel, including the section of gel above the wells. Be sure to leave enough of the wells attached to the gel so that the positions of the lanes can be marked on the membrane after transfer of DNA. Cut off a small triangular piece from the bottom left-hand corner of the gel to simplify orientation during the succeeding operations.

It is best to cut off the lanes containing the molecular-weight markers because probes may contain sequences complementary to some of the marker bands. The resulting pattern of bands appearing on the autoradiogram is sometimes informative, but it is more often puzzling.

If the fragments of interest are larger than ~15 kb, then transfer may be improved by nicking the DNA by brief depurination before denaturation (Wahl et al. 1979). Depurination lays the phosphate-sugar backbone of DNA open to subsequent cleavage by hydroxyl ions. After Step 6, soak the gel in several volumes of 0.2 N HCl until the bromophenol blue turns yellow and the xylene cyanol turns yellow/green. Immediately place the 0.2 N HCl in a hazardous-waste container and then rinse the gel several times with deionized H<sub>2</sub>O.

Because depurination depends on diffusion of H<sup>+</sup> ions into the gel, the DNA molecules at different levels within the agarose are depurinated at different rates and to different extents. The reaction is therefore difficult both to control and to reproduce and, if carried out too enthusiastically, can result in excessive fragmentation of DNA and a reduction in the strength of the hybridization signal. Therefore, depurination is best avoided when the size of the target fragments is <20 kb. However, for Southern analysis of higher-molecular-weight DNA separated by conventional or pulsed-field electrophoresis, depurination/nicking is advisable, if not essential.

7. Denature the DNA by soaking in a denaturing (alkaline) solution as follows:

#### FOR TRANSFER TO UNCHARGED MEMBRANES

- a. Soak the gel for 45 minutes at room temperature in 10 gel volumes of denaturation solution with constant *gentle* agitation (e.g., on a rotary platform).
- b. Rinse the gel briefly in deionized H<sub>2</sub>O, and then neutralize it by soaking for 30 minutes at room temperature in 10 gel volumes of Neutralization buffer I with constant gentle agitation. Change the neutralization buffer and continue soaking the gel for a further 15 minutes.

#### FOR TRANSFER TO CHARGED NYLON MEMBRANES

- a. Soak the gel for 15 minutes at room temperature in several volumes of alkaline transfer buffer with constant *gentle* agitation (e.g., on a rotary platform).
- b. Change the solution and continue to soak the gel for a further 20 minutes with gentle agitation.

If the gel floats to the surface of the liquid, weigh it down with several Pasteur pipettes.

## Preparation of the Membrane for Transfer

- Use a fresh scalpel or a paper cutter to cut a piece of nylon or nitrocellulose membrane ~1 mm larger than the gel in each dimension. Also cut two sheets of thick blotting paper to the same size as the membrane.

▲ **IMPORTANT** Use appropriate gloves and blunt-ended forceps (e.g., Millipore forceps) to handle the membrane. A membrane that has been touched by oily hands will not wet!

- Float the membrane on the surface of a dish of deionized H<sub>2</sub>O until it wets completely from beneath, and then immerse the membrane in the appropriate transfer buffer for at least 5 minutes. Use a clean scalpel blade to cut a corner from the membrane to match the corner cut from the gel.

The rate at which different batches of nitrocellulose membranes wet varies enormously. If the membrane is not saturated after floating for several minutes on H<sub>2</sub>O, it should be replaced with a new membrane, since the transfer of DNA to an unevenly wetted membrane is unreliable. The original membrane should be either discarded or autoclaved for 5 minutes between pieces of 3MM paper that are saturated with 2x SSC. This treatment usually results in complete wetting. The autoclaved membrane, sandwiched between the autoclaved 3MM papers saturated with 2x SSC, may be stored at 4°C in a sealed plastic bag until needed.

Uneven wetting is not usually a problem with neutral or charged-nylon membranes.

## Assembly of the Transfer Apparatus and Transfer of the DNA

Neutral transfer buffer (10x SSC or 10x SSPE) is used to transfer DNA to uncharged membranes. Alkaline transfer buffer (0.4 N NaOH with 1 M NaCl) is used to transfer DNA to charged nylon membranes.

- While the DNA is denaturing, place a piece of thick blotting paper on a sheet of Plexiglas or a glass plate to form a support that is longer and wider than the gel. The ends of the blotting paper should drape over the edges of the plate. Place the support inside a large baking dish. The support can be placed on top of four neoprene stoppers to elevate it from the bottom of the dish. (For an example of a capillary blot, please see Figure 6-1.)
- Fill the dish with the appropriate transfer buffer until the level of the liquid reaches almost to the top of the support. When the blotting paper on the top of the support is thoroughly wet, smooth out all air bubbles with a glass rod or pipette.
- Remove the gel from the solution in Step 7 and invert it so that its underside is now uppermost. Place the inverted gel on the support so that it is centered on the wet blotting paper.
 

Make sure that there are no air bubbles between the blotting paper and the gel.
- Surround, but do not cover, the gel with Saran Wrap or Parafilm.
 

This protective mask serves as a barrier to prevent liquid from flowing directly from the reservoir to paper towels placed on top of the gel. If these towels are not precisely stacked, they tend to droop over the edge of the gel and may touch the wick. This type of short-circuiting is a major cause of inefficient transfer of DNA from the gel to the membrane.
- Wet the top of the gel with the appropriate transfer buffer. Place the wet membrane on top of the gel so that the cut corners are aligned. To avoid bubbles, touch one corner of the membrane to the gel and gently lower the membrane onto the gel. One edge of the membrane should extend just over the edge of the line of slots at the top of the gel.
 

▲ **IMPORTANT** Do not move the membrane once it has been applied to the surface of the gel. Make sure that there are no air bubbles between the membrane and the gel.

15. Wet the two pieces of thick blotting paper in the appropriate transfer buffer and place them on top of the wet membrane. Roll a pipette across the surface of the membrane to smooth away any air bubbles.

16. Cut or fold a stack of paper towels (5–8 cm high) just smaller than the blotting papers. Place the towels on the blotting papers. Put a glass plate on top of the stack and weigh it down with a 400-g weight.

The objective is to set up a flow of liquid from the reservoir through the gel and the membrane so that fragments of denatured DNA are eluted from the gel and are deposited on the membrane. The weight on the top of the gel should be heavy enough to ensure good contact between the various components of the blot, but light enough to prevent compressing the gel. Compression will squeeze liquid from the interstices of the gel, leaving a dehydrated matrix that greatly retards the movement of DNA and drastically reduces the efficiency of transfer from the gel to the membrane.

Intact, rather than cut or folded, paper towels can also be used in this setup, but only if the protective mask of Saran Wrap or Parafilm efficiently prevents seepage of buffer.

To prevent evaporation, some investigators wrap the entire transfer setup in Saran Wrap. Whether this is necessary seems somewhat doubtful.

17. Allow the transfer of DNA to proceed for 8–24 hours. Replace the paper towels as they become wet. Try to prevent the entire stack of towels from becoming wet with buffer.

18. Remove the paper towels and the blotting papers above the gel. Turn the gel and the attached membrane over and lay them, gel side up, on a dry sheet of blotting paper. Mark the positions of the gel slots on the membrane with a very soft lead pencil or a ballpoint pen.

19. Peel the gel from the membrane and discard the gel.

Instead of discarding the gel, it can be stained (45 minutes) in a 0.5 µg/ml solution of ethidium bromide in H<sub>2</sub>O and visualized on a UV transilluminator to gauge the success of the DNA transfer. Note that the intensity of fluorescence will be quite low because any DNA remaining in the gel will have been denatured.

### Fixation of the DNA to the Membrane

The sequence of steps from immobilization of DNA to the membrane to subsequent hybridization depends on the type of membrane, the method of transfer, and the method of fixation (please see Table 6-3). Because alkaline transfer results in covalent attachment of DNA to positively charged nylon membranes, there is no need to fix the DNA to the membrane before hybridization. DNA transferred to uncharged nylon membranes in neutral transfer buffer should be fixed to the membrane by baking under vacuum or heating in a microwave oven, or cross-linked to the membrane by UV irradiation.

**TABLE 6-3 Fixing DNA to the Membrane for Hybridization**

TYPE OF MEMBRANE	TYPE OF TRANSFER	METHOD OF FIXATION	SEQUENCE OF STEPS
Positively charged nylon	alkaline transfer	alkaline transfer	1. Soak membrane in Neutralization buffer II. 2. Proceed to prehybridization.
Uncharged nylon or positively charged nylon	neutral transfer	UV irradiation (please see Step 21 for details)	1. Soak membrane in 6x SSC. 2. Fix the DNA by UV irradiation. 3. Proceed to prehybridization.
Uncharged nylon or positively charged nylon	neutral transfer	baking in vacuum oven or microwave oven (please see Step 21 for details)	1. Soak membrane in 6x SSC. 2. Bake the membrane. 3. Proceed to prehybridization.



20. Soak the membrane in *one* of the following solutions as appropriate:

*For neutral transfer:* 6x SSC for 5 minutes at room temperature.

*For alkaline transfer:* Neutralization buffer II (0.5 M Tris-Cl [pH 7.2] with 1 M NaCl) for 15 minutes at room temperature.

This rinse removes any pieces of agarose sticking to the membrane and, in the latter case, also neutralizes the membrane.

21. Immobilize the DNA that has been transferred to uncharged membranes.

Because alkaline transfer results in covalent attachment of DNA to positively charged nylon membranes, there is no need for additional steps to fix the DNA to the membrane.

#### TO FIX BY BAKING IN A VACUUM OVEN

- a. Remove the membrane from the 6x SSC and allow excess fluid to drain away. Place the membrane flat on a paper towel to dry for at least 30 minutes at room temperature.
- b. Sandwich the membrane between two sheets of dry blotting paper. Bake for 30 minutes to 2 hours at 80°C in a vacuum oven.

Overbaking can cause nitrocellulose membranes to become brittle. If the gel was not completely neutralized before the DNA was transferred, nitrocellulose membranes will turn yellow or brown during baking and chip very easily. The background of nonspecific hybridization also increases dramatically.

#### TO FIX BY BAKING IN A MICROWAVE OVEN

- a. Place the damp membrane on a dry piece of blotting paper.
- b. Heat the membrane for 2–3 minutes at full power in a microwave oven (750–900 W).

Proceed directly to hybridization (Protocol 10) or dry the membrane and store it between sheets of blotting paper until it is needed.

Baking nitrocellulose membranes in a microwave oven attenuates the signal in Southern hybridizations and is not recommended (Angeletti et al. 1995).

#### TO CROSS-LINK BY UV IRRADIATION

- a. Place the damp membrane on a dry piece of blotting paper.
- b. Irradiate at 254 nm to cross-link the DNA to the membrane (Khandjian 1987).

Immobilization of nucleic acids by UV irradiation can greatly enhance the hybridization signal obtained with some brands of *positively charged* nylon membranes (Khandjian 1987). However, for maximum effect, it is important to make sure that the membrane is not overirradiated. The aim is to form cross-links between a small fraction of the thymine residues in the DNA and positively charged amine groups on the surface of the membrane (Church and Gilbert 1984). Overirradiation results in the covalent attachment of a high proportion of the thymines, with consequent decrease in hybridization signal. Make sure that the side of the membrane carrying the DNA faces the UV light source. Most manufacturers advise that damp membranes be exposed to a total of 1.5 J/cm<sup>2</sup> and that dry membranes be exposed to 0.15 J/cm<sup>2</sup>. However, we recommend carrying out a series of preliminary experiments to determine empirically the amount of irradiation required to produce the maximum hybridization signal.

22. Proceed directly to hybridization of immobilized DNA to a probe (Protocol 10).

Any membranes not used immediately in hybridization reactions should be thoroughly dried, wrapped loosely in aluminum foil or blotting paper, and stored at room temperature, preferably under vacuum.

# Protocol 9

---

## Southern Blotting: Simultaneous Transfer of DNA from a Single Agarose Gel to Two Membranes

**D**NA CAN BE SIMULTANEOUSLY TRANSFERRED FROM OPPOSITE SIDES of a single agarose gel to two membranes (please see Figure 6-3). This procedure is useful when the need arises to analyze the same set of restriction fragments with two different probes. Transfer of DNA fragments is rapid, but the efficiency is low because the agarose gel quickly becomes dehydrated as fluid is withdrawn from both sides. The method therefore works best when the target sequences are present in high concentration, for example, when analyzing cloned DNAs (plasmids, bacteriophages, cosmids, PACs, or BACs) or less complex genomes (e.g., those of *S. cerevisiae* or *Drosophila*). Too little mammalian genomic DNA is transferred to allow signals from single-copy sequences to be detected in a reproducible or timely fashion.

### MATERIALS

---

**CAUTION:** Please see Appendix 12 for appropriate handling of materials marked with <!.>.

#### Buffers and Solutions

Please see Appendix 1 for components of stock solutions, buffers, and reagents. Dilute stock solutions to the appropriate concentrations.

*Denaturation solution*

1.5 M NaCl  
0.5 N NaOH <!.>

*HCl (0.2 N), for depurination of DNA <!.>*

Optional, please see note to Step 6, Protocol 8.

*Neutralization buffer*

1 M Tris (pH 7.4)  
1.5 M NaCl

*Neutral transfer buffer (10x SSC)*

6x SSC

*6x Sucrose gel-loading buffer*

SYBR Gold <!.> or Ethidium bromide <!.>

#### Enzymes and Buffers

*Appropriate restriction enzymes*

## Gels

### *Agarose gel (0.7%) cast in 0.5x TBE or 1x TAE in the absence of ethidium bromide*

The gel may be cast and run in the usual way in buffers containing 0.5 µg/ml ethidium bromide. However, a more accurate measurement of the size of DNA fragments may be obtained by staining the gel after electrophoresis with ethidium bromide or SYBR Gold. The inclusion of SYBR Gold in the gel matrix may cause distortion of the DNA bands and may retard the migration of the DNA fragments to varying degrees. Please see Appendix 8.

## Nucleic Acids and Oligonucleotides

### *DNA size markers*

Sets of size markers are available from many commercial manufacturers, or they can be prepared by digesting cloning vectors with appropriate restriction enzymes. We recommend using a 1-kb ladder (GIBCO-BRL) in the lane closest to one side of the gel and a *Hind*III digest of bacteriophage λ DNA in the lane on the opposite side of the gel.

Markers radiolabeled with <sup>35</sup>S or <sup>33</sup>P are not recommended because they usually require exposure times different from those optimal for the target bands.

### *Target DNA*

## Special Equipment

*Cross-linking device (e.g., Stratalinker, Stratagene; GS Gene Linker, Bio-Rad), or Microwave oven, or Vacuum oven*

*Glass baking dishes*

*Glass plate*

*Nylon or nitrocellulose membranes*

Please see discussion on Membranes Used in Southern and Northern Hybridization in the Introduction to Protocols 8–10.

*Rotary platform shaker*

*Thick blotting paper (e.g., Whatman 3MM, Schleicher & Schuell GB004, or Sigma QuickDraw)*

*Transparent ruler with fluorescent markings*

The ruler is used to measure the distance traveled by the marker DNAs. A ruler placed alongside the gel during photography allows the distances traveled from the loading wells by DNA markers of known size to be measured on the photographic image and plotted graphically. The sizes of radiolabeled bands detected by hybridization can then be estimated by interpolation.

*Weight (400 g)*

## METHOD

---

1. Digest the DNA and fractionate it by gel electrophoresis according to Steps 1–3 of Protocol 8.
2. After fractionating the DNA by gel electrophoresis, stain the gel with ethidium bromide or SYBR Gold and photograph as described in Chapter 5, Protocol 2. Place a transparent ruler alongside the gel so that the distance that any band has migrated can be read directly from the photographic image. Prepare the gel for transfer under neutral conditions (Protocol 8, Steps 6–7).
3. Use a fresh scalpel or a paper cutter to cut two pieces of nylon or nitrocellulose membrane ~1–2 mm larger than the gel in each dimension. Cut a corner from the membranes to match the corner cut from the gel. Also cut four sheets of thick blotting paper to the same size as the membranes.

▲ **IMPORTANT** Use appropriate gloves and blunt-ended forceps (e.g., Millipore forceps) to handle the membranes. A membrane that has been touched by oily hands will not wet!

To retain small fragments of DNA (<300 nucleotides), use nitrocellulose membranes with a small pore size (0.2 µm) or nylon membranes.

4. Float the membranes on the surface of a dish of deionized H<sub>2</sub>O until they wet completely from beneath, and then immerse the membranes in 10x SSC for at least 5 minutes.

The rate at which different batches of nitrocellulose membranes wet varies enormously. If the membrane is not saturated after floating for several minutes on H<sub>2</sub>O, it should be replaced with a new membrane, since the transfer of DNA to an unevenly wetted membrane is unreliable. The original membrane should be either discarded or autoclaved for 5 minutes between pieces of 3MM paper saturated with 2x SSC. This treatment usually results in complete wetting of the membrane. The autoclaved membrane, sandwiched between the autoclaved 3MM papers saturated with 2x SSC, may be stored at 4°C in a sealed plastic bag until needed.

5. Roll a moistened pipette over each layer as it is assembled to ensure that no air bubbles are trapped, especially between the membranes and the gel sides. Place one of the membranes on two pieces of dampened blotting paper. Lay the gel on top of the membrane, aligning the cut corner of the gel with the cut corner of the membrane. Without delay, place the second membrane on the other side of the gel, followed by two sheets of dampened blotting paper (please see Figure 6-3).
6. Transfer the entire sandwich of blotting papers, membranes, and gel onto a 2–4-inch stack of paper towels. Cover the sandwich with a second stack of paper towels. Put a glass plate on top of the entire stack and weigh it down with a 400-g weight.
7. After 2–4 hours, remove the paper towels and blotting papers. Transfer the gel and membrane sandwich to a dry sheet of blotting paper, and mark the approximate positions of the gel slots with a very soft lead pencil or a ballpoint pen.
8. Immobilize the DNA onto the membranes by completing Steps 19–21 of Protocol 8.
9. Proceed directly to hybridization of immobilized DNA to a probe (Protocol 10).

Any membranes not used immediately in hybridization reactions should be thoroughly dry, wrapped loosely in aluminum foil or blotting paper, and stored at room temperature, preferably under vacuum.

# Protocol 10

---

## Southern Hybridization of Radiolabeled Probes to Nucleic Acids Immobilized on Membranes

**T**HE STRENGTH OF THE HYBRIDIZATION SIGNAL OBTAINED IN SOUTHERN HYBRIDIZATION depends on a number of factors, including the proportion of immobilized DNA that is complementary to the probe, the size of the probe and its specific activity, and the amount of genomic DNA transferred to the membrane. Under the best conditions, the method is sufficiently sensitive to detect  $<0.1$  pg of DNA complementary to a probe that has been radiolabeled with  $^{32}\text{P}$  to high specific activity ( $>10^9$  cpm/ $\mu\text{g}$ ; please see Chapter 9). A sequence of 1000 bp that occurs only once in the mammalian genome (i.e., 1 part in 3 million) can be detected in an overnight exposure to conventional X-ray film (or 15–60 minutes on a phosphorimager) if 10  $\mu\text{g}$  of genomic DNA is transferred to the membrane and hybridized to a probe several hundred nucleotides in length. Because the strength of the signal is proportional to the specific activity of the probe and inversely proportional to its length, Southern hybridization reaches the limits of its sensitivity when very short probes are used. To obtain a signal from single-copy genomic sequences with, for example, oligonucleotide probes, it is necessary to radiolabel to the highest specific activity possible (please see Chapter 10, Protocol 2 or 7), to increase the amount of target DNA on the membrane, and to expose the autoradiograph for several days, or the phosphorimager plate for many hours. For the detection of related but not identical sequences, please see the panel on **ADDITIONAL PROTOCOL: HYBRIDIZATION AT LOW STRINGENCY** at the end of this protocol.

Several methods are now available for nonradioactive labeling of DNA and RNA (for reviews, please see Guesdon 1992; Viale and Dell'Orto 1992; Mansfield et al. 1995; see also Chapter 9). Although these methods offer advantages such as long storage times and reduced exposure to radiation, they cannot yet be recommended for detection of single-copy sequences by Southern hybridization. The background is often high and, in many systems that utilize nonradioactive probes, the signal is not proportional to the amount of nucleic acid bound to the membrane. Worst of all, the detection of single-copy sequences in Southern analysis of mammalian DNAs lies at or just beyond the limit of sensitivity of most nonradioactive probes. Although nonradioactive labeling has improved dramatically during the past few years, it still has some way to go before it can be recommended for general use.

**HYBRIDIZATION CHAMBERS**

The first Southern hybridizations in the United States were carried out in a homemade hybridization device consisting of a rotating wheel housed within a 65°C oven that was kept under the back stairs in a lab at Cold Spring Harbor Laboratory. The precious nitrocellulose sheets were rolled up and inserted, together with the hybridization solution, into glass tubes that were sealed with a silicon rubber bung held in place with electrical tape. The tubes were then clamped to the wheel and left to rotate for 18 hours. The ancient, asbestos-lined oven door was always opened with trepidation since experience had shown that at least one of the tubes would break and that the bungs would pop from others. Of course, the oven and the wheel became encrusted with dried hybridization fluid and contaminated beyond redemption. Not surprisingly, successful experiments were few in number.

It was a great relief when Sears' Seal-A-Meal bags appeared on the scene some months later. Almost immediately, leaks were a thing of the past and the awful levels of background hybridization endemic to tightly rolled membranes were reduced to manageable proportions. For the next 10 years, when the results of Southern hybridizations were published at an average rate of >10,000 per year, hybridization in bags was the method of choice. Given the early frightening experience with hybridization ovens, it is understandable that their reappearance during the 1980s was greeted with some incredulity and suspicion. However, the machines available today from commercial manufacturers are a far cry from the gimcrack arrangements of the early investigators. The tubes are virtually leakproof and can be fitted with mesh to hold the rolls of the membrane apart and reduce background. Commercial rotating wheels have one additional advantage over Seal-A-Meal bags: They are less prone to leak when using hybridization buffers with high concentrations of SDS. Because plastic bags containing such buffers are very difficult to seal, the risk of leaks and contamination with radioactivity is increased.

**MATERIALS**

**CAUTION:** Please see Appendix 12 for appropriate handling of materials marked with <!>.

**Buffers and Solutions**

Please see Appendix 1 for components of stock solutions, buffers, and reagents. Dilute stock solutions to the appropriate concentrations.

*Phosphate-SDS washing solution 1*

- 40 mM sodium phosphate buffer (pH 7.2)
- 1 mM EDTA (pH 8.0)
- 5% (w/v) SDS
- 0.5% (w/v) Fraction-V-grade bovine serum albumin

*Phosphate-SDS washing solution 2*

- 40 mM sodium phosphate buffer (pH 7.2)
- 1 mM EDTA (pH 8.0)
- 1% (w/v) SDS

*Prehybridization/hybridization solutions*

Prepare the prehybridization solution appropriate for the task at hand. Approximately 0.2 ml of prehybridization solution is required for each square centimeter of membrane. Smaller volumes (~0.1 ml/cm<sup>2</sup>) can be used when hybridizing in roller bottles. For advice on which solution to use, please see the introduction to Protocol 32 in Chapter 1.

Prehybridization/hybridization solution may be prepared with or without poly(A) RNA. When <sup>32</sup>P-labeled cDNA or RNA is used as a probe, poly(A) RNA may be included in prehybridization or hybridization solutions to prevent the probe from binding to thymidine-rich sequences commonly found in eukaryotic DNA. Poly(A) RNA should be added to aqueous and formamide hybridization buffers at a final concentration of 1 µg/ml.

*Solution for hybridization in aqueous buffer*

- 6x SSC (or 6x SSPE)
- 5x Denhardt's reagent
- 0.5% (w/v) SDS
- 1 µg/ml poly(A)
- 100 µg/ml salmon sperm DNA

6x SSPE contains EDTA, which is a better chelator of divalent metal ions (e.g.,  $Mg^{2+}$ ) than citrate, and in turn will more efficiently inhibit DNase activity that can decrease probe and target DNA concentrations. After thorough mixing, filter the solution through a 0.45- $\mu$ m disposable cellulose acetate membrane (Schleicher & Schuell Uniflow syringe membrane or equivalent).

*Solution for hybridization in formamide buffers*

6x SSC (or 6x SSPE)  
5x Denhardt's reagent  
0.5% (w/v) SDS  
1  $\mu$ g/ml poly(A)  
100  $\mu$ g/ml salmon sperm DNA  
50% (v/v) formamide <!>

After thorough mixing, filter the solution through a 0.45- $\mu$ m disposable cellulose acetate membrane (Schleicher & Schuell Uniflo syringe membrane or equivalent). To decrease background when hybridizing under conditions of reduced stringency (e.g., 20–30% formamide), it is important to use formamide that is as pure as possible. Please see the information panel on **FORMAMIDE AND ITS USES IN MOLECULAR CLONING**.

*Solution for hybridization in phosphate-SDS buffer*

0.5 M sodium phosphate (pH 7.2)  
1 mM EDTA (pH 8.0)  
7% (w/v) SDS  
1% (w/v) bovine serum albumin

Use an electrophoresis grade of bovine serum albumin. No blocking agents or hybridization rate enhancers are required with this particular prehybridization/hybridization solution.

*Sodium phosphate (1 M, pH 7.2)*

0.1x SSC  
0.1x SSC with 0.1% (w/v) SDS  
2x SSC with 0.1% (w/v) SDS  
2x SSC with 0.5% (w/v) SDS  
6x SSC or 6x SSPE

## Nucleic Acids and Oligonucleotides

*DNA immobilized on membrane*

*Poly(A) RNA (10 mg/ml) in sterile H<sub>2</sub>O*

Optional, for hybridization buffers. Prepare solution by dissolving poly(A) RNA in sterile H<sub>2</sub>O and store in 100- $\mu$ l aliquots.

*Probe DNA or RNA <!>*

For Southern analysis of mammalian genomic DNA, where each lane of the gel contains 10  $\mu$ g of DNA, use 10–20 ng/ml radiolabeled probe (sp. act.  $\geq 10^9$  cpm/ $\mu$ g). For Southern analysis of cloned DNA fragments, where each band of the restriction digest contains 10 ng of DNA or more, much less probe is required. When analyzing cloned DNA, hybridization is carried out for 6–8 hours using 1–2 ng/ml radiolabeled probe (sp. act.  $10^6$  to  $10^9$  cpm/ $\mu$ g). Labeling should be carried out according to the methods described in Chapter 9 or 10.

*Salmon sperm DNA (~10 mg/ml)*

Denatured fragmented salmon sperm DNA should be used at a concentration of 100  $\mu$ g/ml in prehybridization and hybridization solutions involving essentially any type of hybridization experiment. To prepare:

- i. Dissolve salmon sperm DNA (Sigma type III sodium salt) in H<sub>2</sub>O at a concentration of 10 mg/ml. If necessary, stir the solution on a magnetic stirrer for 2–4 hours at room temperature to help the DNA to dissolve.
- ii. Adjust the concentration of NaCl to 0.1 M, and extract the solution once with phenol and once with phenol:chloroform.
- iii. Recover the aqueous phase, and shear the DNA by passing it 12 times rapidly through a 17-gauge hypodermic needle.
- iv. Precipitate the DNA by adding 2 volumes of ice-cold ethanol, recover by centrifugation, and dissolve at a concentration of 10 mg/ml in H<sub>2</sub>O.

- v. Determine the  $A_{260}$  of the solution and calculate the approximate concentration of the DNA.
- vi. Boil the solution for 10 minutes and store at  $-20^{\circ}\text{C}$  in small aliquots. Just before use, heat the solution for 5 minutes in a boiling-water bath and chill quickly in ice water.

## Special Equipment

*Adhesive dots marked with radioactive ink <math>\langle ! \rangle</math> or Phosphorescent adhesive dots*  
*Hybridization container*  
*Incubator or commercial hybridization device preset to the appropriate temperature*  
*Incubator or shaking water bath preset to  $65^{\circ}\text{C}$  (for hybridization in phosphate-SDS buffer)*  
*Water bath, boiling*

## METHOD

---

1. Float the membrane containing the target DNA on the surface of a tray of 6x SSC (or 6x SSPE) until the membrane becomes thoroughly wetted from beneath. Submerge the membrane for 2 minutes.
2. Prehybridize the membrane by one of the following methods.

### FOR HYBRIDIZATION IN A HEAT-SEALABLE BAG

- a. Slip the wet membrane into a heat-sealable bag (e.g., Sears Scal-A-Meal or equivalent), and add 0.2 ml of prehybridization solution for each square centimeter of membrane. Squeeze as much air as possible from the bag.
- b. Seal the open end of the bag with a heat sealer and then make a second seal. Test the strength and integrity of the seal by gently squeezing the bag. Incubate the bag for 1–2 hours submerged in a water bath set to the appropriate temperature ( $68^{\circ}\text{C}$  for aqueous solvents;  $42^{\circ}\text{C}$  for solvents containing 50% formamide;  $65^{\circ}\text{C}$  for phosphate-SDS solvents).

### FOR HYBRIDIZATION IN A ROLLER BOTTLE

- a. Gently roll the wetted membrane into the shape of a cylinder and place it inside a hybridization roller bottle together with the plastic mesh provided by the manufacturer. Add 0.1 ml of prehybridization solution for each square centimeter of membrane. Close the bottle tightly.
- b. Place the hybridization tube inside a prewarmed hybridization oven at the appropriate temperature ( $68^{\circ}\text{C}$  for aqueous solvents;  $42^{\circ}\text{C}$  for solvents containing 50% formamide;  $65^{\circ}\text{C}$  for phosphate-SDS solvents).

### FOR HYBRIDIZATION IN A PLASTIC CONTAINER

- a. Place the wetted membrane in a plastic (e.g., Tupperware) container, and add 0.2 ml of prehybridization solution for each square centimeter of membrane.



- b. Seal the box with the lid and place the box on a rocking platform in an air incubator set at the appropriate temperature (68°C for aqueous solvents; 42°C for solvents containing 50% formamide; 65°C for phosphate-SDS solvents).
- 3. If the radiolabeled probe is double-stranded DNA, denature it by heating for 5 minutes at 100°C. Chill the probe rapidly in ice water.
  - Alternatively, denature DNA probes by adding 0.1 volume of 3 N NaOH. After 5 minutes at room temperature, chill the probe to 0°C in an ice-water bath, and add 0.05 volume of 1 M Tris-Cl (pH 7.2) and 0.1 volume of 3 N HCl. Store the probe in ice water until it is needed.
  - Single-stranded DNA and RNA probes need not be denatured.
- 4. To hybridize the probe to a blot containing genomic DNA, carry out one of the following methods.

#### FOR HYBRIDIZATION IN A HEAT-SEALABLE BAG

- a. Working quickly, remove the bag containing the membrane from the water bath. Open the bag by cutting off one corner with scissors and pour off the prehybridization solution.
- b. Add the denatured probe to an appropriate amount of fresh prehybridization solution and deliver the solution into the bag. Squeeze as much air as possible from the bag.
- c. Reseal the bag with the heat sealer; make sure that as few bubbles as possible are trapped in the bag. To avoid radioactive contamination of the water bath, seal the resealed bag inside a second, noncontaminated bag. Incubate the bag submerged in a water bath set at the appropriate temperature for the required period of hybridization.

#### FOR HYBRIDIZATION IN A ROLLER BOTTLE

- a. Pour off the prehybridization solution from the hybridization bottle and replace with fresh hybridization solution containing probe.
- b. Seal bottle and replace in hybridization oven. Incubate for the required period of hybridization.

#### FOR HYBRIDIZATION IN A PLASTIC CONTAINER

- a. Transfer the membrane from the container to a sealable bag or a hybridization bottle.
  - b. Immediately treat as described above.
5. After hybridization, wash the membrane.

#### FOR HYBRIDIZATION IN A HEAT-SEALABLE BAG

- a. Wearing gloves, remove the bag from the water bath, remove the outer bag, and immediately cut off one corner of the inner bag. Pour out the hybridization solution into a container suitable for disposal of radioactivity, and then cut the bag along the length of three sides.
- b. Remove the membrane and immediately submerge it in a tray containing several hundred milliliters of 2x SSC and 0.5% SDS (i.e., ~1 ml/cm<sup>2</sup> membrane) at room temperature. Agitate the tray gently on a slowly rotating platform.

### FOR HYBRIDIZATION IN A ROLLER BOTTLE

- a. Remove the membrane from the hybridization bottle, and briefly drain excess hybridization solution from the membrane by holding the corner of the membrane to the lip of the bottle or container.
- b. Place the membrane in a tray containing several hundred milliliters of 2x SSC and 0.5% SDS (i.e., ~1 ml/cm<sup>2</sup> membrane) at room temperature. Agitate the tray gently on a slowly rotating platform.

When hybridizing in phosphate-SDS solution, remove the membrane from the hybridization chamber as described in Step 5 and place it in several hundred milliliters (i.e., ~1 ml/cm<sup>2</sup> membrane) of Phosphate-SDS washing solution 1 at 65°C. Agitate the tray. Repeat this rinse once.

▲ **IMPORTANT** Do not allow the membrane to dry out at any stage during the washing procedure.

6. After 5 minutes, pour off the first rinse solution into a radioactivity disposal container and add several hundred milliliters of 2x SSC and 0.1% SDS to the tray. Incubate for 15 minutes at room temperature with occasional gentle agitation.

If hybridization was carried out in a phosphate-SDS buffer, rinse the membrane a total of eight times for 5 minutes each in several hundred milliliters of Phosphate-SDS washing solution 2 at 65°C. Skip to Step 9 after the eighth rinse.

7. Replace the rinse solution with several hundred milliliters of fresh 0.1x SSC with 0.1% SDS. Incubate the membrane for 30 minutes to 4 hours at 65°C with gentle agitation.

During the washing step, periodically monitor the amount of radioactivity on the membrane using a hand-held minimonitor. The parts of the membrane that do not contain DNA should not emit a detectable signal. Do not expect to pick up a signal on the minimonitor from membranes containing mammalian DNA that has been hybridized to single-copy probes.

8. Briefly wash the membrane with 0.1x SSC at room temperature.
9. Remove most of the liquid from the membrane by placing it on a pad of paper towels. Place the damp membrane on a sheet of Saran Wrap. Apply adhesive dot labels marked with radioactive ink (or phosphorescent dots) to several asymmetric locations on the Saran Wrap. These markers serve to align the autoradiograph with the membrane. Cover the labels with Scotch Tape. This prevents contamination of the film holder or intensifying screen with the radioactive ink.

Alternatively, dry the membrane in the air and glue it to a piece of 3MM paper using a water-soluble glue.

10. Cover the membrane with a sheet of Saran Wrap, and expose the membrane to X-ray film for 16–24 hours at –70°C with an intensifying screen to obtain an autoradiographic image (please see Appendix 9).

Alternatively, cover the hybridized and rinsed membrane with Saran Wrap, and expose it to a phosphorimager plate. An exposure time of 1–4 hours is usually long enough to detect single-copy gene sequences in a Southern blot of mammalian genomic DNA.

If the DNA on the membrane is to be hybridized with a different probe, please see the panel on **ADDITIONAL PROTOCOL: STRIPPING PROBES FROM MEMBRANES** at the end of this protocol.

### TROUBLESHOOTING

Several factors cause background in Southern hybridizations. Table 6-4 outlines the most common symptoms and prophylactic measures to reduce background.

**TABLE 6-4 Background and How to Avoid It**

SYMBOL	CAUSE	POTENTIAL SOLUTIONS
Blotchy background over the entire membrane.	Incomplete blocking during prehybridization.	Prehybridize for longer periods of time.
	Drying out of membrane during experiment.	Be vigilant in keeping membrane wet at all times.
	SDS precipitated from any of the solutions used in the experiment.	Make solutions at room temperature, prewarm to 37°C, and then add SDS. Do not allow SDS to precipitate at any time. Reheating a solution from which SDS has precipitated only occasionally yields a clean result.
	Use of 10% dextran sulfate in hybridization experiments.	Dextran sulfate enhances the rate of hybridization. Except in rare instances (in situ hybridizations or when using subtracted probes), dextran sulfate can be left out of most hybridization solutions. Use of large volumes of washing solutions are required to remove this viscous compound, which if left on the membrane after hybridization, traps probe and produces background.
	Paper towels became completely wet during capillary transfer (see Protocol 8).	Use a larger stack of towels or remove wet towels and replace with dry ones during transfer procedure.
	Use of charged nylon membranes and solutions containing low SDS. Use of impure (yellow) formamide. Use of improper blocking reagent.	Increase the concentration of SDS to 1% (w/v) at all steps. Switch to uncharged nylon membranes. Purify formamide on Dowex XG-8 before use (Appendix 8). Do not use BLOTTO for genomic Southern blots. Instead try 50 µg/ml heparin as blocking reagent (Singh and Jones 1984) or use Church buffer (Church and Gilbert 1984) as both prehybridization and hybridization solutions.
Haloed over the entire membrane.	Presence of bubbles in prehybridization/hybridization solutions, failure to agitate membrane.	Prewarm solutions before use. Agitate the membrane.
Background concentrated over the lanes containing nucleic acid.	Improperly denatured carrier DNA.	Reboil the salmon sperm DNA used in the prehybridization/hybridization solutions. Do not allow the heat-denatured DNA to reanneal.
	Use of probes containing poly(T) tracts in northern hybridizations.	Include poly(A) at 1 µg/ml in hybridization solutions.
	Use of RNA probes.	Drastically increase the stringency of hybridization by increasing the concentration of formamide in the hybridization buffer; use 1% SDS in the hybridization buffer, increase the washing temperatures, and decrease the ionic strength of washing buffers (e.g., 0.1x SSC).
Blotchy background appearing on some membranes but not others.	Too many membranes hybridized in the same vessel, not enough volume of prehybridization/hybridization solution.	Increase the volume of the hybridization and washing solutions and/or decrease number of membranes in a hybridization bag or container.
Intense black spots all over membrane.	Use of old radiolabel to prepare probe.	A peppered background due to <sup>32</sup> P present as inorganic phosphate or pyrophosphate sticking to the membrane is frequently encountered when using 5'-labeled probes. Do not use old radiolabel in which radiolysis has occurred. Purify the probe by spun-column chromatography, precipitation, or gel electrophoresis before use. Include 0.5% (w/v) sodium pyrophosphate in prehybridization/hybridization solutions.

**ADDITIONAL PROTOCOL: STRIPPING PROBES FROM MEMBRANES**

Although in many cases, it is possible to remove probes from membranes after an image has been recorded and to reprobe the membrane with different probes, the following are some of the problems associated with this procedure.

- **Irreversible binding of the probe to the membrane.** Probes become irreversibly bound when nitrocellulose membranes and nylon membranes are allowed to dry for extended periods of time. If a given membrane is to be hybridized with more than one probe, every effort should be made to ensure that the solid support remains wet at all stages during hybridization, washing, and exposure to X-ray film or phosphor-imager cassettes.
- **Fragility of membranes.** Nylon membranes containing either genomic DNA or RNA can be stripped and rehybridized five to ten times. Nitrocellulose membranes, however, are more fragile and generally do not survive more than two or three cycles of hybridization and stripping.
- **Leaching of nucleic acids from the membranes.** A fraction of the DNA or RNA immobilized on the membrane leaches away during each cycle of hybridization and stripping so that the strength of the signal decreases progressively with each use. Nitrocellulose membranes are the worst offenders in this respect.

**Method**

**Removal of a Hybridized Probe from a Nitrocellulose Membrane**

1. Prepare elution buffer by heating several hundred milliliters of 0.05x SSC, 0.01 M EDTA (pH 8.0) to boiling. Remove the fluid from the heat and add SDS to a final concentration of 0.1% (w/v).
2. Immerse the membrane in the hot elution buffer for 15 minutes. Rock or rotate the container during this time period.
3. Repeat Step 2 with a fresh batch of boiling elution buffer.
  - ▲ **IMPORTANT** Do not allow the membrane to dry when transferring it between batches of hot elution buffer.
4. Rinse the membrane briefly in 0.01x SSC at room temperature. Blot most of the liquid from the membrane by placing it on a pad of paper towels, sandwich the damp membrane between two sheets of Saran Wrap, and apply it to X-ray film to check that all of the probe has been removed.
5. Dry the membrane, wrap loosely in aluminum foil or between sheets of blotting paper, and store at room temperature — preferably under vacuum — until needed. To rehybridize the membrane, place it in prehybridization solution and continue with Step 2 of Protocol 10.

**Removal of a Hybridized Probe from a Charged or Neutral Nylon Membrane**

Most manufacturers of nylon membranes provide instructions describing how various types of probes may best be stripped from their particular type of membrane. It is advisable to follow these instructions. Alternatively, treat the hybridized membrane with one of the three stripping solutions described in the table below.

1. Prepare several hundred milliliters of one of the recipes for stripping solution given in the table below, immerse the membrane, and treat as described to remove the probe and to wash the membrane.

Stripping solution	Treatment	Washing solution
1 M Tris-Cl (pH 8.0), 1 mM EDTA (pH 8.0), 0.1x Denhardt's reagent	2 hours at 75°C	0.1x SSPE at room temperature
50% formamide <math>\langle ! \rangle</math>, 2x SSPE	1 hour at 65°C	0.1x SSPE at room temperature
0.4 M NaOH <math>\langle ! \rangle</math>	30 minutes at 42°C	0.1x SSC, 0.1% SDS, 0.2 M Tris-Cl (pH 7.6) for 30 minutes at 42°C

2. Blot most of the liquid from the membrane by placing it on a pad of paper towels, sandwich the damp membrane between two sheets of Saran Wrap, and apply it to X-ray film to ensure that all of the probe has been removed.
3. Dry the membrane, wrap loosely in aluminum foil or between sheets of blotting paper, and store at room temperature — preferably under vacuum — until needed. To rehybridize the membrane, place it in prehybridization solution and continue with Step 2 of Protocol 10.

**ADDITIONAL PROTOCOL: HYBRIDIZATION AT LOW STRINGENCY**

The detection of genes that are related but not identical in sequence to a particular probe can sometimes be accomplished by hybridizing under conditions of reduced stringency. Success depends chiefly on (1) the degree of sequence identity between the hybridization probe and the target and (2) the judicious choice of hybridization conditions. Members of a gene family from a single species or orthologous genes from different species can almost always be isolated by low-stringency hybridization if they share 65% or greater sequence identity. The identification of genes that share <65% identity requires skill in the art and sometimes luck. Genes in the latter category are more frequently isolated by low-stringency PCR (see Chapter 8). The following hybridization/washing conditions can be used to identify genes that share  $\geq 65\%$  sequence identity.

- **For Southern hybridization or screening of bacteriophage plaques and bacterial colonies:** Set up hybridization reactions in a buffer containing 30% (v/v) deionized formamide, 0.6 M NaCl, 0.04 M sodium phosphate (pH 7.4), 2.5 mM EDTA (pH 8.0), 1% SDS, and radiolabeled denatured probe ( $1 \times 10^6$  to  $2 \times 10^6$  cpm/ml of hybridization solution). Hybridize for 16 hours at 42°C.
- **For northern hybridizations:** Hybridize in 50% deionized formamide, 0.25 M NaCl, 0.10 M sodium phosphate (pH 7.2), 2.5 mM EDTA (pH 8.0), 7% SDS, and radiolabeled denatured probe ( $1 \times 10^6$  to  $2 \times 10^6$  cpm/ml of hybridization solution). Hybridize for 16 hours at 42°C.

At the end of the hybridization reaction, wash the membranes twice with 2x SSC/0.1% SDS for 10 minutes each at room temperature, followed by a wash for 1 hour at 55°C in 2x SSC/0.1% SDS. Use large volumes of rinse and wash solutions; make sure that they are at the appropriate temperature before use. The identification of genes that share <65% sequence is trickier but may be accomplished by using one or more of the following approaches.

- **Use an RNA probe prepared by in vitro transcription** (please see Chapter 9, Protocol 6). The increased stability of RNA-DNA hybrids over DNA-DNA hybrids (Casey and Davidson 1977; Zuker et al. 1985) can sometimes make the difference between seeing a signal and not seeing a signal. However, RNA probes may generate high backgrounds that are difficult to remove with low-stringency washes. The use of noncharged nylon membranes may alleviate this problem.
- **Use a single-stranded DNA probe prepared from a bacteriophage M13 template** as described in Chapter 9, Protocol 4 or 5. Single-stranded DNA probes generate fewer background problems than RNA probes.
- **Decrease the formamide concentration** to 20% and hybridize at 34°C. Rinse and wash the hybridized membranes as described above.
- **Include "crowding agents" in the hybridization reaction.** When included at appropriate concentrations, these agents can stabilize nucleic acids against thermal denaturation and accelerate the renaturation of DNA (for review, please see Zimmerman and Minton 1993). For a description of the effect of crowding agents on denaturation of nucleic acids, please see Wieder and Wetmur (1981) and Sikorav and Church (1991). If using DNA probes, add 10% dextran sulfate or 5% polyethylene glycol (PEG 8000) to the hybridization solutions. These polymers accelerate the rate of hybridization about tenfold (Wahl et al. 1979; Renz and Kurz 1984; Amasino 1986; Kroczeck 1993). Dextran sulfate or PEG 8000 can sometimes lead to high background, and hybridization solutions containing them are always difficult to handle because of their viscosity. Use large volumes of rinse and wash solutions to overcome these problems.
- **Use a commercial "rapid hybridization" solution** (please see the information panels on **RAPID HYBRIDIZATION BUFFERS** and **CTAB**) and wash the membranes according to the manufacturer's instructions.

## FORMAMIDE AND ITS USES IN MOLECULAR CLONING

Formamide is used as an ionizing solvent in aqueous buffers. Many batches of high-grade formamide are sufficiently pure to be used without further treatment. However, as a rule of thumb, if any yellow color is present or if there is even the hint of a smell of ammonia, the formamide should be purified. A more rigorous test of purity is to measure conductivity, which rises as the formamide breaks down to ammonium formate. The conductivity of pure formamide is 1.7 (Casey and Davidson 1977) and the conductivity of a  $10^{-3}$  M solution of ammonium formate is  $\sim 650 \mu\text{mho}$ . The conductivity of formamide used in reannealing experiments should be  $< 2.0 \mu\text{mho}$ .

Formamide can be deionized by stirring for 1 hour on a magnetic stirrer with a mixed bed ion-exchange resin (e.g., Dowex AG8, Bio-Rad AG 501-X8, 20–50 mesh or X8[D]). The solution is then filtered through Whatman #1 paper and stored in small aliquots at  $-20^\circ\text{C}$ , preferably under nitrogen. Each resin can be reused several times. X8(D) contains an indicator that changes color when the resin is exhausted.

Formamide is used in hybridization reactions, to resolve complex compressions in sequencing gels, and to denature DNA before electrophoresis as described below.

### Resolving Compressions in Sequencing Gels

Including 25–50% (v/v) formamide in polyacrylamide sequencing gels destabilizes secondary structures in DNA and resolves some types of compression caused by anomalous migration of DNA bands (Brown 1984; Martin 1987). Gels containing formamide run slower and cooler than conventional polyacrylamide gels at the same voltage. It is usually necessary to increase the voltage by  $\sim 10\%$  to maintain temperature. Gels containing formamide give fuzzier bands.

In addition to DNA sequencing, formamide is routinely included in gels used to analyze polymorphic (CA) repeats in mammalian DNAs. In the presence of formamide, the smear of bands that is generated during polymerase chain reaction (PCR) amplification of alleles is resolved into a discrete family whose members differ in size by 2 bp (Litt et al. 1993).

### Denaturing RNA before Electrophoresis

Formamide (50%) is used to assist in denaturation of RNA before electrophoresis through denaturing formaldehyde-agarose gels (Lehrach et al. 1977).

### Hybridization Reactions

Bonner et al. (1967) were the first to use formamide as a solvent in hybridization reactions. At the end of their brief paper, they wrote:

That formamide should take the place of elevated temperature in the hybridization process is to be expected. Aqueous solutions of formamide denature DNA as has been shown by Helmkamp and Ts'o (1961) and Marmur and T'so (1961). The concentrations of formamide required for DNA-RNA hybridization, 30–40 vol%, are well below the 60 vol% found by Marmur and T'so to be required for denaturation of native DNA (in 0.02 M NaCl–0.002 M sodium citrate).

What has now been found by serendipity is that hybridization as conducted in aqueous formamide possesses distinct advantages over hybridization conducted at elevated temperatures. These advantages include increased retention of immobilized DNA by the nitrocellulose filters and decreased nonspecific background absorption. These two factors combine to result in an increased reproducibility of replicates with the hybridization procedure. Hybridization in formamide solution at low temperature is helpful also in minimizing scission of nucleic acid molecules during prolonged periods of incubation.

In addition to these advantages, increased flexibility is introduced into the design of reaction conditions for a given experiment. It is more convenient to control this stringency of hybridization with formamide rather than through adjustment of the incubation temperature.

**HYBRIDIZATION IN BUFFERS CONTAINING FORMAMIDE**

Depression of the melting temperature ( $T_m$ ) of duplex DNA is a linear function of the formamide concentration (McConaughy et al. 1969; Casey and Davidson 1977). For DNAs whose G+C content is in the range of 30–75%, the  $T_m$  is depressed by 0.63°C for each percentage of formamide in the hybridization mixture. Thus, the  $T_m$  of the hybrid formed between a probe and its target may be estimated from the following equation, which is modified from Bolton and McCarthy (1962):

$$T_m = 81.5^\circ\text{C} + 16.6 (\log_{10} [\text{Na}^+]) + 41 (\text{mole fraction } [\text{G}+\text{C}]) - 0.63 (\% \text{formamide}) - 500/n$$

where  $n$  is the length of the DNA in nucleotides. This equation applies to the reversible  $T_m$  defined by optical measurement of hyperchromicity at  $\text{OD}_{260}$ . The "irreversible"  $T_m$  (Hamaguchi and Geiduschek 1962), which is more important for autoradiographic detection of DNA hybrids, is usually 7–10°C higher than that predicted by the equation. Similar equations have been derived for RNA probes hybridizing to immobilized RNA (Bodkin and Knudson 1985):

$$T_m = 79.8^\circ\text{C} + 18.5 (\log_{10} [\text{Na}^+]) + 58.4 (\text{mole fraction } [\text{G}+\text{C}]) + 11.8 (\text{mole fraction } [\text{G}+\text{C}])^2 - 0.35 (\% \text{formamide}) - 820/n$$

and for DNA:RNA hybrids (Casey and Davidson 1977):

$$T_m = 79.8^\circ\text{C} + 18.5 (\log_{10} [\text{Na}^+]) + 58.4 (\text{mole fraction } [\text{G}+\text{C}]) + 11.8 (\text{mole fraction } [\text{G}+\text{C}])^2 - 0.50 (\% \text{formamide}) - 820/n$$

Comparison of these equations shows that the relative stability of nucleic acid hybrids in high concentrations of formamide decreases in the following order: RNA-RNA (most stable), RNA-DNA (less stable), and DNA-DNA (least stable). In 80% formamide, the  $T_m$  of an RNA-DNA hybrid is ~10°C higher than a DNA-DNA hybrid of equivalent base composition. It is therefore possible to find hybridization conditions that allow the formation of RNA-DNA hybrids and discourage the formation of DNA-DNA hybrids (Casey and Davidson 1977). This ability to suppress reannealing of DNA was extremely useful when S1 mapping of RNA was carried out with double-stranded DNA probes (Berk and Sharp 1977). However, the development of efficient methods to prepare single-stranded probes now allows annealing of RNA to DNA to be carried out under standard hybridization conditions without fear of competition from the complementary strand of DNA. As a consequence, the annealing conditions established by Casey and Davidson (1977) are today used only very rarely.

- The rate of DNA-DNA hybridization in 80% formamide is slower than in aqueous solution (Casey and Davidson 1977). Increasing the concentration of formamide decreases the rate of DNA:DNA renaturation by 1.1% for every 1% increase in the concentration of formamide (Hutton 1977). Therefore, the optimal rate in 50% formamide is 0.45 times the optimal rate in aqueous solution (Hutton 1977). In 80% formamide, the rate of DNA-DNA hybridization is three- to fourfold slower than in aqueous solution (Casey and Davidson 1977). This effect is a consequence of increased viscosity of the hybridization solution at the temperatures used for renaturation.
- The breakdown of formamide that occurs during prolonged incubation at temperatures in excess of 37°C can cause the pH of the hybridization buffer to drift upward (Casey and Davidson 1977). When formamide is included in the hybridization buffer, 6x SSPE is preferred to 6x SSC because of its greater buffering power.

---

**SPOOLING DNA (HISTORICAL FOOTNOTE)**

---

Ethanol precipitation of biologically active nucleic acid predates molecular cloning by ~50 years. Lionel Alloway, who worked at the Rockefeller Institute in the early 1930s, used it as a method to concentrate "transforming factor." His project was to prepare active cell-free extracts of S-type *Streptococcus pneumoniae* that would genetically transform R-type organisms in vitro. At that time, transformation had been achieved only with intact, heat-killed donor cells. After many frustrating failures, Alloway (1932) reported that he could get the substance responsible for transformation into solution by heating a freeze-thaw extract of the S organisms to 60°C, removing particulate matter by centrifugation, and passing the solution through a filter made of porous porcelain.

Alloway's success at eliminating the need for heat-killed donor cells was a major step on the road that was eventually to lead to the discovery of DNA as the transforming material (Avery et al. 1944). However, not all of Alloway's cell-free preparations worked, and, even when transformation was obtained, the efficiency was very low. Alloway must have realized that these problems were caused in part by the dilute nature of the extract, for he began to search for different ways to lyse the pneumococci and for different methods to concentrate the transforming activity (Alloway 1933). Maclyn McCarty (1985) described Alloway's discovery of ethanol precipitation as follows:

Alloway then introduced another new procedure that became an indispensable part of all work on the transforming substance from that time forward. He added pure alcohol in a volume five times that of the extract which resulted in precipitation of most of the material that had been released from the pneumococci... The precipitated material could be redissolved in salt solution and shown to contain the active substance in transformation tests. Alcohol precipitation and resolution could be repeated at will without loss of activity.

Alloway describes the formation of "a thick stringy precipitate" that could be collected by stirring the ethanolic solution with a spatula. Although Alloway was the first person to use spooling to recover high-molecular-weight biologically active DNA, ethanol precipitation of shards of DNA had already been used by several generations of organic chemists who were puzzling over the structure of the bases in DNA. However, Alloway was the first to use ethanol precipitation to prepare material that could change the phenotype of recipient cells. Final proof that the transforming factor was DNA still lay a dozen or more years into the future. But Alloway could fairly claim to be the inventor of a technique that is now second nature to us all.

---

**RAPID HYBRIDIZATION BUFFERS**

---

Several cationic detergents dramatically enhance the rate of hybridization of two complementary strands of nucleic acid (Pontius and Berg 1991). These include dodecyltrimethylammonium bromide and cetyltrimethylammonium bromide (DTAB and CTAB), which are variants of the quaternary amine tetramethylammonium bromide. The latter compound is used to stabilize duplexes formed between oligonucleotide probes and target sequences (please see Chapter 10). At concentrations in the millimolar range, DTAB and CTAB enhance the rate of renaturation of two complementary strands of DNA >10,000-fold. The increase in hybridization rate is specific and occurs in the presence of as much as a 10<sup>6</sup>-fold excess of noncomplementary DNAs (please see the information panel on **CTAB**).

Several commercial manufacturers now sell rapid hybridization solutions that decrease the required hybridization time from 16 hours to 1–2 hours. Although the chemical composition of these premade solutions is a trade secret, it seems likely that some of them contain quaternary ammonium compounds, whereas others contain volume excluders such as 10% dextran sulfate (Wahl et al. 1979; Renz and Kurz 1984; Amasino 1986) or 5% PEG 35,000 (Kroczek 1993). Hybridization times can be reduced by a factor of five or more if these rapid hybridization solutions are used instead of conventional hybridization buffers. In addition, these hybridization accelerators improve the efficiency of hybridization when low concentrations



of probe are used (~1 ng/ml). The rapid hybridization solution should be preheated to the correct hybridization temperature before it is added to the membranes. Radiolabeled probes should be added to preheated rapid hybridization solution before adding it to the membrane.

In our experience, rapid hybridization buffers work extremely well for Southern hybridization. However, when hybridization accelerators are used in northern hybridization, the background of hybridization to ribosomal RNAs increases greatly — sometimes to levels that are unacceptable.

---

## CTAB

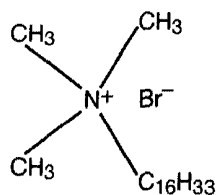
---

Cetyltrimethylammonium bromide (CTAB) is a cationic detergent that has the useful property of precipitating nucleic acids and acidic polysaccharides from solutions of low ionic strength. Under these conditions, proteins and neutral polysaccharides remain in solution. In solutions of high ionic strength, CTAB forms complexes with proteins and all but the most acidic polysaccharides, but will not precipitate nucleic acids (Jones and Walker 1963). CTAB is therefore particularly useful for purification of DNAs from organisms that produce large quantities of polysaccharides, e.g., plants (Murray and Thompson 1980) and certain Gram-negative bacteria (including some strains of *E. coli*). CTAB is used in two types of basic precipitation procedures:

- **For preparation of genomic DNAs.** The detergent is added to bacterial or cell lysates that have been adjusted to high ionic strength (>0.7 M NaCl). After removing the CTAB/polysaccharide/protein complexes by sequential extraction with chloroform and phenol, the genomic DNA is recovered from the supernatant by precipitation with isopropanol or ethanol (Jones and Walker 1963; Wilson 1987).
- **For preparation of phagemid, plasmid, and bacteriophage DNAs.** CTAB is added to lysates of low ionic strength. The precipitated DNAs are collected by centrifugation, dissolved in solutions of high ionic strength, and purified by ethanol precipitation (e.g., please see Manfioletti and Schneider 1988; Del Sal et al. 1989).

CTAB and other cationic detergents also have the remarkable property of enhancing the rate of renaturation of complementary DNA strands (Pontius and Berg 1991). At a concentration of 1 mM CTAB, renaturation rates can be as much as 10,000 times faster than those in water. This rate is ~2000 times faster than that obtained in a 1 M solution of NaCl (i.e., ~6x SSC). The annealing reaction in the presence of CTAB is second order with respect to DNA concentration, and the rates approach those with which two complementary strands collide in a solution. CTAB also stabilizes the double-stranded DNA helix once formed. Annealing reactions remain rapid in the presence of as much as a  $10^6$ -fold excess of noncomplementary DNAs. Although not widely publicized, it seems likely that CTAB or another cationic detergent is the active ingredient in the numerous “rapid hybridization” solutions that are commercially available.

- Most commercial preparations of CTAB are mixtures of trimethylammonium bromides with varying lengths of aliphatic tails (please see Figure 6-4). About 80% of a typical preparation consists of the cetyl form ( $M_r = 364.48$ ).
- Because CTAB precipitates in the cold, solutions containing the detergent should be stored at temperatures >15°C.
- CTAB is widely used as a topical antiseptic and is sold under the trade names of Savlon and Cetavlon.



**FIGURE 6-4** The Structure of CTAB

---

## REFERENCES

- Alloway J.L. 1932. The transformation *in vitro* of R pneumococci into S forms of different specific types by the use of filtered pneumococcus extracts. *J. Exp. Med.* **54**: 91–99.
- . 1933. Further observations on the use of pneumococcus extracts in effecting transformation of type *in vitro*. *J. Exp. Med.* **57**: 265–278.
- Alwine J.C., Kemp D.J., and Stark G.R. 1977. Method for detection of specific RNAs in agarose gels by transfer to diazobenzyloxymethyl-paper and hybridization with DNA probes. *Proc. Natl. Acad. Sci.* **74**: 5350–5354.
- Amasino R.M. 1986. Acceleration of nucleic acid hybridization rate by polyethylene glycol. *Anal. Biochem.* **152**: 304–307.
- Angeletti B., Battiloro E., Pascale E., and D'Ambrosio E. 1995. Southern and northern blot fixing by microwave oven. *Nucleic Acids Res.* **23**: 879–880.
- Avery O.T., McCleod C.M., and McCarty M. 1944. Studies on the chemical nature of the substance inducing transformation of pneumococcal types. Induction of transformation by a deoxyribonucleic acid fraction isolated from pneumococcus type III. *J. Exp. Med.* **79**: 137–158.
- Berk A.J. and Sharp P.A. 1977. Sizing and mapping of early adenovirus mRNAs by gel electrophoresis of S1 endonuclease-digested hybrids. *Cell* **12**: 721–732.
- Beutler E., Gelbart T., and Kuhl W. 1990. Interference of heparin with the polymerase chain reaction. *BioTechniques* **9**: 166.
- Blin N. and Stafford D.W. 1976. A general method for isolation of high molecular weight DNA from eukaryotes. *Nucleic Acids Res.* **3**: 2303–2308.
- Bodkin D.K. and Knudson D.L. 1985. Assessment of sequence relatedness of double-stranded RNA genes by RNA-RNA blot hybridization. *J. Virol. Methods* **10**: 45–52.
- Bolton E.T. and McCarthy B.J. 1962. A general method for the isolation of RNA complementary to DNA. *Proc. Natl. Acad. Sci.* **48**: 1390–1397.
- Bonner J., Kung G., and Bekhor I. 1967. A method for the hybridization of nucleic acid molecules at low temperature. *Biochemistry* **6**: 3650–3653.
- Botchan M., Topp W., and Sambrook J. 1976. The arrangement of simian virus 40 sequences in the DNA of transformed cells. *Cell* **9**: 269–287.
- Bowtell D.D. 1987. Rapid isolation of eukaryotic DNA. *Anal. Biochem.* **162**: 463–465.
- Brown N.L. 1984. DNA sequencing. *Methods Microbiol.* **17**: 259–313.
- Casey J. and Davidson N. 1977. Rates of formation and thermal stabilities of RNA:DNA and DNA:DNA duplexes at high concentrations of formamide. *Nucleic Acids Res.* **4**: 1539–1552.
- Chomczynski P. 1992. One-hour downward alkaline capillary transfer for blotting of DNA and RNA. *Anal. Biochem.* **201**: 134–139.
- Church G.M. and Gilbert W. 1984. Genomic sequencing. *Proc. Natl. Acad. Sci.* **81**: 1991–1995.
- Couse J.F., Davis V.L., Tally W.C., and Korach K.S. 1994. An improved method of genomic DNA extraction for screening transgenic mice. *BioTechniques* **17**: 1030–1032.
- Del Sal G., Manfioletti G., and Schneider C. 1989. The CTAB-DNA precipitation method: A common mini-scale preparation of template DNA from phagemids, phages or plasmids suitable for sequencing. *BioTechniques* **7**: 514–520.
- Feinberg A.P. and Vogelstein B. 1983. A technique for radiolabeling DNA restriction endonuclease fragments to high specific activity. *Anal. Biochem.* **132**: 6–13.
- . 1984. A technique for radiolabeling DNA restriction endonuclease fragments to high specific activity. Addendum. *Anal. Biochem.* **137**: 266–267.
- Gillespie D. and Spiegelman S. 1965. A quantitative assay for DNA-RNA hybrids with DNA immobilized on a membrane. *J. Mol. Biol.* **12**: 829–842.
- Glasel J.A. 1995. Validity of nucleic acid purities monitored by 260nm/280nm absorbance ratios (see comments). *BioTechniques* **18**: 62–63.
- Guesdon J.L. 1992. Immunoenzymatic techniques applied to the specific detection of nucleic acids. A review. *J. Immunol. Methods* **150**: 33–49.
- Gustafson S., Proper J.A., Bowie E.J., and Sommer S.S. 1987. Parameters affecting the yield of DNA from human blood. *Anal. Biochem.* **165**: 294–299.
- Haas M., Vogt M., and Dulbecco R. 1972. Loss of simian virus 40 DNA-RNA hybrids from nitrocellulose membranes: Implications for the study of virus-host DNA interactions. *Proc. Natl. Acad. Sci.* **69**: 2160–2164.
- Hall B.D. and Spiegelman S. 1961. Sequence complementarity of T2-DNA and T2-specific RNA. *Proc. Natl. Acad. Sci.* **47**: 137–163.
- Hamaguchi K. and Geiduschek E.P. 1962. The effect of electrolytes on the stability of the deoxynucleate helix. *J. Am. Chem. Soc.* **84**: 1329–1338.
- Helmkamp G. and Ts'o P.O.P. 1961. The secondary structures of nucleic acids in organic solvents. *J. Am. Chem. Soc.* **83**: 138–142.
- Hutton J.R. 1977. Renaturation kinetics and thermal stability of DNA in aqueous solutions of formamide and urea. *Nucleic Acids Res.* **4**: 3537–3555.
- Jones A.S. and Walker R.T. 1963. Isolation and analysis of the deoxyribonucleic acid of *Mycoplasma mycoides* var. *capri*. *Nature* **198**: 588–589.
- Khandjian E.W. 1987. Optimized hybridization of DNA blotted and fixed to nitrocellulose and nylon membranes. *Bio/Technology* **5**: 165–167.
- Koetsier P.A., Schorr J., and Doerfler W. 1993. A rapid optimized protocol for downward alkaline Southern blotting of DNA. *BioTechniques* **15**: 260–262.
- Köntgen F. and Stewart C.L. 1993. Simple screening procedure to detect gene targeting events in embryonic stem cells. *Methods Enzymol.* **225**: 878–890.
- Kroczyk R.A. 1993. Southern and northern analysis. *J. Chromatogr.* **618**: 133–145.
- Kupiec J.J., Giron M.L., Vilette D., Jeltsch J.M., and Emanoil-Ravier R. 1987. Isolation of high-molecular-weight DNA from eukaryotic cells by formamide treatment and dialysis. *Anal. Biochem.* **164**: 53–59.
- Laird P.W., Zijderveld A., Linders K., Rudnicki M.A., Jaenisch R., and Berns A. 1991. Simplified mammalian DNA isolation procedure. *Nucleic Acids Res.* **19**: 4293.
- Lehrach H., Diamond D., Wozney J.M., and Boedtker H. 1977. RNA molecular weight determinations by gel electrophoresis under denaturing conditions, a critical reexamination. *Biochemistry* **16**: 4743–4751.
- Lichtenstein A.V., Moiseev V.L., and Zaboikin M.M. 1990. A pro-

- cedure for DNA and RNA transfer to membrane filters avoiding weight-induced gel flattening. *Anal. Biochem.* **191**: 187–191.
- Litt M., Hauge X., and Sharma V. 1993. Shadow bands seen when typing polymorphic dinucleotide repeats: Some causes and cures. *BioTechniques* **15**: 280–284.
- Manfioletti G. and Schneider C. 1988. A new and fast method for preparing high quality lambda DNA suitable for sequencing. *Nucleic Acids Res.* **16**: 2873–2884.
- Mansfield E.S., Worley J.M., McKenzie S.E., Surrey S., Rappaport E., and Fortina P. 1995. Nucleic acid detection using non-radioactive labelling methods. *Mol. Cell. Probes* **9**: 145–156.
- Marmur J. and T'so P.O.P. 1961. Denaturation of deoxyribonucleic acid by formamide. *Biochim. Biophys. Acta* **51**: 32–36.
- Martin R. 1987. Overcoming DNA sequencing artifacts: Stops and compressions. *Focus (Life Technologies)* **9**: 8–10.
- McCarty M. 1985. *The transforming principle: Discovering that genes are made of DNA*, 1st edition. W.W. Norton, New York.
- McConaughy B.L., Laird C.D., and McCarthy B.J. 1969. Nucleic acid reassociation in formamide. *Biochemistry* **8**: 3289–3295.
- Medveczky P., Chang C.-W., Mulder C., and Oste C. 1987. Rapid vacuum driven transfer of DNA and RNA from gels to solid supports. *BioTechniques* **5**: 242–246.
- Meinkoth J. and Wahl G. 1984. Hybridization of nucleic acids immobilized on solid supports. *Anal. Biochem.* **138**: 267–284.
- Murray M.G. and Thompson W.F. 1980. Rapid isolation of high molecular weight plant DNA. *Nucleic Acids Res.* **8**: 4321–4325.
- Nygaard A.P. and Hall B.D. 1960. A method for the detection of DNA-RNA complexes. *Biochim. Biophys. Acta* **40**: 85–92.
- Olszewska E. and Jones K. 1988. Vacuum blotting enhances nucleic acid transfer. *Trends Genet.* **4**: 92–94.
- Palmiter R.D., Chen H.Y., Messing A., and Brinster R.L. 1985. SV40 enhancer and large-T antigen are instrumental in development of choroid plexus tumours in transgenic mice. *Nature* **316**: 457–460.
- Pitas J.W. 1989. A simple technique for repair of nylon blotting membranes. *BioTechniques* **7**: 1084.
- Pontius B.W. and Berg P. 1991. Rapid renaturation of complementary DNA strands mediated by cationic detergents: A role for high-probability binding domains in enhancing the kinetics of molecular assembly processes. *Proc. Natl. Acad. Sci.* **88**: 8237–8241.
- Ramirez-Solis R., Davis A.C., and Bradley A. 1993. Gene targeting in embryonic stem cells. *Methods Enzymol.* **225**: 855–878.
- Ramirez-Solis R., Rivera-Pérez J., Wallace J.D., Wims M., Zheng H., and Bradley A. 1992. Genomic DNA microextraction: A method to screen numerous samples. *Anal. Biochem.* **201**: 331–335.
- Reed K.C. and Mann D.A. 1985. Rapid transfer of DNA from agarose gels to nylon membranes. *Nucleic Acids Res.* **13**: 7207–7221.
- Renz M. and Kurz C. 1984. A colorimetric method for DNA hybridization. *Nucleic Acids Res.* **12**: 3435–3444.
- Seed B. 1982a. Attachment of nucleic acids to nitrocellulose and diazonium-substituted supports. *Genet. Eng.* **4**: 91–102.
- . 1982b. Diazotizable arylamine cellulose papers for the coupling and hybridization of nucleic acids. *Nucleic Acids Res.* **10**: 1799–1810.
- Sepp R., Szabó I., Uda H., and Sakamoto H. 1994. Rapid techniques for DNA extraction from routinely processed archival tissue for use in PCR. *J. Clin. Pathol.* **47**: 318–323.
- Sikorav J.L. and Church G.M. 1991. Complementary recognition in condensed DNA: Accelerated DNA renaturation. *J. Mol. Biol.* **222**: 1085–1088.
- Singh L. and Jones K.W. 1984. The use of heparin as a simple cost-effective means of controlling background in nucleic acid hybridization procedures. *Nucleic Acids Res.* **12**: 5627–5638.
- Southern E.M. 1975. Detection of specific sequences among DNA fragments separated by gel electrophoresis. *J. Mol. Biol.* **98**: 503–517.
- Stellweg E.J. and Dahlberg A.E. 1980. Electrophoretic transfer of DNA, RNA and protein onto diazobenzoyloxymethyl (DBM)-paper. *Nucleic Acids Res.* **8**: 299–317.
- Stulnig T.M. and Amberger A. 1994. Exposing contaminating phenol in nucleic acid preparations. *BioTechniques* **16**: 402–404.
- Thomas S.M., Moreno R.F., and Tilzer L.L. 1989. DNA extraction with organic solvents in gel barrier tubes. *Nucleic Acids Res.* **17**: 5411.
- Trnovsky J. 1992. Semi-dry electroblotting of DNA and RNA from agarose and polyacrylamide gels. *BioTechniques* **13**: 800–804.
- Udy G.B. and Evans M.J. 1994. Microplate DNA preparation, PCR screening and cell freezing for gene targeting in embryonic stem cells. *BioTechniques* **17**: 887–894.
- Viale G. and Dell'Orto P. 1992. Non-radioactive nucleic acid probes: Labelling and detection procedures. *Liver* **12**: 243–251.
- Wahl G.M., Stern M., and Stark G.R. 1979. Efficient transfer of large DNA fragments from agarose gels to diazobenzoyloxymethyl-paper and rapid hybridization by using dextran sulfate. *Proc. Natl. Acad. Sci.* **76**: 3683–3687.
- Wieder R. and Wetmur J.G. 1981. One hundred-fold acceleration of DNA renaturation rates in solution. *Biopolymers* **20**: 1537–1547.
- Wilson K. 1987. *Current protocols in molecular biology*. Wiley, New York.
- Zimmerman S.B. and Minton A.P. 1993. Macromolecular crowding: Biochemical, biophysical, and physiological consequences. *Annu. Rev. Biophys. Biomol. Struct.* **22**: 27–65.
- Zuker C.S., Cowman A.F., and Rubin G.M. 1985. Isolation and structure of a rhodopsin gene from *D. melanogaster*. *Cell* **40**: 851–858.

# Chapter 7

---

## Extraction, Purification, and Analysis of mRNA from Eukaryotic Cells

### INTRODUCTION

### PROTOCOLS

1	Purification of RNA from Cells and Tissues by Acid Phenol–Guanidinium Thiocyanate–Chloroform Extraction	7.4
2	A Single-step Method for the Simultaneous Preparation of DNA, RNA, and Protein from Cells and Tissues	7.9
3	Selection of Poly(A) <sup>+</sup> RNA by Oligo(dT)-Cellulose Chromatography	7.13
4	Selection of Poly(A) <sup>+</sup> RNA by Batch Chromatography	7.18
	Introduction to Northern Hybridization (Protocols 5–9)	7.21
5	Separation of RNA According to Size: Electrophoresis of Glyoxylated RNA through Agarose Gels	7.27
6	Separation of RNA According to Size: Electrophoresis of RNA through Agarose Gels Containing Formaldehyde	7.31
7	Transfer and Fixation of Denatured RNA to Membranes	7.35
	• Alternative Protocol: Capillary Transfer by Downward Flow	7.41
8	Northern Hybridization	7.42
9	Dot and Slot Hybridization of Purified RNA	7.46
10	Mapping RNA with Nuclease S1	7.51
11	Ribonuclease Protection: Mapping RNA with Ribonuclease and Radiolabeled RNA Probes	7.63
12	Analysis of RNA by Primer Extension	7.75

### INFORMATION PANELS

How to Win the Battle with RNase	7.82
Inhibitors of RNases	7.83
Diethylpyrocarbonate	7.84
Guanidinium Salts	7.85
Nuclease S1	7.86
Exonuclease VII	7.86
Mung Bean Nuclease	7.87
Promoter Sequences Recognized by Bacteriophage-encoded RNA Polymerases	7.87
Actinomycin D	7.88
	7.1

**A** TYPICAL MAMMALIAN CELL CONTAINS  $\sim 10^{-5}$   $\mu\text{g}$  OF RNA, 80–85% of which is ribosomal RNA (chiefly the 28S, 18S, 5.8S, and 5S species). Most of the remaining 15–20% consists of a variety of low-molecular-weight species (e.g., transfer RNAs and small nuclear RNAs). These abundant RNAs are of defined size and sequence and can be isolated in virtually pure form by gel electrophoresis, density gradient centrifugation, anion-exchange chromatography, or high-performance liquid chromatography (HPLC). By contrast, messenger RNA, which makes up between 1% and 5% of the total cellular RNA, is heterogeneous in both size — from a few hundred bases to many kilobases in length — and sequence. However, most eukaryotic mRNAs carry at their 3' termini a tract of polyadenylic acid residues that is generally long enough to allow mRNAs to be purified by affinity chromatography on oligo(dT)-cellulose. The resulting heterogeneous population of molecules collectively encodes virtually all of the polypeptides synthesized by the cell.

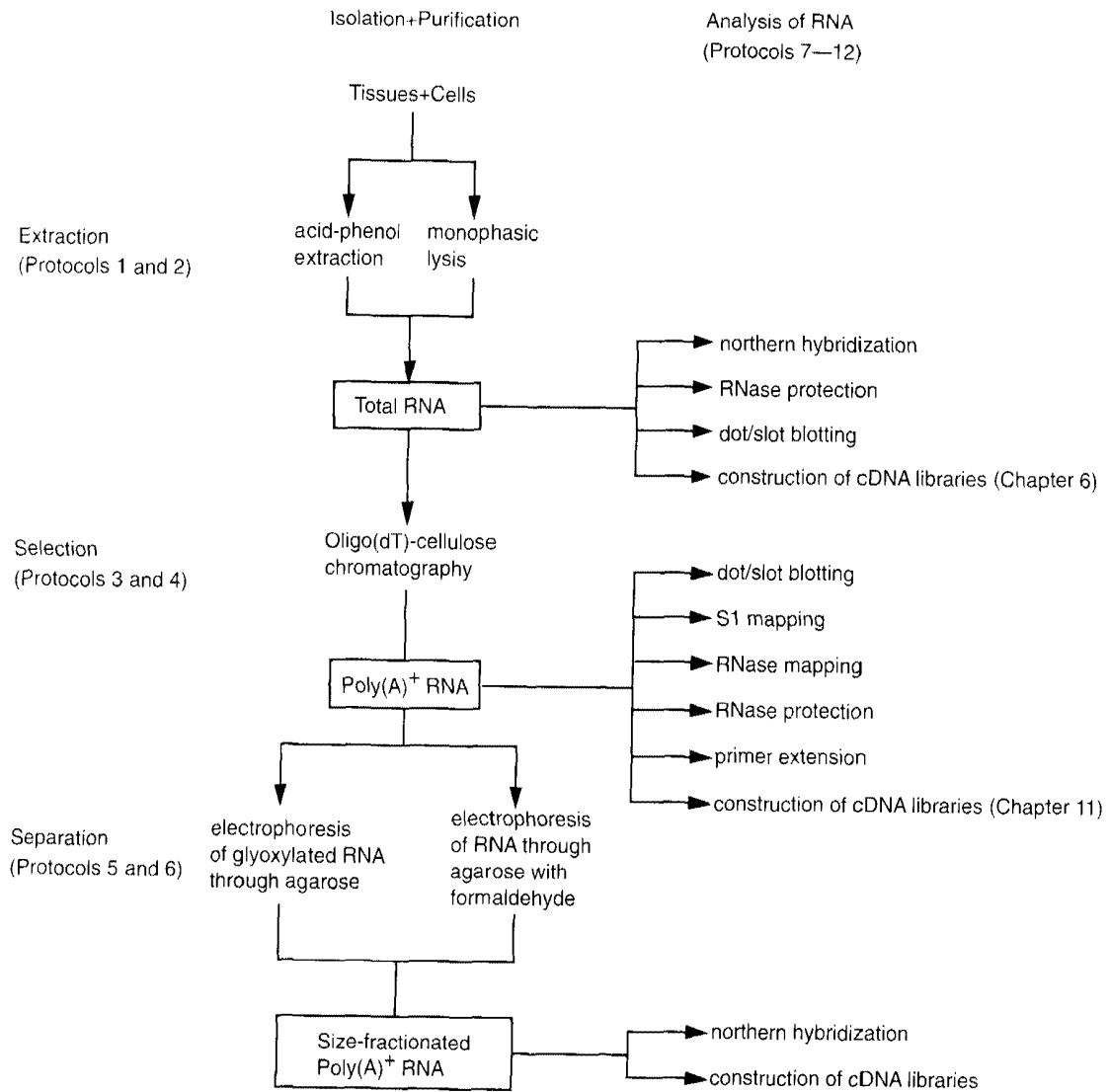
Because ribose residues carry hydroxyl groups in both the 2' and 3' positions, RNA is chemically much more reactive than DNA and is easy prey to cleavage by contaminating RNases — enzymes with various specificities that share the property of hydrolyzing diester bonds linking phosphate and ribose residues. Because RNases are released from cells upon lysis and are present on the skin, constant vigilance is required to prevent contamination of glassware and bench tops and the generation of RNase in aerosols. The problem is compounded since there is no simple method to inactivate RNases. Because of the presence of intrachain disulfide bonds, many RNases are resistant to prolonged boiling and mild denaturants and are able to refold quickly when denatured. Unlike many DNases, RNases do not require divalent cations for activity and thus cannot be easily inactivated by the inclusion of ethylenediaminetetraacetic acid (EDTA) or other metal ion chelators in buffer solutions. The best way to prevent problems with RNase is to avoid contamination in the first place (please see the information panels on **HOW TO WIN THE BATTLE WITH RNASE**, **INHIBITORS OF RNASES**, and **DIETHYLPYROCARBONATE** at the end of this chapter).

This chapter is divided into two parts (please see Figure 7-1). The first series of protocols (Protocols 1 through 6) is devoted to the isolation and purification of total RNA and, subsequently, of poly(A)<sup>+</sup> RNA.

The second series of protocols (Protocols 7 through 12) deals with various approaches for the analysis of purified RNA, in particular for assessing gene expression and/or gene structure. Hybridization by northern transfer (Protocols 7 and 8) or by dot/slot blotting (Protocol 9) may be used to determine the size and abundance of a particular species of RNA. Details of the fine structure of a particular transcript may be assessed by S1 mapping or ribonuclease protection (Protocols 10 and 11). The use of either of these techniques allows the detection of the 5' and 3' ends of a particular mRNA, as well as the splice junctions, precursors, and processing intermediates of mRNA. Primer extension (Protocol 12) provides a measure of the amount of a particular mRNA species and allows an exact determination of the 5' end of the mRNA.

*Work is of two kinds: first, altering the position of matter at or near the earth's surface relatively to other such matter; second, telling other people to do so. The first is unpleasant and ill paid; the second is pleasant and highly paid.*

Bertrand Russell



**FIGURE 7-1** Flowchart of Methods

# Protocol 1

---

## Purification of RNA from Cells and Tissues by Acid Phenol–Guanidinium Thiocyanate–Chloroform Extraction

**T**HE KEY TO SUCCESSFUL PURIFICATION OF INTACT RNA from cells and tissues is speed. Cellular RNases should be inactivated as quickly as possible at the very first stage in the extraction process. Once the endogenous RNases have been destroyed, the immediate threat to the integrity of the RNA is greatly reduced, and purification can proceed at a more graceful pace.

Because of the urgency, many methods for the isolation of intact RNA from cells use strong denaturants such as guanidinium hydrochloride or guanidinium thiocyanate to disrupt cells, solubilize their components, and denature endogenous RNases simultaneously (please see the information panel on **GUANIDINIUM SALTS**). The use of guanidinium isothiocyanate in RNA extraction, first mentioned briefly by Ullrich et al. (1977), was documented in papers published by Han et al. (1987) and Chirgwin et al. (1979). The Han method is laborious as it involves solubilization of RNA pellets in progressively smaller volumes of 5 M guanidine thiocyanate. In the Chirgwin method, cultured cells or tissues are homogenized in 4 M guanidinium isothiocyanate, and the lysate is layered onto a dense cushion of CsCl. Because the buoyant density of RNA in CsCl (1.8 g/ml) is much greater than that of other cellular components, rRNAs and mRNAs migrate to the bottom of the tube during ultracentrifugation (Glisin et al. 1974). As long as the step gradients are not overloaded, proteins remain in the guanidinium lysate while DNA floats on the CsCl cushion. Because the Chirgwin method yields RNA of very high quality and purity and is not labor-intensive, it became the standard technique during the early 1980s for isolation of undegraded high-molecular-weight RNA. However, the method has one weakness: It is unsuitable for simultaneous processing of many samples. For this purpose, it has been almost completely displaced by the single-step technique of Chomczynski and Sacchi (1987), in which the guanidinium thiocyanate homogenate is extracted with phenol:chloroform at reduced pH. Elimination of the ultracentrifugation step allows many samples to be processed simultaneously and speedily at modest cost and without sacrifice in yield or quality of RNA. For many investigators, the single-step technique described in Protocol 1 remains the method of choice to isolate RNA from cultured cells and most animal tissues.

There are two circumstances in which the single-step procedure is not recommended. First, the procedure does not extract RNA efficiently from adipose tissues that are rich in triglycerides. RNA is best prepared from these fatty sources by a modification of the method of Chirgwin et al. (1979), described by Tavangar et al. (1990). Second, RNA prepared by guanidine lysis is some-

times contaminated to a significant extent by cellular polysaccharides and proteoglycans. These contaminants are reported to prevent solubilization of RNA after precipitation with alcohols, to inhibit reverse-transcriptase-polymerase chain reactions (RT-PCRs), and to bind to membranes during RNA blotting (Groppe and Morse 1993; Re et al. 1995; Schick and Eras 1995). If contamination by proteoglycans and polysaccharides appears to be a problem, include an organic extraction step and change the conditions used to precipitate the RNA as described in Protocol 2.

The yield of total RNA depends on the tissue or cell source, but it is generally in the range of 4–7  $\mu\text{g}/\text{mg}$  of starting tissue or 5–10  $\mu\text{g}/10^6$  cells. The  $A_{260}/A_{280}$  ratio of the extracted RNA is generally 1.8–2.0.

## MATERIALS

▲ **IMPORTANT** Prepare all reagents used in this protocol with DEPC-treated  $\text{H}_2\text{O}$  (please see the information panel on **HOW TO WIN THE BATTLE WITH RNASE**).

**CAUTION:** Please see Appendix 12 for appropriate handling of materials marked with <!.>.

### Buffers and Solutions

Please see Appendix 1 for components of stock solutions, buffers, and reagents. Dilute stock solutions to the appropriate concentrations.

*Chloroform:isoamyl alcohol (49:1, v/v)* <!.>

*Ethanol*

*Isopropanol*

*Liquid nitrogen* <!.>

*Phenol* <!.>

*Phosphate-buffered saline (PBS)*

Required for cells grown in suspension and monolayers only.

*Sodium acetate (2 M, pH 4.0)*

*Solution D (denaturing solution)*

4 M guanidinium thiocyanate <!.>

25 mM sodium citrate  $\cdot 2\text{H}_2\text{O}$

0.5% (w/v) sodium lauryl sarcosinate

0.1 M  $\beta$ -mercaptoethanol <!.>

Dissolve 250 g of guanidinium thiocyanate in 293 ml of  $\text{H}_2\text{O}$ , 17.6 ml of 0.75 M sodium citrate (pH 7.0), and 26.4 ml of 10% (w/v) sodium lauryl sarcosinate. Add a magnetic bar and stir the solution on a combination heater-stirrer at 65°C until all ingredients are dissolved. Store Solution D at room temperature, and add 0.36 ml of 14.4 M stock  $\beta$ -mercaptoethanol per 50 ml of Solution D just before use. Solution D may be stored for months at room temperature but is sensitive to light. Note that guanidinium will precipitate at low temperatures.

Table 7-1 presents the amounts of Solution D required to extract RNA from various sources.

▲ **WARNING** Solution D is very caustic. Wear appropriate gloves, a laboratory coat, and eye protection when preparing, handling, or working with the solution.

**TABLE 7-1** Amounts of Solution D Required to Extract RNA from Cells and Tissues

AMOUNT OF TISSUE OR CELLS	AMOUNT OF SOLUTION D
100 mg of tissue	3 ml
T-75 flask of cells	3 ml
60-mm plate of cells	1 ml
90-mm plate of cells	2 ml

The amounts of Solution D recommended here are greater than those used by Chomczynski and Sacchi (1987). Our experience and that of other investigators (e.g., Zolfaghari et al. 1993; Sparmann et al. 1997) indicate that the technique is more reproducible and the yield of RNA is consistently higher when the amount of solution D is increased to the values shown in the Table.



*Stabilized formamide (Optional) <!>*

Stabilized formamide is used for the storage of RNA; please see the panel on **STORAGE OF RNA** following Step 11.

## Cells and Tissues

*Cells or tissue samples for RNA isolation*

## Centrifuges and Rotors

*Sorvall SS-34 rotor or equivalent*

*Sorvall H1000 rotor or equivalent*

## Special Equipment

*Cuvettes for measuring absorbance at 260 nm*

The cuvettes should be either disposable UV-transparent methylacrylate or quartz. Before and after use, soak quartz cuvettes in concentrated HCl:methanol (1:1, v/v) for at least 30 minutes and then wash them extensively in sterile H<sub>2</sub>O.

*Homogenizer (e.g., Tissumizer from Tekmar-Dohrmann or Polytron from Brinkmann)*

*Mortar and pestle washed in DEPC-treated H<sub>2</sub>O, prechilled*

Please see Chapter 6, Protocol 1.

*Polypropylene snap-cap tube (e.g., Falcon)*

*Water bath preset to 65°C*

Optional, please see Step 10.

## METHOD

---

1. Prepare cells or tissue samples for isolation of RNA as appropriate for the material under study.

### FOR TISSUES

When working with tissues such as pancreas or gut that are rich in degradative enzymes, it is best to cut the dissected tissue into small pieces (100 mg) and then drop the fragments immediately into liquid nitrogen. Fragments of snap-frozen tissue can be transferred to -70°C for storage or used immediately for extraction of RNA as described below. Tissues can be stored at -70°C for several months without affecting the yield or integrity of the RNA.

Snap-freezing and pulverization is not always necessary. Tissues that are not as rich in RNases may be rapidly minced into small pieces and transferred directly into polypropylene snap-cap tubes containing the appropriate amount of Solution D (Step c) below.

- a. Isolate the desired tissues by dissection and place them immediately in liquid nitrogen.
- b. Transfer ~100 mg of the frozen tissue to a mortar containing liquid nitrogen and pulverize the tissue using a pestle. The tissue can be kept frozen during pulverization by the addition of liquid nitrogen.
- c. Transfer the powdered tissue to a polypropylene snap-cap tube containing 3 ml of Solution D.
- d. Homogenize the tissue for 15–30 seconds at room temperature with a polytron homogenizer.

Instead of grinding in a mortar, frozen tissue may be placed inside a homemade bag of plastic film and pulverized with a blunt instrument (e.g., a hammer) (Gramza et al. 1995). Only certain types of plastic film are tough enough to withstand hammering at low temperature (e.g., Write-On Transparency Film from 3M).

**FOR MAMMALIAN CELLS GROWN IN SUSPENSION**

- a. Harvest the cells by centrifugation at 200–1900g (1000–3000 rpm in a Sorvall RT600 using the H1000 rotor) for 5–10 minutes at room temperature in a benchtop centrifuge.
- b. Remove the medium by aspiration and resuspend the cell pellets in 1–2 ml of sterile ice-cold PBS.
- c. Harvest the cells by centrifugation, remove the PBS completely by aspiration, and add 2 ml of Solution D per  $10^6$  cells.
- d. Homogenize the cells with a polytron homogenizer for 15–30 seconds at room temperature.

**FOR MAMMALIAN CELLS GROWN IN MONOLAYERS**

- a. Remove the medium and rinse the cells once with 5–10 ml of sterile ice-cold PBS.
  - b. Remove PBS and lyse the cells in 2 ml of Solution D per 90-mm culture dish (1 ml per 60 mm dish).
  - c. Transfer the cell lysates to a polypropylene snap-cap tube.
  - d. Homogenize the lysates with a polytron homogenizer for 15–30 seconds at room temperature.
2. Transfer the homogenate to a fresh polypropylene tube and sequentially add 0.1 ml of 2 M sodium acetate (pH 4.0), 1 ml of phenol, and 0.2 ml of chloroform-isoamyl alcohol per milliliter of Solution D. After addition of each reagent, cap the tube and mix the contents thoroughly by inversion.
  3. Vortex the homogenate vigorously for 10 seconds. Incubate the tube for 15 minutes on ice to permit complete dissociation of nucleoprotein complexes.
  4. Centrifuge the tube at 10,000g (9000 rpm in a Sorvall SS-34 rotor) for 20 minutes at 4°C, and then transfer the upper aqueous phase containing the extracted RNA to a fresh tube.  
To minimize contamination by DNA trapped at the interface, avoid taking the lowest part of the aqueous phase.
  5. Add an equal volume of isopropanol to the extracted RNA. Mix the solution well and allow the RNA to precipitate for 1 hour or more at –20°C.
  6. Collect the precipitated RNA by centrifugation at 10,000g (9000 rpm in a Sorvall SS-34 rotor) for 30 minutes at 4°C.
  7. Carefully decant the isopropanol and dissolve the RNA pellet in 0.3 ml of Solution D for every 1 ml of this solution used in Step 1.  
**▲ IMPORTANT** Pellets are easily lost. Decant the supernatant into a fresh tube. Do not discard it until the pellet has been checked.
  8. Transfer the solution to a microfuge tube, vortex it well, and precipitate the RNA with 1 volume of isopropanol for 1 hour or more at –20°C.  
If degradation of RNA turns out to be a problem (e.g., when isolating RNA from cells or tissues known to contain large amounts of RNase, such as macrophages, pancreas, and small intestine), repeat Steps 7 and 8 once more.

9. Collect the precipitated RNA by centrifugation at maximum speed for 10 minutes at 4°C in a microfuge. Wash the pellet twice with 75% ethanol, centrifuge again, and remove any remaining ethanol with a disposable pipette tip. Store the open tube on the bench for a few minutes to allow the ethanol to evaporate. Do not allow the pellet to dry completely.
10. Add 50–100 µl of DEPC-treated H<sub>2</sub>O. Store the RNA solution at –70°C.  
Addition of SDS to 0.5% followed by heating to 65°C may assist dissolution of the pellet.
11. Estimate the concentration of the RNA by measuring the absorbance at 260 nm of an aliquot of the final preparation, as described in Appendix 8.

Purified RNA is not immune to degradation by RNase after resuspension in the 0.5% SDS solution. Some investigators therefore prefer to dissolve the pellet of RNA in 50–100 µl of stabilized formamide and store the solution at –20°C (Chomczynski 1992). RNA can be recovered from formamide by precipitation with 4 volumes of ethanol. For further details, please see the panel on **STORAGE OF RNA**.

SDS should be removed by chloroform extraction and ethanol precipitation before enzymatic treatment of the RNA (e.g., primer extension, reverse transcription, and *in vitro* translation). The redissolved RNA can then be used for mRNA purification by oligo(dT)-cellulose chromatography (Protocol 3) or analyzed by standard techniques such as blot hybridization (Protocols 7 and 8) or mapping (Protocols 10, 11, and 12).

RNA prepared from tissues is generally not contaminated to a significant extent with DNA. However, RNA prepared from cell lines undergoing spontaneous or induced apoptosis is often contaminated with fragments of degraded genomic DNA. RNA prepared from transfected cells is almost always contaminated by fragments of the DNA used for transfection. Some investigators therefore treat the final RNA preparation with RNase-free DNase (Grillo and Margolis 1990; Simms et al. 1993). Alternatively, fragments of DNA may be removed by preparing poly(A)<sup>+</sup> RNA by oligo(dT) chromatography.

#### STORAGE OF RNA

After precipitation with ethanol, store the RNA as follows:

- **Dissolve the precipitate in deionized formamide and store at –20°C** (Chomczynski 1992). Formamide provides a chemically stable environment that also protects RNA against degradation by RNases. Purified, salt-free RNA dissolves quickly in formamide up to a concentration of 4 mg/ml. At such concentrations, samples of the RNA can be analyzed directly by gel electrophoresis, RT-PCR, or RNase protection, saving time and avoiding potential degradation. If necessary, RNA can be recovered from formamide by precipitation with 4 volumes of ethanol as described by Chomczynski (1992) or by diluting the formamide fourfold with 0.2 M NaCl and then adding the conventional 2 volumes of ethanol (Nadin-Davis and Mezl 1982).
- **Dissolve the precipitate in an aqueous buffer and store at –80°C**. Buffers commonly used for this purpose include SDS (0.1–0.5%) in TE (pH 7.6) or in DEPC-treated H<sub>2</sub>O containing 0.1 mM EDTA (pH 7.5). The SDS should be removed by chloroform extraction and ethanol precipitation before enzymatic treatment of the RNA (e.g., primer extension, reverse transcription, and *in vitro* translation).
- **Store the precipitate of RNA as a suspension at –20°C in ethanol**. Samples of the RNA can be removed, as needed, with an automatic pipetting device. However, because precipitates of RNA are lumpy and sticky, and partly because of losses onto the surfaces of disposable pipette tips, the recovery of RNA is inconsistent.

# Protocol 2

---

## A Single-step Method for the Simultaneous Preparation of DNA, RNA, and Protein from Cells and Tissues

**T**HE FOLLOWING PROTOCOL (CHOMCZYNSKI 1993), a variation on the single-step method described in Protocol 1, allows the simultaneous recovery of RNA, DNA, and protein from an aliquot of tissue or cells. Like its predecessor (Chomczynski and Sacchi 1987), this method involves lysis of cells with a monophasic solution of guanidine isothiocyanate and phenol. Addition of chloroform generates a second (organic) phase into which DNA and proteins are extracted, leaving RNA in the aqueous supernatant. The DNA and proteins can be isolated from the organic phase by sequential precipitation with ethanol and isopropanol, respectively. The DNA recovered from the organic phase is ~20 kb in size and is a suitable template for PCRs. The proteins, however, remain denatured as a consequence of their exposure to guanidine and are used chiefly for immunoblotting. The RNA precipitated from the aqueous phase with isopropanol can be further purified by chromatography on oligo(dT)-cellulose columns and/or used for northern blot hybridization, reverse transcription, or RT-PCRs.

The yield of total RNA depends on the tissue or cell source, but it is generally 4–7 µg/mg starting tissue or 5–10 µg/10<sup>6</sup> cells. The  $A_{260}/A_{280}$  ratio of the extracted RNA is generally 1.8–2.0.

### MATERIALS

---

▲ **IMPORTANT** Prepare all reagents used in this protocol with DEPC-treated H<sub>2</sub>O (please see the information panel on **HOW TO WIN THE BATTLE WITH RNASE**).

**CAUTION:** Please see Appendix 12 for appropriate handling of materials marked with <!>.

### Buffers and Solutions

Please see Appendix 1 for components of stock solutions, buffers, and reagents. Dilute stock solutions to the appropriate concentrations.

*Chloroform* <!>

*Ethanol*

*Isopropanol*

*Liquid nitrogen* <!>

**Table 7-2 Monophasic Lysis Reagents**

REAGENT	COMMERCIAL SUPPLIER
Trizol Reagent	Life Technologies
TRI Reagent	Molecular Research Center
Isogen	Nippon Gene, Toyama, Japan
RNA-Stat-60	Tel-Test

When using commercial reagents for the simultaneous isolation of RNA, DNA, and protein, we recommend following the manufacturer's instructions. In most cases, these differ little from the generic instructions given below. However, note that the modifications of the technique described in this protocol reduce the level of contamination of the RNA by DNA, polysaccharides, and proteoglycans. At the time of writing, not all of the manufacturer's instructions contained these modifications.

#### *Monophasic lysis reagent*

The composition of the monophasic lysis reagent used for the simultaneous isolation of RNA, DNA, and proteins has not been published. However, a large number of commercial reagents, with a variety of names, are available (please see Table 7-2). These reagents are all monophasic solutions containing phenol, guanidine, or ammonium thiocyanate and solubilizing agents.

#### *Phosphate-buffered saline (PBS), ice-cold*

Required for cells grown in suspension and monolayers only.

#### *RNA precipitation solution*

1.2 M NaCl

0.8 M disodium citrate · 15H<sub>2</sub>O

No adjustment of pH is required.

#### *Sodium acetate (3 M, pH 5.2)*

## Cells and Tissues

*Source cells/tissue*

## Centrifuges and Rotors

*Sorvall H1000 rotor or equivalent*

*Sorvall SS-34 rotor or equivalent*

## Special Equipment

#### *Cuvettes for measuring absorbance at 260 nm*

The cuvettes should be either disposable UV-transparent methylacrylate or quartz. Before and after use, soak quartz cuvettes in concentrated HCl:methanol (1:1, v/v) for at least 30 minutes and then wash extensively in sterile H<sub>2</sub>O.

#### *Homogenizer (e.g., Tisumizer from Tekmar-Dohrmann or Polytron from Brinkmann)*

#### *Mortar and pestle washed in DEPC-treated H<sub>2</sub>O, prechilled*

Please see Chapter 6, Protocol 1.

#### *Polypropylene snap-cap tube (e.g., Falcon)*

#### *Water bath, preset to 65°C*

Optional, please see Step 7.

## METHOD

1. Prepare cells or tissue samples for isolation of RNA.

### FOR TISSUES

When working with tissues such as pancreas or gut that are rich in degradative enzymes, it is best to cut the dissected tissue into small pieces (100 mg) and then drop the fragments immediately into

liquid nitrogen. Fragments of snap-frozen tissue can be transferred to  $-70^{\circ}\text{C}$  for storage or used immediately for extraction of RNA as described below. Tissues can be stored at  $-70^{\circ}\text{C}$  for several months without affecting the yield or integrity of the RNA.

Snap-freezing and pulverization are not always necessary. Tissues that are not as rich in RNases may be rapidly minced into small pieces and transferred directly into polypropylene snap-cap tubes containing the appropriate amount of Solution D (Step c) below.

- a. Isolate the desired tissues by dissection and place them immediately in liquid nitrogen.
- b. Transfer  $\sim 100$  mg of the frozen tissue to a mortar containing liquid nitrogen and pulverize the tissue using a pestle. The tissue can be kept frozen during pulverization by the addition of liquid nitrogen.
- c. Transfer the powdered tissue to a polypropylene snap-cap tube containing 1 ml of ice-cold monophasic lysis reagent.
- d. Homogenize the tissue with a polytron homogenizer for 15–30 seconds at room temperature.

Instead of grinding in a mortar, frozen tissue may be placed inside a homemade bag of plastic film and pulverized with a blunt instrument (e.g., a hammer) (Gramza et al. 1995). Only certain types of plastic film are tough enough to withstand hammering at low temperature (e.g., Write-On Transparency Film from 3M).

#### FOR MAMMALIAN CELLS GROWN IN SUSPENSION

- a. Harvest the cells by centrifugation at 200–1900g (1000–3000 rpm in a Sorvall H1000 rotor) for 5–10 minutes at room temperature in a benchtop centrifuge.
- b. Remove the medium by aspiration and resuspend the cell pellets in 1–2 ml of sterile ice-cold PBS.
- c. Harvest the cells by centrifugation, remove the PBS completely by aspiration, and add 1 ml of monophasic lysis reagent per  $10^6$  cells.
- d. Homogenize the cells with a polytron homogenizer for 15–30 seconds at room temperature.

#### FOR MAMMALIAN CELLS GROWN IN MONOLAYERS

- a. Remove the medium and rinse the cells once with 5–10 ml of sterile ice-cold PBS.
  - b. Remove PBS and lyse the cells in 1 ml of monophasic lysis reagent per 90-mm culture dish (0.7 ml per 60-mm dish).
  - c. Transfer the cell lysates to a polypropylene snap-cap tube.
  - d. Homogenize the lysates with a polytron homogenizer for 15–30 seconds at room temperature.
2. Incubate the homogenates for 5 minutes at room temperature to permit complete dissociation of nucleoprotein complexes.
  3. Add 0.2 ml of chloroform per milliliter of monophasic lysis reagent. Mix the samples by vigorous shaking or vortexing.
  4. Separate the mixture into two phases by centrifuging at 12,000 rpm (10,000g in a Sorvall SS-34 rotor) for 15 minutes at  $4^{\circ}\text{C}$ . Transfer the upper aqueous phase to a fresh tube.

DNA and protein are extracted into the organic phase, leaving RNA in the aqueous phase. DNA and protein may be recovered from the organic phase by sequential precipitation with ethanol and isopropanol.

5. Precipitate the RNA from the aqueous phase: For each initial milliliter of monophasic lysis reagent, add 0.25 volume of isopropanol and 0.25 volume of RNA precipitation solution. After thorough mixing, store the final solution for 10 minutes at room temperature.

The original protocols describing monophasic lysis reagents (Chomczynski 1993; Simms et al. 1993) suggested using 0.5 volume of isopropanol to precipitate RNA from the aqueous phase. However, this step has been modified in the light of the discovery (Schick and Eras 1995) that guanidine-based extraction methods generate RNA preparations that are contaminated to a significant extent by polysaccharides and proteoglycans. These contaminants are reported to prevent solubilization of RNA after precipitation with alcohols, to inhibit RT-PCRs, and to bind to membranes during northern blotting (Groppe and Morse 1993; Re et al. 1995; Schick and Eras 1995). Changing the conditions used to precipitate RNA from the aqueous phase (Chomczynski and Mackey 1995), as described in Step 5, greatly reduces the level of contamination with proteoglycans and polysaccharides and eliminates most of the problems mentioned above.

6. Collect the precipitated RNA by centrifugation at maximum speed for 10 minutes at 4°C in a microfuge. Wash the pellet twice with 75% ethanol, and centrifuge again. Remove any remaining ethanol with a disposable pipette tip. Store the open tube on the bench for a few minutes to allow the ethanol to evaporate. Do not allow pellet to dry completely.
7. Add 50–100 µl of DEPC-treated H<sub>2</sub>O. Store the RNA solution at –70°C.

Addition of SDS to 0.5% followed by heating to 65°C may assist dissolution of the pellet.

8. Estimate the concentration of the RNA as described in Appendix 8.

Purified RNA is not immune to degradation by RNase after resuspension in the 0.5% SDS solution. Some investigators therefore prefer to dissolve the pellet of RNA in 50–100 µl of stabilized formamide and store the solution at –20°C (Chomczynski 1992). RNA can be recovered from formamide by precipitation with 4 volumes of ethanol. For further details, please see the panel on **STORAGE OF RNA** in Protocol 1.

SDS should be removed by chloroform extraction and standard ethanol precipitation before enzymatic treatment of the RNA (e.g., primer extension, reverse transcription, and *in vitro* translation). The redissolved RNA can then be used for mRNA purification by oligo(dT)-cellulose chromatography (Protocol 3), or analyzed by standard techniques such as blot hybridization (Protocols 7 and 8) or mapping (Protocols 10, 11, and 12).

RNA prepared from tissues is generally not contaminated to a significant extent with DNA. However, RNA prepared from cell lines undergoing spontaneous or induced apoptosis is often contaminated with fragments of degraded genomic DNA. RNA prepared from transfected cells is almost always contaminated by fragments of the DNA used for transfection. Some investigators therefore treat the final RNA preparation with RNase-free DNase (Grillo and Margolis 1990; Simms et al. 1993). Alternatively, fragments of DNA may be removed by preparing poly(A)<sup>+</sup> RNA by oligo(dT) chromatography.

# Protocol 3

---

## Selection of Poly(A)<sup>+</sup> RNA by Oligo(dT)-Cellulose Chromatography

**B**Y CONTRAST TO rRNA, 5S RNA, 5.8S RNA, AND tRNA, most eukaryotic mRNAs carry tracts of poly(A) at their 3' termini. mRNAs can therefore be separated from the bulk of cellular RNA by affinity chromatography on oligo(dT)-cellulose (Edmonds et al. 1971; Aviv and Leder 1972). The method takes advantage of the ability of poly(A) tails on the mRNAs to form stable RNA-DNA hybrids with short chains of oligo(dT) (generally 18–30 nucleotides in length) linked to a supporting cellulose matrix (please see the panel on **OLIGO(dT) CELLULOSE** on the following page). Because only a few dT-A base pairs are formed, high salt must be added to the initial chromatography buffer to stabilize the nucleic acid duplexes. After nonpolyadenylated RNAs have been washed from the matrix, a low-salt buffer is used to destabilize the double-stranded structures and to elute the poly(A)<sup>+</sup> RNAs from the resin.

Poly(A)<sup>+</sup> RNA can be selected by chromatography on oligo(dT) columns (this protocol) or by batch elution (Protocol 4). Column chromatography is the preferred method for purification of large quantities (>25 µg) of nonradioactive poly(A)<sup>+</sup> RNA extracted from mammalian cells. For simultaneous processing of many samples of mammalian RNA, whether radioactive or not, batch elution is the better choice because fewer fractions are collected, which speeds up the process; and because a finer grade of oligo(dT)-cellulose (type III) can be used, which increases the efficiency of binding and elution of RNA. In general, between 1% and 10% of the total RNA applied to an oligo(dT) column is recovered as poly(A)<sup>+</sup> RNA. However, it is very difficult to remove all of the nonpolyadenylated RNA species completely, even after five to six cycles of affinity chromatography.

Oligo(dT)-cellulose chromatography represents an essential step when preparing mRNA to be used as a template for construction of cDNA libraries. In addition, poly(A)<sup>+</sup> RNA usually yields better results than total RNA when analyzed by blot hybridization, PCR, or nuclease S1 and RNase protection assays. This improvement is attributable to the 10–30-fold purification of mRNA obtained by chromatography on oligo(dT)-cellulose.



**OLIGO(dT)-CELLULOSE**

Oligo(dT) continues to be heavily exploited as an affinity ligand to isolate and purify poly(A)<sup>+</sup> mRNA, essentially as described by Aviv and Leder (1972) and Nakazato and Edmonds (1972). For this purpose, thymidylate oligomers 12–18 residues in length are covalently attached to a solid matrix (usually cellulose). The standard method of synthesis of the oligomers, pioneered by Gilham (1964, 1971), involves polymerization of thymidine monophosphate in the presence of a carbodiimide. Cellulose is then added, to which the oligothymidylate molecules become attached by reaction between their 5-phosphoryl groups and the hydroxyl groups of cellulose. Gilham (1964) used oligo(dT)-cellulose columns chiefly to explore affinity chromatography of polynucleotides, showing that various oligomers of adenylic acid could be eluted from an oligo(dT)-cellulose column in a temperature-dependent fashion. For isolation of mRNA, however, it is more convenient to exploit the salt dependence of the hybridization reaction, as described in this protocol.

Oligo(dT)-celluloses are sold by a number of commercial suppliers in a variety of grades that differ in purity, flow rate, and binding capacity. As much as 10 mg of total cellular RNA can be applied to a 1-ml column of packed oligo(dT), which can bind at least 500 µg of poly(A)<sup>+</sup> RNA. Other supports for oligo(dT) that have been used from time to time include silicas, controlled pore-glass, latex, polystyrene, and paramagnetic beads (which can be recovered by a magnet) (for reviews, please see Hornes and Korsnes 1990; Jarret 1993). These rigid supports, although more expensive, can give better performance and are therefore used chiefly for more stringent tasks such as construction of subtractive cDNA libraries, solid-phase synthesis of cDNA (e.g., please see Kuribayashi-Ohta et al. 1993; Eberwine 1996), and capture of specific mRNAs by sandwich hybridization (e.g., please see Hunsaker et al. 1989; Morrissey et al. 1989; Hara et al. 1993).

**MATERIALS**

▲ **IMPORTANT** Prepare all reagents used in this protocol with DEPC-treated H<sub>2</sub>O (please see the information panel on **HOW TO WIN THE BATTLE WITH RNASE**).

**CAUTION:** Please see Appendix 12 for appropriate handling of materials marked with <!>.

**Buffers and Solutions**

Please see Appendix 1 for components of stock solutions, buffers, and reagents. Dilute stock solutions to the appropriate concentrations.

**2x Column-loading buffer**

- 40 mM Tris-Cl (pH 7.6)
- 1 mM NaCl
- 2 mM EDTA (pH 8.0)
- 0.2% (w/v) sodium lauryl sarcosinate

Prepare as described below.

Make up Tris-Cl (pH 7.6) from a fresh bottle in autoclaved, DEPC-treated H<sub>2</sub>O. Prepare NaCl and EDTA in 0.1% DEPC <!> in H<sub>2</sub>O. Store for at least 12 hours at 37°C and autoclave the mixture for 15 minutes at 15 psi (1.05 kg/cm<sup>2</sup>) on liquid cycle (please see the information panels on **HOW TO WIN THE BATTLE WITH RNASE** and **DIETHYLPYROCARBONATE**). To prepare sterile column-loading buffer, mix appropriate amounts of RNase-free stock solutions of Tris-Cl (pH 7.6), NaCl, and EDTA (pH 8.0) in an RNase-free container. Allow the solution to cool to ~65°C, and then add sodium lauryl sarcosinate from a 10% stock solution that has been heated to 65°C for 30 minutes.

Alternatively, substitute 0.05 M sodium citrate for Tris-Cl, and treat the sodium citrate/NaCl/EDTA mixture and sodium lauryl sarcosinate with DEPC (please see Protocol 1). Store column-loading buffer at room temperature.

**Elution buffer**

- 10 mM Tris-Cl (pH 7.6)
- 1 mM EDTA (pH 8.0)
- 0.05% SDS

The stock solutions of Tris-Cl and EDTA used to make elution buffer should be freshly autoclaved (15 minutes at 15 psi [1.05 kg/cm<sup>2</sup>] on liquid cycle) and then diluted with the appropriate amount of sterile DEPC-treated H<sub>2</sub>O. Then add the SDS from a concentrated stock solution (10% or 20%) made in sterile DEPC-treated H<sub>2</sub>O.

▲ **IMPORTANT** Do not attempt to sterilize elution buffer by autoclaving as it froths excessively.

*Ethanol*

*NaCl (5 M), RNase-free*

*NaOH (10 N) <math><!\>*

Dilute working solution from 10 N stock with sterile DEPC-treated H<sub>2</sub>O.

*Sodium acetate (3 M, pH 5.2)*

## Nucleic Acids and Oligonucleotides

*RNA, total*

Prepared as described in Protocol 1 or 2 of this chapter.

## Centrifuges and Rotors

*Sorvall SS-34 rotor or equivalent*

## Special Equipment

*Cuvettes for measuring absorbance at 260 nm*

Use disposable UV-transparent methacrylate cuvettes or standard quartz cuvettes. Before and after use, soak quartz cuvettes in concentrated HCl:methanol (1:1, v/v) for at least 30 minutes and then wash extensively in sterile H<sub>2</sub>O.

*Dispocolumn (Bio-Rad) or a Pasteur pipette plugged with sterile glass wool*

The Dispocolumn should be treated with DEPC (please see the information panel on **DIETHYLPYRO-CARBONATE**). The plugged Pasteur pipette should be sterilized by baking for 4 hours at 300°C.

*Equipment for storage of RNA*

Please see the panel on **STORAGE OF RNA** in Protocol 1.

*Oligo(dT)-cellulose*

This resin is usually purchased commercially as a dried powder. Use a high grade of resin, such as Type VII oligo(dT)-cellulose from Pharmacia.

Some protocols call for the use of poly(U)-Sephadex rather than oligo(dT)-cellulose. Although both resins give excellent results, oligo(dT)-cellulose is preferred because of its durability. However, poly(U)-Sephadex has a faster flow rate, which is a convenience when large volumes are to be passed through the column.

Columns of oligo(dT)-cellulose can be stored at 4°C and reused many times. Between uses, regenerate the column by sequential washing with NaOH, H<sub>2</sub>O, and column-loading buffer as described in Steps 1, 2, and 3 below. Spun columns (please see Appendix 8) containing oligo(dT)-cellulose are available from several commercial manufacturers.

*pH Paper (pH Test Strips, Sigma)*

*Water bath preset to 65°C*

## METHOD

---

### Set Up and Load the Column

1. Suspend 0.5–1.0 g of oligo(dT)-cellulose in 0.1 N NaOH.
2. Pour a column of oligo(dT)-cellulose (0.5–1.0-ml packed volume) in a DEPC-treated Dispocolumn (or a Pasteur pipette, plugged with sterile glass wool and sterilized by baking for 4 hours at 300°C). Wash the column with 3 column volumes of sterile DEPC-treated H<sub>2</sub>O.  
Keep in mind that up to 10 mg of total RNA can be loaded onto 1 ml of packed oligo(dT)-cellulose. If smaller quantities of total RNA are used, the amount of oligo(dT)-cellulose should be reduced accordingly to avoid loss of poly(A)<sup>+</sup> RNA both on the column and during the subsequent steps.
3. Wash the column with sterile 1× column-loading buffer (dilute from 2× stock using sterile DEPC-treated H<sub>2</sub>O) until the pH of the effluent is <math><8.0</math>. Use pH paper for this measurement.

4. Dissolve the RNA in double-distilled, autoclaved H<sub>2</sub>O, and heat the solution to 65°C for 5 minutes. Cool the solution to room temperature quickly, and add 1 volume of 2x column-loading buffer.

Heating the RNA disrupts regions of secondary structure that might involve the poly(A) tail. For RNAs that contain large amounts of secondary structure, the inclusion of dimethylsulfoxide (DMSO) at 10% (v/v) in the column-loading buffer may improve retention and subsequent recovery.

The sodium salt of lauryl sarcosine is relatively insoluble and may therefore impede the flow of the column if the room temperature is less than 18°C. This problem can be avoided by using LiCl instead of NaCl in the column-loading buffer.

### Recovering Poly(A)<sup>+</sup> RNA from the Column

5. Apply the solution of RNA to the column, and immediately begin to collect in a sterile tube the material flowing through the column. When all of the RNA solution has entered the column, wash the column with 1 column volume of 1x column-loading buffer while continuing to collect the flow-through.
6. When all the liquid has emerged from the column, heat the collected flow-through to 65°C for 5 minutes and reapply it to the top of the column. Again collect the material flowing through the column.

Unlike many chromatography resins, oligo(dT)-cellulose neither swells when hydrated nor cracks when dry. There is no need to maintain a flow of liquid through the column or to keep the matrix damp.

7. Wash the column with 5–10 column volumes of 1x column-loading buffer, collecting 1-ml fractions into sterile plastic tubes (e.g., microfuge tubes).

In some protocols, the column is washed with 5 column volumes of 1x column-loading buffer containing 0.1 M NaCl after Step 7. However, very little or no nonpolyadenylated RNA elutes from the column during this wash, which can therefore be omitted.

8. Use quartz or disposable methacrylate cuvettes to measure the absorbance at 260 nm of a 1:20 dilution of each fraction collected from the column using 1x column-loading buffer as a blank.

A solution containing 38 µg/ml RNA will give an absorbance reading of 1.0 at 260 nm and a reading of 0.4–0.5 at 280 nm. Initially, the OD<sub>260</sub> will be very high as the nonpolyadenylated RNA passes through the column. The later fractions should have very little or no absorbance at 260 nm.

9. Precipitate the fractions containing a majority of the OD<sub>260</sub> material by the addition of 2.5 volumes of ethanol.

This so-called poly(A)<sup>-</sup> RNA is a useful control in subsequent experiments.

### Eluting Poly(A)<sup>+</sup> RNA from the Column

10. Elute the poly(A)<sup>+</sup> RNA from the oligo(dT)-cellulose with 2–3 column volumes of sterile, RNase-free elution buffer. Collect fractions equivalent in size to 1/3 to 1/2 of the column volume.
11. Use quartz or disposable methacrylate cuvettes to measure the absorbance at 260 nm of each fraction collected from the column. Pool the fractions containing the eluted RNA.

### Further Purification of the RNA (Optional)

The material obtained after a single round of chromatography on oligo(dT)-cellulose usually contains approximately equal amounts of polyadenylated and nonpolyadenylated species of RNA. Polyadenylated RNA may be further purified as described in the following steps.

12. To purify poly(A)<sup>+</sup> RNA further, heat the preparation of RNA to 65°C for 3 minutes and then cool it quickly to room temperature. Adjust the concentration of NaCl in the eluted RNA to 0.5 M using 5 M NaCl and carry out a second round of chromatography on the same column of oligo(dT)-cellulose (i.e., repeat Steps 3 and 5–11).
13. To the poly(A)<sup>+</sup> RNA eluted from the second round of oligo(dT)-cellulose chromatography, add 3 M sodium acetate (pH 5.2) to a final concentration of 0.3 M. Mix well. Add 2.5 volumes of ice-cold ethanol, mix, and store the solution for at least 30 minutes on ice.
14. Recover the poly(A)<sup>+</sup> RNA by centrifugation at 10,000g (9000 rpm in a Sorvall SS-34 rotor) for 15 minutes at 4°C. Carefully discard the supernatant, and wash the pellet (which is often invisible) with 70% ethanol. Recentrifuge briefly, remove the supernatant by aspiration, and store the open tube in an inverted position for a few minutes to allow most of the residual ethanol to evaporate. Do not allow the pellet to dry.
15. Redissolve the damp pellet of RNA in a small volume of sterile, DEPC-treated H<sub>2</sub>O. Use quartz or disposable methacrylate cuvettes to measure the absorbance at 260 nm of each fraction collected from the column. Pool the fractions that contain RNA.  
 Assume that the amount of poly(A)<sup>+</sup> RNA recovered is equal to 5–10% of the starting total RNA and read the absorbance on an appropriate dilution of the resuspended RNA.  
 A solution with an OD<sub>260</sub> of 1 contains ~38 µg of RNA/ml.
16. Store the preparation of poly(A)<sup>+</sup> RNA as described in the panel on **STORAGE OF RNA** in Protocol 1.

# Protocol 4

---

## Selection of Poly(A)<sup>+</sup> RNA by Batch Chromatography

**W**HEN MANY RNA SAMPLES ARE TO BE PROCESSED or when working with small amounts (<50 µg) of total mammalian RNA, the technique of choice is batch chromatography on oligo(dT)-cellulose. The method is carried out with a fine grade of oligo(dT)-cellulose at optimal temperatures for binding and elution. Many methods for purification of poly(A)<sup>+</sup> RNAs by batch chromatography have been published over the years. The technique described below is a modification of the method of Celano et al. (1993). For additional methods, please see the panel on **ADDITIONAL METHODS TO SELECT POLY(A)<sup>+</sup> RNA** following Step 15.

### MATERIALS

---

▲ **IMPORTANT** Prepare all reagents used in this protocol with DEPC-treated H<sub>2</sub>O (please see the information panel on **HOW TO WIN THE BATTLE WITH RNASE**).

**CAUTION:** Please see Appendix 12 for appropriate handling of materials marked with <!>.

### Buffers and Solutions

Please see Appendix 1 for components of stock solutions, buffers, and reagents. Dilute stock solutions to the appropriate concentrations.

*Absorption/washing buffer*

This buffer is TES containing 0.5 M NaCl.

*Ammonium acetate (10 M) <!>*

*Ethanol*

*Ice-cold water*

*NaCl (5 M)*

*TES*

### Nucleic Acids and Oligonucleotides

*RNA, total*

Prepared as described in Protocol 1 or 2 of this chapter.

### Special Equipment

*Cuvettes for measuring absorbance at 260 nm*

Use disposable UV-transparent methacrylate cuvettes or standard quartz cuvettes. Before and after use, soak quartz cuvettes in concentrated HCl:methanol (1:1, v/v) for at least 30 minutes and then wash extensively in sterile H<sub>2</sub>O.

*Microfuge fitted with speed control*

*Oligo(dT)<sub>18-30</sub> cellulose*

Use Type III cellulose (binding capacity 100 OD<sub>260</sub>/g) equilibrated in absorption/washing buffer and suspended in the same buffer at a concentration of 100 mg/ml. For details, please see Protocol 3, Steps 1 through 3.

*Rotating wheel*

*Water baths preset to 55°C and 65°C*

## METHOD

---

1. In a series of sterile microfuge tubes, adjust the volume of each sample of total RNA (up to 1 mg) to 600 µl with TES. Heat the sealed tubes to 65°C for 10 minutes and then cool them quickly in ice to 0°C. Add 75 µl (0.1 volume) of 5 M NaCl to each sample.
2. Add 50 mg (500 µl) of equilibrated oligo(dT)-cellulose to each tube and incubate the closed tubes on a rotating wheel for 15 minutes at room temperature.
3. Centrifuge the tubes at 600–800g (~1500–2500 rpm) for 2 minutes at room temperature in a microfuge.
4. Transfer the supernatants to a series of fresh microfuge tubes. Store the tubes on ice.
5. To the pellets of oligo(dT) remaining in the first set of tubes, add 1 ml of ice-cold absorption/washing buffer. Disperse the pellets of oligo(dT) by gentle vortexing. Incubate the closed tubes on a rotating wheel for 2 minutes at room temperature.
6. Centrifuge the tubes at 600–800g (~1500–2500 rpm) for 2 minutes at room temperature in a microfuge. Discard the supernatants and then repeat Steps 5 and 6 twice.
7. Resuspend the pellets of oligo(dT) in 0.4 ml of *ice-cold*, double-distilled, autoclaved H<sub>2</sub>O by gentle vortexing. Immediately centrifuge the tubes for 2 minutes at 4°C in a microfuge.
8. Remove the supernatants by careful aspiration.
9. Recover the bound poly(A)<sup>+</sup> RNA by resuspending the pellets of oligo(dT)-cellulose in 400 µl of double-distilled, autoclaved H<sub>2</sub>O. Incubate the suspensions for 5 minutes at 55°C and then centrifuge the tubes for 2 minutes at 4°C in a microfuge.
10. Transfer the supernatants to a series of fresh tubes and repeat Step 9 twice, pooling the recovered supernatants.
11. Add 0.2 volume of 10 M ammonium acetate and 2.5 volumes of ethanol to the supernatants. Store the tubes for 30 minutes at –20°C.
12. Recover the precipitated poly(A)<sup>+</sup> RNAs by centrifugation at maximum speed for 15 minutes at 4°C in a microfuge. Carefully discard the supernatants, and wash the pellets (which are often invisible) with 70% ethanol. Centrifuge briefly, remove the supernatants by aspiration, and store the open tubes in an inverted position for a few minutes to allow most of the residual ethanol to evaporate.
13. Dissolve the RNA in a small volume of sterile DEPC-treated H<sub>2</sub>O.
14. Estimate the concentration of the RNA as described in Appendix 8.
15. Store the preparations as described in the panel on **STORAGE OF RNA** in Protocol 1.

**ADDITIONAL METHODS TO SELECT POLY(A)<sup>+</sup> RNA**

Many alternative methods to oligo(dT) chromatography have been devised over the years to select poly(A)<sup>+</sup> mRNA from preparations of total RNA. These methods include the following:

- **Chromatography on poly(U)-Sephrose** (Lindberg and Persson 1974). The advantage of this technique is that RNA molecules with short poly(A) tails will bind efficiently to the long (~100 nucleotide) poly(U) chains attached to the Sepharose. Disadvantages of the method include the comparatively low binding capacity of poly(U)-Sephrose and the necessity of using formamide-based buffers to elute the bound poly(A) RNA efficiently from the long poly(U) chains.
- **Paper filters to which poly(U) residues are covalently attached** (Wreschner and Herzberg 1984; Jacobson 1987). Total cellular RNA is spotted onto the filters, which are then washed in DEPC-treated 0.1 M NaCl and 70% ethanol. Poly(A)<sup>+</sup> RNA is eluted by heating the filters to 70°C for 5 minutes in H<sub>2</sub>O. These filters bind up to 20 µg of poly(A)<sup>+</sup> RNA/cm<sup>2</sup> and are extremely useful when isolating small amounts of poly(A)<sup>+</sup> RNA from many samples simultaneously.
- **Streptavidin-coated paramagnetic polystyrene beads** (Albretsen et al. 1990; Hornes and Korsnes 1990; Jakobsen et al. 1990). These beads (available from Promega and other suppliers) have the advantage that mRNA can be directly isolated from lysis buffers containing guanidinium isothiocyanate. In a typical experiment, tissue, cells, or cell suspensions are lysed with guanidinium thiocyanate, and a biotinylated oligo(dT) primer is added directly to the lysate. After a short period of time to allow hybridization of the primer to the poly(A) tails of cellular mRNAs, magnetized beads to which streptavidin has been coupled are added to the lysate. The streptavidin captures the biotinylated oligo(dT)-poly(A)<sup>+</sup> mRNA complexes and affixes them to the magnetized beads. A magnet is then used to retrieve the beads from the lysate solution and to facilitate washing of the beads with a high-salt solution. In a final step, the poly(A)<sup>+</sup> mRNA is released from the beads with H<sub>2</sub>O and then collected by ethanol precipitation. The yield of poly(A)<sup>+</sup> mRNA isolated with beads is equal to or exceeds that obtained by conventional oligo(dT)-cellulose chromatography. Among the advantages offered by these beads are speed of operation and the possibility of working at kinetic rates close to those occurring in free solution. Binding of ligand takes only a few minutes, and magnetic separation takes seconds: Washing or elution can in most cases be completed in 15 minutes or less. However, the use of these beads have two strong drawbacks: A maximum of 1 g of tissue or cells can be worked up at any one time and the beads are very expensive.

## Northern Hybridization

**N**ORTHERN HYBRIDIZATION IS USED TO MEASURE the amount and size of RNAs transcribed from eukaryotic genes and to estimate their abundance. No other method is capable of obtaining these pieces of information simultaneously from a large number of RNA preparations; northern analysis is therefore fundamental to studies of gene expression in eukaryotic cells.

Northern hybridization became part of the standard repertoire of molecular biology almost immediately after the first descriptions of the method were published (Alwine et al. 1977, 1979). Although many variations and improvements (e.g., please see Kroczek 1993) have been published during the succeeding 20 years, the basic steps in northern analysis remain unchanged:

- isolation of intact mRNA
- separation of RNA according to size through a denaturing agarose gel
- transfer of the RNA to a solid support in a way that preserves its topological distribution within the gel
- fixation of the RNA to the solid matrix
- hybridization of the immobilized RNA to probes complementary to the sequences of interest
- removal of probe molecules that are nonspecifically bound to the solid matrix
- detection, capture, and analysis of an image of the specifically bound probe molecules.

There are choices at every step during the process and new alternatives continually appear in the literature. It is impossible to distill from this ferment the “best” combination of methods that can be universally applied in all situations. However, the methods described in the next five protocols are extremely robust and have worked well in a wide variety of circumstances.

### **SEPARATION OF RNA ACCORDING TO SIZE**

---

Electrophoresis through denaturing agarose gels is used to separate RNAs according to size and is the first stage in northern hybridization. In earlier times, methylmercuric hydroxide (Bailey and Davidson 1976) achieved some degree of popularity, particularly among the brave and foolhardy. Although unparalleled as a denaturing agent, methylmercuric hydroxide is both volatile and extremely toxic (Cummins and Nesbitt 1978) and is therefore no longer recommended. The following are the two methods most commonly used today to separate denatured RNAs for northern analysis.



- Electrophoresis of RNA denatured with glyoxal/formamide through agarose gels (Protocol 5) (Bantle et al. 1976; McMaster and Carmichael 1977; Goldberg 1980; Thomas 1980, 1983).
- Pretreatment of RNA with formaldehyde and dimethylsulfoxide, followed by electrophoresis through gels containing up to 2.2 M formaldehyde (Protocol 6) (Boedtke 1971; Lehrach et al. 1977; Rave et al. 1979).

The two systems have approximately the same resolving power (Miller 1987), and the technical problems with both of them have long since been solved. For example, recirculation of electrophoresis buffer is no longer required when separating glyoxylated RNA in agarose gels and staining of RNA with ethidium bromide is now possible. However, glyoxal and especially formaldehyde retain some disadvantages, including toxicity. The choice between the systems therefore depends on the relative weight of these disadvantages, which will vary from one laboratory to the next.

Many compounds other than glyoxal, formaldehyde, and methylmercuric hydroxide have been explored as denaturing agents for RNA during gel electrophoresis, but few of these have proven to be reliable in routine laboratory use. Guanidine thiocyanate is the only compound that may have advantages over formaldehyde or glyoxal (Goda and Minton 1995). When incorporated into an agarose gel at a final concentration of 10 mM, it maintains RNA in a denatured form. Electrophoresis may be carried out in standard TBE buffer and ethidium bromide may be incorporated in the gel. However, few laboratories have adopted the method, and at present, experience with this system is too limited for us to recommend that guanidine thiocyanate be used in place of glyoxal and formaldehyde.

## EQUALIZING AMOUNTS OF RNA IN NORTHERN GELS

Equalizing the amounts of RNA loaded into lanes of northern gels is a thorny problem when a number of different samples are to be compared. Several different approaches are possible and none of them perfect:

- **Loading of equal amounts of RNA** (usually 0.5–0.7 OD<sub>260</sub> units) into each lane of the gel. rRNAs are the dominant components in preparations of total cellular RNA and contribute >75% of the UV-adsorbing material. Northern analysis of equal quantities of total RNA shows how the steady-state concentration of target mRNAs changes with respect to rRNA content of the cell (Alwine et al. 1977; de Leeuw et al. 1989). Unlike the transcripts of housekeeping genes (see below), there is no evidence that the levels of 18S or 28S rRNA vary significantly from one mammalian tissue or cell line to the next (e.g., please see Bhatia et al. 1994). In addition, rRNA can easily be detected in agarose gels by staining with ethidium bromide instead of a second round of hybridization with a specific probe.
- **Normalizing samples according to their content of mRNAs** of an endogenous, constitutively expressed housekeeping gene such as cyclophilin,  $\beta$ -actin, or glyceraldehyde-3-phosphate dehydrogenase (GAPDH) (Kelly et al. 1983). All three genes are expressed at moderately abundant levels (~0.1% of poly(A)<sup>+</sup> RNA or 0.003% of total cellular RNA). Variations observed in the intensity of the hybridization signal of the gene of interest are often expressed relative to one of these three housekeeping genes. However, it turns out that the levels of expression of housekeeping genes are not constant from one mammalian tissue to another nor from one cell line to another (e.g., please see Spanakis 1993; Bhatia et al. 1994). Alterations in the relative intensity of the hybridization signals between the housekeeping gene and the gene of interest may therefore result from changes in the level of transcription of either gene or both.

- **Loading of equal amounts of poly(A)<sup>+</sup> RNA.** The poly(A)<sup>+</sup> content of preparations of RNA can be compared by slot- or dot-blot hybridization to a radiolabeled poly(dT) probe (Harley 1987, 1988). Equivalent amounts of poly(A)<sup>+</sup> RNA can then be loaded into each lane of a northern gel. This is an attractive option because it measures changes in concentration of a specific mRNA relative to the total amount of gene transcripts in the cell.
- **Using a synthetic pseudomessage as a standard.** Several groups (e.g., please see Toscani et al. 1987; DuBois et al. 1993) have used RNAs synthesized in vitro as externally added standards to calibrate the expression of the gene of interest in different preparations of cellular RNA. The synthetic pseudomessage, which is engineered to be different in size from the natural message, is added in known amounts to samples at the time of cell lysis. The relative intensity of the hybridization signals obtained from the authentic and pseudomessages is used to estimate the expression of the endogenous gene of interest.

## MARKERS USED IN GELS TO FRACTIONATE RNA

---

The size of an RNA of interest can be measured accurately only when markers of known molecular weight are included in the gel. Four types of markers are commonly used:

- **RNA standards purchased from a commercial source.** These standards are usually generated by in vitro transcription of cloned DNA templates of known length. As a consequence, the RNA standards are sometimes contaminated by template DNA and its associated plasmid sequences. Vector sequences present in the probe used in northern hybridization may hybridize to these remnants, generating on the autoradiogram either discrete bands or, more commonly, a smear where none should be.
- **DNA standards purchased from a commercial source.** Glyoxylated denatured DNAs and RNAs of equal length migrate at equal speeds through agarose gels. Small DNAs of known size can therefore be used as markers in this system. Once again, however, there is a chance that vector sequences present in the probe may hybridize with the standards. At times, this can be an advantage because the signals generated by the marker bands on the autoradiogram can be used directly to measure the size of the RNA of interest. DNA standards should not be used as markers on gels containing formaldehyde since RNA migrates through these gels at a faster rate than DNA of equivalent size (Wicks 1986).
- **Highly abundant rRNAs (28S and 18S) within the RNA preparations under test.** The sizes of these RNAs vary slightly from one mammalian species to another. 18S rRNAs range in size from 1.8 kb to 2.0 kb, whereas 28S RNAs range between 4.6 kb and 5.3 kb in length.
- **Tracking dyes.** In most denaturing agarose gel systems, bromophenol blue migrates slightly faster than the 5S rRNA, whereas xylene cyanol migrates slightly slower than the 18S rRNA.

## MEMBRANES USED FOR NORTHERN HYBRIDIZATION

---

Transfer of electrophoretically separated DNA and RNA from gels to two-dimensional solid supports is a key step in northern hybridization. Initially, hybridization was carried out exclusively with RNA immobilized on activated cellulose papers (Alwine et al. 1977; Seed 1982a,b). However, it was soon realized that RNA denatured by glyoxal, formaldehyde, or methylmercuric hydroxide, like denatured DNA, binds tightly to nitrocellulose (Thomas 1980, 1983). For several years thereafter, nitrocellulose was the support of choice for northern hybridization.

Unfortunately, nitrocellulose is not an ideal matrix for solid-phase hybridization because its capacity to bind nucleic acids is low ( $\sim 50\text{--}100\ \mu\text{g}/\text{cm}^2$ ) and varies according to the size of the RNA. In addition, the RNA becomes attached to nitrocellulose by hydrophobic rather than covalent interactions and therefore leaches slowly from the solid support during hybridization and washing at high temperatures. Finally, nitrocellulose membranes become brittle during baking under vacuum at  $80^\circ\text{C}$ , which is an integral part of the process to immobilize nucleic acids. The friable membranes cannot subsequently survive more than two to three cycles of hybridization and washing at high temperatures.

These problems have been solved by the introduction of various types of nylon membranes that bind nucleic acids irreversibly, are far more durable than nitrocellulose filters (Reed and Mann 1985), and can be repaired if damaged (Pitas 1989). Immobilized nucleic acids can therefore be hybridized sequentially to several different probes. Furthermore, because nucleic acids can be immobilized on nylon in buffers of low ionic strength, transfer of nucleic acids from gels to nylon can be carried out electrophoretically. This advantage can be useful when capillary or vacuum transfer is inefficient, for example, when small molecules of RNA are transferred from polyacrylamide gels.

Two types of nylon membranes are available commercially: unmodified (or neutral) nylon and charge-modified nylon, which carries amine groups and is therefore also known as positively charged or (+) nylon. Both types of nylon bind single- and double-stranded nucleic acids and retention is quantitative in solvents as diverse as water, 0.25 N HCl, and 0.4 N NaOH. Charge-modified nylon has a greater capacity to bind nucleic acids (see Table 7-3), but it has a tendency to give increased levels of background hybridization, which results, at least in part, from nonspecific binding of negatively charged phosphate groups in RNA to the positively charged groups on the surface of the polymer. However, this problem can usually be controlled by using increased quantities of blocking agents in the prehybridization and hybridization steps.

Nylon is a generic name for any long-chain synthetic polymer having recurring polyamide ( $-\text{CONH}-$ ) groups. Nylons of different types are formed from various combinations of diacids, diamines, and amino acids. In the standard nomenclature, a single numeral (e.g., nylon 6) indicates the number of carbon atoms in a monomer. Two numbers (e.g., nylon 6,6 or 66) indicate a polymer formed from diamines and dibasic acids. The first number indicates the number of carbon atoms separating the nitrogen atoms of the diamine, and the second number indicates the number of straight chain carbon atoms in the dibasic amino acid.

Fiber 66, the original name of nylon, was developed in the 1930s by Wallace Carothers, a chemist working for DuPont (see Fenichell 1999). His discovery, which grew from a decade of research on the structure and assembly of long-chain polyamide polymers, should have been the capstone of his career, but instead was the catalyst to tragedy. Carothers, more a scientific aesthete than a twentieth century company man, became deeply depressed by the idea that he had discovered a material whose chief use seemed to be as a replacement for silk stockings. In 1937, a few days after filing his patent for Fiber 66, Carothers, just 41 years old, killed himself in a hotel room by swallowing cyanide. DuPont pressed ahead with the commercial development of Fiber 66 and, in a ceremony that would have been anathema to Carothers, dedicated the name nylon to the public domain at a Herald Tribune Forum in October of the following year. Stockings, of course, turned out to be just the first of a line of nylon products, some of which would surely have given Carothers great pleasure, including perhaps, nylon membranes for immobilizing nucleic acids.

Different brands of nylon membranes are available that vary in the extent and type of charged groups and the density of the nylon mesh. Comparisons of the efficiency of these membranes for northern blotting and hybridization under various conditions are published from time to time (e.g., please see Khandjian 1987; Rosen et al. 1990; Twomey and Krawetz 1990; Beckers et al. 1994). In addition, each manufacturer provides specific recommendations for the transfer of nucleic acids to their particular product. The instructions given in Protocols 6 through 8 (northern hybridization) and in Chapter 6, Protocols 8–10 (Southern transfer) work well in almost all circumstances, and in some cases, yield results that exceed the manufacturer's standard.

**TABLE 7-3 Properties of Nylon Membranes Used for Immobilization of DNA and RNA**

PROPERTY	NEUTRAL NYLON	CHARGED NYLON
Capacity ( $\mu\text{g}$ nucleic acid/ $\text{cm}^2$ )	~200–300	400–500
Size of nucleic acid required for maximal binding	>50 bp	>50 bp
Transfer buffer	low ionic strength over a wide range of pH	
Immobilization	baking for 1 hour at 70°C; no vacuum required <i>or</i> mild alkali <i>or</i> UV irradiation at 254 nm; damp membranes are generally exposed to 1.6 kJ/m <sup>2</sup> ; dried membranes require 160 kJ/m <sup>2</sup>	
Commercial products	Hybond-N Gene-Screen	Hybond-N+ Zeta-Probe Nytran + Gene-Screen Plus

## TRANSFERRING RNA FROM GELS TO SOLID SUPPORTS

The crucial step in northern analysis is the transfer of denatured RNA from the interstices of an agarose gel to the surface of a membrane. Transfer must be done in a way that not only preserves the distribution of the molecules along the length of the gel, but works efficiently for nucleic acids of quite different sizes. Over the years, many methods have been found to achieve these goals, including electroblotting, vacuum blotting, semidry blotting, and upward capillary blotting. In addition, several attempts have been made to avoid transfer completely by performing hybridization directly in the gel (e.g., please see Purrello and Balazs 1983; Tsao et al. 1983). However, it is not clear whether these techniques, which may require expensive pieces of equipment, are superior to the original method of upward capillary transfer (Southern 1975). Certainly, there does not seem to be any good reason to rush out and buy a vacuum blotting or electroblotting apparatus in the belief that it will significantly improve northern and Southern blots.

- **Upward capillary transfer.** The original simple and economical technique devised by Southern (1975) involves an overnight transfer of nucleic acids from gel to membrane in an upward flow of buffer (please see Figure 7-2). A major drawback is selective retention of large molecules of nucleic acid within the gel, which is caused by flattening, compression, and dehydration of the gel. This problem can be relieved (1) by using the thinnest gels possible, (2) by ensuring that the filter papers in immediate contact with the gel are thoroughly saturated with buffer before transfer begins, and (3) by partial hydrolysis of RNA by alkali (Reed and Mann 1985) before transfer. It is important that partial hydrolysis be used with moderation since overenthusiasm can generate fragments too short to bind efficiently to the membrane.

Since 1975, the common practice has been to carry out upward capillary transfer for 16 hours or so. However, ascending transfer is now known to be almost complete after 4 hours (Lichtenstein et al. 1990), and we now recommend much shorter transfer times. A more serious problem with ascending transfer is the potential for some of the RNA to move from the gel in a descending direction counter to the flow of the buffer. This apparent anomaly occurs when the filter paper under the gel is not fully saturated with buffer. Fluid is then drawn from

the gel, carrying with it some of the nucleic acid. The problem can be ameliorated by ensuring that the bottom filter paper, like the top, is fully saturated with buffer and by working quickly to set up the remainder of the transfer system once the gel has been laid on the bottom filter.

- **Downward capillary transfer.** Descending transfer (please see Figure 7-3) does not cause flattening of the agarose gel and results in a faster transfer of nucleic acid. RNA molecules up to 8 kb in size, for example, are transferred with high efficiency within 1 hour at either neutral or alkaline pH (Chomczynski 1992; Chomczynski and Mackey 1994). The speed of downward capillary transfer therefore has particular advantage when carrying out alkaline blotting of RNA. Blotting of RNA for more than 4 hours significantly decreases the strength of the hybridization signal, presumably due to excessive hydrolysis of the RNA.

## **FURTHER INFORMATION ABOUT NORTHERN HYBRIDIZATION**

---

Northern and Southern hybridizations have much in common, including, for example, the mechanics of hybridization, the types of probes, and the posthybridization processing of the membranes. All of these topics are discussed in depth in other areas within this manual. Signposts to this information are posted at relevant positions within the next five protocols.

# Protocol 5

---

## Separation of RNA According to Size: Electrophoresis of Glyoxylated RNA through Agarose Gels

**T**HE METHOD DESCRIBED IN THIS PROTOCOL INCORPORATES GLYOXAL denaturation with agarose gel electrophoresis (adapted from McMaster and Carmichael [1977] and Thomas [1983]). The conditions for simultaneous glyoxylation of RNA and staining with ethidium bromide, as well as the modifications to the electrophoresis buffer, are those of Burnett (1997).

Glyoxal (also known as diformyl and ethanedial) is used to eliminate secondary structures in single-stranded RNA during electrophoresis through agarose gels. The two aldehyde groups of glyoxal react under slightly acid conditions with the imino groups of guanosine to form a cyclic compound that prevents formation of intrastrand Watson-Crick bonds (Salomaa 1956; Shapiro and Hachmann 1966; Nakaya et al. 1968). Once established, this adduct is stable at room temperature at  $\text{pH} \leq 7.0$ , so an aldehyde need not be incorporated into the agarose gel (McMaster and Carmichael 1977). Because the glyoxylated RNA is unable to form stable secondary structures, it migrates through agarose gels at a rate that is approximately proportional to the  $\log_{10}$  of its size (McMaster and Carmichael 1977).

Agarose gel electrophoresis of glyoxylated RNA must be carried out at low ionic strength to suppress renaturation of the RNA. The running buffers used until recently (10 mM phosphate or 40 mM 3-*N*-morpholinopropanesulfonic acid [MOPS]) had limited buffering capacity. Thus, a major drawback to the use of glyoxal as a denaturing agent was the upward shift in pH of the standard electrophoresis buffer that occurred in the cathodic chamber during running of the agarose gel. If this shift were allowed to proceed unhindered, a steep pH gradient would form as small ions in the buffers migrated rapidly along the gel from the cathode (O'Conner et al. 1991), resulting in removal of the glyoxal adduct from the RNA (Nakaya et al. 1968). For many years, it has therefore been necessary to recirculate the buffer mechanically or to replace it at regular intervals during the electrophoretic run. A more recent solution to this problem is to use a more stable electrophoresis buffer containing a weak acid and a weak base with similar pK values (Burnett 1997).

Staining glyoxylated RNA in agarose gels has also been a problem until recently. Staining the gel with ethidium bromide after electrophoresis is insensitive because of the high background of nonspecific fluorescence. Acridine orange, which has been used for years to stain DNA and RNA (Richards et al. 1965), gives stronger signals than ethidium bromide but requires extensive washing of the gel. Staining the RNA during glyoxylation before loading the gel has always seemed to be an unpromising approach since ethidium bromide was reported to react with glyoxal

(McMaster and Carmichael 1977). Recently, however, Gründemann and Koepsell (1994) and Burnett (1997) have reported that RNA can be effectively stained during denaturation with glyoxal and that the limits of detection are ~10 ng of RNA per band. However, such high sensitivity comes at a price: Staining with ethidium bromide results in a modest decrease in hybridization efficiency after transfer of the RNA to a membrane (Wilkinson et al. 1990).

If a decrease in hybridization efficiency is unacceptable, then ethidium bromide should be left out of the glyoxal reaction mixture and Steps 1 through 5 should be followed as indicated. After electrophoresis, the outside lanes of the agarose gel containing the size standards should be cut from the gel, incubated for 30 minutes at room temperature in 0.05 M NaOH containing 1 µg/ml ethidium bromide, and photographed with UV illumination. The remainder of the gel containing the cellular RNAs is then processed as described in Protocol 7.

## MATERIALS

▲ **IMPORTANT** Prepare all reagents used in this protocol with RNase-free H<sub>2</sub>O (please see the information panel on **HOW TO WIN THE BATTLE WITH RNASE**).

**CAUTION:** Please see Appendix 12 for appropriate handling of materials marked with <!>.

## Buffers and Solutions

Please see Appendix 1 for components of stock solutions, buffers, and reagents. Dilute stock solutions to the appropriate concentrations.

### 10x BPTE electrophoresis buffer

100 mM PIPES (piperazine-1,4-bis[2-ethanesulfonic acid])  
300 mM Bis-Tris (bis[2-hydroxyethyl]iminotris[hydroxymethyl]methane)  
10 mM EDTA (pH 8.0)

The final pH of the 10x buffer is ~6.5.

Prepare the 10x buffer by adding 3 g of PIPES (free acid), 6 g of Bis-Tris (free base), and 2 ml of 0.5 M EDTA (pH 8.0) to 90 ml of distilled H<sub>2</sub>O, then treating the solution with DEPC, final concentration 0.1%, for 1 hour at 37°C, and then autoclaving (for more details, please see the information panel on **DIETHYLPYROCARBONATE**).

### DMSO <!>

Purchase a high grade of DMSO (HPLC grade or better).

### Glyoxal

Commercial stock solutions of glyoxal (40% or 6 M) contain various hydrated forms of glyoxal, as well as oxidation products such as glyoxylic acid, formic acid, and other compounds that can degrade RNA, and therefore must be removed (please see Appendix 1).

### Glyoxal reaction mixture

6 ml of DMSO  
2 ml of deionized glyoxal  
1.2 ml of 10x BPTE electrophoresis buffer  
0.6 ml of 80% glycerol in H<sub>2</sub>O  
0.2 ml of ethidium bromide (10 mg/ml in H<sub>2</sub>O) <!>

Divide into small aliquots and store at -70°C.

### RNA gel-loading buffer

## Gels

### Agarose gel

Cast an agarose gel as described in Chapter 5, Protocol 1 in 1x BPTE electrophoresis buffer. Use a comb with at least four more teeth than the number of RNA samples under test. These extra lanes are used for RNA size markers and running dyes (please see Step 4). A 1.5% agarose gel is suitable for resolving RNAs in the 0.5–8.0-kb size range. Larger RNAs should be separated on 1.0% or 1.2% gels.

## Nucleic Acids and Oligonucleotides

### RNA samples

Samples of total or poly(A)<sup>-</sup> RNA should consist of up to 10 µg of RNA in a volume of 1–2 µl. Equivalent amounts of the RNA samples to be analyzed are removed from storage (please see the panel on **STORAGE OF RNA** in Protocol 1). Precipitate the RNA with ethanol and dissolve the pellet in an appropriate volume of sterile, DEPC-treated H<sub>2</sub>O.

The presence of salts or SDS in the samples, or loading of >10 µg of RNA per lane, can cause smearing of the RNA during electrophoresis.

### RNA size markers

Glyoxylated RNAs and DNAs of the same size migrate through agarose gels at the same rate. However, we recommend using RNA ladders (e.g., from Life Technologies) that contain RNAs of 9.49, 7.46, 4.40, 2.37, 1.35, and 0.24 kb in length. This allows the markers to be used as sentinels to detect RNase contamination or other problems that may occur during glyoxylation or electrophoresis. Please see the Introduction to Northern Hybridization preceding Protocol 5.

## Special Equipment

### Equipment for horizontal electrophoresis

A particular electrophoresis apparatus should be reserved for RNA analysis. Clean electrophoresis tanks and combs used for electrophoresis of RNA (Protocols 5 and 6) with detergent solution, rinse in H<sub>2</sub>O, dry with ethanol, and then fill with a solution of 3% H<sub>2</sub>O<sub>2</sub>. After 10 minutes at room temperature, rinse the electrophoresis tanks and combs thoroughly with H<sub>2</sub>O treated with 0.1% DEPC.

### Ruler, transparent

Water bath preset to 55°C

## METHOD

1. Set up the glyoxal denaturation reaction. In sterile microfuge tubes mix:

RNA (up to 10 µg)	1–2 µl
glyoxal reaction mixture	10 µl

Up to 10 µg of RNA may be analyzed in each lane of the gel. Abundant mRNAs (0.1% or more of the mRNA population) can usually be detected by northern analysis of 10 µg of total cellular RNA. Detection of rare RNAs requires at least 1.0 µg of poly(A)<sup>+</sup> RNA. Samples containing RNA size markers should be prepared in glyoxal reaction mixture in the same way as the RNA samples under test. Please see the Introduction to Northern Hybridization (Equalizing Amounts of RNA in Northern Gels).

2. Close the tops of the microfuge tubes, and incubate the RNA solutions for 60 minutes at 55°C. Chill the samples for 10 minutes in ice water, and then centrifuge them for 5 seconds to deposit all of the fluid in the bottom of the microfuge tubes.
 

Some investigators prefer to heat the RNA samples before electrophoresis for 10 minutes at 65°C.
3. While the samples are incubating, install the agarose gel in a horizontal electrophoresis box. Add sufficient 1× BPTE electrophoresis buffer to cover the gel to a depth of ~1 mm.
4. Add 1–2 µl of RNA gel-loading buffer to the glyoxylated RNA samples, and without delay, load the glyoxylated RNA samples into the wells of the gel, leaving the two outermost lanes on each side of the gel empty. Load the RNA size markers in the outside lanes of the gel.
5. Carry out electrophoresis at 5 V/cm until the bromophenol blue has migrated ~8 cm.
 

Using higher voltages during electrophoresis leads to smearing of bands.



6. Visualize the RNAs by placing the gel on a piece of Saran Wrap on a UV transilluminator. Align a transparent ruler with the stained gel and photograph the gel under UV illumination. Please see the panel on **CHECKING THE QUALITY OF PREPARATIONS OF RNA**.
7. Use the photograph to measure the distance from the loading well to each of the bands of RNA. Plot the  $\log_{10}$  of the size of the fragments of RNA against the distance migrated. Use the resulting curve to calculate the sizes of the RNA species detected by blot hybridization.
8. Proceed with immobilization of RNA onto a solid support by upward or downward capillary transfer (please see Protocol 7 or the panel on **ALTERNATIVE PROTOCOL: CAPILLARY TRANSFER BY DOWNWARD FLOW** in Protocol 7).

#### CHECKING THE QUALITY OF PREPARATIONS OF RNA

After electrophoresis of RNA in the presence of ethidium bromide, the 28S and 18S species of rRNA should be clearly visible under UV illumination, as should a more diffuse, fast-migrating band composed of tRNA, 5.8S and 5S rRNA. If the RNA preparation is undegraded, the 28S rRNA band should be stained at approximately twice the intensity of the 18S band and no smearing of either band should be visible. Staining close to the loading well is a sign that DNA is still present in the preparation. mRNA is invisible unless the gel is overloaded. Three other methods can be used to check the integrity of RNA:

- **Analysis of the size of cDNA synthesized using oligo(dT) as a primer.** Radioactive cDNA is synthesized in a pilot first-strand cDNA reaction. cDNA synthesized from mammalian mRNA should run as a continuous smear from ~600 bases to >5 kb. The bulk of the radioactivity should lie between 1.5 kb and 2 kb, and no bands of cDNA should be visible unless the mRNA was prepared from highly differentiated cells (e.g., reticulocytes and B lymphocytes) that express large quantities of a particular set of proteins.
- **Use of radiolabeled poly(dT) as a probe in a pilot northern hybridization** (Fornace and Mitchell 1986; Hollander and Fornace 1990). Poly(A)<sup>+</sup> RNA will generate an autoradiogram with a continuous smear from 600 bases to >5 kb. The bulk of the radioactivity should lie between 1.5 kb and 2 kb, and, once again, no specific bands of mRNA should be visible unless the mRNA was prepared from cells that express large quantities of specific mRNAs.
- **Use of northern hybridization to detect mRNA of known size expressed from a housekeeping gene.** Glyceraldehyde 3-phosphate dehydrogenase (GAPDH) mRNA, whose size in most mammalian cells is ~1.3 kb, is commonly used to monitor the quality of the RNA. Significant smearing of the band into lower-molecular-weight regions generally indicates that significant degradation of the mRNA populations has occurred. Fuzziness, on the other hand, is a sign of problems with the agarose gel system (e.g., the presence of ions in the glyoxal).

# Protocol 6

---

## Separation of RNA According to Size: Electrophoresis of RNA through Agarose Gels Containing Formaldehyde

**S**AMPLES OF RNA MAY BE DENATURED BY TREATMENT WITH FORMAMIDE and separated by electrophoresis through agarose gels containing formaldehyde. In this method, adapted from Lehrach et al. (1977), Goldberg (1980), Seed (1982a), and Rosen et al. (1990), RNA is fractionated by electrophoresis through an agarose gel containing 2.2 M formaldehyde.

Formaldehyde forms unstable Schiff bases with the single imino group of guanine residues. These adducts maintain RNA in the denatured state by preventing intrastrand Watson-Crick base pairing. Because the Schiff bases are unstable and easily removed by dilution, RNA can be maintained in the denatured state only when formaldehyde is present in the buffer or gel. Formaldehyde, a teratogen, is highly toxic by inhalation and contact with the skin and has been classified as a carcinogen by the Occupational Safety and Health Association (OSHA). Solutions containing formaldehyde should be handled with great care and only in a chemical fume hood.

Agarose gels containing formaldehyde are slimier, less elastic, and more frangible than non-denaturing agarose gels. Great care is required in moving them from one receptacle to another. Nevertheless, formaldehyde-agarose gels remain a popular method of separating RNAs during northern analysis because the denaturant is more easily dissociated than is glyoxal from RNA after electrophoresis. However, the bands of RNA in formaldehyde-agarose gels are often fuzzy and do not match the crisp beauty of bands in glyoxal-agarose gels.

The original protocols for northern analysis used gels with a formaldehyde content of 6% or 2.2 M (Boedtger 1971; Lehrach et al. 1977; Rave et al. 1979). This high concentration of denaturant compensates for loss of formaldehyde by diffusion from the gel into the buffer during electrophoresis. However, this problem can also be avoided by running gels for shorter times at higher voltages (7–10 V/cm, instead of the more usual 2–3 V/cm), which allows the concentration of formaldehyde in the gels to be reduced to 1.1% or 0.66 M (Davis et al. 1986).

At one time, the presence of ethidium bromide was thought to compromise transfer of RNA from formaldehyde gels to membranes and/or to suppress subsequent hybridization (e.g., please see Thomas 1980). These effects, if they exist at all, are now believed to be small in magnitude (Kroczek and Siebert 1990), and many investigators routinely include ethidium bromide in gels containing 0.66 M formaldehyde. However, ethidium bromide should not be included in gels run in the old style, which contain higher concentrations of formaldehyde. When irradiated by UV

light, they emit an eerie pinkish-purple glow that swamps the signal from small amounts of RNA. Better staining can be obtained with very little background fluorescence by heating the samples of RNA with low concentrations of ethidium bromide before loading into the gel (Fourney et al. 1988; Rosen and Villa-Komaroff 1990). As long as the concentration of ethidium bromide does not exceed 50 µg/ml in the sample, the efficiency of transfer and hybridization of the RNA is not significantly affected (KroczeK 1989; KroczeK and Siebert 1990; Ogretmen et al. 1993).

## MATERIALS

▲ **IMPORTANT** Prepare all reagents used in this protocol with DEPC-treated H<sub>2</sub>O (please see the information panel on **HOW TO WIN THE BATTLE WITH RNASE**).

**CAUTION:** Please see Appendix 12 for appropriate handling of materials marked with <!>.

### Buffers and Solutions

Please see Appendix 1 for components of stock solutions, buffers, and reagents. Dilute stock solutions to the appropriate concentrations.

*Ethidium bromide (200 µg/ml)* <!>

Prepare in DEPC-treated H<sub>2</sub>O <!>.

*Formaldehyde* <!>

Formaldehyde is supplied as a 37–40% w/v (12.3 M) solution that may contain a stabilizer such as methanol (10–15%). Formaldehyde oxidizes readily to formic acid when exposed to air. If the pH of the formaldehyde solution is acidic (<pH 4.0) or if the solution is yellow, the stock solution should be deionized by treatment with a mixed bed resin, such as Bio-Rad AG-501-X8 or Dowex XG8 before use.

*Formamide* <!>

Purchase a distilled-deionized preparation of this reagent and store in small aliquots under nitrogen at –20°C. Alternatively, reagent-grade formamide can be deionized as described in Appendix 1.

*10× Formaldehyde gel-loading buffer*

50% glycerol (diluted in DEPC-treated H<sub>2</sub>O)  
10 mM EDTA (pH 8.0)  
0.25% (w/v) bromophenol blue  
0.25% (w/v) xylene cyanol FF

*10× MOPS electrophoresis buffer*

0.2 M MOPS (pH 7.0) <!>  
20 mM sodium acetate  
10 mM EDTA (pH 8.0)

Dissolve 41.8 g of MOPS (3-[*N*-morpholino]propanesulfonic acid) in 700 ml of sterile DEPC-treated H<sub>2</sub>O. Adjust the pH to 7.0 with 2 N NaOH. Add 20 ml of DEPC-treated 1 M sodium acetate and 20 ml of DEPC-treated 0.5 M EDTA (pH 8.0). Adjust the volume of the solution to 1 liter with DEPC-treated H<sub>2</sub>O. Sterilize the solution by filtration through a 0.45-µm Millipore filter, and store it at room temperature protected from light. The buffer yellows with age if it is exposed to light or is autoclaved. Straw-colored buffer works well, but darker buffer does not.

## Gels

*Agarose gel containing 2.2 M formaldehyde*

To prepare 100 ml of a 1.5% agarose gel containing 2.2 M formaldehyde, add 1.5 g of agarose to 72 ml of sterile H<sub>2</sub>O. Dissolve the agarose by boiling in a microwave oven. Cool the solution to 55°C and add 10 ml of 10× MOPS electrophoresis buffer and 18 ml of deionized formaldehyde. In a chemical fume hood, cast an agarose gel with slots formed by a 3-mm comb with at least four more teeth than the number of RNA samples under test. These extra lanes are used for RNA size markers and running dyes (please see Step 4). Allow the gel to set for at least 1 hour at room temperature. As soon as the agarose has set, cover the gel with Saran Wrap until the samples are ready to be loaded.

A 1.5% agarose gel is suitable for resolving RNAs in the 0.5–8.0-kb size range. Larger RNAs should be separated on gels cast with 1.0% or 1.2% agarose (Lehrach et al. 1977; Miller 1987).

## Nucleic Acids and Oligonucleotides

### RNA samples

Samples of total or poly(A)<sup>+</sup> RNA should consist of up to 20 µg of RNA in a volume of 1–2 µl. Equivalent amounts of the RNA samples to be analyzed are removed from storage (please see the panel on **STORAGE OF RNA** in Protocol 1). Precipitate the RNA with ethanol and dissolve it in an appropriate volume of sterile, DEPC-treated H<sub>2</sub>O.

The presence of salts or SDS in the samples or loading of >20 µg of RNA per lane can cause smearing of the RNA during electrophoresis.

### RNA size markers

DNA and RNA migrate at different rates through agarose gels containing formaldehyde, with RNA migrating faster than DNA of equivalent size (Wicks 1986). Although DNA markers are preferable because they run as sharp bands, they cannot readily be used to measure the absolute size of unknown RNAs. We therefore recommend using RNA ladders (e.g., from Life Technologies) that contain RNAs of 9.49, 7.46, 4.40, 2.37, 1.35, and 0.24 kb in length. This allows the markers to be used as sentinels to detect RNase contamination or other problems that may occur during electrophoresis. Please see the Introduction to Northern Hybridization preceding Protocol 5.

## Special Equipment

### Equipment for horizontal electrophoresis

A particular electrophoresis apparatus should be reserved specifically for RNA analysis. Clean electrophoresis tanks and combs used for electrophoresis of RNA (Protocols 5 and 6) with detergent solution, rinse in H<sub>2</sub>O, dry with ethanol, and then fill with a solution of 3% H<sub>2</sub>O<sub>2</sub>. After 10 minutes at room temperature, rinse the electrophoresis tanks and combs thoroughly with H<sub>2</sub>O treated with 0.1% DEPC.

Because the pH of the electrophoresis buffer changes during the run, set up the electrophoresis tank so that the buffer circulates continuously from one chamber to the other via a peristaltic pump. Alternatively, transfer the buffer manually every hour or so from one buffer chamber to the other.

### Ruler, transparent

Water bath preset to 55°C

## METHOD

1. Set up the denaturation reaction. In sterile microfuge tubes mix:

RNA (up to 20 µg)	2.0 µl
10x MOPS electrophoresis buffer	2.0 µl
formaldehyde	4.0 µl
formamide	10.0 µl
ethidium bromide (200 µg/ml)	1.0 µl

As much as 20 µg of RNA may be analyzed in each lane of the gel. Abundant mRNAs (0.1% or more of the mRNA population) can usually be detected by northern analysis of 10 µg of total cellular RNA. For detection of rare RNAs, at least 1.0 µg of poly(A)<sup>+</sup> RNA should be applied to each lane of the gel. Samples containing RNA size markers should be prepared in the same way as the RNA samples under test.

2. Close the tops of the microfuge tubes, and incubate the RNA solutions for 60 minutes at 55°C. Chill the samples for 10 minutes in ice water, and then centrifuge them for 5 seconds to deposit all of the fluid in the bottom of the microfuge tubes.  
Many investigators prefer to incubate the RNA solutions for 10 minutes at 85°C.
3. Add 2 µl of 10x formaldehyde gel-loading buffer to each sample and return the tubes to an ice bucket.
4. Install the agarose/formaldehyde gel in a horizontal electrophoresis box. Add sufficient 1x MOPS electrophoresis buffer to cover the gel to a depth of ~1 mm. Run the gel for 5 minutes

at 5 V/cm, and then load the RNA samples into the wells of the gel, leaving the two outermost lanes on each side of the gel empty. Load the RNA size standards in the outside lanes of the gel.

5. Run the gel submerged in 1x MOPS electrophoresis buffer at 4–5 V/cm until the bromophenol blue has migrated ~8 cm (4–5 hours).

Using higher voltages during electrophoresis leads to smearing of bands.

Because the pH of the electrophoresis buffer changes during the run, set up the electrophoresis tank so that the buffer circulates continuously from one chamber to the other via a peristaltic pump. Alternatively, transfer the buffer manually every hour or so from one buffer chamber to the other.

6. Visualize the RNAs by placing the gel on a piece of Saran Wrap on a UV transilluminator. Align a transparent ruler with the stained gel and photograph under UV illumination.

Please see the panel on **CHECKING THE QUALITY OF PREPARATIONS OF RNA** at the end of Protocol 5.

7. Use the photograph to measure the distance from the loading well to each of the bands of RNA. Plot the  $\log_{10}$  of the size of the fragments of RNA against the distance migrated. Use the resulting curve to calculate the sizes of the RNA species detected by blot hybridization.
8. Proceed with immobilization of RNA onto a solid support by upward or downward capillary transfer (please see Protocol 7 or the panel on **ALTERNATIVE PROTOCOL: CAPILLARY TRANSFER BY DOWNWARD FLOW** at the end of Protocol 7).

# Protocol 7

---

## Transfer and Fixation of Denatured RNA to Membranes

**I**N MOST CASES, FRACTIONATION OF RNA BY AGAROSE GEL ELECTROPHORESIS is but a prelude to hybridization of the fractionated population to specific labeled probes that detect particular target mRNAs. RNA is first transferred from an agarose gel to a two-dimensional support, usually a nylon membrane.

As discussed in the Introduction to Northern Hybridization, investigators in many cases have a choice of solvents and membranes to be used for transfer, and more than one option for attaching the transferred RNA tightly to the membrane. In our hands, the best northern blots are obtained following transfer of RNA from gels to nylon membranes at neutral or alkaline pH.

### **TRANSFER TO POSITIVELY CHARGED NYLON MEMBRANES AT ALKALINE PH**

---

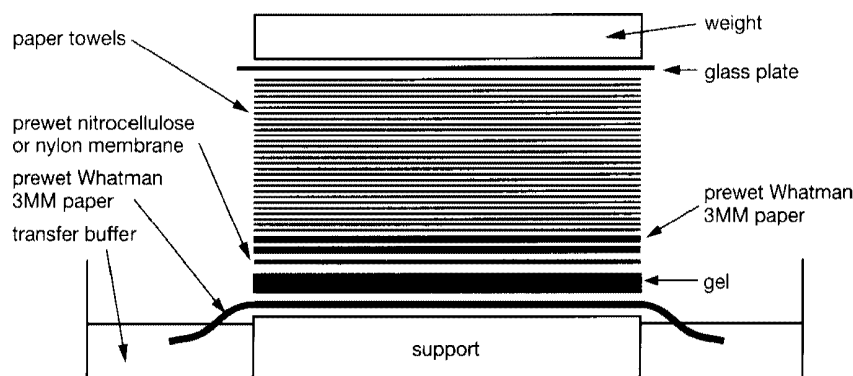
Because charged nylon membranes retain nucleic acids in alkaline solution (Reed and Mann 1985), RNA can be efficiently transferred from agarose gels in 8.0 mM NaOH with 3 M NaCl (Chomczynski and Mackey 1994). Transfer under these conditions partially hydrolyzes the RNA and thereby increases the speed and efficiency of transfer of large (>2.3 kb) RNAs. Because RNA transferred in alkaline solution becomes covalently fixed to the charged nylon membrane, there is no need to bake the membrane or to expose it to UV irradiation before hybridization.

Alkaline transfer is not free of problems: It sometimes generates a high level of background hybridization, especially when RNA probes are used. Extended exposure of charged nylon membranes to alkaline solutions (>6 hours) exacerbates the problem. This shortcoming can sometimes be overcome by decreasing the transfer time and by using increased amounts of blocking agents in the prehybridization and hybridization steps. In addition, there are reports of variability in the strength of the hybridization signal generated by RNA after alkaline transfer. This variability may be related to the switch by manufacturers to nylon 66 membranes, rather than the original nylon 6 membranes, with which alkaline transfer was first described (Reed and Mann 1985).

### **TRANSFER TO UNCHARGED NYLON MEMBRANES AT NEUTRAL PH**

---

Transfer to uncharged nylon membranes is carried out at neutral pH, usually in 10x or 20x SSC. The RNA is then covalently linked to the matrix by the traditional method of baking under vac-



**FIGURE 7-2 Upward Capillary Transfer**

Capillary transfer of nucleic acids from an agarose gel to solid supports is achieved by drawing the transfer buffer from the reservoir upward through the gel into a stack of paper towels. The nucleic acid is eluted from the gel by a moving stream of buffer and is deposited onto a nitrocellulose filter or nylon membrane. A weight applied to the top of the paper towels helps to ensure a tight connection between the layers of material used in the transfer system.

uum for 2 hours, by heating in a microwave oven for 2–3 minutes (Angeletti et al. 1995), or by exposing the nylon membrane to UV irradiation at 254/312 nm. Most investigators agree with Khandjian (1987) that RNA immobilized on nylon membranes by UV irradiation generates more intense signals in northern hybridization than RNA immobilized by baking.

This protocol presents the steps involved in the transfer of RNA from an agarose gel to a membranous support, facilitated by the upward flow of buffer (please see Figure 7-2), followed by various methods for fixation of the RNA to the membrane in preparation for hybridization. An alternative method for transfer by downward capillary flow is given in the panel on **ALTERNATIVE PROTOCOL: CAPILLARY TRANSFER BY DOWNWARD FLOW** at the end of this protocol.

## MATERIALS

▲ **IMPORTANT** Prepare all reagents used in this protocol with DEPC-treated H<sub>2</sub>O (please see the information panel on **HOW TO WIN THE BATTLE WITH RNASE**).

**CAUTION:** Please see Appendix 12 for appropriate handling of materials marked with <!.>.

## Buffers and Solutions

Please see Appendix 1 for components of stock solutions, buffers, and reagents. Dilute stock solutions to the appropriate concentrations.

*Ammonium acetate (0.1 M) with 0.5 µg/ml ethidium bromide <!.>*

Optional, please see Step 13.

*Methylene blue solution*

0.02% (w/v) methylene blue (Sigma, 89% pure) in 0.3 M sodium acetate (pH 5.5).

*Soaking solution*

For charged membranes, use 0.01 N NaOH <!.> combined with 3 M NaCl; for uncharged membranes, use 0.05 N NaOH.

*0.2× SSC with 1% (w/v) SDS*

*20× SSC*

*Transfer buffer*

For alkaline transfers to charged membranes, use 0.01 N NaOH with 3 M NaCl; for neutral transfers to uncharged membranes, use 20× SSC.

## Nucleic Acids and Oligonucleotides

RNA sample, fractionated through an agarose gel  
Prepared as described in Protocol 5 or 6 of this chapter.

## Special Equipment

Blotting Paper (Schleicher & Schuell GB002 or Sigma P 9039)

Cross-linking device (e.g., Stratalinker, Stratagene; GS Gene Linker, Bio-Rad) or Microwave oven or Vacuum oven

Glass baking dish

Nylon membranes, either uncharged or positively charged

Plexiglas or glass plate to support the gel during transfer

Scalpel blade

Thick blotting paper (e.g., Whatman 3MM, Schleicher & Schuell GB004, or Sigma QuickDraw)

Visible-spectrum light box

Weight (400 g)

Yellow filter for photography

## METHOD

---

### Preparation of the Gel for Transfer

1. (Optional) Partially hydrolyze the RNA sample, fractionated through agarose, by soaking the gel in the appropriate soaking solution as described below.

Treating the gel with NaOH after electrophoresis can enhance subsequent transfer of the partially hydrolyzed RNA to nylon membranes, either charged or uncharged. This treatment is especially useful if the gel contains >1% agarose or is >0.5-cm thick or if the RNA to be analyzed is >2.5 kb in length.

#### FOR TRANSFER TO UNCHARGED NYLON MEMBRANES

- a. Rinse the gel with DEPC-treated H<sub>2</sub>O.
- b. Soak the gel for 20 minutes in 5 gel volumes of 0.05 N NaOH.
- c. Transfer the gel into 10 gel volumes of 20× SSC for 40 minutes.
- d. Without delay, proceed directly with Step 2 to transfer the partially hydrolyzed RNA to an uncharged nylon membrane by capillary action.

#### FOR TRANSFER TO CHARGED NYLON MEMBRANES

- a. Rinse the gel with DEPC-treated H<sub>2</sub>O.
  - b. Soak the gel for 20 minutes in 5 gel volumes of 0.01 N NaOH/3 M NaCl.
  - c. Without delay, proceed directly with Step 2 to transfer the partially hydrolyzed RNA to a positively charged nylon membrane by capillary action.
2. Move the gel containing fractionated RNA to a glass baking dish, and use a sharp scalpel to trim away unused areas of the gel. Cut along the slot line to allow the top of the trimmed gel to be aligned with the top of the membrane during transfer. Cut off a small triangular piece from the bottom left-hand corner of the gel to simplify orientation during the succeeding operations.



3. Place a piece of thick blotting paper on a sheet of Plexiglas or a glass plate to form a support that is longer and wider than the trimmed gel. Make sure that the ends of the blotting paper drape over the edges of the plate. Place the support inside a large baking dish.  
Neoprene stoppers can be used to elevate the support plate above the buffer reservoir.
4. Fill the dish with the appropriate transfer buffer (0.01 N NaOH/3 M NaCl for positively charged membranes, and 20x SSC for uncharged membranes) until the level of the liquid reaches almost to the top of the support. When the blotting paper on the top of the support is thoroughly wet, smooth out all air bubbles with a glass rod or pipette.  
Alkaline transfer buffer (0.01 N NaOH, 3 M NaCl) is used to transfer RNA to positively charged nylon membranes. Neutral transfer buffer (20x SSC) is used to transfer RNA to uncharged nylon membranes.

### Preparation of the Membrane for Transfer

5. Use a fresh scalpel or a paper cutter to cut a piece of the appropriate nylon membrane ~1 mm larger than the gel in both dimensions.  
Use appropriate gloves and blunt-ended forceps (e.g., Millipore forceps) to handle the membrane. A nylon membrane that has been touched by greasy hands will not wet!
6. Float the nylon membrane on the surface of a dish of deionized H<sub>2</sub>O until it wets completely from beneath, and then immerse the membrane in 10x SSC for at least 5 minutes. Use a clean scalpel blade to cut a corner from the membrane to match the corner cut from the gel.  
The rate at which different batches of nylon membranes wet can vary. If the membrane is not saturated after floating for several minutes on water, it should be replaced with a new membrane; the transfer of RNA to an unevenly wetted membrane is unreliable.

### Assembly of the Transfer System and Transfer of the RNA (Please See Figure 7-2)

7. Carefully place the gel on the support in an inverted position so that it is centered on the wet blotting paper.  
Make sure that there are no air bubbles between the thick blotting paper and the gel.
8. Surround, but do not cover, the gel with Saran Wrap or Parafilm.  
This barrier prevents liquid from flowing directly from the reservoir to paper towels placed on the top of the gel. If these towels are not precisely stacked, they tend to droop over the edge of the gel and may touch the support. This type of short-circuiting is a major reason for inefficient transfer of RNA from the gel to the membrane.
9. Wet the top of the gel with the appropriate transfer buffer (please see Step 4). Place the wet nylon membrane on top of the gel so that the cut corners are aligned. One edge of the membrane should extend just beyond the edge of the line of slots at the top of the gel.  
**▲ IMPORTANT** Do not move the membrane once it has been applied to the surface of the gel. Make sure that there are no air bubbles between the membrane and the gel.
10. Wet two pieces of thick blotting paper (cut to exactly the same size as the gel) in the appropriate transfer buffer and place them on top of the wet nylon membrane. Smooth out any air bubbles with a glass rod.
11. Cut or fold a stack of paper towels (5–8 cm high) just smaller than the blotting papers. Place the towels on the blotting papers. Put a glass plate on top of the stack and weigh it down with a 400-g weight (please see Figure 7-2).
12. Allow upward transfer of RNA to occur for no more than 4 hours in neutral transfer buffer and ~1 hour in alkaline transfer buffer.

13. Dismantle the capillary transfer system. Mark the positions of the slots on the membrane with a ballpoint pen through the gel. Transfer the membrane to a glass tray containing ~300 ml of 6x SSC at 23°C. Place the tray on a platform shaker and agitate the membrane very slowly for 5 minutes.

To assess the efficiency of transfer of RNA, rinse the gel briefly in several changes of H<sub>2</sub>O and then stain it for 45 minutes in a solution of ethidium bromide (0.5 µg/ml in 0.1 M ammonium acetate). Examine and photograph the stained gel under UV illumination.

14. Remove the membrane from the 6x SSC and allow excess fluid to drain away. Lay the membrane, RNA side upward, on a dry sheet of blotting paper for a few minutes.

### Staining of the RNA and Fixation of the RNA to the Membrane

The order of steps during staining and fixation depends on the type of transfer, the type of membrane, and the method of fixation. Because alkaline transfer results in covalent attachment of RNA to positively charged nylon membranes, there is no need to fix the RNA to the membrane before staining. RNA transferred to uncharged nylon membranes in neutral transfer buffer should be stained and then fixed to the membrane by baking under vacuum or heating in a microwave oven. If the RNA is to be cross-linked to the membrane by UV irradiation, then the staining step should follow fixation (please see Table 7-4).

RNA that has been transferred to a nylon membrane can be visualized by staining with methylene blue (Herrin and Schmidt 1988). This simple method allows monitoring of the integrity of the RNA, estimation of the efficiency of the transfer process, and location of the positions of the major RNAs (usually rRNAs) on the membrane. If the RNA is to be fixed by UV irradiation, proceed first to Step 16.

15. Stain the membrane.
  - a. Transfer the damp membrane to a glass tray containing methylene blue solution. Stain the membrane for just enough time to visualize the rRNAs (~3–5 minutes).
  - b. Photograph the stained membrane under visible light with a yellow filter.
  - c. After photography, destain the membrane by washing in 0.2x SSC and 1% (w/v) SDS for 15 minutes at room temperature.

Fix the RNA to the membrane if appropriate (please see Table 7-4), and proceed directly to hybridization (Protocol 8). Any membranes not used immediately in hybridization reactions should be thoroughly dry, wrapped loosely in aluminum foil or blotting paper, and stored at room temperature, preferably under vacuum.

16. Fix the RNA to the uncharged nylon membrane.

**TABLE 7-4 Sequence of Staining RNA and Fixing to the Membrane**

TYPE OF MEMBRANE	METHOD OF FIXATION	ORDER OF STEPS
Positively charged nylon	alkaline transfer	1. Stain with methylene blue. 2. Proceed to prehybridization.
Uncharged nylon or positively charged nylon (nonalkaline transfer)	UV irradiation (please see Step 16 for details)	1. Fix the RNA by UV irradiation. 2. Stain with methylene blue. 3. Proceed to prehybridization.
Uncharged nylon or positively charged nylon (nonalkaline transfer)	baking in vacuum oven or microwave oven (please see Step 16 for details)	1. Stain with methylene blue. 2. Bake the membrane. 3. Proceed to prehybridization.

**TO FIX BY BAKING**

- Allow the membrane to dry in air and then bake for 2 hours between two pieces of blotting paper under vacuum at 80°C in a vacuum oven.

or

- Place the damp membrane on a dry piece of blotting paper and heat for 2–3 minutes at full power in a microwave oven (750–900 W).

Proceed directly to hybridization (Protocol 8). Any membranes not used immediately in hybridization reactions should be thoroughly dry, wrapped loosely in aluminum foil or blotting paper, and stored at room temperature, preferably under vacuum.

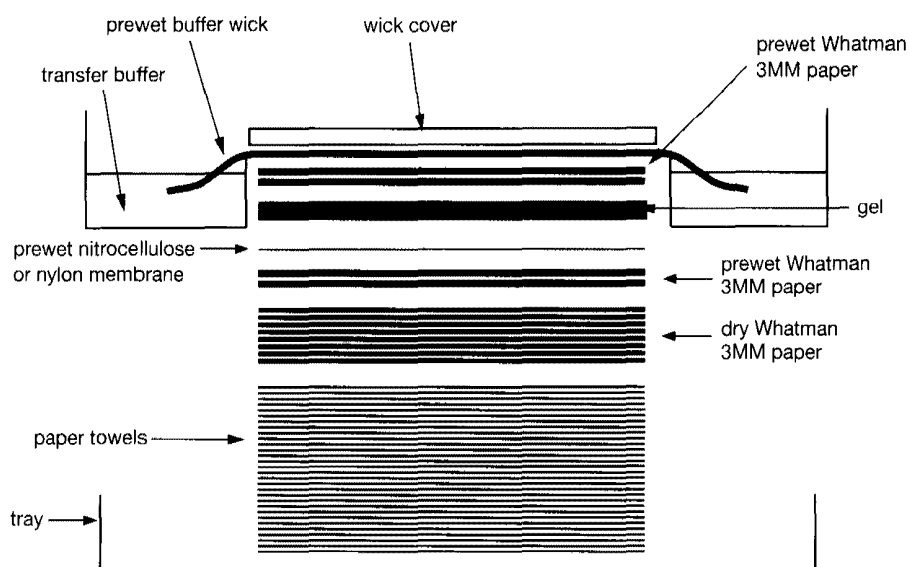
**TO CROSS-LINK BY UV IRRADIATION**

- Place the damp, unstained membrane on a piece of dry blotting paper and irradiate at 254 nm for 1 minute 45 seconds at 1.5 J/cm<sup>2</sup>.

This step is best accomplished in a commercial device according to the manufacturer's instructions.

- After irradiation, stain the membrane with methylene blue as described in Step 15.

Proceed directly to hybridization (Protocol 8). Any membranes not used immediately in hybridization reactions should be thoroughly dry, wrapped loosely in aluminum foil or blotting paper, and stored at room temperature, preferably under vacuum.



**FIGURE 7-3 Downward Capillary Transfer**

In this arrangement, capillary transfer of nucleic acids from an agarose gel to solid support is achieved by drawing the transfer buffer from the reservoir downward through the gel into a stack of paper towels. The nucleic acid is eluted from the gel by a moving stream of buffer and is deposited onto a nitrocellulose filter or nylon membrane.

**ALTERNATIVE PROTOCOL: CAPILLARY TRANSFER BY DOWNWARD FLOW**

Downward capillary transfer can be used as an alternative to upward transfer. This approach, adapted from Chomczynski and Mackey (1994), results in faster transfer times and increased efficiency of transfer for longer RNA species. This alternative protocol presents the steps involved in the transfer of RNA from an agarose gel to a membranous support, facilitated by the downward flow of buffer (please see Figure 7-3).

**CAUTION:** Please see Appendix 12 for appropriate handling of materials marked with <!.>.

**Method**

1. Prepare the gel for transfer of RNA, as described in Steps 1 and 2 of the main protocol (Protocol 7).
2. Make an ~3-cm stack of disposable paper towels. Place four pieces of blotting paper on top of the stack. The stack should exceed the size of the trimmed gel by 1–2 cm in each dimension.
3. Use a fresh scalpel or a paper cutter to cut a piece of the appropriate nylon membrane ~1 mm larger than the gel in both dimensions.  
Use appropriate gloves and blunt-ended forceps (e.g., Millipore forceps) to handle the membrane. A nylon membrane that has been touched by greasy hands will not wet!
4. Float the nylon membrane on the surface of a dish of deionized H<sub>2</sub>O until it wets completely from beneath, and then immerse the membrane in transfer buffer for at least 5 minutes. Use a clean scalpel to cut a corner from the membrane to match the corner cut from the gel.

The rate at which different batches of nylon membranes wet can vary. If the membrane is not saturated after floating for several minutes on H<sub>2</sub>O, it should be replaced with a new membrane, as the transfer of RNA to an unevenly wetted membrane is unreliable.

Alkaline transfer buffer (0.01 N NaOH <!.>, 3 M NaCl) is used to transfer RNA to positively charged nylon membranes. Neutral transfer buffer (10x SSC) is used to transfer RNA to uncharged nylon membranes.

5. Cut four pieces of blotting paper to the same size as the gel and wet them thoroughly with transfer buffer. Cut two larger pieces of blotting paper that will be used to connect the top of the stack to the buffer reservoirs, as shown in Figure 7-3.

**Assembly of the Transfer System and Transfer of the RNA (Please See Figure 7-3)**

6. Working quickly, align one of the sheets of wet blotting paper on top of the stack. Then place the nylon membrane exactly on top of the wet blotting papers. Place the trimmed agarose gel on top of the membrane, so that the cut corners are aligned. Surround, but do not cover, the gel with Saran Wrap or Parafilm.  
▲ **IMPORTANT** Do not move the gel once it has been placed on top of the membrane. Make sure that there are no air bubbles between the membrane and the gel.
7. Wet the top surface of the gel with transfer buffer and immediately cover it with the three remaining pieces of wet blotting paper. Connect the stack to the reservoirs with the two larger pieces of wet blotting paper.
8. Place a sheet of Plexiglas or a thin glass plate on top of the stack to prevent evaporation.
9. Allow downward transfer of RNA to occur for no more than 4 hours in neutral transfer buffer and ~1 hour in alkaline transfer buffer.
10. Continue with Steps 13 through 16 of the main protocol (Protocol 7).

# Protocol 8

---

## Northern Hybridization

**R**NA SAMPLES THAT HAVE BEEN TRANSFERRED AND FIXED TO A MEMBRANE (please see Protocol 7 or the panel on **ALTERNATIVE PROTOCOL: CAPILLARY TRANSFER BY DOWNWARD FLOW** in Protocol 7) may be hybridized with a specific probe to locate the RNA species of interest. Any one of a large number of methods can be used to label and detect probes, at the discretion of the investigator; please see Chapters 9 and 10 for methods to prepare probes. After treating the membrane with blocking agents that suppress nonspecific absorption of the probe, the membrane is incubated under conditions that favor hybridization of the labeled probe to the immobilized target RNA. The membrane is then washed extensively to remove adventitiously bound probe and finally manipulated to yield an image of the distribution of the tightly bound probe on the membrane. After analysis of the hybridization results, the probe may be stripped from the membrane, and the membrane used again in another hybridization experiment (please see the panel on **STRIPPING NORTHERN BLOTS OF RADIOACTIVITY** at the end of this protocol). Table 7-5 describes how to deal with factors that cause background interference in northern hybridization.

### MATERIALS

---

▲ **IMPORTANT** Prepare all reagents used in this protocol with DEPC-treated H<sub>2</sub>O (please see the information panel on **HOW TO WIN THE BATTLE WITH RNASE**).

**CAUTION:** Please see Appendix 12 for appropriate handling of materials marked with <!>.

### Buffers and Solutions

Please see Appendix 1 for components of stock solutions, buffers, and reagents. Dilute stock solutions to the appropriate concentrations.

#### *Prehybridization solution*

0.5 M sodium phosphate (pH 7.2)

7% (w/v) SDS

1 mM EDTA (pH 7.0)

Background is often a problem when using nylon membranes. Of the large number of hybridization buffers that have been described in the literature, those containing high concentrations of SDS are the most effective at suppressing background while preserving high sensitivity. These buffers are modifications (e.g., please see Kevil et al. 1997; Mahmoudi and Lin 1989) of the hybridization buffer first described by Church and Gilbert (1984).

SSC (0.5x, 1x, and 2x) with 0.1% (w/v) SDS

SSC (0.1x and 0.5x) with 0.1% (w/v) SDS

Optional, please see Step 4.

## Nucleic Acids and Oligonucleotides

### *Probe DNA or RNA ( $>2 \times 10^8$ cpm/ $\mu$ g) $<!\>$*

Prepare and radiolabel the probes in vitro to high specific activity with  $^{32}\text{P}$ , as described in Chapter 9.

High-specific-activity ( $>2 \times 10^8$  cpm/ $\mu$ g) strand-specific probes (either DNA or RNA) can detect mRNAs that are present at low to medium abundance. The highest sensitivity in northern blotting is obtained from single-stranded probes — either DNA or RNA — radiolabeled in vitro to high specific activity with  $^{32}\text{P}$  ( $>2 \times 10^8$  cpm/ $\mu$ g). Double-stranded DNA probes are two to three times less sensitive than single-stranded probes.

### *RNA, immobilized on membrane*

Prepared as described in Protocol 7 or the panel on **ALTERNATIVE PROTOCOL: CAPILLARY TRANSFER BY DOWNWARD FLOW** in Protocol 7.

## Special Equipment

*Blotting paper (Whatman 3MM or equivalent)*

*Boiling water bath*

*Water bath preset to 68°C*

*Water bath preset to the hybridization temperature*

Please see Step 3.

## METHOD

1. Incubate the membrane for 2 hours at 68°C in 10–20 ml of prehybridization solution.
 

Any number of systems for hybridization of northern blots have been described ranging from efficient but expensive commercial rotating wheels to a variety of economical homemade devices including plastic lunch boxes, sandwiches of filter paper (Jones and Jones 1992), and heat-sealed plastic bags (Sears Seal-A-Meal bags are still the best). With practice, all of these gadgets can be made to work reasonably well, and the choice among them is generally a matter of personal preference. Commercial rotating wheels, however, have one clear advantage: They are less prone to leak when using hybridization buffers with high concentrations of SDS. Because plastic bags and boxes containing such buffers are very difficult to seal, the risk of leaks and contamination with radioactivity is increased.
2. If using a double-stranded probe, denature the  $^{32}\text{P}$ -labeled double-stranded DNA by heating for 5 minutes at 100°C. Chill the probe rapidly in ice water.
 

Alternatively, denature the probe by adding 0.1 volume of 3 N NaOH. After 5 minutes at room temperature, transfer the probe to ice water and add 0.05 volume of 1 M Tris-Cl (pH 7.2) and 0.1 volume of 3 N HCl. Store the probe in ice water until it is needed.

Single-stranded probes need not be denatured.
3. Add the denatured or single-stranded radiolabeled probe directly to the prehybridization solution. Continue incubation for 12–16 hours at the appropriate temperature.
 

To detect low-abundance mRNAs, use at least 0.1  $\mu$ g of probe whose specific activity exceeds  $2 \times 10^8$  cpm/ $\mu$ g. Low-stringency hybridization, in which the probe is not homologous to the target gene, is best carried out at lower temperatures (37–42°C) in a hybridization buffer containing 50% deionized formamide, 0.25 M sodium phosphate (pH 7.2), 0.25 M NaCl, and 7% SDS.

For additional details on conditions for hybridization of probes to nucleic acids immobilized on solid supports, please see Chapter 6, Protocol 10.
4. After hybridization, remove the membrane from the plastic bag and transfer it as quickly as possible to a plastic box containing 100–200 ml of 1x SSC, 0.1% SDS at room temperature. Place the closed box on a platform shaker and agitate the fluid gently for 10 minutes.
 

▲ **IMPORTANT** Do not allow the membrane to dry out at any stage during the washing procedure.

Increase the concentration of SDS in the washing buffer to 1% if single-stranded probes are used.

Following low-stringency hybridization in formamide-containing buffers, rinse the membrane in 2x SSC at 23°C and then successively wash in 2x SSC, 0.5x SSC with 0.1% SDS, and 0.1x SSC with 0.1% SDS for 15 minutes each at 23°C. A final wash containing 0.1x SSC and 1% SDS is carried out at 50°C.

5. Transfer the membrane to another plastic box containing 100–200 ml of 0.5x SSC, 0.1% SDS, prewarmed to 68°C. Agitate the fluid gently for 10 minutes at 68°C.
6. Repeat the washing in Step 5 twice more for a total of three washes at 68°C.
7. Dry the membrane on blotting paper and establish an autoradiograph by exposing the membrane for 24–48 hours to X-ray film (Kodak XAR-5 or equivalent) at –70°C with an intensifying screen (please see Appendix 9). Tungstate-based intensifying screens are more effective than the older rare-earth screens. Alternatively, an image of the membrane can be obtained by scanning in a phosphorimager.

#### **STRIPPING NORTHERN BLOTS OF RADIOACTIVITY**

To strip radiolabeled probes from nylon membranes containing immobilized RNA, incubate the membrane for 1–2 hours in either

- a large volume of 10 mM Tris-Cl (pH 7.4), 0.2% SDS, preheated to 70–75°C.
- a large volume of 50% deionized formamide, 0.1x SSC, 0.1% SDS preheated to 68°C.

**TABLE 7-5 Background in Southern and Northern Hybridizations and How to Avoid It**

SYMPTOM	CAUSE	POTENTIAL SOLUTIONS
Blotchy background over the entire membrane.	Incomplete blocking during prehybridization.	Prehybridize for longer periods of time.
	Drying out of membrane during experiment.	Be vigilant in keeping membrane wet at all times.
	SDS precipitated from any of the solutions used in the experiment.	Prepare solutions at room temperature, prewarm to 37°C, then add SDS; do not allow SDS to precipitate at any time. Reheating a solution from which SDS has precipitated will sometimes yield a clean result.
	Use of 10% dextran sulfate in hybridization experiments.	This polymer is added to induce macromolecular crowding and thus to enhance the rate of hybridization. Except in rare instances (in situ hybridizations or using subtracted probes), dextran sulfate can be left out of most hybridization solutions. Use of large volumes of washing solutions are required to remove this viscous compound, which if left on the membrane after hybridization, traps probe and produces background.
	Paper towels become completely wet during capillary transfer (see Protocol 7).	Use a larger stack of towels or remove wet towels and replace with dry towels during transfer procedure.
	Use of charged nylon membranes and solutions containing low SDS.	Switch to uncharged nylon membranes. Increase the concentration of SDS to 1% (w/v) at all steps. Hybridization buffers containing high concentrations of SDS are the most effective in suppressing background while preserving high sensitivity. These buffers are modifications (e.g., please see Mahmoudi and Lin 1989; Kevil et al. 1997) of the hybridization buffer first described by Church and Gilbert (1984).
	Use of impure (yellow) formamide.	Purify formamide on Dowex XG-8 before use (see Appendix 1).
Haloes over the entire membrane.	Use of a plastic film that is permeable to moisture.	Use a better quality film.
	Use of improper blocking reagent.	Do not use BLOTTO for genomic Southern blots. Instead, try 50 µg/ml heparin as blocking reagent (Singh and Jones 1984) or use Church buffer (Church and Gilbert 1984) as both prehybridization and hybridization solution.
	Presence of bubbles in prehybridization/hybridization solutions, failure to agitate membrane.	Prewarm solutions before use. Agitate the membrane.
Background concentrated over the lanes containing nucleic acid.	Improperly denatured carrier DNA.	Reboil the salmon sperm DNA used in the prehybridization/hybridization solutions. Do not allow the heat-denatured DNA to reanneal.
	Use of probes containing poly(T) tracts in northern hybridizations.	Include poly(A) at 1 µg/ml in hybridization solutions.
	Use of RNA probes.	Drastically increase the stringency of hybridization by increasing the concentration of formamide in the hybridization buffer, use 1% SDS in the hybridization buffer, increase the washing temperatures, and decrease the ionic strength of washing buffers (e.g., 0.1× SSC).
Blotchy background appearing on some membranes and not others.	Too many membranes hybridized in the same vessel, not enough volume of prehybridization/hybridization solution.	Increase the volume of the hybridization and washing solutions and/or decrease number of membranes in a hybridization bag or container.
Intense black spots all over membrane.	Use of old radiolabel to prepare probe.	A peppered background is due to <sup>32</sup> P present as inorganic phosphate or pyrophosphate sticking to the membrane. This problem is frequently encountered when using 5'-labeled probes. Do not use old radiolabel in which radiolysis has occurred. Purify the probe by spun-column chromatography, precipitation, or gel electrophoresis before use. Include 0.5% (w/v) sodium pyrophosphate in prehybridization/hybridization solutions.



# Protocol 9

---

## Dot and Slot Hybridization of Purified RNA

**D**OT AND SLOT BLOTTING (KAFATOS ET AL. 1979) ARE TECHNIQUES for immobilizing several preparations of nucleic acids on the same solid support, usually a charged nylon membrane. The concentrations of the target sequence of interest can be estimated by hybridizing the immobilized samples to an appropriate probe. The amounts of target sequence are estimated by comparing the intensity of signals emitted by dots containing the test samples with standards containing known concentrations of the target sequence.

For several years, dot blotting and slot blotting were viewed with disfavor by many investigators chiefly because of variability in the hybridization signal obtained from identical samples applied to the same membrane, especially when analyzing complex populations of RNA or DNA. Although this problem has not been entirely solved (Anchordoguy et al. 1996), the advent of positively charged modified nylon membranes has led to a marked improvement in the sample-to-sample variation (Chomczynski and Qasba 1984). In the case of DNA, purified preparations or alkaline lysates of cells and tissue samples can be loaded onto the membrane under alkaline conditions (Reed and Matthaei 1990).

Dot-blot analysis of RNA is slightly trickier than dot-blotting of DNA. At one stage, investigators experimented with dot- and slot-blotting of crude cytoplasm prepared from freshly harvested or frozen cultured cells or animal tissues (e.g., please see White and Bancroft 1982). However, the results obtained from dot blotting of crude preparations of RNA did not always match those obtained from northern blots of purified RNA (Tsykin et al. 1990). For this reason, dot-blotting and slot-blotting are generally carried out with purified preparations of RNA that have been denatured with glyoxal (McMaster and Carmichael 1977; Carmichael and McMaster 1980) or formaldehyde (Thomas 1980) immediately before they are applied to the membrane (e.g., please see Weydert et al. 1983).

### APPLYING THE SAMPLES TO THE MEMBRANE

---

Although samples of RNA can be applied to the membrane manually with an automatic pipetting device, the spacing and size of the resulting dots are often variable. The resulting images may be misshapen, blurred, and of such uneven character as to defy quantitation. The preferred method of applying samples to a membrane is by vacuum manifold. Many of the commercially available manifolds are supplied with a choice of molds that deposit the samples on the membrane as dots or slots in various geometries. This ensures that the immobilized samples all have the same shape, area, and spacing, which facilitates comparison of the intensity of hybridization.

## STANDARDS

---

To obtain quantitative results, it is essential to include positive and negative controls that have physical properties similar to those of the nucleic acid under test. For example, when analyzing mammalian RNAs, the negative control should consist of RNA from a cell or tissue that is known not to express the target sequences. Positive controls should consist of preparations of RNA mixed with known quantities of RNA standards that are complementary to the probe. These standards and radiolabeled probes are best synthesized *in vitro* from DNA templates that have been cloned into plasmid vectors in which the cloning site is flanked by two different bacteriophage promoters in opposite orientations. Sense-strand RNA for use as a hybridization standard can be synthesized using one promoter; radiolabeled (antisense) probe can be synthesized using the other promoter.

When creating standards, the synthetic sense-strand RNA is mixed with an irrelevant RNA so that the resulting mass is equal to that of the test samples. The irrelevant RNA should be prepared in the same manner as the test RNA. These precautions are necessary to control for the presence of impurities in cytoplasmic RNA that decrease the intensity of the hybridization signal and to control for decreased hybridization efficiency in samples containing large amounts of purified RNA.

## NORMALIZATION

---

To avoid overloading the membrane, not more than 5  $\mu$ g of total RNA should be used in a slot of standard size. As a matter of course, the same amount of RNA is loaded into each slot. However, there is always some uncertainty about the actual amounts of RNA that are retained on the membrane. This problem can be solved by staining the membrane with methylene blue after the RNA has been cross-linked to the positively charged membrane by UV irradiation (please see Protocol 7 and Table 7-5 in Protocol 8). Alternatively, the amount of poly(A)<sup>+</sup> RNA retained on the membrane can be measured by hybridization with radiolabeled oligo(dT) (Harley 1987, 1988). This method is especially useful when loading small amounts of purified poly(A)<sup>+</sup> RNA in each slot.

## MEASURING THE INTENSITY OF THE SIGNAL

---

For many purposes, visual assessment of the intensity of hybridization is sufficient. However, more accurate estimates of the amount of target sequence in each sample can be obtained by densitometric scanning (Brown et al. 1983; Chapman et al. 1983; Ross et al. 1989), direct phosphorimaging, or luminometry (when using chemiluminescent probes) (Matthews et al. 1985). Liquid scintillation counting also provides direct quantitation of the concentration of target DNA. However, this method requires that the sample be cut into pieces and placed in a scintillation fluor, thereby eliminating any possibility of reprobing the dot blots.

This protocol describes the blotting and subsequent hybridization of RNA purified from cells or tissues by one of the methods previously described in Protocols 1 through 4.

## MATERIALS

▲ **IMPORTANT** Prepare all reagents used in this protocol with DEPC-treated H<sub>2</sub>O (please see the information panel on **HOW TO WIN THE BATTLE WITH RNASE**).

**CAUTION:** Please see Appendix 12 for appropriate handling of materials marked with <!.>.

### Buffers and Solutions

Please see Appendix 1 for components of stock solutions, buffers, and reagents. Dilute stock solutions to the appropriate concentrations.

NaOH (10 N) <!.>

*Prehybridization solution*

*RNA denaturation solution*

660 µl of formamide <!.>

210 µl of 37% (w/v) formaldehyde <!.>

130 µl of 10x MOPS electrophoresis buffer (pH 7.0) <!.>

For further details on MOPS electrophoresis buffer, please see Appendix 1.

Formaldehyde is supplied as a 37–40% w/v (12.3 M) solution that may contain a stabilizer such as methanol (10–15%). Formaldehyde oxidizes readily to formic acid when exposed to air. If the pH of the formaldehyde solution is acidic (<pH 4.0) or if the solution is yellow, the stock solution should be deionized by treatment with a mixed bed resin, such as Bio-Rad AG-501-X8 or Dowex XG8 before use.

Purchase a distilled deionized preparation of formamide reagent and store in small aliquots under nitrogen at –20°C. Alternatively, reagent-grade formamide can be deionized as described in Appendix 1.

*0.1x SSC with 0.1% (w/v) SDS*

Please see note to Step 18.

*0.1x SSC with 1% (w/v) SDS*

Optional, please see Step 18.

*0.5x SSC with 0.1% (w/v) SDS*

*1x SSC with 0.1% (w/v) SDS*

*2x SSC*

Optional, please see Step 18.

*20x SSC*

### Nucleic Acids and Oligonucleotides

*RNA test samples, standards and negative controls*

Prepare samples by one of the methods described in Protocols 1 through 4 of this chapter.

All samples should contain the same amount of RNA dissolved in 10 µl of sterile, DEPC-treated H<sub>2</sub>O. Standards are generated by mixing varying quantities of unlabeled sense-strand RNA synthesized in vitro (please see Chapter 9) to aliquots of a "negative" RNA preparation that lacks sequences complementary to the radiolabeled probe.

### Probes

*Probe, radiolabeled and denatured*

Denature just before use as described in Step 2 of Protocol 8.

High-specific-activity (>5 × 10<sup>8</sup> cpm/µg) strand-specific probes (either DNA or RNA) can easily detect mRNAs that are present at medium to high abundance when 5 µg of total cellular RNA is loaded per slot. RNAs of the lowest abundance (1–5 copies/cell) are difficult to detect in dot blots of total mammalian cellular RNA. Such RNAs are best detected by loading >1 µg of purified poly(A)<sup>+</sup> RNA per slot and hybridizing with strand-specific probes of high specific activity (>5 × 10<sup>8</sup> cpm/µg).

### Special Equipment

*Blotting manifold*

Manifolds are available from several commercial sources. Devices for dot blotting are more popular than those for slot blotting, perhaps because, with a dot-blotter, the sample is applied over a larger area, resulting in a more uniform hybridization signal.

Cross-linking device (e.g., Stratalinker, Stratagene; GS Gene Linker, Bio-Rad) or Vacuum oven or Microwave oven

Positively charged nylon membrane

Please see the Introduction to Northern Hybridization (Membranes Used for Northern Hybridization).

Thick blotting paper (e.g., Whatman 3MM, Schleicher & Schuell GB004, or Sigma QuickDraw)

Water bath preset to 68°C

## METHOD

---

### Setting Up the Blotting Manifold

1. Cut a piece of positively charged nylon membrane to a suitable size. Mark the membrane with a soft pencil or ballpoint pen to indicate the orientation. Wet the membrane briefly in H<sub>2</sub>O and soak it in 20× SSC for 1 hour at room temperature.
2. While the membrane is soaking, clean the blotting manifold carefully with 0.1 N NaOH and then rinse it well with sterile H<sub>2</sub>O.
3. Wet two sheets of thick blotting paper with 20× SSC, and place them on top of the vacuum unit of the apparatus.
4. Place the wet nylon membrane on the bottom of the sample wells cut into the upper section of the manifold. Roll a pipette across the surface of the membrane to smooth away any air bubbles trapped between the upper section of the manifold and the nylon membrane.
5. Clamp the two parts of the manifold together, and connect the unit to a vacuum line.
6. Fill all of the slots/dots with 10× SSC, and apply gentle suction until the fluid has passed through the nylon membrane. Turn off the vacuum, and refill the slots with 10× SSC.

### Preparation of the RNA Samples

7. Mix each of the RNA samples (dissolved in 10 µl of H<sub>2</sub>O) with 30 µl of RNA denaturation solution.
8. Incubate the mixture for 5 minutes at 65°C, and then cool the samples on ice.
9. Add an equal volume of 20× SSC to each sample.
10. Apply gentle suction to the manifold until the 10× SSC in the slots has passed through the membrane. Turn off the vacuum.

### Blotting of the RNA Samples and Fixation of the RNA to the Membrane

11. Load all of the samples into the slots, and then apply gentle suction. After all of the samples have passed through the membrane, rinse each of the slots twice with 1 ml of 10× SSC.
12. After the second rinse has passed through the nylon membrane, continue suction for 5 minutes to dry the membrane.
13. Remove the membrane from the manifold, and fix the RNA to the membrane by either UV irradiation, baking, or microwaving, as described in Step 16 of Protocol 7.

Before setting up the prehybridization and hybridization reactions, please see Protocol 8.

## Hybridization and Washing of Immobilized RNA

14. Incubate the membrane for 2 hours at 68°C in 10–20 ml of prehybridization solution in a baking dish or hybridization chamber.
15. Add the denatured radiolabeled probe directly to the prehybridization solution. Continue the incubation for 12–16 hours at the appropriate temperature.

To detect low-abundance mRNAs, use at least 0.1 µg of probe whose specific activity exceeds  $5 \times 10^8$  cpm/µg. Low-stringency hybridization, in which the probe is not homologous to the target gene, is best carried out at lower temperatures (37–42°C) in a hybridization buffer containing 50% deionized formamide, 0.25 M sodium phosphate (pH 7.2), 0.25 M NaCl, and 7% SDS.
16. After hybridization, remove the membrane from the plastic bag and transfer it as quickly as possible to a plastic box containing 100–200 ml of 1× SSC, 0.1% SDS at room temperature. Place the closed box on a platform shaker and agitate the fluid gently for 10 minutes.

**▲ IMPORTANT** Do not allow the membrane to dry out at any stage during the washing procedure. Increase the concentration of SDS in the washing buffer to 1% if single-stranded probes are used. Following low-stringency hybridization in formamide-containing buffers, rinse the membrane in 2× SSC at 23°C and then successively wash in 2× SSC, 0.5× SSC with 0.1% SDS, and 0.1× SSC with 0.1% SDS for 15 minutes each at 23°C. A final wash containing 0.1× SSC and 1% SDS is carried out at 50°C.
17. Transfer the membrane to another plastic box containing 100–200 ml of 0.5× SSC, 0.1% SDS, prewarmed to 68°C. Agitate the fluid gently for 10 minutes at 68°C.
18. Repeat the washing in Step 17 twice more for a total of three washes at 68°C.
19. Dry the membrane on filter paper and establish an autoradiograph by exposing the membrane for 24–48 hours to X-ray film (Kodak XAR-5 or equivalent) at –70°C with an intensifying screen (please see Appendix 9). Tungstate-based intensifying screens are more effective than the older rare-earth screens. Alternatively, an image of the membrane can be obtained by scanning in a phosphorimager.

# Protocol 10

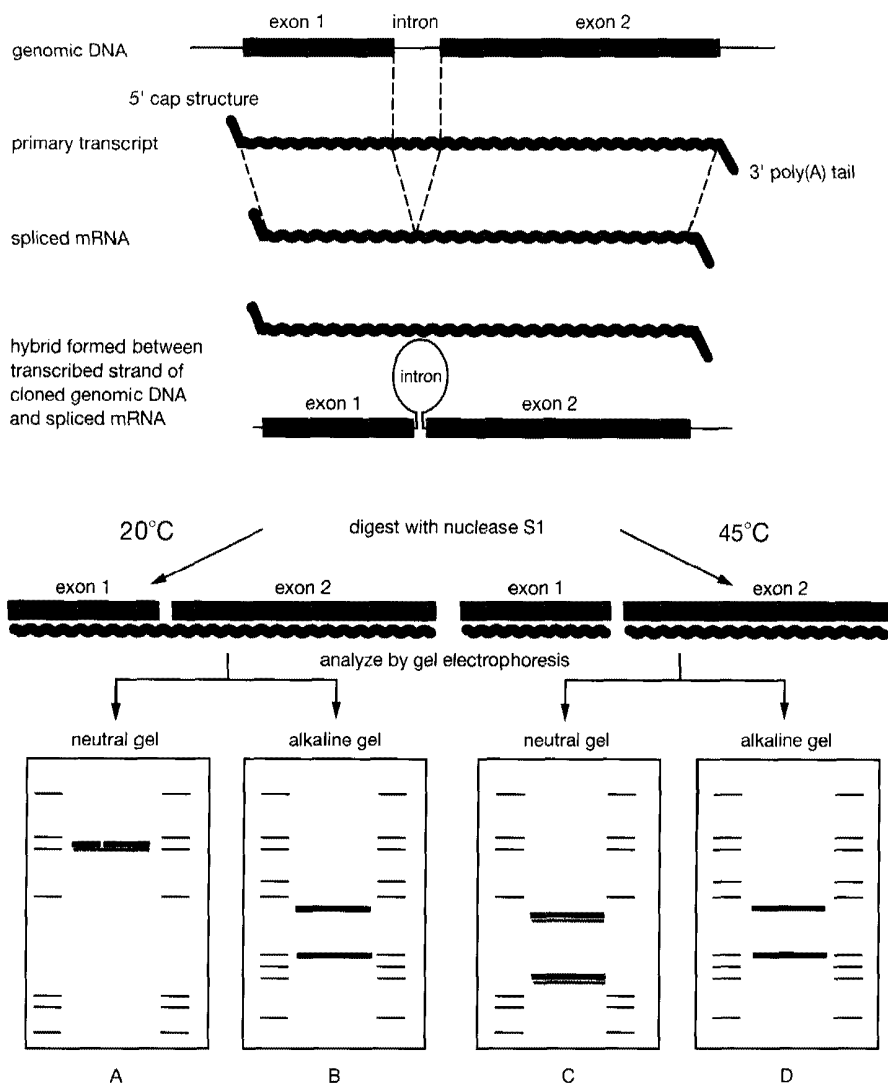
---

## Mapping RNA with Nuclease S1

**T**HREE DIFFERENT NUCLEASES — NUCLEASE S1, RIBONUCLEASE, AND EXONUCLEASE VII — have been used to quantitate RNAs, to map the position of introns, and to identify the locations of 5' and 3' ends of mRNAs on cloned DNA templates (please see Figures 7-4 and 7-5). Nuclease S1 is used in protection assays when the test RNA is hybridized to a DNA template (please see the information panel on **NUCLEASE S1**); ribonuclease is used when the test RNA is hybridized to an RNA copy of a DNA template (please see Protocol 11). Exonuclease VII is used for more specialized purposes — to map short introns and to resolve anomalies arising in nuclease S1 protection assays (please see the information panel on **EXONUCLEASE VII**).

The methods used with all three enzymes are elaborations of the classical nuclease S1 protection technique described by Berk and Sharp (1977). Preparations of RNA containing the mRNA of interest are incubated with a complementary DNA or RNA probe under conditions that favor the formation of hybrids. At the end of the reaction, an enzyme is used to degrade unhybridized single-stranded RNA and DNA. The surviving DNA-RNA or RNA-RNA hybrids are then separated by gel electrophoresis and visualized either by autoradiography or by Southern hybridization (Favaloro et al. 1980; Calzone et al. 1987). When the probe is present in molar excess in the hybridization reaction, the strength of the signal is proportional to the concentration of the mRNA of interest in the test preparation. Accurate estimates of concentration can be obtained by constructing a standard curve in which an excess of probe is hybridized to known amounts of the target sequence.

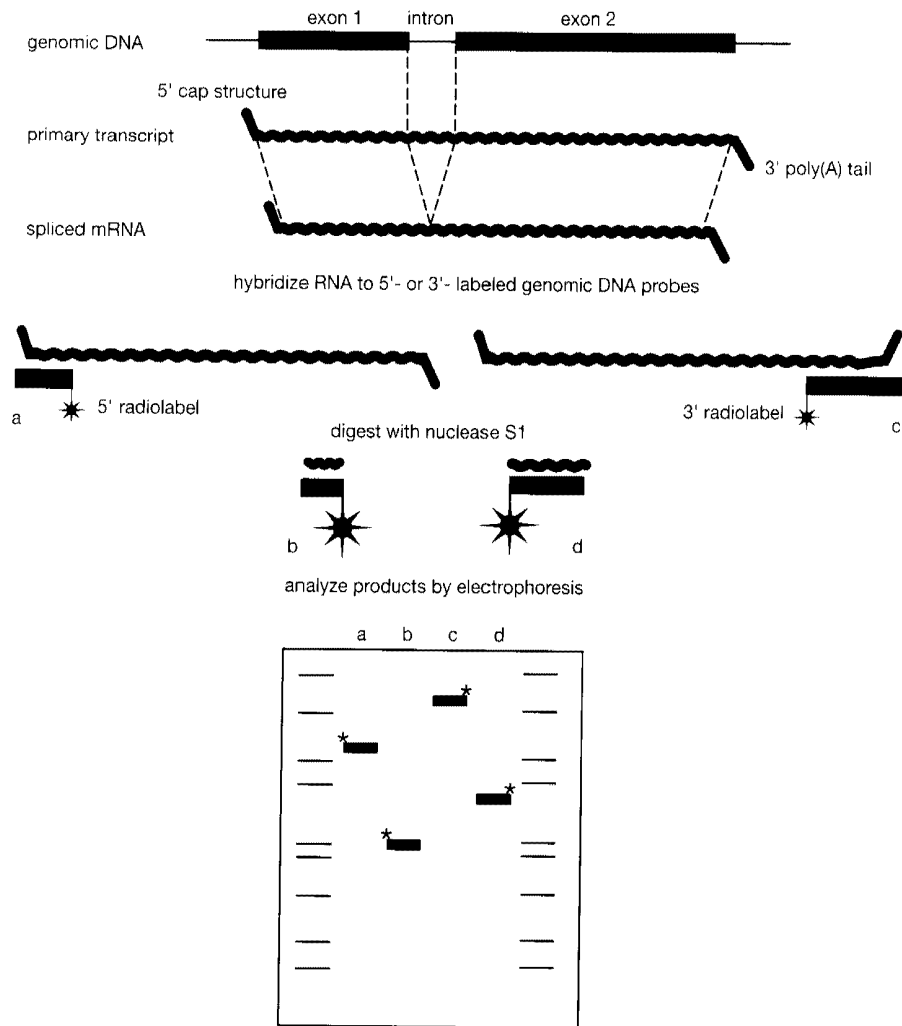
A major problem with the nuclease S1 protection assay in its original form (Berk and Sharp 1977) was the use of double-stranded DNA as probes. To prevent reassociation of the probe DNA during the hybridization step, it was desirable but not always possible to establish hybridization conditions that favored the formation of RNA-DNA hybrids over competing DNA-DNA hybrids. Because DNA-RNA hybrids are slightly more stable than DNA-DNA hybrids, the annealing step was usually performed in 80% formamide at a temperature above the calculated melting temperature of the double-stranded DNA (Casey and Davidson 1977; Dean 1987). However, under these conditions, the rate of hybridization is slowed by a factor of ~10, and the stability of DNA-RNA hybrids is unpredictable. These problems could be circumvented by the use of single-stranded probes. The annealing step could then be carried out under standard hybridization conditions because there would be no complementary strand present to compete with the target RNA for probe. However, when Berk and Sharp did their work, there was simply no reliable method to prepare a single strand of DNA free of its complement. Strand-separating gel electrophoresis (Hayward 1972) was the only technique available, but it was always a tricky business (please see



**FIGURE 7-4 Mapping RNA with Nuclease S1**

When cloned segments of genomic DNA are used as probes, the location of introns can be inferred from the size of the bands after nuclease S1 digestion. Hybrids formed between the transcribed strand of genomic DNA and mRNA contain loops of single-stranded DNA (introns). Digestion of these hybrids with nuclease S1 at 20°C generates molecules whose RNA moieties are intact but whose DNAs contain gaps at the sites of the introns. These molecules migrate as a single band when analyzed by gel electrophoresis under nondenaturing conditions (gel A). In alkaline gels (gel B), however, the RNA is hydrolyzed and the individual fragments of DNA separate according to their sizes. When digestion with nuclease S1 is carried out at 45°C, both the DNA and RNA strands of the parental hybrid are cleaved to yield a series of smaller DNA-RNA hybrids that can be separated by electrophoresis under nondenaturing conditions (gel C). The DNA moieties in these hybrids (gel D) are the same size as those detected in gel B.

Chapter 5, Protocol 8). Separation was possible with only ~70% of the DNA fragments and, even when successful, inevitably resulted in preparations that were contaminated with the complementary DNA strand. Because of these difficulties, the patterns of bands detected after gel electrophoresis were sometimes complex and often varied from one experiment to the next. These difficulties were solved in the late 1980s by the development of methods to produce single-stranded DNA or RNA probes labeled to high specific activity.



**FIGURE 7-5 Mapping the 5' and 3' Termini of mRNAs**

Hybrids formed between mRNA and DNA probes radiolabeled at either their 5' or their 3' termini are digested with nuclease S1. The locations of radiolabels are shown by the starburst symbol. The location of the 5' and 3' termini of the target RNA can be deduced by measuring the size of the nuclease-resistant fragments of DNA and estimating the distance between the radiolabel and the 5' and 3' termini of the mRNA. (Lane a) 5'-labeled probe before digestion with nuclease S1; (lane b) 5'-labeled probe after digestion with nuclease S1; (lane c) 3'-labeled probe before digestion with nuclease S1; (lane d) 3'-labeled probe after digestion with nuclease S1. Molecular-weight standards are represented in the outside lanes. In eukaryotic systems, the 5' end of the mRNA determined by nuclease S1 mapping generally represents the start point of transcription, whereas the delineated 3' end represents the site of polyadenylation. A similar strategy can be used to map the position of 3'- and 5'-splice sites.

## PROBES USED IN NUCLEASE S1 PROTECTION ASSAYS

Probes of known polarity and high specific activity are made by separating the strands of a fragment of double-stranded DNA or, more frequently, by de novo synthesis either of RNA complementary to one strand of a double-stranded DNA template or of DNA complementary to a single-stranded template (for further details on probe preparation, please see Chapter 9).

- Strand-separated probes are prepared by using type II restriction enzymes, singly or in combination, to generate a DNA fragment of suitable size (usually 100–500 nucleotides) with a 5'



extension at one end and a 3' extension at the other. One strand of the fragment therefore will be up to eight nucleotides longer than the other. This difference in size is sufficient to allow separation of the two strands by electrophoresis through a polyacrylamide gel under denaturing conditions. Either before or after electrophoresis, the 5' terminus of the strand of interest is dephosphorylated and radiolabeled *in vitro* by transfer of the labeled phosphate residue from [ $\gamma$ - $^{32}\text{P}$ ]ATP, a reaction catalyzed by bacteriophage T4 polynucleotide kinase (please see Chapter 9, Protocols 13–16).

- De novo synthesis is used to produce end-labeled or uniformly labeled DNA probes *in vitro* (e.g., please see Weaver and Weissmann 1979; Burke 1984; Calzone et al. 1987; Aldea et al. 1988; Sharrocks and Hornby 1991; see also Chapter 9). End-labeled probes are prepared by phosphorylating the 5' terminus of the oligonucleotide primer; uniformly labeled probes are prepared by incorporating radiolabeled nucleotides into the growing DNA strand. In both cases, the newly synthesized strand of DNA can be separated from the template by digestion with a restriction enzyme that recognizes a unique site in the newly formed double-stranded DNA. The radiolabeled probe can then be separated from the linearized single-stranded DNA by electrophoresis through a polyacrylamide gel under denaturing conditions.
- Radiolabeled probes biased heavily in favor of one strand of DNA are produced in PCRs in which the concentration of one primer exceeds the other by a factor of 20–200. During the initial cycles of the PCR, double-stranded DNA is synthesized in a conventional exponential fashion. However, when the concentration of one primer becomes limiting, the reaction generates single-stranded DNA that accumulates at an arithmetic rate. By the end of the reaction, the concentration of one strand of DNA is three to five times greater than the concentration of the other (Scully et al. 1990).
- Radiolabeled probes consisting entirely of one strand of DNA are synthesized in thermal cycling reactions that contain a double-stranded DNA template but only one primer. Double-stranded template DNA (20  $\mu\text{g}$ ) generates  $\sim 200 \mu\text{g}$  of single-stranded probe over the course of 40 cycles. The length of the probe can be defined by cleaving the template DNA at a restriction site downstream from the binding site of the primer (Stürzl and Roth 1990a,b).
- Uniformly labeled RNA probes (riboprobes) are generated by transcribing a linear double-stranded DNA template attached to a bacteriophage promoter (Melton et al. 1984). The DNA template is generated either by digesting a recombinant plasmid with a restriction enzyme that cleaves within or downstream from the cloned DNA sequence or by amplifying the template using PCR. The linearized template is transcribed in the presence of [ $\alpha$ - $^{32}\text{P}$ ]NTPs by the appropriate bacteriophage DNA-dependent RNA polymerase to produce a radiolabeled RNA that extends from the initiation site of the promoter to the end of the DNA fragment. The promoter and the DNA sequence are oriented such that the resulting riboprobe is antisense (complementary) to the mRNA to be analyzed. It is prudent, but not mandatory, to purify RNA probes by denaturing gel electrophoresis. Purification can be carried out easily and quickly on minigels cast with 5% polyacrylamide/8 M urea and run on a miniprotein gel apparatus (e.g., Bio-Rad Mini-Protean).

Even when single-stranded probes are used, nuclease S1 analysis of the structure of eukaryotic RNAs is not free of artifacts. For example, small mismatches in DNA:RNA heteroduplexes are relatively resistant to the action of the nuclease (Berk and Sharp 1977). Conversely, regions of perfect heteroduplex that are rich in rU:dA sequences are susceptible to cleavage (Miller and Sollner-Webb 1981). A single molecule of DNA frequently can be protected from the action of the nucle-

ase by simultaneous hybridization to two different RNA molecules (Lopata et al. 1985). Finally, nuclease S1 inefficiently cleaves the segment of DNA opposite a looped-out region of RNA (Sisodia et al. 1987). Many of these problems can be solved by using a range of concentrations of nuclease S1, by performing the digestion at different temperatures, by using a different nuclease (e.g., mung bean nuclease), or by using a combination of nucleases (e.g., RNase H and nuclease S1) (Sisodia et al. 1987). However, it is important to realize that cleavage by nuclease S1 does not necessarily reflect a divergence in sequence between strands of two nucleic acids and that resistance to digestion is not necessarily synonymous with identity. Mapping with nuclease S1 should therefore be regarded as a useful, but not infallible, guide to the structure of RNAs. Thus, when using nuclease S1 to map, for example, the 5' and 3' ends of a mRNA, it is important to confirm the result by an independent technique such as primer extension (Protocol 12).

Mung bean nuclease can be substituted for nuclease S1 in many mapping experiments (please see the information panel on **MUNG BEAN NUCLEASE**). With some DNA probes, far less mung bean nuclease than nuclease S1 is needed to obtain complete digestion of single-stranded regions. For example, nuclease S1 is used at a concentration of 1000 units/ml to obtain complete digestion of excess single-stranded DNA probe corresponding to the human low-density lipoprotein receptor, whereas an identical result is obtained with as little as 10 units/ml of mung bean nuclease (J.A. Cuthbert, pers. comm., University of Texas Southwestern Medical Center, Dallas). A disadvantage of mung bean nuclease is that it can cost 20 times more on a per-unit basis than nuclease S1. Mung bean nuclease can be substituted for nuclease S1 at Step 22 in the protocol. Mung bean nuclease digestions are carried out in a buffer containing 10 mM sodium acetate (pH 4.6)/50 mM NaCl/1 mM ZnCl<sub>2</sub>/1 mM β-mercaptoethanol/0.001% (v/v) Triton X-100.

This protocol presents a method for nuclease S1 mapping of mRNA using a uniformly labeled, single-stranded DNA probe. Procedures for mapping RNA using ribonuclease and RNA probes and for mapping RNA by primer extension are presented in Protocols 11 and 12, respectively.

## MATERIALS

▲ **IMPORTANT** Prepare all reagents used in this protocol with DEPC-treated H<sub>2</sub>O (please see the information panel on **HOW TO WIN THE BATTLE WITH RNASE**).

**CAUTION:** Please see Appendix 12 for appropriate handling of materials marked with <!.>.

### Buffers and Solutions

Please see Appendix 1 for components of stock solutions, buffers, and reagents. Dilute stock to the appropriate working concentration.

*Ammonium persulfate (10%) <!.>*

*10x Annealing buffer*

100 mM Tris-Cl (pH 7.5)

100 mM MgCl<sub>2</sub>

0.5 M NaCl

100 mM dithiothreitol

*Ethanol*

*Gel elution buffer*

0.5 M ammonium acetate <!.>

1 mM EDTA (pH 8.0)

0.1% (w/v) SDS

*Hybridization buffer (for RNA)*

40 mM PIPES (pH 6.4)  
 0.1 mM EDTA (pH 8.0)  
 0.4 M NaCl

Use the disodium salt of PIPES (piperazine-*N,N'*-bis[2-ethanesulfonic acid]) to prepare the buffer, and adjust the pH to 6.4 with 1 N HCl.

*Nuclease S1 stop mixture*

4 M ammonium acetate  
 50 mM EDTA (pH 8.0)  
 50 µg/ml carrier RNA

Store the nuclease S1 stop mixture in aliquots at -20°C.

*Phenol:chloroform (1:1, v/v) <!>**RNA gel-loading buffer**Sodium acetate (3 M, pH 5.2)**TE (pH 7.6)**TEMED (N,N,N',N'-tetramethylethylene diamine) <!>**Trichloroacetic acid (TCA) (1% and 10%) <!>*

Dilute 100% stock solution 1/10 and 1/100 just before use. Chill the working solutions in ice.

**Enzymes and Buffers***Bacteriophage T4 polynucleotide kinase**Klenow fragment of E. coli DNA polymerase (10 units/µl)**Nuclease S1 (for use in nuclease S1 digestion buffer, please see below)*

It is necessary to titrate the nuclease S1 each time a new probe or RNA preparation is used.

*Nuclease S1 digestion buffer*

0.28 M NaCl  
 0.05 M sodium acetate (pH 4.5)  
 4.5 mM ZnSO<sub>4</sub>·7H<sub>2</sub>O

Store aliquots of nuclease S1 buffer at -20°C and add nuclease S1 to a concentration of 500 units/ml just before use.

*Restriction endonucleases***Gels***Denaturing polyacrylamide gel containing 8 M urea <!>*

For most 5'- and 3'-end mapping experiments, a denaturing gel composed of 5% or 6% polyacrylamide and containing 8 M urea nicely resolves protected DNA fragments. A typical gel is 1.5 mm thick. However, "thin" or "sequencing" gels (0.4-mm thickness) can also be used (please see Chapter 12). If thin gels are used to resolve protected DNA fragments, it is usually not necessary to fix the gel in trichloroacetic acid (TCA), as described in Steps 30-32, before drying the gel. Fixing sharpens and increases the resolution of thicker gels. In many cases, a miniprotein gel apparatus (e.g., Bio-Rad Mini-Protean or Ambion Vertical Gel Apparatus) (13 cm x 13 cm x 1 mm) can be used both to prepare the radiolabeled single-stranded DNA or RNA probe and to analyze the products of nuclease S1 digestion. Table 7-6 shows the percentage of polyacrylamide used to purify DNA fragments of various sizes; Table 7-7 shows the expected mobilities of tracking dyes in these gels. The method used to prepare the polyacrylamide gel is described in Step 1 of this protocol; for further details, please see Chapter 12, Protocol 8.

**TABLE 7-6 Percentage of Gel for Purifying Various DNA Fragments**

% POLYACRYLAMIDE/UREA GEL	SIZE OF BAND (nt)
4	>250
6	60-250
8	40-120
10	20-60
12	10-50

**TABLE 7-7 Expected Mobilities of Tracking Dyes**

% POLYACRYLAMIDE/UREA GEL	XYLENE CYANOL (nt)	BROMOPHENOL BLUE (nt)
4	155	30
6	110	25
8	75	20
10	55	10

Tracking dyes can serve as useful size standards on denaturing polyacrylamide gels. The table indicates the approximate sizes of tracking dyes (in nucleotides) on gels of different polyacrylamide concentrations.

## Nucleic Acids and Oligonucleotides

*Carrier RNA (yeast tRNA)*

*dNTP solution (20 mM) containing all four dNTPs*

Dissolve the dNTPs in 25 mM Tris-Cl (pH 8.0) and store as small aliquots at  $-20^{\circ}\text{C}$ .

*RNA, for use as a standard*

Synthesize in vitro by transcription of the appropriate strand of a recombinant plasmid containing the DNA sequences of interest and a bacteriophage promoter. Methods to synthesize and purify the RNA are outlined in Chapter 9, Protocol 6.

*Synthetic oligonucleotide (10 pmoles/ $\mu\text{l}$ ) in distilled  $\text{H}_2\text{O}$*

The oligonucleotide used to prime synthesis of the probe from a single-stranded DNA template should be 20–25 nucleotides in length and complementary to the RNA strand to be analyzed. It should hybridize to the template DNA strand 250–500 nucleotides 3' of the position that will be cleaved by the chosen restriction enzyme. Store oligonucleotides in aliquots at  $-20^{\circ}\text{C}$ .

*Template DNA (1  $\mu\text{g}/\mu\text{l}$ ), single-stranded*

Use standard procedures (Chapter 3, Protocol 5) to prepare single-stranded DNA from a recombinant bacteriophage M13 carrying the insert DNA strand in the same sense as the test RNA.

*Test RNA*

Poly(A)<sup>-</sup> or total RNA prepared by one of the methods described in Protocols 1 through 4 of this chapter.

## Probes

*DNA probe, uniformly labeled and single-stranded*

The DNA probe is prepared in Steps 1–15 of this protocol. Use single-stranded probes uniformly labeled to high specific activity within a few days to avoid problems caused by radiochemical degradation.

## Radioactive Compounds

*[ $\gamma$ - $^{32}\text{P}$ ]ATP (10 mCi/ml, 3000 Ci/mmmole) <1>*

## Special Equipment

*Water baths preset to  $65^{\circ}\text{C}$ ,  $85^{\circ}\text{C}$ , and  $95^{\circ}\text{C}$ , to the appropriate digestion temperature (please see Step 22), and to the desired hybridization temperature (please see Step 21)*

*Whatman 3MM filter paper (or equivalent)*

**TABLE 7-8 Volumes of Polyacrylamide Required to Cast Minigels of Various Percentages**

% GEL	VOLUME OF 40% ACRYLAMIDE (ml)
4	1.5
5	1.875
6	2.25
8	3.0

## METHOD

---

### Preparation of Randomly Labeled Single-stranded DNA Probe

1. Prepare a polyacrylamide minigel containing 8 M urea (13 cm × 15 cm × 0.75 mm) (e.g., Bio-Rad Mini-Protean).
  - a. Mix the following reagents:
    - 7.2 g of urea
    - 1.5 ml of 10x TBE

Add the appropriate amounts of 40% acrylamide (acrylamide:bisacrylamide 19:1; please see Table 7-8) to generate a gel containing the desired concentration of polyacrylamide (please see Table 7-6).
  - b. Add H<sub>2</sub>O to a final volume of 15 ml.
  - c. Stir the mixture at room temperature on a magnetic stirrer until the urea dissolves. Then add:
    - 120 μl of 10% ammonium persulfate
    - 16 μl of TEMED

Mix the solution quickly and then pour the gel into the mold of a minigel apparatus.
2. While the gel is polymerizing, mix the following reagents:
  - 10 pmoles (1 μl) of unlabeled oligonucleotide
  - 10 μl of [ $\gamma$ -<sup>32</sup>P]ATP (3000 Ci/mmol, 10 mCi/ml)
  - 2 μl of 10x polynucleotide kinase buffer
  - 6 μl of H<sub>2</sub>O
  - 10 units (1 μl) of polynucleotide kinase

Incubate the reaction mixture for 45 minutes at 37°C, and then for 3 minutes at 95°C to inactivate the polynucleotide kinase.
3. Add to the kinase reaction:
  - 2 μl (2 μg) of single-stranded DNA template
  - 4 μl of 10x annealing buffer
  - 14 μl of H<sub>2</sub>O

Incubate the reaction mixture for 10 minutes at 65°C and then allow it to cool to room temperature.
4. Add to the reaction mix from Step 3:
  - 4 μl of dNTP mixture
  - 1 μl (10 units) of the Klenow fragment of *E. coli* DNA polymerase I

Incubate the reaction mixture for 15 minutes at room temperature and then inactivate the DNA polymerase by incubation for 3 minutes at 65°C.
5. Adjust the ionic composition and pH of the reaction mixture to suit the restriction enzyme. Add 20 units of restriction enzyme and incubate the reaction mixture for 2 hours at the appropriate temperature.
6. Add to the restriction endonuclease digestion reaction:
  - 2 μl of carrier RNA
  - 5 μl of 3 M sodium acetate (pH 5.2)

Recover the DNA probe by standard precipitation with ethanol.

7. Dissolve the DNA in 20  $\mu$ l of gel-loading buffer. Heat the solution to 95°C for 5 minutes to denature the DNA, and then cool the DNA quickly to 0°C.

### Purification of the Probe by Gel Electrophoresis

8. While the DNA is incubating at 95°C, wash the loading slots of the gel to remove urea and then, without delay, load the probe into one of the slots of the gel.
9. Run the gel until the bromophenol blue reaches the bottom of the gel (200 mA for ~30 minutes).
10. Dismantle the gel apparatus, leaving the gel attached to the bottom glass plate. Wrap the gel and plate in a piece of plastic wrap (e.g., Saran Wrap). Make sure that there are no bubbles between the gel and the plastic film.
  - ▲ **WARNING** Wear eye protection when prying the glass plates apart.
11. Expose the gel to X-ray film. Mark the location of the corners and sides of the plate on the film with a permanent marker. Also mark the position of the bromophenol blue and xylene cyanol. Usually an exposure of 2–10 minutes is sufficient to obtain an image of the radiolabeled probe.
12. Realign the glass plate with the film and excise the radiolabeled band with a scalpel. Reexpose the mutilated gel to a fresh piece of film to ensure that the region of the gel containing the band of the correct molecular weight has been accurately excised.

#### SETTING UP HYBRIDIZATIONS BETWEEN THE RADIOLABELED PROBE AND THE TEST RNA

When setting up hybridizations:

- The DNA probe should be in excess over the target RNA species. In most cases, addition of 0.01–0.05 pmole of probe (~1–8 ng of a 400-nucleotide single-stranded DNA probe) will provide an excess of probe in the hybridization reaction. However, nuclease S1 mapping of abundant RNAs (e.g., viral mRNAs present in infected cells, mRNAs encoding structural proteins, or mRNAs encoding abundant enzymes) may require more DNA probe. The exact amount of probe required to reach saturation can be determined empirically by nuclease S1 digestion of a series of hybridization mixtures containing different ratios of test RNA:probe.
- The amount of test RNA required depends on the concentration of the sequences of interest and on the specific activity of the radiolabeled probe. With DNAs that have been radiolabeled to high specific activity ( $>10^9$  cpm/ $\mu$ g), 10  $\mu$ g of total RNA is usually sufficient to allow detection of mRNA species that are present at the level of one to five copies/cell. To detect sequences present in lower concentrations (e.g., in RNA extracted from heterogeneous populations of cells), up to 150  $\mu$ g of RNA may be used in a 30- $\mu$ l hybridization reaction. For ease of manipulation in subsequent steps, it is advisable to keep the hybridization volume to 30  $\mu$ l or less. If reagents are in short supply, the hybridization reactions can be scaled down to 10  $\mu$ l. In every experiment, it is best to include several different amounts of input RNA to make sure that the DNA probe is in excess and that duplicate tubes yield reproducible results.
- All reactions should contain the same amount of RNA to ensure that digestion with nuclease S1 is carried out under near identical conditions. If necessary, adjust the amount of RNA in the hybridization reactions by adding carrier RNA.
- To quantify the target sequences in the preparations of RNA under test, set up a series of hybridization reactions containing a constant amount of radiolabeled probe, a constant amount of control RNA (i.e., RNA known to lack the target sequences), and amounts (1 fg to 100 pg) of a standard preparation of RNA synthesized *in vitro*. Total cellular RNA (10  $\mu$ g) will contain 10 fg to 1 pg of a rare mRNA and ~300 pg of a moderately abundant mRNA such as  $\beta$ -actin or GAPDH.

13. Transfer the fragment of gel to a fresh sterile microfuge tube and add just enough gel elution buffer to cover the fragment (250–500  $\mu$ l). Incubate the closed tube on a rotating wheel overnight at room temperature.

14. Centrifuge the tube at maximum speed for 5 minutes in a microfuge.
15. Taking care to avoid the pellet of polyacrylamide, use an automatic pipetting device to transfer the supernatant to a fresh microfuge tube. The labeled probe should emit  $\sim 1 \times 10^4$  cpm/ $\mu$ l as measured by liquid scintillation spectroscopy.
  - Optional: To maximize recovery of RNA, add 200  $\mu$ l of gel elution buffer to the gel pellet in Step 15, incubate the closed tube on a rotating wheel overnight, and repeat Steps 14 and 15.
16. Store the probe at  $-70^\circ\text{C}$ .

### Hybridization between the Test RNA and the Radiolabeled Probe DNA

17. Transfer 0.5–150  $\mu$ g aliquots of RNA (test and standard) into sterile microfuge tubes. Add an excess of uniformly labeled single-stranded DNA probe to each tube.
18. Precipitate the RNA and DNA by adding 0.1 volume of 3 M sodium acetate (pH 5.2) and 2.5 volumes of ice-cold ethanol. After storage for 30 minutes at  $0^\circ\text{C}$ , recover the nucleic acids by centrifugation at maximum speed for 15 minutes at  $4^\circ\text{C}$  in a microfuge. Discard the ethanolic supernatant, rinse the pellet with 70% ethanol, and centrifuge the sample. Carefully remove all of the ethanol, and store the pellet containing RNA and DNA at room temperature until the last visible traces of ethanol have evaporated.
  - Do not allow the pellet to become desiccated, otherwise it will be difficult to dissolve.

#### DISSOLVING NUCLEIC ACID PELLETS

It is often difficult to obtain complete dissolution of the pellet of nucleic acids in hybridization buffer (Step 19). This problem is exacerbated if the pellet is dried in a desiccator. Sometimes the pellet can be dissolved by a combination of vigorous pipetting and heating to  $60^\circ\text{C}$ . If difficulties persist, or if equivalent signals are not obtained from duplicate samples of RNA, the following procedure is recommended:

1. After Step 18 of the protocol, dissolve the pellet in 40–50  $\mu$ l of  $\text{H}_2\text{O}$ . Evaporate the sample in a rotary evaporator until it is just dry.
2. Add 30  $\mu$ l of hybridization buffer. The hydrated pellet should go into solution quickly and easily and yield reproducible results.

19. Dissolve the nucleic acid pellet in 30  $\mu$ l of hybridization buffer. Pipette the solution up and down many times to ensure that the pellet is completely dissolved.
20. Close the lid of the tube tightly, and incubate the hybridization reaction in a water bath set at  $85^\circ\text{C}$  for 10 minutes to denature the nucleic acids.
21. Rapidly transfer the tube to a water bath set at the desired hybridization temperature (usually  $65^\circ\text{C}$ ). Do not allow the tube to cool below the hybridization temperature during transfer. Hybridize the DNA and RNA for 12–16 hours at the chosen temperature.

### Nuclease S1 Digestion of the DNA-RNA Hybrids

22. Taking care to keep the body of the tube submerged, open the lid of the hybridization tube. Rapidly add 300  $\mu$ l of ice-cold nuclease S1 digestion buffer, and immediately remove the tube from the water bath. Quickly mix the contents of the tube by vortexing gently, and then transfer the tube to a water bath set at the temperature appropriate for digestion with nuclease S1. Incubate for 1–2 hours, depending on the degree of digestion desired.

**CONDITIONS FOR DIGESTION WITH NUCLEASE S1**

A variety of temperatures and nuclease S1 concentrations have been used to analyze DNA-RNA hybrids. For example, at 20°C, nuclease S1 at a concentration of 100–1000 units/ml will degrade loops of DNA but will not efficiently digest segments of RNA molecules that bridge loops of DNA. This property is useful when mapping intron/exon borders in segments of genomic DNA because the partially digested molecule will migrate through agarose gels at neutral pH at approximately the same rate as double-stranded DNA. However, under alkaline conditions, the RNA “bridge” will be hydrolyzed, liberating two smaller pieces of single-stranded DNA. From the sizes of these fragments, it is often possible to assign locations to intron/exon junctions in a segment of genomic DNA (Berk and Sharp 1977). For digestion of the single-stranded regions of DNA-RNA hybrids, higher temperatures (37–45°C) or increased quantities of nuclease S1 are generally required. Because of the ambiguity inherent in choosing conditions that will lead to either complete resistance to digestion or complete digestion of single-stranded nucleic acid structures, it is best to choose a convenient digestion time (e.g., 1 hour) and then set up a series of test reactions in which the amount of nuclease S1 is varied (e.g., 100, 500, and 1000 units/ml) and the digestion temperature is varied (22°C, 30°C, 37°C, and 45°C). Examine the results by polyacrylamide gel electrophoresis and fine tune the enzyme concentration and temperature conditions as needed.

23. Chill the reaction to 0°C. Add 80 µl of nuclease S1 stop mixture and vortex the tube to mix the solution.
24. Extract the reaction once with phenol:chloroform. After centrifugation at maximum speed for 2 minutes at room temperature in a microfuge, transfer the aqueous supernatant to a fresh tube. Add 2 volumes of ethanol, mix, and store the tube for 1 hour at –20°C.
25. Recover the nucleic acids by centrifugation at maximum speed for 15 minutes at 4°C in a microfuge. Carefully remove all of the supernatant, and store the open tube at room temperature until the last visible traces of ethanol have evaporated.

### Analysis of the Products of Nuclease S1 Digestions by Gel Electrophoresis

26. Dissolve the pellet in 4 µl of TE (pH 7.6). Add 6 µl of gel-loading buffer and mix well.
27. Heat the nucleic acids for 5 minutes at 95°C, and then immediately transfer the tube to an ice bath. Centrifuge the tubes briefly in a microfuge to consolidate the samples at the bottoms of the tubes.
28. Analyze the radiolabeled DNA by electrophoresis through a polyacrylamide/8 M urea gel.
 

For most applications, a 5–6% polyacrylamide/8 M urea gel of 1.5-mm thickness will suffice. As molecular-weight markers, use end-labeled fragments of DNA of known size or a sequencing ladder. During electrophoresis, enough current should be run through the gel to keep the glass plates warm to the touch.
29. After the tracking dyes have migrated an appropriate distance through the gel (please see Table 7-7), turn off the power supply and disassemble the electrophoresis set up. Gently pry up one corner of the larger glass plate and slowly remove the plate from the gel. Cut off one corner of the gel for orientation purposes.
 

▲ **WARNING** Wear eye protection when prying the glass plates apart.
30. Transfer the glass plate containing the gel to a tray containing an excess of 10% TCA. Gently rock or rotate the tray for 10 minutes at room temperature.
 

The gel will usually float off the glass plate during this incubation. Do not allow the floating gel to fold up on itself.



31. Pour off the 10% TCA solution and replace with an excess of 1% TCA. Gently rock or rotate the tray for 5 minutes at room temperature.
32. Pour off the 1% TCA solution and briefly rinse the fixed gel with distilled deionized H<sub>2</sub>O. Lift the glass plate together with the gel out of the tray and place them on a flat bench top. Use paper towels or Kimwipes to remove excess H<sub>2</sub>O.  
Do not place towels on top of the gel.
33. Cut a piece of Whatman 3MM filter paper (or equivalent) that is 1 cm larger than the gel on all sides. Transfer the gel to the filter paper by laying the paper on top of the gel and inverting the glass plate.
34. Remove the plate and dry the gel on a gel dryer for 1.0–1.5 hours at 60°C.
35. Establish an autoradiographic image of the dried gel. Scan the image by densitometry or phosphorimaging, or excise the segments of the gel containing the fragments and count them by liquid scintillation spectroscopy.

From the samples containing different amounts of standard RNA, a curve of mass versus radioactivity can be constructed. The amount of target sequences in the test preparations of RNA can then be estimated by interpolation.

# Protocol 11

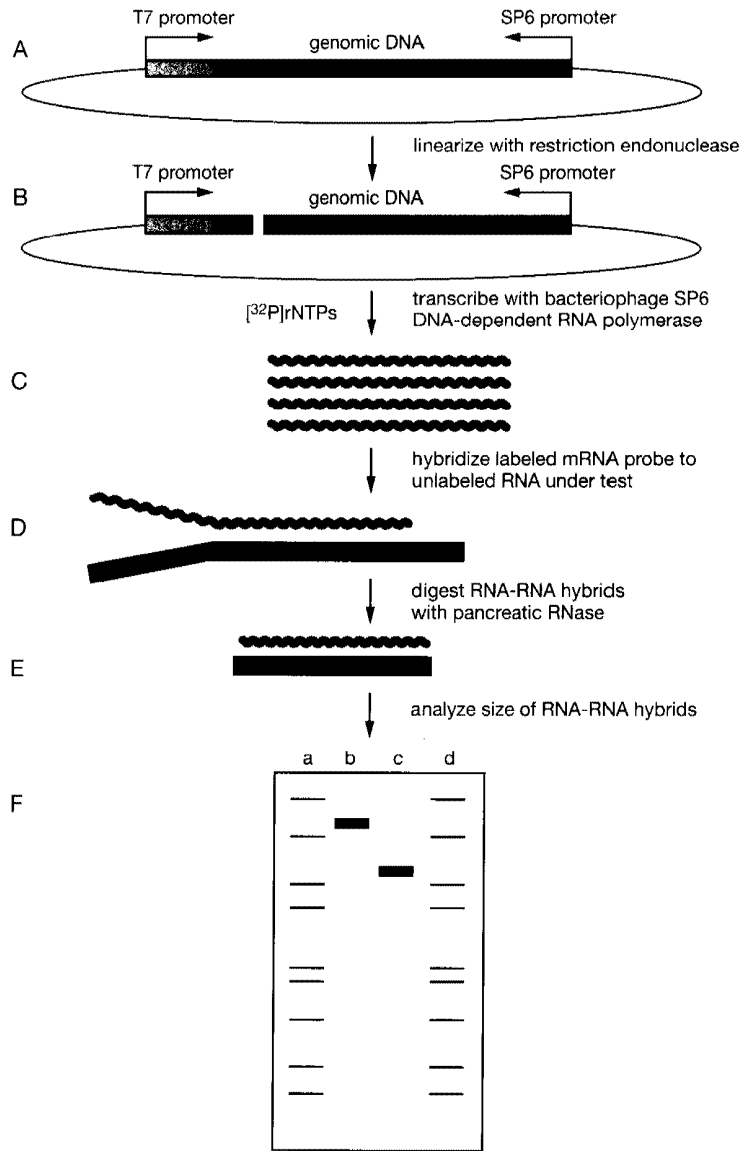
---

## Ribonuclease Protection: Mapping RNA with Ribonuclease and Radiolabeled RNA Probes

**R**IBONUCLEASE PROTECTION ASSAYS ARE USED TO MEASURE the abundance of specific mRNAs and to map their topological features. The method involves hybridization of test RNAs to complementary radiolabeled RNA probes (riboprobes), followed by digestion of nonhybridized sequences with one or more single-strand-specific ribonucleases. At the end of the digestion, the ribonucleases are inactivated, and the protected fragments of radiolabeled RNA are analyzed by polyacrylamide gel electrophoresis and autoradiography. As with nuclease S1 protection assays (please see Figure 7-4), the size of the protected fragments allows the mapping of features such as intron-exon borders and sites of transcription initiation and termination (please see Figure 7-6) (Lynn et al. 1983; Zinn et al. 1983; Melton et al. 1984; for reviews, please see Calzone et al. 1987; Kekule et al. 1990; Mitchell and Fidge 1996). However, interpretation of mapping data is not always easy or unambiguous. For example, when analyzing protected fragments formed between a test mRNA and a riboprobe derived by transcription of a cloned segment of genomic DNA, it is not always possible to distinguish between a splice junction lying near the 5' terminus of the mRNA and the true 5' terminus of the mRNA. Wherever possible, confirmatory data should be obtained from an independent technique, for example, primer extension (Protocol 12 of this chapter) or 5'-RACE (Chapter 8, Protocol 9).

When the antisense riboprobe is present in molar excess, the strength of the autoradiographic signal is proportional to the amount of sense RNA in the test sample. Quantification is achieved by comparing the strength of the signals from samples containing test RNA with that of signals from samples containing known amounts of standard RNAs, these being generated by *in vitro* transcription of an appropriate DNA template (please see Techniques for Quantitating RNA below). Ribonuclease protection is at least tenfold more sensitive than northern hybridization. This sensitivity is due to a variety of factors, including the following.

- **More complete and speedier hybridization** is achieved because test and probe RNAs are both present in solution.
- **Elimination of the step in which RNA is transferred from a gel to a solid support.** The efficiency of this step varies according to the method used and the molecular weight of the target RNA.
- **Elimination of posthybridization washing steps.** The stringency and efficiency of these steps affect the level of background and the strength of the signal. No matter how skillfully these washes are performed, the maximum ratio of signal to noise in a northern blot rarely exceeds a factor of 10.



**FIGURE 7-6 Mapping mRNAs with Radiolabeled RNA Probes and RNase**

Radiolabeled RNA, synthesized *in vitro* from a cloned copy of the genomic DNA (steps A–C), is hybridized to unlabeled test mRNA (step D). After removal of the unhybridized tails by digestion with RNase (step E), the size of the radiolabeled RNA that is resistant to RNase is measured by gel electrophoresis (step F). (Step A) Target DNA is cloned into a plasmid downstream from a prokaryotic promoter (bacteriophage SP6 or T7); (step B) the recombinant plasmid is linearized with a restriction enzyme that cleaves at the distal end of the target DNA; (step C) the linear DNA is transcribed with the appropriate DNA-dependent RNA polymerase (in this case, SP6), and template DNA is removed by digestion with RNase-free pancreatic DNase; (step D) radiolabeled RNA (orange squiggly line) is hybridized to unlabeled test RNA (solid red line); (step E) RNA-RNA hybrids are digested with pancreatic RNase; (step F) RNA-RNA hybrids (before and after digestion with RNase) are analyzed with gel electrophoresis and autoradiography. (Lanes a,d) Molecular-weight standards. (Lane b) Radiolabeled RNA before digestion with RNase; (lane c) radiolabeled RNA after digestion with RNase. By using probes complementary to appropriate segments of the template DNA, it is possible to map the positions of the 5' and 3' termini of mRNAs and the positions of 5'- and 3'-splice sites.

- **Greater tolerance of RNA degradation.** Because the radiolabeled antisense probe is generally much shorter than the mRNA under test, the sensitivity and accuracy of the ribonuclease protection assay are not significantly affected if the preparation of test RNA is partially degraded.

Ribonuclease protection assays have other advantages over northern hybridizations; they do not require special instruments, can be adapted to the simultaneous use of several radiolabeled probes, and are sufficiently sensitive to detect low-abundance RNAs in preparations of total RNA. The ribonuclease protection assay shares many of these advantages with the nuclease S1 protection assay. However, the two protection assays differ in some respects. AU-rich regions, which are often cleaved nonspecifically by nuclease S1, are not susceptible to nonspecific cleavage in ribonuclease protection assays, and the termini of the hybrids are not at risk of being nibbled (please see Ribonucleases Used in Ribonuclease Protection Assays below). In addition, radiolabeled probes used in nuclease S1 protection assays require specific oligonucleotide primers and single-stranded DNA templates. Riboprobes, on the other hand, can be produced by transcription of standard plasmids carrying bacteriophage promoters (for further details, please see Chapter 9). For these reasons, the ribonuclease protection assay has largely replaced the nuclease S1 assay as the standard method of analysis of RNA.

## TECHNIQUES FOR QUANTITATING RNA

---

Oddly enough, gene expression was measured more accurately in the 1970s than it is today. Only one technique — reassociation kinetics — was available in those days. Reassociation of nucleic acids in solution results from collision of complementary strands and follows kinetics that are second order or very nearly so (Wetmur and Davidson 1968). The rate of hybridization is therefore inversely proportional to the initial concentration of the complementary strands (Britten and Kohne 1968). The absolute concentration of a particular RNA can be calculated from the kinetics of its reassociation with its DNA template.

During the decade that preceded the development of molecular cloning, many reassociation experiments were carried out to measure the concentration of mRNAs. Almost all of these experiments involved measuring the rate of association of a radiolabeled single-stranded DNA probe with its complementary mRNA, when the RNA was present in molar excess. These were difficult experiments, for several reasons: The concentration of reagents in the hybridization reactions was often so low that the reassociation reaction required many hours — days in some cases — to generate significant amounts of hybrid. Second, hydroxyapatite columns were routinely used to separate double-stranded and single-stranded nucleic acids (Kohne and Britten 1971; Britten et al. 1974). Running these columns was a tedious and messy business. With practice, one person could run 24 small hydroxyapatite columns simultaneously. However, this was not much fun; not only was the processing of samples extremely monotonous, but, even worse, the columns were run in scalding hot water baths. Then there was the perennial problem of generating a radiolabeled template of high specific activity. In those days, all labeling of nucleic acids was done *in vivo* using [<sup>32</sup>P]orthophosphate. At Cold Spring Harbor Laboratory, our weekly delivery of 100 mCi of the ghastly stuff arrived on Tuesday and was immediately used to label cultured cells infected with SV40 or adenovirus. By Friday or Saturday, if we were lucky, we had purified enough viral DNA at sufficient specific activity to do a few experiments before the next batch of radioactivity arrived. Both the hydroxyapatite columns and the radiolabeled DNA were far too hot to handle with comfort.

Hydroxyapatite columns and their scalding water baths have all but disappeared from laboratory inventories. We cannot regret their passing, but we can mourn the loss of reassociation

kinetics as a way to measure the concentrations of nucleic acids. The simplicity and elegance of the underlying theory and the easy clarity of the experiments deserved a greater permanence.

Today, a number of procedures are used to measure the abundance of a particular mRNA in a preparation of total or poly(A)<sup>+</sup> RNA. The most popular of these are northern blots, ribonuclease protection, and quantitative reverse transcriptase-PCR (RT-PCR). Each of these methods has virtues and limitations:

- **Northern blots** require relatively large amounts of material and are severely compromised by degradation of the RNA. Their sensitivity is low and they are clumsy instruments for measuring the abundance of different mRNAs in the same sample. However, northern blotting has the unique virtue of simultaneously providing information on both size and abundance of target mRNAs. This duality is particularly useful when comparing expression of spliced variants of a transcript in different tissues. Quantification depends on rehybridization with a probe to a transcript from a housekeeping gene or an externally added standard (please see the Introduction to Northern Hybridization preceding Protocol 5).
- **Ribonuclease protection** does not require intact RNA; it is ~20–100-fold more sensitive than northern hybridization and is capable of detecting ~10<sup>5</sup> copies of a specific transcript. The method can easily cope with several target mRNAs simultaneously and, because the intensity of the signal is directly proportional to the concentration of target RNA, comparisons of the level of expression of the target gene in different tissues is easily accomplished. However, ribonuclease protection works best with antisense probes that are exactly complementary to the target mRNA. This can be a problem if the experiment generates RNA-RNA hybrids containing mismatched base pairs that are susceptible to cleavage by RNase, for example, when analyzing families of related mRNAs. Quantification of target RNAs is best achieved by constructing standard curves with one (Pape et al. 1991) or two (Davis et al. 1997) synthetic sense-strand templates that can be distinguished from the endogenous target RNA by size.
- **Quantitative RT-PCR** (please see Chapter 8, Protocol 15) offers several substantial advantages over other methods: The RNA need not be highly purified, only small amounts of template are needed, and the method is far more sensitive than northern hybridization or ribonuclease protection assays. RT-PCR is the only method that in theory is capable of detecting a single copy of a target sequence in a preparation of RNA. In practice, however, this level of sensitivity is beyond reach, mostly because of inefficiencies inherent in the first stage of the reaction — the conversion of RNA to DNA. The subsequent amplification step, which endows quantitative PCR with such exquisite sensitivity, can also be its Achilles' heel: Small differences in the efficiency of amplification between samples can dramatically affect the strength of the signal obtained. These problems can be minimized but never completely eliminated by the use of internal controls in the PCR.

In summary, quantitative RT-PCR is the best available method to measure rare transcripts in small-scale preparations of mRNA. However, ribonuclease protection is preferred whenever the amount of target RNA falls within the range of detection, simply because of the linearity of the assay. Northern hybridization remains esthetically the most pleasing of the three techniques.

## RIBONUCLEASES USED IN RIBONUCLEASE PROTECTION ASSAYS

---

The original ribonuclease protection method (Melton et al. 1984) relied exclusively on pancreatic RNase (RNase A) to degrade the single-stranded RNA remaining after the hybridization step. However, more complete digestion may be obtained with a mixture of RNase A and RNase T1 (Winter et al. 1985), two single-strand-specific endoribonucleases with different specificities:

Bovine pancreatic ribonuclease A shows a strong preference for pyrimidine bases at the 3' position of the vulnerable phosphodiester bond and a preference for purine bases at the 5' position (for review, please see Nogués et al. 1995). The enzyme has a clear preference for polynucleotide substrates rather than oligonucleotide substrates. Ribonuclease T1 of the slime mold *Aspergillus oryzae* (which is used in Japan in the brewing of sake) cleaves with high specificity the 5'-phosphodiester bond of GpN sequences of single-stranded RNA (for review, please see Steyaert 1997). Most ribonuclease protection assays nowadays are carried out with a combination of these two enzymes, which efficiently cleave most single-stranded regions of RNA to a mixture of mono- and oligonucleotides. However, they have two disadvantages: The elimination of RNase activity at the end of the digestion requires destroying the enzyme with proteinase K in the presence of SDS, and the combination of RNase A and T1 under standard digestion conditions may nick A:U-rich regions of double-stranded RNA. When analyzing RNAs rich in A:U sequences (i.e., >65% A+U), it is best to use only RNase T1, which cannot attack the 5'-phosphodiester bonds of ApN or UpN residues in single-stranded RNA. Most investigators do not find these disadvantages to be incapacitating. Nevertheless, they can certainly be bothersome and, for that reason, other single-strand-specific RNases have been used from time to time in ribonuclease protection assays.

RNase T2, which cleaves 3' of all four ribonucleotides, but strongly prefers to cleave 3' to A residues (Uchider and Egami 1967), has been used in ribonuclease protection assays (e.g., please see Saccomanno et al. 1992). In addition to its broad specificity, RNase T2 has the advantage of being easily inactivated at the end of the digestion period. A major disadvantage, however, is the high cost of T2.

Recently, RNase I of *E. coli*, expressed from the cloned gene, has become commercially available (RNase ONE, Promega). RNase ONE cleaves 3' to all four bases with no preference and is inactivated by SDS, eliminating the need for organic extractions before gel electrophoresis. Like RNase T2, RNase ONE is much more expensive than a mixture of RNases A and T1.

For all types of RNases, the efficiency of digesting single-stranded RNA and the specificity of the reaction are a function of enzyme concentration. The penalty for using too much enzyme is a loss of specificity, resulting in partial digestion of double-stranded RNA. Too little enzyme, on the other hand, results in a failure to degrade single-stranded RNA.

## MATERIALS

▲ **IMPORTANT** Prepare all reagents used in this protocol with DEPC-treated H<sub>2</sub>O (please see the information panel on **HOW TO WIN THE BATTLE WITH RNASE**).

**CAUTION:** Please see Appendix 12 for appropriate handling of materials marked with <!>.

### Buffers and Solutions

Please see Appendix 1 for components of stock solutions, buffers, and reagents. Dilute stock to the appropriate working concentration.

*Ammonium acetate* (10 M) <!>

*Dithiothreitol* (0.2 M)

*Ethanol*

*Hybridization buffer* (for RNA)

40 mM PIPES (pH 6.8)

1 mM EDTA (pH 8.0)

0.4 M NaCl

80% deionized formamide <!>

Use the disodium salt of PIPES (piperazine-*N,N'*-bis[2-ethanesulfonic acid]) and adjust the pH with 1 N HCl.

*Phenol:chloroform (1:1, v/v) <!>*

*RNA gel-loading buffer*

- 95% deionized formamide <!>
- 0.025% (w/v) bromophenol blue
- 0.025% (w/v) xylene cyanol FF
- 5 mM EDTA (pH 8.0)
- 0.025% (w/v) SDS

Purchase a distilled deionized preparation of formamide and store in small aliquots under nitrogen at  $-20^{\circ}\text{C}$ . Alternatively, reagent-grade formamide can be deionized as described in Appendix 1.

*SDS (10% w/v)*

*Sodium acetate (3 M, pH 5.2)*

*TE (pH 7.6)*

*10x Transcription buffer*

- 0.4 M Tris-Cl (pH 7.5)
- 0.1 M NaCl
- 60 mM  $\text{MgCl}_2$
- 20 mM spermidine

Store in aliquots at  $-20^{\circ}\text{C}$ .

*Trichloroacetic acid (1% and 10% TCA) <!>*

Dilute 100% stock solution 1/10 and 1/100 just before use. Chill the working solutions in ice.

## Enzymes and Buffers

*Bacteriophage-encoded DNA-dependent RNA polymerases*

T3, SP6, or T7, depending on the plasmid vector and on the strand of DNA to be transcribed. If, as is often the case, the bacteriophage RNA polymerase supplied by the manufacturer is highly concentrated, prepare an appropriate dilution of the enzyme in polymerase dilution buffer.

*DNase I (1 mg/ml, RNase-free pancreatic DNase)*

This enzyme is available from several manufacturers (e.g., RQ1 from Promega).

*Polymerase dilution buffer*

Prepare solution fresh for each use.

*Proteinase K (10 mg/ml)*

*Protein inhibitor of RNase, chill in ice*

These inhibitors are sold by several manufacturers under various trade names (e.g., RNasin, Promega; Prime Inhibitor, 5 Prime $\rightarrow$ 3 Prime). For more details, please see the information panel on **INHIBITORS OF RNASES**.

*RNase digestion mixture*

- 300 mM NaCl
- 10 mM Tris-Cl (pH 7.4)
- 5 mM EDTA (pH 7.5)
- 40  $\mu\text{g/ml}$  RNase A
- 2  $\mu\text{g/ml}$  RNase T1

Prepare 10 mg/ml ribonuclease A (bovine pancreatic RNase) in 10 mM Tris-Cl (pH 7.5), 15 mM NaCl. Prepare 1 mg/ml ribonuclease T1 in 10 mM Tris-Cl (pH 7.5), 15 mM NaCl.

Add the RNases fresh each time, just before digestion; 300  $\mu\text{l}$  of digestion mixture is required for each digestion.

## Gels

*Denaturing polyacrylamide gel <!> containing 8 M urea*

For most 5'- and 3'-end mapping experiments, a denaturing gel composed of 5% or 6% polyacrylamide and containing 8 M urea nicely resolves protected DNA fragments. A typical gel is 1.5 mm thick. However, "thin" or "sequencing" gels (0.4-mm thickness) can also be used (please see Chapter 12). If thin gels are used to resolve protected DNA fragments, it is usually not necessary to fix the gel in trichloroacetic acid (TCA), as described in Steps 22–24, before drying the gel. Fixing sharpens and increases the resolution of thicker gels. In many cases, a miniprotein gel apparatus (e.g., Bio-Rad Mini-Protean) (13 cm  $\times$  13 cm  $\times$  1 mm) can be used both to prepare the radiolabeled single-stranded DNA or

RNA probe and to analyze the products of ribonuclease digestion. Table 7-6 (Protocol 10) shows the percentage of polyacrylamide used to purify DNA fragments of various sizes; Table 7-7 (Protocol 10) shows the expected mobilities of tracking dyes on these gels. The method used to prepare the polyacrylamide gel is described in Step 1 of Protocol 10. The preparation of larger gels is described in Chapter 12, Protocol 8.

## Nucleic Acids and Oligonucleotides

### Carrier RNA (1 mg/ml)

Prepare a stock of carrier RNA by dissolving commercially available yeast tRNA at a concentration of 10 mg/ml in sterile TE (pH 7.6) containing 0.1 M NaCl. Extract the solution twice with phenol (equilibrated in Tris-Cl [pH 7.6]) and twice with chloroform. Recover RNA by precipitation with 2.5 volumes of ethanol at room temperature. Dissolve the precipitated RNA at a concentration of 10 mg/ml in sterile TE (pH 7.6), divide the stock into small aliquots, and store them at  $-20^{\circ}\text{C}$ .

### Plasmid DNA or linearized target DNA for preparing templates

If a plasmid DNA is used to prepare templates (please see Step 1), clone the DNA segment of interest into a plasmid vector of the pGEM (Promega) or Bluescript (Stratagene) series. pGEM plasmids contain promoters recognized by RNA polymerases from bacteriophages SP6 and T7, whereas Bluescript plasmids contain bacteriophage T7 and T3 promoters (please see the information panel on **PROMOTER SEQUENCES RECOGNIZED BY BACTERIOPHAGE-ENCODED RNA POLYMERASES**). Minipreparations of plasmid DNA are adequate but not optimal templates for *in vitro* transcription reactions. Better results are usually obtained from large-scale preparations purified from alkaline lysates of bacterial cultures by precipitation with polyethylene glycol (please see Chapter 1, Protocol 8).

### Ribonucleotides

Prepare a solution containing GTP, CTP, and ATP, each at a concentration of 5 mM.

### RNA, for use as standards

RNA standards are synthesized *in vitro* by transcription of the appropriate strand of a recombinant plasmid containing DNA sequences of interest and a bacteriophage promoter (please see Chapter 9, Protocol 6). By cloning an appropriate fragment of the gene of interest, it is possible to distinguish by size between authentic mRNA in the test sample and the signal from the RNA standard (Pape et al. 1991).

### Test RNA

Poly(A)<sup>+</sup> or total RNA prepared by one of the methods described in Protocols 1 through 4 of this chapter. In some cases, treatment of total RNA with RNase-free DNase may improve the accuracy of RNase protection (Dixon et al. 1997).

### UTP (100 $\mu\text{M}$ )

## Probes

### Riboprobe

The riboprobe is prepared in Steps 1–7 of this protocol.

## Radioactive Compounds

### [ $\alpha$ - $^{32}\text{P}$ ]UTP (10 mCi/ml, 800 Ci/mmol) <1>

[ $\alpha$ - $^{32}\text{P}$ ]UTP is the radiolabel of choice because it is specific to RNA. However, some investigators prefer to use [ $\alpha$ - $^{32}\text{P}$ ]GTP because bacteriophage SP6 RNA polymerase tolerates low concentrations of this ribonucleotide slightly better than it tolerates low concentrations of any of the other three.

## Special Equipment

Water baths preset to  $30^{\circ}\text{C}$ ,  $85^{\circ}\text{C}$ , and  $95^{\circ}\text{C}$  and the appropriate annealing temperature (please see Step 10).

Whatman 3MM filter paper (or equivalent)

## Additional Reagents

Step 1 of this protocol may require the reagents listed in Chapter 8, Protocol 1.

Step 7 of this protocol requires the reagents listed in Protocol 10 of this chapter.



## METHOD

---

### Preparation of Randomly Labeled Single-stranded RNA Probe

1. Prepare the linearized template DNA.

Templates for *in vitro* transcription can be generated by cloning the DNA sequence of interest downstream from a bacteriophage promoter or by amplifying the DNA of interest by PCR using oligonucleotide primers that contain a bacteriophage promoter.

#### TO PREPARE TEMPLATE FROM PLASMID DNA

- a. Linearize 5–20  $\mu\text{g}$  of plasmid DNA by digestion with a fivefold excess of an appropriate restriction enzyme that cleaves either within the cloned DNA sequence or downstream from the DNA sequence. The distance from the promoter to the newly created terminus should be 200–400 bp. Make sure not to use an enzyme that separates the promoter from the sequence of interest. Because bacteriophage-encoded RNA polymerases may initiate transcription at 3'-protruding termini, choose a restriction enzyme that generates a blunt terminus or a 5' extension.
- b. At the end of the digestion, analyze an aliquot (~200 ng) of the reaction by agarose gel electrophoresis. No trace of circular plasmid DNA should be visible. If necessary, add more restriction enzyme and continue digestion until no more circular plasmid DNA can be detected.
- c. Purify the linear DNA by extracting twice with phenol:chloroform and then recover the DNA by standard precipitation with ethanol. After washing the precipitate with 70% ethanol, dissolve the DNA in TE (pH 7.6) at a concentration of 1  $\mu\text{g}/\mu\text{l}$ .

When precipitating small amounts (<1  $\mu\text{g}$ ) of linear plasmid DNA, glycogen is the preferred carrier, since it does not interfere with transcription reactions.

#### TO PREPARE TEMPLATE BY AMPLIFICATION OF TARGET DNA

- a. Carry out PCR to synthesize double-stranded DNA templates, 100–400 bp in length, (Schowalter and Sommer 1989; Bales et al. 1993; Davis et al. 1997; please see Chapter 8, Protocol 1 for details).

The template should be either linearized plasmid DNA or a DNA fragment encoding the sequence of interest. Either one or both of the oligonucleotide primers are designed to contain the consensus sequence of a bacteriophage promoter at their 5' termini (please see the information panel on **PROMOTER SEQUENCES RECOGNIZED BY BACTERIOPHAGE-ENCODED RNA POLYMERASES**). Amplification in PCR yields double-stranded DNA fragments carrying bacteriophage promoters at one or both ends.

- b. Analyze the products of the PCR by electrophoresis through an agarose or a polyacrylamide gel to ensure that a DNA fragment of the appropriate size has been amplified.
- c. Purify the linear amplification product by extracting twice with phenol:chloroform and then recover the DNA by standard precipitation with ethanol. After washing with 70% ethanol, dissolve the DNA in TE (pH 7.6) at a concentration of 1  $\mu\text{g}/\mu\text{l}$ .

2. Mix the following in order, prewarmed to room temperature except when noted otherwise.

0.5 µg of linearized template DNA (from Step 1)  
 1 µl of 0.2 M dithiothreitol  
 2 µl of ribonucleotide solution  
 1 µl of 100 µM UTP  
 50–100 µCi [ $\alpha$ -<sup>32</sup>P]UTP (800 Ci/mmol, 10 mCi/ml)  
 H<sub>2</sub>O to a volume of 16 µl  
 2 µl of 10X transcription buffer  
 24 units of protein inhibitor of RNase (on ice)  
 15–20 units of bacteriophage RNA polymerase (on ice)

Adding the reagents in the order shown at room temperature prevents both precipitation of the DNA by spermidine and Mg<sup>2+</sup> in the transcription buffer and inactivation of the RNase inhibitor by high concentrations of dithiothreitol.

If, as is often the case, the bacteriophage RNA polymerase supplied by the manufacturer is highly concentrated, prepare an appropriate dilution of the enzyme in polymerase dilution buffer.

Incubate the reaction mixture for 60 minutes at 37°C.

The specific activity of the RNA synthesized in the reaction will be high (~10<sup>9</sup> cpm/µg) since 60–80% of the radiolabeled UTP will be incorporated. The total yield of RNA should be ~100 ng.

3. At the end of the incubation period, add 1 unit of RNase-free DNase equivalent to ~1 µg of the enzyme and continue incubation for a further 10 minutes at 37°C.

*Carry Out the Next Two Steps (4 and 5) Simultaneously*

4. Dilute the reaction mixture to 100 µl with TE (pH 7.6) and measure the total radioactivity and the amount of TCA-precipitable radioactivity in 1-µl aliquots of the diluted mixture (please see Appendix 8). From the fraction of radioactivity incorporated in TCA-precipitable material, calculate the weight and specific activity of the RNA probe synthesized in the reaction.
5. After removing 1-µl aliquots in Step 4, add 1 µl of 1 mg/ml carrier RNA to the remainder of the diluted reaction mixture. Extract the diluted reaction mixture once with phenol:chloroform. Transfer the aqueous phase to a fresh tube and precipitate the RNA by adding 10 µl of 10 M ammonium acetate and 300 µl of ethanol. Store the tube at –20°C until Step 4 has been completed.

A solution of carrier RNA (1 mg/ml) is prepared by diluting the stock solution 1:10 with DEPC-treated H<sub>2</sub>O.

6. Recover the RNA by centrifugation at maximum speed for 10 minutes at 4°C in a microfuge. Wash the RNA pellet with 75% ethanol and centrifuge again. Remove the supernatant and allow the pellet of RNA to dry in the air until no visible trace of ethanol remains. Dissolve the RNA in 20 µl of gel-loading buffer if the probe is to be purified by gel electrophoresis (Step 7) or in 20 µl of TE (pH 7.6) if the probe is to be used without further purification.

Gel purification is recommended because it allows full-length transcripts to be isolated free of unincorporated nucleotides, shorter RNA products, and fragments of template DNA. When the transcription reaction contains a limiting concentration of one or more rNTPs, synthesis of RNA chains may be aborted. When rNTPs are not limiting, more than 90% of the transcripts will appear as a single band of the expected size. Contamination with RNase will result in the appearance of a smear of smaller fragments of RNA in the gel (please see Melton et al. 1984; Krieg and Melton 1987).

7. Following the instructions given in Steps 8–16 of Protocol 10, purify the probe by electrophoresis using the previously prepared polyacrylamide/8 M urea gel.

High-specific-activity probes should be used within a few days of synthesis to avoid problems caused by radiochemical damage to the RNA.

## Hybridization of RNAs and Digestion of Hybrids with Ribonucleases

8. Combine each of the test RNAs and RNA standards with the riboprobe ( $2 \times 10^5$  to  $10 \times 10^5$  cpm, 0.1–0.5 ng) (please see the panel on **SETTING UP HYBRIDIZATIONS FOR RIBONUCLEASE PROTECTION ASSAYS**). Add 0.1 volume of 3 M sodium acetate (pH 5.2) and 2.5 volumes of ice-cold ethanol. Store the mixtures for 10 minutes at  $-20^\circ\text{C}$  and then recover the RNAs by centrifugation at maximum speed for 10 minutes at  $4^\circ\text{C}$  in a microfuge. Wash the pellet in 75% ethanol. Carefully remove all of the ethanol and store the pellet at room temperature until the last visible traces of ethanol have evaporated.

Do not allow the pellet to become desiccated, otherwise it will be difficult to dissolve.

All reactions should contain the same amount of RNA to ensure that digestion with ribonuclease is carried out under near identical conditions. If necessary, adjust the amount of RNA in the hybridization reactions by adding carrier RNA.

To quantify the target sequences in the preparations of RNA under test, set up a series of hybridization reactions containing a constant amount of radiolabeled probe, a constant amount of control RNA (i.e., RNA known to lack the target sequences), and amounts (1 fg to 100 pg) of a standard preparation of RNA synthesized *in vitro*; 10  $\mu\text{g}$  of total cellular RNA will contain 10 fg to 1 pg of a rare mRNA and  $\sim 300$  pg of a moderately abundant mRNA such as  $\beta$ -actin or GAPDH.

9. Dissolve the RNAs in 30  $\mu\text{l}$  of hybridization buffer. Pipette the solution up and down numerous times to ensure that the pellet is completely dissolved.

It is often difficult to obtain complete dissolution of the pellet of nucleic acids in hybridization buffer. This problem is exacerbated if the pellet is dried under vacuum or stored in a desiccator. Sometimes the pellet can be dissolved by a combination of vigorous pipetting and heating to  $60^\circ\text{C}$ . If difficulties persist, or if equivalent signals are not obtained from duplicate samples of RNA, the following procedure is recommended: (i) Dissolve the RNA pellet (from Step 8) in 40–50  $\mu\text{l}$  of  $\text{H}_2\text{O}$ . Evaporate the sample in a rotary evaporator until it is just dry. (ii) Add 30  $\mu\text{l}$  of hybridization buffer. The hydrated pellet should go into solution quickly and easily and yield reproducible results.

### SETTING UP HYBRIDIZATIONS FOR RIBONUCLEASE PROTECTION ASSAYS

The amount of unlabeled test RNA required depends on the abundance of the sequences of interest and the specific activity of the radiolabeled complementary RNA. Before embarking on large-scale experiments, it is advisable to carry out preliminary experiments to establish the range of concentrations of RNAs that yield acceptable results. With RNA probes that have been radiolabeled to high specific activity ( $>10^9$  cpm/ $\mu\text{g}$ ), 10  $\mu\text{g}$  of total RNA is usually sufficient to allow detection of mRNA species that are present at the level of 1–5 copies/cell. To detect sequences present in lower amounts (e.g., in RNA extracted from heterogeneous populations of cells), up to 150  $\mu\text{g}$  of RNA may be used in a 30- $\mu\text{l}$  hybridization reaction. For ease of manipulation in subsequent steps, it is advisable to keep the hybridization volume to 30  $\mu\text{l}$  or less. If reagents are in short supply, the hybridization reactions can be scaled down to 10  $\mu\text{l}$ .

When comparing different preparations of RNA, make sure that all of the reactions contain the same amount of RNA. In this way, digestion with RNase is carried out under standard conditions. If necessary, adjust the amount of RNA in the hybridization reactions by adding carrier RNA.

Usually,  $1 \times 10^5$  to  $5 \times 10^5$  cpm of probe are used per hybridization reaction. A single *in vitro* transcription reaction with bacteriophage DNA-dependent RNA polymerase generates enough probe ( $\sim 2$  pmoles) for more than 200 hybridization reactions. However, because background increases as more probe is added to the hybridization reaction, add only enough probe to achieve a small molar excess. This amount is usually determined empirically by RNase digestion of a series of hybridization mixtures containing different ratios of probe RNA to target RNA. If necessary, the system can be calibrated by setting up a series of control reactions containing a constant amount of radiolabeled RNA and increasing amounts of unlabeled RNA transcribed *in vitro* from the opposite strand of an appropriate double-stranded DNA template (please see Chapter 9, Protocol 6).

10. Incubate the hybridization mixture for 10 minutes at 85°C to denature the RNAs. Quickly transfer the hybridization mixture to an incubator or water bath set at the annealing temperature. Incubate the mixture for 8–12 hours.

The optimal temperature for annealing varies from RNA to RNA, presumably depending on such factors as G+C content and propensity to form secondary structures. In most cases, satisfactory results are obtained when the RNA is annealed at 45–50°C. Optimal conditions for the hybridization of specific probes can be established by reconstruction experiments, in which the radiolabeled probe is hybridized, at temperatures ranging between 25°C and 65°C, to unlabeled RNA transcribed in vitro from the opposite strand of an appropriate double-stranded DNA template (please see Chapter 9, Protocol 6; please also see the panel on **SETTING UP HYBRIDIZATIONS FOR RIBONUCLEASE PROTECTION ASSAYS**).

11. Cool the hybridization mixture to room temperature, and add 300 µl of RNase digestion mixture. Digest the hybridization reaction for 60 minutes at 30°C.

The time and temperature of the digestion with RNase should be determined empirically if the signal-to-noise ratio detected after autoradiography is unacceptable.

In some cases, the specificity and sensitivity of detection can be improved by cooling the hybridization reaction on ice for 10–20 minutes before the addition of the RNase digestion mixture. This cooling may stabilize the ends of RNA-RNA hybrids.

12. Add 20 µl of 10% SDS and 10 µl of 10 mg/ml proteinase K to stop the reaction. Incubate the reaction mixture for 30 minutes at 37°C.
13. Add 400 µl of phenol:chloroform, vortex the mixture for 30 seconds, and separate the phases by centrifugation at maximum speed for 5 minutes at room temperature in a microfuge.
14. Transfer the upper aqueous phase to a fresh tube, carefully avoiding the interface between the organic and aqueous phases.
15. Add 20 µg of carrier RNA and 750 µl of ice-cold ethanol. Mix the solution well by vortexing, and then store the solution for 30 minutes at –20°C.
16. Recover the RNA by centrifugation at maximum speed for 15 minutes at 4°C in a microfuge. Carefully remove the ethanol and wash the pellet with 500 µl of 70% ethanol. Centrifuge as before.
17. Carefully remove all of the ethanol, and store the open tube at room temperature until the last visible traces of ethanol have evaporated.

### Analysis of the RNase-resistant Hybrids by Gel Electrophoresis

18. Resuspend the precipitate in 10 µl of gel-loading buffer.
19. Heat the nucleic acids for 5 minutes at 95°C, and then immediately transfer the tube to an ice bath. Centrifuge the tubes briefly in a microfuge to consolidate the samples at the bottom of the tubes.
20. Analyze the radiolabeled RNA by electrophoresis through a “thin” polyacrylamide/8 M urea gel.

For most applications, a 5–6% polyacrylamide/8 M urea gel of 1.5-mm thickness will suffice. As molecular-weight markers, use a DNA sequencing ladder or end-labeled fragments of DNA of known size (e.g., an *MspI* digest of pBR322, end-labeled with [ $\alpha$ -<sup>32</sup>P]dGTP or an *HaeIII* digest of  $\phi$ X174 end-labeled with [ $\alpha$ -<sup>32</sup>P]dGTP). During electrophoresis, enough current should be run through the gel to keep the glass plates warm to the touch. The relative mobility of RNA and DNA through polyacrylamide/8 M urea gels varies according to the conditions used for electrophoresis. In general, the faster the gel is run, the less the difference in mobility between RNA and DNA molecules of identical size. Under the conditions normally used (40–45 V/cm), RNA runs ~5–10% more slowly than DNA of the same size. Thus, a 90-nucleotide RNA will migrate at approximately the same rate as a 100-nucleotide DNA. If absolute measurement of the size of the RNA is

required, the use of a series of radioactive RNA probes of defined length is recommended. These size standards can be generated by *in vitro* transcription of a double-stranded DNA template after digestion with restriction enzymes that cleave at sites progressively more distal to a bacteriophage promoter. Alternatively, the standards can be produced by end labeling commercially available RNA markers with [ $\alpha$ - $^{32}$ P]cordycepin and poly(A) polymerase.

21. After the tracking dyes have migrated an appropriate distance through the gel (please see Table 7-7), turn off the power supply and dismantle the electrophoresis set up. Gently pry up one corner of the larger glass plate and slowly remove the plate from the gel. Cut off one corner of the gel for orientation purposes.

▲ **WARNING** Wear eye protection when prying the glass plates apart.

22. Transfer the glass plate containing the gel to a tray containing an excess of 10% TCA. Gently rock or rotate the tray for 10 minutes at room temperature.

The gel will usually float off the glass plate during this incubation. Do not allow the floating gel to fold up on itself.

23. Pour off the 10% TCA solution and replace with an excess of 1% TCA. Gently rock or rotate the tray for 5 minutes at room temperature.

24. Pour off the 1% TCA solution and briefly rinse the fixed gel with distilled deionized H<sub>2</sub>O. Lift the glass plate together with the gel out of the tray and place them on a flat bench top. Apply paper towels or Kimwipes to the sides of the gel to remove excess H<sub>2</sub>O.

Do not place towels on top of the gel.

25. Cut a piece of Whatman 3MM filter paper (or equivalent) that is 1 cm larger than the gel on all sides. Transfer the gel to the filter paper by laying the paper on top of the gel and inverting the glass plate.

26. Remove the plate and dry the gel on a gel dryer for 1.0–1.5 hours at 60°C.

27. Establish an autoradiographic image of the dried gel. Scan the image by densitometry or phosphorimaging, or excise the segments of the gel containing the fragments and count them by liquid scintillation spectroscopy.

From the samples containing different amounts of standard RNA, a curve of mass versus radioactivity can be constructed. The amount of target sequences in the test preparations of RNA can then be estimated by interpolation.

# Protocol 12

---

## Analysis of RNA by Primer Extension

**P**RIMER EXTENSION IS USED CHIEFLY TO MAP THE 5' TERMINI of mRNAs. A preparation of poly(A)<sup>+</sup> RNA is first hybridized with an excess of a single-stranded oligodeoxynucleotide primer, radiolabeled at its 5' terminus, which is complementary to the target RNA. The enzyme reverse transcriptase is then used to extend the primer. The resulting cDNA is complementary to the RNA template and is equal in length to the distance between the 5' end of the priming oligonucleotide and the 5' terminus of the RNA.

In the past, primer extension has also been used for additional purposes: to measure the abundance of particular target mRNAs, to detect splice variants of mRNAs, and to map precursors and processing intermediates of mRNA (for review, please see Boorstein and Craig 1989). However, ribonuclease protection and nuclease S1 assays are now preferred for these tasks because of their greater sensitivity. Nevertheless, primer extension remains the firm choice for the mapping of 5' termini of mRNAs. Once initiated by a primer, the extension reaction generally proceeds to the extreme 5' terminus of an RNA template and its size can be measured with great accuracy. In addition, the length of the product is unaffected by the distribution and size of introns in the target gene, which can confound the mapping of mRNAs by hybridization to genomic templates. Short exons at the 5' terminus of an mRNA are easily overlooked in methods such as nuclease S1 and RNase protection that rely on digestion of hybrids.

Almost all primer extension assays are carried out using synthetic oligonucleotide primers, 20–30 nucleotides in length (for further details, please see Chapter 10). The best results are obtained when oligonucleotide primers are used that hybridize to target sequences located within 150 nucleotides of the 5' terminus of the mRNA. Primers that hybridize to more distant sites can give rise to heterogeneous extension products because reverse transcriptase may stop or pause in regions of high secondary structure in the template RNA. The design of the primer should therefore take into account the position of hybridization in addition to the actual sequence of the primer. Wherever possible, oligonucleotide primers should have a GC content of ~50% and should have a G or C residue at the 3' terminus. Ideally, two primers should be used that hybridize to regions of the mRNA separated by a known distance (e.g., 20–50 nucleotides). Primer extension products that differ in size by an amount equivalent to the distance between the two primers provide confirmation of the results. It may be necessary to synthesize several primers in order to find a pair that yield clean extension products.

## OPTIMIZING PRIMER EXTENSION REACTIONS

In many cases, the extension reaction will generate two products: full-length cDNA molecules and reverse transcripts that are one to two bases shorter. These may represent heterogeneity at the 5' terminus of the mRNAs resulting from multiple start sites of transcription. Alternatively, shorter molecules may result from premature termination of the extension reaction at the methylated residue next to the cap site in the target mRNA. The stoichiometry of the cap-related bands can vary from one preparation of mRNA to another but is generally constant for a given preparation. To distinguish between artifacts of reverse transcription and true heterogeneity of 5' termini, it is a very good idea (if not essential to get the result published) to carry out nuclease S1 analysis with probes labeled at their 5' termini (please see Protocol 10).

Preparations of poly(A)<sup>+</sup> RNA yield much cleaner results than unfractionated preparations of mammalian RNA, which often yield an unacceptably high number of prematurely terminated extension products. This artifact can be minimized by performing the reaction in the presence of higher (5 mM) concentrations of dNTPs and using a primer that is complementary to sequences that lie within 50–100 nucleotides of the 5' terminus of the mRNA.

At one time, it was mandatory to purify the oligonucleotide primers by polyacrylamide gel electrophoresis to remove shorter molecules (Boorstein and Craig 1989). These days, however, many investigators do not bother with purification unless the analysis is complicated by the persistent presence of a ladder of extension products.

The oligonucleotide primer should be present in about tenfold molar excess over the target mRNA in the hybridization reaction. The presence of larger quantities of primer may result in nonspecific priming and the appearance of artifactual bands. It is therefore advisable to carry out a series of pilot reactions that contain a constant amount of RNA and different amounts of primer — usually 20–40 fmoles ( $\sim 10^4$  to  $10^5$  cpm).

The annealing temperature can greatly affect the quality of the results of primer extension experiments, and it is therefore worth investing some time in preliminary experiments to determine the optimal annealing temperature. In most cases, where the primer is  $\sim 50\%$  GC and is 20–30 nucleotides in length, the optimum annealing temperature will be between 40°C and 60°C. To determine the optimum temperature, set up and analyze a series of identical primer extension reactions that have been hybridized at temperatures differing by 5°C.

End-labeled DNA fragments of known size may be used as molecular-weight markers when analyzing primer extension products by gel electrophoresis. Even better, however, is a DNA sequencing ladder established on a DNA template with the same oligonucleotide primer used in the primer extension reaction. By reading the size of the primer extension product against the sequencing ladder, the 5' end of the target RNA can be mapped to a particular base pair.

The following protocol was developed by Thomas Südhof and supplied by Daphne Davis (both of the University of Texas Southwestern Medical Center, Dallas).

## MATERIALS

▲ **IMPORTANT** Prepare all reagents used in this protocol with DEPC-treated H<sub>2</sub>O (please see the information panel on **HOW TO WIN THE BATTLE WITH RNASE**).

**CAUTION:** Please see Appendix 12 for appropriate handling of materials marked with <!>.

## Buffers and Solutions

Please see Appendix 1 for components of stock solutions, buffers, and reagents. Dilute stock solutions to the appropriate concentrations.

Ammonium acetate (10 M) <!-->

Chloroform <!-->

Dithiothreitol (1 M)

Ethanol

Formamide loading buffer

80% deionized formamide <!-->

10 mM EDTA (pH 8.0)

1 mg/ml xylene cyanol FF

1 mg/ml bromophenol blue

Purchase a distilled deionized preparation of formamide and store in small aliquots under nitrogen at  $-20^{\circ}\text{C}$ . Alternatively, deionize reagent-grade formamide as described in Appendix 1.

Store deionized formamide in small aliquots under nitrogen at  $-70^{\circ}\text{C}$ .

KCl (1.25 M)

Phenol <!-->

Primer extension mix <!-->

20 mM Tris-Cl (pH 8.4) (at room temperature)

10 mM  $\text{MgCl}_2$

1.6 mM dNTP solution containing all four dNTPs

50  $\mu\text{g}/\text{ml}$  actinomycin D

Dissolve actinomycin D in methanol at a concentration of 5 mg/ml before supplementing the primer extension mix. Store the actinomycin D stock solution at  $-20^{\circ}\text{C}$  in the dark. Please see the information panel on **ACTINOMYCIN D**

Sodium acetate (3 M, pH 5.2)

TE (pH 7.6)

Trichloroacetic acid (1% and 10% TCA)

Dilute 100% stock solution 1/10 and 1/100 just before use. Chill the working solutions in ice.

## Enzymes and Buffers

Polynucleotide kinase

Protein inhibitor of RNase

These inhibitors are sold by several manufacturers under various trade names (e.g., RNasin, Promega, Prime Inhibitor, 5 Prime $\rightarrow$ 3 Prime). For more details, please see the information panel on **INHIBITORS OF RNASES**

Reverse transcriptase

A cloned version of reverse transcriptase encoded by the Moloney murine leukemia virus (Mo-MLV) is the enzyme of choice in this protocol. Mutants of the enzyme that lack RNase H activity (e.g., StrataScript, Stratagene) have some advantages over the wild-type enzyme since they produce higher yields of full-length extension product and work equally well at both  $47^{\circ}\text{C}$  and  $37^{\circ}\text{C}$  (for review, please see Gerard et al. 1997).

Reverse transcriptase supplied by different manufacturers varies in its activity per unit. When using a new batch of enzyme, set up a series of extension reactions containing equal amounts of poly(A)<sup>-</sup> RNA and oligonucleotide primer, and different amounts of enzyme. If possible, the primer should be specific for a mRNA present at moderate abundance in the preparation of poly(A)<sup>-</sup> RNA. Assay the products of each reaction by gel electrophoresis as described in this protocol. Use the minimal amount of enzyme required to produce the maximum yield of extension product. The units used in this protocol work well with most batches of StrataScript.

## Gels

Denaturing polyacrylamide gel <!--> containing 8 M urea

In many cases, a miniprotein gel apparatus (e.g., Bio-Rad Mini-Protean) (13 cm  $\times$  13 cm  $\times$  0.75 mm) can be used to analyze radiolabeled primer extension products. Please see Tables 7-6 and 7-7 and the note to the entry for polyacrylamide gel electrophoresis in Protocol 10. The method used to prepare a mini-denaturing polyacrylamide gel is described in Step 1 of Protocol 10. The preparation of larger gels is described in Chapter 12, Protocol 8.



## Nucleic Acids and Oligonucleotides

*Carrier RNA (yeast tRNA)*

*DNA markers, radiolabeled, for gel electrophoresis <1>*

Please see Optimizing Primer Extension Reactions (this protocol) and Appendix 6.

*Input RNA to be analyzed*

Preparations of poly(A)<sup>+</sup> RNA are preferred, especially when setting up primer extension reactions for the first time or when preparations of total RNA produce extension products of different lengths.

*Oligonucleotide primer*

These primers should be 20–30 nucleotides in length and preferentially purified through Sep-Pak chromatography and by gel electrophoresis (please see Chapter 10, Protocol 1). Crude preparations of oligonucleotides give rise to higher backgrounds on the autoradiogram, especially in the area of the film corresponding to the low-molecular-weight region of the polyacrylamide gel. Resuspend the purified oligonucleotide at a concentration of ~60 ng/μl (5–7 pmoles/μl) in TE (pH 7.6).

## Radioactive Compounds

*[γ-<sup>32</sup>P]ATP (10 mCi/ml, 7000 Ci/mmmole) <1>*

## Special Equipment

*Water baths preset to 42°C and 95°C, and the appropriate annealing temperature (please see Step 12)*

*Whatman 3MM filter paper (or equivalent)*

## METHOD

---

### Preparation of the Oligonucleotide Probe

1. Phosphorylate the oligonucleotide primer in a reaction containing:

oligonucleotide primer (5–7 pmoles or 60 ng)	1 μl
distilled deionized H <sub>2</sub> O	6.5 μl
10X kinase buffer	1.5 μl
polynucleotide kinase (~10 units)	1 μl
[γ- <sup>32</sup> P]ATP (7000 Ci/mmmole)	2 μl

Incubate the reaction for 60 minutes at 37°C.

The final concentration of radiolabeled ATP in the reaction should be ~30 nM.

2. Stop the kinase reaction with the addition of 500 μl of TE (pH 7.6). Add 25 μg of carrier RNA.
3. Add 400 μl of equilibrated phenol (pH 8.0) and 400 μl of chloroform (or 800 μl of commercial phenol:chloroform [1:1]). Vortex vigorously for 20 seconds. Separate the aqueous and organic phases by centrifugation for 2 minutes in a microfuge.
4. Transfer the aqueous layer to a fresh sterile microfuge tube and extract with 800 μl of chloroform. Vortex vigorously for 20 seconds. Separate the aqueous and organic phases by centrifugation for 2 minutes in a microfuge. Again transfer the aqueous layer to a fresh sterile microfuge tube.
5. Repeat Step 4.
6. Add 55 μl of sterile 3 M sodium acetate (pH 5.2) and 1 ml of ethanol to the aqueous layer from Step 5. Mix by vortexing and store the solution for at least 1 hour at –70°C.

7. Collect the precipitated oligonucleotide primer by centrifugation at maximum speed for 15 minutes at 4°C in a microfuge. Remove and discard the radioactive supernatant. Wash the pellet in 70% ethanol and centrifuge again. Discard the supernatant and dry the precipitate in the air. Dissolve the precipitate in 500 µl of TE (pH 7.6).
8. Count 2 µl of radiolabeled oligonucleotide primer in 10 ml of scintillation fluid in a liquid scintillation counter. Calculate the specific activity of the radiolabeled primer assuming 80% recovery. The specific activity should be  $\sim 2 \times 10^6$  cpm/pmole of primer.

### Hybridization and Extension of the Oligonucleotide Primer

9. Mix  $10^4$  to  $10^5$  cpm (20–40 fmoles) of the DNA primer with 0.5–150 µg of the RNA to be analyzed. Add 0.1 volume of 3 M sodium acetate (pH 5.2) and 2.5 volumes of ethanol. Store the solution for 60 minutes at –70°C, and then recover the RNA by centrifugation at maximum speed for 10 minutes at 4°C in a microfuge. Wash the pellet with 70% ethanol and centrifuge again. Carefully remove all of the ethanol, and store the pellet at room temperature until the last visible traces of ethanol have evaporated.

The primer should be in about tenfold molar excess over the template RNA (please see the discussion on Optimizing Primer Extension Reactions in the introduction to this protocol).

10. Resuspend the pellets in 8 µl of TE (pH 7.6) per tube. Pipette the samples up and down several times to dissolve pellets.
11. Add 2.2 µl of 1.25 M KCl. Vortex the samples gently and then deposit the fluid in the base of the tubes by centrifuging for 2 seconds in a microfuge.
12. Place the oligonucleotide/RNA mixtures in a water bath set at the appropriate annealing temperature. Incubate the samples for 15 minutes at the optimum temperature, as determined in preliminary experiments (please see the discussion on Optimizing Primer Extension Reactions in the introduction to this protocol).

The kinetics of annealing between the oligonucleotide primer and the mRNA template are remarkably rapid under typical primer extension conditions, in which the primer is in excess of the target mRNA. For this reason, the time of annealing in Step 12 can be limited to 15 minutes. Some protocols include elaborate heating and cooling routines at this step, but in our hands, these Byzantine variations are rarely necessary.

13. While the oligonucleotide and RNA are annealing, supplement an aliquot of primer extension mix with dithiothreitol and reverse transcriptase as follows: Thaw a 300-µl aliquot of primer extension mix on ice and then add 3 µl of 1 M dithiothreitol and reverse transcriptase to a concentration of 1–2 units/µl. Add 0.1 unit/µl of protein inhibitor of RNase, gently mix by inverting the tube several times, and store it on ice.

It is possible to establish the DNA sequence of a primer-extended product by including dideoxynucleotides (terminators) in the reaction mix. In a 5'-end mapping experiment, knowing the exact sequence of the primer extended product allows precise positioning of the end in the 5'-flanking region of the gene. This approach has been successful in many labs when examining mRNAs that are relatively abundant in the cell (class I antigens, rat liver steroid 5 $\alpha$ -reductase mRNA, and yeast alcohol dehydrogenase 2 mRNA). For protocols on primer extension sequencing, please see Geliebter et al. (1986) and Hahn et al. (1989).

14. Remove the tubes containing the oligonucleotide primer and RNA from the water bath and deposit the fluid in the base of the tubes by centrifuging for 2 seconds in a microfuge.
15. Add 24 µl of supplemented primer extension mix to each tube. Gently mix the solution in the tubes and again deposit the liquid at the tube bottoms by centrifugation.
16. Incubate the tubes for 1 hour at 42°C to allow the primer extension reaction to proceed.

17. Terminate the primer extension reactions by the addition of 200  $\mu\text{l}$  of TE (pH 7.6), 100  $\mu\text{l}$  of equilibrated phenol (pH 8.0), and 100  $\mu\text{l}$  of chloroform. Vortex for 20 seconds. Separate aqueous and organic phases by centrifugation for 4 minutes at room temperature in a microfuge.

There is often a considerable amount of radioactivity remaining in the well of the polyacrylamide gel after electrophoresis (Step 22 below). In our hands, there is rarely a correlation between the amount of this radioactivity in the well and the amount of the desired primer extension product. The aggregated material in the well may represent longer extension products derived by spurious priming of the oligonucleotide on nontarget mRNAs or contaminating genomic DNA templates. Rarely, this background can represent aggregates of the desired primer extension product with molecules of RNA.

If there is a significant amount of radioactivity trapped in the well of the gel, try treating the primer-extended products after Step 16 with RNase: Add 1  $\mu\text{l}$  of 0.5 M EDTA (pH 8.0) and 1  $\mu\text{l}$  of DNase-free pancreatic RNase (5 mg/ml) (please see Appendix 4) to each tube and incubate the reactions for 30 minutes at 37°C. Add 150  $\mu\text{l}$  of TE (pH 7.6) containing 0.1 M NaCl and 200  $\mu\text{l}$  of phenol:chloroform. Vortex for 30 seconds, and centrifuge at maximum speed for 5 minutes at room temperature in a microfuge. Continue the protocol at Step 18. Alternatively, the primer-extended products from Step 16 can be treated with NaOH to hydrolyze the RNA template prior to electrophoresis: Add 1.0  $\mu\text{l}$  of 10 N NaOH to the solution and incubate for 10 minutes at room temperature. Neutralize the NaOH by the addition of one-tenth volume of 3 M sodium acetate (pH 5.2) and continue the protocol at Step 17.

18. Precipitate the nucleic acids by the addition of 50  $\mu\text{l}$  of 10 M ammonium acetate and 700  $\mu\text{l}$  of ethanol. Mix well by vortexing and incubate ethanol precipitations for at least 1 hour at  $-70^{\circ}\text{C}$ .

### Purification and Analysis of the Primer Extension Products

19. Collect the precipitated nucleic acids by centrifugation for 10 minutes at 4°C in a microfuge. Carefully rinse the pellets with 400  $\mu\text{l}$  of 70% ethanol. Centrifuge again for 5 minutes at 4°C and remove the 70% ethanol rinse with a pipette. Store the open tubes at room temperature until all visible traces of ethanol have evaporated.
20. Dissolve the nucleic acid precipitates in 10  $\mu\text{l}$  of formamide loading buffer. Pipette the samples up and down to assist resuspension.
21. Heat the samples for 8 minutes at 95°C. Then plunge the tubes into an ice-water bath and immediately analyze the primer extension products by electrophoresis through a denaturing polyacrylamide gel.

End-labeled DNA fragments of known size should be used as molecular-weight markers on the gel (please see the discussion on Optimizing Primer Extension Reactions in the introduction to this protocol).

22. After the tracking dyes have migrated an appropriate distance through the gel (Table 7-7), turn off the power supply and dismantle the electrophoresis setup. Gently pry up one edge of the larger glass plate and slowly remove the plate from the gel. Cut off one corner of the gel for orientation purposes.

▲ **WARNING** Wear eye protection when prying the glass plates apart.

23. If a polyacrylamide gel 1.0 mm in thickness was used, fix the gel in TCA. Transfer the glass plate containing the gel to a tray containing an excess of 10% TCA. Gently rock or rotate the tray for 10 minutes at room temperature.

The gel will usually float off the glass plate during this incubation. Do not allow the gel to fold up on itself.

This step is not necessary if a thin gel (0.4-mm thickness) was used. In this case, proceed to Step 26.

24. Pour off the 10% TCA solution and replace it with an excess of 1% TCA. Gently rock or rotate the tray for 5 minutes at room temperature.
25. Pour off the 1% TCA solution and briefly rinse the fixed gel with distilled deionized H<sub>2</sub>O. Lift the glass plate together with the gel out of the tray and place them on a flat bench top. Apply paper towels or Kimwipes to the sides of the gel to remove excess H<sub>2</sub>O.  
Do not place towels on top of gel.
26. Cut a piece of Whatman 3MM filter paper (or equivalent) that is 1 cm larger than the gel on all sides. Transfer the gel to the filter paper by laying the paper on top of the gel and inverting the glass plate.
27. Remove the plate and dry the gel on a heat-assisted vacuum-driven gel dryer for 1.0–1.5 hours at 60°C.
28. Establish an image of the gel using autoradiography or phosphorimaging.

---

**HOW TO WIN THE BATTLE WITH RNASE**

---

Many an experiment has been needlessly ruined by contamination with RNase. However, problems with exogenous RNase can be entirely avoided by vigilant use of prophylactic measures and the prudent application of common sense. In our experience, contamination with exogenous RNase most frequently arises from two sources:

- **Contaminated buffers:** By careless use of aseptic technique, buffers have become contaminated with bacteria or other microorganisms. The growth of these microorganisms is not usually visible to the naked eye and need not be florid to cause problems. Because RNase cannot be removed by autoclaving, solutions that are contaminated, or are suspected of being so, must be discarded.
- **Automatic pipetting devices:** There is simply no point in using disposable pipette tips that are free of RNase if the automatic pipettor has been used previously to dispense solutions containing RNase, for example, during processing of small-scale plasmid preparations or, even worse, in ribonuclease protection assays. If the barrel or the metal ejector of the automatic pipettor comes in contact with the sides of tubes, it becomes a very efficient vector for the dissemination of RNase.

A mantric belief in the power of rubber gloves to ward off problems with RNase has taken root in many laboratories. In truth, however, snapping on a pair or two of rubber gloves is about as useful as carrying a rabbit's foot. First, the hair or beards of investigators are more likely to be the culprits than the hands, and more significantly, gloves can only provide protection until they touch a surface that has been in contact with skin. To be of any use at all, gloves must be changed every time a piece of apparatus is touched, a refrigerator opened, an ice-bucket filled, an entry written in a laboratory notebook, a reagent measured. This is neither wise nor practicable. Wear gloves, but do not believe that they offer protection against RNase. More sensible measures include the following:

- Keep a special set of automatic pipettors for use when handling RNA.
- Set aside items of glassware, batches of plasticware, and buffers that are to be used only for experiments with RNA.
- Store solution/buffers in small aliquots and discard each aliquot after use. Avoid materials or stock solutions that have been used for any other purposes in the laboratory.
- Set aside special electrophoresis devices for use in the separation of RNA. Clean these devices with detergent solution, rinse in H<sub>2</sub>O, dry with ethanol, and then fill with a 3% solution of H<sub>2</sub>O<sub>2</sub>. After 10 minutes at room temperature, rinse the electrophoresis tank thoroughly with H<sub>2</sub>O that has been treated with DEPC (please see the information panel on **DIETHYLPYROCARBONATE**).
- Prepare all solutions and buffers with RNase-free glassware, DEPC-treated water, and chemicals reserved for work with RNA that are handled with disposable spatulas or dispensed by tapping the bottle rather than using a spatula. Wherever possible, treat solutions with 0.1% DEPC for at least 1 hour at 37°C and then autoclave for 15 minutes at 15 psi (1.05 kg/cm<sup>2</sup>) on liquid cycle.
- Autoclaving glassware and plasticware may not be sufficient to inactivate RNase. Bake glassware for 4 hours at 300°C. Treat plasticware either with DEPC or commercially available products that inactivate RNase upon contact (e.g., RNaseZap from Ambion Inc.).
- Use disposable tips and microfuge tubes certified by a reputable manufacturer to be free of RNase. To reduce the chances of contamination, it is best to use sterile forceps when transferring these small items from their original packages to laboratory racks.
- Use inhibitors to suppress RNases during the isolation of RNA (please see the information panel on **INHIBITORS OF RNASES**).

---

**INHIBITORS OF RNASES**

---

RNases are robust and powerful enzymes that seriously threaten the integrity of RNA at all stages of its isolation and characterization. Three types of inhibitors are commonly used to keep the activity of RNases in check:

- **Diethylpyrocarbonate** (DEPC), a highly reactive alkylating agent, is used to inactivate RNases in buffers and on glassware. Because DEPC indiscriminately modifies proteins and RNA, it cannot be used during isolation and purification of RNA and is incompatible with some buffers (e.g., Tris). For further details, please see the information panel on **DIETHYLPYROCARBONATE**.
- **Vanadyl ribonucleoside complexes** are transition state analogs that bind to the active sites of many RNases and inhibit their catalytic activity almost completely (Berger and Birkenmeier 1979). Because vanadyl ribonucleases do not covalently modify RNases, they must be used at all stages of RNA extraction and purification. However, because these complexes inhibit RNA polymerases and in vitro translation, they must be removed from the final preparation of RNA by multiple extractions with phenol containing 0.1% hydroxyquinoline. Vanadyl ribonucleoside complexes are available from several commercial suppliers.
- **Protein inhibitors of RNases.** Many RNases bind very tightly, albeit noncovalently, to ~50-kD proteins found in the cytoplasm of virtually all mammalian tissues and can be isolated in abundance from placenta (Blackburn et al. 1977). In vivo, these proteins function as inhibitors of proteins belonging to the pancreatic RNase superfamily, notably angiogenin, a blood-vessel-inducing and eosinophyl-derived neurotoxin. The affinities of these protein inhibitors for their targets are among the highest on record (1–70 fM) (Lee et al. 1989; for review, please see Lee and Vallee 1993).

The archetypal RNase inhibitor is a horseshoe-shaped molecule, containing seven alternating leucine-rich repeats, 28 and 29 residues in length. The inhibitor also contains a large number of cysteinyl residues, all in the reduced form. The interface between ribonuclease and the inhibitor is unusually large and encompasses residues located in multiple domains of both proteins. However, the energetically important contacts involve only the carboxy-terminal segment of the inhibitor and the catalytic center of ribonuclease, including a crucial lysine residue (Kobe and Deisenhofer 1993, 1995, 1996; Papageorgiou et al. 1997; for review, please see Hofsteenge 1994).

Protein inhibitors of RNase derived from several sources are sold by many manufacturers under various trade names (e.g., RNasin, Promega; Prime Inhibitor, 5 Prime →3 Prime). Although these vary in their requirement for sulfhydryl reagents, all of them display a broad spectrum of inhibitory activities against RNases, but do not inhibit other nucleases or polymerases or in vitro translation systems (e.g., please see Murphy et al. 1995).

Because the inhibitors do not form covalent complexes with RNase, they cannot be used in the presence of denaturants such as SDS and guanidine, which are commonly used to lyse mammalian cells in the initial stages of extraction of RNA. However, the inhibitors can be included at all stages during subsequent purification of RNA. Inhibitors must be replenished several times during the purification procedure, since they are removed by extraction with phenol.

---

**DIETHYLPYROCARBONATE**


---

Diethylpyrocarbonate (DEPC) is used in molecular cloning to inactivate trace amounts of RNases that may contaminate solutions, glassware, and plasticware that are to be used for the preparation of nuclear RNA or mRNA (Penman et al. 1971; Williamson et al. 1971). DEPC is a highly reactive alkylating agent that destroys the enzymatic activity of RNase chiefly by ethoxyformylation of histidyl groups (please see Figure 7-7).

Glassware and plasticware should be filled with a solution of 0.1% DEPC in H<sub>2</sub>O and allowed to stand for 1 hour at 37°C or overnight at room temperature. Rinse the items several times with DEPC-treated H<sub>2</sub>O then autoclave them for 15 minutes at 15 psi (1.05 kg/cm<sup>2</sup>) on liquid cycle.

In aqueous solution, DEPC hydrolyzes rapidly to CO<sub>2</sub> and ethanol, with a half-life in phosphate buffer of ~20 minutes at pH 6.0 and 10 minutes at pH 7.0. This hydrolysis is greatly accelerated by Tris and other amines, which themselves become consumed in the process. DEPC therefore cannot be used to treat solutions that contain these buffers. Samples of DEPC that are free of nucleophiles (e.g., H<sub>2</sub>O and ethanol) are perfectly stable, but even small amounts of these solvents can cause complete conversion of DEPC to diethylcarbonate. For this reason, DEPC should be protected against moisture. Store it under small aliquots in dry conditions and always allow the bottle to reach ambient temperature before opening it.

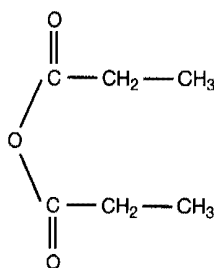
Although H<sub>2</sub>O purified through well-maintained, modern reverse-osmosis systems is free of RNase (Huang et al. 1995), poorly maintained purification systems may become contaminated by microbial growth. This situation commonly occurs in large centralized systems with many meters of piping and storage vats in which H<sub>2</sub>O can stagnate. In such cases, it may be necessary to generate DEPC-treated H<sub>2</sub>O by treatment with 0.1% DEPC for 1 hour at 37°C and autoclaving for 15 minutes at 15 psi (1.05 kg/cm<sup>2</sup>) on liquid cycle.

**Other Uses of DEPC**

In addition to reacting with histidine residues in proteins, DEPC can form alkali-labile adducts with the imidazole ring N7 of unpaired purines, resulting in cleavage of the glycosidic bond and generation of an alkali-labile abasic site (for review, please see Ehrenberg et al. 1976). Because of its high reactivity and specificity, DEPC has been used as a chemical probe of secondary structure in DNA and RNA (e.g., please see Peattie and Gilbert 1980; Herr 1985). Unpaired adenine residues are strongly reactive (Leonard et al. 1970, 1971) as are guanine residues in Z-DNA (Herr 1985; Johnston and Rich 1985). A diminution in the reactivity of purines with DEPC can therefore be used to measure binding between Z-DNA and specific proteins (Runkel and Nordheim 1986).

**Problems in Using DEPC**

Removal of DEPC by thermal degradation generates small amounts of ethanol and CO<sub>2</sub>, which can increase the ionic strength and lower the pH of unbuffered solutions. DEPC can carboxymethylate unpaired adenine residues in RNA. mRNAs that have been exposed to DEPC are translated with reduced efficiency in *in vitro* protein-synthesizing systems (Ehrenberg et al. 1976). However, the ability of DEPC-treated RNA to form DNA-RNA or RNA-RNA hybrids is not seriously affected unless a large fraction of the purine residues have been modified.




---

**FIGURE 7-7 Structure of Diethylpyrocarbonate**


---

---

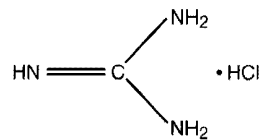
**GUANIDINIUM SALTS**

---

Guanidinium salts are chaotropic agents that destroy the three-dimensional structure of proteins. The most powerful of these commonly used protein denaturants are guanidinium isothiocyanate and guanidinium chloride, which convert most proteins to a randomly coiled state (Tanford 1968; Gordon 1972). The mechanism of this conversion is unclear, although it seems to involve binding of progressively greater amounts of the guanidinium salt to the protein as denaturation proceeds (Gordon 1972). The first guanidinium salt to be used as a deproteinization agent during isolation of RNA was the chloride (please see Figure 7-8) (Cox 1968).

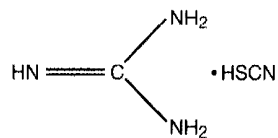
Although it is a strong inhibitor of ribonuclease, guanidinium chloride is not a powerful enough denaturant to allow extraction of intact RNA from tissues that are rich in RNase, such as the pancreas. Guanidinium isothiocyanate, a stronger chaotropic agent, contains potent cationic and anionic groups that form strong hydrogen bonds (please see Figure 7-9). Guanidinium isothiocyanate is used in the presence of a reducing agent to break protein disulfide bonds and in the presence of a detergent such as Sarkosyl to disrupt hydrophobic interactions.

Guanidinium isothiocyanate, or its close relative ammonium thiocyanate, are components of commercial kits that use a monophasic reagent (containing acidified phenol, guanidinium, or ammonium thiocyanate and a phenol solubilizer such as glycerol) to optimize the speed and extent of RNase inactivation (Puissant and Houdebine 1990; Chomczynski 1993, 1994; Chomczynski and Mackey 1995).



**FIGURE 7-8 Structure of Guanidinium Hydrochloride**

---



**FIGURE 7-9 Structure of Guanidinium Isothiocyanate**

---



---

## NUCLEASE S1

---

- Nuclease S1 is a heat-stable extracellular enzyme ( $M_r = 29,030$ ) secreted from the fungus *Aspergillus oryzae*. The mature enzyme is glycosylated and contains two disulfide bridges and a cluster of three  $Zn^{2+}$  ions that line the base of the active cleft and are required for enzymatic activity. Both the amino acid sequence and the three-dimensional structure of nuclease S1 are known (Iwamatsu et al. 1991; Sück et al. 1993), and the gene encoding nuclease S1 (*nucO*) has been cloned (Lee et al. 1995).
- Under conditions of high ionic strength (0.1–0.4 M NaCl) and low pH (pH 4.2) and in the presence of 1 mM  $Zn^{2+}$ , nuclease S1 degrades single-stranded DNA and RNA with high specificity (Ando 1966). The chief products of the reaction are 5' mononucleotides, which are generated by the concerted action of exo- and endonucleolytic activities (Shishido and Ando 1982). Moderate amounts of nuclease S1 will cleave at single-stranded nicks in duplex DNA (Beard et al. 1973; Martin-Bertram 1981) but will not recognize single-base-pair mismatches (Silber and Loeb 1981). Nuclease S1 can cleave single-stranded DNA under conditions that would be entirely unacceptable to many enzymes, for example, 10% formamide, 25 mM glyoxal, 30% sulfoxide (DMSO), and 30% formamide (Case and Baker 1975; Hutton and Wetmur 1975).
- Nuclease S1 is inhibited by  $PO_4^{3-}$ , 5' ribonucleotides and deoxyribonucleotides, nucleoside triphosphates, citrate, and EDTA. However, it is stable in low concentrations of denaturants such as SDS or urea (Vogt 1973).

For further information, please see Shishido and Habuka (1986), Fraser and Low (1993), and Gite and Shankar (1995).

---

## EXONUCLEASE VII

---

Exonuclease VII (Chase and Richardson 1974a,b; Chase and Vales 1981) is a single-strand-specific DNase that hydrolyzes denatured DNA, single-stranded regions extending from the termini of duplex DNA, and displaced single-stranded regions. The enzyme also excises pyrimidine dimers in vitro from UV-irradiated, nicked double-stranded DNA.

Exonuclease VII digests both 5' and 3' ends of single-stranded DNA in a processive fashion, eventually yielding short, acid-soluble oligonucleotides 2–25 nucleotides in length (Chase and Richardson 1974b). Because the enzyme releases oligonucleotides rather than mononucleotides, it cannot be used to produce blunt-ended molecules of double-stranded DNA (Ghangas and Wu 1975).

Exonuclease VII consists of two subunits ( $M_r = 10,500$  and 54,000) encoded by the *xseA* and *xseB* genes of *Escherichia coli* (Vales et al. 1982) and neither requires nor is inhibited by divalent cations. The enzyme has been used for several purposes in molecular cloning:

- **To eliminate primers from completed PCRs** (Li et al. 1991). This property can be extremely useful when carrying out multistep PCRs involving sequential addition of different sets of oligonucleotide primers. Alternative methods of removing primers left over from previous amplification steps rely on physical separation, which can be cumbersome when dealing with many samples, or dilution, in which a small aliquot of one PCR is transferred to the next. This latter method works well most of the time, but it is not recommended if absolutely clean separation is required between one PCR and the next.
- **As a substitute for nuclease S1 and mung bean nuclease in analysis of the structure of DNA-RNA hybrids** (Berk and Sharp 1978; Sharp et al. 1980). Digestion of the hybrid with exonuclease VII yields a DNA strand whose length is equivalent to the sum of the exons and introns complementary to the probe. By contrast, digestion with nuclease S1 or mung bean nuclease generates fragments of DNA that are equivalent in length to the individual exons. Exonuclease VII has been used to resolve problems in cases where digestion of mRNA-DNA hybrids yields anomalous bands in conventional nuclease S1 analysis (Chassagne and Schwartz 1992).
- **To excise inserts that have been attached to plasmid vectors via poly(dA-dT) tracts** (Goff and Berg 1978).

## MUNG BEAN NUCLEASE

Mung bean nuclease is used in molecular biology primarily to convert protruding termini on double-stranded DNAs to blunt ends (Ghangas and Wu 1975; Upcroft and Healey 1987). For this type of terminal polishing, mung bean nuclease is the enzyme of choice because it is easier to control than nuclease S1. For example, nuclease S1 will cleave the DNA strand opposite a nick in the duplex, whereas mung bean nuclease will attack the nick only after it has been enlarged to a gap several nucleotides in length (Kroeker and Kowalski 1978). However, mung bean nuclease greatly prefers to remove nucleotides from the 5' end of substrates (Ghangas and Wu 1975) and therefore is not as useful as nuclease S1 when the DNA carries 3' extensions. In addition, mung bean nuclease generates blunt ends when the terminal base pair of the blunt-ended DNA is GC, but frayed ends are more common when the terminal base pair is AT.

The enzyme, which was first isolated in 1962 by Sung and Laskowski from mung bean sprouts, degrades single-stranded DNA (and RNA) by a combination of exo- and endonucleolytic activity to a mixture of 5'-phosphorylated mono- and oligonucleotides. Mung bean nuclease is highly specific for single-stranded DNA, and the ratio of its activity on single- and double-stranded substrates is ~30,000:1 (for review, please see Gite and Shankar 1995). Thus, when used overenthusiastically (in high concentrations and/or for long incubation times), mung bean nuclease will nick and/or degrade double-stranded DNA, especially DNAs that are AT-rich (Johnson and Laskowski 1970; Kowalski et al. 1976; Kroeker and Kowalski 1978).

Mung bean nuclease is a small glycoprotein (m.w. 35,000–39,000), composed of two subunits linked by disulfide bonds (Kroeker et al. 1976; Kroeker and Kowalski 1978; Martin et al. 1986). It has an absolute requirement for  $Zn^{2+}$  and works best in low salt (25 mM ammonium acetate) at pH 5.0. In addition to polishing the termini of double-stranded molecules, mung bean nuclease has been used to map RNA transcripts as described in Protocol 10 of this chapter (Murray 1986), to probe secondary structure in DNA (Martin et al. 1986), and to linearize supercoiled DNA by cleavage in AT-rich regions (Johnson and Laskowski 1970; Wang 1974).

## PROMOTER SEQUENCES RECOGNIZED BY BACTERIOPHAGE-ENCODED RNA POLYMERASES

BACTERIOPHAGE	PROMOTER				
	-15	-10	-5	+1	+5
T7					
	TAATACGACTCACTATAGGGAGA				
T3	AATTAACCCTCACTAAAGGGAGA				
SP6	ATTTAGG <sup>T</sup> <sub>G</sub> GACACTATAGAAG				

The consensus sequences of promoters are recognized by three bacteriophage-encoded RNA polymerases: T7 (Dunn and Studier 1983), T3 (Beck et al. 1989), and SP6 (Brown et al. 1986). All of the bacteriophage promoters share a core sequence that extends from -7 to +1, suggesting that this region has a common role in promoter function. The promoters diverge in the region from -8 to -12, suggesting that promoter-specific contacts are made in this region. By convention, the sequence of the non-template strand is shown. (Adapted, with permission, from Jorgensen et al. 1991.)

In addition to the promoter, the nucleotides immediately downstream from the transcriptional start site can affect the efficiency of RNA synthesis (Solazzo et al. 1987; Nam and Kang 1988; Milligan and Uhlenbeck 1989). It is therefore best to synthesize oligonucleotide primers that extend five to six nucleotides past the start site. The composite promoters shown in the table prevent abortive cycling of the RNA polymerase and generate large yields of RNA in transcription reactions. For further information on bacteriophage polymerases and the promoters they recognize, please see Chapter 9.

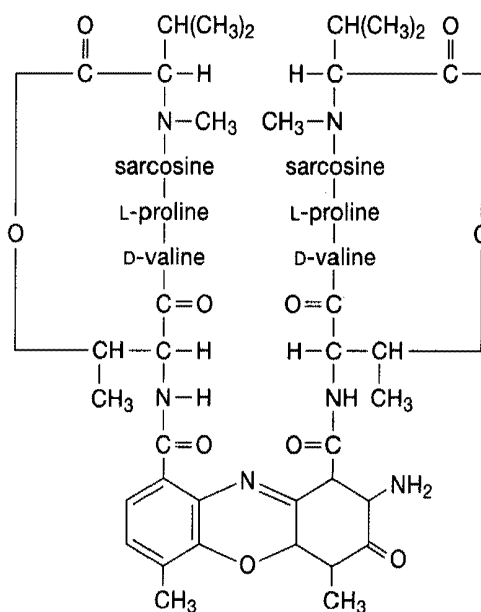
## ACTINOMYCIN D

Actinomycin D (sometimes called Dactinomycin) is a chromopeptide, originally isolated from a culture broth of a species of *Streptomyces*. The molecule contains a planar phenoxazone ring that can stably intercalate between adjacent G-C pairs of double-stranded DNA and block transcription by RNA polymerase (Sobell 1973). In addition, actinomycin D causes single-strand breaks in DNA, possibly through free radical formation or as a result of the activity of topoisomerase II (Goldberg et al. 1977).

Actinomycin D at a concentration of 50  $\mu\text{g/ml}$  is sometimes used in molecular cloning to inhibit self-primed synthesis of second-strand cDNA during reverse transcription of RNA (McDonnell et al. 1970; Müller et al. 1971). The chromopeptide either may suppress the formation of hairpin structures by the unpaired 3' sequences of first-strand DNA (Bunte et al. 1980) or may destabilize such structures to an extent that DNA polymerases like reverse transcriptase or the Klenow fragment of *E. coli* DNA polymerase I are unable to latch on to the hairpin for kinetic reasons.

Lyophilized preparations of actinomycin D supplied by pharmaceutical manufacturers for therapeutic uses often contain additional substances such as sugars and salts. It is therefore important to verify the concentration of actinomycin D by measuring the absorbance of the stock solution at 441 nm. The molar extinction coefficient of pure actinomycin D in  $\text{H}_2\text{O}$  is 21,900. The absorbance at 441 nm of a stock solution containing 5 mg/ml of the drug is therefore 0.410. Stock solutions should be prepared in deionized  $\text{H}_2\text{O}$  and stored at  $-20^\circ\text{C}$  in a foil-wrapped tube.

Actinomycin D is a teratogen and carcinogen. Wear a mask and gloves and work in a chemical fume hood when preparing stock solutions.



**FIGURE 7-10** Actinomycin D,  $M_r = 1255.47$

The structure of actinomycin D is reported in Bullock and Johnson (1957).

## REFERENCES

- Albretsen C., Kalland K.H., Haukanes B.I., Havarstein L.S., and Kleppe K. 1990. Applications of magnetic beads with covalently attached oligonucleotides in hybridization: Isolation and detection of specific measles virus mRNA from a crude cell lysate. *Anal. Biochem.* **189**: 40–50.
- Aldea M., Claverie-Martin E., Diaz-Torres M.R., and Kushner S.R. 1988. Transcript mapping using [<sup>35</sup>S] DNA probes, trichloroacetate solvent and dideoxy sequencing ladders: A rapid method for identification of transcriptional start points. *Gene* **65**: 101–110.
- Alwine J.C., Kemp D.J., and Stark G.R. 1977. Method for detection of specific RNAs in agarose gels by transfer to diazobenzylmethoxymethyl-paper and hybridization with DNA probes. *Proc. Natl. Acad. Sci.* **74**: 5350–5354.
- Alwine J.C., Kemp D.J., Parker B.A., Reiser J., Renart J., Stark G.R., and Wahl G.M. 1979. Detection of specific RNAs or specific fragments of DNA by fractionation in gels and transfer to diazobenzylmethoxymethyl paper. *Methods Enzymol.* **68**: 220–242.
- Anchordoguy T.J., Crawford D.L., Hardewig D.L., and Hand S.C. 1996. Heterogeneity of DNA binding to membranes used in quantitative dot blots. *BioTechniques* **20**: 754–756.
- Ando T. 1966. A nuclease specific for heat-denatured DNA isolated from a product of *Aspergillus oryzae*. *Biochim. Biophys. Acta* **114**: 158–168.
- Angeletti B., Battiloro E., Pascale E., and D'Ambrosio E. 1995. Southern and northern blot fixing by microwave oven. *Nucleic Acids Res.* **23**: 879–880.
- Aviv H. and Leder P. 1972. Purification of biologically active globin messenger RNA by chromatography on oligothymidylic acid cellulose. *Proc. Natl. Acad. Sci.* **69**: 1408–1412.
- Bailey J.M. and Davidson N. 1976. Methylmercury as a reversible denaturing agent for agarose gel electrophoresis. *Anal. Biochem.* **70**: 75–85.
- Bales K.R., Hannon K., Smith II C.K., and Santerre R.F. 1993. Single-stranded RNA probes generated from PCR-derived templates. *Mol. Cell. Probes* **7**: 269–275.
- Bantle J.A., Maxwell I.H., and Hahn W.E. 1976. Specificity of oligo(dT)-cellulose chromatography in the isolation of polyadenylated RNA. *Anal. Biochem.* **72**: 413–427.
- Beard P., Morrow J.F., and Berg P. 1973. Cleavage of circular superhelical simian virus 40 DNA linear duplex by S1 nuclease. *J. Virol.* **12**: 1303–1313.
- Beck P.J., Gonzalez S., Ward C.L., and Molineux I.J. 1989. Sequence of bacteriophage T3 DNA from gene 2.5 through gene 9. *J. Mol. Biol.* **210**: 687–701.
- Beckers T., Schmidt P., and Hilgard P. 1994. Highly sensitive northern hybridization of rare mRNA using a positively charged nylon membrane. *BioTechniques* **16**: 1075–1078.
- Berger S.L. and Birkenmeier C.S. 1979. Inhibition of intractable nucleases with ribonucleotide-vanadyl complexes: Isolation of messenger ribonucleic acid from resting lymphocytes. *Biochemistry* **18**: 5143–5149.
- Berk A.J. and Sharp P.A. 1977. Sizing and mapping of early adenovirus mRNAs by gel electrophoresis of S1 endonuclease-digested hybrids. *Cell* **12**: 721–732.
- . 1978. Spliced early mRNAs of simian virus 40. *Proc. Natl. Acad. Sci.* **75**: 1274–1278.
- Bhatia P., Taylor W.R., Geenberg A.H., and Wright J.A. 1994. Comparison of glyceraldehyde-3-phosphate dehydrogenase and 28S-ribosomal RNA gene expression as RNA loading controls for northern blot analysis of cell lines of varying malignant potential. *Anal. Biochem.* **216**: 223–226.
- Blackburn P., Wilson G., and Moore S. 1977. Ribonuclease inhibitor from human placenta. Purification and properties. *J. Biol. Chem.* **252**: 5904–5910.
- Boedtker H. 1971. Conformation-independent molecular weight determinations of RNA by gel electrophoresis. *Biochim. Biophys. Acta* **240**: 448–453.
- Boorstein W.R. and Craig E.A. 1989. Primer extension analysis of RNA. *Methods Enzymol.* **180**: 347–369.
- Britten R.J. and Kohne D.E. 1968. Repeated sequences in DNA. Hundreds of thousands of copies of DNA sequences have been incorporated into the genomes of higher organisms. *Science* **161**: 529–540.
- Britten R.J., Graham D.E., and Neufeld B.R. 1974. Analysis of repeating DNA sequences by reassociation. *Methods Enzymol.* **29**: 363–418.
- Brown J.E., Klement J.F., and McAllister W.T. 1986. Sequences of three promoters for the bacteriophage SP6 RNA polymerase. *Nucleic Acids Res.* **14**: 3521–3526.
- Brown P.C., Tlsty T.D., and Schimke R.T. 1983. Enhancement of methotrexate resistance and dihydrofolate reductase gene amplification by treatment of mouse 3T6 cells with hydroxyurea. *Mol. Cell. Biol.* **3**: 1097–1107.
- Bullock E. and Johnson A.W. 1957. Actinomycin. Part V. The structure of actinomycin D. *J. Chem. Soc.* 3280–3285.
- Bunte T., Novak U., Friedrich R., and Moelling K. 1980. Effect of actinomycin D on nucleic acid hybridization: The cause of erroneous DNA elongation during DNA synthesis of RNA tumor viruses in vitro. *Biochim. Biophys. Acta* **610**: 241–247.
- Burke J.F. 1984. High sensitivity S1 mapping with single-stranded [<sup>32</sup>P] DNA probes synthesized from bacteriophage M13mp templates. *Gene* **30**: 63–68.
- Burnett W.V. 1997. Northern blotting of RNA denatured in glyoxal without buffer recirculation. *BioTechniques* **22**: 668–671.
- Calzone F.J., Britten R.J., and Davidson E.H. 1987. Mapping of gene transcripts by nuclease protection assays and cDNA primer extension. *Methods Enzymol.* **157**: 611–632.
- Carmichael G.G. and McMaster G.K. 1980. The analysis of nucleic acids in gels using glyoxal and acridine orange. *Methods Enzymol.* **65**: 380–391.
- Case S.T. and Baker R.F. 1975. Investigation into the use of *Aspergillus oryzae* S1 nuclease in the presence of solvents which destabilize or prevent DNA secondary structure: Formaldehyde, formamide and glyoxal. *Anal. Biochem.* **64**: 477–484.
- Casey J. and Davidson N. 1977. Rates of formation and thermal stabilities of RNA:DNA and DNA:DNA duplexes at high concentrations of formamide. *Nucleic Acids Res.* **4**: 1539–1552.
- Celano P., Vertino P.M., and Casero Jr., R.A. 1993. Isolation of polyadenylated RNA from cultured cells and intact tissues. *BioTechniques* **15**: 26–28.
- Chapman A.B., Costello M.A., Lee F., and Ringold G.M. 1983. Amplification and hormone-regulated expression of a mouse mammary tumor virus-*Eco gpt* fusion plasmid in mouse 3T6 cells. *Mol. Cell. Biol.* **3**: 1421–1429.
- Chase J.W. and Richardson C.C. 1974a. Exonuclease VII of *Escherichia coli*. Purification and properties. *J. Biol. Chem.* **249**: 4545–4552.

- , 1974b. Exonuclease VII of *Escherichia coli*. Mechanism of action. *J. Biol. Chem.* **249**: 4553–4561.
- Chase J.W. and Vales L.D. 1981. Exonuclease VII of *E. coli*. In *Gene amplification and analysis* (ed. L.G. Chirikjian and T.S. Papas), vol. 2, pp. 147–168. Elsevier, New York.
- Chassagne C. and Schwartz K. 1992. Mapping of mRNA isoforms with an oligonucleotide probe. *Nucleic Acids Res.* **20**: 3256.
- Chirgwin J.M., Przybyla A.E., MacDonald R.J., and Rutter W.J. 1979. Isolation of biologically active ribonucleic acid from sources enriched in ribonuclease. *Biochemistry* **18**: 5294–5299.
- Chomczynski P. 1992. Solubilization of formamide protects RNA from degradation. *Nucleic Acids Res.* **20**: 3791–3792.
- , 1993. A reagent for the single-step simultaneous isolation of RNA, DNA and proteins from cell and tissue samples. *BioTechniques* **15**: 532–534.
- , 1994. Self-stable product and process for isolating RNA, DNA and proteins. U.S. Patent 5,346,994.
- Chomczynski P. and Mackey K. 1994. One-hour downward capillary blotting of RNA at neutral pH. *Anal. Biochem.* **221**: 303–305.
- , 1995. Modification of the TRI Reagent™ procedure for isolation of RNA from polysaccharide- and proteoglycan-rich sources. *BioTechniques* **19**: 942–945.
- Chomczynski P. and Qasba P.K. 1984. Alkaline transfer of DNA to plastic membrane. *Biochem. Biophys. Res. Commun.* **122**: 340–344.
- Chomczynski P. and Sacchi N. 1987. Single-step method of RNA isolation by acid guanidinium thiocyanate-phenol-chloroform extraction. *Anal. Biochem.* **162**: 156–159.
- Church G.M. and Gilbert W. 1984. Genomic sequencing. *Proc. Natl. Acad. Sci.* **81**: 1991–1995.
- Cox R.A. 1968. The use of guanidinium chloride in the isolation of nucleic acids. *Methods Enzymol.* **12**: 120–129.
- Cummins J.E. and Nesbitt B.E. 1978. Methyl mercury and safety. *Nature* **273**: 96.
- Davis L.G., Dibner M.D., and Battey J.F., eds. 1986. *Basic methods in molecular biology*. Elsevier, New York.
- Davis M.J., Bailey C.S., and Smith II C.K. 1997. Use of internal controls to increase quantitative capabilities of the ribonuclease protection assay. *BioTechniques* **23**: 280–285.
- Dean M. 1987. Determining the hybridization temperature for S1 nuclease mapping. *Nucleic Acids Res.* **15**: 6754.
- de Leeuw W.J.F., Slagboom P.E., and Vijg J. 1989. Quantitative comparison of mRNA levels in mammalian tissues: 28S ribosomal RNA level as an accurate internal control. *Nucleic Acids Res.* **17**: 10137–10138.
- Dixon D.A., Vaitkus D.L., and Prescott S.M. 1997. DNase I treatment of total RNA improves the accuracy of ribonuclease protection assay. *BioTechniques* **24**: 732–734.
- DuBois D.C., Almon R.R., and Jusko W.J. 1993. Molar quantification of specific messenger ribonucleic acid expression in northern hybridization using cRNA standards. *Anal. Biochem.* **210**: 140–144.
- Dunn J.J. and Studier F.W. 1983. Complete nucleotide sequence of bacteriophage T7 DNA and the locations of T7 genetic elements. *J. Mol. Biol.* **166**: 477–535.
- Eberwine J. 1996. Amplification of mRNA populations using aRNA generated from immobilized oligo(dT)-T7 primed cDNA. *BioTechniques* **20**: 584–591.
- Edmonds M., Vaughan Jr., M.H., and Nakazato H. 1971. Polyadenylic acid sequences in the heterogeneous nuclear RNA and rapidly-labeled polyribosomal RNA of HeLa cells: Possible evidence for a precursor relationship. *Proc. Natl. Acad. Sci.* **68**: 1336–1340.
- Ehrenberg L., Fedorcsak I., and Solymosy F. 1976. Diethyl pyrocarbonate in nucleic acid research. *Prog. Nucleic Acid Res. Mol. Biol.* **16**: 189–262.
- Favaloro J., Treisman R., and Kamen R. 1980. Transcription maps of polyoma virus-specific RNA: Analysis by two-dimensional nuclease S1 gel mapping. *Methods Enzymol.* **65**: 718–749.
- Fenichell S. 1999. *Plastic: The making of a synthetic century*. Harper Business, New York.
- Fornace Jr., A.J. and Mitchell J.B. 1986. Induction of B2 RNA polymerase III transcription by heat shock enrichment for heat shock induced sequences in rodent cells by hybridization subtraction. *Nucleic Acids Res.* **14**: 5793–5811.
- Fourney R.M., Miyakoshi J., Day III R.S., and Paterson M.C. 1988. Northern blotting: Efficient RNA staining and transfer. *Focus (Life Technologies)* **10**: 5–6.
- Fraser M.J. and Low R.L. 1993. Fungal and mitochondrial nucleases. In *Nucleases*, 2nd edition (ed. S.M. Linn et al.), pp. 171–207. Cold Spring Harbor Laboratory Press, Cold Spring Harbor, New York.
- Geliebter J., Zeff R.A., Melvold R.W., and Nathenson S.G. 1986. Mitotic recombination in germ cells generated two major histocompatibility complex mutant genes shown to be identical by RNA sequence analysis: Kbm9 and Kbm6. *Proc. Natl. Acad. Sci.* **83**: 3371–3375.
- Gerard G.F., Fox D.K., Nathan M., and D'Alessio J.M. 1997. Reverse transcriptase. The use of cloned Moloney murine leukemia virus reverse transcriptase to synthesize DNA from RNA. *Mol. Biotechnol.* **8**: 61–77.
- Ghanges G.S. and Wu R. 1975. Specific hydrolysis of the cohesive ends of bacteriophage lambda DNA by three single strand-specific nucleases. *J. Biol. Chem.* **250**: 4601–4606.
- Gilham P.T. 1964. Synthesis of polynucleotide celluloses and their use in fractionation of oligonucleotides. *J. Am. Chem. Soc.* **86**: 4982–4989.
- , 1971. The covalent binding of nucleotides, polynucleotides and nucleic acids to cellulose. *Methods Enzymol.* **21**: 191–197.
- Gite S.U. and Shankar V. 1995. Single-strand-specific nucleases. *Crit. Rev. Microbiol.* **21**: 101–122.
- Glisin V., Crkvenjakov R., and Byus C. 1974. Ribonucleic acid isolated by cesium chloride centrifugation. *Biochemistry* **13**: 2633–2637.
- Goda S.K. and Minton N.P. 1995. A simple procedure for gel electrophoresis and northern blotting of RNA. *Nucleic Acids Res.* **23**: 3357–3358.
- Goff S. and Berg P. 1978. Excision of DNA segments introduced into cloning vectors by the poly(dA-dT) joining method. *Proc. Natl. Acad. Sci.* **75**: 1763–1767.
- Goldberg D.A. 1980. Isolation and partial characterization of the *Drosophila* alcohol dehydrogenase gene. *Proc. Natl. Acad. Sci.* **77**: 5794–5798.
- Goldberg I.H., Beerman T.A., and Poon R. 1977. Antibiotics: Nucleic acids as targets in chemotherapy. In *Cancer 5: A comprehensive treatise* (ed. F.F. Becker), pp. 427–456. Plenum Press, New York.
- Gordon J.A. 1972. Denaturation of globular proteins. Interaction of guanidinium salts with three proteins. *Biochemistry* **11**: 1862–1870.
- Gramza A.W., Lucas J.M., Mountain R.E., Schuller D.E., and Lang J.C. 1995. Efficient method for preparing normal and tumor tissue for RNA extraction. *BioTechniques* **18**: 228–231.

- Grillo M. and Margolis E.L. 1990. Use of reverse transcriptase polymerase chain reaction to monitor expression of intronless genes. *BioTechniques* **9**: 262–268.
- Groppe J.C. and Morse D.E. 1993. Isolation of full-length RNA templates for reverse transcription from tissues rich in RNase and proteoglycans. *Anal. Biochem.* **210**: 337–343.
- Gründemann D. and Koepsell H. 1994. Ethidium bromide staining during denaturation with glyoxal for sensitive detection of RNA in agarose gel electrophoresis. *Anal. Biochem.* **216**: 459–461.
- Hahn C.S., Strauss E.G., and Strauss J.M. 1989. Dideoxy sequencing of RNA using reverse transcriptase. *Methods Enzymol.* **180**: 121–130.
- Han J.H., Stratawa C., and Rutter W.J. 1987. Isolation of full-length putative rat lysophospholipase cDNA using improved methods for mRNA isolation and cDNA cloning. *Biochemistry* **26**: 1617–1625.
- Hara E., Yamaguchi T., Tahara H., Tsuyama N., Tsurui H., Ide T., and Oda K. 1993. DNA-DNA subtractive cDNA cloning using oligo(dT)<sub>30</sub>-latex and PCR: Identification of cellular genes which are overexpressed in senescent human diploid fibroblasts. *Anal. Biochem.* **214**: 54–64.
- Harley C.B. 1987. Hybridization of oligo(dT) to RNA on nitrocellulose. *Gene Anal. Tech.* **4**: 17–22.
- . 1988. Normalization of RNA dot blots with oligo(dT). *Trends Genet.* **4**: 152.
- Hayward G.S. 1972. Gel electrophoretic separation of the complementary probe strands of bacteriophage DNA. *Virology* **49**: 342–344.
- Herr W. 1985. Diethyl pyrocarbonate: A chemical probe for secondary structure in negatively supercoiled DNA. *Proc. Natl. Acad. Sci.* **82**: 8009–8013.
- Herrin D.L. and Schmidt G.W. 1988. Rapid, reversible staining of northern blots prior to hybridization. *BioTechniques* **6**: 196–197, 199–200.
- Hofsteenge J. 1994. "Holy" proteins. I. Ribonuclease inhibitor. *Curr. Opin. Struct. Biol.* **4**: 807–809.
- Hollander M.C. and Fornace Jr., A.J. 1990. Estimation of relative mRNA content by filter hybridization to a polythymidylate probe. *BioTechniques* **9**: 174–179.
- Hornes E. and Korsnes L. 1990. Magnetic DNA hybridization properties of oligonucleotide probes attached to superparamagnetic beads and their use in the isolation of poly(A) mRNA from eukaryotic cells. *Genet. Anal. Tech. Appl.* **7**: 145–150.
- Huang Y.H., Leblanc P., Apostolou V., Stewart B., and Moreland R.B. 1995. Comparison of Milli-Q® PF Plus water to DEPC-treated water in the preparation and analysis of RNA. *BioTechniques* **19**: 656–661.
- Hunsaker W.R., Badri H., Lombardo M., and Collins M.L. 1989. Nucleic acid hybridization assays employing dA-tailed capture probes. *Anal. Biochem.* **181**: 360–370.
- Hutton J.R. and Wetmur J.G. 1975. Activity of endonuclease S1 in denaturing solvents: Dimethylsulfoxide, dimethylformamide, formamide and formaldehyde. *Biochem. Biophys. Res. Commun.* **66**: 942–948.
- Iwamatsu A., Aoyama H., Dibo G., Tsunasawa S., and Sakiyama F. 1991. Amino acid sequence of nuclease S1 from *Aspergillus oryzae*. *J. Biochem.* **110**: 151–158.
- Jacobson A. 1987. Purification and fractionation of poly(A) RNA. *Methods Enzymol.* **152**: 254–261.
- Jakobsen K.S., Breivold E., and Horsnes E. 1990. Purification of mRNA directly from crude plant tissues in 15 minutes using magnetic oligo dT microspheres. *Nucleic Acids Res.* **18**: 3669.
- Jarrett H.W. 1993. Affinity chromatography with nucleic acid polymers. *J. Chromatogr.* **618**: 315–339.
- Johnson P.H. and Laskowski Sr., M. 1970. Mung bean nuclease I. II. Resistance of double-stranded deoxyribonucleic acid and susceptibility of regions rich in adenosine and thymidine to enzymatic hydrolysis. *J. Biol. Chem.* **245**: 891–898.
- Johnston B.H. and Rich A. 1985. Chemical probes of DNA conformation: Detection of Z-DNA at nucleotide resolution. *Cell* **42**: 713–724.
- Jones R.W. and Jones M.J. 1992. Simplified filter paper sandwich blot provides rapid, background-free northern blots. *BioTechniques* **12**: 684–688.
- Jorgensen E.D., Durbin R.K., Risman S.S., and McAllister W.T. 1991. Specific contacts between the bacteriophage T3, T7 and SP6 RNA polymerases and their promoters. *J. Biol. Chem.* **266**: 645–651.
- Kafatos F.C., Jones C.W., and Efstratiadis A. 1979. Determination of nucleic acid sequence homologies and relative concentrations by a dot hybridization procedure. *Nucleic Acids Res.* **7**: 1541–1552.
- Kekule A.S., Lauer U., Meyer M., Caselmann W.H., Hofschneider P.H., and Koshy R. 1990. The preS2/S region of integrated hepatitis B virus DNA encodes a transcriptional transactivator. *Nature* **343**: 457–461.
- Kelly K., Cochran B., Stiles C., and Leder P. 1983. Cell-specific regulation of the *c-myc* gene by lymphocyte mitogens and platelet-derived growth factor. *Cell* **35**: 603–610.
- Kevil C.G., Walsh L., Laroux F.S., Kalogeris T., Grisham M.B., and Alexander J.S. 1997. An improved rapid northern protocol. *Biochem. Biophys. Res. Commun.* **238**: 277–279.
- Khandjian E.W. 1987. Optimized hybridization of DNA blotted and fixed to nitrocellulose and nylon filters. *Bio/Technology* **5**: 165–167.
- Kobe B. and Deisenhofer J. 1993. Crystal structure of porcine ribonuclease inhibitor, a protein with leucine-rich repeats. *Nature* **366**: 751–756.
- . 1995. A structural basis for the interactions between leucine-rich repeats and protein ligands. *Nature* **374**: 183–186.
- . 1996. Mechanism of ribonuclease inhibition by ribonuclease inhibitor protein based on the crystal structure of its complex with ribonuclease A. *J. Mol. Biol.* **264**: 1028–1043.
- Kohne D.E. and Britten R.J. 1971. Hydroxyapatite techniques for nucleic acid reassociation. *Prog. Nucleic Acid Res.* **2**: 500–512.
- Kowalski D., Kroeker W.D., and Laskowski Sr., M. 1976. Mung bean nuclease I. Physical, chemical, and catalytic properties. *Biochemistry* **15**: 4457–4463.
- Krieg P.A. and Melton D.A. 1987. In vitro RNA synthesis with SP6 RNA polymerase. *Methods Enzymol.* **155**: 397–415.
- Kroczek R.A. 1989. Immediate visualization of blotted RNA in northern analysis. *Nucleic Acids Res.* **17**: 9497.
- . 1993. Southern and northern analysis. *J. Chromatogr.* **618**: 133–145.
- Kroczek R.A. and Siebert E. 1990. Optimization of northern analysis by vacuum-blotting, RNA-transfer visualization, and ultraviolet fixation. *Anal. Biochem.* **184**: 90–95.
- Kroeker W.D. and Kowalski D. 1978. Gene-sized pieces produced by digestion of linear duplex DNA with mung bean nuclease. *Biochemistry* **17**: 3236–3243.
- Kroeker W.D., Kowalski D., and Laskowski Sr., M. 1976. Mung bean nuclease I. Terminally-directed hydrolysis of native DNA. *Biochemistry* **15**: 4463–4467.

- Kuribayashi-Ohta K., Tamatsukuri S., Hikata M., Miyamoto C., and Furuichi Y. 1993. Application of oligo(dT)<sub>30</sub>-latex for the rapid purification of poly(A)<sup>+</sup> mRNA and for hybrid subtraction with the in situ reverse transcribed cDNA. *Biochim. Biophys. Acta* **1156**: 204–212.
- Lee B.R., Kitamoto K., Yamada O., and Kumagai C. 1995. Cloning, characterization and overproduction of nuclease S1 gene (*nucS*) from *Aspergillus oryzae*. *Appl. Microbiol. Biotechnol.* **44**: 425–431.
- Lee F.S. and Vallee B.L. 1993. Structure and action of mammalian ribonuclease (angiogenin) inhibitor. *Prog. Nucleic Acid Res. Mol. Biol.* **44**: 1–30.
- Lee F.S., Shapiro R., and Vallee B.L. 1989. Tight binding inhibition of angiogenin and ribonuclease A by placental ribonuclease inhibitor. *Biochemistry* **28**: 225–230.
- Lehrach H., Diamond D., Wozney J.M., and Boedtker H. 1977. RNA molecular weight determinations by gel electrophoresis under denaturing conditions: A critical reexamination. *Biochemistry* **16**: 4743–4751.
- Leonard N.J., McDonald J.J., and Reichmann M.E. 1970. Reaction of diethyl pyrocarbonate with nucleic acid components: Adenine. *Proc. Natl. Acad. Sci.* **67**: 93–98.
- Leonard N.J., McDonald J.J., Henderson R.E.L., and Reichmann M.E. 1971. Reaction of diethyl pyrocarbonate with nucleic acid components: Adenosine. *Biochemistry* **10**: 3335–3342.
- Li H.H., Cui X.F., and Arnheim N. 1991. Eliminating primers from completed polymerase chain reactions with exonuclease VII. *Nucleic Acids Res.* **19**: 3139–3141.
- Lichtenstein A.V., Moiseev V.L., and Zaboikin M.M. 1990. A procedure for DNA and RNA transfer to membrane filters avoiding weight-induced flattening. *Anal. Biochem.* **191**: 187–191.
- Lindberg U. and Persson T. 1974. Messenger RNA isolation with poly(U) agarose. *Methods Enzymol.* **34**: 496–499.
- Lopata M.A., Sollner-Webb B., and Cleveland D.W. 1985. Surprising S1-resistant trimolecular hybrids: Potential complication in interpretation of S1 mapping analyses. *Mol. Cell. Biol.* **5**: 2842–2846.
- Lynn D.A., Angerer L.M., Bruskin A.M., Klein W.H., and Angerer R.C. 1983. Localization of a family of mRNAs in a single cell type and its precursors in sea urchin embryos. *Proc. Natl. Acad. Sci.* **80**: 2656–2660.
- Mahmoudi M. and Lin V.K. 1989. Comparison of two different hybridization systems in northern transfer analysis. *BioTechniques* **7**: 331–332.
- Martin S.A., Ullrich R.C., and Meyer W.L. 1986. A comparative study of nucleases exhibiting preference for single-stranded nucleic acid. *Biochim. Biophys. Acta* **867**: 76–80.
- Martin-Bertram H. 1981. S1-sensitive sites in DNA after  $\gamma$ -irradiation. *Biochim. Biophys. Acta* **652**: 261–265.
- Matthews J.A., Batki A., Hynds C., and Cricka L.J. 1985. Enhanced chemiluminescent method for the detection of DNA dot-hybridization assays. *Anal. Biochem.* **151**: 205–209.
- McDonnell J.P., Garapin A., Levinson W.E., Quintrell N., Fanshier L., and Bishop J.M. 1970. DNA polymerases of Rous sarcoma virus: Delineation of two reactions with actinomycin. *Nature* **228**: 433–445.
- McMaster G. and Carmichael G.G. 1977. Analysis of single- and double-stranded nucleic acids on polyacrylamide and agarose gels by using glyoxal and acridine orange. *Proc. Natl. Acad. Sci.* **74**: 4835–4838.
- Meinkoth J. and Wahl G. 1984. Hybridization of nucleic acids immobilized on solid supports. *Anal. Biochem.* **138**: 267–284.
- Melton D.A., Krieg P.A., Rebagliati M.R., Maniatis T., Zinn K., and Green M.R. 1984. Efficient *in vitro* synthesis of biologically active RNA and RNA hybridization probes from plasmids containing a bacteriophage SP6 promoter. *Nucleic Acids Res.* **12**: 7035–7056.
- Miller K. 1987. Gel electrophoresis of RNA. *Focus (Life Technologies)* **9**: 30.
- Milligan J.F. and Uhlenbeck O.C. 1989. Synthesis of small RNAs using T7 RNA polymerase. *Methods Enzymol.* **180**: 51–62.
- Miller K.G. and Sollner-Webb B. 1981. Transcription of mouse RNA genes by RNA polymerase I: In vitro and in vivo initiation and processing sites. *Cell* **27**: 165–174.
- Mitchell A. and Fidge N. 1996. Determination of apolipoprotein mRNA levels by ribonuclease protection assay. *Methods Enzymol.* **263**: 351–363.
- Morrissey D.V., Lombardo M., Eldredge J., Kearney K.R., Groody E.P., and Collins M.L. 1989. Nucleic acid hybridization assays employing dA-tailed capture probes. I. Multiple capture methods. *Anal. Biochem.* **181**: 345–359.
- Müller W.E., Zahn R.K., and Seidel H.J. 1971. Inhibitors acting on nucleic acid synthesis in an oncogenic RNA virus. *Nat. New Biol.* **232**: 143–145.
- Murphy N.R., Leinbach S.S., and Hellwig R.J. 1995. A potent, cost-effective RNase inhibitor. *BioTechniques* **18**: 1068–1073.
- Murray M.G. 1986. Use of sodium trichloroacetate and mung bean nuclease to increase sensitivity and precision during transcript mapping. *Anal. Biochem.* **158**: 165–170.
- Nadin-Davis S. and Mezl V.A. 1982. Optimization of the ethanol precipitation of RNA from formamide containing solutions. *Prep. Biochem.* **12**: 49–56.
- Nakaya K., Takenaka O., Horinishi H., and Shibata K. 1968. Reactions of glyoxal with nucleic acids, nucleotides and their component bases. *Biochim. Biophys. Acta* **161**: 23–31.
- Nakazato H. and Edmonds M. 1972. The isolation and purification of rapidly labeled polysome-bound ribonucleic acid on polythymidylate cellulose. *J. Biol. Chem.* **247**: 3365–3367.
- Nam S.C. and Kang C. 1988. Transcription initiation site selection and abnormal initiation cycling of phage SP6 RNA polymerase. *J. Biol. Chem.* **263**: 18123–18127.
- Nogués M.V., Vilanova M., and Cuchillo C.M. 1995. Bovine pancreatic ribonuclease A as a model of an enzyme with multiple substrate binding sites. *Biochim. Biophys. Acta* **1253**: 16–24.
- O'Conner J.L., Wade M.E., and Zhou Y. 1991. Control of buffer pH during agarose gel electrophoresis of glyoxylated RNA. *BioTechniques* **10**: 300–302.
- Ogretmen B., Ratajczak H., Kats A., Stark B.C., and Gendel S.M. 1993. Effects of staining of RNA with ethidium bromide before electrophoresis on performance of northern blots. *BioTechniques* **14**: 932–935.
- Papageorgiou A.C., Shapiro R., and Acharya K.R. 1997. Molecular recognition of human angiogenin by placental ribonuclease inhibitor — An X-ray crystallographic study at 2.0 Å resolution. *EMBO J.* **16**: 5162–5177.
- Pape M.E., Melchior G.W., and Marotti K.R. 1991. mRNA quantitation by a simple and sensitive RNase protection assay. *Genet. Anal. Tech. Appl.* **8**: 206–213.
- Peattie D.A. and Gilbert W. 1980. Chemical probes for higher-order structure in RNA. *Proc. Natl. Acad. Sci.* **77**: 4679–4682.
- Penman S., Fan H., Perlman S., Rosbash M., Weinberg R., and Zylber E. 1971. Distinct RNA synthesis systems of the HeLa cell. *Cold Spring Harbor Symp. Quant. Biol.* **35**: 561–575.
- Pitas J.W. 1989. A simple technique for repair of nylon blotting

- membranes. *BioTechniques* **7**: 1084.
- Puissant C. and Houdebine L.M. 1990. An improvement of the single-step method of RNA isolation by acid guanidinium thiocyanate-phenol-chloroform extraction. *BioTechniques* **8**: 148-149.
- Purrello M. and Balazs I. 1983. Direct hybridization of labeled DNA to DNA in agarose gels. *Anal. Biochem.* **128**: 393-397.
- Rave N., Crkvenjakov R., and Boedtker H. 1979. Identification of procollagen mRNAs transferred to diazobenzoyloxymethyl paper from formaldehyde gels. *Nucleic Acids Res.* **6**: 3559-3567.
- Re P., Valhmu W.B., Vostrejs M., Howell D.S., Fischer S.G., and Ratcliffe A. 1995. Quantitative polymerase chain reaction assay for aggrecan and link protein gene expression in cartilage. *Anal. Biochem.* **225**: 356-360.
- Reed K.C. and Mann D.A. 1985. Rapid transfer of DNA from agarose gels to nylon membranes. *Nucleic Acids Res.* **13**: 7207-7221.
- Reed K.C. and Matthaei K.I. 1990. Rapid preparation of DNA dot blots from tissue samples, using hot alkaline lysis and filtration onto charge-modified nylon membrane. *Nucleic Acids Res.* **18**: 3093.
- Richards E.G., Coll J.A., and Gratzer W.B. 1965. Disc electrophoresis of ribonucleic acid in polyacrylamide gels. *Anal. Biochem.* **12**: 452-471.
- Rosen K.M. and Villa-Komaroff L. 1990. An alternative method for the visualization of RNA in formaldehyde agarose gels. *Focus (Life Technologies)* **12**: 23-24.
- Rosen K.M., Lamperti E.D., and Villa-Komaroff L. 1990. Optimizing the northern blot procedure. *BioTechniques* **8**: 398-403.
- Ross P.M., Woodley K., and Baird M. 1989. Quantitative autoradiography of dot blots using a microwell densitometer. *BioTechniques* **7**: 680-688.
- Runkel L. and Nordheim A. 1986. Chemical footprinting of the interaction between left-handed Z-DNA and anti-Z-DNA antibodies by diethylpyrocarbonate carbethoxylation. *J. Mol. Biol.* **189**: 487-501.
- Sacomanno C.F., Bordonaro M., Chen J.S., and Nordstrom J.L. 1992. A faster ribonuclease protection assay. *BioTechniques* **13**: 846-850.
- Salomaa P. 1956. Two volumetric methods for the determination of glyoxal. *Acta Chem. Scand.* **10**: 306-310.
- Schick B.P. and Eras J. 1995. Proteoglycans partially co-purify with RNA in TRI Reagent™ and can be transferred to filters by northern blotting. *BioTechniques* **18**: 574-578.
- Schowalter D.B. and Sommer S.S. 1989. The generation of radio-labelled DNA and RNA probes with polymerase chain reaction. *Anal. Biochem.* **177**: 90-94.
- Scully S.P., Joyce M.E., Abidi N., and Bolander M.E. 1990. The use of polymerase chain reaction generated nucleotide sequences as probes for hybridization. *Mol. Cell. Probes* **4**: 485-495.
- Seed B. 1982a. Attachment of nucleic acids to nitrocellulose and diazonium-substituted supports. *Genet. Eng.* **4**: 91-102.
- . 1982b. Diazotizable acrylamine cellulose papers for the coupling and hybridization of nucleic acids. *Nucleic Acids Res.* **10**: 1799-1810.
- Shapiro R. and Hachmann J. 1966. The reaction of guanine derivatives with 1,2-dicarbonyl compounds. *Biochemistry* **5**: 2799-2807.
- Sharp P.A., Berk A.J., and Berget S.M. 1980. Transcriptional maps of adenovirus. *Methods Enzymol.* **65**: 750-768.
- Sharrocks A.D. and Hornby D.P. 1991. S1 nuclease transcript mapping using sequenase-derived single-stranded probes. *BioTechniques* **10**: 426, 428.
- Shishido K. and Ando T. 1982. Single-strand-specific nucleases. In *Nucleases* (ed. S.M. Linn and R.J. Roberts), pp. 155-185. Cold Spring Harbor Laboratory, Cold Spring Harbor, New York.
- Shishido K. and Habuka N. 1986. Purification of S1 nuclease to homogeneity and its chemical, physical and catalytic properties. *Biochim. Biophys. Acta* **884**: 215-218.
- Silber J.R. and Loeb L.A. 1981. S1 nuclease does not cleave DNA at single-base mis-matches. *Biochim. Biophys. Acta* **656**: 256-264.
- Simms D., Cizdziel P.E., and Chomczynski P. 1993. TRIzol™: A new reagent for optimal single-step isolation of RNA. *Focus (Life Technologies)* **15**: 99-102.
- Singh L. and Jones K.W. 1984. The use of heparin as a simple cost-effective means of controlling background in nucleic acid hybridization procedures. *Nucleic Acids Res.* **12**: 5627-5638.
- Sisodia S.S., Cleveland D.W., and Sollner-Webb B. 1987. A combination of RNase H and S1 circumvents an artifact inherent to conventional S1 analysis of RNA splicing. *Nucleic Acids Res.* **15**: 1995-2011.
- Sobell H.M. 1973. The stereochemistry of actinomycin binding to DNA and its implications in molecular biology. *Prog. Nucleic Acid Res. Mol. Biol.* **13**: 153-190.
- Solazzo M., Spinelli L., and Cesarini G. 1987. SP6 RNA polymerase: Sequence requirements downstream from the transcription initiation start site. *Focus (Life Technologies)* **10**: 11-12.
- Southern E.M. 1975. Detection of specific sequences among DNA fragments separated by gel electrophoresis. *J. Mol. Biol.* **98**: 503-517.
- Spanakis E. 1993. Problems related to the interpretation of autoradiographic data on gene expression using common constitutive transcripts as controls. *Nucleic Acids Res.* **21**: 3809-3819.
- Sparmann G., Jäschke A., Loehr M., Liebe S., and Emmrich J. 1997. Tissue homogenization as a key step in extracting RNA from human and rat pancreatic tissue. *BioTechniques* **22**: 408-410.
- Steyaert J. 1997. A decade of protein engineering on ribonuclease T1: Atomic dissection of the enzyme-substrate interactions. *Eur. J. Biochem.* **247**: 1-11.
- Stürzl M. and Roth W.K. 1990a. Run-off synthesis and application of defined single-stranded DNA hybridization probes. *Anal. Biochem.* **185**: 164-169.
- . 1990b. PCR-synthesized single-stranded DNA: A useful tool for 'hyb' and 'HAP' standardization for construction of subtraction libraries. *Trends Genet.* **6**: 106.
- Sück D., Dominguez R., Lahm A., and Volbeda A. 1993. The three-dimensional structure of *Penicillium* P1 and *Aspergillus* S1 nucleases. *J. Cell. Biochem. Suppl.* **17C**: 154.
- Sung S.C. and Laskowski Sr., M. 1962. A nuclease from mung bean sprouts. *J. Biol. Chem.* **237**: 506-511.
- Tanford C. 1968. Protein denaturation. *Adv. Protein Chem.* **23**: 121-282.
- Tavangar K., Hoffman A.R., and Kraemer F.B. 1990. A micromethod for the isolation of total RNA from adipose tissue. *Anal. Biochem.* **186**: 60-63.
- Thomas P.S. 1980. Hybridization of denatured RNA and small DNA fragments transferred to nitrocellulose. *Proc. Natl.*



- Acad. Sci.* **77**: 5201–5205.
1983. Hybridization of denatured RNA transferred or dotted nitrocellulose paper. *Methods Enzymol.* **100**: 255–266
- Toscani A., Soprano D.R., Cosenza S.C., Owen T.A., and Soprano K.J. 1987. Normalization of multiple RNA samples using an in vitro-synthesized external standard cRNA. *Anal. Biochem.* **165**: 309–319.
- Tsao S.G., Brunk C.F., and Pearlman R.E. 1983. Hybridization of nucleic acids directly in agarose gels. *Anal. Biochem.* **131**: 365–372.
- Tsykin A., Thomas T., Milland J., Aldred A.R., and Schreiber G. 1990. Dot blot hybridization using cytoplasmic extracts is inappropriate for determination of mRNA levels in regenerating liver. *Nucleic Acids Res.* **18**: 382.
- Twomey T.A. and Krawetz S.A. 1990. Parameters affecting hybridization of nucleic acids blotted onto nylon or nitrocellulose membranes. *BioTechniques* **8**: 478–482.
- Uchider T. and Egami F. 1967. The specificity of ribonuclease T2. *J. Biochem.* **61**: 44–53.
- Ullrich A., Shine J., Chirgwin J., Pictet R., Tischer E., Rutter W., and Goodman H. 1977. Rat insulin genes: Construction of plasmids containing the coding sequences. *Science* **196**: 1313–1319.
- Upcroft P. and Healey A. 1987. Rapid and efficient method for cloning of blunt-ended DNA fragments. *Gene* **51**: 69–75.
- Vales L.D., Rabin B.A., and Chase J.W. 1982. Subunit structure of *Escherichia coli* exonuclease VII. *J. Biol. Chem.* **257**: 8799–8805.
- Vogt V.M. 1973. Purification and further properties of single-strand-specific nuclease from *Aspergillus oryzae*. *Eur. J. Biochem.* **33**: 192–200.
- Wahl G.M., Stern M., and Stark G.R. 1979. Efficient transfer of large DNA fragments from agarose gels to diazobenzyloxymethyl paper and rapid hybridization using dextran sulfate. *Proc. Natl. Acad. Sci.* **76**: 3683–3687.
- Wang J.C. 1974. Interactions between twisted DNAs and enzymes: The effects of superhelical turns. *J. Mol. Biol.* **87**: 797–816.
- Weaver R.F. and Weissmann C. 1979. Mapping of RNA by a modification of the Berk-Sharp procedure: The 5'-terminus of 15 S  $\beta$ -globin mRNA precursor and mature 10 S  $\beta$ -globin mRNA have identical map coordinates. *Nucleic Acids Res.* **7**: 1175–1193.
- Wetmur J.G. and Davidson N. 1968. Kinetics of renaturation of DNA. *J. Mol. Biol.* **1**: 349–370.
- Weydert A., Daubas P., Caravatti M., Minty A., Bugaisky G., Cohen A., Robert B., and Buckingham M. 1983. Sequential accumulation of mRNAs encoding different myosin heavy chain isoforms during skeletal muscle development *in vivo* detected with a recombinant plasmid identified as coding for an adult fast myosin heavy chain from mouse skeletal muscle. *J. Biol. Chem.* **258**: 13867–13874.
- White B.A. and Bancroft F.C. 1982. Cytoplasmic dot hybridization. Simple analysis of relative mRNA levels in multiple small cell or tissue samples. *J. Biol. Chem.* **257**: 8569–8572.
- Wicks R.J. 1986. RNA molecular weight determination by agarose gel electrophoresis using formaldehyde as denaturant: Comparison of RNA and DNA molecular weight markers. *Int. J. Biochem.* **18**: 277–278.
- Wilkinson D.G., Bhatt S., and Herrmann B.G. 1990. Expression pattern of the mouse T gene and its role in mesoderm formation. *Nature* **343**: 657–659.
- Williamson R., Morrison M., Lanyon G., Eason R., and Paul J. 1971. Properties of mouse globin messenger ribonucleic acid and its preparation in milligram quantities. *Biochemistry* **10**: 3014–3021.
- Winter E., Yamamoto F., Almoguera C., and Perucho M. 1985. A method to detect and characterize point mutations in transcribed genes: Amplification and overexpression of the mutant c-Ki-ras allele in human tumor cells. *Proc. Natl. Acad. Sci.* **82**: 7575–7579.
- Wreschner D.H. and Herzberg M. 1984. A new blotting medium for the simple isolation and identification of highly resolved messenger RNAs. *Nucleic Acids Res.* **12**: 1349–1359.
- Zinn K., DiMaio D., and Maniatis T. 1983. Identification of two distinct regulatory regions adjacent to the human  $\beta$ -interferon gene. *Cell* **34**: 865–879.
- Zolfaghari R., Chen X., and Fisher E.A. 1993. Simple method for extracting RNA from cultured cells and tissue with guanidine salts. *Clin. Chem.* **39**: 1408–1411.

# Index

*We shall not cease from exploration  
And the end of all our exploring  
Will be to arrive where we started  
And know the place for the first time.*

T.S. Eliot

- Aat*II cleavage at end of DNA fragments, A6.4  
ABLE C, 1.13  
ABLE K, 1.13  
ABTS. *See* 2,2'-azino-bis(3-ethylbenzothiazoline-6-sulphonic acid)  
Acc65 cleavage at end of DNA fragments, A6.4  
AccI cleavage of 7-deaza-dGTP modified DNA, 8.60  
AccIII, A4.7  
Acetic acid  
  for polyacrylamide gel fixation, 5.49–5.50, 12.90–12.92  
  recipes, A1.6  
Acetonitrile, 10.28–10.29, 10.42, 10.49, 18.68  
Acetyl-CoA, 17.95  
  CAT, 17.36–17.41  
  luciferase and, A9.22  
Acid citrate dextrose solution B (ACD), 6.8–6.9  
Acid hydrolyzed casein (AHC) medium, 4.65  
Acid phenol-guanidinium thiocyanate-chloroform extraction, 7.4–7.8  
Acids and bases, general, A1.6  
Acridine orange and glyoxylated RNA staining, 7.27  
Acridinium esters, chemiluminescence from, A9.17–A9.18  
Acrylamide, 12.71–12.75, A8.40–A8.43. *See also* Polyacrylamide; Polyacrylamide gel electrophoresis  
  recipe, A1.25  
  solutions for denaturing gels, table of, 12.78  
  solutions for denaturing polyacrylamide gels containing formamide, table of, 12.82  
  storage, 12.75  
Acrylamide gel elution buffer, 5.51–5.52  
Acrylease, 5.44, 12.75  
Actinomycin C, A2.7  
Actinomycin D, 11.38, A1.15  
  mechanism of action, 7.88, A2.7  
  overview, 7.88  
  in primer extension mix, 7.77  
  self-priming, inhibition of, 11.46  
  structure of, 7.88  
Activation domain fusion plasmids, 18.20  
ADA. *See* Adenosine deaminase  
Adamantyl 1,2-dioxetane phosphate (AMPPD), 9.79, A9.39–A9.40, A9.42–A9.44  
  kinetics of chemiluminescence, A9.44  
Adaptors  
  attaching to protruding termini, 1.88–1.89  
  cDNA cloning, 11.20–11.21, 11.51–11.55  
  in direct selection of cDNAs protocol, 11.102  
  directional cloning, 1.84  
  overview, 1.160  
  table of sequences, 1.161  
*ade* gene, 4.2, 4.59–4.60, 18.22  
Adenine, A6.6  
  methylation of, 11.48, 13.87–13.88, A4.3–A4.4  
  nitrous oxide modification of, 13.78  
  related compounds (Table A6-5), A6.6  
  structure, A6.6  
  in YAC vector growth, 4.65  
Adenosine deaminase (ADA), 16.47  
Adenosine diphosphate (ADP), A1.25  
Adenosine triphosphate (ATP), A1.25  
  dATP inhibition of T4 DNA ligase, 1.85  
  luciferase and, 17.44–17.45, 17.47, A9.22  
ADP. *See* Adenosine diphosphate  
Adsorption, viral, 2.4  
*Aequorea victoria*, 18.69, A9.24. *See also* Green fluorescent protein  
Aequorin, 17.84, 17.89, A9.24  
Affinity chromatography. *See also* Chromatography  
  antisera purification, 14.51  
  biotinavidin, 11.11  
  of *E. coli* lysate for cross-reactive antibody removal, 14.28–14.30  
  epitope tagging and, 17.91  
  fusion protein purification, 14.40, 14.43, 15.4–15.5  
  on amylose resin, 15.40–15.43  
  on glutathione agarose, 15.36–15.39  
  of maltose-binding proteins, 15.40–15.43  
  histidine-tagged protein purification, 15.44–15.48  
  metal chelate, 15.44–15.48  
  removal of cross-reactive antibodies, 14.28–14.30  
Affinity purification using magnetic beads, 11.118–11.120  
*Afl*II cleavage at end of DNA fragments, A6.4  
Agar, media containing, A2.5  
Agarase, 5.33–5.35, 5.83–5.88, A4.51  
Agarose. *See also* Agarose gel electrophoresis  
  blocks/plugs  
   $\lambda$  concatemer ligation in, 5.72–5.73  
  lysis of cells in, 5.61, 5.64–5.65, 5.67  
  for pulsed-field gel electrophoresis, 5.59, 5.61–5.70  
  restriction endonuclease digestion of DNA in, 5.68–5.70  
  storage of, 5.64, 5.67  
  composition of, 5.4  
  electroendo-osmosis (EEO), 5.7  
  low-melting-temperature, 5.6, 5.7  
  DNA recovery from, 5.29–5.35  
  pulsed-field gel electrophoresis gels, 5.83–5.88  
  DNA size selection in shotgun sequencing protocol, 12.18  
   $\lambda$  concatamer ligation in, 5.72–5.73  
  ligation in, 1.103–1.104, 5.29  
  migration rate through, 5.31  
  properties of, 5.6  
  pulsed-field gel electrophoresis, 5.61–5.67, 5.83–5.88  
  radiolabeling DNA in gel slices, 9.9  
  resolution of, 5.6  
  restriction endonuclease digestion in agarose plugs, 5.68–5.70  
  media containing, A2.5  
  types of, 5.6  
Agarose gel electrophoresis. *See also* Pulsed-field gel electrophoresis  
  alkaline, 5.36–5.39  
  autoradiography, 5.39  
  method, 5.38  
  Southern hybridization, 5.38  
  uses for, 5.36  
  analysis of linker/adaptor attachment to cDNA, 11.55  
  analysis of methylation of cDNA, 11.50  
  band-stab PCR of samples from gel, 8.71  
  cDNA fractionation, 11.9  
  denaturing, 7.21–7.23, 7.27–7.34  
  DNA content of  $\lambda$  stock and lysates, assaying, 2.45–2.46  
DNA detection, 5.14–5.17  
  ethidium bromide staining, 5.14–5.15  
  photography, 5.16–5.17  
  SYBR Gold staining, 5.15–5.16  
DNA recovery, 1.91, 5.18  
  anion-exchange chromatography, 5.26–5.28  
  DEAE cellulose membranes, electrophoresis onto, 5.18–5.22  
  dialysis bags, electroelution into, 5.23–5.25  
  low-melting temperature agarose  
  agarase, 5.33–5.35  
  glass bead use, 5.32  
  organic extraction, 5.29–5.31  
  problems associated with, 5.18  
DNA size selection in shotgun sequencing protocol, 12.18  
DNA transfer from capillary transfer  
  downward, 6.35  
  upward, 6.34–6.35  
  electrophoretic transfer, 6.36  
  simultaneous transfer to two filters, 6.35–6.36  
  vacuum transfer, 6.37  
electrophoresis buffers. *See also* Electrophoresis buffers  
  effect on DNA migration, 5.7–5.8  
  gel preparation, 5.10  
  recipes, 5.8  
ethidium bromide staining, A9.3–A9.4  
gel-loading buffers, 5.9  
history of, 5.3  
 $\lambda$  arm purification, 2.71  
large DNA molecules, difficulty entering the gel, 6.15  
markers, radiolabeled size, 9.54  
method, 5.10–5.13  
  comb placement, 5.11  
  gel preparation, 5.10  
  loading gel, 5.12–5.13  
  pouring gel, 5.11–5.13  
  well capacity, 5.12–5.13  
methylene blue staining, A9.5  
migration rate  
  DNA from alkaline lysis preparations, 1.40  
  DNA from boiled lysis preparations, 1.45, 1.49  
  DNA from toothpick minipreparations, 1.53  
ethidium bromide and, 1.53  
factors determining, 5.4–5.8  
  agarose concentration, 5.5  
  agarose type, 5.6–5.7  
  conformation of DNA, 5.5  
  electrophoresis buffer, 5.7–5.8  
  ethidium bromide presence, 5.5

## 1.2 Index

- Agarose gel electrophoresis (*continued*)  
size of DNA, 5.4  
voltage applied, 5.5–5.6  
minigels, 5.13  
mRNA fractionation for cDNA preparation, 11.9  
partial digestion products, separating, 2.78  
polyacrylamide gels compared, 5.2, 5.40  
pulsed-field gel electrophoresis  
overview of, 5.2–5.3  
resolution, 5.3  
for quantitating DNA, A8.24  
reptation, 5.2  
resolution, 5.2, 5.6, 5.12  
RNA separation  
equalizing RNA amounts, 7.22–7.23  
formaldehyde-containing gels, 7.31–7.34  
glyoxylated RNA, 7.27–7.30  
markers used for, 7.23, 7.29  
overview, 7.21–7.22  
pseudomessages as standards, 7.23  
tracking dyes, 7.23  
RNA transfer to membranes, 7.35–7.41  
Southern hybridization, 1.28  
standards, DNA size, 5.10  
storage of gels, 6.43  
Agel cleavage at end of DNA fragments, A6.4  
A gene/protein,  $\lambda$ , 2.14–2.15  
Air bubbles in polyacrylamide gels, 12.79  
Ala-64 subtilisin, 15.8  
Alanine  
codon usage, A7.3  
nomenclature, A7.7  
properties, table of, A7.8  
Alanine-scanning mutagenesis, 13.3, 13.81  
Alkaline agarose gel electrophoresis, 5.36–5.39. *See also* Agarose gel electrophoresis  
autoradiography, 5.39  
buffer, A1.17  
method, 5.38  
Southern hybridization, 5.38  
uses of, 5.36  
Alkaline gel-loading buffer, A1.18  
Alkaline lysis  
BAC DNA purification protocols, 4.53–4.57  
in P1/PAC DNA purification protocols, 4.41–4.43  
plasmid DNA protocols, 1.19  
maxipreparation protocol, 1.38–1.41  
midipreparation protocol, 1.35–1.37  
minipreparation protocol, 1.32–1.34  
overview, 1.31  
troubleshooting, 1.41–1.42  
yield, 1.41  
Alkaline lysis solutions I, II, and III 1.32–1.33, 1.35–1.36, 1.38, 1.40, 3.24–3.25  
in plasmid DNA purification by precipitation with PEG, 12.31  
recipes, A1.16  
Alkaline phosphatase, A8.55  
antibody conjugates, A9.34  
calculating amount of 5' ends in a DNA sample, 9.63  
chemiluminescent enzyme assay, A9.19  
dephosphorylation  
of M13 vector DNA, 12.24  
of plasmid DNA, 1.93–1.97  
digoxigenin-specific antibodies coupled to, A9.39–A9.40  
in end-labeling, 9.55  
inactivation, 1.96, 9.62, 9.64, 9.93  
 $\lambda$  vector DNA, treatment of, 2.68–2.70  
in M13 vectors, 3.34, 3.36  
overview, 9.92–9.93, A4.37  
properties of, 9.92–9.93  
protocol, 9.62–9.65  
purification of dephosphorylated DNA, 9.64  
as reporter enzyme, 9.92, 17.31  
for biotin, 9.76  
chemiluminescence, 9.79  
colorimetric assays, 9.78  
for digoxigenin, 9.77  
direct detection, 9.80  
for fluorescein, 9.77  
fluorescent assays, 9.79  
in screening expression libraries, 14.3  
chemiluminescent, 14.11, 14.21  
chromogenic, 14.9–14.10, 14.20  
self-ligation, prevention of, 9.92  
substrates  
AMPPD, A9.39, A9.42–A9.44  
BCIP/NPT, A9.39–A9.40  
D-luciferin-O-phosphate, A9.42  
p-nitrophenyl phosphate, A9.41–A9.42  
use in cosmid vector cloning, 4.15, 4.19, 4.20–4.21  
Alkaline phosphatase promoter (PhoA) for expression of cloned genes in *E. coli*, 15.30–15.35  
large-scale expression, 15.34  
materials for, 15.31–15.32  
optimization, 15.33  
overview, 15.30  
protocol, 15.32–15.34  
subcellular localization of fusion proteins, 15.35  
Alkaline transfer buffer, 6.40, 6.44, 6.46, A1.12  
Allele-specific oligonucleotides (ASO), 13.91, 13.95  
Allyl alcohol, 12.70–12.71  
 $\alpha$ -amanitin, 17.29  
 $\alpha$ -complementation, 1.149–1.150  
in BAC vectors, 4.3  
in  $\lambda$  vectors, 11.22, 11.25  
in M13, 3.8, 3.10, 3.33  
in pMAL vectors, 15.40  
problems with, 1.27, 1.150  
in protein-protein interaction assays, 18.127  
protocol, 1.123–1.125  
in pUC vectors, 1.10, 3.9  
 $\alpha$ -galactosidase (MEL1), 18.14  
 $\alpha$ -thrombin, 15.8  
Altered sites II in vitro mutagenesis system, 13.89  
*Alteromonas espejiana*, 13.62, 13.71–13.72, A4.43  
*AluI* cleavage of 7-deaza-dGTP-modified DNA, 8.60  
*AluI* methylase, A4.7  
AMAD. *See* Another MicroArray database  
Amber mutation, A7.5  
in  $\lambda$  S gene, 2.15  
in M13 vectors, 3.11–3.13  
*supE* mutation, 3.11–3.13  
Amber suppressors, A7.5–A7.6  
Amberlite XAD-16, A8.28  
Ambion, 1.64  
Amidine, 16.11  
Amine-coupling kit, 18.104  
Amino acids  
codon usage, A7.2–A7.4  
hydrophobicity/hydrophilicity scales, A9.31  
nomenclature, table of, A7.7  
overview, A7.6  
properties, table of, A7.8–A7.9  
side chain properties, A7.7  
Venn diagram of, A7.6  
N-(4-aminobutyl)-N-ethylisoluminol (ABEI), A9.18  
Aminoformamidinium hydrochloride. *See* Guanidinium chloride  
Aminoglycoside phosphotransferase, 16.47–16.48  
Aminophosphotransferases (APHs), 1.145  
Aminopterin, 16.47, 16.48  
Ammonium acetate  
in ethanol precipitation of nucleic acids, A8.12  
in ethanol precipitation of oligonucleotides, 10.20–10.21  
recipe, A1.25  
Ammonium hydroxide, A1.6  
Ammonium ion inhibition of T4 polynucleotide kinase, A4.35  
Ammonium persulfate, 5.41–5.43, 7.58, 12.75, 12.78, 12.82, 13.53–13.54, A1.25, A8.42  
Ammonium sulfate, 8.9, 11.43, 11.45  
in long PCR buffer, 8.78  
in PCR lysis solution, 6.22  
*ampC*, 15.26  
Amphotericin, A2.7  
Ampicillin, 1.9  
mechanism of resistance to, 1.148  
modes of action, 148, A2.7  
properties, 1.148  
satellite colonies, 1.148  
selecting transformants, 1.110, 1.115, 1.118  
stock/working solutions, A2.6  
Ampicillin resistance gene (*amp<sup>r</sup>*) gene, 1.9  
in activation domain fusion plasmids, 18.20  
in LexA fusion plasmids, 18.19  
in pMC9, 14.6  
in two-hybrid system of reporter plasmids, 18.12  
Amplification  
of bacteriophage, in situ, 2.95  
of cDNA libraries, 11.64–11.66  
of cosmid libraries  
on filters, 4.31–4.32  
in liquid culture, 4.28–4.30  
on plates, 4.34  
of genomic libraries, 2.87–2.89  
for hybridization procedures, 1.128, 1.131  
of plasmids  
chloramphenicol and, 1.4, 1.39, 1.48, 1.56, 1.128, 1.131, 1.143  
runaway plasmid vectors, 1.13  
Amplification buffer, A1.9  
Amplification refractory mutation system (ARMS), 13.91, 13.96  
Amplify scintillant, A9.12  
AmpliQ DNA polymerase. *See also* Taq DNA polymerase  
AmpliQ Gold, 8.110  
CS DNA polymerase, 12.54  
in cycle sequencing reactions, 12.46–12.47  
structure of, 12.47  
FS DNA polymerase  
in cycle sequencing reactions, 12.46–12.47  
in DNA sequencing  
automated, 12.98  
dye-primer sequencing, 12.96  
dye-terminator systems, 12.96–12.97  
structure of, 12.47  
properties, table of compared, A4.11  
Ampliwax PCR Gems, 8.110  
AMPPD. *See* Adamantyl 1,2-dioxetane phosphate  
*amp<sup>r</sup>*. *See* Ampicillin resistance gene (*amp<sup>r</sup>*) gene  
Amylose agarose, affinity chromatography use of, 15.40–15.43  
Analytical ultracentrifugation, 18.96  
Anion-exchange chromatography, DNA purification by, 5.26–5.28  
Annealing buffer in nuclease S1 mapping of RNA, 7.55, 7.58  
Annealing reactions  
CTAB and, 6.62  
in PCR, 8.8–8.9  
in primer extension assays, 7.76, 7.79  
in ribonuclease protection assay protocol, 7.73  
in S1 protection assays, 7.51  
Annealing temperature  
in inverse PCR, 8.85  
in long PCR, 8.80  
in touchdown PCR, 8.112  
Another MicroArray database (AMAD), A10.15  
Antibiotics. *See also specific antibiotics*  
modes of action, table of, A2.7

- for protein expression optimization, 15.19  
as selectable markers, 1.8–1.9  
stock/working solutions, A2.6
- Antibodies**, A9.25–A9.34  
  antipeptide, A9.30–A9.33  
  applications, A9.25  
  immunoprecipitation, 18.60–18.68  
  conjugated, A9.33–A9.34  
    biotinylated, A9.33  
    enzymic, A9.34  
    fluorochrome, A9.33  
  Cy3 labeling, 18.82–18.83  
  digoxigenin-specific, A9.40  
  epitope tagging, 1.14, 17.32, 17.90–17.93  
  Fab fragment generation and purification, 18.81–18.82  
  GFP, 17.89  
  immunological assays, A9.27–A9.30  
    immunoblotting, A8.54–A8.55  
    immunoprecipitation, A9.29  
    RIA, A9.29–A9.30  
    western blotting, A9.28  
  immunological screening  
    antibody choice for, 14.50–14.51  
    polyclonal vs. monoclonal, 14.50  
    purification, 14.51  
  phage display of, 18.122  
  probes for screening expression libraries, 14.1–14.2  
  protein microarrays, A10.18  
  purification of, A9.25–A9.27  
  radiolabeling, A9.30  
  removal of cross-reactive  
    affinity chromatography, 14.28–14.30  
    incubation with *E. coli* lysate, 14.26–14.27  
    pseudoscreening, 14.23–14.25  
  in SPR spectroscopy of protein interactions, 18.103–18.114  
  use in supershift assays, 17.17
- Antipain dihydrochloride**, A5.1
- Antipeptide antibodies**, A9.30–A9.33
- Antiporter proteins**, 1.26, 1.146
- Antisense primer**, 8.46–8.48, 8.50, 8.52, 8.56–8.57, 8.61, 8.63, 8.69, 8.90–8.92
- Antitermination factors in  $\lambda$** , 2.6–2.8, 2.11
- Antithrombin III**, A5.1
- ApaI**  
  cleavage at end of DNA fragments, A6.4  
  fragment size created by, table of, A4.8  
  site frequency in human genome, 4.16, A6.3
- APIs**. *See* Aminophosphotransferases
- APMSI**, A5.1
- Aprotinin**, 18.67, A5.1  
  in cell resuspension buffer, 17.6  
  as protease inhibitor, 15.19
- Aptamers**, peptide, 18.8
- Apurinic DNA**. screening expression libraries, 14.2
- Arabidopsis***  
  database, A11.20  
  genomic resources for microarrays, A10.6
- Arginine**  
  for affinity purification of fusion proteins, 15.6  
  codon usage, A7.3  
  nomenclature, A7.7  
  properties, table of, A7.8
- ARMS**. *See* Amplification refractory mutation system
- Arrayed libraries**, 4.8  
  BAC, 4.50  
  differential screening, 9.90  
  P1, 4.39  
  YAC, 4.61
- Arrays**. *See* DNA array technology
- ArrayVision image analysis program**, A10.13
- Ascl**  
  cleavage at end of DNA fragments, A6.4  
  fragment size created by, table of, A4.8  
  genomic DNA mapping, 5.68–5.69  
  site frequency in human genome, 4.16, A6.3
- Ascl**, A4.9
- Asialofetuin**, for protein stability, 17.16
- Asparagine**  
  codon usage, A7.3  
  nomenclature, A7.7  
  properties, table of, A7.8
- Aspartic acid**  
  cleavage by formic acid, 15.6, 15.8  
  codon usage, A7.3  
  nomenclature, A7.7  
  properties, table of, A7.8
- Aspergillus oryzae***, A4.46
- Aspiration of supernatants**, 1.33, 1.36, 1.45
- Assembly of bacteriophage particles**,  $\lambda$ , 2.14–2.15
- ASSET (Aligned Segment Statistical Evaluation Tool)** program, A11.9
- AstII***, A4.7
- Atlas cDNA arrays**, A10.9
- ATP**. *See* Adenosine triphosphate
- att* sites**,  $\lambda$ , 2.16, 2.18
- AU epitopes**, 17.93
- Authorin program**, A11.3
- Autographa californica* nuclear polyhedrosis (AcNPV or AcMNPV)**, 17.81–17.83
- Autonomously replicating sequence (ARS)**, 4.2–4.3, 4.60
- Autoradiography**, A9.9–A9.15  
  of alkaline agarose gels, 5.39  
  chemical DNA sequencing gels and, 12.61–12.62, 12.74, 12.90–12.91  
  chemiluminescent, 14.11–14.12, 14.21–14.22  
  in coimmunoprecipitation protocol, 18.62–18.63  
  DNase I footprinting, 17.76  
  fluorography, A9.12  
  imaging, A9.9–A9.10  
  intensifying screen, A9.11  
  isotopes used  
    decay data, A9.15  
    particle spectra, A9.9–A9.10  
    sensitivity of detection, A9.13  
    mutation detection with SSCP, 13.52, 13.55  
  phosphorimaging, A9.11–A9.14  
  phosphorimaging devices, A9.14  
  polyacrylamide gels, DNA detection in, 5.49  
  preflashing, A9.11–A9.12  
  reading an autoradiograph, 12.113  
  setting up autoradiographs, A9.13–A9.14
- AvaI*** in phosphorothioate incorporation mutagenesis, 13.86
- Avian myeloblastosis virus (AMV)**, 11.109. *See also* Reverse transcriptase  
  reverse transcriptase, A4.24–A4.25  
  RNA-dependent DNA polymerase, 8.48  
  RNase H activity, 11.109
- Avidin**, 11.115–11.117, A9.45
- Avidin-biotin (ABC) assay**, A9.33
- AvrII***  
  cleavage at end of DNA fragments, A6.4  
  fragment size created by, table of, A4.8  
  site frequency in human genome, 4.16, A6.3  
  2,2'-azino-di(3-ethylbenzthiazoline-6-sulphonic acid) (ABTS), A9.35
- BAC**. *See* Bacterial artificial chromosomes
- Bacillus subtilis***  
  expression in, 15.55  
  genomic resources for microarrays, A10.6
- Bacterial alkaline phosphatase (BAP)**, 9.92–9.93, A4.37
- Bacterial artificial chromosomes (BACs)**, 4.48–4.57  
  advantages of, 4.48  
   $\alpha$ -complementation in, 4.3  
  CIT Human BAC Library, 4.9  
  clone size, 4.3–4.4  
  copy number, 4.48  
  DNA purification  
    from large-scale cultures, 4.55–4.57  
    from small-scale cultures, 4.53–4.54  
  electroporation, 4.49, 4.52  
  genomic libraries  
    arrayed libraries, 4.8  
    choosing for construction of, 4.7–4.10  
  construction, 4.49–4.50  
    RPCI-11 Human BAC Library, 4.9  
    screening, 4.50–4.51  
  low-copy-number replicons, 1.3  
  overview, 4.2–4.4  
  size of inserts, 4.49  
  storage, 4.51  
  vectors, A3.5
- Bacterial colonies**, screening by PCR, 8.74–8.75
- Bacterial cultures**  
  receiving in the laboratory, 1.29  
  storage of, A8.5
- Bacterial strains**. *See* *Escherichia coli* strains
- Bacteriophage**  
   $\phi$ 1. *See*  $\phi$ 1 bacteriophage  
   $\phi$ X174. *See*  $\phi$ X174 bacteriophage  
   $\lambda$ . *See*  $\lambda$  bacteriophage  
  M13. *See* M13 bacteriophage  
  P1. *See* P1 bacteriophage  
  SP6. *See* SP6 bacteriophage  
  T3. *See* T3 bacteriophage  
  T4 DNA ligase buffer, A1.9  
  T4 DNA polymerase buffer, A1.10  
  T4 DNA polymerase repair buffer, 11.53  
  T4 polynucleotide kinase buffer, A1.10  
  T7. *See* T7 bacteriophage
- Bacteriophages**. *See also specific bacteriophages*  
  CsCl density gradients purification of, 1.155  
  filamentous, 3.1–3.7  
  historical perspective, 2.109  
  male-specific, 3.2  
  origin of replication, 1.11  
  phagemids, 1.11  
  promoters, 1.11–1.12, 9.31. *See also* Promoters: *specific promoters*
- Baculovirus**, 17.81–17.84  
  expression systems  
    commercial, 17.84  
    drawbacks of, 17.83  
    vectors, 17.83  
  gene expression in, 17.82  
  history, 17.81  
  host interactions, 17.81–17.82  
  as pesticides, 17.81  
  vectors, 17.83
- Baking hybridization membranes**, 6.46
- BAL 31 buffer**, A1.10
- BAL 31 nuclease**, 13.2  
  activities of, 13.68  
    endonuclease activity, A4.44–A4.45  
    exonuclease activity, A4.44–A4.45  
  assaying activity of, 13.64–13.65  
  checking progress of digestion, 13.71  
  deletion mutant sets, generation of bidirectional, 13.62–13.67  
    materials for, 13.62–13.63  
    protocol, 13.63–13.67  
  fast and slow forms, A4.44  
  heat inactivation of, 13.65  
  history of, 13.71–13.72  
  inhibition by EGTA, 13.64  
  overview, 13.68–13.72, A4.43–A4.45  
  properties of, 13.68–13.71  
  storage, A4.44  
  unidirectional mutations, generation of, 13.68, 13.70  
  uses, list of, A4.43

- Bam*HI  
 7-deaza-dGTP modified DNA, cleavage of, 8.60  
 cleavage at end of DNA fragments, A6.4  
*dam* methylation and, 13.87, A4.3  
 directional cloning use of, 1.84  
 fragment size created by, table of, A4.8  
 linker sequences, 1.99  
 methylase, A4.7  
 site frequency in human genome, 4.16, A6.3  
 in USE, 13.85
- Band-stab PCR of samples from gel, 8.71  
 BankIt program, A11.3  
 BAP. See Bacterial alkaline phosphatase  
 Barcode chip, A10.19  
 Barnase in positive selection vectors, 1.12  
 Base-excision repair, exonuclease III and, 13.73  
 Batch chromatography, selection of poly(A)<sup>+</sup> RNA  
 by, 7.18–7.19
- BAX gene, 17.72  
 Bayes Block Aligner program, A11.4–A11.5  
 Baylor College of Medicine Search Launcher, A11.2  
 BB4 *E. coli* strain, 2.29, 11.23–11.25, 11.60–11.62,  
 11.66, 14.6, A3.6
- BCIP (5-bromo-4-chloro-3-indolyl phosphate),  
 9.78, 14.9–14.10, 14.20, A9.39–A9.42
- Bcl*I, 13.87, A4.3, A4.9  
 BEAUTY (BLAST Enhanced Alignment Utility)  
 program, A11.17  
 Beckman Coulter Multimek, A10.5  
 Benzamide as protease inhibitor, 15.19  
 BES-N,N-bis[2-hydroxyethyl]-2-aminoethanesul-  
 fonic acid, 16.19  
 BES-buffered saline (BBS), 16.19–16.20  
 Bestatin, A5.1  
 $\beta$ -actin, normalizing RNA samples against, 7.22  
 $\beta$ -galactosidase, 17.97–17.99. See also Fusion pro-  
 teins; *lacZ*  
 $\alpha$ -complementation, 1.26–1.27, 1.123, 1.125,  
 1.149–1.150  
 antibody conjugates, A9.34  
 assay of activity by chloroform overlay assay,  
 18.28  
 chemiluminescent enzyme assay, A9.19  
 fusion proteins, 15.26  
 affinity purification of fusion proteins, 15.6  
 disadvantages, 15.58  
 inclusion bodies, 15.58  
 vectors for, 15.59  
 histochemical stains, 17.98–17.99  
 immunohistochemical staining of cell monolay-  
 ers for, 16.13  
 ONPG substrate, 17.50–17.51  
 in protein-protein interaction assays, 18.127  
 quantitative assays  
 MUG hydrolysis, 17.98  
 ONPG hydrolysis, 17.97–17.98  
 reaction catalyzed by, 17.98–17.99  
 reporter assays, 17.48–17.51  
 as digoxigenin reporter enzyme, 9.77  
 endogenous mammalian  $\beta$ -galactosidase  
 activity, 17.48  
 materials for, 17.50  
 method, 17.51  
 normalizing reporter enzyme activity to  $\beta$ -  
 galactosidase activity, 17.48, 17.51  
 overview, 17.48–17.49  
 p $\beta$ -gal reporter vectors, 17.49  
 substrates for  $\beta$ -galactosidase, 17.51
- substrates, 17.50  
 as transfection control (reporter gene), 16.4,  
 16.12–16.13  
 vectors containing. See also specific vectors  
 Bluescript plasmid, 1.27  
 expression vectors, 14.47–14.48  
 $\lambda$  vectors, 2.30, 11.22, 11.25  
 pGEM, 1.27  
 pMAL vectors, 15.40  
 pUC vectors, 1.10  
 X-gal, 1.149
- $\beta$ -glucuronidase, 16.42, 18.14  
 $\beta$ -glucuronidase lysis solution, 18.46  
 $\beta$ -lactamase  
 mechanism of action, 1.148  
 satellite colonies and, 1.110, 1.115, 1.118  
 $\beta$ -mercaptoacetic acid, 15.44  
 $\beta$ -mercaptoethanol, 15.44  
 $\beta$ -nicotinamide adenine dinucleotide ( $\beta$ -NAD),  
 11.43, 11.45
- Bgl*I  
 fragment size created by, table of, A4.8  
 linker sequences, 1.99  
 site frequency in human genome, 4.16, A6.3
- Bgl*II  
 cleavage at end of DNA fragments, A6.4  
*dam* methylation and, 13.87, A4.3  
 directional cloning use of, 1.84  
 fragment size created by, table of, A4.8  
 site frequency in human genome, 4.16, A6.3  
 in USE, 13.85
- BHB2688 *E. coli* strain  
 genotype, A3.6  
 $\lambda$  vector propagation, 2.29
- BHB2690 *E. coli* strain  
 genotype, A3.6  
 $\lambda$  vector propagation, 2.29
- BLAcore, 18.96–18.114  
 BLAevaluation software, 18.97, 18.101–18.102,  
 18.112  
 BLAsimulation software, 18.98  
 chips, 18.98–18.100  
 components of, 18.97  
 Interaction Wizard, 18.108  
 protocol design, 18.102–18.114  
 sensorgrams, 18.100–18.101, 18.112–18.114  
 writing methods with BLAcore Method  
 Definition Language, 18.108
- BLAevaluation software, 18.97, 18.101–18.102,  
 18.112  
 BLAsimulation software, 18.98  
 Bidirectional dideoxy fingerprinting (Bi-ddF),  
 13.91, 13.94  
 BigDye terminators, 12.96–12.99  
 Binary expression system, 9.88  
 Binding buffer, 14.33, 15.45  
 BioChip Arrayer, A10.16  
 BioChip Imager, A10.11  
 Bioelectric chips, A10.19  
 Bio-Gel HTP, A8.33  
 Bio-Gel P-60, 10.26, A8.29–A8.30  
*bio* gene,  $\lambda$  transduction of, 2.18  
 Bioinformatics, A10.15, A11.1–A11.23  
 databases, A11.20–A11.21  
 DNA, A11.20–A11.21  
 microarray, A10.15  
 protein, A11.22–A11.23  
 RNA, A11.21–A11.22  
 database similarity search software (Table A11-  
 2), A11.18–A11.19  
 software (Table A11-1), A11.3–A11.7  
 DNA, A11.3–A11.14  
 genes, exons and introns, A11.10–A11.12  
 motifs and patterns, A11.8–A11.10  
 promoters, transcription-factor-binding  
 sites, A11.12–A11.13  
 regulatory sites, miscellaneous, A11.14  
 scoring matrices, A11.5  
 sequence alignment, A11.3–A11.8  
 sequence submission, A11.3  
 protein, A11.16–A11.17  
 motifs, patterns, and profiles, A11.16–A11.17  
 sequence alignment, A11.16  
 RNA, A11.14–A11.15  
 RNA-specifying genes, motifs, A11.15  
 secondary structure, A11.14–A11.15  
 Web site resources, A11.2
- Biolistic PDS-1000/He Particle Delivery System,  
 16.39  
 Biolistics, 16.3, 16.37–16.41  
 materials for, 16.38–16.39  
 method, 16.39–16.41  
 particle types, 16.37  
 variables, 16.37
- Bioluminescence, A9.21–A9.24  
 bacterial luciferase, A9.23–A9.24  
 firefly luciferase, A9.21–A9.23  
 assays for, A9.22–A9.23  
 properties of, A9.21–A9.22  
 as reporter molecule, A9.23  
 GFP, A9.24  
 Bioluminescent resonance energy transfer (BRET),  
 17.87–17.89
- Biomolecular Structure and Modeling group at the  
 University College, London, A11.22
- BioRobot (Qiagen), A10.5  
 Biotin, 9.76–9.79, A9.45  
 bridged avidin-biotin (BRAB) assay, A9.33  
 CARD protocol and, A9.19  
 derivatives, 11.116  
 labeling  
 antibodies, A9.33  
 in cycle DNA sequencing, 12.52  
 direct selection of cDNAs protocol, 11.98–  
 1.99, 11.102, 11.106  
 enzymatic labeling, 9.77–9.78  
 GST, 18.50  
 of nucleic acids, 11.116–11.117  
 photolabeling, 9.78  
 probes, for in situ hybridization, 9.35  
 of proteins, 11.115–11.117  
 in subtractive hybridization, 9.91  
 overview, 11.115  
 structure of, 11.116, A9.45  
 in SPR spectroscopy, 18.99
- Biotin:avidin affinity chromatography, 11.11  
 Bisacrylamide, 12.74–12.75, A8.40–A8.41. See also  
 Polyacrylamide gel electrophoresis  
 storage, 12.75
- Bis-Tris, 7.28  
 Bis-Tris-Cl, 5.33  
 Bisulfite, mutagenesis from, 13.78  
 BL21 *E. coli* strain, 15.21–15.23, A3.6  
*bla* gene, 1.148  
 BLAST (Basic Alignment Search Tool) program,  
 A11.3, A11.18  
 BLAST2 (Gapped-BLAST) program, A11.18–  
 A11.19  
 BLAST-Genome Sequences program, A11.19  
 Bleomycin modes of action, A2.7  
 BLIMPS-BLOCKS Improved Searcher program,  
 A11.9  
 Blocking agents, A1.14–A1.16, A8.54  
 for nucleic acid hybridization, A1.14–A1.15  
 for western blotting, A1.16  
 Blocking buffer, 14.4, 14.9, 14.15, 14.23, 14.26,  
 A1.12  
 BLOCKS server program, A11.9
- Blood cells  
 buffy coat removal by aspiration, 6.9  
 collection of cells  
 from freshly drawn blood, 6.8–6.9  
 from frozen blood, 6.9  
 lysis of, 6.8–6.9
- BLOSUM scoring matrices program, A11.5  
 BLOTTO (Bovine Lacto Transfer Technique  
 Optimizer)  
 in northern hybridization, 7.45  
 for protein stability, 17.16  
 recipe, A1.15

- in Southern hybridization, 1.139, 6.56, A1.14–A1.15
  - Bluescript vectors. *See* pBluescript vectors
  - Blunt-ended DNA
    - addition of synthetic linkers to, 1.98–1.102
    - cloning, 1.22–1.24
    - of PCR products, 8.32–8.34
    - into plasmid vectors, 1.90–1.92
    - creation with T4 DNA polymerase, A4.19
    - end-labeling with Klenow, 9.52–9.53, 9.55–9.56
    - generation by mung bean nuclease, 7.87
    - ligation with T4 DNA ligase, A4.31–A4.32
    - linker/adaptor ligation, 11.51–11.52
    - phosphorylation of, 9.70–9.72
    - radiolabeling using Klenow, 12.101
  - BMH71-181 *E. coli* strain, 13.29
  - BNN93 *E. coli* strain
    - genotype, A3.6
    - $\lambda$  vector propagation, 2.28
  - BNN102 *E. coli* strain, 4.83–4.84, 11.59–11.60, 11.62, 11.64–11.65
    - genotype, A3.6
    - $\lambda$  vector propagation, 2.28
  - Boiling lysis plasmid DNA protocols
    - large-scale, 1.47–1.50
    - overview, 1.43
    - small-scale, 1.44–1.46
    - yield, 1.50
  - Bolton-Hunter reagent, A9.30
  - Bombix mori* nuclear polyhedrosis virus (BmNPV), 17.81
  - bom* region, 1.146
  - Bovine growth hormone (BGH) poly(A) signal, 17.72
  - Bovine Lacto Transfer Technique Optimizer. *See* BLOTTO
  - Bovine milk casein for protein stability, 17.16
  - Bovine serum albumin (BSA)
    - as blocking agent, A8.54
    - in long PCR buffer, 8.78
    - in PCR, 8.23
    - for protein stability, 17.16
    - SDS absorption by, 6.25
  - Bovine submaxillary mucin (type1) for protein stability, 17.16
  - BPTE electrophoresis buffer, 7.28–7.29, A1.17
  - BRAB. *See* Bridged avidin-biotin assay
  - BRET. *See* Bioluminescent resonance energy transfer
  - Bridged avidin-biotin (BRAB) assay, A9.33
  - Brilliant Blue. *See* Coomassie Brilliant Blue
  - BRET database, A10.15
  - 5-Bromo-4-chloro-3-indolyl phosphate. *See* BCIP
  - 5-Bromo-4-chloro-3-indolyl- $\beta$ -D-galactoside. *See* X-gal
  - Bromocresol green in alkaline agarose gel electrophoresis, 5.36
  - 5-Bromodeoxyuridine (BrdU), 9.76, 16.47
  - Bromophenol blue, 5.36
    - in agarose gel electrophoresis gel-loading buffers, 1.53, 5.9
    - in denaturing agarose gels, 7.23
    - in formaldehyde gel-loading buffer, 7.32
    - in formamide buffers, 7.77, 17.6
    - inhibition of PCR by, 8.13
    - migration rate through polyacrylamide gels, 12.89
    - oligonucleotide size and comigration in polyacrylamide, 10.15
    - polyacrylamide gel electrophoresis, 5.42, 7.57
    - recipe, A1.18
    - in RNA gel-loading buffer, 7.68
    - in SDS gel-loading buffer, A8.42
    - sucrose solution, 17.14, A1.19
    - Taq* polymerase inhibition by, 1.53
  - BSA. *See* Bovine serum albumin
  - BSC-1 cell lines, 16.27
  - Bst*AI cleavage at end of DNA fragments, A6.4
  - Bsp*EI cleavage at end of DNA fragments, A6.4
  - Bsp*MII methylation, A4.7
  - Bst*GI cleavage at end of DNA fragments, A6.4
  - Bst*HII
    - cleavage at end of DNA fragments, A6.4
    - fragment size created by, table of, A4.8
    - genomic DNA mapping, 5.60, 5.69
    - site frequency in human genome, 4.16, A6.3
  - Bst* DNA polymerase, 8.10, A4.23
  - Bst*BI, 5.69
  - Bst*EII, A4.9
  - Bst*NI, A4.9
  - Bst*XI in exon amplification protocol, 11.79, 11.82, 11.89, 11.92
  - Bst*36I in end-labeling, selective, 9.52
  - Btag, epitope tagging, 17.93
  - Buffers, A1.2–A1.22. *See also specific buffer types and uses; specific buffers*
    - electrophoresis, 5.7–5.8, A1.17–A1.18
    - enzyme dilution, A1.9
    - enzyme reaction, A1.9–A1.12
    - extraction/lysis buffers, A1.16
    - gel-loading, 5.9, A1.18, A1.20
    - hybridization buffers, A1.12–A1.13
    - pH, A1.7–A1.8
    - phosphate, A1.5
    - properties of good buffers, A1.3–A1.4
    - restriction
      - DNA migration in agarose, effect on, 5.10
      - sequential use of, 1.86
    - Tris, A1.2–A1.3
  - Buffy coat, removal by aspiration, 6.9
  - Butanol, 12.70–12.71
    - concentrating nucleic acids by extraction with, A8.18
    - for removal of ethidium bromide from DNA, 1.73, 1.151, A8.27
  - <sup>14</sup>C
    - particle spectra, A9.10
    - sensitivity of autoradiographic methods for detection, A9.13
  - C600 *E. coli* strain, 11.59–11.60, 11.62, 11.65, 15.32
    - genotype, A3.6
    - $\lambda$  vector propagation, 2.28
  - Caenorhabditis elegans*
    - genomic resources for microarrays, A10.6
    - protein interaction mapping, 18.124
  - Caging, 17.13
  - Cairns, 1.6, 2.11, 3.2
  - Calcium (Ca<sup>2+</sup> ions and exonuclease III, 13.73
  - Calcium chloride (CaCl<sub>2</sub>), A1.25
    - in  $\lambda$  stock preparation, 2.35, 2.37, 2.39
    - preparation and transformation of competent *E. coli* using, 1.116–1.118
    - in transfection of eukaryotic cells, 16.16, 16.19–16.20, 16.23
  - Calcium-phosphate-mediated transfection, 16.3, 16.14–16.26, 16.52–16.53
    - of adherent cells, 16.25
    - of cells growing in suspension, 16.26
    - chloroquine treatment, 16.14, 16.17, 16.52
    - cotransformation, 16.24
    - efficiency, factors affecting, 16.52
    - with genomic DNA, 16.21–16.24
    - glycerol shock, 16.14, 16.17, 16.52
    - high efficiency, 16.19
    - mutation prevalence, 16.53
    - with plasmid DNA, 16.14–16.20
    - sodium butyrate, 16.14, 16.17–16.18
  - Calcium phosphate transfection
    - Escort, 16.5
    - Kit, 16.5
    - System, 16.5
  - Calcium tungstate intensifying screens, A9.11
  - Calf intestinal alkaline phosphatase (CIP), 1.95–1.96, 2.69, 9.62–9.64, 9.92–9.93, A4.37. *See also* Alkaline phosphatase
    - in cosmid library construction protocol, 4.17–4.21
    - dephosphorylation of M13 vector DNA, 12.24
    - inactivation of, 1.96, 9.64, 9.93
    - properties of, 9.93
    - RNA dephosphorylation, 9.65
  - Calli dam* methylation and, 13.87
  - Calpain inhibitor I and II, A5.1
  - CalPhos Mammalian Kit, 16.5
  - cAMP, 5–5', 2.7
  - cAMP-dependent protein kinase, 18.49, 18.51
  - cAMP response element-binding protein (CREB), 18.11
  - Candida albicans*, genomic resources for microarrays, A10.6
  - CAP, 15.57, 17.80, 18.127
  - Capillary transfer of DNA from agarose gels to solid supports
    - depurination/hydrolysis, 6.34–6.35
    - downward transfer, 6.35–6.36, 7.26, 7.40–7.41
    - northern hybridization, 7.25–7.26, 7.36, 7.38–7.41
    - protocols for, 6.39–6.49
    - transfer to two membranes, 6.35–6.36, 6.47–6.49
    - upward transfer, 6.34–6.35, 7.25–7.26, 7.36, 7.38–7.39
  - Capped RNAs, 9.88
  - Carbenicillin, 1.148
    - modes of action, A2.7
    - stock/working solutions, A2.6
  - Carbodiimide, 13.95
  - Carbonic anhydrase II and affinity purification of fusion proteins, 15.6
  - CARD. *See* Catalyzed reporter deposition protocol
  - Carrier RNA, 5.20, 7.69
  - Cassette mutagenesis, 13.79
  - CAT. *See* Chloramphenicol acetyltransferase
  - cat* gene, 1.144
  - CAT reaction mixtures, 17.36, 17.40–17.41
  - Catalyzed reporter deposition protocol, A9.19
  - CATH database, A11.22
  - Cathepsin B, 16.52–16.53
  - ccdB* gene in positive selection vectors, 1.12
  - CCD cameras, 5.15–5.16, 18.76, 18.91–18.92, 18.94
  - CCM. *See* Chemical cleavage of mismatched bases
  - CDI modification, 13.95
  - cDNA. *See also* cDNA cloning; cDNA libraries; cDNA synthesis
    - adaptor use, 1.160
    - blunt-end ligation of, 11.51–11.52
    - clone analysis by PCR, 2.105
    - differentially expressed, isolating, 9.89–9.91
    - differential screening, 9.89–9.90
    - plus/minus screening, 9.89–9.90
    - random sampling, 9.89
    - subtractive screening, 9.90–9.91
  - E. coli* DNA ligase use, 1.159
  - end modification of cloned, 8.42
  - expression library construction, 14.48–14.49
  - full-length clones, low-yield of, 8.60
  - length, measurement by alkaline agarose gel electrophoresis, 5.36
  - linker use with, 1.99–1.100
  - methylation of, 11.48–11.50
  - microarray analysis, A10.3–A10.6, A10.9–A10.10, A10.14
- PCR techniques
  - amplification of 3' ends, 8.61–8.65
  - amplification of 5' ends, 8.54–8.60
  - characterization of cloned segments in prokaryotic vectors, 8.72–8.76
  - differential display-PCR, 8.96–8.106

- cDNA (continued)  
 end modification, 8.42  
 long PCR, 8.77  
 mixed oligonucleotide-primed amplification, 8.66–8.71  
 RT-PCR, 8.46–8.53  
 in primer extension assays, 7.75–7.76  
 probe construction  
 subtracted  
 by random extension, 9.46–9.50  
 using oligo(dT) primers, 9.41–9.45  
 using oligo(dT) primers, 9.41–9.45  
 using random primers, 9.38–9.40  
 tailing reaction, 8.58–8.59
- cDNA cloning. *See also* cDNA libraries, construction  
 fidelity of, 11.5  
 history of methods to synthesize and clone, 11.3–11.5  
 linkers and adaptors, 11.20–11.21  
 methylation, 11.21  
 mRNA preparation for  
 enrichment methods, 11.8–11.11  
 fractionation of cDNA, 11.9–11.10  
 fractionation of mRNA, 11.9  
 number of clones needed for library, 11.8  
 overview, 11.8–11.9  
 polysome purification, 11.10  
 subtractive cloning, 11.10–11.11  
 integrity of mRNA, 11.7–11.8, 11.39, 11.42  
 source of mRNA, 11.6–11.7  
 PCR error rate, 11.5  
 screening. *See* cDNA libraries, screening  
 strategies for, 11.5, 11.6  
 vectors, 11.21–11.26  
 $\lambda$ gt10/ $\lambda$ gt11, 11.25, 11.27  
 $\lambda$ ZAP, 11.22  
 $\lambda$ ZAP Express, 11.22–11.25  
 $\lambda$ ZAPII, 11.22–11.23  
 $\lambda$ ZipLox, 11.25–11.26  
 plasmids, 11.25
- cDNA libraries, 11.1–11.124. *See also* Expression libraries, screening  
 amplification, 11.64–11.66  
 in  $\lambda$ gt10, 11.64–11.65  
 in  $\lambda$ gt11,  $\lambda$ ZAP,  $\lambda$ ZipLox, 11.65–11.66  
 arrayed libraries, 4.8  
 construction  
 cDNA synthesis, 11.11–11.20  
 first-strand, 11.11–11.14, 11.38–11.42  
 second-strand, 11.14–11.20, 11.43–11.47  
 enrichment methods, 11.8–11.11  
 eukaryotic expression, 11.68–11.73  
 controls, 11.70  
 factors influencing success, 11.69–11.70  
 host/vector systems, 11.69  
 options, 11.68  
 vector systems for, 11.72  
 fractionation of cDNA, 11.56–11.58  
 kits for, 11.107–11.108  
 ligation of cDNA into plasmid vector, 11.63  
 ligation of cDNA to  $\lambda$  arms, 11.59–11.61  
 linkers and adaptors, 11.20–11.21, 11.51–11.55  
 methylation of cDNA, 11.48–11.50  
 polishing cDNA termini, 11.43, 11.45, 11.54  
 from small numbers of cells, 11.112  
 subtractive cloning, 11.10–11.11  
 troubleshooting, 11.64  
 vectors for, 11.21–11.26
- custom-made, 11.107  
 differential screening, 9.89–9.90  
 direct selection, 11.98–11.106  
 amplification, 11.104–11.105  
 biotin labeling, 11.102  
 blocking repetitive sequences, 11.103, 11.105–11.106  
 linked pool preparations, 11.102  
 materials for, 11.100–11.101  
 overview, 11.98–11.100  
 primary selection, 11.105  
 secondary selection, 11.105  
 streptavidin bead preparation, 11.103  
 troubleshooting, 11.106
- eukaryotic expression, 11.68–11.78  
 exon trapping/amplification, 11.79–11.97  
 flow chart for construction and screening, 11.2  
 in  $\lambda$  vectors, 2.23  
 number of clones needed, calculating, 11.8  
 oligonucleotide probes for  
 degenerate pools, 10.5–10.6  
 length of, 10.4  
 screening, 11.26–11.34  
 by binding to specific ligands, 11.32–11.33  
 double-stranded DNA probes, 11.33  
 immunoglobulin probes, 11.32–11.33  
 direct selection of cDNAs, 11.35, 11.98–11.106  
 eukaryotic expression, 11.74–11.78  
 controls, 11.74–11.75  
 protocols, 11.76–11.78  
 screening pools, 11.74  
 exon trapping, 11.35  
 by expression, 11.33–11.34  
 by hybridization, 11.27–11.32  
 homologous probes, 11.27  
 similar sequence probes, 11.28–11.29  
 subtracted cDNA probes, 11.29–11.31  
 synthetic oligonucleotide probes, 11.31–11.32  
 total cDNA probes, 11.29  
 zoo blots, 11.28  
 by PCR, 11.32  
 for protein-protein interactions, 18.30–18.48  
 by subtracted cDNA probes, 9.46, 9.90–9.91  
 validation of clones selected, 11.34
- validation of clones, 11.34
- cDNA synthesis  
 in exon trapping/amplification protocol, 11.91–11.92  
 first-strand, 11.11–11.14, 11.38–11.42  
 methods, table of, 11.15  
 optimizing, 11.38, 11.42  
 primers for, 11.12–11.15, 11.39  
 oligo(dT), 11.12–11.13, 11.15, 11.39  
 random primers, 11.12–11.15, 11.39  
 protocol, 11.38–11.41  
 reverse transcriptase choice, 11.11–11.12, 11.38  
 troubleshooting, 11.42  
 yield, calculating, 11.41–11.42
- kits for, 11.71, 11.107–11.108  
 Klenow fragment use, A4.15  
 reverse transcriptase, A4.25–A4.26  
 second-strand, 11.14–11.20, 11.43–11.47  
 oligonucleotide-primed, 11.17–11.20  
 optimizing, 11.46  
 protocol, 11.43–11.47  
 replacement synthesis, 11.16–11.17  
 self-primed, 11.14, 11.46  
 troubleshooting, 11.46  
 yield, calculating, 11.45
- CDP-*Star*, 9.79, A9.44  
 CE6, bacteriophage, 15.20  
 Cell fixative, 16.13  
 Cell homogenization buffer, 17.4  
 Cell lysis buffer, 15.35, 15.41, 15.50  
 for reporter assays, 17.44–17.45  
 Cell numbers, estimation of  
 hemocytometer counting, A8.6–A8.7  
 viability staining, A8.7–A8.8  
 Cell resuspension buffer, 17.6  
 Cell walls  
 digestion of yeast, 4.60, 5.66–5.67  
 inhibition of restriction enzymes by components of, 1.33, 1.36, 1.42, 3.24  
 Cell wash buffer, 5.65  
 CellFECTIN, 16.5, 16.11  
 CellPect Transfection Kit, 16.5  
 Cellulose. *See also* DEAE-cellulose  
 affinity purification of fusion proteins, 15.6  
 oligo(dT), 7.14  
 CEN4 (centromeric sequence), 4.60  
 Centricon concentrator, 8.27–8.29, 8.58, 8.68, 12.106, 18.81–18.82
- Centrifugation  
 nomogram for conversion of rotor speed to relative centrifugal force, A8.39  
 rotors, table of commonly used, A8.39
- CEPH Mega YAC Library, 4.9  
*cer* region, 1.146  
 Cerenkov counting, 9.69, 9.71, 9.75, 10.27, 11.58, 12.66, A8.25  
 CES200 *E. coli* strain genotype, A3.6  
 CES201 *E. coli* strain genotype, A3.6  
 Cesium chloride (CsCl)  
 removal from bacteriophage suspensions, 2.57–2.58  
 removal from DNA, 1.73–1.75  
 Cesium chloride (CsCl) density gradients  
 bacteriophage purification, 1.155  
 DNA form and density, 1.18  
 double-stranded DNAs, 1.154  
 ethidium bromide, 1.151  
 $\lambda$  particle purification, 2.47–2.51  
 collection of particles, 2.50  
 equilibrium gradient, 2.49, 2.51  
 step gradient, 2.48–2.49  
 properties of CsCl solutions, 1.155–1.156  
 purification of closed circular DNA  
 contamination by DNA/RNA fragments, 1.65  
 continuous gradients, 1.67–1.68  
 discontinuous gradients, 1.69–1.71  
 DNA collection from, 1.67–1.68, 1.71  
 rebanding, 1.68  
 RNA, 1.155, 7.4  
 single-stranded DNAs, 1.155
- Cetyltrimethylammonium bromide (CTAB), 6.61–6.62  
 DNA precipitation by, 6.62  
 in hybridization solutions, 6.61–6.62  
 polysaccharide removal, 2.105  
 for solubilization of inclusion bodies, 15.54  
 structure of, 6.62
- Cetylpyridinium bromide (CPB), 10.22–10.24  
 CFP PowerScan mutation detection system, 13.89  
*Cfr*6I methylase, A4.7  
*Cfr*9I, A4.7  
 Chameleon Double-stranded Site-directed Mutagenesis Kit, 13.27, 13.89  
 Chaotropic agents, 15.60. *See also specific agents*  
 DNA binding to silica, 1.63  
 for solubilization of proteins from pellets, 15.11  
 Chaperones, 1.4  
 Charged couple device (CCD)-based image detection systems, 5.15–5.16, 18.76, 18.91–18.92, 18.94  
 Charon vectors, 2.12, 2.22, A3.3  
 CHEE. *See* Contour-clamped homogeneous electric field  
 Chemical cleavage of mismatched bases (CCM), 13.91, 13.95  
 Chemical mutagenesis, 13.78–13.79  
 Chemiluminescence, A8.55, A9.16–A9.20  
 alkaline phosphatase and, A9.40  
 AMPPD and, A9.42–A9.44  
 applications, table of, A9.18  
 assays for immunoassay and nucleic acid hybridization labels, table of, A9.17

- digoxigenin-labeled probes, A9.39–A9.40
- enzyme assays, A9.19–A9.20
- alkaline phosphatase, A9.19
  - $\beta$ -galactosidase, A9.19
  - glucose oxidase, A9.20
  - horseradish peroxidase, A9.19
  - xanthine oxidase, A9.19
- horseradish peroxidase and, A9.35–A9.37
- labels, A9.17–A9.19
- luminometers, A9.20
- markers, 1.140, 2.98–2.99
- overview, A9.16–A9.17
- reactions, A9.16
- screening of expression libraries
- in  $\lambda$  vectors, 14.11–14.12
  - in plasmid vectors, 14.21–14.22
- Chi (Z) site
- E. coli*, 2.13
  - $\lambda$ , 2.13, 2.22
- ChIP (Chromatin immunoprecipitation), A10.18
- Chloramine T (N-chlorobenzenesulfonamide), 14.5, 14.16, A9.30
- Chloramphenicol. *See also* Chloramphenicol acetyltransferase
- dam* strains and, 13.88
  - mechanism of resistance to, 1.144
  - modes of action, A2.7
  - plasmid copy number amplification, 1.4, 1.39, 1.48, 1.56, 1.128, 1.131, 1.143
  - properties and mode of action, 1.143–1.144
  - for protein expression optimization, 15.19
  - relaxed plasmid replication, 1.4
  - resistance, 17.94
  - stock/working solutions, A2.6
  - structure of, 1.143
- Chloramphenicol acetyltransferase (CAT), 17.94–17.95
- affinity purification of fusion proteins, 15.6
  - expression in mammalian cells, 17.95
  - reaction catalyzed by, 17.94
  - as reporter gene, 17.30–17.41, 17.95
  - aberrant transcription, 17.34
  - controls, 17.34
  - measurement
    - by diffusion of reaction products into scintillation fluid, 17.41
    - by extraction with organic solvents, 17.40
    - by thin-layer chromatography, 17.36–17.39
  - normalizing CAT activity to  $\beta$ -galactosidase activity, 17.48–17.49, 17.51
  - overview, 17.33–17.34
  - pCAT3 vectors, 17.35
  - quantitative assays, 17.95
  - as transfection-positive control, 16.4
- Chloramphenicol resistance gene (Cm<sup>r</sup>)
- in activation domain fusion plasmids, 18.20
  - in LexA fusion plasmids, 18.19
  - in two-hybrid system of reporter plasmids, 18.12
- Chloroform, 1.34. *See also* Phenol:chloroform extraction
- extraction
- in hydroxyl radical footprinting protocol, 17.12
  - mineral oil removal from PCRs, 8.22
  - in oligonucleotide purification, 10.27
  - in transcriptional run-on assay protocol, 17.28
  - for  $\lambda$  cDNA storage, 11.64
  - for  $\lambda$  plaques storage, 2.32–2.33, 2.36
  - overlay assay of  $\beta$ -galactosidase activity, 18.28
- 4-Chloro-1-naphthol, 14.10, 14.20–14.21
- Chlorophenol red  $\beta$ -D-galactopyranoside, 17.50
- Chloroquine, 16.14–16.15, 16.17, 16.52–16.53, 17.60, 17.62
- DEAE transfection, facilitation of, 16.28, 16.31
- Chlortetracycline, 1.147, 17.52
- Chromatin immunoprecipitation (ChIP), A10.18
- Chromatography. *See also* Affinity chromatography; *specific resins*
- anion-exchange chromatography, DNA purification protocol, 5.26–5.28
  - cDNA size fractionation through Sepharose CL-4B, 11.55–11.58
  - ethidium bromide removal from DNA, 1.75–1.77, 1.151
  - FPLC, 13.20
  - gel-filtration, A8.29–A8.31
    - column chromatography, A8.29–A8.30
    - spun-column, A8.30–A8.31
  - HPLC, 10.49, A8.35
  - hydroxyapatite, 7.65, 9.90–9.91, 11.1, A8.32–A8.34
  - in IgG radioiodination protocol, 14.5, 14.16
  - immunoaffinity, 11.10
  - liquid chromatography-tandem MS (LC-MS/MS), 18.66
  - mRNA separation by
    - batch, 7.18–7.19
    - oligo(dT)-cellulose, 7.13–7.17
    - poly(U)-Sepharose, 7.15, 7.20
  - oligonucleotide purification, 10.49
  - Sep-Pak C<sub>18</sub> columns, 10.11, 10.13, 10.15–10.16, 10.28–10.29
  - plasmid DNA purification, 1.19
    - overview of, 1.62–1.64
    - through Sephacryl S-1000, 1.80–1.81
    - resins, table of commercially available, 1.64
  - thin-layer chromatography for CAT measurement, 17.36–17.39
- Chromogenic screening of expression libraries
- in  $\lambda$  vectors, 14.9–14.11
  - in plasmid vectors, 14.20–14.21
- Chromosomal DNA. *See also* Genomic DNA
- denaturation in boiling lysis plasmid DNA protocols, 1.43
  - migration in agarose gel electrophoresis, 5.5
  - pulsed-field gel electrophoresis separation of, 5.3, 5.56, 5.59–5.60
- Chromosome walking
- inverse PCR use, 8.81
  - overview, 4.8–4.10
- Church buffer, 4.26, A1.12
- in northern hybridization, 7.45
  - in Southern hybridization, 6.56
- Chymostatin, A5.1
- Chymotrypsin, 18.64
- cI gene
- $\lambda$ , 2.3, 2.6, 2.8, 2.11, 2.17–2.18, 2.21, 2.23, 11.111.
  - See also*  $\lambda$ , repressor
  - PI, 4.37
  - in pEX vectors, 14.14
  - thermosensitive mutants, 14.37
- CI protein,  $\lambda$ , 2.8, 2.10, 2.14, 2.17–2.18
- cII gene,  $\lambda$ , 2.6, 2.11, 2.17
- CII protein,  $\lambda$ , 2.7–2.8, 2.11
- cIII gene,  $\lambda$ , 2.6, 2.11, 2.17
- CIII protein,  $\lambda$ , 2.7, 2.11
- CIP. *See* Calf intestinal alkaline phosphatase
- Circular mutagenesis, 13.19–13.25
- materials, 13.21–13.22
  - polymerase choice, 13.20–13.21
  - primer design, 13.19–13.20
  - protocol, 13.22–13.25
- CIT Human BAC Library, 4.9
- Citric acid, A1.6
- cIs857* mutation, 2.23
- CJ236 *E. coli* strain, 13.12–13.13, A3.6
- C-la *E. coli* strain genotype, A3.6
- Clal*, methylation, A4.3, A4.7
- ClearCut Miniprep Kit, 1.64
- CLONEAMP pAMP, 11.105
- CLONectin reagent, 16.5, 16.11
- Cloning. *See also* cDNA cloning
- by addition of linkers to blunt-ended target DNA, 1.98
  - in Cosmids
    - diagram of steps, 4.12
    - double *cos* site vectors, 4.11–4.14
    - ligation reactions, 4.15, 4.21–4.22
    - partial filling of 3' termini, 4.15
    - single *cos* site vectors, 4.11, 4.13
  - expression cloning
    - cDNA library construction, 11.68–11.73
    - controls for, 11.70
    - factors influencing success, 11.69–11.70
    - mammalian host/vector systems, 11.69
    - screening cDNA library, 11.74–11.78
    - vector systems for, 11.72
  - in M13 vectors
    - locations
      - gene X, 3.9–3.10
      - large intergenic region, 3.9
      - multiple cloning sites, table of, 3.14
      - small intergenic region, 3.9
    - materials, 3.35–3.36
    - methods
      - dephosphorylation of vector DNA, 3.34
      - forced (directional cloning), 3.34
      - ligation of insert into linearized vector, 3.34
      - protocol, 3.36–3.38
      - transformation reactions, 3.37–3.38
  - PCR products
    - blunt end, 8.30–8.34
    - difficulty of, 8.30
    - end modification, 8.42–8.45
    - genetic engineering with PCR, 8.42–8.45
    - overview, 8.30–8.31
    - polishing termini, 8.30, 8.32–8.34
    - restriction site addition and, 8.31, 8.37–8.41
      - clamp sequences and, 8.38–8.39
      - diagram of procedure, 8.38
      - primer design tips, 8.37–8.38
      - problems, 8.37
      - protocol, 8.39–8.41
      - troubleshooting, 8.41
    - into T vectors, 8.31, 8.35–8.36
  - in plasmid vectors
    - blunt-ended cloning, 1.22–1.24, 1.90–1.92
    - directional cloning, 1.21–1.22, 1.84–1.87
    - fragments with protruding ends, 1.20–1.21
    - overview, 1.19–1.20
- Closed circular DNA purification in CsCl gradients, 1.18
- continuous, 1.65–1.68
  - discontinuous, 1.69–1.71
- Clostripain, 15.8
- clp*, 15.58
- CLUSTALW program, A11.6
- Cluster analysis program, A10.15
- CM selective medium, 18.18, 18.31, 18.40
- CMV promoter. *See* Cytomegalovirus promoter
- c-Myc protein, human, epitope tagging of, 17.92
- Code20 kit, 13.89
- Codon usage
- changing codons by PCR, 8.44
  - database, A11.20
  - degenerate primer pools and, 8.67
  - evolution and, A7.2
  - genetic code table, A7.4
  - guesser design and, 10.7
  - in humans, table of, A7.3
  - optimization of expression and, 15.12
- Coenzyme R. *See* Biotin
- Cohesive termini. *See* Protruding termini
- Coimmunoprecipitation, 18.4, 18.60–18.68
- cell lysis, 18.62, 18.65
  - controls, 18.63–18.66



- Coimmunoprecipitation (*continued*)  
   identification of proteins, 18.66  
   immunoprecipitation of cell lysate, 18.62–18.63  
   materials for, 18.67–18.68  
   method, 18.68  
   nonspecific interactions, reducing, 18.65–18.66  
   procedure, outline of, 18.61–18.62
- Coincidence circuit, scintillation counter, 17.46, A9.22
- colE1 replicon, 1.3–1.4  
   chloramphenicol amplification, 1.143  
   in cosmids, 4.5  
   DNA synthesis at, 1.5–1.7  
   *E. coli* strain and copy number, 1.15  
   *penB* gene and copy number suppression, 1.13  
   in pET vectors, 15.3  
   plasmid growth and replication, table of, 1.17
- Colicin B protein, epitope tagging of, 17.92
- Colicin E1 replicon. *See* colE1 replicon
- Colicin E3 in positive selection vectors, 1.12
- Collagenase, 15.8, 18.116
- Collodion bags, 6.14–6.15
- Column-loading buffer for oligo(dT)-cellulose chromatography, 7.14–7.16
- Compactin, 11.6
- Competent cell preparation  
   chemical methods, 1.24–1.25  
   electrocompetent, 1.25–1.26, 1.119–1.121  
   frozen stocks, 1.109, 1.114–1.115  
   Hanahan method, 1.105–1.110  
   Inoue method, 1.112–1.115  
   using calcium chloride, 1.116–1.118
- Competition assays, 17.17
- Competitive oligonucleotide priming (COP), 13.91, 13.96
- Complementation. *See*  $\alpha$ -complementation
- Complete minimal (CM) recipe, A2.9
- Compressions in DNA sequencing gels, 12.109–12.110
- Concentrating nucleic acids, A8.12–A8.18  
   butanol, extraction with, A8.18  
   by dialysis on bed of sucrose, 6.15  
   ethanol precipitation, A8.12–A8.16  
     aspiration of supernatants, A8.15  
     carriers, A8.13  
     dissolving precipitates, A8.13, A8.15–A8.16  
     history of, A8.14  
     protocol for, A8.14–A8.15  
     of RNA, A8.16  
     salt solutions used with, A8.12  
   high-molecular-weight DNA samples, 6.15  
   lithium chloride precipitation of large RNAs, A8.16  
   microconcentrators, A8.16–A8.17
- Condensing reagents, 1.24, 1.152
- Conditional mutations, A7.5
- Conditionally lethal genes, 1.12
- Conjugated antibodies, A9.33–A9.34
- Conjugation, *traD36* mutation, 3.10
- Consensus program, A11.14
- Constant denaturing gel electrophoresis (CDGE), 13.92
- Contact printing arrayer, A10.7
- Contour-clamped homogeneous electric field (C-HEF), 5.57, 5.79–5.82  
   conditions for, 5.79–5.80  
   electrode configuration, 5.57  
   high-capacity vector insert size determination, 4.18  
   method, 5.81–5.82  
   pulse times, 5.79–5.80  
   resolution, 5.79
- Coomassie Brilliant Blue staining solution, A1.26, A8.46–A8.47
- Copy number  
   BAC, 4.48  
   cosmids, 4.26  
   P1 and PAC vectors, 4.41
- plasmid, 1.39, 1.48, 1.56, 1.128, 1.131  
   amplification, 1.4, 1.143  
   chloramphenicol and, 1.4, 1.143  
   control by RNAI, 1.6–1.7  
   *E. coli* strains, related suppression of, 1.15  
   incompatibility of plasmids and, 1.7–1.8  
   low-copy-number vectors, 1.12–1.13  
   needs for low, 1.3  
   plasmid size and, 1.9  
   replicons and, 1.3–1.4  
   suppression by *penB*, 1.13
- Cordycepin, 9.55, 9.60–9.61, 12.73
- CorePromoter program, A11.12
- COS cells, 11.68, 11.75  
   COS-1, 11.114  
   COS-7 cells, 11.114  
     electroporation into, 11.85–11.86  
     mRNA harvesting from, 11.87–11.88  
   overview, 11.114  
   transfection, 16.27, 16.29, 16.32
- cos* sites  
   in BAC vectors, 4.3  
   cosmids, 4.11, 4.30, 4.33  
    $\lambda$ , 2.2–2.3, 2.12, 2.14–2.15, 2.68  
   in vitro packaging and, 2.111, 11.113
- Cosmids, 4.11–4.34, A3.5  
   chimeric clones, reducing, 4.15–4.16  
   choosing for genomic library construction, 4.7–4.10  
   cloning in  
     diagram of steps, 4.12  
     double *cos* site vectors, 4.11–4.14  
     ligation reactions, 4.15, 4.21–4.22  
     partial filling of 3' termini, 4.15  
     single *cos* site vectors, 4.11, 4.13  
   copy number, 4.26  
   DNA purification, 4.22–4.23  
   genomic libraries  
     amplification  
       on filters, 4.31–4.32  
       in liquid culture, 4.28–4.30  
       on plates, 4.34  
     by rescuing DNA in transducing particles, 4.30  
   arm isolation, 4.19–4.20  
   arrayed libraries, 4.31  
   dephosphorylation of genomic DNA, 4.20–4.21  
   digestion of genomic DNA, 4.20  
   isolation and analysis, 4.22  
   ligation, 4.21–4.22  
   linearization/dephosphorylation, vector, 4.18–4.19  
   protocol for construction, 4.17–4.23  
   restriction map construction, 4.33  
   screening unamplified by hybridization, 4.24–4.27  
   storage, 4.11, 4.30, 4.32  
   overview, 4.4–4.5  
   packaging, 4.21–4.22, 4.30  
   restriction mapping recombinants, 4.33  
   size, 4.11  
   stability of cloned sequences, 4.10, 4.28  
   subcloning YAC DNAs into, 4.64  
   transforming *E. coli*, 4.25  
   in vitro transcription from bacteriophage promoters, 9.31
- Cotransformation, 16.24, 16.47
- Cotton bollworm virus, 17.81
- Coulter Multimek (Beckman), A10.5
- CPD-Star, A9.44
- CpG sequences, 5.60, 5.68–5.69
- Cre, 4.4, 4.82–4.85. *See also* Cre-*loxP* recombination system
- CREB. *See* cAMP response-element-binding protein
- Cre-*loxP* recombination system, 4.82–4.85  
   mechanism of action, 4.82–4.83  
   site-specific integration and excision of transgenes, 4.84–4.85  
   use in mammalian cells, 4.84–4.85  
   vectors containing Cre-*loxP* sites, 4.83–4.84  
      $\lambda$ ZipLox vector, 11.25–11.26  
     P1 vectors, 4.4
- Cresol red, 1.53, A1.19
- cro* genes,  $\lambda$ , 2.6, 2.8–2.9, 14.14
- Cro protein, 2.6, 2.8, 2.10, 2.14, 2.18
- Cross-linking devices, 6.41, 6.46
- Crowding agents, 1.23–1.24, 1.152, 1.157–1.158, 3.49, 6.58
- crp* gene, 15.3
- CsCL. *See* Cesium chloride
- CSH18 *E. coli* strain  
   genotype, A3.6  
    $\lambda$  vector propagation, 2.29
- CSPD, A9.43–A9.44
- CspI* methylation, A4.7
- CTAB. *See* Cetyltrimethylammonium bromide
- CTAC for solubilization of inclusion bodies, 15.54
- Cul2, 18.60, 18.62, 18.64
- Cup horn sonicator, 12.16, A8.36
- CV-1 cell lines, 16.27
- Cvi*III methylase, A4.7
- Cvi*J1 restriction enzyme, 9.15, 12.11
- Cvi*QI, A4.9
- Cy3 dye, 18.69, 18.71–18.72, 18.78, 18.80, 18.82–18.83, 18.91, 18.93–18.95
- Cy5 dye, 18.80, 18.91
- cya*, *E. coli* gene, 2.7
- Cyalume Lightsticks, A9.17
- Cyanogen bromide, 15.6, 15.8, A9.26–A9.27
- Cycle DNA sequencing  
   advantages of, 12.51–12.52  
   with end-labeled primers, 12.51–12.55  
   with internal labeling, 12.60  
   reaction mixtures for, 12.53, 12.60  
   troubleshooting, 12.55
- Cycle-sequencing buffer, 12.53
- Cyclic coiled DNA  
   alkaline lysis plasmid DNA procedure, 1.40, 1.45, 1.49  
   boiling lysis plasmid DNA protocols, 1.45, 1.49
- Cyclophilin, normalizing RNA samples against, 7.22
- Cysteine  
   for affinity purification of fusion proteins, 15.6  
   codon usage, A7.3  
   nomenclature, A7.7  
   properties, table of, A7.8  
   in pulse-chase experiments, 15.18–15.19
- Cysteine-scanning mutagenesis, 13.3
- Cytochrome *c* for protein stability, 17.16
- CytoFectene Reagent, 16.5
- Cytomegalovirus (CMV) promoter, 11.68  
   for eukaryotic expression vectors, 11.72  
   in pTer-tTak, 17.57–17.58
- Cytosine, A6.7  
   bisulfite modification of, 13.78  
   codon usage and, A7.2  
   hydrazine cleavage of, 13.78  
   hydroxylamine modification of, 13.78, 13.95  
   methylation of, A4.3–A4.4  
   nitrous oxide modification of, 13.78  
   related compounds (Table A6-6), A6.7  
   structure, A6.7
- DabcyI, 8.95
- dam* methylase, 1.25, 13.87–13.88, A4.3, A4.7
- Database of transcribed sequences (DOTS), A10.15
- Database Similarity Search Software (Table A11-2), A11.18–A11.19
- Databases. *See also individual listings*  
   searching, 1.14  
   table of bioinformatics, A11.22–A11.24

- dbfS1 databank, A10.3
- DC Cholesterol, 16.8, 16.11
- dcn* methylase, 1.25, 12.113, A4.3–A4.4
- DDAB, 16.11
- DDBI database, A11.20
- DdeI*
- 7-deaza-dGTP modified DNA, cleavage of, 8.60
  - in end-labeling, selective, 9.52
- ddNTPs. See Dideoxynucleoside triphosphates
- DD-PCR. See Differential display-PCR
- DD-PCR reverse transcriptase buffer, 8.101
- DH3 *E. coli* strain
- genotype, A3.6
- DH52, 2.102–2.104, 2.107–2.108. See also DEAE-cellulose
- DH-81 filters, A8.26
- DEAE, 1.19
- high-salt elution buffer, 5.19
  - low-salt elution buffer, 5.20
- DEAE-cellulose
- for DNA purification, 5.26–5.28
  - DNA recovery from agarose gels, 5.18–5.22
  - in  $\lambda$  DNA purification from plate lysates, 2.102
- DEAE Dextran Kit, 16.5
- DEAE-dextran-mediated transfection, 16.3, 16.27–16.32
- calcium phosphate method compared, 16.27
  - cell viability, increasing, 16.32
  - facilitators of, 16.28
  - kits, 16.30
  - materials for, 16.29–16.30
  - mechanism of action, 16.27
  - method, 16.30–16.31
  - mutation prevalence, 16.28, 16.53
  - variables, 16.27–16.28
- DEAE-Sepharcl, 5.26–5.28, A8.31
- deArray image analysis program, A10.13
- 7-Deaza-dGTP, 8.60, 12.52, 12.55, 12.58, 12.96
- in automated DNA sequencing protocols, 12.95
  - in DNA sequencing protocols, 12.109–12.110
  - overview of, 12.111
  - Sequenase, use of, 12.105
  - structure of, 12.111
- DepVont DNA polymerase, 8.11, 8.85, A4.23
- Degenerate oligonucleotides, pools of, 10.5–10.6, 11.31
- degP* mutation, 15.19
- Deletion mutants
- BAL 31 generation of bidirectional sets, 13.62–13.67
  - exonuclease III generation of nested sets, 13.57–13.61, 13.74–13.75
- Denaturation
- DNA
    - for DNA sequencing protocols, 12.26–12.30
    - by formamide, 6.59–6.60
    - in PCRs, 8.8
    - probes, 7.13
  - RNA, 7.21–7.22
    - for dot and slot blotting, 7.46, 7.48–7.49
    - formaldehyde, 7.31–7.33
    - glyoxal, 7.27–7.29
    - by heat, 8.51
- Denaturation solution, 10.38
- in guanidinium lysis, 7.5
  - for neutral transfer, double-stranded DNA targets only, A1.12
  - in Southern hybridization, 6.41, 6.43, 6.47
- Denaturing buffer
- CHEE gel, 5.80
  - FAE gel, 5.75
- Denaturing gradient gel electrophoresis (DGGE), 13.91–13.92
- mutation detection, 13.49
  - SYBR Gold stain as alternative to, 5.15
- Denhardt's solution
- BIO110 and, 1.139
  - in hybridization solutions, 6.51–6.52, 10.35, 10.38
  - recipe, A1.15
  - in stripping solutions, 6.57
- Densitometric scanning, 7.47
- deoI* gene, 3.16
- Deoxycholate, 15.10, 15.50
- 2'-deoxycoformycin (dCF), 16.47
- Dideoxynucleoside triphosphates (dNTPs), A1.26
- in PCRs, 8.5
  - radiolabeled, 9.5. See also Radiolabeled probes
  - removal by ultrafiltration, 8.27–8.29
  - stock solution preparation, 12.107, A1.26
  - storage of, 8.5
- Deoxyribonuclease I (DNase I), A4.40–A4.42
- cleavage preferences, A4.41–A4.42
  - ethidium bromide and, A4.41
  - limiting activity of, A4.41
  - RNase free, preparation of, A4.42
  - uses, list of, A4.41
- DEPC. See Diethylpyrocarbonate
- Dephosphorylation, 9.92
- in cosmid vector cloning, 4.15, 4.19, 4.20–4.21
  - of DNA fragments with alkaline phosphatase, 9.62–9.65
  - efficiency, analysis of reaction, 4.19
  - efficiency, monitoring, 2.70
  - of  $\lambda$  vector DNA, 2.68–2.70
  - of M13 vector DNA, 3.34, 3.36, 12.24
  - of plasmid DNA, 1.93–1.97
    - conditions for, 1.95
    - diagram of, 1.94
    - method, 1.95–1.97
    - when to use, 1.93–1.94
  - of RNA, 9.65
- Dephosphorylation buffer, 2.69
- for use with CIP, A1.10
  - for use with SAP, A1.10
- Depurination of DNA
- during DNA transfer from agarose gel to filter, 6.34
  - by piperidine, 12.61
  - in Southern hybridization, 6.41, 6.43, 6.47
- Detection systems, A9.1–A9.49. See also specific chemicals; specific methods
- AMPPD, A9.42–A9.44
- antibodies, A9.25–A9.34
  - antipeptide, A9.30–A9.33
  - applications, A9.25
  - conjugated, A9.33–A9.34
    - biotinylated, A9.33
    - enzyme, A9.34
    - fluorochrome, A9.33
  - immunological assays, A9.27–A9.30
    - immunoprecipitation, A9.29
    - solid-phase RIA, A9.29–A9.30
    - western blotting, A9.28
  - purification of, A9.25–A9.27
  - radiolabeling, A9.30
- autoradiography, A9.9–A9.15
- fluorography, A9.12
  - imaging, A9.9–A9.10
  - intensifying screen, A9.11
  - isotopes used
    - decay data, A9.15
    - particle spectra, A9.9–A9.10
    - sensitivity of detection, A9.13
  - phosphorimaging, A9.11–A9.14
  - phosphorimaging devices, A9.14
  - prelashing, A9.11–A9.12
  - setting up autoradiographs, A9.13–A9.14
- BCIP, A9.41–A9.42
- bioluminescence, A9.21–A9.24
- bacterial luciferase, A9.23–A9.24
  - firefly luciferase, A9.21–A9.23
    - assays for, A9.22–A9.23
    - properties of, A9.21–A9.22
    - as reporter molecule, A9.23
  - GFP, A9.24
- biotin, A9.45. See also Biotin
- chemiluminescence, A8.55, A9.16–A9.20
- alkaline phosphatase, A8.55
  - AMPPD and, A9.42–A9.44
  - applications, table of, A9.18
  - assays for immunoassay and nucleic acid hybridization labels, table of, A9.17
  - digoxygenin and, A9.39–A9.40
  - enzyme assays, A9.19–A9.20
    - alkaline phosphatase, A9.19
    - $\beta$ -galactosidase, A9.19
    - glucose oxidase, A9.20
    - horseradish peroxidase, A9.19
    - xanthine oxidase, A9.19
  - horseradish peroxidase, A8.55
  - horseradish peroxidase/luminol, A9.35–A9.37
  - labels, A9.17–A9.19
  - luminometers, A9.20
  - overview, A9.16–A9.17
  - reactions, A9.16
- chromogenic, A8.55
- alkaline phosphatase, A8.55
  - horseradish peroxidase, A8.55
- digoxygenin, A9.39–A9.40
- horseradish peroxidase, A9.35–A9.37
- immunoglobulin binding proteins
- protein A, A9.46–A9.48
  - protein G, A9.46–A9.48
  - protein L, A9.46, A9.47, A9.49
- staining nucleic acids, A9.3–A9.8
- ethidium bromide, A9.3–A9.4
  - methylene blue, A9.4–A9.5
  - silver staining, A9.5–A9.7
  - SYBR dyes, A9.7–A9.8
- Dexamethasone, 18.11
- Dextran sulfate
- as crowding agent, 6.58
  - in hybridization solutions, 6.58
  - in northern hybridization, 7.45
  - in Southern hybridization, 6.56
- DGGE. See Denaturing gradient gel electrophoresis
- DH11 *E. coli* strain, 1.14–1.15, 1.25, 1.115
- genotype, A3.6
  - transformation by Hanahan method, 1.106
- DH5 *E. coli* strain, 1.25
- genotype, A3.6
  - transformation by Hanahan method, 1.106
- DH5 $\alpha$  *E. coli* strain, 1.115
- genotype, A3.7
  - for interaction trap library screening, 18.38, 18.43–18.44
  - transformation by Hanahan method, 1.106
- DH5 $\alpha$ F' *E. coli* strain for M13 growth, 12.21, 12.23
- DH5 $\alpha$ MCR *E. coli* strain
- for cosmid stability, 4.28
  - genotype, A3.7
- DH10B *E. coli* strain
- for BAC propagation, 4.49
  - genotype, A3.7
- DH10B(ZIP) *E. coli* strain, 11.25
- DH11S *E. coli* strain
- genotype, A3.7
  - M13 vectors and, 3.13, 3.16
  - phagemids and, 3.42, 3.44, 3.46–3.47
- DH12S(ZIP) *E. coli* strain, 11.25
- DIALIGN program, A11.8
- Dialysis
- buffers, 2.56–2.57, 6.4, 6.15
  - to concentrate DNA, 6.15
  - drop dialysis, 4.44, A8.11
  - electroelution into dialysis bags, 5.23–5.25
  - to purify DNA, 6.15
  - on sucrose bed, 6.15
  - tubing, preparation of, A8.4

- 3,3-Diaminobenzidine (DAB), A9.35  
 Dichlorodimethylsilane, 12.75, 12.112, A8.3  
 3,4-Dichloroisocoumarin, A5.1  
 Dichlororhodamine dyes, 12.96–12.97  
 Dideoxy fingerprinting (ddF), 13.49, 13.91, 13.94  
 Dideoxynucleoside triphosphates (ddNTPs), 12.4–12.5. *See also* DNA sequencing  
 DideoxyATP, 9.55, 9.60–9.61  
 incorporation rate by thermostable DNA polymerases, 12.45  
 stock solutions of, preparing, 12.107  
 terminator dye linkage to, 12.96  
 Diethylpyrocarbonate (DEPC), 7.84  
 glassware/plasticware treatment with, 7.82, 7.84  
 as probe of secondary structure of DNA and RNA, 7.84  
 problems using, 7.84  
 for RNase inactivation, 7.82–7.84  
 storage, 7.84  
 structure of, 7.84  
 treated water, 7.84  
 Differential display-PCR, 8.96–8.106  
 Differential screening, 9.89–9.90  
 Differentially expressed genes, isolating, 9.89–9.91  
 plus/minus screening, 9.89–9.90  
 random sampling, 9.89  
 subtractive screening, 9.90–9.91  
 Difromazan, 9.78  
 Digital Optical Chemistry (DOC) system, A10.17  
*Digitalis purpurea*, 9.77  
 Digoxigenin, 9.5, A9.36  
 labeled RNA probes, 9.35  
 labeling nucleic acids with, A9.38–A9.39  
 overview, A9.38  
 specific antibodies coupled to reporter enzymes, A9.40  
 Dihydrofolate reductase (*dhfr*) gene, 16.47, 16.49  
 Dimethylformamide, 14.9–14.10, 14.20, 18.80, 18.82, A9.42  
 Dimethylsulfate, 12.5, 12.61–12.65, 12.67  
 Dimethylsulfoxide (DMSO), A1.26  
 in column-loading buffers, 7.16  
 DEAE transfection, facilitation of, 16.28  
 in DNA sequencing reactions, 12.38, 12.109  
 for  $\lambda$  cDNA storage, 11.64  
 for  $\lambda$  storage, long-term, 2.36  
 in PCRs, 8.9, 8.23  
 in transfection with polybrene, 16.43–16.45  
 in transformation buffers, 1.105–1.106  
 Dinitrophenol, 9.76  
 Diolcylphosphatidylethanolamine (DOPE), 16.5, 16.7–16.8, 16.50  
 Direct selection of cDNAs, 11.98–11.106  
 amplification, 11.104–11.105  
 biotin labeling, 11.102  
 blocking repetitive sequences, 11.103, 11.105–11.106  
 linkered pool preparations, 11.102  
 materials for, 11.100–11.101  
 overview, 11.98–11.100  
 primary selection, 11.105  
 secondary selection, 11.105  
 streptavidin bead preparation, 11.103  
 troubleshooting, 11.106  
 Directional cloning, 1.21–1.22, 1.84–1.87  
 in M13 vectors, 3.34  
 priming cDNAs with an oligo(dT) adaptor, 11.13  
 DiscoverARRAY Gene Display, A10.9  
 DisplayPhage System, 18.120  
 Dithiothreitol (DTT)  
 in binding buffer, 14.33  
 in vitro transcription reactions, 7.71  
 in primer extension assay protocol, 7.79  
 in random priming buffer, 9.6  
 in transformation buffers, 1.105–1.106  
 dITR. *See* Inosine  
 D-luciferin-O-phosphate, A9.42  
 DMRIE, 16.11  
 DMRIE-C, 16.11  
 DMS buffer, 12.63  
 DMS stop solution, 12.63  
 DMSO. *See* Dimethylsulfoxide  
 DNA. *See also* cDNA; Chromosomal DNA; Double-stranded DNA; Genomic DNA; Mammalian cells, DNA isolation; Plasmid DNA; Single-stranded DNA  
 concentrating. *See* Concentrating nucleic acids  
 concentration measurement  
 by fluorometry, 6.12  
 high-molecular-weight DNA, 6.11, 6.15  
 phenol contamination and, 6.11, 6.15  
 by spectrophotometry, 6.11, 6.15  
 denaturation. *See* Denaturation, DNA  
 detection  
 in agarose gels  
 ethidium bromide staining, 5.14–5.15  
 photography, 5.16–5.17  
 SYBR Gold staining, 5.15–5.16  
 in polyacrylamide gels  
 by autoradiography, 5.49–5.50  
 photography, 5.48  
 by staining, 5.47–5.48  
 drying DNA pellets, 1.34, 1.37, 1.41  
 electrophoresis of. *See* Agarose gel electrophoresis; Polyacrylamide gel electrophoresis  
 ethidium bromide interaction with. *See* Ethidium bromide  
 fingerprinting and mapping YAC genomic inserts, 4.63  
 footprinting DNA, 17.75–17.78, A4.41  
 fragmentation. *See* Fragmentation of DNA; Hydrodynamic shearing  
 gyrase, 1.4, 2.3  
 high-molecular-weight. *See* Chromosomal DNA; Genomic DNA; Large DNA molecules  
 ligase. *See* DNA ligase  
 microarrays. *See* DNA array technology  
 mismatch repair, A4.3  
 polymerases. *See* DNA polymerase  
 precipitation by  
 CPB, 10.22–10.24  
 CTAB, 6.62  
 ethanol, 3.28–3.29, 6.17–6.18, 6.61, 10.20–10.21, A8.12–A8.16  
 isopropanol, 6.25, 6.30  
 PEG, 1.152, 1.154  
 spermidine, 9.34, 9.36  
 probes. *See* DNA probes; Radiolabeled probe preparation  
 purification. *See also* Plasmid DNA, preparation  
 from agarose gels, 5.18  
 anion-exchange chromatography, 5.26–5.28  
 DEAE cellulose membranes, electrophoresis onto, 5.18–5.22  
 dialysis bags, electroelution into, 5.23–5.25  
 problems associated with, 5.18  
 from agarose gels, low-melting temperature agarose  
 agarase, 5.33–5.35  
 glass bead use, 5.32  
 organic extraction, 5.29–5.31  
 BAC  
 from large-scale cultures, 4.55–4.57  
 from small-scale cultures, 4.53–4.54  
 bacteriophage  $\lambda$ , 2.56–2.60  
 cosmid vectors, 4.22–4.23  
 CTAB use in, 6.62  
 high-molecular-weight  
 by chromatography on Qiagen resin, 4.45  
 by drop dialysis, 4.44  
 $\lambda$  bacteriophage  
 from liquid cultures, 2.106–2.108  
 from plate lysates, 2.101–2.104  
 M13, 12.21–12.24  
 double-stranded (replicative form), 3.23–3.25  
 large-scale, 3.30–3.33  
 single-stranded, 3.26–3.29  
 P1 and PAC, 4.42–4.45  
 simultaneous preparation with RNA and protein, 7.9–7.12  
 spooling, 6.61  
 YACs, 4.67–4.71  
 quantitation. *See* Quantitation of nucleic acids  
 replication. *See also* Origin of replication; Replicons  
 in  $\lambda$ , 2.11  
 in phagemids, 3.43  
 sequencing. *See* DNA sequencing  
 size markers. *See* Molecular-weight markers  
 synthesis of oligonucleotides, 10.1, 10.42–10.46  
 Ultraviolet (UV) radiation  
 damage to DNA by, 1.67, 1.151, 5.20, 5.24  
 fixation to membranes by, 1.135, 1.137, 2.94–2.95, 6.46, 7.36  
 vectors. *See* Vectors; *specific vectors*  
 vital statistics tables, A6.2–A6.10  
 DNA adenine methylase (*dam*). *See dam* methylase  
 DNA array technology, A10.1–A10.19  
 advantages/disadvantages of array systems, A10.10  
 applications, A10.2–A10.3  
 gene expression analysis, A10.2  
 genomic DNA changes, monitoring, A10.2–A10.3  
 choice of array system, A10.8, A10.10  
 coverslips for, A10.14  
 databases and analysis software, A10.14–A10.16  
 detection of hybridization signal, A10.11  
 emerging technologies, A10.16–10.19  
 barcode chip, A10.19  
 bioelectric chip, A10.19  
 bubble jet printing, A10.16  
 DOC system, A10.17  
 DNA-protein interactions, detection of, A10.18–A10.19  
 IBD mapping, A10.17–A10.18  
 piezoelectric printing, A10.16  
 primer extension, A10.17  
 protein microarrays, A10.18  
 resequencing, A10.17  
 tissue microarrays, A10.18  
 flowchart, experiment, A10.4  
 genomic resources for, A10.3–A10.6  
 guidelines for experiments, A10.13–A10.14  
 hybridization, A10.10  
 image analysis, A10.12–A10.13  
 process overview, A10.2  
 production of microarrays, A10.7–A10.8  
 commercial sources, 10.9, A10.7–A10.8  
 contact printing, A10.7  
 photolithography, A10.8  
 pin and ring, A10.8  
 robotics for high-throughput processing, 10.5  
 solid support substrates, 10.5–A10.7  
 steps, experimental, A10.3  
 surface chemistry, A10.5–A10.7  
 DNA-binding domains, 18.6–18.15  
 DNA-binding proteins  
 competition assays, 17.17  
 detection with one-and-a-half hybrid system, 18.125–18.126  
 gel retardation assays, 17.13–17.16, 17.78–17.80  
 materials for, 17.13  
 optimizing, 17.16

- poly-dI dC and, 17.14–17.15  
troubleshooting, 17.16
- identifying in bacteriophage  $\lambda$  expression libraries, 14.31–14.36
- mapping sites  
by DNase I footprinting, 17.4–17.11  
by hydroxyl radical footprinting, 17.12
- protection against *dam* methylation, 13.88
- supershift assays, 17.17
- DNA-dependent RNA polymerase, 1.4, 1.11
- DNA ligase. *See also* Ligation reactions  
bacteriophage T4, 1.157–1.158, 3.37, A4.31–A4.32  
activity of, A4.31  
blunt-end ligation, A4.32  
cohesive termini/nick ligation, A4.32  
linker/adaptor attachment to cDNA, 11.54  
uses, list of, A4.31
- E. coli*, 1.158–1.159, A4.33  
in cDNA second-strand synthesis, 11.43, 11.45–11.46
- $\lambda$ , 2.3  
overview, 1.157  
table of properties, 1.158  
thermostable, 1.158  
units of activity, 1.159
- DNA PAM (percent accepted mutation) program, A11.5
- DNA polymerase, A4.22–A4.23. *See also specific polymerases*  
for automated DNA sequencing, 12.96, 12.98  
bacteriophage T4, 11.43, 11.45, 11.54, 12.32, A4.18–A4.21, A4.22. *See also* Sequenase  
3'-5' exonuclease activity, 8.30, 8.34–8.35, A4.18, A4.20  
5'-3' exonuclease activity, A4.18, A4.20  
5'-3' polymerase activity, A4.20  
in blunt-end cloning of PCR products, 8.32–8.34  
cDNA second-strand synthesis, 11.16  
in end-labeling, 9.56–9.59  
exchange reaction, A4.21  
idling/turnover reaction, 9.57–9.58  
in oligonucleotide-directed mutagenesis of single-stranded DNA, 13.15–13.17  
polishing ends, 11.43, 11.45, 11.54, 12.17  
properties, table of compared, A4.11  
uses, list of, A4.18–A4.19
- bacteriophage T7, A4.22  
in oligonucleotide-directed mutagenesis of single-stranded DNA, 13.15–13.16  
overview of, 12.104  
properties, table of compared, A4.11  
comparison, table of, A4.11
- E. coli* DNA polymerase I, 1.4, 9.82–9.86, A4.12–A4.14. *See also* Klenow fragment  
3'-5' exonuclease activity, A4.12, A4.14  
5'-3' exonuclease activity, A4.12–A4.14  
5'-3' polymerase activity, A4.12–A4.13  
in cDNA second-strand synthesis, 11.14–11.16, 11.43–11.46
- digoxygenin labeling of nucleic acids, A9.38–A9.39
- DNase I contamination of, 9.13  
domains of, 9.82–9.83, 12.101  
end-labeling, A4.12  
error rate, 9.83  
exchange reaction, A4.14  
M13 replication, 3.5  
nick translation, 9.12–9.13, 9.85–9.86, A4.12  
proofreading, 9.82  
properties, table of compared, A4.11  
in random priming reactions, 9.5  
RNase H primer, 1.6  
RNase H activity, A4.12  
uses of, 9.85–9.86, A4.12
- Klenow fragment, 1.84–1.85, 4.15, A4.15–A4.17  
3'-5' exonuclease activity, A4.17  
5'-3' polymerase activity, A4.16  
end-labeling, 4.33, A4.15–A4.16  
exchange reaction, A4.17  
uses, list of, A4.15–A4.16  
overview, A4.10  
properties, table of, A4.11, A4.23  
reverse transcriptase (RNA-dependent DNA polymerase), A4.24–A4.26  
5'-3' polymerase activity, A4.24  
RNase H activity, A4.24–A4.25  
uses, list of, A4.25–A4.26
- in RT-PCR, 8.46, 8.48, 8.51–8.52  
thermostable, 8.4, 8.6–8.8, 8.10–8.11, 8.18, A4.22–A4.23. *See also* PCR  
3'-5' exonuclease activity, 8.30, 8.77  
antibodies, 8.110  
for cDNA second-strand synthesis, 11.14  
cocktail mixtures of, 8.7, 8.77  
digoxygenin labeling of nucleic acids, A9.38–A9.39  
in DNA sequencing, 12.45–12.50  
in hot start PCR, 8.110  
in mutagenesis procedures  
megaprimer PCR mutagenesis method, 13.33–13.34  
misincorporation mutagenesis, 13.80  
overlap extension method of mutagenesis, 13.37–13.39  
plasmid template mutagenesis, 13.20–13.21  
in SSCP protocol, 13.53  
terminal transferase activity; template-independent, 8.30
- DNA polymerase III, 1.4
- DNA probes, radiolabeled  
preparation  
cDNA probes  
subtracted, 9.41–9.50, 9.90–9.91  
using oligo(dT) primer, 9.41–9.45  
using random primers, 9.38–9.40  
end-labeling  
3' termini with cordycepin/dideoxy ATP, 9.60–9.61  
3' termini with Klenow, 9.51–9.56  
3' termini with T4 DNA polymerase, 9.57–9.59  
5' termini, 9.55, 9.66–9.75  
methods, table of, 9.55–9.56  
with T4 polynucleotide kinase, 9.55, 9.66–9.75  
with terminal transferase, 9.55–9.56, 9.60–9.61  
nick translation, 9.4, 9.12–9.13  
PCR, 9.11–9.18  
random priming, 9.4–9.11  
single-stranded probes from M13  
of defined length, 9.19–9.24  
of heterogeneous length, 9.25–9.28  
overview, 9.19–9.20  
premature termination, 9.24  
for S1 nuclease mapping of RNA, 7.59
- DNA-protein interaction detection by array use, A10.18–A10.19
- DNA-RNA hybrid length, measurement by alkaline agarose gel electrophoresis, 5.36
- DNase. *See also* DNase I  
contamination  
alkaline lysis plasmid DNA preparation, 1.42  
TE as source, 1.42  
exonuclease VII, 7.86  
in RNA isolation protocols, 7.8, 7.12  
single-strand-specific, 7.86  
in washing solution for inclusion bodies, 15.10
- DNase I, A1.8  
in *E. coli* lysate preparation for affinity chromatography, 14.29
- footprinting, 14.32, 14.40, 17.4–17.11, A4.41  
concentration of DNase I, 17.11  
control reactions, 17.8  
materials for, 17.4–17.7  
nuclear extract preparation from cultured cells, 17.9  
small numbers of cultured cells, 17.9–17.10  
tissue, 17.8–17.9  
optimization, 17.11  
overview, 17.75–17.76  
specificity, 17.75  
steps, diagram of, 17.5  
troubleshooting, 17.11
- hypersensitivity mapping, 17.18–17.22  
controls for, 17.22  
limitations of, 17.22  
materials for, 17.19–17.20  
overview of, 17.18–17.19  
protocol, 17.20–17.21  
in  $\lambda$  DNA purification, 2.107  
in nick translation, 9.12–9.13  
in RNA probe construction, 9.31–9.34  
in shotgun library generation, 12.10–12.11  
titrating batches of, 9.13
- DNase I dilution buffer, 17.19, A1.9
- DNA sequencing, 12.1–12.114  
asymmetric labeling, methods for, 12.72  
automated, 12.94–12.100  
capillary vs. slab systems, 12.94  
current models available, 12.94  
dye-primer sequencing, 12.96  
dye-terminator systems, 12.96–12.97  
genome sequencing strategy, 12.99–12.100  
history, 12.94–12.95  
optimizing reactions, 12.98–12.99  
polymerases for, 12.98  
templates for, 12.98–12.99
- autoradiography  
reading, 12.113
- BAFLs (bands in all four lanes), 12.29
- chemical method, 12.4–12.6, 12.61–12.73  
advantages of, 12.63  
chemical modifications used, 12.61  
diagram of, 12.62  
end-labeling for, 12.73  
flow chart for, 12.65  
materials for, 12.63–12.64  
methods, 12.64–12.66, 12.70–12.73  
end-labeling, 12.73  
examples, 12.72  
rapid, 12.70–12.71  
troubleshooting band aberrations, 12.67–12.69
- compression in gels, 12.109–12.111
- dideoxy-mediated chain termination, 12.3–12.4, 12.6–12.9  
cycle sequencing, 12.51–12.55, 12.60  
advantages of, 12.51–12.52  
with end-labeled primers, 12.51–12.55  
with internal labeling, 12.60  
reaction mixtures for, 12.53, 12.60  
troubleshooting, 12.55
- denaturation of DNA for, 12.26–12.30  
rapid protocol, 12.30
- double-stranded templates, 12.26–12.31  
amount needed, 12.27  
denaturation protocols, 12.28–12.30  
in DNA purification by PEG precipitation, 12.31  
PCR-amplified, 12.106  
troubleshooting, 12.29  
using cycle sequencing, 12.51, 12.54  
using Sequenase, 12.34  
using *Taq* polymerase, 12.49
- end-labeling, 12.8

- DNA sequencing (*continued*)  
 general principles, 12.6  
 internal radiolabeling, 12.8  
 kits, 12.9  
 primers, 12.6–12.7  
 problem sources, 12.8  
 single-stranded templates using  
 cycle sequencing, 12.51, 12.54  
 Klenow, 12.40–12.44  
 Sequenase, 12.32, 12.34  
*Taq* polymerase, 12.49  
 strategies, 12.7  
 templates, 12.7  
 preparing denatured, 12.26–12.31  
 troubleshooting problems with, 12.38–  
 12.39, 12.44, 12.56–12.58  
 troubleshooting, 12.56–12.59  
 using Klenow, 12.40–12.44, 12.102  
 materials for, 12.41–12.42  
 method, 12.42–12.43  
 reaction mixtures, table of, 12.41  
 troubleshooting, 12.44  
 using Sequenase, 12.32–12.39, 12.104–  
 12.105  
 annealing primer to template, 12.29  
 materials for, 12.33–12.35  
 protocol, 12.35–12.36  
 reaction mixtures, table of, 12.33  
 sequencing range, 12.37  
 steps involved, 12.32  
 troubleshooting, 12.38–12.39  
 using *Taq* DNA polymerase, 12.45–12.50  
 materials for, 12.48–12.49  
 method, 12.49–12.50  
 overview, 12.45–12.47  
 versions of *Taq* used, 12.46–12.47  
 dNTP/ddNTP stock solutions, preparation of,  
 12.107  
 exonuclease III use in, 13.72, 13.75  
 fluorescent labeling and, 9.80  
 glycerol in sequencing reactions, 12.108–12.109  
 history of, 12.3–12.4  
 Maxam and Gilbert technique, 12.3–12.6, 12.61–  
 12.73  
 microtiter plate use, 12.100  
 nucleoside analogs used as chain terminators in  
 (Table A6-11), A6.10  
 oligonucleotide primers, preparing stocks of,  
 12.103  
 PCR-amplified DNA, 12.106  
 plus and minus technique, 12.4  
 polyacrylamide gels, 12.66–12.69, 12.74–12.93  
 autoradiography, 12.90–12.93  
 compression of bands, troubleshooting,  
 12.83, 12.109–12.110  
 loading, 12.88  
 base order, 12.88  
 loading devices, 12.88  
 marker dye migration rate, 12.89  
 preparation of, 12.74–12.84  
 air bubbles, 12.79  
 electrolyte gradient gels, 12.83–12.84  
 formamide containing, 12.81–12.82  
 glass plates, 12.76–12.78  
 leaking gels, 12.80  
 materials for, 12.74–12.75  
 pouring gels, 12.78–12.80  
 reading, 12.90–12.93  
 resolution of, 12.85  
 running, 12.85–12.89  
 safety precautions, 12.86  
 temperature-monitoring strips, 12.86  
 troubleshooting band pattern aberrations,  
 12.67–12.69, 12.82  
 wedge gels, 12.83  
 purification of plasmid DNA for, 1.152  
 Sanger technique, 12.3–12.4, 12.6–12.9  
 shotgun sequencing, 12.10–12.25  
 diagram of strategy, 12.12  
 DNA purification, 12.21–12.24  
 DNA repair, phosphorylation, and size selec-  
 tion, 12.17–12.18  
 enzymatic cleavage, 12.10–12.11  
 fragmentation of target DNA, 12.10–12.11,  
 12.15–12.17  
 growth of recombinants in 96-tube format,  
 12.19–12.21  
 hydrodynamic shearing, 12.10  
 ligation to vector DNA, 12.18–12.19  
 materials for, 12.13  
 number of sequences needed for coverage, 12.20  
 self-ligation of target DNA, 12.15  
 test ligations, 12.18, 12.25  
 universal primers, 8.113–8.117  
 uses for, 12.3  
 DnD solution, 1.106, 1.109  
 dNTPs. *See* Deoxynucleoside triphosphates  
 Dodecyltrimethylammonium bromide (DTAB), 6.61  
 DOGS, 16.8–16.9, 16.11  
 DOPE. *See* Dioleoylphosphatidylethanolamine  
 DOSPA, 16.11  
 DOSPER, 16.11  
 Dot hybridization of purified RNA, 7.46–7.50  
 DOTAP, 16.5, 16.11  
 DOTMA, 16.11  
 Double interaction screen (DIS), 18.125  
 Double-stranded DNA  
 calculating amount of 5' ends in a sample, 9.63  
 chemical stability of, 6.3  
 concentration in solution (Table A6-4), A6.5  
 denaturing probes, 7.43  
 nomogram for, A6.13  
 probes, denaturing, 6.54  
 separation from single-stranded by hydroxyap-  
 atite chromatography, A8.32–A8.34  
 Dowex AG 50W-X8, A8.27  
 Dowex AG50 resin, 1.76, 1.151  
 Doxycycline, 17.52, 17.54–17.56, 17.59  
 DP50<sup>sup</sup>F *E. coli* strain  
 genotype, A3.7  
 $\lambda$  vector propagation, 2.29  
*DpnI*, 13.19–13.25, 13.84, A4.5–A4.6  
*DraI*, A4.9  
 fragment size created by, table of, A4.8  
 site frequency in human genome, 4.16, A6.3  
 dRhodamine, 12.96–12.98  
 Drop dialysis, 4.44, A8.11  
 Drop-out media recipe, A2.9  
*Drosophila melanogaster*  
 ecdysone, 17.71  
 genomic resources for microarrays, A10.6  
 Drying DNA pellets, 1.34, 1.37, 1.41, 1.46  
 Drying SDS-polyacrylamide gels, A8.50–A8.51  
 DTAB. *See* Dodecyltrimethylammonium bromide  
 DTT. *See* Dithiothreitol  
 Dual Luciferase Reporter Assay System, A9.22  
 Dulbecco's modified Eagle's medium (DMEM),  
 11.85, 16.32, 17.61  
*dut* gene, 13.11–13.15, 13.84, 13.85  
 dUTPase, 13.85  
 Dye-primer sequencing, 12.96  
 Dye-terminator systems, 12.96–12.97  
 DynAzyme, 8.7  
 DYNOMILL, 15.49  
*EagI*  
 cleavage at end of DNA fragments, A6.4  
 fragment size created by, table of, A4.8  
 genomic DNA mapping, 5.60, 5.69  
 methylation, A4.7  
 site frequency in human genome, 4.16, A6.3  
 EBC lysis buffer, 18.67–18.68  
 EBI-European Bioinformatics Institute, EMBL  
 Outstation, A11.2  
 Ecdysone receptor (EcR), 17.71, 17.73  
 Ecdysone-inducible mammalian expression system,  
 17.72  
*EcoK*, A4.4  
*E. coli* C, 11.113  
*E. coli* K, 11.113  
*E. coli* strains. *See* *Escherichia coli* strains  
*EcoO109I*, 9.52  
*EcoRI*  
 7-deaza-dGTP modified DNA, cleavage of, 8.60  
 in cDNA construction, 11.21, 11.48–11.52, 11.64  
 cleavage at end of DNA fragments, A6.4  
 fragment size created by, table of, A4.8  
 $\lambda$  vector construction, 2.19  
 linker sequences, 1.99  
 methylation of restriction site, 1.12, 1.99, 11.48–  
 11.50, A4.4  
 in positive selection vectors, 1.12  
 site frequency in human genome, 4.16, A6.3  
*EcoRI* methylase, 1.12, 11.48–11.50, A4.5, A4.7  
*EcoRI* methylase buffer, A1.10  
*EcoRII* methylase, A4.7  
*EcoRV*, A4.9, A6.4  
 ED8654 *E. coli* strain  
 genotype, A3.7  
 $\lambda$  vector propagation, 2.28  
 ED8767, *E. coli* strain  
 genotype, A3.7  
 ED8767 *E. coli* strain, 2.29  
 EDC (*N*-ethyl-*N'*-[dimethylaminopropyl]-carbodi-  
 imide), 18.104–18.105  
 Edman degradation, 18.62, 18.66, 18.68  
 EDTA, A1.26  
 as anticoagulant, 6.8  
 inhibition of PCR by, 8.13  
 as protease inhibitor, 15.19  
 in washing solution for inclusion bodies, 15.10  
 Effectene, 16.5  
 EGAD database, A10.15  
 EGTA, A1.26  
 inhibition of BAL 31, 13.64  
 as protease inhibitor, 15.19  
 EGY48, 18.22–18.23, 18.29, 18.44  
 EGY191, 18.22  
 Elastinal, A5.1  
 Electrical mobility of DNA, 12.114  
 Electroendo-osmosis (EEO), 5.7  
 Electrolyte gradient gels, 12.83–12.84, 12.87  
 Electrophoresis. *See* Agarose gel electrophoresis;  
 Alkaline agarose gel electrophoresis;  
 Contour-clamped homogenous electric  
 field; Denaturing gradient gel electro-  
 phoresis; Polyacrylamide gel electrophore-  
 sis; Pulsed-field gel electrophoresis; SDS-  
 polyacrylamide gel electrophoresis of pro-  
 teins; Transverse alternating field electro-  
 phoresis  
 Electrophoresis buffers  
 agarose gel preparation, 5.10  
 alkaline agarose gel electrophoresis, 5.37  
 BPTE, 7.28–7.29  
 CHEF gel, 5.80  
 DNA migration rate in agarose gels, effect on,  
 5.7–5.8  
 ethidium bromide in, 5.15  
 MOPS, 7.32  
 for polyacrylamide gel electrophoresis, 12.75,  
 12.84, 12.87  
 recipes, 5.8, A1.17–A1.18  
 in SSCP protocol, 13.52  
 TAFE gel, 5.75  
 taurine-containing, 12.108, 13.90  
 Tris-glycine, A8.42, A8.44  
 types, 5.8

- Electrophoretic transfer of DNA to nylon membranes, 6.36
- Electroporation  
of BAC DNA, 4.3, 4.49, 4.52  
DEAE-dextran enhancement of, 16.28  
DNA size and, 1.26  
electrical conditions required for, 16.55–16.56  
of library into COS-7 cells, 11.85–11.86  
of mammalian cells, 16.3, 16.33–16.36, 16.54–16.57  
efficiency, factors influencing, 16.33–16.34, 16.57  
materials for, 16.34–16.35  
method, 16.35–16.36  
marker-dependent transformation efficiency, 1.26  
mechanism of, 16.54–16.55  
in oligonucleotide-directed mutagenesis protocol, 13.18  
optimizing, 16.57  
overview, 1.25–1.26, 1.162  
P1 clones, 4.4, 4.46–4.47  
pulse parameters, 1.162  
transformation of *E. coli* by, 16.54  
cotransformants, 1.119, 1.122  
plasmid size and, 1.119  
protocol, 1.119–1.122  
pulse characteristics, 1.122
- Eliminator dye removal system, A8.28
- Elution buffer  
for oligo(dT)-cellulose chromatography, 7.14, 7.16  
Qiagen, A1.20  
EMBL, 2.20–2.22
- EMBL database, A11.20
- EMBL3A vector, 2.64–2.65
- emotif (Exploring the Motif Universe) program, A11.9
- En<sup>h</sup>Hance scintillant, A9.12
- End modifications  
by inverse PCR, 8.42  
by PCR, 8.42–8.45
- endA*. See Endonucleases, endonuclease A
- End-labeling  
3' termini with cordycepin or dideoxy ATP, 9.60–9.61  
3' termini with Klenow, 9.51–9.56, 9.83–9.85, 12.101  
materials for, 9.53  
overview of, 9.51–9.53  
protocol, 9.54  
uses for, 9.51  
3' termini with T4 DNA polymerase, 9.57–9.59  
5' termini with T4 polynucleotide kinase, 9.55, 9.66–9.75  
blunt/recessed 5' termini, 9.70–9.72  
by exchange reaction, 9.73–9.75  
protruding 5' termini, 9.66–9.69, 9.73–9.75  
for chemical sequencing, 12.73  
in cosmid vectors, 4.33  
by DNA polymerase I, A4.12  
in DNA sequencing, 12.8  
cycle DNA sequencing, 12.51–12.55  
with Klenow fragment, 9.51–9.56, 9.83–9.85, 12.101, A4.15–A4.16  
methods, table of, 9.55–9.56  
with poly(A) polymerase, 9.56, 9.61  
probes in S1 protection assays, 7.54  
RNA by RNA ligase, A4.30  
with RNA ligase, 9.56, 9.61  
with T4 DNA polymerase, 9.57–9.59, A4.18  
with terminal transferase, 9.55–9.56, 9.60–9.61
- Endoacetylmuramidase, bacteriophage T4, A4.51
- Endocytosis, internalization of DEAE-dextran/DNA complexes, 16.27
- Endolysin, bacteriophage  $\lambda$ , A4.51
- Endonucleases  
endonuclease A  
boiling lysis plasmid DNA protocols and, 1.18, 1.43, 1.46  
TE as contamination source, 1.42  
endonuclease IV, 12.3  
restriction endonuclease. See Restriction enzymes
- End-rescue subcloning, 4.63
- Enhanced cyan fluorescent protein (ECFP), 18.71–18.72, 18.76, 18.91
- Enhanced green fluorescent protein (EGFP), 18.72, 18.76, 18.90–18.94
- Enhanced yellow fluorescent protein (EYFP), 18.72, 18.76, 18.91
- Enlightning scintillant, A9.12
- Entensify scintillant, A9.12
- Enterokinase, 15.8, 15.39–15.40, 15.43, 18.49
- Entrez, 1.14
- Enzyme stabilization by glycerol, 13.90
- Enzyme-free cloning. See Ligation-independent cloning
- Enzymes, A4.1–A4.52. See also specific classes of enzymes; specific enzymes  
agarase, A4.51  
alkaline phosphatases, A4.37  
DNA polymerases, A4.10–A4.27  
bacteriophage T4, A4.18–A4.21  
3'-5' exonuclease activity, A4.18, A4.20  
5'-3' polymerase activity, A4.20  
exchange reaction, A4.21  
uses, list of, A4.18–A4.19  
bacteriophage T7, A4.22  
comparison, table of, A4.11  
DNA polymerase I, *E. coli*, A4.12–A4.14  
3'-5' exonuclease activity, A4.12, A4.14  
5'-3' exonuclease activity, A4.12, A4.14  
5'-3' polymerase activity, A4.12–A4.13  
end-labeling, A4.12  
exchange reaction, A4.14  
nick translation, A4.12  
uses, list of, A4.12  
Klenow fragment, A4.15–A4.17  
3'-5' exonuclease activity, A4.17  
5'-3' polymerase activity, A4.16  
end-labeling, A4.15, A4.16  
exchange reaction, A4.17  
uses, list of, A4.15–A4.16  
overview, A4.10  
properties, table of compared, A4.11  
reverse transcriptase (RNA-dependent DNA polymerase), A4.24–A4.26  
5'-3' polymerase activity, A4.24  
RNase H activity, A4.24–A4.25  
uses, list of, A4.25–A4.26  
terminal transferase, A4.27  
thermostable, A4.22–A4.23
- inhibitors, table of, A5.1
- kinase, bacteriophage T4 polynucleotide, A4.30, A4.35–A4.36  
exchange reaction, A4.30, A4.35–A4.36  
forward reaction, A4.30, A4.35–A4.36  
properties, table of, A4.30
- ligases, A4.30–A4.34  
bacteriophage T4 DNA ligase, A4.31–A4.32, A4.34  
activity of, A4.31  
blunt-end ligation, A4.32  
cohesive termini/nick ligation, A4.32  
uses, list of, A4.31  
*E. coli* DNA ligase, A4.33  
thermostable DNA ligases, A4.34
- lysozymes, A4.51
- methylating, A4.3–A4.9. See also Methylation  
*dam* methyltransferase, A4.3  
*dem* methyltransferase, A4.3–A4.4  
nucleases, A4.38–A4.49  
bacteriophage  $\lambda$  exonuclease, A4.49
- BAL 31, A4.43–A4.45  
DNase I, A4.40–A4.42  
exonuclease III, A4.47–A4.48  
mung bean, A4.47  
RNase A, A4.39  
RNase H, A4.38  
RNase T1, A4.39  
S1, A4.46  
proteinase K, A4.50  
RNA polymerases, A4.28–A4.29  
topoisomerase I, A4.52  
UDG, A4.51
- EPD (eukaryotic promoter database), A11.20
- Episomes, 1.3, 11.69. See also Plasmids
- Epitope tagging, 17.32, 17.90–17.93  
applications, 17.91  
examples, table of, 17.92–17.93  
overview, 17.90  
practical considerations, 17.90–17.91
- Epitope-tagged proteins, 1.14
- Eppendorf 5 Prime, 1.64
- Equilibration buffer, 5.86
- Equilibrium centrifugation, 1.18–1.19. See also Cesium chloride density gradients
- Escherichia coli*  
chromosome size, 5.65  
genomic resources for microarrays, A10.6  
strains. See also specific strains  
for the amplification of cDNA libraries in bacteriophage  $\lambda$  vectors, 11.66  
choosing appropriate, 1.14–1.16  
for inverted repeat sequences, 1.15  
for methylated DNA propagation, 1.15–1.16  
recombination mutations, 1.15  
for toxic protein products, 1.15  
heat lysis and, 1.17–1.18, 1.43  
 $\lambda$  propagation, 2.28–2.29, 11.62  
for M13 vectors, 3.10–3.46  
receiving in the laboratory, 1.29  
table of, A3.6–A3.10  
for in vitro packaging, 2.111
- EtBr Green Bag, A8.28
- Ethanol  
NaCl/ethanol solution, 6.19–6.20  
for washing glass plates for polyacrylamide gel electrophoresis, 12.77
- Ethanolamine, 18.104–18.105
- Ethanol precipitation, A8.12–A8.16  
aspiration of supernatants, A8.15  
carriers, A8.13  
dissolving precipitates, A8.13, A8.15–A8.16  
of DNA, 6.61  
M13 RF DNA preparation, 3.25  
M13 single-stranded DNA preparation, 3.28–3.29  
in PCR product purification, 8.59  
radiolabeled oligonucleotides, 10.20–10.21  
for spooling of mammalian DNA, 6.17–6.18  
history of, A8.14  
protocol for, A8.14–A8.15  
of RNA, 9.34–9.35, A8.16  
salt solutions used with, A8.12
- Ethidium bromide, A1.26  
agarose gel electrophoresis, 5.5, 5.11–5.15  
binding to DNA, A9.3  
breaks in DNA, single-stranded, 5.20  
in CsCl gradients, 1.18, 1.151  
continuous, 1.65–1.68  
discontinuous, 1.69–1.71  
decontamination, A8.27–A8.28  
commercial kits for, A8.28  
of concentrated solutions, A8.27–A8.28  
of dilute solutions, A8.28  
disposal of ethidium bromide, A8.27

- Ethidium bromide (*continued*)  
 dissociation from DNA, 1.151  
 DNase I and, A4.41  
 fluorescence, A9.3  
 in formaldehyde-containing agarose gels,  
 7.31–7.32  
 glyoxylated RNA, staining of, 7.27–7.28  
 intercalation into DNA, 1.18, 1.151, 5.14  
 migration in agarose gel electrophoresis, 5.13  
 overview, 1.150–1.151  
 photography, 5.16  
 polyacrylamide gel staining, 5.15, 5.47–5.48  
 quantitation of DNA, A8.19, A8.23–A8.24, A9.4  
 agarose plate method, A8.24  
 minigel method, A8.24  
 spot test, A8.19, A8.24  
 rate of DNA migration in agarose, effect on,  
 1.53, 5.5, 5.15  
 in real time PCR, 8.94  
 removal from DNA, 1.68, 1.151, A8.27  
 extraction with organic solvents, 1.72–1.77,  
 1.151  
 ion-exchange chromatography, 1.75–1.77,  
 1.151  
 resolution and, 5.15  
 RNA staining, 7.31–7.32  
 sensitivity of, 5.12  
 staining DNA in gels, A9.3–A9.4  
 structure of, 1.150, A9.3  
 as trypanocidal agent, 5.14, A9.3  
 versions of, improved, A9.4
- Ethyl acetate, 17.36, 17.38, 17.40  
*N*-ethylmaleimide, 13.3
- Eukaryotic DNA. *See* Genomic DNA; Mammalian  
 cells, DNA isolation
- Eukaryotic expression libraries. *See also* Expression  
 libraries  
 construction, 11.68–11.73  
 screening, 11.74–11.78
- European Bioinformatics Institute, A11.23
- ExGen 500, 16.5
- Exon amplification, 11.35, 11.79–11.97  
 analysis of clones, 11.95–11.97  
 electroporation of library into COS-7 cells,  
 11.85–11.86  
 flow chart of steps, 11.80  
 library construction, 11.81  
 mRNA, harvesting, 11.87–11.88  
 overview, 11.79–11.97  
 RT-PCR, 11.89–11.94  
 materials, 11.90–11.91  
 overview, 11.89  
 protocol, 11.91–11.94
- Exonuclease II buffer, A1.10
- Exonuclease III, 11.121, 13.2, A4.47–A4.48  
 3' exonuclease activity, A4.48  
 3' phosphatase activity, A4.48  
 activities of, 13.73  
 in linker-scanning mutagenesis, 13.75  
 making templates for dideoxysequencing with,  
 13.75  
 nested deletion mutant sets, generation of,  
 13.57–13.61, 13.74–13.75  
 overview, 13.72–13.75, A4.47–A4.48  
 in site-directed mutagenesis, A4.48  
 substrate specificity, 13.72  
 thionucleotide resistance to, 13.75  
 uses of, 13.74, A4.47–A4.48
- Exonuclease III buffer, 13.58
- Exonuclease V, 1.15, 2.11–2.13, 2.13
- Exonuclease VII, 7.86
- Exonuclease,  $\lambda$ , A4.49
- Expand high-fidelity PCR system, 13.20
- Expand long-template PCR system, 8.7, 8.77
- ExPASy: Molecular Biology Server-Expert Protein  
 Analysis System, Swiss Institute of  
 Bioinformatics, A11.2
- Export of proteins, 15.30, 15.34–15.35  
 maltose-binding fusion proteins, 15.40, 15.43
- Expressed sequence tags (ESTs), 9.89
- GenBank, A10.3–A10.4  
 microarray technology and, A10.3–A10.4, A10.6
- Expression. *See also* Expression in *E. coli* of cloned  
 genes; Expression in mammalian cells  
 analysis by microarray technology, A10.2  
 cloning  
 cDNA library construction, 11.68–11.73  
 controls for, 11.70  
 factors influencing success, 11.69–11.70  
 mammalian host/vector systems, 11.69  
 screening cDNA library, 11.74–11.78  
 vector systems for, 11.72  
 screening cDNA libraries by, 11.33–11.34
- Expression array platform, A10.9
- Expression in *E. coli* of cloned genes, 15.1–15.60  
 expression system choice, 15.2–15.3, 15.55–15.57  
 fusion proteins  
 cleavage, 15.6–15.8  
 chemical, 15.6–15.8  
 enzymatic, 15.7–15.8, 15.39–15.40, 15.43  
 purification  
 by affinity chromatography on amylose  
 resin, 15.40–15.43  
 by affinity chromatography on glutathione  
 agarose, 15.36–15.39  
 of histidine-tagged proteins, 15.44–15.48  
 from inclusion bodies, 15.49–15.54  
 of maltose-binding proteins, 15.40–15.43  
 by metal chelate affinity chromatography,  
 15.44–15.48  
 purification of, 15.4–15.5  
 solubility, 15.9–15.11, 15.39, 15.53–15.54  
 uses for, 15.4  
 vectors for creating, 15.5
- inclusion bodies, 15.9–15.11, 15.49–15.54
- optimization  
 codon usage, 15.12  
 of expression from inducible promoter,  
 15.16–15.19  
 growth conditions, 15.12, 15.16–15.17, 15.19,  
 15.23, 15.28  
 temperature effect on, 15.16–15.17, 15.25  
 translation initiation, 15.11–15.12  
 overview, 15.56–15.57  
 problem areas, 15.56–15.57  
 promoters, choosing, 15.3–15.4  
 solubility of proteins, 15.9–15.11, 15.39, 15.53–  
 15.54  
 using alkaline phosphatase promoter (*phaA*),  
 15.30–15.35  
 large-scale expression, 15.34  
 materials for, 15.31–15.32  
 optimization, 15.33  
 overview, 15.30  
 protocol, 15.32–15.34  
 subcellular localization of fusion proteins,  
 15.35  
 using IPTG-inducible promoters, 15.3, 15.14–  
 15.19  
 choices for, 15.3  
 large-scale expression, 15.17–15.18  
 materials for, 15.15  
 optimization, 15.16–15.19  
 overview, 15.14  
 protocol, 15.16–15.18  
 troubleshooting, 15.18–15.19  
 using  $\lambda p_1$  promoter, 15.4, 15.25–15.29  
 large-scale expression, 15.29  
 materials for, 15.26–15.27  
 optimization, 15.28  
 overview, 15.25  
 protocol, 15.27–15.29
- tryptophan-inducible expression, 15.26,  
 15.28–15.29  
 using T7 promoter, 15.3–15.4, 15.20–15.24  
 large-scale expression, 15.24  
 materials for, 15.22  
 optimization, 15.23–15.24  
 overview, 15.20–15.22  
 protocol, 15.23–15.24  
 regulation by lysozyme, 15.24  
 vectors, choosing, 15.3–15.5
- Expression in mammalian cells, 17.1–17.99  
 differential expression, 9.89  
 DNA-binding proteins  
 competition assays, 17.17  
 gel retardation assays  
 materials for, 17.13  
 optimizing, 17.16  
 poly(dI-dC) and, 17.14–17.15  
 troubleshooting, 17.16  
 gel retardation assays for, 17.13–17.16, 17.78–  
 17.80  
 mapping sites by  
 DNase I footprinting, 17.4–17.11  
 hydroxyl radical footprinting, 17.12  
 supershift assays, 17.17  
 DNase I footprinting, 17.4–17.11  
 control reactions, 17.8  
 materials for, 17.4–17.7  
 nuclear extract preparation from  
 cultured cells, 17.9  
 small numbers of cultured cells, 17.9–17.10  
 tissue, 17.8–17.9  
 optimization, 17.11  
 steps, diagram of, 17.5  
 troubleshooting, 17.11
- DNase-I-hypersensitivity sites, mapping, 17.18–  
 17.22  
 controls for, 17.22  
 limitations of, 17.22  
 materials for, 17.19–17.20  
 overview of, 17.18–17.19  
 protocol, 17.20–17.21  
 hydroxyl radical footprinting protocol, 17.12
- inducible systems  
 ecdysone, 17.71–17.74  
 tetracycline, 17.52–17.70  
 libraries, 11.68–11.69, 11.74–11.78. *See also*  
 Expression libraries, screening  
 overview, 17.3  
 reporter assays, 17.30–17.51  
 $\beta$ -galactosidase, 17.48–17.51  
 endogenous mammalian  $\beta$ -galactosidase  
 activity, 17.48  
 materials for, 17.50  
 method, 17.51  
 normalizing reporter enzyme activity to  $\beta$ -  
 galactosidase activity, 17.48, 17.51  
 overview, 17.48–17.49  
 p $\beta$ -gal reporter vectors, 17.49  
 substrates for  $\beta$ -galactosidase, 17.51  
 chloramphenicol acetyltransferase, 17.30–  
 17.41, 17.95  
 aberrant transcription, 17.34  
 controls, 17.34  
 measurement by diffusion of reaction  
 products into scintillation fluid, 17.41  
 measurement by extraction with organic  
 solvents, 17.40  
 measurement by thin-layer chromatogra-  
 phy, 17.36–17.39  
 normalizing CAT activity to  $\beta$ -galactosi-  
 dase activity, 17.48–17.49, 17.51  
 overview, 17.33–17.34  
 pCAT3 vectors, 17.35  
 quantitative assays, 17.95  
 genes used, 17.30–17.32

- GFP, 17.85–17.87  
 luciferase, 17.42–17.47, 17.96  
 advantages of, 17.42  
 luminometer measurements from 96-well plates, 17.47  
 materials for, 17.44  
 methods, 17.45–17.47  
 optimizing measurement, 17.45  
 pGL3 vectors, 17.43  
 scintillation counting protocol, 17.46  
 overview, 17.30–17.32  
 transfection controls, 17.32  
 transcriptional run-on assays, 17.23–17.29  
 materials for, 17.24–17.26  
 nuclei isolation, 17.26–17.27  
 from cultured cells, 17.26  
 from tissue, 17.27  
 overview of, 17.23–17.24  
 radiolabeling transcripts from cultured cell nuclei, 17.27  
 tissue nuclei, 17.27–17.28
- Expression libraries, screening, 14.1–14.51  
 antibody choice for, 14.50–14.51  
 antisera purification for, 14.51  
 complexity of library, 14.49  
 cross-reactive antibody removal  
 affinity chromatography, 14.28–14.30  
 incubation with *E. coli* lysate, 14.26–14.27  
 pseudoscreening, 14.23–14.25  
 DNA-binding protein identification, 14.31–14.36  
 filter preparation, 14.35–14.36  
 hybridization, 14.36  
 materials for, 14.32–14.34  
 overview, 14.31–14.32  
 probe preparation, 14.34–14.35  
 enzymatic vs. radiolabeled reagents, 14.3  
 by far western analysis, 18.48–18.50  
 genomic vs. cDNA libraries, 14.47–14.48  
 in  $\lambda$  vectors, 14.4–14.13, 14.47–14.49  
 bacteriophage recovery from stained filters, 14.11  
 chemiluminescent screening, 14.11–14.12  
 chromogenic screening, 14.9–14.11  
 detection of fusion protein-expressing plaques, 14.8–14.12  
 duplicate filter preparation, 14.8  
 expression induction on filters, 14.7–14.8  
 materials for, 14.4–14.6  
 plating bacteriophage, 14.7  
 radiochemical screening, 14.9  
 troubleshooting, 14.13  
 validation of clones, 14.12  
 lysate preparation from  $\lambda$  lysogens, 14.37–14.46  
 agar plate, 14.41–14.43  
 from colonies, 14.37–14.40  
 liquid culture, 14.44–14.46  
 overview, 14.37  
 in plasmid vectors, 14.14–14.22, 14.47–14.49  
 chemiluminescent screening, 14.21–14.22  
 chromogenic screening, 14.20–14.21  
 master plate/filter preparation, 14.17  
 materials for, 14.15–14.17  
 processing filters, 14.18  
 protein expressing clones, 14.19–14.22  
 radiochemical screening, 14.19  
 replica filter preparation, 14.17–14.18  
 validation of clones, 14.22  
 vector choice, 14.14  
 probability of recombinant existence, 14.48  
 probe types  
 antibody probes, 14.1–14.2  
 oligonucleotide probes, 14.2  
 specialized, 14.2  
 for protein interactions by two-hybrid system, 18.6  
 Expression systems, 15.55–15.57  
*Bacillus subtilis*, 15.55  
 bacteriophage T7, A4.28  
*E. coli*, 15.1–15.60. *See also* Expression in *E. coli* of cloned genes  
 insect cells, culture, 15.55  
 mammalian cells. *See* Expression in mammalian cells  
 RNA polymerase use in, 9.88  
*Saccharomyces cerevisiae*, 15.55  
 system selection, 15.55  
 Expression vectors  
 $\lambda$ , 2.22–2.23, 4.83  
 luciferase, A9.23  
 overview, 1.13–1.14  
 phagemids, 3.43  
 ExSite PCR-based site-directed mutagenesis kit, 13.89  
 Extinction coefficients, 10.13–10.14, A8.20–A8.21  
 Extraclean, 18.104–18.106  
 Ex-Wax DNA extraction kit, 6.27
- f1 bacteriophage, 1.11  
 origin of replication, 11.22–11.24, 17.35, 17.49  
 sequences in  $\lambda$ ZAP vectors, 11.22  
 f88-4, 18.118  
 Factor X protease, 15.40, 15.43  
 Factor Xa, 15.7–15.8, 15.39  
 Far western analysis, 18.3  
 outline of, 18.49  
 protein-protein interactions, detecting, 18.48–18.54  
 Farnesylated enhanced GFP (EGFP-F), 16.10  
 Fast performance liquid chromatography (FPLC), 13.20  
 FASTA program, A11.3, A11.19  
 FASTS/TFASST program, A11.19  
 FASTX/FASTY program, A11.4  
 fd bacteriophage, 3.2, 18.115, 18.117. *See also* M13 bacteriophage  
 FeCl<sub>3</sub> in  $\lambda$  stock preparation, 2.35, 2.37  
 Fe(II)-EDTA, 17.12, 17.76–17.77  
 Fetuin for protein stability, 17.16  
 F factors  
 BACs and, 4.2–4.3, 4.48  
 history of, 4.49  
*lacI<sup>q</sup>* allele on, 15.18  
 M13 and, 3.2, 3.8, 3.11, 3.17–3.18  
 maintaining, 3.17–3.18  
 overview, 4.49  
*par* genes, 4.3  
 positive selection strategies, 3.11–3.13  
 FGENES program, A11.11–A11.12  
 FI protein,  $\lambda$ , 2.14  
 Fibronectin, 18.60, 18.62, 18.64  
 Ficoll 400  
 in DNase I footprinting protocol, 17.10  
 in gel retardation assay, 17.15  
 FII gene,  $\lambda$ , 2.14  
 Filamentous bacteriophage, 18.115. *See also* f1 bacteriophage; M13 bacteriophage  
 biology overview, 3.2–3.7  
 discovery of, 3.2  
 phagemids, 3.42–3.49  
 Filamentous phage display, 18.3, 18.115–18.122  
 affinity selection and purification of bacteriophages, 18.121  
 commercial display systems, 18.120–18.121  
 of foreign proteins, 18.121–18.122  
 interaction rescue, 18.122  
 of peptides, 18.116–18.121  
 constrained libraries, 18.120–18.121  
 construction of libraries, 18.117–18.119  
 random peptide libraries, 18.116–18.117  
 vectors used for, 18.115–18.116, 18.118  
 Filling in, 1.84–4.85  
 double stranded cDNA, 11.20  
 with Klenow fragment, 9.83–9.84, 12.101, A4.5  
 with reverse transcriptase, A4.25  
 with T4 DNA polymerase, 9.57, A4.18  
 Film, autoradiography and, A9.9–A9.14  
 Filters. *See specific type of filter*  
 Firefly luciferase gene. *See* Luciferase  
 Fixative, cell, 16.13  
 FK506, 18.11  
 FKBP12, 18.11  
 FLAG  
 affinity purification of fusion proteins, 15.4–15.6  
 epitope tagging, 17.92–17.93  
 FlexiPrep, 1.64  
 FLIM. *See* Fluorescence lifetime imaging microscopy  
 cell preparation for, 18.84–18.89  
 fixed cells, 18.87–18.88  
 microinjection of live cells, 18.88–18.89  
 transfection of plasmid DNA into live cells, 18.84–18.86  
 example experiments  
 on fixed cells, 18.94–18.95  
 on live cells, 18.93–18.94  
 flow diagram for, 18.79  
 image acquisition, 18.90–18.95  
 imaging protein phosphorylation with, 18.78  
 labeling proteins with fluorescent dyes for, 18.80–18.83  
 frequency domain, 18.74, 18.76–18.77  
 image processing, 18.75–18.78  
 single-frequency configuration, 18.76–18.77  
 time domain, 18.74  
 Fluorescence resonance energy transfer (FRET), 17.87, 18.4, 18.69–18.95  
 detection methods, 18.72–18.74  
 donor quenching, 18.73  
 fluorescence lifetime, 18.73–18.74  
 photobleaching, acceptor, 18.73  
 steady-state fluorescence intensity measurements, 18.72–18.73  
 efficiency, 8.71, 18.74  
 FLIM-FRET, 18.78–18.95  
 cell preparation for, 18.84–18.89  
 data acquisition, 18.90–18.95  
 flow diagram, 18.79  
 imaging protein phosphorylation with, 18.78  
 labeling proteins with fluorescent dyes for, 18.80–18.83  
 photophysical principles of, 18.70–18.72  
 Fluorescent labeling  
 of oligonucleotide probes in real time PCR, 8.94–8.95  
 probes, 9.77–9.80  
 in microarray hybridization, A10.2, A10.11–A10.13  
 in sequencing, 12.63  
 in automated DNA sequencing, 12.94–12.96  
 in cycle DNA sequencing, 12.52  
 Fluorochromes  
 excitation and emission wavelengths, A9.33  
 labeled antibodies, A9.33  
 Fluorography, A9.12  
 Fluorometers, 8.95  
 Fluorometric quantitation of nucleic acids, 6.12, A8.22–A8.24  
 ethidium bromide use, A8.19, A8.23–A8.24  
 agarose plate method, A8.24  
 minigel method, A8.24  
 spot test, A8.19, A8.24  
 with Hoechst 33258, A8.19, A8.22–A8.23  
 Fluorometry buffer, 6.12  
 Fnu4H in end-labeling, selective, 9.52



- FokI* methylase, A4.7
- Footprinting DNA, 17.75–17.78  
cleavage product selection, 17.77  
DNase I, 17.4–17.11, 17.75–17.76  
controls for, 17.8  
materials for, 17.4–17.7  
method, 17.8–17.10  
overview of, 17.75–17.76  
troubleshooting/optimizing, 17.11  
hydroxy radical, 17.12, 17.76  
in vivo, 17.77  
1,10 penanthroline-copper, 17.76–17.77
- Forced ligation. *See* Directional cloning
- Formaldehyde  
in agarose gels, 7.31–7.34  
in cell fixative, 16.13  
RNA denaturation, 7.31–7.33  
for dot/slot hybridization, 7.48  
in silver staining protocol, A9.5–A9.7
- Formaldehyde gel-loading buffer, A1.19
- Formamide, 1.138  
deionization of, A1.24  
for DNA isolation  
in  $\lambda$  DNA extraction, 2.59–2.60  
from mammalian cells, 6.13–6.15  
in DNA sequencing protocols, 12.109–12.110  
resolving compressions in sequencing gels, 6.59  
in gel-loading buffers, 7.7, 7.68, 10.12, 12.36, A1.19  
in northern hybridization, 7.45  
in PCR, 8.9  
in polyacrylamide sequencing gels, 12.81–12.82  
purity, assessing, 6.59  
in ribonuclease protection assay protocols, 7.67  
RNA denaturation, 6.59, 7.33  
RNA gel-loading buffer, 7.68  
RNA storage, 7.8  
in Southern hybridization, 6.56, 6.58–6.60  
stripping northern blots, 7.44  
stripping probes from filters, A9.38  
in tracking dye, 10.12
- Formamide denaturation buffer, 6.14
- Formamide dye mix, 17.6
- Formamide loading buffer, 7.77, 12.36, A1.19
- Formic acid, 12.70–12.71, A1.6  
cleavage of fusion proteins, 15.6, 15.8
- FPLC. *See* Fast performance liquid chromatography
- Fragmentation of DNA, A8.35–A8.38. *See also* Hydrodynamic shearing  
HPLC use for, A8.35  
methods, table of, A8.35  
nebulization, A8.37–A8.38  
sonication, A8.36–A8.37
- Fredd volume fluctuation, 16.55
- French press for cell lysis prior to affinity chromatography, 15.38, 15.46
- FRET. *See* Fluorescence resonance energy transfer
- Frozen storage buffer, 1.106, 1.108
- FspI*, 5.69
- FSSP (Fold classification based on Structure-Structure alignment of Proteins) database, A11.22
- ftz* gene, 18.125
- fUSE vectors, 18.118
- Fusion proteins  
 $\beta$ -galactosidase, 17.97  
cleavage, 15.6–15.8  
chemical, 15.6–15.8  
enzymatic, 15.7–15.8, 15.39–15.40, 15.43  
epitope tagging, 17.90–17.93  
applications, 17.91  
examples, table of, 17.92–17.93  
overview, 17.90  
practical considerations, 17.90–17.91  
expression vectors, 1.13–1.14  
GFP, 17.87–17.89  
*lacZ* fusion, 15.57–15.59  
disadvantages, 15.58  
inclusion bodies, 15.58  
vectors for, 15.59  
lysate preparation from  $\lambda$  lysogens  
agar plates, 14.41–14.43  
from colonies, 14.37–14.40  
liquid culture, 14.44–14.46  
protein-protein interaction studies  
GST, 18.48–18.59  
two-hybrid system, 18.17–18.47  
purification, 15.4–15.5  
by affinity chromatography, 14.40  
on amylose resin, 15.40–15.43  
on glutathione agarose, 15.36–15.39  
metal chelate, 15.44–15.48  
of histidine-tagged proteins, 15.44–15.48  
from inclusion bodies, 15.49–15.54  
of maltose-binding proteins, 15.40–15.43  
screening expression libraries  
 $\lambda$  vectors, 14.31  
in  $\lambda$  vectors, 14.4–14.12  
in plasmid vectors, 14.14–14.15, 14.19–14.22  
solubility, 15.9–15.11, 15.39, 15.53–15.54  
subcellular localization of PhoA fusion proteins, 15.35  
uses for, 15.4  
vectors for creating, 15.5
- G418, 16.24, 16.48
- Gadolinium oxysulfide intensifying screens, A9.11
- GAL1, 18.24, 18.27, 18.30, 18.37
- GAL4, 18.14–18.15, 18.24
- Galactokinase in positive selection vectors, 1.12
- Galacto-Light, 17.50
- gal* gene,  $\lambda$  transduction of, 2.18
- gam*,  $\lambda$ , 2.11–2.13, 2.20, 2.22
- GATA-1 transcription factor in positive selection vectors, 1.12
- GC-Melt, 4.81, 8.9, 8.23
- GEF. *See* Guanyl nucleotide exchange factor
- Gel electrophoresis. *See* Agarose gel electrophoresis;  
Alkaline agarose gel electrophoresis;  
Contour-clamped homogeneous electric field; Denaturing gradient gel electrophoresis; Polyacrylamide gel electrophoresis; Pulsed-field gel electrophoresis; SDS-polyacrylamide gel electrophoresis of proteins; Transverse alternating field electrophoresis
- Gel equilibration buffer, 5.33
- Gel retardation assays, 11.68, 17.13–17.16, 17.78–17.80  
advantages of, 17.79  
carrier DNAs, 17.80  
competition assays, 17.17  
controls, 17.15  
materials for, 17.13  
measuring dissociation constants of protein-DNA complexes, 17.79  
mechanism of action, 17.80  
mobility of protein-DNA complex, 17.79–17.80  
optimizing, 17.16  
overview, 17.78–17.80  
poly(dI-dC) and, 17.14–17.15  
supershift assays, 17.17  
troubleshooting, 17.16
- Gel Slick, 12.75
- Gelatin, A1.27
- Gel-elution buffer, 7.55, 7.59–7.60
- Gel-fixing solution, 12.90
- Gel-loading buffers  
6x gel-loading buffers, 5.42, A1.18–A1.19  
agarose gel electrophoresis, 1.53, 5.9  
alkaline agarose gel electrophoresis, 5.37  
formaldehyde, 7.32, A1.19  
formamide, 7.7, 7.68, 10.12, 12.36, A1.19  
glycerol in, 13.90  
recipes, A1.18–A1.20  
RNA, 7.68, A1.19  
SDS, 15.15, 15.22, 15.26, 15.31, 15.35, 15.41, 15.50, 18.17, A1.20, A8.42
- GenBank, A10.3, A10.15, A11.20
- GenData AG image analysis program, A10.13
- Gene discovery and microarray technology, A10.3
- Gene expression. *See also* Expression in *E. coli* of cloned genes; Expression in mammalian cells; Expression libraries, screening; Expression systems; Northern hybridization  
analysis by microarray technology, A10.2  
differential display-PCR, 8.96–8.106  
measurement by reassociation kinetics, 7.65
- Gene gun. *See* Biolistics
- Gene Pulser II, 16.35
- GeneAmp 5700 System, 8.95
- Genecards database, A10.15
- GeneChip, A10.9
- Geneclean, 12.21
- GeneFilters microarrays, A10.9
- Genelight (GL) system, A9.22
- GeneMark program, A11.10
- GeneParser program, A11.11
- GenePix 4000, A10.11, A10.13
- GenePix image analysis software, A10.15
- GenePix Pro image analysis program, A10.13
- GENESCAN program, A11.11
- GeneSHUTTLE 20, 16.5
- GeneSHUTTLE 40, 16.5
- GENESIS sample processor (Tecan), A10.5
- GeneSpring, A10.15
- GeneTAC 1000, A10.11
- Genetic code table, A7.4
- Genetic engineering with PCR, 8.42–8.45
- Geneticin, A2.7
- Geneticin resistance in activation domain fusion plasmids, 18.20
- GeneTransfer HMG-1 Mixture, 16.5
- GeneTransfer HMG-2 Mixture, 16.5
- GeneView software, A10.9
- GenExplore image analysis program, A10.13
- GeniePrep, 1.64
- Genie program, A11.10
- Genome comparisons (Table A6-1), A6.2
- Genome sequencing strategy, 12.99–12.100
- GenomeInspector program, A11.13
- Genomic DNA  
breakage, 6.3  
CHEF gels, 5.79–5.82  
cloning specific fragments of, 2.80  
digestion by restriction enzymes in agarose plugs, 5.68–5.70, 5.78  
direct selection of cDNAs with, 11.98–11.106  
exon trapping/amplification, 11.79–11.97  
expression library construction, 14.48–14.49  
inverse PCR, 8.81  
isolation  
CTAB use, 6.62  
hydrodynamic shearing forces and, 6.3  
lysis of cells  
blood cells, 6.8–6.9  
in monolayers, 6.6  
in suspension, 6.7, 6.17  
in tissue samples, 6.7–6.8, 6.17  
from microtiter plates, 6.19–6.22  
from mouse tails, 6.23–6.27  
one-tube isolation, 6.26–6.27  
from paraffin blocks, 6.27  
without extraction by organic solvents, 6.26  
from paraffin blocks, 6.27  
for PCR use, 6.18, 6.22

- rapid protocol  
   for mammalian DNA, 6.28–6.30  
   for yeast DNA, 6.31–6.32  
 by spooling, 6.16–6.18  
 using formamide, 6.13–6.15  
 using proteinase K and phenol, 6.4–6.11  
   100–150-kb DNA size, 6.10–6.11  
   150–200-kb DNA size, 6.10  
 for microarray analysis, A10.3–A10.6  
 microarray technology for monitoring changes  
   in, A10.2–A10.3  
 partial digestion for cosmid library construction,  
   4.20  
 preparation for pulsed-field gel electrophoresis,  
   5.61–5.67  
 resolution by TAFE, 5.74–5.78  
 restriction digestion  
   completeness of, 6.40  
   for Southern analysis, 6.39–6.40, 6.42  
 Southern analysis. *See also* Southern hybridiza-  
   tion)  
   overview, 6.33  
   restriction digestion for, 6.39–6.40, 6.42  
   transfection of eukaryotic cells, calcium-phos-  
   phate-mediated, 16.21–16.24  
 Genomic footprinting, 12.63  
 Genomic libraries. *See also* Vectors, high-capacity  
   BAC  
   construction, 4.49–4.50  
   screening, 4.50–4.51  
   chromosome walking, 4.8–4.10  
   clone analysis by PCR, 2.105  
   construction  
     arrayed libraries, 4.8  
     chromosome walking, 4.8–4.10  
     overview, 4.6–4.7  
     vector choice, factors influencing, 4.7–4.10  
   cosmids, 4.11–4.34  
     amplification, 4.28–4.34  
     arrayed libraries, 4.31  
     overview, 4.11–4.16  
     protocol for construction, 4.17–4.23  
     stability of recombinants, 4.28  
     storage, 4.30, 4.32  
   DNA for. *See* Genomic DNA  
   gaps in coverage, 4.6–4.7  
   human, table of, 4.9  
   insert size, 2.77  
   in  $\lambda$   
     amplification, 2.87–2.89  
     ligation of  $\lambda$  arms to genomic DNA frag-  
     ments, 2.84–2.86  
     screening by hybridization  
       DNA transfer to filters, 2.90–2.95  
       protocol, 2.96–2.100  
   P1, 4.35–4.40  
   partial digestion of DNA for  
     pilot reactions, 2.76–2.79  
     preparative reactions, 2.80–2.83  
   probability calculations, 4.6  
   restriction site frequency in human genome,  
     4.16  
   vectors PCR isolation of genomic ends, 4.74–  
     4.81  
   YAC  
     characterization, 4.61  
     construction, 4.60  
     mapping inserts, 4.63  
     rescuing termini of genomic DNAs, 4.63  
     screening, 4.61, 4.62  
     subcloning from, 4.64  
 Genomic mismatch scanning (GMS), A10.17–  
   A10.18  
 Genomics and mapping protein interactions,  
   18.123–18.124  
 GENSCAN program, A11.11  
 Gentamycin, A2.7  
 German Human Genome Project, A10.5  
 GFP. *See* Green fluorescent protein  
 GI724 *E. coli* strain, 15.26  
 Gibbs sampler (Gibbs Sampling Strategy for  
   Multiple Alignment) program, A11.10  
 Giemsa stain, 16.13  
 Gigapack III Gold, 11.114  
 Glass beads  
   acid-washed, 6.31–6.32  
   recovery of DNA from agarose gels using, 5.32  
 Glass plates for sequencing gels, 12.76–12.78  
 Glass powder resins for DNA purification, 5.26  
 Glass slides for microarray applications, A10.5  
 Glass-Max, 1.64  
 Glassmilk, 8.27  
 Glassware, preparation of, A8.3  
 Glucocorticoid receptor (GR), 17.71  
 Glucose oxidase  
   chemiluminescent enzyme assay, A9.20  
   as digoxigenin reporter enzyme, 9.77  
 Glu-Glu, epitope tagging, 17.93  
 Glutamic acid  
   codon usage, A7.3  
   nomenclature, A7.7  
   properties, table of, A7.8  
 Glutamine  
   codon usage, A7.3  
   nomenclature, A7.7  
 Glutaraldehyde  
   in cell fixative, 16.13  
   coupling peptides to carriers, A9.32  
   for silver staining PFGE gels, 5.77  
 Glutathione-agarose resin, 15.36–15.39, 17.83  
   18.51–18.52, 18.58–18.59  
 Glutathione elution buffer, 15.36, 15.38  
 Glutathione S-transferase (GST) fusion proteins,  
   14.47, 15.26, 15.36–15.39, 17.83  
   affinity purification of fusion proteins, 15.4,  
     15.6  
   as probes for protein-protein interactions,  
     18.48–18.59  
     anti-GST antibodies, 18.54  
     biotin-labeled, 18.50  
     far western analysis, 18.48–18.54  
     pull-down technique, 18.55–18.59  
     protein-protein interactions, 18.3  
     pull-down technique, 18.3, 18.48, 18.55–18.59  
     materials for, 18.57–18.58  
     method, 18.58–18.59  
     outline of, 18.56  
     troubleshooting, 18.59  
     soluble fusion protein production, 15.9  
 Glyceraldehyde-3-phosphate dehydrogenase  
   (GAPDH)  
   normalizing RNA samples against, 7.22  
   use as quality check on RNA gels, 7.30  
 Glycerol, 13.54, A1.27  
   in calcium-phosphate-mediated transfection,  
     16.14–16.15, 16.17, 16.52  
   DEAE transfection, facilitation of, 16.28  
   in DNA sequencing reactions, 12.38, 12.59,  
     12.108–12.109  
   in gel-loading buffers, 13.90  
   in PCRs, 8.9, 8.23, 8.78  
   in polyacrylamide gels, 13.90  
   for stabilization of enzymes, 13.90  
   for storage of bacterial cultures, 13.90, 17.24,  
     A8.5  
   structure of, 13.90  
   for transient expression and transformation of  
     mammalian cells, 13.90  
 Glycerol shock, 17.62–17.63  
 Glycerol step gradient for  $\lambda$  particle purification,  
   2.52–2.53, 13.90  
 Glycerol storage buffer, 17.24  
 Glycine  
   codon usage, A7.3  
   nomenclature, A7.7  
   properties, table of, A7.8  
 Glycogen as carrier in ethanol precipitation of  
   DNA, A8.13  
 Glyoxal  
   deionization of, A1.24  
   denaturation of RNA for electrophoresis,  
     7.27–7.29  
 GMS 418 Array Scanner, A10.11  
 Gobase for Mitochondrial Sequences database,  
   A11.21  
 Gold use in biolistics, 16.38–16.39  
 Good buffers, A1.3–A1.4  
 Gomori buffers, A1.5  
*gpt* gene, *E. coli*, 16.49  
 Gradient fractionating device, 2.81–2.82  
 Gradients. *See* Cesium chloride density gradients;  
   Glycerol step gradient; Sodium chloride,  
   density gradient for  $\lambda$  arm purification;  
   Sucrose gradients  
 Grail II (Gene Recognition and Analysis Internet  
   Link) program, A11.11  
 Green fluorescent protein (GFP), 17.84–17.89  
   antibodies, 17.89  
   cloning vectors, 18.84  
   fluorescence excitation and emission spectra,  
     17.86  
   FRET (fluorescence resonance energy transfer),  
     18.69–18.72, 18.76, 18.84–18.89  
   as fusion tag, 17.87–17.89  
   localization signals, fusion of organelle-specific,  
     18.69, 18.84  
   overview, A9.24  
   pdEGFP vectors, 17.88  
   in protein interaction analysis, 18.69  
   as reporter, 17.31–17.32, 17.85–17.87  
   resources for use of, 17.89  
   source of, 17.84  
   structure and function, 17.84–17.85  
   as transfection positive control, 16.4, 16.10,  
     16.12  
   variants of, 18.71–18.72  
*groE* gene, 2.14  
 Growth hormone as reporter gene, 17.31  
 Grunstein-Hogness screening, 1.28, 1.127, 1.135  
 GST fusion proteins. *See* Glutathione-S-transferase  
   fusion proteins  
 Guanidine hydrochloride, 14.31–14.33  
   denaturing fusion proteins with, 15.7  
   inclusion body solubilization, 15.60  
   for solubilization of inclusion bodies, 15.54  
 Guanidine thiocyanate in denaturing agarose gels,  
   7.22  
 Guanidinium  
   chloride, 15.60  
   hydrochloride, structure of, 7.85  
   isothiocyanate, 7.85, 15.60  
   salts, overview of, 7.85  
   thiocyanate in RNA purification protocols, 7.4–7.8  
 Guanine, A6.8  
   carbodiimide modification, 13.95  
   nitrous oxide modification of, 13.78  
   related compounds (Table A6-7), A6.8  
   structure, A6.8  
 Guanyl nucleotide exchange factor (GEF), 18.126  
 Guessmers, 8.66–8.67, 10.6–10.9, 11.31  
   design, 10.7  
   hybridization conditions, 10.8  
   melting temperature, 10.8  
   mixtures of, 10.7–10.8  
   PCR compared, 10.9  
 Guide RNA (gRNA) database, A11.21  
 Gyrase. *See* DNA, gyrase  
 GYT medium, 1.120–1.121, A2.2

- <sup>3</sup>H  
 decay data, A9.15  
 particle spectra, A9.10  
 sensitivity of autoradiographic methods for detection, A9.13
- HABA (2-[4'-hydroxyazobenzene]) benzoic acid, 11.115
- HaeIII methylase, A4.5
- HaeIII in rapid screen for interaction trap isolates, 18.47
- Hairpin structures  
 nuclease S1 digestion of, 11.4, 11.16, 11.46  
 self-primed synthesis of cDNA and, 11.4, 11.17, 11.46
- Hanahan method for preparation and transformation of competent *E. coli*, 1.105–1.110
- HAT medium, 16.48
- HB101 *E. coli* strain, 1.115  
 boiling lysis plasmid DNA protocols, 1.17–1.18, 1.43  
 cell-wall component shedding and DNA purification, 1.18, 1.115  
 endonuclease A contamination and DNA preparation, 1.18  
 in exon amplification protocols, 11.82–11.84  
 genotype, A3.7  
 $\lambda$  vector propagation, 2.29
- HB2151 *E. coli* strain, 18.116
- HCC. See Hexamminecobalt chloride
- HCl (hydrochloric acid), A1.12, A.6
- Heat shock genes, cellular, 15.25
- Heat-sealable bags. See Seal-A-Meal bags
- Helicase, 4.2
- Helicobacter pylori*, genomic resources for microarrays, A10.6
- Helper virus  
 phagemids and, 3.42–3.47  
 preparation of high-titer stock, 3.46  
 superinfection protocol, 3.47
- Hemocytometer counting, A8.6–A8.7
- Hemoglobin inhibition of PCR by, 8.13
- Heparin  
 inhibition of PCR by, 8.13  
 in Southern hybridization, 6.56
- HEPES  
 in BIAcore analysis solutions, 18.104–18.105, 18.108  
 in binding buffer, 14.33, 14.36  
 in cell resuspension buffer, 17.6  
 in DNase I dilution buffer, 17.19  
 in electrophoresis buffers, 13.56  
 in oligonucleotide labeling buffer, 9.10  
 in random primer buffer, 9.6, 9.47  
 in tissue homogenization buffer, 17.6, 17.25  
 in tissue resuspension buffer, 17.6
- HEPES-buffered DMEM, 16.32
- HEPES-buffered saline, 16.15–16.17, 16.22–16.23, 16.52
- Herpes simplex type-1 (HSV-1) TetR fusion to VP16 protein, 17.54–17.55
- HERV repetitive elements, 11.95
- Heteroduplex analysis (HA), 13.49, 13.51
- Hexadecyltrimethyl ammonium bromide. See also Cetyltrimethylammonium bromide  
 polysaccharide removal, 2.105  
 for solubilization of inclusion bodies, 15.54
- Hexamminecobalt chloride (HCC)  
 as condensing agent, 1.24, 1.152  
 in transformation buffers, 1.107–1.108
- hfl* gene, *E. coli*, 2.21, 2.28, 11.59, 11.111, 14.48
- HhaI* in site-directed mutagenesis protocol, 13.84
- HhaI* methylase, A4.4, A4.7
- HhaII* methylase, A4.7
- High-molecular-weight DNA. See Chromosomal DNA; Genomic DNA; Large DNA molecules
- High-performance liquid chromatography (HPLC)  
 hydrodynamic shearing of DNA, A8.35  
 oligonucleotide purification, 10.49
- himA* gene, 2.16
- himD* gene, 2.16
- HincII*, 1.100, A4.9
- HindIII*  
 7-deaza-dGTP modified DNA, cleavage of, 8.60  
 cleavage at end of DNA fragments, A6.4  
 fragment size created by, table of, A4.8  
 linker sequences, 1.99  
 site frequency in human genome, 4.16, A6.3  
 terminal/subterminal site cleavage, inefficient, 8.38
- HinfI*  
 7-deaza-dGTP modified DNA, cleavage of, 8.60  
 in end-labeling, selective, 9.52
- Hirudin, A5.1
- his3*, 4.59, 18.11, 18.19, 18.22
- His-6 epitope, 17.93. See also Histidine-tagged proteins
- HisBond Resin, 15.46
- Histidine  
 for affinity purification of fusion proteins, 15.6  
 codon usage, A7.3  
 nomenclature, A7.7  
 properties, table of, A7.8
- Histidine-tagged proteins, 17.83  
 elution by decreasing pH, 15.44–15.48  
 purification by affinity chromatography, 15.6, 15.44–15.48  
 in SPR spectroscopy, 18.99
- Histochemical stain, 16.13
- $\beta$ -galactosidase and, 17.98–17.99
- Histone deacetylation, inhibition of, 16.17
- HisTrap, 15.46
- HIV. See Human immunodeficiency virus
- HMMER program, A11.7
- HMS174 *E. coli* strain, 15.23, A3.7
- HNPP (2-hydroxy-3-naphthoic acid 2'-phenyl-anilide phosphate), 9.79
- Hoechst 33258 fluorochrome, 6.12, A8.19, A8.22–A8.23
- Holliday structure, 2.16
- Homogenization of tissue, 6.7–6.8  
 for nuclear extract preparation, 17.8  
 for RNA isolation, 7.6–7.7  
 for transcriptional run-on assay, 17.27
- Homopolymeric tailing, 11.110–11.111
- Horseradish peroxidase (HRP)  
 antibody conjugates, A9.34  
 CARD (catalyzed reporter deposition) protocol and, A9.19  
 chemiluminescent assay, 9.79, A9.19  
 as digoxigenin reporter enzyme, 9.77  
 luminol probes and, A9.35–A9.37  
 overview, A9.35  
 as reporter enzyme, 9.77, 9.79  
 in screening expression libraries, 14.3, 14.20–14.21  
 chemiluminescent, 14.11, 14.21  
 chromogenic, 14.10–14.11  
 substrates, A9.35
- Hot start PCR, 8.89
- Hot tub DNA polymerase, 8.10  
 in megaprimer PCR mutagenesis method, 13.33  
 properties, table of, A4.23
- HotWax Beads, 8.110
- Housekeeping genes  
 as endogenous standards for quantitative PCR, 8.86–8.87  
 normalizing RNA samples against, 7.22
- HpaI*, A4.9
- HpaII* methylase, A4.7
- HphI*  
 for T vector creation, 8.35  
*HphI* methylase, A4.7  
*HphII*, *dam* methylation and, A4.3
- HPLC. See High-performance liquid chromatography
- HPOL, epitope tagging, 17.93
- HRP. See Horseradish peroxidase
- HSB buffer, 17.24
- hsdM*, 11.66, A4.4
- hsdR*, 2.28–2.29, 11.23–11.24, 11.66, A4.4
- hsdR4*, M13 vectors and, 3.10, 3.12
- hsdR17*, M13 vectors and, 3.10, 3.12
- hsdS*, 2.29, A4.4
- HSSP (homology-derived secondary structure of proteins) database, A11.22
- H-tetrazole, 10.42
- Human Genome Project, 12.99, 18.66, A10.5
- Human immunodeficiency virus (HIV)  
 GeneChip array, A10.9  
 Rev protein, 18.11
- Human PAC library, 4.9
- Hybond-C extra, 14.6, 14.24
- Hybridization. See also Nitrocellulose membranes; Nylon membranes; Probes; Southern hybridization  
 bacteriophage  $\lambda$  recombinants, screening  
 DNA transfer to filters, 2.90–2.95  
 probe purity, 2.98  
 in situ amplification, 2.95  
 blocking agents for, A1.14–A1.16  
 cDNA screening, 11.27–11.32  
 homologous probes, 11.27  
 similar sequence probes, 11.28–11.29  
 subtracted cDNA probes, 11.29–11.31  
 synthetic oligonucleotide probes, 11.31–11.32  
 total cDNA probes, 11.29  
 zoo blots, 11.28
- chemiluminescent labels in, A9.17–A9.18
- Church buffer, 4.26
- competitor DNA use, 4.26
- cross-hybridization, reducing, 4.27
- denaturation of DNA on filter, 2.94
- direct selection of cDNAs protocol, 11.98–11.106
- of DNA separated by CHEF, 5.82
- of DNA separated by TAFE, 5.78
- DNA transfer to filters, 2.90–2.95  
 rapid protocol, 2.95
- expression library screening, 14.36
- fixation of DNA to filter, 2.94–2.95
- in formamide-containing buffers, 6.60
- Grunstein-Hogness screening, 1.28
- identifying recombinant plasmids by, 1.27–1.28  
 at low stringency, 6.58
- making filters, 2.93
- melting temperature and, 10.47–10.48
- microarrays, A10.10–A10.12, A10.14
- nonradioactive labeling and, 9.76–9.80
- northern hybridization  
 background, 7.45  
 cDNA library screening, 11.38  
 fixation of RNA to membranes, 7.35–7.36, 7.39–7.40  
 at low stringency, 6.58  
 low-stringency, 7.43  
 membranes used for, 6.37  
 nonradioactive labeling and, 9.76, 9.80  
 overview of, 7.21–7.26  
 protocol, 7.42–7.44  
 quantitating RNA by, 7.66
- ribonuclease protection assay compared, 7.63–7.65
- RNA separation by size  
 electrophoresis of glyoxylated RNA, 7.27–7.30  
 equalizing RNA amounts in gels, 7.22–7.23  
 formaldehyde-agarose gels, 7.31–7.34

- markers used in gels, 7.23, 7.29  
 overview, 7.21–7.22  
 pseudomessages as standards, 7.23  
 RNA transfer to membranes, 7.25–7.26, 7.35–7.41  
   membranes used for, 7.23–7.25  
   protocols, 7.35–7.41  
   staining of RNA on membranes, 7.39  
   steps involved, list of, 7.21  
   stripping blots, 7.44  
   troubleshooting, 7.45  
 for nuclease S1 mapping of RNA, 7.59–7.60  
 oligonucleotide probes  
   degenerate pools, 10.5–10.6  
   hybridization temperature, 10.6  
   length of probes, 10.4–10.5  
   melting temperature, 10.2–10.4  
   reassociation kinetics, 7.65  
   repetitive elements in probes, 4.26–4.27  
 RNA  
   dot and slot, 7.46–7.50  
   intensity of signal, measuring, 7.47  
   normalization, 7.47  
   protocol, 7.48–7.50  
   sample application to membrane, 7.46  
   standards, 7.47  
   northern protocol, 7.42–7.44. *See also* Northern hybridization  
 screening  
   BAC libraries, 4.50–4.51  
   bacterial colonies  
     binding DNA to filters, 1.131, 1.135, 1.137  
     filter type, choosing, 1.126  
     intermediate numbers, 1.129–1.131  
     large numbers, 1.132–1.134  
     lysing colonies, 1.131, 1.135–1.137  
     with radiolabeled probe, 1.138–1.142  
     replica filters, 1.131, 1.134  
     small numbers, 1.126–1.128  
   M13 plaques by, 3.41  
   site-directed mutagenesis clones, 13.40–13.47  
   subtractive, 9.44–9.46, 9.49, 9.90–9.91  
   unamplified cosmid high-capacity, 4.24–4.27  
 in situ hybridization  
   nonradioactive labeling and, 9.76, 9.80  
   RNA probes for, 9.35  
   subtractive, 9.44–9.46, 9.49, 9.90–9.91  
   transcriptional run-on assays, 17.23–17.24, 17.28–17.29  
 Hybridization buffer, A1.12–A1.13  
   with formamide (for RNA), A1.13  
   without formamide (for RNA), A1.13  
   in nuclease S1 mapping of RNA, 7.56  
   rapid, 6.61–6.62  
   in ribonuclease protection assay protocols, 7.67  
 Hybridization chambers, 1.139–1.141, 2.97, A10.14  
 Hybridization solution, 6.51–6.52, 11.100, A1.13–A1.14  
 Hydra Work Station (Robbins), A10.5  
 Hydrazine  
   5-methylcytosine and, 12.68  
   in chemical sequencing protocols, 12.61–12.65  
   rapid methods, 12.71  
   mutagenesis from, 13.78  
   salt interference with, 12.73  
 Hydrazine stop solution, 12.63  
 Hydrochloric acid (HCl), A1.6, A1.12  
 Hydrodynamic shearing, 2.76, 6.10, 12.10–12.11.  
   *See also* Fragmentation of DNA  
 Hydrolink, 13.51, 13.53  
 Hydrophobicity scales, A9.31  
 HydroShear, A8.35  
 Hydroxy radical footprinting, 17.76  
 Hydroxyapatite chromatography, 7.65, 9.44, 9.90–9.91, 11.10, A8.32–A8.34  
 Hydroxylamine, 13.91, 13.95  
   for cleavage of fusion protein, 15.8  
   mutagenesis from, 13.78  
 2-hydroxy-3-naphthoic acid 2'-phenylamide phosphate (HNPP), 9.79  
 3-(*p*-hydroxyphenyl) propionic acid (HPPA), A9.35  
 Hydroxyquinoline, A8.9  
 Hygromycin, 16.49, 17.74, A2.7  
 Hygromycin-B phosphotransferase, 16.47, 16.49  
 Hypophosphorous acid, A8.27  
 Hypoxanthine, 8.68, 10.9, A6.10  
<sup>125</sup>I  
   decay data, A9.15  
   radiolabeling antibodies, A9.30  
   sensitivity of autoradiographic methods for detection, A9.13  
<sup>131</sup>I decay data, A9.15  
 Iasys, 18.96  
 IBIS Biosensor, 18.96  
 Identical-by-descent (IBD) mapping, A10.17–A10.18  
 IgG, radioiodination of, 14.5, 14.16  
 IGP (imidazoleglycerolphosphate), 4.59  
 ImaGene image analysis program, A10.13  
 Imidazole, 15.44–15.45, 15.47  
 Imidazole buffer, 9.74, 15.45, A4.35  
 Imidazoleglycerolphosphate (IGP), 4.59  
 Immunity vectors, 2.21  
 Immunoaffinity columns, 11.10. *See also* Affinity chromatography  
 Immunoassay. *See* Immunological screening  
 Immunoblotting, A8.52–A8.55  
   blocking agents, A8.54  
   membrane types, A8.53  
   probing and detection, A8.54–A8.55  
   staining proteins during, A8.54  
   transfer of proteins from gel to filter, A8.52–A8.53  
 Immunofluorescence and epitope tagging, 17.91  
 Immunoglobulin-binding proteins A, G, L, A9.46–A9.49  
 Immunoglobulins. *See* Antibodies  
 Immunohistochemical staining  
   for  $\beta$ -glucuronidase, 16.42  
   of cell monolayers for  $\beta$ -galactosidase, 16.13  
 Immunological screening. *See also* Expression libraries, screening  
   antibody choice, 14.50–14.51  
   antisera purification, 14.51  
   cDNA screening, 11.32–11.33  
   chemiluminescent labels in, A9.17–A9.18  
   cross-reactive antibody removal  
     affinity chromatography, 14.28–14.30  
     incubation with *E. coli* lysate, 14.26–14.27  
     pseudoscreening, 14.23–14.25  
   epitope tagging, 17.90–17.93  
   of expression libraries, 14.1–14.3  
   validation of clones isolated by, 14.12  
 Immunoprecipitation, A9.29  
   coimmunoprecipitation, 18.4  
   epitope tagging, 17.91  
   of polysomes, 11.10  
 Inclusion bodies, 15.9–15.11, 15.56, 15.58  
   isolation by centrifugation, 15.10  
   lysis of bacteria containing, 15.10  
   purification and washing, 15.51–15.52  
     Triton X-100 use, 15.51  
     urea use, 15.52  
   purification of proteins from, 15.49–15.54  
     cell lysis, 15.49  
     refolding of proteins, 15.53–15.54  
   refolding proteins from, 15.11  
   solubilization, 15.11, 15.52, 15.60  
   washing, 15.10  
 Inclusion-body solubilization buffer, 15.50  
 Incompatibility of plasmids, 1.7–1.8  
 India Ink, A8.54  
 Inducible expression systems  
   ecdysone, 17.71–17.74  
   tetracycline, 17.52–17.70  
 Induction medium, 15.12, 15.31  
 Influenza virus hemagglutinin, epitope tagging of, 17.92  
 Injection/transfection buffer, 5.86  
 Ink, radioactive, 1.140, 1.142, 2.97–2.98, A1.21  
 Inosinate (IMP) dehydrogenase, 16.49  
 Inosine, 8.68, 8.113, 10.9–10.10, 11.32  
   in DNA sequencing, 12.88, 12.95, 12.97, 12.109–12.110  
   Sequenase use of, 12.105  
   structure, A6–10  
 Inoue method for preparation and transformation of competent *E. coli*, 1.112–1.115  
 Insects  
   baculoviruses, 17.81–17.83  
   expression in cultured cells, 15.55  
 Insertion vectors,  $\lambda$ , 2.19, 2.21  
 Insertional inactivation, 1.10  
 In situ hybridization  
   nonradioactive labeling and, 9.76, 9.80  
   RNA probes for, 9.35  
 Integrase, 2.8, 2.16, 11.11  
 Integration host factor (IHF), 2.16  
 Integration of  $\lambda$ , 2.16  
 Intensifying screens, A9.11  
 Interacting sequence tags (ISTs), 18.124  
 Interaction rescue, 18.122  
 Interaction trap  
   genomic analysis, 18.123–18.124  
   library screening, 18.30–18.48  
      $\beta$ -galactosidase activity assay, 18.36–18.37  
     characterization of isolates, 18.45  
     confirmation of positive reactions, 18.38–18.45  
     flow chart for, 18.38  
     harvesting transformants, 18.33–18.34  
     by agitation, 18.34  
     by scraping, 18.34  
   interacting proteins, screening for, 18.35  
   materials for, 18.30–18.32  
   rapid screen of positive reactants, 18.46–18.48  
   transformation of library, 18.32–18.33  
   troubleshooting, 18.35, 18.37  
   related technologies, 18.125–18.127  
*int* gene, 2.3, 2.8, 2.21  
 Inverse PCR, 1.157, 4.74–4.75, 8.81–8.85  
   materials for, 8.82–8.83  
   method, 8.84–8.85  
   overview of, 8.81  
   restriction enzyme choice for, 8.81, 8.84–8.85  
   schematic representation of, 8.82  
   site-directed mutagenesis  
     deletion introduction, 8.42  
     end modification, 8.42  
   use of, 8.81  
 Inverted repeat sequences, lethality of, 1.15  
 Invitrogen, 1.84  
 In vitro mutagenesis, 12.102, 13.19–13.25. *See also* Mutagenesis, site-directed  
 In vitro packaging, 2.111, 11.113–11.114  
 In vitro transcription  
   capped RNAs, 9.88  
   of genomic fragments, 4.74  
   kits, 9.32  
   plasmid vectors for, 9.29–9.31  
   protruding 3' termini, 9.33–9.34, 9.36  
   RNA polymerases, 9.87–9.88  
   RNA probe synthesis, 9.29–9.37  
     materials for, 9.32–9.33  
     promoter addition by PCR, 9.36–9.37  
     protocol, 9.33–9.35  
   for RNase protection assay

- In vitro transcription (*continued*)  
 DNA template production, 7.70  
 protocol, 7.71  
 for in situ hybridization, 9.35  
 troubleshooting, 9.36  
 RNA purification, 9.34–9.35  
 uses of, 9.88
- Iodine, radiolabeling of, 14.5, 14.16
- Iodoacetate, A4.42, A5.1
- Iodogen (1,3,4,6-tetrachloro-3 $\alpha$ ,6 $\alpha$ -diphenylglycouracil), A9.30
- Iodosobenzoic acid 2-(2-nitrophenyl)-3-methyl-3-bromoindole-nine, 15.8
- Ion-exchange chromatography for removal of ethidium bromide from DNA by, 1.75–1.77
- IPLab MicroArray Suite for Macintosh, A10.15
- IPTG (isopropylthio- $\beta$ -D-galactoside), 1.124–1.125, A1.27  
 amplification of P1 vectors, 4.36, 4.42  
 direct addition to plates, 1.125  
 fusion protein induction, 14.38, 14.40–14.42, 14.45–14.46  
 for M13 vectors recognition, 3.8, 3.19  
 in screening of expression libraries  
 $\lambda$  vectors, 14.4, 14.7–14.8  
 plasmid vectors, 14.14, 14.18  
 use with M13 vectors, 3.38
- IPTG overlay solution, 14.41–14.42
- IPTG-inducible promoters  
 for expression of cloned genes in *E. coli*, 15.3, 15.14–15.19  
 choices for, 15.3  
 large-scale expression, 15.17–15.18  
 materials for, 15.15  
 optimization, 15.16–15.19  
 overview, 15.14  
 protocol, 15.16–15.18  
 troubleshooting, 15.18–15.19
- tac* promoter, 15.3  
*trc* promoter, 15.3
- IR1, 3.42
- Iron response element (IRE), 18.11
- IRS, epitope tagging, 17.93
- Isoamyl alcohol  
 ethidium bromide extraction from DNA, 1.73  
 in phenol:chloroform:isoamyl alcohol extractions, 6.25, 6.27, 17.28, A1.23, A8.10
- Isoelectric focusing (IEF), 18.61
- Isogen, 7.10
- Isolation of DNA. *See* Genomic DNA, isolation; Mammalian cells, DNA isolation
- Isoleucine  
 codon usage, A7.3  
 nomenclature, A7.7  
 properties, table of, A7.9
- Isopropanol  
 DNA precipitation, 6.25, 6.30, A8.5  
 ethidium bromide extraction from DNA, 1.151, A8.27  
 RNA precipitation, 7.7, 7.12
- Isopropylthio- $\beta$ -D-galactoside. *See* IPTG
- Isopycnic centrifugation through CsCl gradients for  $\lambda$  particle purification, 2.47–2.51
- Isothermal titration calorimetry, 18.96
- ISTs (interacting sequence tags), 18.124
- Iterons, 1.8
- Jellyfish (*Aequorea victoria*), 17.89. *See also* Green fluorescent protein
- J* gene,  $\lambda$ , 2.4, 2.15
- JM101 *E. coli* strain  
 genotype, A3.7  
 M13 vectors and, 3.12
- JM103 *E. coli* strain, 1.115
- JM105 *E. coli* strain  
 genotype, A3.7  
 M13 vectors and, 3.12
- JM107 *E. coli* strain  
 genotype, A3.7  
 M13 vectors and, 3.12
- JM108 *E. coli* strain, 1.115  
 transformation by Hanahan method, 1.106
- JM109 *E. coli* strain, 1.115, 13.12–13.13  
 genotype, A3.7  
 M13 vectors and, 3.12  
 M13-100 vector use in, 3.10  
 phagemids and, 3.42
- JM110 *E. coli* strain  
 genotype, A3.7  
 M13 vectors and, 3.12
- K802 *E. coli* strain  
 genotype, A3.8  
 $\lambda$  vector propagation, 2.28
- Kanamycin, 1.9  
 in *dam*<sup>-</sup> strains and, 13.88  
 mechanism of resistance to, 1.145  
 modes of action, 1.145, A2.7  
 properties, 1.145  
 stock/working solutions, A2.6  
 structures of, 1.145
- Kanamycin resistance ( $Km^R$ ) (*kan*<sup>R</sup>), 1.9  
 in activation domain fusion plasmids, 18.20  
 in LexA fusion plasmids, 18.19  
 in P1 vectors, 4.4, 4.37  
 in two-hybrid system of reporter plasmids, 18.12
- KasI* cleavage at end of DNA fragments, A6.4
- KC8 *E. coli* strain, 18.27, 18.43, A3.8
- KCl. *See* Potassium chloride
- Keiselguhr, A9.32
- Keyhole limpet hemocyanin, A9.32
- Kid proteins, 17.56
- Kinase. *See* Polynucleotide kinase, bacteriophage T4
- Kinetic PCR. *See* Real time PCR
- Kissing complex, 1.5, 1.7
- Kits, plasmid purification, 1.62–1.64
- KK2186 *E. coli* strain  
 genotype, A3.8  
 M13 vectors and, 3.13
- Klenow buffer, 9.20, A1.10
- Klenow fragment, 1.84–1.85, 9.82–9.86, 12.101–12.102, A4.15–A4.17  
 5'-3' exonuclease activity, A4.17  
 5'-3' polymerase activity, A4.16  
 activity, measurement of, 12.102  
 in BAL 31 mutagenesis protocol, 13.65  
 in cDNA probe production, 9.46, 9.49–9.50  
 in cDNA second-strand synthesis, 11.14  
 digoxigenin labeling of nucleic acids, A9.38–A9.39  
 in DNA sequencing, 12.40–12.44  
 asymmetric labeling, 12.72  
 materials for, 12.41–12.42  
 method, 12.42–12.43  
 reaction mixtures, table of, 12.41  
 secondary structure problems, 12.44  
 troubleshooting, 12.44
- end labeling, A4.15–A4.16  
 for chemical sequencing of DNA, 12.73  
 in cosmid vectors, 4.33  
 modified nucleotide use in end-labeling, 9.53
- error rate, 9.83, 12.102
- exchange reaction, A4.17
- in exonuclease III mutagenesis protocol, 13.57, 13.61
- filling-in recessed 3' termini, 9.83–9.84, 12.101–12.102
- inactivation of, 9.23
- labeling 3' termini, 9.51–9.56, 9.83–9.85, 12.101
- labeling of oligonucleotides, 10.30–10.34  
 diagram of scheme, 10.31  
 primers for, 10.31–10.33  
 protocol, 10.33–10.34  
 strand separation, 10.32
- labeling single-stranded DNA by random priming, 9.85
- in misincorporation mutagenesis, 13.80
- model of DNA bound to, 9.84
- modified nucleotide use in end-labeling, 9.53
- in oligonucleotide-directed mutagenesis of single-stranded DNA, 13.15–13.17
- partial filling of cosmid termini, 4.15
- polishing ends, 12.17
- in probe production for nuclease S1 mapping of RNA, 7.58
- properties, table of compared, A4.11
- in radiolabeling for gel retardation assays, 17.16
- in random priming reactions, 9.5, 9.7, 9.11
- replacement by other polymerases, 12.102
- Sequenase compared, 12.32
- single-stranded probe production, 9.19–9.23, 9.27  
 by primer extension, 9.85  
 uses, list of, A4.15–A4.16  
*in vitro* mutagenesis and, 12.102
- Klentaq, 8.77–8.78, 8.85  
 in circular mutagenesis, 13.20  
 in cycle sequencing reactions, 12.46–12.47  
 structure of, 12.47
- $Km^R$ . *See* Kanamycin resistance
- Knock-out, gene, 1.15
- KOH/Methanol solution, A1.20
- Kox1, 17.56
- Kozak sequence, 17.96
- KpnI*, A4.9  
 cleavage at end of DNA fragments, A6.4
- KS promoter, primer sequence for, 8.117
- Kunkel method, 13.84
- KW251 *E. coli* strain  
 genotype, A3.8  
 $\lambda$  vector propagation, 2.28
- Kyoto Encyclopedia of Genes and Genomes (KEGG) database, A10.15
- L40, 18.22
- Labeled avidin-biotin (LAB) technique, A9.33
- Labeling. *See* DNA probes; Nonradioactive labeling; Radiolabeled probe preparation; RNA, probes
- Labeling buffer, 17.24
- lac* operon in M13, 3.8–3.10
- lac* promoter  
 for eukaryotic expression vectors, 11.72  
 for expression of cloned genes in *E. coli*, 15.3, 15.15–15.19  
 in pET expression vectors, 15.21  
 primer sequence for, 8.117  
*trp-lac* promoter, 15.3
- lac* repressor, 15.18, 15.57. *See also lac*<sup>R</sup>
- lac*<sup>R</sup>, 11.23–11.24, 11.66  
 in IPTG-inducible expression vectors, 15.15–15.16, 15.18  
 $\lambda$  propagation and, 2.28–2.29  
 in  $\lambda$ ZAP, 14.6  
 M13 vectors and, 3.10, 3.12–3.13  
 in plasmid expression vectors, 14.14  
 in pMAL vectors, 15.40
- lac-proAB* in M13 vectors, 3.10, 3.12–3.13
- lacZ*, 1.10, 1.27, 17.97. *See also*  $\beta$ -galactosidase  
 in BAC vectors, 4.3  
 $\alpha$ -complementation, 1.149–1.150  
 in expression vectors, 14.47–14.48  
 fusion proteins, 15.57–15.59  
 disadvantages, 15.58  
 inclusion bodies, 15.58  
 vectors for, 15.59  
 in  $\lambda$  vectors, 2.30, 11.22, 11.25  
 in  $\lambda$ gt11 vector, 11.111

- in M13, 3.8–3.10  
 in pUC vectors, 3.9  
 as screening marker in  $\lambda$  recombinants, 2.21  
 Shine-Dalgarno sequence, 15.57  
 in two-hybrid system of protein-protein interaction reporter plasmids, 18.17, 18.22, 18.24
- lacZ* $\Delta$ M15  
 $\lambda$  propagation and, 2.29  
 M13 vectors and, 3.10, 3.12–3.13
- Ladders. *See* Molecular-weight markers
- LALIGN program, A11.4
- LALIGNO program, A11.4
- lamB* gene, 2.4, 11.62  
 glucose repression of, 2.35, 2.37  
 maltose induction of, 2.26
- lamB* receptor,  $\lambda$  adsorption to, 2.15
- $\lambda$ 2001, 2.20–2.22, A3.3
- $\lambda$  Annealing buffer, A1.20
- $\lambda$  bacteriophage, 2.1–2.111. *See also* Cosmids;  $\lambda$  vectors
- arm purification by sucrose density gradient, 2.71–2.75  
 ligation first method, 2.73  
 materials, 2.72  
 method, 2.73–2.75  
 concatemers, 2.68, 2.70  
 concentration of doubled-stranded DNA in solution, A6.5
- DNA extraction  
 DNA concentration, calculating, 2.58  
 from large-scale cultures  
 using formamide, 2.59–2.60  
 using proteinase K and SDS, 2.56–2.58  
 particle purification for, 2.54–2.55
- DNA purification, 5.71–5.73  
 from liquid cultures, 2.106–2.108  
 miscellaneous methods, 2.104  
 from plate lysates, 2.101–2.104  
 polysaccharide removal by precipitation with CTAB, 2.105
- exonuclease, 11.121, A4.49
- expression vectors, 4.83
- genomic organization, 2.3–2.4, 2.5
- infection phases  
 late lytic  
 DNA packaging, 2.14–2.15  
 DNA replication, 2.11  
 lysis, 2.15  
 particles, assembly of, 2.14–2.15  
 recombinant systems, 2.11–2.13  
 transcription, late, 2.14  
 lysis/lysogeny crossroads, 2.7–2.11  
 lysogeny, 2.15–2.18  
 integration, 2.16  
 transcription of prophage genes, 2.17–2.18  
 temperature and, 2.4, 2.18  
 uncommitted phase  
 adsorption, 2.4  
 transcription, delayed early, 2.6–2.7  
 transcription, immediate early, 2.6
- in vitro packaging, 11.113–11.114
- libraries, screening by PCR, 8.76
- map, physical and genomic, 2.5
- molecular-weight marker ladder, 5.59
- overview of, 2.2–2.3
- P2 prophage restriction of growth, 2.20
- plaques  
 $\beta$ -galactosidase screening, 2.31  
 macroplaques, 2.31  
 number per dish, table of, 2.92  
 picking, 2.32–2.33  
 screening by PCR, 8.74–8.75  
 size, 2.30  
 smearing, 2.30  
 storage, 2.33  
 long-term, 2.36
- plating, 2.25–2.31  
 $\beta$ -galactosidase plaque-assay, 2.30  
 macroplaque protocol, 2.31  
 protocol  
 bacteria preparation, 2.26–2.27  
 infection of plating bacteria, 2.27–2.30  
 materials, 2.25–2.26
- promoters, 2.5–2.8, 2.14, 2.17, 15.4, 15.25–15.29
- propagation, *E. coli* strains for, 2.28–2.29
- purification, particle  
 centrifugation through glycerol step gradient, 2.52–2.53  
 isopycnic centrifugation through CsCl gradient, 2.47–2.51  
 pelleting/centrifugation, 2.54–2.55
- repressor, 2.8, 2.10–2.11, 2.14, 2.17–2.18, 2.21, 2.23  
 inactivation, 14.7  
 in positive selection vectors, 1.12  
 temperature-sensitive, 1.13, 14.37–14.38, 14.40, 14.47, 15.4, 15.25, 15.27–15.28
- shotgun sequencing protocol, 12.10–12.22
- specialized transduction, 2.17
- stock preparation  
 DNA content, assaying by gel electrophoresis, 2.45–2.46  
 large-scale  
 infection at high multiplicity, 2.42  
 infection at low multiplicity, 2.40–2.42  
 liquid culture, small-scale, 2.38–2.39  
 plate lysis and elution, 2.34–2.36  
 plate lysis and scraping, 2.37  
 precipitation of particles, 2.43–2.44  
 yield, factors influencing, 2.35, 2.37
- structure of, 2.3  
 terminase, 2.15, 4.5, 4.30
- $\lambda$ clI, 11.109
- $\lambda$  DE3, 15.20–15.21
- $\lambda$  EMBL vectors, A3.3
- $\lambda$ DASH vector, 2.20–2.22, A3.3
- $\lambda$ ExCell vector  
 in commercial kits for cDNA synthesis, 11.108  
 expression cloning, 11.72
- $\lambda$ EXlox vector, 4.83
- $\lambda$ FIX vector, 2.22, A3.3
- $\lambda$ gt10 vector, 11.25, A3.3  
 amplification of libraries constructed in, 11.64–11.65  
 cDNA library construction in, 11.59–11.60  
 in commercial kits for cDNA synthesis, 11.108  
 overview, 11.111  
 plaque formation with, 11.62  
 primers for, 8.116
- $\lambda$ gt11 vector, 2.22–2.23, 11.25, 11.27  
 amplification of libraries constructed in, 11.65–11.66  
 cDNA library construction in, 11.59  
 in commercial kits for cDNA synthesis, 11.108  
*E. coli* strain for amplification of cDNA libraries, 11.66  
 fusion protein expression in, 14.37, 14.39, 14.43, 14.45  
 immunological screening of libraries in, 14.2  
 overview, 11.111  
 plaque formation with, 11.62  
 primers for, 8.116
- $\lambda$ gt11-23 vector, A3.3
- $\lambda$ gt18-23 vector  
 cDNA library construction in, 11.59  
*E. coli* strain for amplification of cDNA libraries, 11.66  
 expression libraries and, 14.47–14.48  
 fusion protein expression in, 14.37  
 immunological screening of libraries in, 14.2  
 plaque formation with, 11.62
- $\lambda$ gt18-23 vectors, 2.22–2.23
- $\lambda$ gt20 vector, 11.66
- $\lambda$ gt22 vector, 11.66
- $\lambda$ ORF8 vector and expression libraries, 14.47–14.48
- $\lambda$  *p*<sub>L</sub> promoter  
 for expression of cloned genes in *E. coli*, 15.4, 15.25–15.29  
 large-scale expression, 15.29  
 materials for, 15.26–15.27  
 optimization, 15.28  
 overview, 15.25  
 protocol, 15.27–15.29  
 tryptophan-inducible expression, 15.26, 15.28–15.29  
 vectors containing, 15.25
- $\lambda$  *p*<sub>R</sub> promoter, 14.14
- $\lambda$ TriplEx2 in commercial kits for cDNA synthesis, 11.108
- $\lambda$  vectors. *See also specific vectors*  
 amber mutations, A7.5  
 amplification of libraries constructed in, 11.64–11.66  
 cDNA cloning, 11.17–11.18, 11.21–11.26  
 $\lambda$ gt10/ $\lambda$ gt11, 11.25, 11.27  
 $\lambda$ ZAP, 11.22  
 $\lambda$ ZAP Express, 11.22–11.25  
 $\lambda$ ZAPII, 11.22–11.23  
 $\lambda$ ZipLox, 11.25–11.26  
 library construction, 11.59–11.61  
 choosing, 2.20  
 cloning in, flow chart for, 2.24  
 Cre-*loxP* in, 4.83  
 dephosphorylation of arms, 11.59  
 DNA preparation  
 alkaline phosphatase treatment, 2.68–2.70  
 arm purification, 2.71–2.75  
 cleaved with single restriction enzyme, 2.61–2.63  
 cleaved with two restriction enzyme, 2.64–2.67  
 digestion efficiency, monitoring, 2.66–2.67  
*E. coli* strain preferences for plating, 11.62  
 expression vectors, 2.12–2.23  
 immunological screening of libraries in, 14.2  
 immunity vectors, 2.21  
 insertion vectors, 2.19, 2.21
- libraries  
 amplification, 2.87–2.89  
 construction, 2.20, 11.51–11.61  
 expression libraries, screening, 14.4–14.13, 14.47–14.49  
 bacteriophage recovery from filters, 14.11  
 chemiluminescent screening, 14.11–14.12  
 chromogenic screening, 14.9–14.11  
 for DNA-binding proteins, 14.31–14.36  
 duplicate filter preparation, 14.8  
 eukaryotic, 11.72–11.73, 11.76–11.78  
 expression induction on filters, 14.7–14.8  
 fusion protein production, 14.37–14.46  
 materials for, 14.4–14.6  
 plating bacteriophage, 14.7  
 protein-expressing plaques, 14.8–14.12  
 radiochemical screening, 14.9  
 troubleshooting, 14.13  
 validation of clones, 14.12  
 ligation of  $\lambda$  arms to insert fragments, 2.84–2.86  
 partial digestion of DNA for, 2.76–2.83  
 screening by PCR, 2.33, 8.76  
 markers for selection or screening, table of, 2.21  
 overview, 2.18–2.23  
 packaging, 2.63, 2.65, 2.67, 2.84–2.86, 2.110–2.111  
 amplification of genomic libraries, 2.87–2.89  
 cosmids, 4.21–4.22  
 direct screening, 2.87  
 efficiency, 2.67–2.68, 2.110

- λ* vectors (continued)  
 preparation methods, 2.111  
 partial digestion of DNA for  
 pilot reaction, 2.76–2.79  
 preparative reaction, 2.80–2.83  
 primers for cloning in, 8.116  
 propagation, *E. coli* strains for, 2.28–2.29  
 recombinants  
 DNA minipreparation from liquid cultures,  
 2.106–2.107  
 DNA minipreparation from plate lysates,  
 2.101–2.104  
 PCR analysis, 2.105  
 replacement vectors, 2.19–2.22, 2.64–2.65  
 ligation of arms to genomic DNA fragments,  
 2.84–2.86  
 screening by hybridization  
 DNA transfer to filters, 2.90–2.95  
 hybridization protocol, 2.96–2.100  
 size of DNA inserted, 2.85  
 subcloning YAC DNAs into, 4.64  
 table of, A3.3  
 templates for DNA sequencing, 12.29  
*λ*YES vectors, 4.83  
*λ*ZAP vector, 2.101, 11.22  
 amplification of libraries constructed in, 11.65–  
 11.66  
 cDNA library construction in, 11.59  
*E. coli* strain for amplification of cDNA libraries,  
 11.66  
 expression libraries, 14.47–14.48  
 fusion protein expression in, 14.37, 14.47  
 immunological screening of libraries in, 14.2  
 plaque formation with, 11.62  
*λ*ZAP-CMV vector  
 in commercial kits for cDNA synthesis, 11.108  
 expression cloning, 11.72  
*λ*ZAP Express vector, 11.22–11.25, A3.3  
*E. coli* strain for amplification of cDNA libraries,  
 11.66  
 expression cloning, 11.72  
 expression libraries, 14.47–14.48  
 immunological screening of libraries in, 14.2  
*λ*ZAPH vector, 11.22, 11.23  
*E. coli* strain for amplification of cDNA libraries,  
 11.66  
 expression libraries and, 14.47–14.48  
 immunological screening of libraries in, 14.2  
 plaque formation with, 11.62  
*λ*ZipLox vector, 2.101, 4.83, 11.25–11.26, A3.3  
 amplification of libraries constructed in, 11.65–  
 11.66  
 cDNA library construction in, 11.59  
 in commercial kits for cDNA synthesis, 11.108  
*E. coli* strain for amplification of cDNA libraries,  
 11.66  
 expression cloning, 11.72  
 expression libraries, 14.47–14.48  
 fusion protein expression in, 14.37, 14.47  
 plaque formation with, 11.62  
 Langmuir-binding model, 18.112–18.113  
 Lanthanum oxybromide intensifying screens, A9.11  
 Large DNA molecules. *See also* Chromosomal DNA;  
 Genomic DNA  
 CHEF gels, 5.79–5.82  
 cloning products and services, 4.86  
 concentration by dialysis on sucrose bed, 6.15  
 concentration measurement of, 6.11, 6.15  
 fragmentation by hydrodynamic shearing, 2.76,  
 6.3  
 gel electrophoresis, difficulty entering the gel  
 during, 6.15  
 isolation from mammalian cells  
 by spooling, 6.16–6.18  
 using formamide, 6.13–6.15  
 using proteinase K and phenol, 6.4–6.11  
 minimizing damage to, 2.110  
 partial digestion for genomic libraries  
 checking, 2.79  
 methods, 2.76  
 pilot reactions, 2.76–2.79  
 preparative reactions, 2.80–2.83  
 pulsed-field gel electrophoresis  
 recovery from gels, 5.83–5.88  
 separation by, 5.2, 5.55–5.56, 5.59–5.60  
 recovery  
 from low-melting point agarose, 5.33–5.35  
 from pulsed-field gel electrophoresis gels,  
 5.83–5.88  
 spermine/spermidine use, 5.86  
 sucrose gradients, size fractionation through,  
 2.82–2.83  
 transfection of eukaryotic cells, calcium-phos-  
 phate-mediated, 16.21–16.24  
*N*-lauroylsarcosine  
 for solubilization of glutathione *S*-transferase  
 fusion proteins, 15.38–15.39  
 for solubilization of inclusion bodies, 15.54  
 LB freezing buffer, A1.20, A2.6  
 LB medium recipe, A2.2  
 I. buffer, 5.61, 5.64, 5.66–5.67  
 Lck, 18.7  
 LE392 *E. coli* strain, A7.5  
 genotype, A3.8  
*λ* vector propagation, 2.28  
 LEU2, 18.35, 18.37  
 Leucine  
 codon usage, A7.3  
 nomenclature, A7.7  
 properties, table of, A7.9  
 Leucine zipper, 11.33  
 Leupeptin, 17.25, 18.67, A5.1  
 Levan sucrose, 4.37  
 LexA, 18.14  
 bait-LexA fusion protein, 18.17–18.29  
 fusion plasmids, 18.18  
*lexAop-lacA* reporter gene, 18.17  
*lexAop-lacZ* reporter, 18.30, 18.32, 18.36  
*lexAop-LEU2*, 18.17, 18.22, 18.36  
 LFASTA program, A11.4  
 LG90 *E. coli* strain genotype, A3.8  
 L-histidinol, 17.61, 17.63–17.67, 17.69  
 Libraries. *See also* cDNA libraries; Expression  
 libraries, screening; Genomic libraries; *λ*  
 vectors, libraries  
 arrayed libraries, 4.8, 4.39, 4.50, 4.61, 9.90  
 screening for related genes using MOPAC, 8.68  
 LiCl. *See* Lithium chloride  
 LIC-PCR. *See* Ligation-independent cloning  
*lig* gene, 1.159  
 Ligase, DNA, A4.30–A4.34. *See also* Ligation reac-  
 tions  
 bacteriophage T4, 1.157–1.158, 3.37, A4.31–  
 A4.32, A4.34  
 activity of, A4.31  
 blunt-end ligation, A4.32  
 cohesive termini/nick ligation, A4.32  
 linker/adaptor attachment to cDNA, 11.54  
 uses, list of, A4.31  
*E. coli*, 1.158–1.159, A4.33  
 in cDNA second strand synthesis, 11.43,  
 11.45–11.46  
*λ*, 2.3  
 overview, 1.157  
 table of properties, 1.158  
 thermostable, 1.158, A4.34  
 units of activity, 1.159  
 Ligase, T4 RNA ligase, 1.157  
 Ligase amplification reaction, 1.157, 1.159  
 Ligation buffer with polyethylene glycol, 5.71  
 Ligation reactions  
 adaptor attachment to protruding termini, 1.89  
 in BAL 31 mutagenesis protocol, 13.66  
 cDNA  
 into *λ* vectors, 11.61  
 linker/adaptor attachment to, 11.51–11.55  
 into plasmid vectors, 11.63  
 in circular mutagenesis protocol, 13.24  
 condensing and crowding agents, 1.23–1.24,  
 1.152, 1.157–1.159  
 in cosmid vectors, 4.15, 4.21–4.22  
 dephosphorylation of plasmid DNA and, 1.93  
 in directional cloning procedures, 1.84–1.85,  
 1.87  
 DNA fragments with blunt ends, 1.22–1.24,  
 1.90–1.92  
 DNA fragments with protruding ends, 1.20–1.21  
 in exonuclease III mutagenesis protocol, 13.61  
 fragment ratios, 1.21  
 inhibition  
 by agarose, 5.18, 5.29  
 by dATP, 1.85  
 by TBE buffer, 5.30  
 in inverse PCR protocol, 8.84  
*λ* arms to insert genomic DNA, 2.84–2.86  
 linker addition to blunt-ended DNA, 1.99–1.102  
 in low-melting-temperature agarose, 1.103–  
 1.104, 5.29  
 M13 vectors, 3.36–3.37  
 oligonucleotide ligation assay (OLA), 13.96  
 PCR product cloning  
 blunt-end cloning, 8.33–8.34  
 controls, inclusion of, 8.41  
 directional cloning, 8.40  
 T vector cloning, 8.36  
 ratio of components, 1.90–1.91  
 restriction enzyme inclusion into, 1.100  
 in shotgun sequencing protocol, 12.15, 12.18–  
 12.19, 12.25  
 in USE mutagenesis, 13.28  
 Ligation-independent cloning, 11.121–11.124  
 LightCycler, 8.95  
 Lightning Plus intensifying screens, A9.11  
 Line elements, 11.95  
 LINE (long interspersed nuclear element)  
 sequences, 4.75  
 Linear amplification DNA sequencing. *See* Cycle  
 DNA sequencing  
 Linear polyacrylamide as carrier in ethanol precipi-  
 tation of DNA, A8.13  
 Linker kinase buffer, A1.11  
 Linkers. *See also* Adaptors  
 addition to blunt-ended DNA, 1.98–1.102  
 cDNA cloning, 11.20–11.21, 11.51–11.55  
 checking reaction products, 1.102  
 in direct selection of cDNAs protocol, 11.102  
 ligation, 1.99–1.102  
 phosphorylation of, 1.99, 1.101  
 sequences, table of, 1.99  
 Linker-scanning mutagenesis, 13.75–13.77  
 LipofectAce, 16.5, 16.11  
 Lipofectamine, 16.5, 16.11  
 Lipofectin (*N*[1-(2,3-dioleoyloxy)propyl]-*n,n,n*-  
 trimethylammonium chloride [DOTMA]),  
 16.5, 16.7–16.8, 16.11–16.12  
 Lipofection, 11.85, 16.3, 16.7–16.13  
 chemistry of, 16.50  
 lipids used in, 16.8, 16.11, 16.51  
 materials for, 16.7–16.11  
 optimizing, 16.51  
 overview of, 16.50–16.51  
 protocol, 16.12–16.13  
 Liposomes formation by sonication, 16.7  
 LipoTaxi, 16.5  
 Liquid chromatography-tandem MS (LC-MS/MS),  
 18.66  
 Liquid Gold, 1.105  
 Liquid media for *E. coli*, A2.2–A2.4

- Liquid nitrogen  
 for tissue preparation in RNA purification protocols, 7.10–7.11  
 in tissue sample homogenization, 6.7–6.8
- Lithium chloride (LiCl), 1.59, A1.27  
 in column-loading buffers, 7.16  
 in ethanol precipitation of nucleic acids, A8.12  
 precipitation of contaminating nucleic acid fragments, 1.59, 1.82–1.83  
 precipitation of large RNAs with, A8.16  
 in transcriptional run-on assay protocol, 17.28
- LMT elution buffer, 5.30
- Loading buffers. *See* Gel-loading buffers
- Locus Link database, A10.15
- lon, 2.7, 11.66, 14.6, 14.39, 14.47–14.48, 15.19, 15.58
- Long PCR buffer, 8.78, 13.21
- Low-melting-temperature agarose. *See* Agarose, low-melting-temperature
- loxP. *See also* Cre-loxP recombination system  
 in BAC vectors, 4.3  
 in  $\lambda$  vectors, 4.83  
 in P1 vectors, 4.4–4.5, 4.37, 4.82–4.83  
 sequence, 4.82–4.83
- luc gene, 17.96
- Luciferase, 17.42–17.47, 17.96  
 bacterial, A9.23–A9.24  
 dual reporter assay system, 17.96  
 firefly, A9.21–A9.23  
 assays for, A9.22–A9.23  
 liquid scintillation spectroscopy, A9.22–A9.23  
 luminometry, A9.22  
 photographic/X-ray film, A9.23  
 properties of, A9.21–A9.22  
 as reporter molecule, A9.23  
 peroxisome targeting of, 17.96  
 reaction catalyzed by, 17.96  
 as reporter gene, 17.30–17.31, 17.42–17.47  
 advantages of, 17.42  
 luminometer measurements from 96-well plates, 17.47  
 materials for, 17.44  
 methods, 17.45–17.47  
 optimizing measurement, 17.45  
 pGL3 vectors, 17.43  
 scintillation counting protocol, 17.46  
 as transfection-positive control, 16.4
- Luciferase assay buffer, 17.44
- Lucigenin, structure of, A9.17
- Lumi-Gal, 17.50
- Lumigen-PPD, 9.79
- Luminol, 9.79, 14.11, 14.21  
 in enzyme assays, A9.19–A9.20  
 horseradish peroxidase and, A9.35–A9.37  
 as immunoassay label, A9.18  
 structure of, A9.16
- Luminometers, 17.42, 17.45–17.47  
 bioluminescence and, A9.21–A9.22  
 chemiluminescence and, A9.20
- luxA gene, A9.23–A9.24
- luxB gene, A9.23–A9.24
- LXI-Blue MRF *E. coli* strain,  $\lambda$  vector propagation in, 2.28
- Lysine  
 codon usage, A7.3  
 properties, table of, A7.9
- Lysis buffers  
 Alkaline lysis solutions I, II and III, 1.32–1.33, 1.35–1.36, 1.38, 1.40, 3.24, 12.31, A1.16  
 for DNA isolation from mammalian cells grown in microtiter plates, 6.19  
 for DNase I hypersensitivity mapping, 17.19  
 extraction/lysis buffers, A1.16  
 in genomic DNA isolation from mouse tails, 6.24–6.26  
 for mammalian DNA isolation, 6.4, 6.6–6.7, 6.9
- PCR lysis solution, 6.22  
 for rapid isolation of mammalian DNA, 6.28–6.29  
 for rapid isolation of yeast DNA, 6.31–6.32  
 red blood cells, 6.28–6.29  
 in reporter assay protocols, 17.36, 17.38  
 in screening expression library protocol, 14.15–14.18  
 SNET, 6.24–6.25  
 in transcriptional run-on assay protocol, 17.24  
 yeast lysis buffer, 5.66
- Lysogen extraction buffer, 14.38
- Lysogeny  
 induction, 2.9  
 in  $\lambda$ , 2.3, 2.9–2.11, 2.15–2.18
- Lysozyme, A1.8, A4.51  
 for cell lysis prior to affinity chromatography, 15.38, 15.46  
 discovery of, 1.153  
 in *E. coli* lysate preparation for affinity chromatography, 14.29  
 inhibition of T7 RNA polymerase, 9.88, 15.21, 15.24  
 in M13 RF DNA preparation, 3.24  
 overview, 1.153  
 in plasmid DNA preparation protocols  
 alkaline lysis with SDS, 1.33, 1.36  
 boiling lysis, 1.43–1.45, 1.49  
 lysis with SDS, 1.57  
 in washing solution for inclusion bodies, 15.10
- Lyticase, 5.66–5.67, A1.8  
 yeast cell wall digestion, 4.60
- M9 medium recipe, A2.2
- M13 bacteriophage, 1.11, 3.1–3.49. *See also* M13 vectors  
 adsorption to sex pili, 3.5  
 DNA capacity of, 3.7  
 DNA preparation  
 double-stranded (replicative form), 3.23–3.25  
 large-scale, 3.30–3.33  
 single-stranded, 3.26–3.29  
 uracil-substituted DNA, 13.11–13.14  
 DNA purification, 12.21–12.23  
 blunt-ended, dephosphorylated DNA for shotgun cloning, 12.24  
 small numbers of single-stranded templates, 12.23  
 genetic map of, 3.3  
 growing in liquid culture, 3.20–3.22  
 morphogenesis, 3.5–3.6  
 phage display, 18.3  
 plaques  
 picking, 3.22, 12.21  
 type, 3.2, 3.17  
 plating, 3.17–3.19  
 precipitation with polyethylene glycol, 3.26–3.28  
 proteins encoded, 3.2–3.7  
 functions of, 3.4  
 replication, 3.2, 3.5–3.7  
 site-specific mutagenesis, 8.42  
 structural model of, 3.7  
 transcription, 3.5  
 uracil-substituted DNA, preparation of, 13.11–13.14
- M13 vectors, 3.8–3.16, A3.5  
 analysis of clones, 3.39–3.41  
 screening by hybridization, 3.41  
 size analysis by electrophoresis, 3.39–3.41  
 bacterial host for, 3.10–3.16  
 cloning problems, strain-dependent, 3.11, 3.16  
 F plasmid, maintaining, 3.11  
 markers, 3.10–3.11  
 strain, choosing and maintaining, 3.11–3.16  
 table of, 3.12–3.13
- cloning  
 locations  
 gene X, 3.9–3.10  
 large intergenic region, 3.9  
 multiple cloning sites, table of, 3.14  
 small intergenic region, 3.9  
 materials, 3.35–3.36  
 methods  
 dephosphorylation of vector DNA, 3.34  
 forced (directional cloning), 3.34  
 ligation of insert into linearized vector, 3.34  
 protocol, 3.36–3.38  
 transformation reactions, 3.37–3.38  
 deletions and rearrangements, limiting, 3.33–3.34, 3.49  
 growth times, 3.49  
 history of, 3.8  
 insert size, 3.33  
 nested deletion mutant set creating, 13.57, 13.59–13.61  
 oligonucleotide-directed mutagenesis protocol, 13.15–13.18  
 overview, 3.8–3.10  
 phagemids, 3.42–3.49  
 primers for cloning sites in, 8.115  
 screening clones for site-directed mutagenesis, 13.40–13.46  
 in shotgun sequencing protocol, 12.19–12.25  
 dephosphorylated, blunt-ended DNA preparation, 12.24  
 DNA purification, 12.21–12.24  
 growth in 96-tube format, 12.19–12.21  
 single numbers of templates, preparing, 12.23  
 test ligations, 12.25  
 subcloning YAC DNAs into, 4.64
- M13-100 vector, 3.9–3.10
- M13K07 vector, 3.42, 3.44–3.47, 18.116
- M13KE vector, 18.118, 18.120
- M13mp series vectors, 3.8–3.9, 3.14
- M5219 *E. coli* strain, 15.4, 15.25, 15.27, A3.8
- MACAW (Multiple Alignment construction and Analysis Workbench) program, A11.7
- Macroplaque,  $\lambda$ , 2.31
- MaeI cleavage of 7-deaza-dGTP modified DNA, 8.60
- Magic Minipreps, 12.27
- Magnesium chloride  
 MgCl<sub>2</sub>·6H<sub>2</sub>O solution, A1.27  
 MgCl<sub>2</sub>·CaCl<sub>2</sub> solution, A1.21  
 in Sequenase reaction buffer, 12.33
- Magnesium ions  
 DNase I and, 17.6, 17.10–17.11, 17.75, A4.40–A4.41  
 exonuclease III and, 13.73  
 inhibition of *EcoRI* methylase by, 11.48  
 in M13 growth media, 12.21, 12.23  
 in PCRs, 8.5–8.6, 8.21, 8.110  
 PEG stimulation of DNA ligation and, 1.152
- Magnesium sulfate (MgSO<sub>4</sub>), A1.27
- Magnetic beads  
 overview, 11.118–11.120  
 streptavidin-coated, 7.20  
 uses for, table of, 11.120
- MalE, 15.7, 15.40  
 affinity purification of fusion proteins, 15.4  
 soluble fusion protein production, 15.9
- Maltoporin,  $\lambda$  adsorption to, 2.4
- Maltose, A1.27, A2.8  
 induction of *lamB* gene, 11.62  
 for  $\lambda$  growth, 2.26  
 in  $\lambda$  media, 11.62
- Maltose-binding fusion proteins, 14.47, 15.26  
 affinity chromatography purification, 15.6, 15.40–15.43



- Mammalian cells. *See also* COS cells  
 codon usage, 10.7  
 Cre-loxP site-specific integration/excision of transgenes, 4.84–4.85  
 DNA isolation  
 concentration measurement  
 by fluorometry, 6.12  
 by spectrophotometry, 6.11, 6.15  
 from microtiter plate cultures, 6.19–6.22  
 from mouse tails  
 harvesting of tails, 6.24  
 one-tube isolation, 6.26–6.27  
 from paraffin blocks, 6.27  
 protocol, 6.23–6.25  
 sample storage, 6.24  
 without extraction by organic solvents, 6.26  
 from paraffin blocks, 6.27  
 for pulsed-field gel electrophoresis, 5.61–5.64  
 rapid isolation protocol, 6.28–6.30  
 by spooling, 6.16–6.18  
 using formamide, 6.13–6.15  
 using proteinase K and phenol, 6.4–6.11  
 100–150-kb DNA size, 6.10, 6.11  
 150–200-kb DNA size, 6.10–6.11  
 lysis of blood cells, 6.8–6.9  
 lysis of monolayer cells, 6.6  
 lysis of suspension cells, 6.7  
 lysis of tissue samples, 6.7–6.8  
 expression in. *See* Expression in mammalian cells  
 glycerol and efficiency of transient expression and transformation, 13.90  
 nuclear extract preparation from, 17.8–17.10, 17.26–17.27  
 RNA isolation from, 7.7, 7.11  
 poly(A)<sup>+</sup> selection by batch chromatography, 7.18–7.19  
 poly(A)<sup>+</sup> selection by oligo(dT) chromatography, 7.13–1.17  
 transfection, 16.1–16.57  
 biolistics, 16.3, 16.37–16.41  
 materials for, 16.38–16.39  
 method, 16.39–16.41  
 particle types, 16.37  
 variables, 16.37  
 calcium-phosphate-mediated, 16.3, 16.14–16.26, 16.52–16.53  
 of adherent cells, 16.25  
 of cells growing in suspension, 16.26  
 chloroquine treatment, 16.14, 16.17, 16.52  
 cotransformation, 16.24  
 efficiency, factors affecting, 16.52  
 with genomic DNA, 16.21–16.24  
 glycerol shock, 16.14, 16.17, 16.52  
 high efficiency, 16.19  
 mutation prevalence, 16.53  
 with plasmid DNA, 16.14–16.20  
 sodium butyrate, 16.14, 16.17–16.18  
 cell line variation, 16.57  
 controls, 16.4–16.5  
 for stable expression, 16.4–16.5  
 for transient expression, 16.4  
 cotransformation, 16.24, 16.47  
 by DEAE-dextran, 16.3, 16.27–16.32  
 calcium phosphate method compared, 16.27  
 cell viability, increasing, 16.32  
 facilitators of, 16.28  
 kits, 16.30  
 materials for, 16.29–16.30  
 mechanism of action, 16.27  
 method, 16.30–16.31  
 mutation prevalence, 16.28, 16.53  
 variables, 16.27–16.28  
 electroporation, 16.3, 16.33–16.36, 16.54–16.57  
 efficiency, factors influencing, 16.33–16.34, 16.57  
 materials for, 16.34–16.35  
 method, 16.35–16.36  
 by lipofection, 16.3, 16.7–16.13  
 chemistry of, 16.50  
 lipids used in, 16.8, 16.11, 16.51  
 materials for, 16.7–16.11  
 optimizing, 16.51  
 overview of, 16.50–16.51  
 protocol, 16.12–16.13  
 methods, summary of, 16.3  
 polybrene, 16.3, 16.43–16.46  
 stable, selective agents for, 16.48–16.49  
 tetracycline regulation of inducible gene expression and, 17.60–17.70  
 transient vs. stable, 16.2  
 transformation by YACs, 4.63–4.64  
 trypsinization, 16.12  
 vector systems for, 11.72  
 Mammalian Transfection Kit Primary ENHANCER Reagent, 16.5  
 Mammalian vectors, A3.3–A3.4  
 Manganese chloride (MnCl<sub>2</sub>) in Sequenase reaction buffer, 12.43  
 Manganese ions  
 DNase I and, A4.40–A4.41  
 exonuclease III and, 13.73  
 Mannose phosphotransferase, 2.4  
 Mapping  
 DNase I hypersensitivity sites, 17.18–17.22  
 identical-by-descent (IBD), A10.17–A10.18  
 influence of methylation on DNA mapping, A4.6–A4.9  
 mutations with RNase A, A4.39  
 protein-binding sites on DNA  
 by DNase I footprinting, 17.4–17.11  
 by hydroxyl radical footprinting, 17.12  
 MAR-Finder program, A11.13  
 Markers  
 chemiluminescent, 1.140, 2.98–2.99  
 migration rate of dyes through polyacrylamide gels, 12.89  
 molecular-weight. *See* Molecular-weight markers  
 Mass map, 18.66  
 Mass spectrometry, 18.3, 18.62, 18.66  
 MAST (Motif Alignment and Search Tool) program, A11.9–A11.10  
 MAT $\alpha$ , 18.22  
 Matrix-assisted laser desorption-time of flight (MALDI-TOF) mass spectrometry, 18.66  
 Maxam-Gilbert sequencing. *See* DNA sequencing, chemical method  
 MAXIscript, 9.32  
 MBM7014.5 *E. coli* strain  
 genotype, A3.8  
 $\lambda$  vector propagation, 2.28  
 Mbol  
*dam* methylation and, 13.87, A4.3  
 genomic DNA digestion, 4.11, 4.15, 4.20  
 Mbol methylase, A4.7  
 MbolII, A4.9  
*dam* methylation and, 13.87, A4.3  
 methylase, A4.7  
 for T vector creation, 8.35  
 MBS Mammalian transfection kit, 16.5  
 MC1061 *E. coli* strain, 1.118  
 genotype, A3.8  
 $\lambda$  vector propagation, 2.28  
 transformation by Hanahan method, 1.106  
*mcr* restriction system, 11.21, 11.48  
 in vitro  $\lambda$  packaging and, 2.111, 11.113  
*mcrA*, 1.15, A4.4–A4.5  
 $\lambda$  propagation and, 2.28  
 M13 vectors and, 3.11, 3.13  
*mcrB*, A4.4  
 $\lambda$  propagation and, 2.28–2.29  
 MDE (mutation detection enhancement), 13.51, 13.53, 13.56  
 Media, A2.1–A2.2. *See also specific media; specific protocols*  
 agar/agarose containing, A2.5  
 antibiotics, A2.6–A2.7  
 bacteriophage  $\lambda$ -related, A2.8  
 liquid media for *E. coli*, A2.2–A2.4  
 storage, A2.6  
 yeast propagation and selection, A2.9–A2.11  
 Medline, 1.14  
 Megaprimer method of mutagenesis, 13.8–13.10, 13.31–13.35  
 MEGAscript, 9.32  
 Melting temperature  
 calculating, 10.2–10.4, 10.47–10.48  
 guessers and, 10.8  
 inosine and, 10.9–10.10  
 of megaprimers in mutagenesis protocol, 13.31–13.32  
 in quaternary alkylammonium salts, 10.6  
 Membrane Expression arrays, A10.9  
 MEME (Multiple Expectation Maximization for Motif Elicitation) program, A11.8–A11.9  
 MERMAID, 10.49  
 MES (2-[N-morpholino]ethane-sulfonic acid), 1.105, 1.107  
 Metal chelate affinity chromatography, 15.44–15.48  
 Metallothionein promoter, 16.5  
 Methanol  
 methanol/KOH solution, A1.20  
 for polyacrylamide gel fixation, 12.90–12.92  
 Methionine  
 cleavage by cyanogen bromide, 15.6, 15.8  
 codon usage, A7.3  
 nomenclature, A7.7  
 properties, table of, A7.9  
 in pulse-chase experiments, 15.18–15.19  
 Methotrexate (MTX), 16.47, 16.49, A2.7  
 Methylated DNA, *E. coli* strains for propagation of, 1.15–1.16  
 Methylation, 11.21, A4.3–A4.9  
 of cDNA, 11.48–11.50  
 5' methyldeoxycytosine incorporation, 11.48  
 EcoRI, 11.48–11.50  
 in chemical sequencing protocol, 12.61–12.65  
*dam* methyltransferase, A4.3  
*dcm* methyltransferase, A4.3–A4.4  
 by dimethylsulfate, 12.5  
 DNA mapping, influence on, A4.6–A4.9  
 linker use and, 1.99  
 restriction site modification, A4.5–A4.9  
 restriction/modification systems, type I and type II, A4.4  
 Methylation interference assays, 12.63  
 Methylene blue, A9.4–A9.5  
 polyacrylamide gel staining, 5.47–5.48  
 staining of RNA on nylon membranes, 7.39  
 Methylmercuric hydroxide, 7.21–7.22, 11.9  
 4-Methylumbelliferyl- $\beta$ -D-galactoside (MUG), 17.50, 17.97–17.98  
 Met-MEME program, A11.9  
 5-Methylcytosine, 12.68, A4.4  
 MFOLD program, A11.14–A11.15  
 Mg<sup>2+</sup>. *See* Magnesium ions  
 Microarray, DNA. *See* DNA array technology  
 MicroArray Suite image analysis program, A10.13  
 Microconcentrator, 8.27–8.29, 8.58, 8.68, 12.106, A8.16–A8.17  
 Microcon concentrators, 8.27, 12.106, A8.16–A8.17  
 Microinjection of live cells, 18.88–18.89  
 MicroMax arrays, A10.9  
 Microscopy. *See* Fluorescence lifetime imaging microscopy  
 Microspheres. *See* Magnetic beads

- Microtiter plates  
 DNA isolation from mammalian cells grown in, 6.19–6.22  
 use in DNA sequencing protocols, 12.100
- Milk as blocking agent, A8.54
- Mineral oil  
 addition to PCRs, 8.22  
 removal from PCRs by chloroform extraction, 8.22
- Minigels, agarose, 5.13
- Minimal (M9) agar plates for M13 plating, 3.17–3.18
- Minimal medium for bacteria, 18.40
- MisMatch Detect II, 13.93
- Mismatch repair system, 13.88, 13.94
- Mitomycin C  
 induction of  $\lambda$  lysogen, 15.25  
 modes of action, A2.7
- Mixed oligonucleotide-primed amplification of cDNA (MOPAC), 8.66–8.71  
 analysis, 8.70–8.71  
 band-stab PCR and, 8.71  
 DNA template for, 8.68–8.70  
 materials for, 8.69  
 method, 8.70–8.71  
 primer design rules, 8.67–8.68  
 screening for related genes, 8.68  
 variations in protocol, 8.67
- Mful  
 cleavage at end of DNA fragments, A6.4  
 genomic DNA mapping, 5.69  
 methylation, A4.7
- MLV (murine leukemia virus). *See* Moloney murine leukemia virus reverse transcriptase
- MM294 *E. coli* strain, 1.14–1.15, 1.25  
 genotype, A3.8  
 $\lambda$  vector propagation, 2.28  
 transformation by Hanahan method, 1.106
- Mn<sup>2+</sup> ions. *See* Manganese ions
- mob, 1.146
- Mobility of DNA, electrical, 12.114
- Modeling, molecular, 18.3
- Modrich-Lehman unit of ligase activity, 1.159
- Molecular modeling, 18.3
- Molecular modeling database (MMDB), A11.22
- Molecular-weight markers, 5.10, 7.23, A6.4  
 $\lambda$  DNA concatamers, 5.59, 5.71–5.73  
 migration rate of dyes through polyacrylamide gels, 12.89  
 for pulsed-field gel electrophoresis, 5.59–5.60, 5.71–5.73  
 for RNA gels, 5.59–5.60, 5.71–5.73
- Moloney murine leukemia virus (Mo-MLV) reverse transcriptase, 11.109–11.110, A4.24–A4.25  
 in commercial kits for cDNA synthesis, 11.108  
 inhibition by sodium pyrophosphate, 11.46  
 RNA-dependent DNA polymerase, 8.48  
 RNase H<sup>-</sup>, 11.38
- Mo-MLV. *See* Moloney murine leukemia virus reverse transcriptase
- Monoclonal antibodies in immunological probes, 11.33
- Monolayer cultures, lysis of cells growing in, 6.6
- Monophasic lysis reagents, 7.10–7.12
- MOPAC. *See* Mixed oligonucleotide-primed amplification of cDNA
- MOPS electrophoresis buffer, 7.32, A1.18
- MOPS salts, 15.31
- Mouse mammary tumor virus long terminal repeat promoter, 16.5
- Mouse tails, genomic DNA isolation from  
 harvesting of tails, 6.24  
 one-tube isolation, 6.26–6.27  
 from paraffin blocks, 6.27  
 protocol, 6.23–6.25  
 sample storage, 6.24  
 without extraction by organic solvents, 6.26
- Mouse-tail lysis buffer, 6.26
- Mowiol mounting medium, 18.87–18.88
- mp18/mp19, 8.115
- mRNA. *See also* Expression in mammalian cells; RNA  
 3'-RACE procedure and, 8.61  
 5'-RACE procedure and, 8.54–8.55, 8.58  
 cDNA cloning. *See* cDNA cloning  
 cDNA library construction  
 expression library, 11.70  
 from small numbers of cells, 11.112  
 cDNA preparation, 11.39–11.42  
 enrichment methods, 11.8–11.11  
 fractionation of cDNA, 11.9–11.10  
 fractionation of mRNA, 11.9  
 number of clones needed for library, 11.8  
 overview, 11.8–11.9  
 polysome purification, 11.10  
 subtractive cloning, 11.10–11.11  
 integrity of mRNA, 11.7–11.8, 11.39, 11.42  
 source of mRNA, 11.6–11.7  
 differential display-PCR, 8.96–8.106  
 differential expression, screening for, 9.89–9.91
- eukaryotic  
 concentration, measurement  
 northern blots, 7.66  
 quantitative RT-PCR, 7.66  
 reassociation kinetics, 7.65–7.66  
 ribonuclease protection, 7.66  
 mapping  
 mung bean nuclease, 7.55  
 nuclease S1, 7.51–7.62  
 primer extension, 7.75–7.81  
 ribonuclease protection assays, 7.63–7.74  
 northern hybridization. *See* Northern hybridization  
 overview, 7.2  
 purification  
 acid phenol-guanidinium thiocyanate-chloroform extraction, 7.4–7.8  
 poly(A) selection by patch chromatography, 7.18–7.19  
 poly(A) selection by oligo(dT)-cellulose chromatography, 7.13–7.17  
 poly(A) selection by poly(U)-Sephacose chromatography, 7.15, 7.20  
 poly(A) selection by streptavidin-coated beads, 7.20  
 simultaneous preparation with DNA and protein, 7.9–7.12  
 RNases and, 7.2  
 isolation from COS-7 cells, 11.87–11.88
- mapping  
 3'-RACE, 8.61–8.62  
 5'-RACE, 8.54–8.55  
 for microarray hybridization, A10.10, A10.13–A10.14  
 reverse transcription by RT-PCR, 8.46–8.53  
 screening with subtracted cDNA probes, 11.29–11.31  
 splicing, 18.123–18.124  
 stability and G+C content, A7.2
- mrr, 1.15–1.16, A4.4  
 in vitro  $\lambda$  packaging and, 2.111, 11.113  
 M13 vectors and, 3.11, 3.13
- MS2 phage, 18.11
- MSA program, A11.6
- MseI, A4.9
- MspI in site-directed mutagenesis protocol, 13.84
- MspI methylase, A4.5, A4.7
- MTX. *See* Methotrexate
- MultAlin program, A11.8
- Multichannel pipettor, 6.20
- Multiplex PCR, 8.5, 8.107  
 nonspecific amplification, 8.107  
 optimizing, 8.107
- MultiPROBE II (Packard), A10.5
- Mung bean nuclease, 7.55, 7.86, A4.47  
 in exonuclease III mutagenesis protocol, 13.57, 13.74–13.75  
 overview of, 7.87
- MunI cleavage at end of DNA fragments, A6.4
- Munich 13. *See* M13
- Muristerone A, 17.71
- Muta-gene in vitro mutagenesis kit, 13.89
- Mutagenesis  
 alanine-scanning, 13.81  
 BAL 31 use, 13.62–13.67  
 bisulfite-mediated, A4.41  
 cassette, 13.79  
 chemical, 13.78–13.79  
 circular, 13.19–13.25  
 of coding sequences, 13.2–13.4  
 oligonucleotide-directed, 13.3–13.7  
 saturation mutagenesis, 13.2–13.3  
 scanning mutagenesis, 13.3  
 deletion mutants  
 bidirectional sets, 13.62–13.67  
 nested sets, 13.57–13.61, 13.74–13.75  
 exonuclease III use, 13.57–13.61  
 in vitro, 12.102, 13.19–13.25  
 kits for, 13.89  
 Kunkel method, 13.84  
 linker-scanning, 13.75–13.77  
 misincorporation, 13.80  
 oligonucleotide-directed  
 elimination of unique restriction site, 13.26–13.30  
 oligonucleotide design guidelines, 13.82  
 overview of, 13.3–13.7  
 design, 13.4  
 diagram of scheme, 13.5  
 history of, 13.4–13.7  
 methods of, 13.4  
 steps in, 13.6  
 random mutations using spiked primers, 13.80  
 selection of mutants with *DpnI*, 13.19–13.25, 13.84–13.85  
 of single-stranded DNA, 13.15–13.18  
 troubleshooting, 13.18  
 uracil-substituted DNA preparation, 13.11–13.14  
 USE mutagenesis, 13.26–13.30, 13.85  
 PCR-mediated, 13.7–13.10  
 random, 13.78–13.80  
 cassette mutagenesis, 13.79  
 chemical mutagenesis, 13.78–13.79  
 misincorporation mutagenesis, 13.80  
 with spiked oligonucleotide primers, 13.80  
 of regulatory regions, 13.2  
 screening by  
 conformational polymorphism and heteroduplex analysis, 13.49–13.56  
 hybridization to radiolabeled probe, 13.40–13.47  
 PCR, 13.48  
 site-directed  
 alanine-scanning mutagenesis, 13.81  
 codon usage, changing, 15.12  
 commercial kits for, 13.89  
 inverse PCR, deletion introduction by, 8.42  
 Kunkel method, 13.84  
 M13, 8.42  
 mutagenic oligonucleotide for, 13.82–13.83  
 oligonucleotide-directed, 13.3–13.7, 13.11–13.30, 13.84–13.85  
 PCR end modification protocol, 8.42–8.45  
 PCR-mediated

- Mutagenesis (*continued*)
- megaprimer method, 13.8–13.10, 13.31–13.35
  - overlap extension, 13.8, 13.36–13.39
  - overview, 13.7–13.10
  - polymerase choice for, 13.20–13.21
  - restriction site creation/removal, 13.82–13.83, 13.85
  - screening
    - by conformational polymorphism and heteroduplex analysis, 13.49–13.56
    - by hybridization to radiolabeled probe, 13.40–13.46
    - by PCR, 13.48
    - phagemid-containing colonies by hybridization, 13.47
  - selection *in vitro*, 13.84–13.87
    - DpnI* destruction of parentals, 13.19–13.25, 13.84
    - phosphorothioate analog incorporation, 13.86–13.87
    - unique restriction site elimination, 13.26–13.30, 13.85
    - uracil-DNA glycosylate destruction of parentals, 13.84–13.85
  - selection *in vivo*, 13.87
- Mutagenesis buffer, 13.21
- Mutan-Express Km Kit, 13.89
- Mutation detection, 13.91–13.96
- allele-specific oligonucleotides (ASO), 13.91, 13.95
  - amplification refractory mutation system (ARMS), 13.91, 13.96
  - arrays, mutation detection, A10.3
  - bidirectional dideoxy fingerprinting (Bi-ddF), 13.91, 13.94
  - CDI modification, 13.95
  - chemical cleavage of mismatched bases (CCM), 13.91, 13.95
  - competitive oligonucleotide priming (COP), 13.91, 13.96
  - denaturing gradient gel electrophoresis (DGGE), 13.91, 13.92
  - dideoxy fingerprinting (ddF), 13.91, 13.94
  - with DNA mismatch repair enzymes, 13.94
  - oligonucleotide ligation assay (OLA), 13.91, 13.96
  - primer extension, 13.91, 13.96
  - protein truncation test (PTT), 13.92
  - with resolvases, 13.94
  - restriction endonuclease fingerprinting (REF), 13.91, 13.94
  - RFLP/PCR, 13.91, 13.95
  - scanning vs. specific methods, 13.91
  - single-stranded conformational polymorphism (SSCP), 13.91, 13.93
- Mutation detection enhancement. *See* MDE
- Mutations
- amber, A7.5
  - conditional, A7.5
  - temperature-sensitive, A7.5
- mutS*, 13.29–13.30, 13.85, 13.87
- mutY*, 13.94
- MV1184 *E. coli* strain, 13.47
- genotype, A3.8
  - M13 vectors and, 3.13
  - phagemids and, 3.42, 3.44, 3.46
- MV1190 *E. coli* strain
- genotype, A3.8
  - phagemids and, 3.46
- MV1193 *E. coli* strain genotype, A3.8
- MV1304 *E. coli* strain, phagemids and, 3.46
- MvaI* methylase, A4.7
- Mycophenolic acid, 16.49
- MZ-1, *E. coli* strain genotype, A3.8
- MZEF (Michael Zhang's exon finder) program, A11.12
- NaCl. *See* Sodium chloride
- NaeI*
- fragment size created by, table of, A4.8
  - methylation, A4.7
  - site frequency in human genome, 4.16, A6.3
- Nalidixic acid induction of  $\lambda$  lysogen, 15.25
- Nanogenchips, A10.19
- NaOH. *See* Sodium hydroxide
- NarI*
- fragment size created by, table of, A4.8
  - methylation, A4.7
  - site frequency in human genome, 4.16, A6.3
- NA stop/storage buffer, 9.6, 9.9
- National Center for Biotechnology Information (NCBI), A11.2, A11.22
- NBT. *See* Nitroblue tetrazolium
- NciI* in phosphorothioate incorporation mutagenesis, 13.86
- NcoI*
- cleavage at end of DNA fragments, A6.4
  - linker sequences, 1.99
- NdeI*, 1.99, A4.9
- NdeII*, A4.9
- Nebulization of DNA, 12.11, 12.14, 12.16–12.17, A8.37–A8.38
- calibration of nebulizer, A8.37–A8.38
- NENSorb, 10.49
- Neomycin, 17.74, A2.7
- Neomycin resistance marker in YACs, 4.64
- Nested deletion mutant, generating with exonuclease III, 13.57–13.61, 13.74–13.75
- NetGene program, A11.11
- NETN, 18.67–18.68
- Neutralization buffer/solution, 10.38
- for alkaline agarose gels, 5.37
  - for alkaline transfer of DNA to nylon membranes, A1.13
  - for neutral transfer, double-stranded DNA targets only, A1.13
  - in Southern hybridization, 6.41, 6.43
  - for transfer of DNA to uncharged membranes, A1.13
- NF-1 nuclear factor, 17.8, 17.11
- nflA*, *E. coli* gene, 2.7
- nflB*, *E. coli* gene, 2.7
- N* gene,  $\lambda$ , 2.6–2.9, 15.25
- NgoM* IV cleavage at end of DNA fragments, A6.4
- NheI*
- cleavage at end of DNA fragments, A6.4
  - fragment size created by, table of, A4.8
  - linker sequences, 1.99
  - site frequency in human genome, 4.16, A6.3
- NHS (*N*-hydroxysuccinimide), 18.104–18.105
- $\text{Ni}^{2+}$  absorption chromatography, 15.44–15.48
- elution with imidazole, 15.47
  - generation of resin, 15.48
- nic* site, 1.146
- Nick translation
- biotin labeling of genomic clones, 11.102
  - digoxigenin labeling of nucleic acids, A9.38–A9.39
  - DNA polymerase and, 9.85–9.86
  - history of, 9.12
  - kits, 9.13
  - optimizing reactions, 9.13
  - procedure, 9.12–9.13
  - random priming compared, 9.4
  - using *E. coli* DNA polymerase, A4.12
- Nick translation buffer, 11.100
- NIH-3T3 cells, 17.60–17.67
- nin* (*N*-independent) mutants,  $\lambda$ , 2.7
- Nitric acid, A1.6
- Nitrotriacetate (NTA)- $\text{Ni}^{2+}$ -agarose, 15.46
- Nitroblue tetrazolium (NBT), 9.78, 14.9–14.10, 14.20, A9.39–A9.42
- Nitrocellulose membranes, 1.28. *See also*
- Hybridization
  - amplification of bacteriophages on, 2.95
  - amplification of cosmid libraries, 4.31–4.32
  - baking, 2.94, 6.46
  - colorimetric detection of nonradioactive probes on, 9.78
  - denaturing DNA on, 2.94
  - disadvantages of, 6.37–6.38
  - DNA transfer. *See also* Southern hybridization, DNA transfer methods
    - electrophoretic, 6.36
    - from plaques to filters, 2.91, 2.93–2.95
    - vacuum transfer, 6.37
  - fixing DNA to, 2.94–2.95
  - gluing to 3MM paper, 2.99
  - for immunological screening, 11.32, 14.6–14.13, 14.17–14.22, A8.53
  - in  $\lambda$  library screening by PCR protocol, 8.76
  - lysis of colonies and binding of DNA, 1.136
  - for microarray applications, A10.6–A10.7
  - in northern hybridization, 7.23–7.24
  - nylon filters compared, 2.91
  - probe removal from, in Southern hybridizations, 6.57
  - properties of, 6.38
  - reagents for detection of antibody-antigen complex, 14.3
  - RNA binding to, 6.37
  - screening
    - bacterial colonies by hybridization, 1.126–1.134
    - bacterial DNA with radiolabeled probe, 1.138–1.142
    - cosmid libraries by hybridization, 4.24–4.27
    - expression libraries by labeled probes, 14.31–14.36
    - storage of, 6.37–6.38
    - in transcriptional run-on assay hybridizations, 17.28–17.29
    - wetting, 6.44, 6.49
  - p*-nitrophenyl phosphate, A9.41–A9.42
  - Nitrosomethylurea use in M13 vector creation, 3.8
  - Nitrous acid, mutagenesis from, 13.78
  - NM519 *E. coli* strain
    - genotype, A3.8
    - $\lambda$  vector propagation, 2.28
  - NM522 *E. coli* strain
    - genotype, A3.9
    - $\lambda$  vector propagation, 2.29
    - M13 vectors and, 3.13
  - NM531 *E. coli* strain
    - genotype, A3.9
    - $\lambda$  vector propagation, 2.28
  - NM538 *E. coli* strain
    - genotype, A3.9
    - $\lambda$  vector propagation, 2.28
  - NM539 *E. coli* strain
    - genotype, A3.9
    - $\lambda$  vector propagation, 2.29
  - NM554 *E. coli* strain
    - for cosmid stability, 4.28
    - genotype, A3.9
  - N*-methylimidazole (NMI), 10.42
  - NNPP (promoter prediction by neural network) program, A11.12
  - Nonidet P-40
    - in cell lysis buffers, 17.36
    - in coimmunoprecipitation solutions, 18.67
    - in DNA sequencing reactions, 12.38, 12.55
    - in homogenization buffer, 17.9, 17.26
    - in PCR lysis solution, 6.22
    - in supershift assays, 17.17
  - Nonisotopic RNase cleavage assay (NIRCA), 13.93
  - Nonradioactive labeling, 9.76–9.81
    - biotin, 9.76–9.79
    - detection after hybridization, 9.78–9.80

- chemiluminescence, 9.79–9.80  
 colorimetric assays, 9.78–9.79  
 fluorescent assays, 9.79
- digoxigenin, 9.77  
 enzymatic methods, 9.77–9.78  
 fluorescein, 9.77  
 indirect detection systems, 9.76  
 photolabeling, 9.78  
 switching to, 9.80–9.81
- Northern hybridization  
 background, 7.45  
 cDNA library screening, 11.38  
 at low stringency, 6.58  
 low-stringency, 7.43  
 membranes used for, 6.37  
 nonradioactive labeling and, 9.76, 9.80  
 overview of, 7.21–7.26  
 protocol, 7.42–7.44  
 quantitating RNA by, 7.66  
 ribonuclease protection assay compared, 7.63–7.65  
 RNA fixation to membranes, 7.35–7.36, 7.39–7.40  
 RNA separation by size  
 electrophoresis of glyoxylated RNA, 7.27–7.30  
 equalizing RNA amounts in gels, 7.22–7.23  
 formaldehyde-agarose gels, 7.31–7.34  
 markers used in gels, 7.23, 7.29  
 overview, 7.21–7.22  
 pseudomessages as standards, 7.23  
 RNA transfer to membranes, 7.25–7.26, 7.35–7.41  
 membranes used for, 7.23–7.25  
 protocols, 7.35–7.41  
 staining of RNA on membranes, 7.39  
 steps involved, list of, 7.21  
 stripping blots, 7.44  
 troubleshooting, 7.45
- NotI  
 cDNA linkers and adaptors and, 11.20, 11.51, 11.64  
 in cDNA synthesis kits, 11.71  
 cleavage at end of DNA fragments, 8.38, A6.4  
 fragment size created by, table of, A4.8  
 genomic DNA mapping, 5.60, 5.68–5.69  
 linker sequences, 1.99  
 methylation, A4.7  
 site frequency in human genome, 4.16, A6.3
- Novobiocin, A2.7
- NruI  
 genomic DNA mapping, 5.69  
 methylation, A4.7
- NS3516 *E. coli* strain genotype, A3.9  
 NS3529 *E. coli* strain genotype, A3.9  
 NsiI cleavage at end of DNA fragments, A6.4  
 NTA-Ni<sup>2+</sup>-agarose, 15.46  
 regeneration of, 15.48
- Nu1 gene,  $\lambda$ , 2.4, 2.15  
 Nu1 protein,  $\lambda$ , 2.14
- Nuclear extracts  
 preparation from cultured cells, 17.9–17.10  
 preparation from tissues, 17.8–17.9
- Nuclear polyhedrosis viruses (NPVs), 17.81
- Nuclear run-on assays, 17.23. *See also* Transcriptional run-on assays
- Nuclease S1, A4.46  
 digestion buffer, 7.56, 7.60, A1.11  
 digestion of hairpins, 11.46  
 in exonuclease III mutagenesis protocol, 13.57, 13.59–13.61, 13.74–13.75  
 exonuclease VII results compared, 7.86  
 hairpin digestion, 11.4, 11.16  
 inactivation, 13.61  
 mapping of RNA, 7.51–7.62  
 5' and 3' mRNA termini, 7.53  
 artifacts, 7.54–7.55
- diagrams of, 7.52–7.53  
 digestion conditions, 7.61  
 probes, 7.51–7.55  
 protocol, 7.55–7.62  
 analysis by gel electrophoresis, 7.61–7.62  
 digestion of DNA-RNA hybrids, 7.60–7.61  
 dissolving nucleic acid pellets, 7.60  
 hybridization of probe and test RNA, 7.59, 7.60  
 materials for, 7.55–7.57  
 probe preparation, 7.58–7.59  
 probe purification by gel electrophoresis, 7.59–7.60  
 troubleshooting, 7.55  
 overview of, 7.86  
 ribonuclease protection assay compared, 7.65  
 source of, 7.86  
 stop mixture, 7.56, 13.58
- Nucleases, A4.38–A4.49. *See also* BAL 31 nuclease; Exonuclease III; Nuclease S1  
 bacteriophage  $\lambda$  exonuclease, A4.49  
 BAL 31, A4.43–A4.45  
 DNase I, A4.40–A4.42  
 exonuclease III, A4.47–A4.48  
 mung bean, A4.47  
 RNase A, A4.39  
 RNase H, A4.38  
 RNase T1, A4.39  
 S1, A4.46
- Nuclei  
 harvesting for DNase I hypersensitivity mapping, 17.20–17.21  
 isolation  
 from cultured cells, 17.26  
 from tissue, 17.27  
 radiolabeling transcription, 17.27–17.28  
 Nuclei wash buffer, 17.25
- Nucleic acid database and structure resource, A11.21
- Nucleic acid fragment removal  
 by centrifugation through NaCl, 1.78–1.79  
 by chromatography, 1.80–1.81  
 by precipitation with LiCl, 1.82–1.83
- Nucleobond AX, 1.64
- Nucleoside analogs used as chain terminators in DNA sequencing (Table A6-11), A6.10
- Nucleosomes, DNase I hypersensitivity sites and, 17.18
- NusA, 2.7, 2.14  
 NusB, 2.7  
 NusG, 2.7  
*nut* site,  $\lambda$ , 2.7
- Nylon membranes. *See also* Hybridization  
 advantages of, 6.38  
 amplification of cosmid libraries, 4.31–4.32  
 baking, 7.35–7.36, 7.39–7.40  
 biotinylated probe adherence to, 9.76  
 brand differences, 2.91  
 charged vs. neutral, 7.37, 7.39  
 chemiluminescent assays, 9.79, A9.19, A9.43–A9.44  
 colorimetric detection of nonradioactive probes on, 9.78  
 denaturing DNA on, 2.94  
 dot and slot blotting of RNA, 7.46–7.50  
 intensity of signal, measuring, 7.47  
 sample application, 7.46  
 fixing DNA to, 2.94–2.95, 6.46  
 fixing RNA to, 7.36, 7.39–7.40  
 gluing to 3MM paper, 2.99  
 history of, 7.24  
 hybridization at high temperatures, 1.141  
 for immunoblotting, A8.53  
 lysis of colonies and binding of DNA, 1.131, 1.136  
 neutral vs. charged, 6.38, 7.25, 7.35
- nitrocellulose compared, 2.91  
 northern hybridization, 7.24–7.25, 7.35–7.41  
 fixation of RNA, 7.35–7.36, 7.39–7.40  
 transfer to charged membranes at alkaline pH, 7.35  
 transfer to neutral membranes, 7.35–7.36  
 properties of, 6.38, 7.25  
 screening bacterial colonies by hybridization, 1.126–1.134  
 screening cosmid libraries by hybridization, 4.24–4.27
- Southern hybridization  
 fixation of DNA to membrane, 6.45–6.46  
 probe removal from, 6.57  
 transfer protocol, 6.43–6.45, 6.49  
 stripping, A9.38, A9.42  
 transfer of DNA to. *See also* Southern hybridization, DNA transfer methods  
 electrophoretic, 6.36  
 from plaques to filters, 2.91, 2.93–2.95  
 vacuum, 6.37  
 UV irradiation fixation of nucleic acids, 6.46, 7.36, 7.39–7.40  
 wetting, 7.38, 7.41
- NZCYM medium, 11.62, A2.3  
 NZM medium recipe, A2.3  
 NZYM medium recipe, A2.3
- o*-dianisidine, 14.3, A9.34
- OFAGE (orthogonal field agarose gel electrophoresis), 5.55. *See also* Pulsed-field gel electrophoresis
- O* gene,  $\lambda$ , 2.6, 2.8–2.9, 2.11
- Oligo(dT) primers  
 in cDNA probe production, 9.42–9.43  
 for cDNA synthesis, 11.12–11.13, 11.15, 11.39  
 linked to plasmid, 11.12
- Oligo(dT)-cellulose, 7.13–7.17, 7.19–7.20
- Oligonucleotide  
 elution buffer, 10.12  
 hybridization solution, 10.35, 13.41  
 labeling buffer, 9.10  
 ligation assay (OLA), 13.91, 13.96  
 prehybridization solution, 10.35, 10.38, 13.41  
 purification cartridges (OPCs), 10.49
- Oligonucleotide-directed mutagenesis  
 efficiency of, 13.83  
 elimination of unique restriction site, 13.26–13.30  
 oligonucleotide design, guidelines for, 13.82–13.83  
 overview of, 13.3–13.7  
 design, 13.4  
 diagram of scheme, 13.5  
 history of, 13.4–13.7  
 methods of, 13.4  
 steps in, 13.6  
 phosphorothioate incorporation, 13.86–13.87  
 random mutations using spiked primers, 13.80  
 selection of mutants with *DpnI*, 13.19–13.25, 13.84–13.85  
 of single-stranded DNA, 13.15–13.18  
 troubleshooting, 13.18  
 uracil-substituted DNA preparation, 13.11–13.14  
 USE mutagenesis, 13.26–13.30, 13.85
- Oligonucleotide primers. *See also* Oligonucleotide-directed mutagenesis  
 cDNA probe construction  
 oligo(dT) primer, 9.42–9.43, 9.47  
 random primers, 9.39–9.40, 9.48–9.49  
 for cDNA synthesis, 11.12–11.15, 11.39  
 oligo(dT), 11.12–11.13, 11.15  
 random, 11.12–11.15  
 second-strand, 11.17–11.20  
 commonly used (Table A6-12), A6.11  
 converting molarities to units of weight, 12.103

- Oligonucleotide primers (*continued*)  
 design, computer program for, 13.83  
 for DNA sequencing, 12.6–12.7, 12.27–12.28, 12.35, 12.41–12.42, 12.48–12.49, 12.52–12.55, 12.60  
 dye primers, 12.96  
 energy transfer (ET) primers, 12.96  
 stock solution preparation, 12.103  
 in exon trapping/amplification protocol, 11.90–11.93, 11.96  
 gel purification, need for, 12.103  
 molecular-weight calculation, formula for, 8.20, 8.50  
 oligonucleotide-directed mutagenesis, 13.4, 13.6–13.10, 13.16–13.17, 13.19–13.20, 13.26–13.30  
 in PCR, 8.4–8.5, 8.18  
 3'-RACE, 8.61–8.65  
 5'-RACE, 8.54–8.60  
 annealing conditions, 8.8–8.9  
 concentration of, 8.5  
 degenerate pools, 8.66–8.71, 8.113  
 design, 8.13–8.16  
 differential display-PCR, 8.96, 8.99–8.101, 8.103, 8.105  
 extension of primers, 8.9  
 guessmers, 8.66–8.67  
 inosine use in degenerate pools, 8.113  
 inverse PCR, 8.81–8.85  
 ligation-independent cloning, 11.121–11.124  
 linker-scanning mutagenesis, 13.76–13.77  
 long PCR, 8.79  
 MOPAC, 8.66–8.71  
 multiplex PCR, 8.5, 8.107  
 purification of, 8.5, 8.18  
 quantitative PCR, 8.90–8.92  
 restriction site addition to 5' termini, 8.31, 8.37–8.39  
 universal, 8.113–8.117  
 PCR-mediated mutagenesis, 13.31–13.34, 13.36–13.39  
 in primer extension assays, 7.75–7.76, 7.78–7.79  
 promoters of RNA polymerases, adding to DNA fragments, 9.37  
 purification, 7.76  
 in radiolabeled probe production  
 PCR, 9.15–9.18  
 random priming, 9.5–9.7, 9.10  
 single-stranded probes from M13, 9.19–9.22, 9.26  
 removal by ultrafiltration, 8.27–8.29  
 for reverse transcriptase use, A4.25–A4.26  
 for RT-PCR, 8.46–8.48  
 oligo(dT), 8.46–8.48  
 random hexamers, 8.47–8.48  
 spiked, 13.80  
 universal primers, 8.113–8.117  
 for  $\lambda$ gt10/ $\lambda$ gt11, 8.116  
 for M13 vectors, 8.115  
 for pBR322, 8.114  
 for pUC vectors, 8.115  
 transcription promoter primers, 8.117  
 Oligonucleotide probes, 10.1–10.49  
 biotin labeling, 11.117  
 cDNA screening with, 11.31–11.32  
 degenerate pools, 11.31  
 guessmers, 11.31  
 universal bases, 11.32  
 in competition assays, 17.17  
 degenerate pools, 10.5–10.6  
 extinction coefficient, calculating, 10.13–10.14  
 guessmers, 10.6–10.9  
 design, 10.7  
 hybridization conditions, 10.8  
 melting temperature, 10.8  
 mixtures of, 10.7–10.8  
 PCR compared, 10.9  
 labeling with Klenow fragment, 10.30–10.34  
 length of, 10.4–10.5  
 melting temperatures, 10.2–10.4, 10.6, 10.8, 10.47–10.48  
 empirical measurement, 10.38–10.41  
 double-stranded DNA, 10.40–10.41  
 single-stranded DNA, 10.40  
 in TMAcI buffers, 10.36  
 phosphorylation of 5' termini, 10.17–10.19  
 efficiency of transfer, measuring, 10.19  
 materials, 10.17–10.18  
 protocol, 10.18–10.19  
 purification  
 chromatography, 10.49  
 HPLC, 10.49  
 polyacrylamide gel electrophoresis, 10.11–10.16  
 detection in gels, 10.16  
 eluting DNA, 10.15  
 materials, 10.12–10.13  
 protocol, 10.13–10.16  
 Sep-Pak C<sub>18</sub>, 10.15–10.16  
 by polyacrylamide gel electrophoresis, 10.48–10.49  
 resolution, 10.14, 10.33, 10.49  
 precipitation with CPB, 10.22–10.24  
 precipitation with ethanol, 10.20–10.21  
 purification cartridges, 10.49  
 reversed-phase chromatography, 10.11, 10.15–10.16, 10.49  
 Sep-Pak C<sub>18</sub> chromatography, 10.28–10.29  
 size-exclusion chromatography, 10.25–10.27  
 of tritylated, 10.49  
 quantifying by OD, 10.13  
 quaternary alkylammonium salts, 10.6, 10.35–10.37  
 screening expression libraries, 14.2, 14.31–14.36  
 synthesis, 10.1, 10.42–10.46  
 monitoring, 10.42  
 phosphodiester method, 10.42  
 phosphoramidite chemistry, 10.42  
 protecting groups, table of, 10.43  
 steps involved, diagrams of, 10.44–10.45  
 yield estimates, table of, 10.46  
 universal bases, 10.9–10.10  
 uses for, 10.2  
 Oligonucleotides. *See also* Adaptors; Linkers; Oligonucleotide primers; Oligonucleotide probes; Oligonucleotide-directed mutagenesis  
 molecular conversions for (Table A6-13), A6.11  
 purification from polyacrylamide gels by crush and soak method, 5.51  
 spectrophotometry, A8.20, A8.21  
 OMPF protein, 17.53  
*ompT* mutation, 15.19  
 1089 *E. coli* strain, fusion protein preparation in, 14.41  
 ONPG (*o*-nitrophenyl- $\beta$ -D-galactopyranoside), 17.50–17.51, 17.97–17.98  
 OOTFD (Object-Oriented Transcription Factor Database), A11.20  
*O*-phenylenediamine dihydrochloride (OPD), A9.35  
 Oregon Green, 8.94–18.95, 18.80, 18.90, A9.33  
*oriC*, 13.88, A4.3  
 Origin of replication, 1.3, 1.4. *See also* Replicons  
*dam* methylation and, 13.88  
*fl*, 17.35, 17.49  
 locating by linker-scanning mutagenesis, 13.75  
*oriC*, 13.88, A4.3  
 in p $\beta$ -gal vectors, 17.49  
 in pCAT3 vectors, 17.35  
 polyomavirus, 11.69  
 from single-stranded bacteriophages, 1.11  
 SV40, 11.69, 11.114, 17.49  
 yeast artificial chromosome, 4.2  
 Origin of transfer (*oriT*), 1.146  
*oriS* in BACs, 4.48  
 Osmium tetroxide, 13.91, 13.95  
 Osmotic shock for release of proteins from periplasmic space, 15.40, 15.43  
 Ovens, hybridization, 6.51  
 Overhangs, DNA. *See* Protruding termini  
 Overlap extension mutagenesis, 13.8, 13.36–13.39  
<sup>32</sup>P  
 chemiluminescence compared, A9.16  
 decay data, A9.15  
 in far western screens, 18.48  
 particle spectra, A9.9–A9.10  
 sensitivity of autoradiographic methods for detection, A9.13  
<sup>33</sup>P  
 decay data, A9.15  
 particle spectra, A9.9–A9.10  
 sensitivity of autoradiographic methods for detection, A9.13  
 P1 artificial chromosomes (PACs), 4.4  
 advantages/disadvantages, 4.40  
 choosing for genomic library construction, 4.7–4.10  
 DNA purification, 4.42–4.45  
 Human PAC Library, 4.9  
 overview, 4.40  
 vectors, A3.5  
 P1 bacteriophage  
 Cre-*loxP* system, 4.82–4.83  
 history of, 4.35  
 life cycle of, 4.36  
 P1 bacteriophage vectors, 4.35–4.47, A3.5  
 advantages/disadvantages, 4.40  
 amplification, 4.36, 4.42  
 arrayed libraries, 4.8  
 cloning into vectors, 4.37–4.39  
 design of vectors, 4.35–4.37  
 DNA preparation/purification, 4.42–4.45  
 by chromatography, 4.45  
 by drop dialysis, 4.44  
 protocol, 4.42–4.43  
 electroporation, 4.46–4.47  
 genomic libraries  
 arrayed, 4.39  
 choosing for construction of, 4.7–4.10  
 screening, 4.39–4.40  
 overview, 4.4  
 packaging, 4.7, 4.37, 4.82  
 transduction, 4.46  
 P2 prophage, restriction of  $\lambda$  growth, 2.20  
 P3 buffer (Qiagen), A1.21  
 p15A replicon, 1.4  
 p53 GeneChip array, 10.9  
 P450 GeneChip array, A10.9  
 PAC. *See* P1 artificial chromosomes (PACs)  
*pacA* gene, 4.37  
*PacI*  
 cleavage at end of DNA fragments, A6.4  
 fragment size created by, table of, A4.8  
 genomic DNA mapping, 5.68–5.69  
 site frequency in human genome, 4.16, A6.3  
 Packaging  
 cosmids, 4.21–4.22, 4.30  
 in vitro packaging, 2.111, 11.113–11.114  
 $\lambda$  vectors, 2.63, 2.65, 2.67, 2.84–2.89, 2.110–2.111  
 P1 bacteriophage vectors, 4.7, 4.37, 4.82  
 Packard MultiPROBE II, A10.5  
 pACYC, 1.1.4, A3.2  
 pAd10*sacBII*, 4.4, A3.5  
 concentration of double-stranded DNA in solution, A6.5  
 features of, 4.37–4.38  
 library generation in, 4.38

- PAC vector derived from, 4.40  
 PAGE. See Polyacrylamide gel electrophoresis  
 Pak1 kinase, 18.13  
 Pam3, A7.5  
*p*-aminophenyl- $\beta$ -D-thio-galactoside (APTG) (TPEG), 15.6, 15.58, 17.97  
 pAMP1, 11.122–11.123  
 pAMP10, 11.122  
 Pancreatic DNase I. See DNase I  
 Pancreatic RNase. See RNase  
 Panning, 11.68–11.69  
 Papain, 18.80–18.81  
*par*, 1.8, 1.13, 1.146, 4.2, 4.37  
*parA* in bacterial artificial chromosome, 4.2–4.3, 4.48  
 Paraffin blocks, DNA extraction from, 6.27  
 Paraformaldehyde (4%) fixative solution, 18.87  
 Paramagnetic beads, 9.91, 11.98–11.99, 11.103  
*parB* in bacterial artificial chromosome, 4.2–4.3, 4.48  
*parC* in bacterial artificial chromosome, 4.2–4.3  
 Partek Pro 2000 image analysis program, A10.13  
 Partitioning. See also *par*  
   in BACs, 4.48  
   low-copy-number plasmids, 1.13  
 pAS1, 15.4, 15.25  
 pAT53, 1.9  
 Pathways analysis software package, A10.9  
 pAX vectors for LacZ fusion protein expression, 15.59  
 pB6B15.23, 11.109  
 pB42AD, 18.20, A3.4  
 pBAce, 15.5, 15.32  
 pBACe3.6, 4.9  
 pBC KS +/-, A3.2  
 pBeloBACII, 4.3, A3.5, A6.5  
 p $\beta$ -gal vectors, 3.15, 17.49, A3.3  
 pBK-CMV, 11.24, A3.3  
 pBluescript vectors, 1.11, 11.92, 11.94, A3.2  
    $\beta$ -galactosidase gene, 1.27  
   in commercial kits for cDNA synthesis, 11.108  
   in exon trapping protocol, 11.89, 11.92, 11.94  
   for fusion protein construction, 15.5  
   KS (+/-), 3.15, 3.42, 3.44  
   for LacZ fusion protein expression, 15.59  
   in ribonuclease protection assay protocol, 7.69  
   SK (+/-), 3.15, 3.42, 3.44  
   SK(-) phagemid in  $\lambda$ ZAPII, 11.23  
   in USE mutagenesis, 13.30  
 pBR313, 1.9, A3.2  
 pBR322, 1.9–1.10, A3.2  
   cDNA cloning, 11.19  
   concentration of doubled-stranded DNA in solution, A6.5  
   electroporation of, 1.26  
   mobilization, 1.146  
   overview, 1.146  
   plasmid growth and replication, 1.17  
   primers for cloning sites in, 8.114  
   replicon in, 1.14  
 pBR327, A3.2  
 pBS. See pBluescript vectors  
 pCANTAB 5, 18.120  
 pCAT3 vectors, 17.35, A3.3  
 pcDNA3.1, 11.25, 11.30, 11.63, 11.72, A3.3  
 pcDNA4, 11.72  
 pCGB42/p2GB42, 18.20  
 pCGLex/p2GLex, 18.19  
 pCI-Neo, 17.61, 17.66  
 pCMV vectors, A3.3  
   pCMV-Script, 11.25, 11.29, 11.63, 11.72, A3.3  
   pCMV-SPORT in commercial kits for cDNA synthesis, 11.108  
   pCMV-SPORT- $\beta$ -gal, 16.10, A3.4  
*pcnB* gene, 1.13  
 pCOMB3H, 18.118  
 pCOMB8, 18.118  
 pCQV2, 15.25  
 PCR. See Polymerase chain reaction  
 PCR lysis solution, 6.22  
 PCR Primer Design program, 13.89  
 pCR2.1, 3.15  
 pCR1000, A3.2  
 pCRII, 8.35  
 pCR-ScriptSK(+), 1.100, 8.35  
 pCYPAC1, 4.5, 4.9, A3.5  
   concentration of doubled-stranded DNA in solution, A6.5  
   human genomic library, 4.39  
 pd2EGFP vectors, 17.88, A3.4  
 PDB (Protein Data Bank), A11.23  
 pDisplay, 18.120  
 pDisplay Expression Vector, 18.120  
 PEI buffer, 13.15  
 PE2 buffer, 13.15  
 Pefabloc, 15.41, A5.1  
 PEG. See Polyethylene glycol  
 pEG202, 18.19, 18.24, A3.4  
 pEG202I, 18.19  
 pEGFP-F, 16.10  
 pEMBI, 3.42–3.43  
 1,10-Penanthroline-copper, 17.76–17.77  
 Penicillins, 1.148, A2.7  
 Pepstatin, 15.19, 17.25, A5.1  
 Peptide aptamers, 18.8  
 Peptides  
   antibodies against, A9.30–A9.33  
   coupling to carriers, A9.32  
   libraries, 18.116–18.121  
   constrained, 18.120–18.121  
   construction of, 18.117–18.119  
   random, 18.116–18.117  
   phage display of, 18.116–18.121  
 Peptidoglycan, 1.148  
*Peptostreptococcus magnus*, A9.49  
 Perchloric acid, A1.6, A8.10  
 PerFect Lipid Transfection Kit, 16.5, 16.7  
 Perfect Match, 4.81, 8.9  
 PerfectPrep, 1.64, 12.27  
 Periodic Table of Elements, A1.29  
 Periplasmic space  
   export of foreign proteins to, 15.30, 15.34–15.35  
   export of maltose-binding fusion proteins to, 15.40, 15.43  
   release of fusion proteins by osmotic shock, 15.40, 15.43  
 Peroxidase. See Horseradish peroxidase  
 Peroxisome, 17.96  
 pET vectors, 1.12, 15.3, 15.5, 15.20–15.24, A3.2  
 pET-3 vector, 15.20–15.21  
 pEX vectors  
   expression libraries, 14.14  
   for LacZ fusion protein expression, 15.59  
 Pfam program, A11.16–A11.17  
 PFGE. See Pulsed-field gel electrophoresis  
 pFlITrx, 18.120  
 PfScan (ProfileScan) program, A11.16  
*Pfu* DNA polymerase, 8.7, 8.11, 8.30, 8.77–8.78, 8.85  
   3'-5' exonuclease activity, 8.30, 8.35  
   in circular mutagenesis, 13.20–13.23  
   in overlap extension method of mutagenesis, 13.37  
   polishing cDNA termini, 11.43  
   properties, table of, A4.23  
 pGEM vectors, 1.11, A3.2  
    $\beta$ -galactosidase gene, 1.27  
   for fusion protein construction, 15.5  
 pGEM-3Z, 15.14, A3.2  
 pGEM-11Zr(-), A9.23  
 pGEM\_luc, A9.23  
 pGEM-T, 8.35, A3.2  
 pGEMZ for LacZ fusion protein expression, 15.59  
 pGEMZF, 3.42, 3.44, A3.2  
   in ribonuclease protection assay protocol, 7.69  
*P* gene,  $\lambda$ , 2.6, 2.8–2.9, 2.11  
 pGEX vectors, 15.43, A3.2  
   for fusion protein construction, 15.5  
 pGEX-1, 15.15  
 pGEX2T, 15.8  
 pGEX3X, 15.8  
 pGilda, 18.19–18.20, 18.27, A3.4  
 pGL vectors, 17.96  
   pGL2, 3.15  
   pGL3, 17.43, A3.4  
 pNG1, 18.12  
 Phage display, 18.3  
 Phage Display System/Service, 18.120  
 Phagefinder Immunoscreening Kit, 14.25  
 Phagemid display system, 18.115–18.116  
 Phagemids, 1.11  
   advantages of, 3.43  
   DNA preparation, single-stranded, 3.42–3.49  
   growth time and, 3.49  
   materials, 3.45–3.46  
   protocol method, 3.46–3.48  
   yield estimation by gel electrophoresis, 3.48  
 helper viruses, 3.42–3.47  
   preparation of high-titer stock, 3.46  
   protocol for superinfection, 3.47  
 M13, 3.3, 3.5  
   nested deletion mutant set creating, 13.57, 13.59–13.61  
   oligonucleotide-directed mutagenesis, 13.18  
   replication, 3.43  
   screening for site-directed mutagenesis by hybridization to radiolabeled probes, 13.47  
   table of, 3.42  
   uracil-substituted single-stranded DNA, preparation of, 13.12–13.13  
   uses for, 3.43  
 Phagescript SK, A3.5  
 Phase-Lock Gel, 3.28  
 Ph.D. Phage Display Peptide Library Kits, 18.120  
 Phenol, A1.23  
   in DNA isolation from mammalian cells, 6.5, 6.9–6.10, 6.22  
   equilibration of, A1.23  
   inhibition of PCR by, 8.13  
 pH, 6.5  
   spectrophotometry of DNA contaminated with, 6.11, 6.15  
 Phenol:chloroform extraction  
   of agarase, 5.85  
   in DEAE-cellulose membrane recovery of DNA, 5.22  
   in dephosphorylation procedures, 1.96  
   in DNA recovery from polyacrylamide gels, 5.53  
   of DNase contaminants, 1.42  
   in DNase I footprinting protocol, 17.10  
   in DNase I hypersensitivity mapping protocol, 17.21  
   ethidium bromide removal from DNA preps, 1.74, 1.77  
   in hydroxyl radical footprinting protocol, 17.12  
   in  $\lambda$  DNA preparation, 2.58, 2.70  
   of ligated DNA, 1.102  
   M13 RF DNA purification, 3.25  
   of nuclease S1 digestion reactions, 7.61  
   in oligonucleotide purification, 10.27  
   overview of procedure, A8.9–A8.10  
   in PCR products, purification protocol, 8.26  
   plasmid DNA protocols  
   alkaline lysis with SDS, 1.34, 1.37, 1.42  
   boiling lysis, 1.46  
   lysis with SDS, 1.57

- Phenol:chloroform extraction (*continued*)  
 in polyethylene glycol DNA purification procedure, 1.59, 1.61  
 in primer extension assay protocol, 7.80  
 in RNA purification, 7.4  
 for RNase removal, 9.33  
 in yeast DNA purification protocols, 4.68–4.69
- Phenol:chloroform:isoamyl alcohol extraction, A1.23, A8.10  
 in genomic DNA isolation from mouse tails, 6.25, 6.27  
 in transcriptional run-on assay protocol, 17.28
- Phenol extraction  
 in bacteriophage DNA isolation, 12.23  
 in  $\lambda$  DNA preparation, 2.58  
 in M13 DNA preparation, 3.28  
 silicone lubricant for phase separation, 3.28
- Phenylalanine  
 for affinity purification of fusion proteins, 15.6  
 codon usage, A7.3  
 nomenclature, A7.7  
 properties, table of, A7.9
- Phenylmethylsulfonyl fluoride (PMSF), 5.62, 5.78, 14.44, 14.46, 15.41–15.42, 15.52, A5.1  
 in cell/tissue homogenization buffer, 17.4, 17.25  
 in cell/tissue resuspension buffer, 17.6  
 as protease inhibitor, 15.19
- Phenyl-Superose, 15.6
- PHI-BLAST (Position Hit Initiated BLAST) program, A11.18
- OX174 bacteriophage, 1.12, 3.8, A3.3  
 oligonucleotide-directed mutagenesis and, 13.6  
 sequencing of, 12.4  
 shotgun sequencing protocol, 12.10–12.22
- phaA*. See Alkaline phosphatase promoter *phaR*, 15.32
- Phosphatase. See Alkaline phosphatase
- Phosphate buffers, A1.5
- Phosphate buffers, Gomori, A1.5
- Phosphate-buffered saline (PBS), A1.7
- Phosphate-SDS washing solution, 6.51–6.52
- Phosphatidylethanolamine (DOPE), 16.5, 16.7–16.8, 16.50
- Phosphoric acid, A1.6
- Phosphorothioate analogs, 13.86–13.87
- Phosphorylation. See also Polynucleotide kinase, bacteriophage T4  
 of 5' termini, 10.17–10.19  
 blunt/recessed, 9.70–9.72  
 protruding, 9.66–9.67, 9.73–9.75  
 of adaptors, 1.88–1.89, 11.55  
 by exchange reaction, 9.73–9.75  
 imaging protein phosphorylation with FLIM-FRET, 18.78  
 imidazole buffers and, 9.73–9.74  
 of linkers, 1.99, 1.101, 11.55  
 of oligonucleotide probes, 7.78  
 polyethylene glycol enhancement of, 9.70–9.71  
 radiolabeling oligonucleotides, 13.42–13.43  
 in shotgun sequencing protocol, 12.18  
 of Thr-250, 18.78, 18.80, 18.88, 18.93–18.94  
 of tyrosine, 14.2
- Phosphotyrosine residues, antibodies specific for, 14.2
- Photinus pyralis*, 17.96, A9.21
- Photobiotin, 9.78, 11.116
- Photobleaching, 18.73, 18.92
- Photography of DNA in gels, 5.16–5.17  
 (CCD) (charged couple device) imaging systems, 5.15–5.16  
 Polaroid, 5.15–5.17  
 polyacrylamide gels, 5.48
- Photolabeling, 9.78
- Photolithography, A10.8
- pHUB vectors, 15.4, 15.25
- pHybLex/Zeo, 18.19
- picoBlue Immunoscreening Kit, 14.25
- Piezoelectric printing of microarrays, A10.16
- Pili, F, 4.49
- PIMA (Pattern-induced Multiple Alignment) program, A11.6–A11.7
- pIND(SP1)/V5-His A, 17.72, A3.4
- Piperidine  
 in chemical sequencing protocols, 12.61–12.65, 12.67, 12.71  
 rapid methods, 12.71  
 removal of, 12.62, 12.66  
 cleavage of CDI-modified bases, 13.95
- PIPES (piperazine-1,4-bis[2-ethanesulfonic acid]), 7.28  
 in nuclease S1 mapping of RNA, 7.56  
 in ribonuclease protection assay protocols, 7.67
- Pipetting devices, automatic  
 in PCR protocols, 8.19  
 as RNase source, 7.82
- pJ8, 4.13, A3.5
- pJG-4, A3.4
- pJG4-5, 18.20, 18.30, 18.43
- pJG4-5I, 18.20
- pJK101, 18.12, 18.23, 18.25, A3.5
- pJK103, 18.12
- pJK202, 18.19, 18.27
- PK buffer, 18.51, 18.52
- pKC30, 15.4, 15.25
- pKK223-3, 15.3, 15.15
- pKN402 replicon, 1.4
- PLACE (plant *cis*-acting regulatory elements) database, A11.20
- Placental RNase inhibitor, 8.49
- PLALIGN program, A11.4
- PlantCARE (plant *cis*-acting regulatory elements) database, A11.20
- Plaques, viral  
 $\lambda$  bacteriophage  
 $\beta$ -galactosidase screening, 2.30  
 macroplaques, 2.31  
 plating protocols, 2.25–2.31  
 size, 2.30  
 smearing, 2.30  
 M13 bacteriophage, 3.17  
 picking, 3.22  
 type, 3.2, 3.17  
 overview of, 2.25  
 purification, 13.45
- Plasmid DNA  
 dephosphorylation, 1.93–1.97  
 electroporation of *E. coli* and, 1.119–1.122  
 ligation in low-melting-temperature agarose, 1.103–1.104  
 linker addition to blunt-ended DNA, 1.98–1.102  
 preparation  
 alkaline lysis with SDS, 1.19  
 maxipreparation protocol, 1.38–1.41  
 midipreparation protocol, 1.35–1.37  
 minipreparation protocol, 1.32–1.34  
 overview, 1.31  
 troubleshooting, 1.41, 1.42  
 yield, 1.41  
 boiling lysis  
 large-scale, 1.47–1.50  
 overview, 1.43  
 small-scale, 1.44–1.46  
 yield, 1.50  
 for DNA sequencing templates, 12.26–12.31  
 denaturation, 12.26–12.30  
 PEG precipitation, 12.31  
 purification, 1.18–1.19  
 chromatography, 1.62–1.64  
 commercial resins, table of, 1.64  
 Sephacryl S-1000 columns, 1.80–1.81  
 size limitations, 1.63  
 CsCl removal, 1.73–1.75
- CsCl-ethidium bromide gradients, 1.18  
 contamination by DNA/RNA fragments, 1.65  
 continuous gradients, 1.65–1.68  
 discontinuous gradients, 1.69–1.78  
 DNA collection from, 1.67–1.68, 1.71  
 rebanding, 1.68
- ethidium bromide removal  
 extraction with organic solvents, 1.72–1.74  
 ion-exchange chromatography, 1.75–1.77  
 kits, 1.19  
 low-melting-temperature agarose, 5.7  
 nucleic acid fragment removal  
 centrifugation through NaCl, 1.78–1.79  
 chromatography, 1.80–1.81  
 precipitation with LiCl, 1.82–1.83  
 precipitation with PEG, 1.19, 1.59–1.61, 1.152, 12.31  
 steps, 1.16–1.19  
 growth of bacterial culture, 1.16  
 harvesting and lysis of culture, 1.16–1.18  
 purification, 1.18–1.19  
 receiving in the laboratory, 1.29  
 transfection of eukaryotic cells, calcium-phosphate-mediated, 16.14–16.20  
 high efficiency, 16.20  
 materials for, 16.15–16.16  
 method, 16.16–16.19  
 variables affecting, 16.20  
 transformation. See Transformation
- Plasmids. See also Plasmid DNA; Plasmid vectors  
 amplification, 1.4, 1.13, 1.39, 1.48, 1.56, 1.128, 1.131, 1.143  
 copy number, 1.3–1.4, 1.6–1.9  
 chloramphenicol amplification, 1.4, 1.39, 1.48, 1.56, 1.128, 1.131, 1.143  
*E. coli* strains-related suppression, 1.15  
 low-copy-number vectors, 1.12–1.13  
 suppression by *pcnB*, 1.13  
 incompatibility, 1.7–1.8  
 mobilization, 1.146  
 overview, 1.2–1.3  
 partitioning, 1.146  
 replication, 1.4–1.7  
 diagram of, 1.5  
 incompatibility of plasmids, 1.7–1.8  
 initiation of DNA synthesis, 1.5–1.6  
 inverted repeat lethality, 1.15  
 regulation by RNAI, 1.6–1.7  
 relaxed, 1.4, 1.17  
 runaway, 1.13  
 stringent, 1.4, 1.17  
 replicons, 1.3–1.4, 1.17. See also Replicons  
 size, 1.9  
 stability regions, 1.146
- Plasmid vectors  
 adaptor attachment to protruding termini, 1.88–1.89  
 with bacteriophage origin of replication, 1.11  
 with bacteriophage promoters, 1.11–1.12  
 blunt-ended cloning, 1.90–1.92  
 cDNA library construction, 11.63  
 directional cloning, 1.84–1.87  
 eukaryotic expression libraries, 11.72–11.73, 11.76–11.77  
 expression libraries, screening, 14.14–14.22, 14.47–14.49  
 chemiluminescent screening, 14.21–14.22  
 chromogenic screening, 14.20–14.21  
 master plate/filter preparation, 14.17  
 materials for, 14.15–14.17  
 processing filters, 14.18  
 protein expressing clones, 14.19–14.22  
 radiochemical screening, 14.19  
 replica filter preparation, 14.17–14.18  
 validation of clones, 14.22

- vector choice, 14.14
- expression vectors, 1.13–1.14
- finding appropriate, 1.14–1.16
- history of
  - 1973–1978, 1.9
  - 1978–1983, 1.9–1.10
  - 1983–present, 1.11–1.14
- immunological screening of libraries in, 14.2
- in vitro mutagenesis, 13.19–13.25
- for in vitro transcription, 9.29–9.31
- low-copy-number, 1.12–1.13
- nested deletion mutant set creating, 13.57, 13.59–13.61
- positive selection, 1.12
- runaway replication, 1.13
- selectable markers, 1.8–1.9
- table of, A3.2–A3.3
- USE mutagenesis, 13.26–13.30
- Plasmoon, 18.96
- Plasticware, preparation of, A8.3
- Platinum *Taq* Polymerase, 8.110
- pLexAop-lucU, 18.12
- Plus and minus sequencing technique, 12.4
- Plus/minus screening, 9.89–9.90
- plysF, 15.21, 15.24
- plysS, 15.21, 15.24
- PM2, bacteriophage, 13.71–13.72
- pMAL vectors, 15.15, A3.2
  - for fusion protein construction, 15.5
  - pMAL2, 15.7
  - pMAL-c2, 15.8, 15.40
  - pMAL-p2, 15.8, 15.40
- pMB1, A3.2
  - plasmid growth and replication, table of, 1.17
  - replicon, 1.3–1.4
- pMC9, 11.62, 11.66, 14.6, 14.47
- pMC128, 1.15
- Pmel*
  - cleavage at end of DNA fragments, A6.4
  - fragment size created by, table of, A4.8
  - genomic DNA mapping, 5.68–5.69
  - site frequency in human genome, 4.16, A6.3
- pMEX, 15.15
- pMOB45, 1.1.4, A3.2
- pMR100 for LacZ fusion protein expression, 15.59
- PMSF. *See* Phenylmethylsulfonyl fluoride
- pMW101–104, 18.19–18.20, 18.23–18.24
- pMW107–110, 18.12
- pMW111, 18.12, A3.5
- pMW112, 18.12, 18.23–18.25, 18.29, 18.44, A3.5
- pNB42 series, 18.20
- pNLexA, 18.19
- Point mutation detection by ligase amplification reaction, 1.157, 1.159
- Point-sink system of shearing DNA, A8.35
- polA* gene, *E. coli*, 9.82
- Pol I. *See* DNA polymerase, *E. coli* DNA polymerase I
- Pol3scan program, A11.14
- Polishing ends
  - of amplified DNA, 8.30, 8.32–8.34
  - in DNA sequencing protocols, 12.17
  - with Klenow, 12.17
  - with T4 DNA polymerase, 12.17
- Poly(A) polymerase, 1.13, 9.56
- Poly(A) RNA
  - cDNA library construction, 11.39
  - cDNA probe generation from, 9.38–9.40, 9.43, 9.48
  - in hybridization solutions, 6.51–6.52
  - integrity, checking, 11.39, 11.42
  - in northern hybridization, 7.45
  - in primer extension assays, 7.76
  - selection
    - by batch chromatography, 7.18–7.19
    - by oligo(dT)-cellulose chromatography, 7.13–7.17
    - on poly(U)-coated filters, 7.20
    - by poly(U)-Sepharose chromatography, 7.20
    - by streptavidin-coated beads, 7.20
    - in Southern hybridization, 6.56
- Polyacrylamide
  - chemical structure of, A8.41
  - cross-linking, 5.41–5.42
  - structure of, 5.41
- Polyacrylamide gel electrophoresis. *See also* SDS-polyacrylamide gel electrophoresis of proteins
  - agarose gels compared, 5.2, 5.40
  - analysis of protein expression in transfected cells, 17.69
  - band-stab PCR of samples from gel, 8.71
  - caging, 17.13
  - in coimmunoprecipitation protocol, 18.61, 18.65, 18.68
  - denaturing, 5.40
  - DGGE (denaturing gradient gel electrophoresis), 13.91–13.92
  - DNA detection
    - autoradiography, 5.49–5.50
    - silver staining, 5.77
    - staining, 5.47–5.48
  - DNA fragment size resolution, percentage gel for, 7.56
  - DNA recovery
    - by crush and soak method, 5.51–5.54
    - by electroelution into dialysis bags, 5.23–5.25
  - DNA sequencing, 12.66–12.69, 12.74–12.93
    - autoradiography, 12.90–12.93
    - compression of bands, troubleshooting, 12.83, 12.109–12.110
    - loading, 12.88
      - base order, 12.88
      - loading devices, 12.88
    - marker dye migration rate, 12.89
    - preparation of, 12.74–12.84
      - air bubbles, 12.79
      - electrolyte gradient gels, 12.83–12.84
      - formamide containing, 12.81–12.82
      - glass plates, 12.76–12.78
      - leaking gels, 12.80
      - materials for, 12.74–12.75
      - pouring gels, 12.78–12.80
      - reading, 12.90–12.93
      - resolution of, 12.85
      - running, 12.85–12.89
      - safety precautions, 12.86
      - temperature-monitoring strips, 12.86
      - troubleshooting band pattern aberrations, 12.67–12.69, 12.82
      - wedge gels, 12.83
  - in DNase I footprinting protocol, 17.5, 17.10
  - DNA size selection in shotgun sequencing protocol, 12.18
  - drying gels, 5.50, 12.92
  - far western analysis of protein-protein interactions, 18.49–18.50
  - fixing gels, 5.49–5.50, 12.90–12.92
  - formamide in sequencing gels, 6.59
  - gel retardation assays, 17.13–17.17, 17.80
  - gel-loading buffers, 5.42
  - glass plates for, 12.76
  - in GST fusion protein pulldown technique, 18.55, 18.56, 18.59
  - glycerol and, 13.90
  - IEF and, 18.61
  - markers
    - migration rate of dyes, 7.57, 12.89
    - radiolabeled size, 9.54
  - method, nondenaturing, 5.44, 5.46
  - apparatus assembly, 5.44
  - bubbles, removal of, 5.45
  - casting gel, 5.45
  - de-aeration of acrylamide solution, 5.44
  - loading samples, 5.46
  - storage of gels, 5.45
  - nondenaturing, 5.40–5.46
  - in nuclease S1 mapping of RNA, 7.56–7.59
  - oligonucleotide purification, 10.11–10.16, 10.48
    - detection in gels, 10.16
    - eluting DNA, 10.15
    - materials for, 10.12–10.13
    - protocol, 10.13–10.16
  - in primer extension assay protocol, 7.77, 7.80–7.81
  - for protein separation, 15.17, 15.24, 15.29, 15.33
  - resolution, 5.40, 5.42
  - in ribonuclease protection assay
    - analysis of RNase-resistant hybrids, 7.73–7.74
    - purification of riboprobes, 7.71–7.72
    - size standards, 7.73–7.74
  - RNA purification, 9.35
  - silver staining DNA, A9.6–A9.7
  - single-strand conformation polymorphism and, 13.51, 13.54–13.55
  - spacers for, 12.76
  - tape, gel-sealing, 12.76, 12.78
  - temperature-monitoring strips, 5.43, 5.46
  - western blotting and, A9.28
- polyadq program, A11.14
- Polybrene, DNA transfection using, 16.3, 16.43–16.46
- Polycloning sites, 1.10
- Poly(dI-dC), 17.14–17.15
- Polyethylene glycol (PEG)
  - DNA purification, 12.31
  - $\lambda$  particles, precipitation of, 2.43–2.44
  - in ligation reactions, 1.152, 1.154
  - for M13 concentration, 3.26–3.28
  - PEG 8000, A1.28
    - as crowding agent, 1.23
    - phosphorylation reaction enhancement, 9.70–9.71
    - in shotgun sequencing protocol, 12.18
    - in virus particle precipitation, 12.23
  - PEG-MgCl<sub>2</sub> solution, A1.21
  - plasmid DNA purification by PEG precipitation, 1.19, 1.152, 1.159–1.161
  - in protoplast fusion, 1.154
  - structure of, 1.154, 3.49
  - uses of, overview, 1.154, 3.49
- Polyethylene imine for facilitation of DEAE transfection, 16.28
- Polyhedral inclusion bodies (PIBs), 17.81
- Polyhistidine-tagged proteins. *See* Histidine-tagged proteins
- Polylinkers in vectors. *See* Linkers; *specific vectors*
- Poly-L-lysine, 18.85, A10.5
- Polymerase, DNA. *See* DNA polymerase
- Polymerase chain reaction (PCR)
  - amplification of specific alleles, 13.48
  - analysis of
    - $\lambda$  recombinants, 2.33, 2.105
    - products, 8.44, 8.52, 8.58, 8.60, 8.65, 8.70–8.71, 8.75, 8.80, 8.85, 8.92–8.93
    - yeast colonies, 4.72–4.73
- Band-stab, 8.71
- cDNA amplification
  - of 3' ends, 8.61–8.65
    - amplification, 8.64–8.65
    - materials for, 8.61–8.63
    - reverse transcription, 8.64
  - of 5' ends, 8.54–8.60
    - amplification, 8.59–8.60
    - full-length clones, yield of, 8.59
    - materials for, 8.56–8.57
    - reverse transcription, 8.57–8.58
    - tailing reaction, 8.58–8.59
  - mixed oligonucleotide-primed, 8.66–8.71



- Polymerase chain reaction (*continued*)  
 analysis, 8.70–8.71  
 band-stab PCR and, 8.71  
 DNA template, 8.68–8.70  
 guessmers, 8.66–8.67  
 materials for, 8.69  
 method, 8.70–8.71  
 primer design rules, 8.67–8.68  
 variations in protocol, 8.67  
 RT-PCR, 8.46–8.53  
 cDNA characterization, rapid, 8.72–8.76  
 screening individual colonies or plaques, 8.74–8.75  
 method, 8.74–8.75  
 troubleshooting, 8.75  
 yeast colonies, 8.75  
 screening  $\lambda$  libraries, 8.76  
 cloning products  
 blunt end, 8.30–8.34  
 difficulty of, 8.30  
 end modification, 8.42–8.45  
 genetic engineering with PCR, 8.42–8.45  
 overview, 8.30–8.31  
 polishing termini, 8.30, 8.32–8.34  
 restriction site addition and, 8.31, 8.37–8.41  
 clamp sequences and, 8.38–8.39  
 diagram of procedure, 8.38  
 primer design tips, 8.37–8.38  
 problems, 8.37  
 protocol, 8.39–8.41  
 troubleshooting, 8.41  
 into T vectors, 8.31, 8.35–8.36  
 codon usage, changing, 15.12  
 components of  
 essential, 8.4–8.6  
 optional, 8.9  
 contamination in, 8.16–8.17  
 cycles, number required, 8.9, 8.12  
 detection of defined mutants, 13.48  
 diagram of amplification sequence, 8.19  
 differential display, 8.96–8.106  
 advantages of, 8.96  
 kits, 8.102  
 materials for, 8.101–8.102  
 method, 8.102–8.105  
 primers, 8.96  
 anchored, 8.99–8.100  
 arbitrary, 8.100  
 problems with, 8.96–8.99  
 schematic representation of, 8.97  
 tips for success, 8.106  
 digoxigenin labeling of nucleic acids, A9.38–A9.39  
 in direct selection of cDNA protocol, 11.98–11.100  
 DNA polymerase, thermostable, 8.4, 8.6–8.8  
 3'-5' exonuclease activity, 8.30  
 cocktail mixtures of, 8.7, 8.77  
 inactivation, 8.25, 8.29  
 obstructions to, 8.7  
 properties and applications, table of, 8.10–8.11  
 terminal transferase activity, 8.30  
 DNA preparation for  
 mammalian, 6.3, 6.16, 6.19–6.23, 6.27–6.28  
 yeast, 6.31  
 in DNA sequencing  
 with end-labeled primers, 12.51–12.55  
 with internal labeling, 12.60  
 efficiency calculations, 8.12  
 in end-labeling for chemical sequencing of DNA, 12.73  
 GC-Melt, 4.81  
 history of, 8.2–8.4  
 hot start, 4.81, 8.110  
 inhibition of, 8.13  
 by SYBR Gold dye, A9.8  
 inosine use in, 8.113  
 interaction trap positives, rapid screen for, 18.46–18.47  
 inverse PCR, 1.157, 4.74–4.75, 8.81–8.85  
 materials for, 8.82–8.83  
 method, 8.84–8.85  
 overview of, 8.81  
 restriction enzyme choice for, 8.81, 8.84–8.85  
 schematic representation of, 8.82  
 use of, 8.81  
 Klenow use in, A4.16  
 $\lambda$  recombinant analysis, 2.33, 2.105  
 ligation-independent cloning (LIC-PCR), 11.121–11.124  
 locating by linker-scanning mutagenesis, 13.76–13.77  
 long PCR, 8.77–8.80  
 method, 8.79–8.80  
 overview of, 8.77  
 primers, 8.79  
 template DNA, 8.78–8.79  
 melting temperature calculation, 8.15–8.16  
 multiplex, 8.107  
 mutagenesis, random (misincorporation mutagenesis), 13.80  
 mutation detection techniques and, 13.91–13.96  
 Perfect-Match, adding, 4.81  
 primer elimination by exonuclease VII, 7.86  
 primers, 8.4–8.5. *See also specific applications*  
 base composition, 8.14  
 concentration of, 8.5  
 design for basic PCR, 8.13–8.16  
 computer assisted, 8.15  
 melting temperature, 8.14–8.16  
 restriction sites, adding, 8.14, 8.37–8.38  
 factors influencing efficiency, 8.14  
 length, 8.14, 8.18  
 nested, 4.81  
 purification of, 8.5  
 repetitive or random primer use, 4.75  
 selecting primers, 8.13–8.15  
 specificity, 8.13  
 universal primers, 8.113–8.117  
 for  $\lambda$ gt10/ $\lambda$ gt11, 8.116  
 for M13 vectors, 8.115  
 for pBR322, 8.114  
 for pUC vectors, 8.115  
 transcription promoter primers, 8.117  
 programming  
 annealing, 8.8–8.9  
 denaturation, 8.8  
 extension of primers, 8.9  
 number of cycles, 8.9  
 promoter for RNA polymerases, addition to  
 DNA fragments, 9.36–9.37  
 amplification conditions, 9.36  
 primer design, 9.36  
 protocol, basic, 8.18–8.24  
 bystander DNA, 8.21  
 controls, 8.21  
 materials for, 8.18–8.21  
 method, 8.21–8.22  
 optimization, 8.23  
 troubleshooting, 8.23–8.24  
 purification of products  
 for cloning, 8.25–8.26  
 methods for, 8.27  
 ultrafiltration for oligonucleotide and dNTP removal, 8.27–8.29  
 quantitative PCR, 8.86–8.95  
 amplification, 8.92  
 cDNA preparation, 8.91  
 detection and quantification of products, 8.92–8.93  
 materials for, 8.90–8.91  
 overview of, 8.86–8.89  
 real time PCR, 8.89, 8.94–8.95  
 reference template preparation, 8.91  
 references, externally added, 8.87–8.89, 8.91–8.93  
 semiquantitative methods, 8.89  
 standards, endogenous, 8.86–8.87  
 radiolabeling of DNA probes, 9.14–9.18  
 advantages of, 9.14  
 asymmetric probe production, 9.14, 9.18  
 methods used, 9.14–9.15  
 protocol for, 9.15–9.17  
 real time PCR, 8.89, 8.94–8.95  
 rescuing termini of YAC genomic inserts, 4.63  
 restriction enzyme digestion efficiency, use in monitoring, 2.66  
 RT-PCR, 8.46–8.53  
 controls/standards, 8.48–8.49, 8.51–8.52  
 enzymes, reverse transcriptase  
 inactivation of, 8.52  
 types used, 8.48  
 materials for, 8.49–8.51  
 method, 8.51–8.53  
 primers for, 8.46–8.48  
 troubleshooting, 8.53, 8.60  
 sequencing of PCR-amplified DNA, 12.106  
 single-site, 4.76–4.80  
 single-stranded radiolabeled probe production, 7.54  
 site-directed mutagenesis, 8.42–8.45, 13.7–13.10  
 megaprimer method, 13.8–13.10, 13.31–13.35  
 overlap extension, 13.8, 13.36–13.39  
 synthetic oligonucleotide cassette use, 4.76. *See also* Vectorette PCR  
 TAIL, 4.75  
 temperature ramping protocol, 8.70  
 template DNA concentration, 8.6, 8.20  
 template production for in vitro transcription, 7.70  
 theory, 8.12  
 touchdown, 8.112  
 vectorette PCR, 4.74–4.81  
 in vitro mutagenesis, 13.23–13.24  
 Polymerase dilution buffer, A1.9  
 Polynucleotide kinase, bacteriophage T4, A4.30, A4.35–A4.36  
 3' phosphatase activity of, 9.55  
 5' termini, phosphorylation of blunt/recessed, 9.70–9.72  
 5' termini, phosphorylation of oligonucleotide probe, 10.17–10.19  
 5' termini, phosphorylation of protruding, 9.66–9.69, 9.73–9.75  
 adaptor phosphorylation, 1.88–1.89, 11.55  
 in circular mutagenesis protocol, 13.24  
 DNA purification for, A4.35  
 end concentration, A4.36  
 end labeling, 9.55  
 for DNA sequencing, 12.8, 12.73  
 exchange reaction, 9.67, 9.73–9.75  
 forward reaction, 9.67–9.72  
 inactivation, 10.19  
 inhibition by ammonium ions, 9.65, A4.35  
 linkers/adaptors for cDNA, phosphorylation of, 11.55  
 oligonucleotide probes, phosphorylation of, 7.78  
 oligonucleotide-directed mutagenesis of single-stranded DNA, phosphorylation of primers in, 13.15–13.16  
 in probe production for primer extension assay, 7.78  
 radiolabeling oligonucleotides, 13.42–13.43  
 in S1 mapping of RNA, 7.56, 7.58  
 Polyomavirus origin of replication, 11.68  
 Polysomes, immunological purification of, 11.10  
 Poly(U)-Sephadex, 7.15, 7.20

- Polyvinylbenzyl(benzyltrimethylammonium) chloride, A9.19
- Polyvinylidene fluoride (PVDF), 9.78, A8.53
- Ponasterone A, 17.71–17.74
- Ponceau S, A9.28
- Positive selection, 1.12, 1.26–1.27
- Positive-displacement pipette use in PCR protocols, 8.19
- Potassium acetate solution, 6.28–6.29, A1.28
- Potassium chloride (KCl), A1.27  
in long PCR buffer, 8.78  
in PCRs, 8.6, 8.21
- Potassium ferrocyanide ( $K_4Fe(CN)_6$ )  
in histochemical stain, 16.13  
in X-GlcA solution, 16.42
- Potassium glutamate in PCR, 8.9
- Potassium hydroxide (KOH), A1.6, A1.20
- Potassium phosphate buffer, A1.5
- PowerBLAST program, A11.16
- pPCR-Script Direct, A3.2
- pPGKPuro, 17.66
- pPLc vectors, 15.4, 15.25
- PPO (2,5-diphenyloxazole) scintillant, A9.12
- pPROEX-1, 15.8
- PPSEARCH program, A11.17
- pPUR, 17.66
- pRB1840, 18.12
- Preflashing films, A9.11–A9.12
- Prehybridization solution  
for dot, slot, and northern hybridization, A1.13  
for northern hybridization, 7.42–7.43
- Prehybridization/hybridization solution  
for hybridization in aqueous buffer, A1.13  
for hybridization in formamide buffers, A1.13  
for hybridization in phosphate-SDS buffer, A1.14  
for plaque/colony lifts, A1.13  
for transcriptional run-on assay protocol, 17.25
- pRFHM1, 18.19, 18.23–18.25, 18.44, A3.4
- Prime Inhibitor, 7.68, 7.77, 7.83, 9.38
- Primer extension, 7.75–7.81  
analysis of products, 7.80–7.81  
hybridization and extension of primer, 7.79–7.80  
mapping regulatory sequences, 17.33  
markers for gel electrophoresis, 7.76  
materials for, 7.76–7.78  
on microarrays, A10.17  
for mutant detection, 13.91, 13.96  
optimizing reactions, 7.76  
overview, 7.75  
probe preparation, 7.78–7.79  
purification of products, 7.80  
sequencing, 7.79
- Primer extension mix, 7.77
- Primer Generator computer program, 13.83
- Primer-adaptors in cDNA synthesis, 11.12–11.13, 11.15, 11.17–11.19, 11.39
- Prism system, 8.95
- pRM1/pRM9, 15.25
- proAB, 11.23–11.24  
 $\lambda$  propagation and, 2.28–2.29  
M13 vectors and, 3.10, 3.12–3.13
- Probes. *See also* DNA probes; Nonradioactive labeling; Radiolabeled probe preparation; RNA probes  
AMPPD detection, A9.43  
for cDNA screening, 11.27–11.32  
digoxigenin containing, A9.38–A9.40  
for far western analysis of protein-protein interactions, 18.48–18.53  
in GST fusion protein pulldown protocol, 18.55–18.58  
horseradish peroxidase containing, A9.35–A9.36  
immunoblotting, A8.54–A8.55
- Probe synthesis buffer, 9.25
- ProBond, 15.46
- Prodrom database, A11.22
- ProFection, 16.5, 16.30
- Proline  
cleavage by formic acid, 15.6, 15.8  
codon usage, A7.3  
nomenclature, A7.7  
properties, table of, A7.9  
prototrophs, 3.10–3.11
- Promoter-bashing experiments, 17.30
- Promoters. *See also* Regulatory elements of genes;  
SP6 bacteriophage, promoter; SV40 promoter; T3 bacteriophage, promoter; T7 bacteriophage, promoter  
bacteriophage promoters in plasmid vectors, 1.11–1.12  
of baculoviruses, 17.82  
for expression of cloned genes in *E. coli*  
choosing a promoter, 15.3–15.4  
IPTG-inducible, 15.3, 15.14–15.19  
 $\lambda p_L$ , 15.4, 15.25–15.29  
*phoA*, 15.30–15.35  
T7, 15.3–15.4, 15.20–15.24  
in vitro transcription, 9.29–9.37  
 $\lambda$ , 2.5–2.8, 2.14, 2.17, 15.4, 15.25–15.29  
locating by linker-scanning mutagenesis, 13.75  
in low-copy-number plasmid vectors, 1.12  
mapping with primer extension, 17.33  
in plasmid expression vectors, 1.13–1.14  
reporter assays, 17.30–17.51
- Pronase, A4.50
- Prophage,  $\lambda$   
integration, 2.16  
transcription, 2.17–2.18
- PROSITE program, A11.17
- Protease inhibitors  
for optimization of protein expression, 15.19  
table of, A5.1
- Proteases  
cellular heat shock genes, 15.25  
for cleavage of fusion proteins, 15.7–15.8, 15.39–15.40, 15.43  
cleavage site analysis using substrate phages, 18.116
- Protection assays  
nuclease S1, 7.51–7.62  
ribonuclease, 7.63–7.74
- Protein A, 18.81, A9.46–A9.47  
affinity purification of fusion proteins, 15.4, 15.6  
in antibody purification, 14.5, 14.16, 14.51, 18.81, A9.25–A9.26  
applications of, A9.48  
radiolabeled, 14.9, 14.19
- Protein A–Sepharose columns, 11.10, 14.5, 14.16, 14.51, 18.81
- Protein G, 18.81, A9.46–A9.48
- Protein inhibitors of RNases, 7.68, 7.71, 7.77, 7.79, 7.83
- Protein kinase A, 18.49, 18.51
- Protein kinase C $\alpha$  (PKC $\alpha$ ), 18.78, 18.88, 18.93–18.95
- Protein L, A9.46–A9.47, A9.49
- Protein microarrays, A10.18
- Protein Refolding Kit, 15.53
- Protein truncation test (PTT), 13.92
- Proteinase K, 5.78, A1.8  
for alkaline phosphatase inactivation, 2.70, 9.64, 12.24  
in cDNA first-strand synthesis protocol, 11.42  
in DNA isolation from mammalian cells, 6.5, 6.9–6.10, 6.22, 6.28–6.29  
in DNase I hypersensitivity mapping, 17.20–17.21  
in genomic DNA isolation from mouse tails, 6.24–6.26  
inactivation of, 8.26  
inhibition of PCR by, 8.13  
in  $\lambda$  DNA extraction, 2.56–2.58  
for lysis of cells in agarose plugs, 5.62, 5.64, 5.67  
overview of, A4.50  
in PCR lysis solution, 6.22  
in PCR product purification protocol, 8.26  
for restriction enzyme inactivation, 12.24  
in ribonuclease protection assay protocol, 7.73  
for RNase removal, 9.33  
stripping probes from filter and, A9.38  
in transcriptional run-on assay protocol, 17.28
- Proteinase K buffer, A1.11
- Protein-protein interactions, 18.1–18.127  
coimmunoprecipitation, 18.60–18.68  
cell lysis, 18.62, 18.65  
controls, 18.63–18.66  
identification of proteins, 18.66  
immunoprecipitation of cell lysate, 18.62–18.63  
materials for, 18.67–18.68  
method, 18.68  
nonspecific interactions, reducing, 18.65–18.66  
procedure, outline of, 18.61–18.62  
far western analysis, 18.48–18.54  
anti-GST antibodies, 18.54  
materials for, 18.50–18.51  
method, 18.52–18.53  
refolding membrane-bound proteins, 18.53  
troubleshooting, 18.53
- filamentous phage display, 18.115–18.122  
affinity selection and purification of bacteriophages, 18.121  
commercial display systems, 18.120–18.121  
of foreign proteins, 18.121–18.122  
interaction rescue, 18.122  
of peptides, 18.116–18.121  
constrained libraries, 18.120–18.121  
construction of libraries, 18.117–18.119  
random peptide libraries, 18.116–18.117  
vectors used for, 18.115–18.116, 18.118
- FRET, 18.69–18.95  
detection methods, 18.72–18.74  
donor quenching, 18.73  
photobleaching, acceptor, 18.73  
steady-state fluorescence intensity measurements, 18.72–18.73
- FLIM-FRET, 18.78–18.95  
cell preparation for, 18.84–18.89  
data acquisition, 18.90–18.95  
flow diagram, 18.79  
imaging protein phosphorylation with, 18.78  
labeling proteins with fluorescent dyes for, 18.80–18.83  
fluorescence lifetime, 18.73–18.74  
photophysical principles of, 18.70–18.72
- GST fusion proteins  
far western analysis, 18.48–18.54  
pulldown technique, 18.55–18.59  
materials for, 18.57–18.58  
method, 18.58–18.59  
outline of, 18.56  
troubleshooting, 18.59
- mass spectrometry, 18.3  
molecular modeling, 18.3  
overview, 18.2–18.5  
questions posed by, 18.2  
Ras recruitment system (RRS), 18.127  
Sos recruitment system (SRS), 18.126–18.127  
strategies for studying, overview of, 18.3–18.4  
surface plasmon resonance (SPR), 18.96–18.114  
concentration measurement, 18.102  
data collection, 18.100–18.101  
instruments of, 18.96  
kinetic measurements, 18.101–18.102  
overview, 18.97–18.98

- Protein-protein interactions (*continued*)
- protocol, 18.103–18.114
    - capture surface preparation, 18.105
    - data analysis, 18.112–18.114
    - design, 18.103
    - kinetic analysis, 18.108–18.114
    - test binding, 18.106–18.107
  - schematic of, 18.97
  - sensor chips, 18.98–18.100
    - regeneration of surface, 18.100
  - two-hybrid system, 18.3–18.4, 18.6–18.47
    - bait, dual, 18.11–18.13
    - bait and hook, 18.10–18.11
    - bait, modified, 18.6–18.8
    - bait, troubleshooting, 18.27
    - diagram of, 18.7
    - false positives, 18.14–18.15
    - flow chart, 18.16
    - genomic analysis, 18.123–18.124
    - interaction trap. *See* Interaction trap
    - modifications of, 18.14–18.15
    - non-yeast, 18.127
    - peptide-protein interactions, 18.8–18.9
    - protocol
      - bait, troubleshooting/modification of, 18.27
      - expression of bait protein, detecting, 18.26
      - flow chart, 18.16
      - rapid screen for interaction trap positives, 18.46–18.47
      - replica technique, 18.29
      - repression assay for DNA-binding, 18.23–18.25
      - Stage 1: Bait-LexA fusion protein characterization, 18.17–18.29
      - Stage 2: Interactor selection, 18.30–18.37
      - Stage 3: Second confirmation of positive interactions, 18.38–18.47
    - reverse two-hybrid system, 18.11–18.12
    - RNA polymerase-III-based, 18.15
    - swapped system, 18.15
    - ternary complexes, 18.9–18.10
    - vectors, 18.14, 18.19–18.20, 18.22
      - activation domain fusion plasmids, 18.20
      - LexA fusion plasmids, 18.19
      - reporter plasmids, 18.22
    - yeast CM selective media requirements, 18.21, 18.32, 18.40
    - yeast strains for selection, 18.22
  - ubiquitin-based split-protein sensor (USPS), 18.125–18.126
- Proteins. *See also* Fusion proteins; Protein-protein interactions
- absorbance of, A8.21
  - biotinylation of, 11.115–11.117
  - chaotropic agent, denaturation of, 15.60
  - databases, bioinformatics, A11.22–A11.23
  - DNA interactions, 18.125
  - identification, 18.66
  - immunoblotting, A8.52–A8.55
  - mass maps, 18.66
  - molar conversion table, A7.7
  - refolding of membrane-bound, 18.53
  - refolding solubilized proteins from inclusion bodies, 15.53–15.54
  - software, bioinformatics, A11.16–A11.17
  - western blotting, A9.28
- Proteolytic enzymes, A4.50
- Protomap database, A11.22
- Protoplast fusion, 1.154
- Protruding termini
  - adaptor attachment to, 1.88–1.89
  - cloning DNA fragments with, 1.20–1.21
  - phosphorylation of, 9.66–9.69
- PRPP progressive global alignment program, A11.8
- pRS303, 304, 305, 306, A3.4
- pRS313, 314, 315, 316, A3.5
- pRS323, 324, 325, 326, A3.5
- pRSA101, 3.42
- PRSS program, A11.4
- PRT601, 11.109
- pSC101, A3.2
  - incompatibility locus, 1.8
  - plasmid growth and replication, table of, 1.17
  - replicon in, 1.1.4, 1.4
- pSE280, A3.2
- Pseudobase database, A11.21
- Pseudoscreening protocol, 14.23–14.24
- pSGR3, 13.73
- pSH17-4, 18.19, 18.23–18.25, 18.28, A3.4
- pSH18-34, 18.12, 18.24, A3.5
- PSI-BLAST (position-specific BLAST) program, A11.18
- pSK vectors for fusion protein construction, 15.5
- pSKAN, 18.120
- pSP18/19, A3.2
- pSPL1, 11.79
- pSPL3, 11.79, 11.81–11.85, 11.89, A3.4
- pSPORT1, 11.25, 11.28, 11.63, A3.2
  - in commercial kits for cDNA synthesis, 11.108
  - expression cloning, 11.72
- pSR1 recombinase, 4.85
- Pst*I
  - 7-deaza-dGTP modified DNA, cleavage of, 8.60
  - cleavage at end of DNA fragments, A6.4
  - homopolymeric tailing reactions and, 11.110–11.111
  - linker sequences, 1.99
- pSV2CAT, 17.95
- pSV2-His, 17.61–17.63, 17.65
- pSV2neo, 16.48
- pSV3neo, 16.48
- pSVOCAT, 17.95
- pTA1529, 15.5, 15.32
- PTEN phosphatase, 17.72
- pTet-Splice, 17.57–17.58, 17.61, 17.66, 17.70, A3.4
- pTet-tTak, 17.57–17.58, 17.60–17.62, 17.65, 17.70, A3.4
- pTK-HYG, 17.61, 17.66
- pTrc99A, 15.15
- pTrx, 15.5, A3.2
- pTrxFus, 15.4–15.5, 15.25, A3.2
- ptsM* gene, 2.4
- pTZ18, A3.2
- PubMed, 1.14, A10.15
- pUC vectors, 1.9–2.0, A3.2
  - $\alpha$ -complementation, 1.10, 1.39
  - $\beta$ -galactosidase gene, 1.10, 1.27
  - copy number, 1.6
  - expression libraries, 14.14
  - for fusion protein construction, 15.5
  - lacZ* fragments in, 1.10, 3.9
  - for LacZ fusion protein expression, 15.59
  - M13 and, 3.9, 3.14
  - multiple cloning sites, table of, 3.14
  - plasmid growth and replication, 1.17
  - primers for cloning sites in, 8.115
  - replicon in, 1.4, 1.6
- pUC17, A3.2
- pUC18, 8.115, 11.111, A6.5
- pUC19, 8.115, A3.3, A6.5
- pUC118/119, 3.42, 13.18
- pUHC13-3, 17.66, 17.70
- pUK vectors for LacZ fusion protein expression, 15.59
- Pulse-chase experiments, 15.18–15.19
- Pulsed-field gel electrophoresis (PFGE)
  - apparatus types, 5.56–5.57
  - CHEF, 5.57, 5.79–5.82
  - conditions for, 5.79–5.80
  - electrode configuration, 5.57
  - method, 5.81–5.82
  - pulse times, 5.79–5.80
  - resolution, 5.79
- DNA preparation for
  - from mammalian cells/tissues, 5.61–5.64
  - overview, 5.59
  - RE digestion in agarose plugs, 5.68–5.70
  - from yeast, 5.65–5.67
- DNA recovery
  - direct retrieval, 5.83–5.85
  - following DNA concentration, 5.86–5.88
- high-capacity vector insert size determination, 4.18
- molecular-weight markers, 5.59–5.60, 5.71–5.73
- overview, 5.2–5.3, 5.55–5.56
- resolution, 5.3
  - factors affecting, 5.57–5.58
  - field angle, 5.59
  - pulse time, 5.58, 5.74–5.75, 5.79–5.80
  - temperature, 5.59
  - voltage, 5.58–5.59
- restriction enzyme use with, 5.60, 5.68–5.70
- TAFE, 5.56–5.57, 5.74–5.78
  - electrode configuration, 5.57
  - method, 5.76–5.78
  - pulse times, 5.74–5.75
  - resolution, 5.74
  - silver staining, 5.77
  - Southern blots, 5.77–5.78
  - theory overview, 5.55–5.56
- pUR vectors for LacZ fusion protein expression, 15.59
- Purification of plasmid DNA. *See* Plasmid DNA, purification
- Purine molecules, numbering of atoms on, A6.5
- Puromycin, 16.49, 17.65–17.67, 17.69, A2.7
- Puromycin-*N*-acetyl transferase, 16.47, 16.49
- Putrescine, 4.21
- PVDF membranes
  - colorimetric detection of nonradioactive probes on, 9.78
  - for immunoblotting, A8.53
- pVgRXR, 17.74, A3.4
- pVHL protein, 18.60, 18.62, 18.64–18.65
- Pvu*I methylation, 13.87, A4.3, A4.7
- Pvu*II
  - in pSPL3, 11.84
  - in USE, 13.85
- Pvu*II methylase, A4.7
- Pwo* DNA polymerase, 8.11, 8.30
  - in circular mutagenesis, 13.20, 13.21
  - in overlap extension method of mutagenesis, 13.37
  - properties, table of, A4.23
- pXf3, 1.9, A3.3
- pYAC4, 4.59, 4.63, 4.76, A.65
- pYD1, 18.120
- pYD1 Yeast Display Vector Kit, 18.120
- pYESTrp, 18.20
- Pyridopyridazines, A9.18
- Pyrimidine molecules, numbering of atoms on, A6.5
- Pyrimidine tract analysis, 12.3
- Pyrophosphatase, 9.88
  - in DNA sequencing protocols, 12.34–12.36, 12.39
  - dUTPase, 13.85
- Pyrophosphate
  - in automated DNA sequencing protocols, 12.95
  - luciferase and, A9.22
- Pyroxylin, 6.14
- pZLI, 11.25, A3.3
- Q358 and Q359 *E. coli* strain
  - genotype, A3.9
  - $\lambda$  vector propagation, 2.28–2.29
- QAE (diethyl[2-hydroxy-propyl]aminoethyl), 1.19
- QBT buffer (Qiagen), A1.21

- Q gene,  $\lambda$ , 2.8–2.9, 2.12, 2.14  
 Qiagen BioRobot, A10.5  
 Qiagen resins, DNA purification on, 4.45  
 QIAprep, 1.64, 8.27  
 QIAprep Turbo miniprep, 12.27  
 QIAquick, 8.26  
 Quantitation of nucleic acids, A8.19–A8.24  
   fluorometry, A8.22–A8.24  
     ethidium bromide use, A8.19, A8.23–A8.24  
     agarose plate method, A8.24  
     minigel method, A8.24  
     spot test, A8.19, A8.24  
     with Hoechst 33258, A8.19, A8.22–A8.23  
   methods, summary of (Table 8-4), A8.19  
   spectrophotometry, A8.20–A8.21  
 Quaternary alkylammonium salts, 10.6  
 Quaternary ammonium salts, 10.35–10.37  
 Quik Change site-directed mutagenesis kit, 13.21, 13.89  
*quit* site,  $\lambda$ , 2.14
- R1 replicon, 1.12–1.13  
 R6K, A3.3  
 R408, 3.42, 3.44  
 R594 *E. coli* strain  
   genotype, A3.9  
    $\lambda$  vector propagation, 2.28  
 3'-RACE and 5'-RACE. *See* Rapid amplification of cDNA ends (RACE)  
 Radioactive ink, 1.142, 2.97–2.98, A1.21  
 Radioactivity, measuring  
   adsorption to DE-81 filters, A8.26  
   precipitation of nucleic acids with TCA, A8.25–A8.26  
   specific activity, calculating, A8.26  
 Radioimmunoassay (RIA), A9.29  
 Radiolabeled probe preparation, 9.1–9.93  
   asymmetric probes, 9.14, 9.18  
   cDNA probes  
     subtracted, 9.90–9.91  
     by random extension, 9.46–9.50  
     using oligo(dT) primer, 9.41–9.45  
     using oligo(dT) primer, 9.41–9.45  
     using random oligonucleotide primers, 9.38–9.40  
   dephosphorylation of DNA fragments with alkaline phosphatase, 9.62–9.65  
   end-labeling  
     3' termini with cordycepin or dideoxyATP, 9.60–9.61  
     3' termini with Klenow, 9.51–9.56, 9.83–9.85  
     materials for, 9.53  
     overview of, 9.51–9.53  
     protocol, 9.54  
     uses for, 9.51  
     3' termini with T4 DNA polymerase, 9.57–9.59  
     5' termini with T4 polynucleotide kinase, 9.55, 9.66–9.75  
     blunt/recessed 5' termini, 9.70–9.72  
     by exchange reaction, 9.73–9.75  
     protruding 5' termini, 9.66–9.69, 9.73–9.75  
   methods, table of, 9.55–9.56  
   with poly(A) polymerase, 9.56, 9.61  
   with RNA ligase, 9.56, 9.61  
   with terminal transferase, 9.55–9.56, 9.60–9.61  
   with Klenow fragment, 10.30–10.34  
   methods of radiolabeling, table of, 9.3  
 PCR, 9.14–9.18  
   advantages of, 9.14  
   asymmetric probe production, 9.14, 9.18  
   methods used, 9.14–9.15  
   protocol, 9.15–9.17  
 random priming  
   components of reactions, 9.5–9.6  
   DNA polymerase, 9.5  
   primers, 9.5–9.6  
   radiolabel, 9.5  
   template DNA, 9.6  
   in melted agarose, 9.9–9.11  
   nick translation compared, 9.4  
   protocols, 9.6–9.11  
 RNA probes  
   in vitro transcription, 9.29–9.37  
   materials for, 9.32–9.33  
   PCR, promoter addition, 9.36–9.37  
   plasmid vectors, 9.29–9.31  
   protocol, 9.33–9.35  
   in situ hybridization, 9.35  
   troubleshooting, 9.36  
   single-stranded DNA from M13  
     defined length, 9.19–9.24  
     heterogeneous length, 9.25–9.28  
     premature termination, 9.24  
 Radiolabeled probes. *See also* Hybridization;  
   Radiolabeled probe preparation  
   calculation of the specific activity of, A8.26  
   denaturation of, 1.140–1.141  
   denaturing double-stranded, 2.98, 6.54  
   DNase I footprinting protocol, 17.5, 17.7  
   in DNase I hypersensitivity mapping protocol, 17.21  
   in dot/slot hybridization, 7.48, 7.50  
   end-labeled, 7.54  
   in gel retardation assays, 17.13–17.16  
   northern hybridization, 7.43–7.44  
     low stringency, 7.43  
     stripping probes, 7.44  
   oligonucleotide purification by  
     precipitation with CPB, 10.22–10.24  
     precipitation with ethanol, 10.20–10.21  
     Sep-Pak C<sub>18</sub> chromatography, 10.28–10.29  
     size-exclusion chromatography, 10.25–10.27  
   phosphorylation of 5' termini of oligonucleotides, 10.17–10.19  
   purification, 6.56, 7.45  
   purity, 2.98  
   reuse of, 1.141  
   RNA probes, 6.58, 7.54  
     ribonuclease protection assays, 7.63–7.74  
   S1 protection assays, 7.51–7.62  
   screening bacterial DNA on filters, 1.138–1.142  
   screening clones for site-directed mutagenesis, 13.40–13.47  
   screening expression libraries, 14.3, 14.31–14.36  
   screening M13 plaques with, 3.41  
   single-stranded DNA probes, 6.58  
 Southern hybridization  
   low-stringency hybridization, 6.58  
   nonradioactive probes, 6.50  
   overview, 6.50  
   protocol, 6.51–6.55  
     hybridization, 6.54  
     prehybridization, 6.53–6.54  
     washing, 6.54–6.55  
   sensitivity, 6.50  
   stripping from membranes, 6.57  
 Radiolabeling. *See also* Radiolabeled probe preparation  
   antibody, A9.30  
   IgG, radioiodination of, 14.5, 14.16  
   for screening expression libraries, 14.3, 14.5, 14.16  
   CAT reporter assay, 17.36, 17.38–17.41  
   in coimmunoprecipitation protocol, 18.62  
   for DNA sequencing, 12.36, 12.43, 12.49–12.54, 12.60  
     asymmetric labeling, 12.72  
     chemical, 12.64  
     end-labeling by PCR, 12.73  
   in DNase I footprinting protocol, 17.5, 17.7  
   end labeling, 4.33, 12.73  
   for far western analysis of protein-protein interactions, 18.49, 18.52  
   in gel retardation assays, 17.13–17.15  
   with Klenow fragment, 12.101–12.102, A4.15  
   of oligonucleotides by phosphorylation, 13.42–13.43  
   pulse-chase experiments, 15.18–15.19  
   in restriction enzyme digestion efficiency monitoring, 2.66  
   RNA by RNA ligase, A4.30  
   with T4 DNA polymerase, A4.18–A4.19  
   with T4 DNA polynucleotide kinase, A4.35  
   with terminal transferase, A4.27  
   for transcriptional run-on assays, 17.23–17.24, 17.27–17.28  
 RAG1/RAG2 (recombination activating genes), 17.56  
 RainX, 12.75  
 Random priming buffer, 9.6, 9.47  
 Random priming in digoxigenin labeling of nucleic acids, A9.38–A9.39  
 Rapid amplification of cDNA ends (RACE), 18.14  
   3'-RACE, 8.61–8.65  
   5'-RACE, 8.54–8.60  
 Ras recruitment system (RRS), 18.125–18.126  
 Rat, genomic resources for microarrays, A10.6  
 RB791 *E. coli* strain, A3.9  
 rBst DNA polymerase, A4.23  
 Real time PCR, 8.89, 8.94–8.95  
   advantages/disadvantages, 8.95  
   fluorometric detection, 8.94  
   instruments for, 8.95  
   TaqMan method, 8.95  
 Reassociation kinetics, 7.65–7.66  
 REBASE (restriction enzyme database), 1.16, 13.88, A4.3–A4.4, A4.9  
 recA gene, 1.15, 2.28–2.29  
 RecA protein  
   chi site and, 2.13  
    $\lambda$  CI protein cleavage, 2.8, 2.18  
 recA1, M13 vectors and, 3.11–3.13  
 recB, 1.15, 2.11, 2.13, 2.28  
 recC, 2.11, 2.28  
 recD, 2.11, 2.13, 2.28  
 RecF, 1.15  
 RecJ, 1.15  
 RecO, 1.15  
 Recombinant phage antibody system, 18.120  
 Recombination  
   chi sites and, 2.13  
   Cre-loxP recombination system, 4.82–4.85, 11.25–11.26  
   in  $\lambda$ -infected cells, 2.11–2.13  
   M13 vectors and, 3.11–3.13, 3.16  
 Recombination activating genes (RAG1/RAG2), 17.56  
 RecQ, 1.15  
 red,  $\lambda$ , 2.11, 2.20, 2.22  
 Red blood cell lysis buffer, 5.62, 6.28–6.29  
 REF select program, 13.94  
 Regulatory elements of genes. *See also* Promoters  
   detection by transcriptional run-on assays, 17.23  
   gel retardation assays for DNA-binding proteins, 17.13–17.17  
   identification by linker-scanning mutagenesis, 13.75–13.77  
   mapping by DNase I footprinting, 17.18–17.22  
   mapping by DNase I hypersensitivity sites, 17.18–17.22  
   mapping by hydroxyl radical footprinting, 17.12  
   reporter assays, 17.30–17.51  
      $\beta$ -galactosidase, 17.48–17.51  
     CAT, 17.33–17.41  
     luciferase, 17.42–17.47  
     overview, 17.30–17.32

- Renilla reniformis*, 17.89, 17.96, A9.22  
 Renin, 15.8  
*repA* gene in runaway plasmid vectors, 1.13  
 RepA protein, 1.4, 1.8  
*repE* in bacterial artificial chromosome, 4.2, 4.48  
 Repelcote, 12.75  
 Repetitive DNA sequences, amplification of, 8.106  
 Replacement vectors,  $\lambda$ , 2.19, 2.22, 2.64–2.65  
 Replication, DNA  
   chromosomal, chloramphenicol blockage of, 1.143  
   plasmid, 1.4–1.7  
     diagram of, 1.5  
     incompatibility of plasmids, 1.7–1.8  
     initiation of DNA synthesis, 1.5–1.6  
     inverted repeat lethality, 1.15  
     regulation by RNAI, 1.6–1.7  
     relaxed, 1.4, 1.17  
     runaway, 1.13  
     stringent, 1.4, 1.17  
 Replication, M13, 3.2, 3.5–3.7  
 Replicative form (RF), M13, 3.2, 3.5–3.6, 3.23–3.25  
 Replicons  
   ARS, 4.2–4.3, 4.60  
   chloramphenicol amplification and, 1.143–1.144  
   colE1, 1.3–1.4, 1.13, 1.15, 1.17, 1.143, 4.2, 4.5, 11.22–11.24, 15.3  
   F, 4.2–4.3  
   f1, 11.22–11.24  
   in high-capacity vectors, 4.4  
   incompatibility of plasmids, 1.7–1.8  
   low-copy-number plasmid vectors, 1.12  
   P1, 4.4, 4.37  
   plasmid copy number and, 1.3–1.4, 1.12  
   SV40, 4.5  
   table of, 1.4  
 Reporter assays, 17.30–17.51  
    $\beta$ -galactosidase, 17.48–17.51  
   CAT, 17.33–17.41, 17.95  
   GFP, 17.85–17.87  
   luciferase, 17.42–17.47, 17.96, A9.21, A9.23  
   overview, 17.30–17.32  
 Reptation, 5.2, 5.56, 12.114  
 Rescue buffer, 18.39  
 Resequencing, A10.17  
 Resins, 1.62–1.64. *See also* Chromatography  
   for DNA purification, 1.63–1.64, 5.26  
   ion-exchange, formamide deionization, 6.59  
   oligonucleotide purification, 10.49  
   table of commercially available, 1.64  
 Resolvases, 13.91, 13.94  
 Resolver program, A10.15  
 Restriction digestion of DNA for Southern analysis, 6.39–6.40, 6.42  
 Restriction endonuclease fingerprinting (REF), 13.91, 13.94  
 Restriction enzymes. *See also* Restriction sites; *specific enzymes*  
   in adaptor use, 1.89  
   adenine methylation and, 13.87–13.88  
   agarose plugs, DNA digestion, 5.68–5.70, 5.78  
   boiling lysis plasmid DNA preparations and, 1.18, 1.43  
   cleavage near ends of DNA fragments, 1.86, 8.31, 8.37–8.38, A6.4  
   cyclic coiled DNA resistance to cleavage, 1.40, 1.45, 1.49  
   digestion efficiency, monitoring, 2.66–2.67  
   DNA resistance to cleavage  
     alkaline lysis preparations, 1.33, 1.36, 1.42  
     boiled lysis preparations, 1.45, 1.49  
   in exonuclease III mutagenesis protocol, 13.57–13.59  
   fragment size created by, table of, A4.8  
   genomic DNA mapping, 5.68–5.69  
   inhibition by agarose, 5.18, 5.29  
   inhibition by cell wall components, 1.33, 1.36, 1.42, 3.24  
   inverse PCR and, 8.81–8.83  
   ligation reactions, inclusion into, 1.100  
   linker sequences for, 1.99  
   partial digestion of eukaryotic DNA for genomic libraries, 2.76–2.83  
   pulsed-field gel electrophoresis, use with, 5.60, 5.68–5.70  
   use in BAL 31 mutagenesis protocol, 13.63, 13.66  
 Restriction enzyme buffers, effect on DNA migration in agarose, 5.10  
 Restriction mapping  
   BAL 31 nuclease use for, 13.68  
   of cosmid/genomic DNA recombinants, 4.33  
   YAC genomic inserts, 4.63  
 Restriction mutations, M13, 3.10–3.13  
 Restriction sites  
   addition to 5' termini of PCR primers, 8.31, 8.37–8.39  
   clamp sequences, 8.38–8.39  
   enzyme choice, 8.37–8.38  
   frequency in human genome, 4.16, A6.3  
   in linkers/adaptors, 1.98–1.100, 11.20–11.21, 11.48–11.52, 11.64  
   methylation of, A4.5–A4.9  
     *dam* methyltransferase, A4.3  
     isoschizomer pairs, table of, A4.6  
     mutagenesis to create/remove, 13.83  
     removal by USE mutagenesis, 13.26–13.30, 13.85  
 Restriction/modification systems, A4.4. *See also* Methylation  
 Retinoid X receptor (RXR), 17.71, 17.73  
 Rev response element (RRE), 18.11  
 Reverse transcriptase, 8.48, 8.51–8.52, A4.24–A4.26  
   in 3'-RACE protocol, 8.61–8.62, 8.64  
   5'-3' polymerase activity, A4.24  
   in 5'-RACE protocol, 8.54–8.58, 8.60  
 ALV, 11.11  
 AMV, 8.48, 11.38, 11.109  
 cDNA first strand synthesis, 11.38–11.42  
 in cDNA probe construction, 9.39–9.40, 9.42–9.43, 9.47–9.48  
 controls for activity variation, 9.40, 9.43, 9.48  
 in differential display-PCR, 8.97, 8.101, 8.103  
 digoxigenin labeling of nucleic acids, A9.39  
 in exon trapping/amplification protocol, 11.89–11.91  
 inactivation, 8.52, 8.103  
 Mo-MLV, 8.48, 9.39, 9.42, 9.47, 11.11, 11.38, 11.40–11.41, 11.109–11.110  
 in primer extension assays, 7.75, 7.77, 7.79  
 properties, table of compared, A4.11  
 in quantitative RT-PCR, 8.91  
 RNase activity, 11.11–11.12, A4.24–A4.25  
*Tth* DNA polymerase, 8.48  
 types of, 11.11–11.12  
 uses, list of, A4.25–A4.26  
 Reverse transcriptase buffer, A1.11  
 Reverse transcriptase-PCR. *See* RT-PCR  
 Reversed-phase chromatography, 10.11, 10.15–10.16  
   for DNA purification, 5.26  
   oligonucleotide purification, 10.49  
*rexA* gene,  $\lambda$ , 2.3, 2.17  
*rexB* gene,  $\lambda$ , 2.3, 2.17  
 RF6333, *E. coli*, 15.19  
 RFY206, 18.22  
*R* gene,  $\lambda$ , 2.15–2.16  
 Rhodamine, 12.96–12.98, A9.33  
 Rhodium, 17.77  
 Ribonuclease. *See* RNase  
 Ribonuclease protection assays, 7.63–7.74  
   diagram of, 7.64  
   northern hybridization compared, 7.63–7.65  
   protocol  
     analysis by gel electrophoresis, 7.73–7.74  
     digestion of hybrids, 7.73  
     dissolving nucleic acid pellets, 7.72  
     hybridization, 7.72–7.73  
     materials for, 7.67–7.68  
     probe preparation, 7.70–7.72  
     quantification of RNA in samples, 7.63, 7.65–7.66  
   S1 protection assay compared, 7.65  
   sensitivity of, 7.63–7.65  
 Riboprobe Gemini Systems, 9.32  
 Ribosomal protein S10, 2.7  
 Ribosomal RNA mutation databases, A11.21  
 Ribosome-binding site, 15.11–15.12, 15.18  
 Rifampicin  
   inhibition of bacteriophage T7 RNA polymerase, 15.20  
   modes of action, A2.7  
 RNA  
   5' cap, 9.88  
   concentrating. *See* Concentrating nucleic acids  
   concentration determination by spectrophotometry, 7.8, 7.16  
   CsCl density gradients, 1.155  
   databases, bioinformatics, A11.21–A11.22  
   denaturation  
     with formamide, 6.59  
     by heat, 8.51  
   dephosphorylation, 9.65  
   electrophoresis, agarose gel, 7.21–7.23, 7.27–7.34  
   equalizing RNA amounts in, 7.22–7.23  
   formaldehyde-containing gels, 7.31–7.34  
   glyoxylated RNA, 7.27–7.30  
   integrity of RNA, checking methods, 7.30  
   markers for, 7.23, 7.29  
 end-labeling  
   3' termini, 9.56  
   5' termini, 9.55  
 hybridization  
   dot and slot, 7.46–7.50  
   northern protocol. *See* Northern hybridization  
 LiCl precipitation of, 1.59  
 mapping  
   mung bean nuclease, 7.55  
   nuclease S1, 7.51–7.62  
   primer extension, 7.75–7.81  
   ribonuclease protection assays, 7.63–7.74  
 polymerase (*see* RNA polymerase)  
 precipitation with LiCl, 1.59, 1.82–1.83  
 probes, 7.54  
   for in situ hybridization, 9.35  
   purification of, 7.54  
   ribonuclease protection assays, 7.63–7.74  
   screening expression libraries, 14.2  
   synthesis of single-stranded probes by in vitro transcription, 9.29–9.37  
 protein interaction, studying with bait and hook strategy, 18.10–18.11  
 purification  
   acid phenol-guanidinium thiocyanate-chloroform extraction, 7.4–7.8  
   DNA contamination, 7.8, 7.12  
   ethanol precipitation, 9.34–9.35  
   gel electrophoresis, 9.35  
   isopropanol precipitation, 7.7, 7.12  
   poly(A)<sup>+</sup> RNA selection by batch chromatography, 7.18–7.19  
   poly(A)<sup>+</sup> RNA selection by oligo(dT)-cellulose chromatography, 7.13–7.17  
   simultaneous preparation with DNA and protein, 7.9–7.12  
   spun-column chromatography, 9.35  
   quantitation. *See* Quantitation of nucleic acids  
 RNAI  
   decay due to *pcnB* gene, 1.13

- degradation, 1.7  
 regulation of replication, 1.6–1.8  
 Rom binding, 1.7  
 RNAI, 1.4–1.7  
 mutation in pUC plasmid family, 1.6  
 priming of DNA synthesis at *colE1* origins, 1.5–1.6  
 RNAI interaction, 1.6–1.7  
 RNase H transcript processing of, 1.6  
 Rom binding, 1.7  
 software, bioinformatics, A11.14–A11.15  
 staining  
   ethidium bromide binding, 1.151  
   of glyoxylated RNA, 7.27–7.28  
   with methylene blue, 7.39, A9.4  
   with SYBR dyes, A9.7–A9.8  
 standards, 7.23  
 storage of, 7.8  
 types, 7.2  
 yeast carrier tRNA, 5.20  
 RNA denaturation solution, 7.48  
 RNA gel-loading buffer, 7.68, A1.19  
 RNA ligase, bacteriophage T4, 1.157, 9.56, A4.34  
 RNA modification database, A11.21  
 RNA polymerase, A4.28–A4.29  
   bacteriophage T3, A4.28–A4.29  
   bacteriophage T7, A4.28–A4.29  
   inhibition by lysozyme, 15.21, 15.24  
   inhibition by rifampicin, 15.20  
   digoxigenin labeling of nucleic acids, A9.38–A9.39  
 DNA-dependent, 1.4  
*E. coli*, 9.87  
   in  $\lambda$ , 2.10–2.11  
   M13 replication, 3.5  
 in vitro transcription, 9.30–9.32, 9.34, 9.36–9.37, 9.87–9.88  
 $\lambda$ , 2.6, 2.7, 2.8  
 nuclear run-on assays, 17.23  
 promoter addition to DNA fragment by PCR, 9.36–9.37  
   amplification conditions, 9.36  
   primer design, 9.36  
 promoter sequences recognized by bacteriophage-encoded, 7.87  
 in ribonuclease protection assay protocol, 7.68, 7.71  
 RNA polymerase III in two-hybrid system for protein-protein interaction study, 18.15  
 transcription terminator signal overcoming, 9.36  
 recognition, 9.36  
 RNA precipitation solution, 7.10  
 RNA secondary structures database, A11.21  
 RNA World database, A11.21  
 RNase, 7.2, A1.8  
   in BLOTTO, 1.139  
   cleavage of mismatches in RNA:RNA heteroduplexes, 13.93  
   contamination  
     preventive measures, 7.82  
     sources of, 7.82  
     in vitro transcription, 9.36  
   in CsCl-ethidium bromide gradients, 1.67  
   formamide protection of RNA, 7.8  
   inactivation of, 7.4  
   inhibitors of  
     DEPC, 7.82–7.84  
     placental, 8.49  
     protein, 7.68, 7.71, 7.77, 7.79, 7.83, 11.39  
     RNasin, 17.25  
     vanadyl ribonucleoside complexes, 7.83  
   in lysis buffer, 6.4–6.5  
   nucleic acid contaminant removal, 1.79  
   removal by phenol:chloroform extraction, 9.33  
   removal by proteinase K, 9.33  
   in yeast DNA purification protocols, 4.69, 4.71  
 RNase A, 1.59, A4.39  
   in alkaline lysis with SDS protocols, 1.34–1.35, 1.38  
   cleavage of mismatches in RNA:RNA heteroduplexes, 13.93  
   cleavage preferences, 7.67  
   DNase free, preparation of, A4.39  
   in ribonuclease protection assays, 7.66–7.68  
   in transcriptional run-on assay protocol, 17.29  
 RNase digestion mixture, 7.68, 7.73  
 RNase E, 1.7  
 RNase H, 1.4, 7.77, 8.48, 11.43  
   activity of exonuclease III, 13.73  
   in ALV reverse transcriptase, 11.11  
   buffer, A1.11  
   in cDNA second-strand synthesis, 11.14–11.17, 11.43–11.46  
   in DNA polymerase I, A4.12  
   functions of, 8.111  
   overview of, A4.38  
   in reverse transcriptases, 11.11–11.12, 11.109–11.110, A4.24–A4.25  
   RNAII transcript processing, 1.6  
 RNase I, 7.67, 13.93  
 RNase III, *E. coli*, 2.6  
 RNase ONE, 7.67  
 RNase P (polymerase III) promoter, 18.11  
 RNase T1, A4.39  
   cleavage of mismatches in RNA:RNA heteroduplexes, 13.93  
   cleavage preferences, 7.67  
   in ribonuclease protection assays, 7.66–7.68  
   in transcriptional run-on assay protocol, 17.29  
 RNase T2, 7.67  
 RNaseOUT, 9.38  
 RNasin, 7.68, 7.77, 7.83, 9.38, 17.25  
 RNA-Stat-60, 7.10  
 Robbins Hydra Work Station, A10.5  
 Robotics for high-throughput processing, A10.5  
 Roller bottle hybridization chamber, 6.51, 6.53–6.54  
 Rolling circle replication  
    $\lambda$ , 2.11–2.12  
   in phagemids, 3.43  
 Rom (RNAI modulator), 1.5, 1.7  
 Rop (repressor of primer), 1.5, 1.7  
 Rotors, table of commonly used, A8.39  
 RPCI-11 Human BAC Library, 4.9  
 R-phycoerythrin, A9.33  
 RR1 *E. coli* strain, A3.9  
 rRNA database, A11.21  
*RsaI*, A4.9  
*RsrI* site frequency in human genome, 4.16, A6.3  
*RsrII*  
   fragment size created by, table of, A4.8  
   genomic DNA mapping, 5.69  
   methylation, A4.7  
 RT-PCR (reverse transcriptase-PCR), 8.46–8.53  
   advantages/disadvantages, 11.15  
   controls/standards, 8.48–8.49, 8.51–8.52  
   differential display-PCR, 8.97  
   enzymes, reverse transcriptase  
     inactivation of, 8.52  
     types used, 8.48  
   in exon trapping/amplification protocol, 11.89–11.94  
   full-length clones, low-yield of, 8.60  
   materials for, 8.49–8.51  
   measuring multiple gene products by, 8.89  
   method, 8.51–8.53  
   primers for, 8.46–8.48  
   quantitating RNA by, 7.66  
   quantitative, 8.88–8.91  
   reference templates, 8.88–8.89  
   troubleshooting, 8.53, 8.60  
*rTh* DNA polymerase  
   in circular mutagenesis, 13.20  
   in overlap extension method of mutagenesis, 13.37  
   properties, table of, A4.23  
 Runaway plasmid replication, 1.13  
*Rz* gene,  $\lambda$ , 2.15–2.16  
<sup>35</sup>S  
   decay data, A9.15  
   particle spectra, A9.9–A9.10  
   sensitivity of autoradiographic methods for detection, A9.13  
 5S rRNA data bank, A11.21  
 S1 nuclease. *See* Nuclease S1  
*sacB* gene, 4.4–4.5, 4.37  
*Saccharomyces cerevisiae*, 4.58–4.60. *See also* Yeast artificial chromosomes  
   chromosome separation by pulsed-field gel electrophoresis, 5.56  
   chromosome sizes, 5.60, 5.65  
   expression in, 15.55  
   FLP recombinase, 4.85  
   genome size, 4.64  
   protein interactions in, mapping, 18.123–18.124  
   protein-protein interactions, studying, 18.4, 18.6  
   Sos recruitment system (SRS), 18.125–18.126  
*SacI*  
   cleavage at end of DNA fragments, A6.4  
   fragment size created by, table of, A4.8  
   linker sequences, 1.99  
   site frequency in human genome, 4.16, A6.3  
*SacII*  
   fragment size created by, table of, A4.8  
   site frequency in human genome, 4.16, A6.3  
*S*-adenosylmethionine (SAM), 1.99, 11.48–11.49, A4.3  
 SAGA (Sequence Alignment by Genetic Algorithm) program, A11.7–A11.8  
*SalI*  
   7-deaza-dGTP modified DNA, cleavage of, 8.60  
   cDNA linkers and adaptors and, 11.20, 11.51, 11.64  
   in cDNA synthesis kits, 11.71  
   cleavage at end of DNA fragments, A6.4  
   fragment size created by, table of, A4.8  
   genomic DNA mapping, 5.69  
   in homopolymeric tailing protocols, 11.111  
   linker sequences, 1.99  
   methylation, A4.7  
   site frequency in human genome, 4.16, A6.3  
   terminal/subterminal site cleavage, inefficient, 8.38  
 Salmon sperm DNA  
   in chemical sequencing protocols, 12.64  
   in hybridization/prehybridization solutions, 6.52–6.53, 6.56, 7.45, 10.35, 10.38  
   as transfection control, 16.4  
 SAM. *See* *S*-adenosylmethionine (SAM)  
 SAM (Sequence Alignment and Modeling System) program, A11.7  
 SAP. *See* Shrimp alkaline phosphatase  
 Sarkosyl for lysis of cells in agarose plugs, 5.62, 5.64, 5.67  
 Satellite colonies, 1.110, 1.115, 1.118, 1.148  
 Saturation mutagenesis, 13.2–13.3  
*Sau3AI*  
   7-deaza-dGTP modified DNA, cleavage of, 8.60  
   *dam* methylation and, 13.87, A4.3  
   genomic DNA digestion, 4.11, 4.36  
   in site-directed mutagenesis protocol, 13.84  
*sbca*, 2.13, 2.28  
*sbcb*, 1.15, 2.13  
*SbfI* site frequency in human genome, 4.16, A6.3  
 ScanAlyze image analysis program, A10.5, A10.13  
 ScanArray 5000, A10.11

- Scanning mutagenesis, 13.3  
 ScanProsite program, A11.17  
*SceI*, 17.83  
 Schiff bases and formaldehyde, 7.31  
*Schizosaccharomyces pombe*, chromosome sizes of, 5.60, 5.65  
 Schlieren line, 12.79  
 Scintillation counting, 7.47, A8.25  
 CAT reporter assay, 17.39–17.41  
 coincidence circuit, 17.46, A9.22  
 luciferase assay, 17.46, A9.22–A9.23  
 SCOP (Structural Classification of Proteins) database, A11.22  
 Screening. *See also* Expression libraries, screening; Hybridization; Immunological screening  
 bacterial colonies  
 $\alpha$ -complementation, 1.123–1.125  
 by hybridization  
 filter types, choosing, 1.126  
 intermediate numbers, 1.129–1.131  
 large numbers, 1.132–1.134  
 small numbers, 1.126–1.128  
 using X-gal and IPTG, 1.123–1.125  
 cDNA libraries, 11.26–11.34, 11.74–11.78  
 $\lambda$  recombinants, 2.21  
 by PCR  
 bacterial colonies, 8.74–8.75  
 $\lambda$  libraries, 8.76  
 $\lambda$  plaques, 8.74–8.75  
 yeast colonies, 8.75  
 for recombinant plasmids, 1.26–1.28  
 $\alpha$ -complementation, 1.27, 1.150  
 by hybridization, 1.27–1.28  
 overview, 1.26–1.27  
 transformants by insertional inactivation, 1.10  
 YAC recombinants, 4.60  
 Screening buffer, 14.33  
 Sculptor IVM Mutagenesis kit, 13.89  
 SDS, A1.28  
 in acrylamide gel elution buffer, 5.52  
 alkaline phosphatase inactivation, 1.96  
 bovine serum albumin absorption of, 6.25  
 in dot/slot hybridization, 7.48, 7.50  
 in elution buffers, 7.14  
 for inactivation of alkaline phosphatase, 9.64  
 in  $\lambda$  DNA extraction, 2.58  
 in mouse-tail lysis buffers, 6.26  
 in northern hybridization protocols, 7.42–7.44  
 in phosphate-SDS washing solution, 6.51–6.52  
 plasmid DNA protocols  
 alkaline lysis, 1.31–1.42  
 gentle method, 1.55–1.58  
 in ribonuclease protection assay protocol, 7.73  
 in SSCP protocol, 13.56  
 in SNET lysis buffer, 6.24–6.25  
 for solubilization of GST fusion proteins, 15.38–15.39  
 for solubilization of inclusion bodies, 15.54  
 in Southern hybridization wash solutions, 6.55  
 in yeast DNA preparation protocols, 4.68–4.71  
 SDS buffer, 17.20  
 SDS gel-loading buffer, 15.15, 15.22, 15.26, 15.31, 15.35, 15.41, 15.50, 18.17, A1.20, A8.42  
 SDS-EDTA dye mix, A1.20  
 SDS-polyacrylamide gel electrophoresis of proteins, A8.40–A8.51. *See also* Polyacrylamide gel electrophoresis  
 discontinuous buffer system, A8.40  
 drying gels, A8.50–A8.51  
 overview, A8.40  
 protocol  
 materials, A8.42–A8.44  
 pouring gels, A8.44–A8.45  
 resolving gel components, table of, A8.43  
 running gels, A8.45  
 sample preparation, A8.45  
 stacking gel components, table of, A8.43  
 reagents, A8.41–A8.42  
 separation range, table of, A8.42  
 staining gels, A8.46–A8.49  
 with Coomassie Brilliant Blue, A8.46–A8.47  
 during immunoblotting, A8.54  
 with silver salts, A8.46–A8.49  
 transfer of proteins from gel to filters for immunoblotting, A8.52–A8.53  
 Seal-A-Meal bags, 1.139, 2.97, 6.51, 6.53–6.54  
 Searching databases, 1.14  
 Secreted foreign proteins, expression of, 15.30–15.35  
 Selectable markers  
 inactivation as screening tool, 1.10  
 for  $\lambda$  recombinants, 2.21  
 uses of, 1.8–1.9  
 Selection. *See also* Antibiotics; *specific protocols*  
 conditionally lethal genes, 1.12  
 direct selection of cDNAs, 11.98–11.106  
 of mutants in vitro  
*DpnI* destruction of parentals, 13.19–13.25, 13.84  
 phosphorothioate analog incorporation, 13.86–13.87  
 unique restriction site elimination, 13.26–13.30, 13.85  
 uracil-DNA glycosylase destruction of parentals, 13.84–13.85  
 of mutants in vivo, 13.87  
 positive selection vectors, 1.12  
 Sephacryl equilibration buffer, A1.21  
 Sephacryl S-400 in DNA purification for DNA sequencing, 12.106  
 Sephacryl S-1000, nucleic acid fragment contaminants, removal of, 1.80–1.81  
 Sephadex  
 G-15 for oligonucleotide purification, 10.26  
 G-25 in IgG radioiodination protocol, 14.5, 14.16  
 G-50, A8.29–A8.30  
 in cDNA probe production, 9.44–9.45, 9.49–9.50  
 in cDNA synthesis protocols, 11.44, 11.47, 11.54  
 for radiolabeled probe purification, 9.69, 9.71, 9.75  
 RNA purification, 9.35  
 poly(U), 7.15, 7.20  
 preparation of, A8.29  
 Sepharose  
 4B for antisera purification, 14.30, 14.51  
 affinity purification of fusion proteins, 15.6  
 CL-4B, A8.31, A9.26  
 cDNA size fractionation, 11.55–11.58  
 in dephosphorylated DNA purification, 9.65  
 CL-6B for DNA purification for DNA sequencing, 12.106  
 Sep-Pak  $C_{18}$  chromatography, 10.11, 10.13, 10.15–10.16, 10.28–10.29  
 Sequenase, 12.9  
 activity of, 12.104  
 DNA sequencing  
 annealing primers to templates, 12.29  
 automated, 12.98  
 dye-primer sequencing, 12.96  
 materials for, 12.33–12.35  
 protocol, 12.35–12.36  
 pyrophosphatase use with, 12.34–12.36, 12.39  
 reaction mixtures, table of, 12.33  
 sequencing range, modifying, 12.37  
 steps involved, 12.32  
 troubleshooting, 12.38–12.39  
 inosine and, 12.110  
 Klenow compared, 12.32  
 in oligonucleotide-directed mutagenesis of single-stranded DNA, 13.15–13.17  
 overview of, 12.104–12.105  
 properties, table of compared, A4.11  
 versions of, 9.5, 12.104  
 Sequenase dilution buffer, 12.33, A1.9  
 Sequenase reaction buffer, 12.33–12.34  
 Sequencing. *See* DNA sequencing  
 Sequencing by hybridization (SBH), A10.17  
 Sequencing gels, resolving compressions in, 6.59  
 Sequin program, A11.3  
 SequiTherm, 12.46  
 Serine  
 codon usage, A7.3  
 nomenclature, A7.7  
 properties, table of, A7.9  
 Serum separation tubes (SST) for isolation of DNA from mouse tails, 6.26  
 71/18 *E. coli* strain  
 genotype, A3.6  
 M13 vectors and, 3.13  
 phagemids and, 3.42  
 Sex pili, M13 adsorption to, 3.5  
*SfiI*  
 fragment size created by, table of, A4.8  
 genomic DNA mapping, 5.68–5.69  
 site frequency in human genome, 4.16, A6.3  
 S gene,  $\lambda$ , 2.15–2.16  
*SgrAI*  
 fragment size created by, table of, A4.8  
 site frequency in human genome, 4.16, A6.3  
 Shine-Dalgarno sequence  
 fortuitous, formation of, 15.12  
*lacZ*, 15.57  
 in plasmid expression vectors, 1.13  
 translation efficiency and, 15.11–15.12, 15.18  
 Shotgun sequencing, 12.10–12.25  
 diagram of strategy, 12.12  
 DNA purification, 12.21–12.24  
 DNA repair, phosphorylation, and size selection, 12.17–12.18  
 enzymatic cleavage, 12.10–12.11  
 fragmentation of target DNA, 12.10–12.11, 12.15–12.17  
 growth of recombinants in 96-tube format, 12.19–12.21  
 hydrodynamic shearing, 12.10  
 ligation to vector DNA, 12.18–12.19  
 materials for, 12.13  
 number of sequences needed for coverage, 12.20  
 self-ligation of target DNA, 12.15  
 test ligations, 12.18, 12.25  
 Shrimp alkaline phosphatase (SAP), 1.95–1.96, 9.62–9.65, 9.92–9.93, A4.37  
 inactivation of, 1.96, 9.62, 9.64, 9.93  
 properties of, 9.93  
 RNA dephosphorylation, 9.65  
 sib-selection, 11.68–11.69  
 Sigmacote, 5.44, 12.75  
 Signal peptidase, 15.30  
 Silanizing solution, 12.75, 12.77, 12.112  
 Silica resins for DNA purification, 1.63, 5.26  
 Siliconizing fluid, 5.44  
 Siliconizing glassware, plasticware, and glass wool, A8.3  
 Silver emulsions, A9.9  
 Silver nitrate, 5.77, A8.48–A8.49  
 Silver staining, A9.5–A9.7  
 PFGE gels, 5.77  
 SDS-polyacrylamide gels, A8.46–A8.48  
 SilverSequence DNA Sequencing Kit, A9.6  
 SIM program, A11.5  
 Single nucleotide polymorphisms (SNPs), A10.3, A10.17  
 Single-strand-binding proteins in automated DNA sequencing protocols, 12.95

- Single-stranded conformation polymorphism (SSCP), 13.49–13.56, 13.91, 13.93  
 advantages/disadvantages, 13.52  
 amplification, 13.51, 13.53–13.54  
 denaturation, 13.51, 13.54  
 detection of mutants, 13.52, 13.55, 13.91, 13.93  
 dideoxy fingerprinting compared, 13.94  
 electrophoresis, 13.51, 13.55  
 materials, 13.52–13.53  
 mutation detection, 13.49  
 protocol, 13.53–13.55  
 restriction enzyme digestion and, 13.54–13.55  
 schematic diagram, 13.50  
 SYBR Gold stain as alternative to, 5.15  
 troubleshooting, 13.56
- Single-stranded DNA. *See also* M13 bacteriophage  
 alkaline agarose gel electrophoresis, 5.36–5.37  
 binding to DEAE-cellulose membranes, 5.19  
 calculating amount of 5' ends in a sample, 9.63  
 chemical mutagenesis of, 13.79  
 denaturing polyacrylamide gels, 5.40  
 end-labeling, 9.55  
 ethidium bromide binding, 5.14–5.15  
 exonuclease VII digestion of, 7.86  
 M13 DNA, preparation of, 3.26–3.29  
 mung bean digestion of, 7.87  
 nomogram for, A6.12  
 nuclease S1 cleavage of, A4.46  
 oligonucleotide-directed mutagenesis, 13.15–13.18
- PCR  
 production of radiolabeled probes, 7.54  
 SSCP, 13.51, 13.53–13.54  
 phagemids, 3.42–3.49  
 precipitation of, 3.29  
 radiolabeled probe production from M13  
 of defined length, 9.19–9.24  
 of heterogeneous length, 9.25–9.28  
 premature termination, 9.24  
 separation from double-stranded by hydroxyapatite chromatography, A8.32–A8.34  
 sequencing using Klenow fragment, 12.40–12.44  
 SYBR Gold binding, 5.15  
 uracil-containing, preparation of, 13.11–13.14
- Single-stranded DNA-binding protein, 12.44
- Site-directed mutagenesis. *See* Mutagenesis, site-directed
- Size markers. *See* Molecular-weight markers
- Size-exclusion chromatography, oligonucleotide purification by, 10.25–10.27
- SK promoter, primer sequence for, 8.117
- Slot hybridization of purified RNA, 7.46–7.50
- SM, A1.21
- SM buffer recipe, A2.8
- SM plus gelatin, A1.21
- SmaI*  
 7-deaza-dGTP modified DNA, cleavage of, 8.60  
 fragment size created by, table of, A4.8  
 genomic DNA mapping, 5.69  
 linker use of, 1.99, 1.100  
 site frequency in human genome, 4.16, A6.3
- Small RNA database, A11.21
- SMR10 *E. coli* strain  
 genotype, A3.9  
 $\lambda$  vector propagation, 2.29
- SNET solution, 6.24
- snoRNA program, A11.15, A11.21
- SNPs. *See* Single nucleotide polymorphisms
- SNR6 promoter, 18.15
- Soaking solution in northern hybridization protocols, 7.36–7.37
- SOB medium recipe, A2.3
- SOC medium recipe, A2.3
- Sodium acetate, 6.26–6.27, A1.28  
 in ethanol precipitation of nucleic acids, A8.12  
 in RNA isolation protocols, 7.5, 7.10
- Sodium  
 azide, 14.4, 14.15, 14.23–14.27  
 bicarbonate, A1.6  
 butyrate, 16.14–16.15, 16.17–16.18  
 in electroporation protocol, 16.36  
 in transfection, using polybrene protocol, 16.44–16.45  
 carbonate, A1.6  
 chloride (NaCl), A1.27  
 in chemical sequencing protocols, 12.61–12.65  
 density gradient for  $\lambda$  arm purification, 2.71  
 in ethanol precipitation of nucleic acids, A8.12  
 ethanol/NaCl solution, 6.19–6.20  
 in mouse-tail lysis buffers, 6.26  
 nucleic acid contaminant fragment removal, 1.78–1.79  
 for protein expression optimization, 15.19  
 in SNET lysis buffer, 6.24–6.25  
 in transfection with polybrene, 16.43  
 in virus particle precipitation, 12.23  
 dodecyl sulfate (SDS). *See* SDS  
 hydroxide (NaOH), A1.6, A1.27  
 in chemical sequencing protocols, 12.61–12.65, 12.70–12.71  
 for DNA denaturation, 12.28, 12.30  
 iodide solution, 5.32  
 metabisulfite, 14.5, 14.16  
 molybdate for protein stability, 17.16  
 nitrite, A8.27  
 phosphate buffer, A1.5  
 pyrophosphate, 6.56, 7.45  
 inhibition of murine reverse transcriptase, 11.46  
 self-priming, inhibition of, 11.46  
 salicylate scintillant, A9.12
- Software. *See also* Bioinformatics; *specific software programs*  
 microarray image analysis, A10.13  
 Solid-phase radioimmunoassay (RIA), A9.29  
 Solution D (denaturing solution), 7.5  
 Sonication, A8.36–A8.37  
 calibration of the sonicator, A8.36  
 for cell lysis prior to affinity chromatography, 15.38, 15.46  
 of DNA, 12.11, 12.14, 12.15–12.16  
 liposome formation by, 16.7  
 Sorbitol buffer, 4.70–4.71, A1.21  
 Sos recruitment system (SRS), 18.126–18.127  
 South African National Bioinformatics STACK database, A10.15
- Southern hybridization, 1.28  
 advances in, 6.33–6.34  
 alkaline agarose gel, 5.38  
 background, 6.56  
 cDNA library screening, 11.38  
 CHEF gels, 5.82  
 DNA fixation to membranes, 6.45–6.46  
 DNA transfer methods  
 capillary transfer  
 downward, 6.35  
 protocol for, 6.39–6.46  
 to two membranes, 6.35–6.36, 6.47–6.49  
 upward, 6.34–6.35  
 electrophoretic transfer, 6.36  
 fixation of DNA to membranes, 6.45–6.46  
 membranes used for, 6.37–6.38  
 vacuum transfer, 6.37  
 DNase I hypersensitivity mapping, 17.21–17.22  
 electrophoresis buffer choice for, 5.8  
 genomic DNA preparation for, 6.3, 6.16, 6.19–6.21, 6.23  
 hybridization chambers, 6.51, 6.53–6.54  
 at low stringency, 6.58  
 nonradioactive labeling and, 9.76–9.80
- overview of, 6.33–6.38  
 radiolabeled probes, use of  
 low-stringency hybridization, 6.58  
 nonradioactive probes, 6.50  
 overview, 6.50  
 protocol, 6.51–6.55  
 hybridization, 6.54  
 prehybridization, 6.53–6.54  
 washing, 6.54–6.55  
 sensitivity, 6.50  
 stripping from membranes, 6.57  
 for restriction mapping of recombinant cosmids, 4.33  
 TAFE gels, 5.77–5.78  
 troubleshooting, 6.56  
 of YAC clones, 4.63
- Southwestern blotting, 14.32–14.33, 14.36
- Sp1 nuclear factor, 17.8, 17.11, 17.17
- SP6 bacteriophage  
 promoter, 1.11  
 addition to DNA fragments by PCR, 9.37  
 for eukaryotic expression vectors, 11.72  
 in  $\lambda$ ZipLox vector, 11.25  
 in P1 vectors, 4.38  
 primer sequence for, 8.117  
 sequence, 7.87, 9.87  
 RNA polymerase, 9.87–9.88, A4.28–A4.29
- Spacers for sequencing gels, 12.76–12.78
- SPAD (Signaling pathway database), A10.15
- Specialized transducing bacteriophages, 2.18
- Spectrophotometry, A8.19, A8.20–A8.21  
 DNA concentration measurement, 6.11, 6.15  
 quantitative, A9.4  
 RNA concentration estimation by, 7.8, 7.16
- SpeI*, A4.9  
 cleavage at end of DNA fragments, A6.4  
 fragment size created by, table of, A4.8  
 linker sequences, 1.99  
 site frequency in human genome, 4.16, A6.3
- Spermidine, 5.86, A1.28  
 in biolistic transfection protocol, 16.38, 16.40  
 DNA precipitation by, 9.34, 9.36  
 inhibition of PCR by, 8.13  
 in tissue homogenization buffer, 17.6, 17.25  
 in transcription buffer, 7.68, 7.71, 9.32, 9.34
- Spermine, 5.86, 17.6, 17.25
- SphI*, A4.9  
 cleavage at end of DNA fragments, A6.4  
 fragment size created by, table of, A4.8  
 in homopolymeric tailing protocols, 11.111  
 site frequency in human genome, 4.16, A6.3
- Spi* marker, 2.20–2.22
- Spin dialysis, 8.27
- Spliceosome, 18.123
- Splinkerettes, 4.10, 4.76
- Spooling DNA, 6.16–6.18, 6.61
- Spotfire Net image analysis program, A10.13
- Spreeta chip, 18.96
- Spun column chromatography, A8.30–A8.31. *See also* Chromatography; *specific protocols; specific resins*
- SRB, 1.15
- SrfI*  
 fragment size created by, table of, A4.8  
 linker sequences, 1.99  
 site frequency in human genome, 4.16, A6.3
- SSC  
 in dot/slot hybridization, 7.48–7.50  
 in northern hybridization protocols, 7.36, 7.42–7.44  
 recipe, A1.14  
 in Southern hybridization protocols, 6.41, 6.44–6.47, 6.49, 6.51–6.52, 6.55–6.58
- SSCP. *See* Single-stranded conformation polymorphism
- SseI* fragment size created by, table of, A4.8



- S-Sepharose, 15.6  
 SSPE, A1.14  
   in hybridization/prehybridization solutions, 10.35, 10.38  
   in Southern hybridization protocols, 6.51, 6.57  
*SspI*, A4.9  
   fragment size created by, table of, A4.8  
   site frequency in human genome, 4.16, A6.3  
*StII* and genomic DNA mapping, 5.60, 5.69  
 Stability region (*cer*), 1.146  
 Staining  
   glyoxylated RNA, 7.27  
   nucleic acids, A9.3–A9.8  
     ethidium bromide, A9.3–A9.4  
     methylene blue, A9.4–A9.5  
     silver staining, A9.5–A9.7  
     SYBR dyes, A9.7–A9.8  
   SDS-polyacrylamide gels for proteins with Coomassie Brilliant Blue, A8.46–A8.47  
   during immunoblotting, A8.54  
   with silver salts, A8.46–A8.49  
   viability staining, A8.7–A8.8  
 Standing wave acousto-optic modulator (SW-AOM), 18.76–18.77  
*Staphylococcus aureus*  
   genomic resources for microarrays, A10.6  
   protein A. *See* Protein A  
 Starburst dendrimers and facilitation of DEAE transfection, 16.28  
 STE, A1.22  
 Sterol regulatory element-binding proteins (SREBPs), 17.11  
 STES lysis solution, 6.31, 18.39  
 STET, A1.16  
 Sticky ends. *See* Protruding termini  
 Storage media, A2.6  
 Storage of bacterial cultures, A8.5  
 Storm system, A10.11  
 Strains of *E. coli*. *See* *Escherichia coli* strains  
 Strand-separation gel electrophoresis, 7.51–7.52  
 StrataScript, 7.77, 8.48, 9.39  
 StrataScript RT, 11.38  
 Streptavidin, 9.76, 9.78, A9.45  
   BIAcore chips, 18.99  
   in direct selection of cDNAs protocol, 11.98–11.99, 11.103  
   magnetic beads and, 7.20, 11.118–11.119  
 Streptavidin bead-binding buffer, 11.100  
*Streptomyces avidinii*, A9.45  
*Streptomyces hygroscopicus*, 16.49  
 Streptomycin  
   modes of action, A2.7  
   stock/working solutions, A2.6  
 Stripping solution, 6.57  
 Stromelysin, 18.116  
 Stuffer fragment,  $\lambda$ . *See*  $\lambda$  vectors, replacement vectors  
 Substance P, epitope tagging of, 17.92  
 Subtilisin, 9.82, 12.101, 15.8, A4.15  
 Subtracted cDNA probes, 11.29–11.31  
 Subtractive cloning, 11.10–11.11  
 Subtractive screening, 9.90–9.91  
 Sucrose  
   dialysis on bed of, 6.15  
   dye solution, 17.14  
   gel-loading buffer, 2.77–2.78, 2.81, 6.41–6.42  
   for protein expression optimization, 15.19  
 Sucrose gradients  
   cDNA fractionation, 11.9  
    $\lambda$  arm purification, 2.71–2.75  
   mRNA fractionation for cDNA preparation, 11.9  
   preparing, 2.81–2.82  
   size fractionation of genomic DNA, 2.81–2.82  
 Sulfoindocyanine (Cy) dyes, 18.80. *See also* Cy3 dye; Cy5 dye  
 Sulfosalicylic acid, A8.46  
 Sulfuric acid, A1.6  
*SUP4*, 4.3, 4.59–4.60  
*supB*, A7.6  
*supC*, A7.6  
*supD*, A7.6  
*supE*, 11.23–11.24, A7.5, A7.6  
    $\lambda$  propagation and, 2.28–2.29  
   M13 vectors and, 3.11–3.13  
 SuperCos-1, 4.5, 4.12, 4.14, 4.18–4.19, A3.5  
 SuperFect, 16.5  
 Superinfection  
   frozen cultures, using, 3.47  
   phagemids/helper virus, 3.47  
 Supernatants, aspiration of, 1.33, 1.36, 1.45  
 SuperScript, 8.48, 11.12, 11.38  
 SuperScript II, 9.39, 11.38, 11.108  
*supF*, 2.23, 2.28–2.29, 11.23–11.24, 11.66, 14.37, 14.47, A7.5–A7.6  
 Supplemented minimal medium (SMM), A2.9–A2.10  
 Suppressor tRNA gene, 4.3  
 SURE *E. coli* strains, 1.15, 1.25  
 Surface plasmon resonance (SPR), 18.4, 18.96–18.114  
   concentration measurement, 18.102  
   data collection, 18.100–18.101  
   instruments of, 18.96  
   kinetic measurements, 18.101–18.102  
   overview, 18.97–18.98  
   protocol, 18.103–18.114  
     capture surface preparation, 18.105  
     data analysis, 18.112–18.114  
     design, 18.103  
     kinetic analysis, 18.108–18.114  
     test binding, 18.106–18.107  
     schematic of, 18.97  
     sensor chips, 18.98–18.100  
     regeneration of surface, 18.100  
 SurfZAP, A3.3  
 Suspension cultures, lysis of mammalian cells in, 637  
 SV40  
   COS cells and, 11.114  
   intron and polyadenylation signal in pTet vectors, 17.58  
   origin of replication, 11.68, 11.114, 17.49  
   T antigen, epitope tagging of, 17.92  
 SV40 promoter  
   in p $\beta$ -gal reporter vectors, 17.49  
   in pCAT3 vectors, 17.35  
   in pd2EGFP vectors, 17.88  
   in pGL3 vectors, 17.43  
   in pSPL3, 11.82, 11.85, 11.89  
   in pSV2CAT vector, 17.95  
*SwaI*  
   fragment size created by, table of, A4.8  
   site frequency in human genome, 4.16, A6.3  
 Swiss Blue. *See* Methylene blue  
 SWISS\_PROT, A10.15  
 SYBR dyes, overview, A9.7–A9.8  
 SYBR Gold, 1.53, A9.7–A9.8  
   in agarose gel electrophoresis, 5.11, 5.15–5.16  
   photography, 5.16–5.17  
   polyacrylamide gel staining, 5.47–5.48  
   in quantitation of DNA, A8.24  
   removal from gels, 5.15  
   resolution of, 5.15  
   sensitivity of, 5.12  
   staining solution recipe, A1.29  
 SYBR Green, A9.7–A9.8  
   in real time PCR, 8.94, 8.95  
 Sybron SIL G/UV254 TLC plates, 17.38  
 Synthetic dextrose minimal medium (SD), A2.10  
 Synthetic minimal (SM) recipe, A2.9  
 SYSTERS database, A11.22  
 T vectors  
   cloning PCR products into, 8.31, 8.35–8.36  
   creating, 8.35  
   stability of 3' unpaired residues, 8.36  
 T2 *dam* methylase, A4.7  
 T3 bacteriophage  
   promoter, 1.11, 1.13  
     addition to DNA fragments by PCR, 9.37  
     in cosmid vectors, 4.5, 4.33  
     for eukaryotic expression vectors, 11.72  
     in  $\lambda$ ZAP vectors, 11.22  
     in  $\lambda$ ZipLox vector, 11.25  
     primer sequence for, 8.117  
     in ribonuclease protection assay protocol, 7.69  
     sequence, 7.87, 9.37, 9.87  
     RNA polymerase, 9.87–9.88  
 T4 bacteriophage  
   DNA ligase, 1.157–1.158, 3.37, A4.31–A4.32, A4.34  
     activity of, A4.31  
     blunt end ligation, A4.32  
     cohesive termini/nick ligation, A4.32  
     inactivation, 1.102  
     inhibition by dATP, 1.85  
     linker/adaptor attachment to cDNA, 11.54  
     uses, list of, A4.31  
   DNA polymerase  
     3'-5' exonuclease activity, 11.121  
   polynucleotide kinase. *See* Polynucleotide kinase, bacteriophage T4  
   RNA ligase, 1.157  
 T4 *dam* methylase, A4.7  
 T5A3 gene, 2.21  
 T7 bacteriophage  
   DNA polymerase in DNA sequencing  
     automated, 12.98  
     dye-primer sequencing, 12.96  
   promoter, 1.11–1.13, A4.28  
     addition to DNA fragments by PCR, 9.37  
     in cosmid vectors, 4.5, 4.33  
     for eukaryotic expression vectors, 11.72  
     for expression of cloned genes in *E. coli*, 15.3–15.4, 15.20–15.24  
     large-scale expression, 15.24  
     materials for, 15.22  
     optimization, 15.23–15.24  
     overview, 15.20–15.22  
     protocol, 15.23–15.24  
     regulation by lysozyme, 15.24  
   in  $\lambda$ ZAP vectors, 11.22  
   in  $\lambda$ ZipLox vector, 11.25  
   in M13-100 vector, 3.10  
   in P1 vectors, 4.38  
   primer sequence for, 8.117  
   in ribonuclease protection assay protocol, 7.69  
   sequence, 7.87, 9.37, 9.87  
   protein interaction network in, 18.123  
   RNA polymerase, 9.87–9.88  
     in binary expression systems, 9.88  
     lysozyme inhibition of, 9.88  
 T7-Tag, epitope tagging, 17.93  
*tac* promoter, 15.3, 15.40  
 TAE. *See* Tris-acetate-EDTA electrophoresis buffer  
 TAFE. *See* Transverse alternating field electrophoresis  
 TAFE gel electrophoresis buffer, A1.18  
 TAIL PCR, 4.75  
 Tailing reaction  
   in 5'-RACE procedure, 8.58–8.59  
   in cDNA cloning, 11.3–11.4, 11.15  
   digoxigenin labeling of nucleic acids, A9.38–A9.39  
   homopolymers, 11.110–11.111  
   terminal transferase and, 8.111  
 Talon, 15.46

- Tamra, 8.95  
 TAP90 *E. coli* strain  
   genotype, A3.9  
    $\lambda$  vector propagation, 2.28  
 Tape, gel-sealing, 12.76, 12.78  
 Taq dilution buffer, 12.48, A1.9  
 Taq DNA polymerase, 8.4, 8.6–8.7, 8.10, A4.22–A4.23. *See also* AmpliTaq DNA polymerase; DNA polymerase, thermostable  
   for cDNA second-strand synthesis, 11.14  
   in differential display-PCR, 8.98  
   digoxigenin labeling of nucleic acids, A9.38–A9.39  
   in DNA sequencing, 12.45–12.50  
     automated, 12.98  
     dye-primer sequencing, 12.96  
     materials for, 12.48–12.49  
     method, 12.49–12.50  
     overview, 12.45–12.47  
     reaction mixtures, table of, 12.48  
     steps involved, 12.47  
     version of *Taq*, 12.46–12.47  
   error rate, 8.108–8.109  
   in exon trapping, 11.91–11.93  
   heat tolerance of, 8.8  
   incorrect base incorporation, 8.77  
   inhibition by dyes, 1.53  
   in-house preparation, 8.108–8.109  
   inosine and, 12.109  
   in megaprimer PCR mutagenesis method, 13.33  
   in misincorporation mutagenesis, 13.80  
   overview of, 8.108–8.109  
   polymerization rate, 8.9  
   properties of, 8.10, 8.108, A4.11, A4.23  
   rapid screening of bacterial colonies or  $\lambda$  plaques by PCR, 8.74–8.75  
   in RT-PCR, 8.49  
   site-directed mutagenesis, oligonucleotide design for, 13.82  
   stability of, 8.25, 8.30, 8.108  
   Stoffel fragment, 8.109  
   storage, 8.19  
   temperature optimum, 8.9  
   terminal transferase activity, template-independent, 8.30, 8.35  
   variations in preparations of, 8.6  
 Taq gene, 8.108–8.109  
 TaqEXPRESS, 12.46  
 TaqI, 13.87, A4.3, A4.9  
 TaqI methylase, A4.5, A4.7  
 TaqMan method of real time PCR, 8.95  
 TaqPlus  
   in circular mutagenesis, 13.20  
   Long PCR System, 8.7, 8.77  
 TaqStart, 8.110  
 Taquenase  
   in cycle sequencing reactions, 12.46–12.47  
   structure of, 12.47  
 tat gene, HIV, 11.82  
 Taurine in electrophoresis buffers, 12.108, 13.90  
 TBE. *See* Tris-borate-EDTA electrophoresis buffer  
 Tbr DNA polymerase, 8.7, 8.10, A4.23  
 TE (Tris EDTA) buffer, A1.7  
 TEACl. *See* Tetraethylammonium chloride  
 Tecan GENESIS sample processor, A10.5  
 Telomeric repeat (TEL) sequences in YACs, 4.59  
 TEMED (*N,N,N',N'*-tetramethylethylene diamine), 5.41, 5.43, 5.45, 12.75, 12.79, 12.82, 13.53–13.54, A8.42  
 Temperate bacteriophages, 2.9. *See also*  $\lambda$ ; P1  
 TEN buffer, A1.22  
 Terminal deoxynucleotidyl transferase, A4.27  
   activity in DNA polymerases, 8.30, 8.35  
   in cDNA second-strand synthesis, 11.17  
   digoxigenin labeling of nucleic acids, A9.38–A9.39  
   in end-labeling, 9.55–9.56  
     for chemical sequencing of DNA, 12.73  
   homopolymeric tailing, 11.110  
   inactivation of, 8.59  
   in lymphocytes, 8.112  
   overview of, 8.111–8.112  
   5'-RACE protocol, 8.54–8.60  
   requirements of, 8.111  
 Terminal transferase. *See* Terminal deoxynucleotidyl transferase  
 Terminal transferase buffer, A1.11  
 Terminal transferase (tailing) buffer, A1.11–A1.12  
 Terminase,  $\lambda$ , 2.15, 4.5, 4.30  
 Terrific Broth recipe, A2.4  
 TES, A1.22  
 TESS (Transcription Element Search System) program, A11.13  
 TetA, 17.53  
 tetO, 17.53–17.58  
 tetP, 17.57  
 TetR, 17.53–17.56, 18.11  
 Tetracycline, 1.9  
   electroporation efficiency of *tet*-resistant transformants, 1.26  
   entry into cells, 17.53  
   mechanism of action, 17.53  
   mechanism of resistance to, 1.147  
   modes of action, A2.7  
   for protein expression optimization, 15.19  
   regulation of inducible gene expression, 17.52–17.70  
     autoregulatory system, 17.56, 17.70  
     reduced basal activity, 17.56–17.59  
     repression system, 17.54  
     reversed activator, 17.55–17.56  
     schematic representation of repression system, 17.54  
   Stage 1: Stable transfection of fibroblasts pTet-tTAk, 17.60–17.64  
   Stage 2: Stable transfection of inducible t-TA-expressing NIH-3T3 cells with tetracycline-regulated target genes, 17.65–17.69  
   Stage 3: Analysis for protein expression in transfected cells, 17.68–17.69  
   *trans*-activator, 17.54–17.55  
   in transiently transfected cells using the autoregulatory tTA system, 17.70  
   troubleshooting, 17.59  
   resistance, 17.53  
   selecting transformants, 1.110, 1.115, 1.118  
   structure of, 1.146, 17.52–17.53  
 Tetracycline repressor (TetR), 17.53–17.56, 18.11  
 Tetracycline resistance (*ter*), 1.9, 1.147  
   in  $\lambda$ ZAP, 14.6  
   mechanism of resistance, 1.147  
   in positive selection vectors, 1.12  
 Tetracycline-responsive element (TRE), 17.32  
 Tetracycline stock/working solutions, A2.6  
 Tetraethylammonium chloride (TEACl), 10.6, 10.35–10.37  
 Tetrahymena, 4.59  
 Tetramethylammonium chloride (TMACl), 8.9, 10.6, 10.35–10.37  
 3,3', 5,5'-tetramethylbenzidine (TMB), A9.35  
 TEV (tobacco etch virus) protease, 15.8  
 Texas Red, A9.33  
 TFASTX/TFASTY program, A11.19  
 TFBIND program, A11.13  
 Tfi DNA polymerase, 8.10, A4.23  
 Tfx, 16.5, 16.7, 16.11  
 TG1 *E. coli* strain, 13.12–13.13  
   cell-wall component shedding and DNA purification, 1.18  
   genotype, A3.9  
   M13 vectors and, 3.12, 3.16  
 TG2 *E. coli* strain  
   genotype, A3.9  
   M13 vectors and, 3.12  
   phagemids and, 3.44  
 Thermal asymmetric interlaced (TAIL) PCR, 4.75  
 Thermal cycle DNA sequencing. *See* Cycle DNA sequencing  
 Thermal cycler, 8.19–8.22, 8.112. *See also* Polymerase Chain Reaction  
 ThermoSequenase  
   in DNA sequencing  
     automated, 12.98  
     cycle sequencing reactions, 12.46–12.47  
     dye-primer sequencing, 12.96  
   inosine and, 12.110  
   structure of, 12.47  
 Thermostable DNA polymerases. *See* DNA polymerase, thermostable; *specific polymerases*  
*Thermus aquaticus*, 8.4, 8.6–8.7, A4.22. *See also* Taq DNA polymerase  
 $\theta$  (Theta) structures, 1.6, 2.11–2.12, 3.2  
 Thin-layer Chromatography (TLC) for CAT measurement in extracts from mammalian cells, 17.36–17.39  
 Thionucleotides, resistance to exonuclease III, 13.75  
 Thiopropyl-Sephrose, 15.6  
 Thioredoxin, 14.47, 15.9, 15.26  
 Thiourea, 17.12  
 3B3, epitope tagging, 17.93  
 3D-Ali database, A11.22  
 Threonine  
   codon usage, A7.3  
   nomenclature, A7.7  
   properties, table of, A7.9  
 Thrombin, 15.39–15.40, 15.43  
 Thymidine, hydrazine cleavage of, 13.78  
 Thymidine glycosylase, 13.94  
 Thymidine kinase gene, 1.15, 16.47–16.48, 17.33  
 Thymine, A6.9  
   carbodiimide modification, 13.95  
   osmium tetroxide modification of, 13.95  
   related compounds (Table A6-8), A6.9  
   structure, A6.9  
 Thyroglobulin for protein stability, 17.16  
 Thyroid receptor resource database, A11.21  
 Thyroid-stimulating hormone (TSH), 18.104–18.114  
 TIGR Gene Indices, A10.15  
 TIGR Spotfinder image analysis program, A10.13  
 TIMP-2, A5.1  
 Tissue homogenization buffer, 17.6, 17.25  
 Tissue microarrays, A10.18  
 Tissue plasminogen activators, 18.116  
 Tissue resuspension buffer, 17.6  
 Tissues  
   DNA isolation  
     hemoglobin contamination, 6.7–6.8, 6.17–6.18  
     from mouse tails, 6.23–6.27  
     for pulsed-field gel electrophoresis, 5.61–5.64  
   homogenization of, 6.7–6.8  
   lysis of, 6.7–6.8, 6.17  
   nuclear extract preparation from, 17.8–17.9  
   RNA, DNA, and protein simultaneous preparation, 7.9–7.12  
   RNA isolation by acid phenol-guanidinium thiocyanate-chloroform extraction, 7.4–7.8  
 TKM buffer, 11.87  
 TLCK, A5.1  
 Tli DNA polymerase, A4.23  
 TliVent DNA polymerase, 8.11  
 TM buffer recipe, A2.8  
 TMACl. *See* Tetramethylammonium chloride  
 TMB. *See* 3,3', 5,5'-tetramethylbenzidine  
 tmRNA database, A11.22  
 TM-TPS, 16.11  
 Tn9 transposon, 13.88

- TNT buffer, 14.5, 14.8–14.9, 14.15, 14.18–14.19  
 TolA/TolR/TolQ proteins, 3.6  
 Toldo and Oligonucleotide Calculator program, 13.89  
 Tomtec Quadra, A10.5  
 Toothpick minipreparations of plasmid DNA, 1.51–1.54  
 Topoisomerase I (Topo I), 1.4, 2.16, A4.52  
 Tosyl-L-lysine-chloromethyl ketone as protease inhibitor, 15.19  
 Touchdown PCR, 8.112  
   in MOPAC protocol, 8.70  
   multiplex PCR, 8.107  
   quantitative PCR, 8.89  
 Toxic proteins  
   choosing appropriate strain of *E. coli*, 1.15  
   low-copy-number plasmid vectors, 1.12  
 TPCK, A5.1  
 TPE. *See* Tris-phosphate-EDTA electrophoresis buffer  
*traA* gene, 4.49  
 Tracking dyes  
   in denaturing agarose gels, 7.23  
   in polyacrylamide gels, 7.57  
*traD36*, 3.10, 3.12–3.13  
 Tran<sup>35</sup>S-label, 15.18  
 Transcription buffer, 7.68, 7.71, 9.32  
 Transcription factor E2F1, 18.11  
 Transcription factor GATA-1 in positive selection vectors, 1.12  
 Transcription factors, screening cDNA libraries for, 11.33  
 Transcriptional activation domain  
   activation domain fusion plasmids, 18.20  
   two-hybrid system and, 18.6, 18.14, 18.20, 18.36  
 Transcriptional run-on assays, 17.23–17.29  
   materials for, 17.24–17.26  
   nuclei isolation, 17.26–17.27  
     from cultured cells, 17.26  
     from tissue, 17.27  
   overview of, 17.23–17.24  
   radiolabeling transcripts  
     from cultured cell nuclei, 17.27  
     from tissue nuclei, 17.27–17.28  
 Transcriptional silencers (tTS), 17.56  
 Transduction of the P1 recombinant plasmid, 4.46  
 Transfac program, A11.12  
 Transfast transfection, 16.5  
 Transfectam, 16.5, 16.8–16.9, 16.11  
 Transfection, 16.1–16.57  
   biolistics, 16.3, 16.37–16.41  
     materials for, 16.38–16.39  
     method, 16.39–16.41  
     particle types, 16.37  
     variables, 16.37  
   calcium-phosphate-mediated, 16.3, 16.14–16.26, 16.52–16.53  
     of adherent, 16.25  
     of cells growing in suspension, 16.25  
     chloroquine treatment, 16.14, 16.17, 16.52  
     cotransformation, 16.24  
     efficiency, factors affecting, 16.52  
     with genomic DNA, 16.21–16.24  
     glycerol shock, 16.14, 16.17, 16.52  
     high efficiency, 16.19  
     mutation prevalence, 16.53  
     with plasmid DNA, 16.14–16.20  
     sodium butyrate, 16.14, 16.17–16.18  
   cell line variation, 16.57  
   controls, 16.4–16.5  
     for stable expression, 16.4–16.5  
     for transient expression, 16.4  
   cotransformation, 16.24, 16.47  
   by DEAE-dextran, 16.3, 16.27–16.32  
     calcium phosphate method compared, 16.27  
     cell viability, increasing, 16.32  
     facilitators of, 16.28  
     kits, 16.30  
     materials for, 16.29–16.30  
     mechanism of action, 16.27  
     method, 16.30–16.31  
     mutation prevalence, 16.28, 16.53  
     variables, 16.27–16.28  
   electroporation  
     efficiency, factors influencing, 16.33–16.34, 16.57  
     of mammalian cells, 16.3, 16.33–16.36, 16.54–16.57  
     materials for, 16.34–16.35  
     method, 16.35–16.36  
     for FLIM-FRET analysis, 18.84–18.86  
   by lipofection, 16.3, 16.7–16.13  
     chemistry of, 16.50  
     lipids used in, 16.8, 16.11, 16.51  
     materials for, 16.7–16.11  
     optimizing, 16.51  
     overview of, 16.50–16.51  
     protocol, 16.12–16.13  
   methods, summary of, 16.3  
   polybrene, 16.3, 16.43–16.46  
   stable, selective agents for, 16.48–16.49  
   tetracycline regulation of inducible gene expression and, 17.60–17.70  
   transient vs. stable, 16.2  
 Transfection Reagent Optimization System, 16.7  
 Transfection Reagent Selector Kit, 16.5  
 Transfer buffers  
   for alkaline transfer of RNA to charged membranes, 7.36, 7.38  
   in Southern hybridization, 6.40–6.41, 6.44, 6.46–6.47, 6.49  
 Transformation. *See also* Transfection  
   of blunt-ended fragment ligations, 1.92  
   cell density and, 1.108, 1.112, 1.114, 1.117, 1.120–1.121  
   cell preparation, 1.107–1.109, 1.113–1.114, 1.117–1.118  
   controls, 1.111  
   in directional cloning procedures, 1.87  
   DnD solution, 1.106, 1.109  
   by electroporation, 1.25–1.26, 1.119–1.122  
   freezing of competent cells, 1.114–1.115  
   frozen storage buffer, 1.106, 1.108  
   glassware cleanliness and efficiency of, 1.105–1.106  
   Hanahan method, 1.105–1.110  
   Inoue method, 1.112–1.115  
   in M13 cloning, 3.37–3.38  
   of mammalian cells by YACs, 4.63–4.64  
   overview, 1.24–1.26  
   plasmid size and efficiency, 1.9  
   of plasmids with inverted repeats, 1.15  
   strain of *E. coli*, choosing appropriate, 1.14–1.15  
   using calcium chloride, 1.116–1.118  
   yeast spheroplasts, 4.60  
 Transformation buffer, 1.106–1.107  
 Transformer kit, 13.27  
 Transformer site-directed mutagenesis kit, 13.89  
 Transition mutations, 13.78  
 Translation initiation, optimization of, 15.11–15.12  
 Translational coupling, 15.12  
 Transposons and kanamycin resistance, 1.145  
 Transverse alternating field electrophoresis (TAFE), 5.56–5.57, 5.74–5.78  
   electrode configuration, 5.57  
   high-capacity vector insert size determination, 4.18  
   method, 5.76–5.78  
   pulse times, 5.74–5.75  
   resolution, 5.74  
   silver staining, 5.77  
   Southern blots, 5.77–5.78  
*trc* promoter, 15.3  
 TreeView program, A10.15  
 TRI reagent, 7.10  
 Triazol reagent, 7.10  
 Trichloroacetic acid (TCA), A1.29  
   in oligonucleotide synthesis, 10.42, 10.49  
   polyacrylamide gel fixation, 7.56, 7.61–7.62, 7.68  
   precipitation of nucleic acids with, A8.25–A8.26  
 Trifluoroacetic acid, A9.32  
 Tris buffers  
   deficiencies of, A1.3  
   general, A1.2  
   preparation with various pH values, table of, A1.2  
 Tris-Cl, A1.7  
 Tris EDTA (TE) buffer, A1.7  
 Tris magnesium buffer (TM), A1.8  
 Tris-acetate-EDTA (TAE) electrophoresis buffer, 5.8, 5.76, A1.17  
 Tris-borate-EDTA (TBE) electrophoresis buffer, 5.8, 12.75, 12.84, 12.87  
   ligation reaction inhibition, 5.30  
   polyacrylamide gel electrophoresis, 5.43  
   for pulsed-field gel electrophoresis, 5.60  
   recipe, A1.17  
   in SSCP protocol, 13.52  
   for TAFE, 5.76  
 Tris-buffered saline (TBS), A1.8  
 Tris-buffered saline with dextrose (TBS-D), 16.29–16.31  
 Tris-glycine, A1.17  
 Tris-glycine electrophoresis buffer, A8.42–A8.43  
 Tris-phosphate-EDTA (TPE) electrophoresis buffer, 5.8, A1.17  
 Tris-SDS chromatography buffer, 10.25–10.26  
 Tris-sucrose, A1.22  
 Triton X-100  
   in cell lysis buffers, 17.36, 17.44–17.45  
   inclusion bodies recovery using, 15.51  
   luciferase and, A9.22  
   in preparation of fixed cells for FLIM-FRET analysis, 18.87  
   for solubilization of GST fusion proteins, 15.38–15.39  
   in supershift assays, 17.17  
   in washing solution for inclusion bodies, 15.10  
 Triton/SDS solution, 4.68, A1.22  
 tRNA carrier RNA, 7.69  
 tRNA genes, higher-plant mitochondria database, A11.21  
 tRNA suppressor, A7.5  
 tRNAscan-SE program, A11.15  
*trp* promoter, 15.3  
*TRP1*, 4.3, 4.60, 18.20, 18.22, 18.43  
*trpC* mutation, 18.43  
*trpE* gene, 11.109  
 TRRD (Transcriptional Regulatory Region Database), A11.20  
*trx* gene, *E. coli*, 12.104  
 Trypan blue dye, 17.20  
 Trypanosomes, 1.150, A9.3  
 Trypsin, 15.8, 16.12, 18.66–18.68, A1.8  
 Tryptophan  
   auxotrophy and YAC vectors, 4.60, 4.65  
   codon usage, A7.3  
   nomenclature, A7.7  
   properties, table of, A7.9  
 Tryptophan-inducible expression systems, 15.25–15.26, 15.28–15.29  
 TSSG program, A11.13  
 TSSW program, A11.13, A11.20  
 tTA (trans-Transcriptional Activator), 17.54–17.60, 17.64–17.65, 17.70  
*Tho* DNA polymerase, 8.10, 8.48  
   for cDNA second-strand synthesis, 11.14  
   in circular mutagenesis, 13.20

- in overlap extension method of mutagenesis, 13.37  
 properties, table of, A4.23  
*Tth*HBI, A4.9  
 TthStart, 8.110  
*Tub* polymerase, 8.10  
 Tungsten in biolistics, 16.38–16.39  
 Tween-20  
 in blocking buffer, 14.4, 14.15, 14.23, 14.26  
 in DNA sequencing protocols, 12.55  
 in PCR lysis solution, 6.22  
 for solubilization of GST fusion proteins, 15.38–15.39  
 in supershift assays, 17.17  
 in TNT buffer, 14.5, 14.13  
 Two-hybrid system. *See* Protein-protein interactions, two-hybrid system  
 Tyrosine  
 codon usage, A7.3  
 Lck tyrosine kinase, 18.7  
 nomenclature, A7.7  
 phosphorylation, 14.2  
 properties, table of, A7.9  
 Tyrosine kinase, 18.7  
 Ubiquitin-based split-protein sensor (USPS)  
 method, 18.125–18.126  
 UDG system, 11.105  
 U gene,  $\lambda$ , 2.15  
*Ult* DNA polymerase, 8.10, A4.23  
 Ultraspiracle protein (USP), 17.71  
 Ultraviolet (UV) radiation  
 damage to DNA, 1.67, 1.151, 5.20, 5.24  
 DNA fixation to membranes by, 1.135, 1.137, 2.94–2.95, 6.46, 7.36  
 ethidium bromide fluorescence, 1.151  
 inactivation of contaminating DNA in PCRs, 8.16–8.17  
 oligonucleotide visualization in polyacrylamide gels, 10.16  
 photography of DNA in gels, 5.16–5.17  
 RNA fixation to nylon membranes by, 7.40  
*umuC* gene, 1.15  
*umg*, 13.11–13.15, 13.77, 13.84–13.85  
 UniGene, 10.15, A10.4  
 Unique restriction site elimination (USE). *See* USE mutagenesis  
 Universal bases, 10.9–10.10, 11.32  
 Universal KGB (restriction endonuclease buffer), 8.32, A1.12  
 Universal primers, 8.113–8.117  
 for  $\lambda$ gt10/ $\lambda$ gt11, 8.116  
 for M13 vectors, 8.115  
 for pBR322, 8.114  
 for pUC vectors, 8.115  
 transcription promoter primers, 8.117  
 Uni-ZAP in commercial kits for cDNA synthesis, 11.108  
*URA3*, 4.3, 4.60, 18.11–18.12, 18.22  
 Uracil, A6.9  
 auxotrophy and YAC vectors, 4.60, 4.65  
 related compounds (Table A6-9), A6.9  
 structure, A6.9  
 Uracil DNA glycosylase (UDG), 8.17, 11.121–11.123, 13.79, 13.84, A4.51  
 Uracil tryptophan drop-out medium, 4.65  
 Uracil-substituted DNA, preparation of M13, 13.11–13.14  
 Uranyl salts, 17.77  
 Urea  
 denaturing fusion proteins with, 15.7  
 in denaturing polyacrylamide gels, 7.58, 12.74, 12.78  
 inclusion bodies recovery using, 15.52  
 solubilization of, 12.78  
 for solubilization of inclusion bodies, 15.54  
 Urease antibody conjugates, A9.34  
 uRNA database, A11.22  
 USE mutagenesis, 13.26–13.30, 13.85, 13.89  
 UTP, digoxigenin coupled, A9.38  
 UV light. *See* Ultraviolet (UV) radiation  
*uvrC* gene, 1.15  
 V protein,  $\lambda$ , 2.15  
 V8 protease, 18.64  
 Vacuum aspiration, 6.10  
 Vacuum transfer of DNA to membranes, 6.37  
 Valine  
 codon usage, A7.3  
 nomenclature, A7.7  
 properties, table of, A7.9  
 Vanadyl ribonucleoside complexes, 7.83  
 VCISM13, 3.44, 18.116  
 Vector alignment search tool (VAST), A11.22  
 Vectorette PCR, 4.10, 4.74–4.81  
 protocol method, 4.78–4.81  
 rescuing termini of YAC genomic inserts, 4.63  
 scheme, diagram of, 4.77  
 splinkerettes, 4.76  
 Vectors. *See also* Cosmids; Expression vectors;  $\lambda$  vectors; M13 vectors; Plasmid vectors;  
 Vectors, high-capacity; *specific vectors*  
 phagemids, 3.42–3.49  
 positive selection, 1.12  
 table of, A3.2–A3.5  
 $\lambda$ , A3.3  
 mammalian, A3.3–A3.4  
 plasmid/phagemid, A3.2–A3.3  
 shuttle vectors, A3.4–A3.5  
 yeast, A3.4  
 Vectors, high-capacity, 4.1–4.86. *See also specific vectors*  
 BACs, 4.2, 4.58–4.73  
 bacterial P1, 4.4, 4.35–4.47  
 cosmids, 4.4–4.5, 4.11–4.34  
 genomic library construction  
 arrayed libraries, 4.8  
 chromosome walking, 4.8–4.10  
 overview, 4.6–4.7  
 vector choice, factors influencing, 4.7–4.10  
 insert size measurement by pulsed-field gel electrophoresis, 4.18  
 large DNA fragment cloning products and services, 4.86  
 P1 artificial chromosomes, 4.4, 4.40–4.44  
 table of, 4.2  
 vectorette PCR isolation of genomic ends, 4.74–4.81  
 YACs, 4.2, 4.58–4.73  
*Vent* DNA polymerase, 8.85  
*VentR* DNA polymerase, 13.37  
 Vesicular stomatitis virus (VSV) G protein, epitope tagging, 17.93  
 Viability staining, A8.7–A8.8  
*Vibrio harveyi*, A9.21, A9.23  
 Vienna RNA package program, A11.15  
 Viroid and viroid-like RNA sequence database, A11.22  
 Virus. *See* Bacteriophages  
 Vitamin H. *See* Biotin  
 von Hippel-Lindau tumor suppressor protein (pVHL), 18.60, 18.62  
 Wallace Rule, 10.3  
 Wash buffer (Qiagen), A1.22  
 Wash solutions. *See specific protocols; specific solutions*  
 wconsensus program, A11.14  
 Webin program, A11.3  
 Wedge gels, 12.83  
 Weiss unit of ligase activity, 1.159  
 Western blotting, A9.28  
 in coimmunoprecipitation protocol, 18.63  
 epitope tagging, 17.91  
 ubiquitin-based split-protein sensor (USPS)  
 method, 18.125  
 Whatman 3MM CHR paper for polyacrylamide gel drying, 12.92  
 Whatman 541 filter papers for screening bacterial colonies by hybridization, 1.126  
 White blood cells, DNA isolation from, 5.63–5.64  
 WIT database, A10.15  
 Wizard, 1.64  
 Wizard PCR Preps Purification System, 8.26–8.27  
 WU-BLAST (Washington University BLAST) program, A11.19  
 Xanthine, structure of, A6–10  
 Xanthine monophosphate (XMP), 16.49  
 Xanthine oxidase  
 chemiluminescent enzyme assay, A9.19  
 as digoxigenin reporter enzyme, 9.77  
 Xanthine-guanine phosphoribosyltransferase, 16.47  
*Xba*I  
 7-deaza-dGTP modified DNA, cleavage of, 8.60  
 cleavage at end of DNA fragments, A6.4  
*dam* methylation and, 13.87, A4.3  
 fragment size created by, table of, A4.8  
 linker sequences, 1.99  
 site frequency in human genome, 4.16, A6.3  
 terminal/subterminal site cleavage, inefficient, 8.38  
*Xcm*I for T vector creation, 8.35  
*Xenopus* oocytes, 11.68, 11.75–11.76, 11.78  
 controls, experimental, 11.70  
 vector systems for, 11.72  
 X-gal, 1.27, 17.97, 17.99  
 $\alpha$ -complementation and, 1.150  
 direct addition to plates, 1.125  
 in histochemical stain, 16.13  
 history of, 1.150  
 in  $\lambda$  vector plaque-assay, 2.30  
 protocol for use in screening colonies, 1.123–1.125, 1.150  
 recipe, A1.29  
 in two-hybrid system of protein-protein interaction study, 18.24–18.25, 18.36–18.37  
 use in pUC vectors, 1.10  
 use with M13 vectors, 3.8, 3.19, 3.38  
 in yeast selective X-gal medium, 18.18, 18.31, 18.40  
 X-gal indicator plates for yeast, A2.10–A2.11  
 X-gal plates for lysed yeast cells on filters, A2.11  
 X-GlcA (5-bromo-4-chloro-3-indolyl- $\beta$ -D-glucuronide), 16.42  
*Xho*I  
 cDNA adaptors and, 11.51  
 cDNA protection against, 11.40  
 cleavage at end of DNA fragments, A6.4  
 fragment size created by, table of, A4.8  
 genomic DNA mapping, 5.69  
 linker sequences, 1.99  
 methylation, A4.7  
 regeneration of site, 1.100  
 site frequency in human genome, 4.16, A6.3  
 terminal/subterminal site cleavage, inefficient, 8.38  
*Xho*II, *dam* methylation and, 13.87, A4.3  
 XL1-Blue *E. coli* strain, 11.23–11.25, 11.61–11.62, 11.66, 14.6  
 genotype, A3.9–A3.10  
 $\lambda$  vector propagation, 2.29  
 for M13, 12.21, 12.23  
 M13 vectors and, 3.12, 3.16, 3.18  
 phagemids and, 3.42, 3.46  
 XL1-Blue MRF<sup>+</sup> *E. coli* strain, 11.25  
 in circular mutagenesis protocol, 13.25  
 genotype, A3.10  
 M13 vectors and, 3.13

- phagemids and, 3.42, 3.46
- XI.1-Blue MRF Kan strain, 3.18
- Xma*I, A4.7, A6.4
- Xmn*I, A4.9
- Xor*II, A4.7
- XS101 *E. coli* strain
  - M13 vectors and, 3.13
  - phagemids and, 3.42
- XS127 *E. coli* strain
  - genotype, A3.10
  - M13 vectors and, 3.12
  - phagemids and, 3.42
- xseA* gene, 7.86
- xseB* gene, 7.86
- xth* gene of *E. coli*, 13.73
- Xylene cyanol FF
  - in agarose gel electrophoresis gel-loading buffers, 1.53, 5.9
  - in denaturing agarose gels, 7.23
  - in formaldehyde gel-loading buffer, 7.32
  - in formamide dye mix, 7.77, 17.6
  - inhibition of PCR by, 8.13
  - migration rate through polyacrylamide gels, 12.89
  - oligonucleotide size and comigration in polyacrylamide, 10.15
  - polyacrylamide gel electrophoresis, 5.42, 7.57
  - in RNA gel-loading buffer, 7.68
  - in sucrose dye solution, 17.14
  - Taq* polymerase inhibition by, 1.53
- Y1089 *E. coli* strain, 15.19
  - for fusion protein expression, 14.39, 14.48
  - genotype, A3.10
- Y1090 *E. coli* strain, 15.19
- Y1090*hsdR* *E. coli* strain, 11.59–11.60, 11.62, 11.66, 14.6, 14.27
  - for fusion protein expression, 14.37, 14.39, 14.42, 14.45, 14.47–14.48
  - genotype, A3.10
  - $\lambda$  vector propagation, 2.28
- Y1090(ZL) *E. coli* strain, 11.61–11.62, 11.66
- YAC. See Yeast artificial chromosomes (YACs)
- YCp (yeast centromere plasmid), A3.5
- Yeast. See also *Saccharomyces cerevisiae*; Yeast artificial chromosomes
  - carrier tRNA, 5.20
  - DNA
    - isolation, rapid protocol, 6.31–6.32
    - preparation for pulsed-field gel electrophoresis, 5.65–5.67
  - gene expression patterns and microarray technology, A10.2
  - genomic resources for microarrays, A10.6
  - lysis buffer, 5.66
  - media, 4.65
  - media for the propagation and selection of, A2.9–A2.11
  - resuspension buffer, A1.22
  - screening colonies by PCR, 8.75
  - selective X-gal medium, 18.18, 18.31, 18.40
  - splice sites database, A11.20
  - tRNA as carrier in ethanol precipitation of DNA, A8.13
  - vectors, A3.4
- Yeast artificial chromosomes (YACs), 4.58–4.73, A3.4
  - arrayed libraries, 4.8
  - CEPH Mega YAC Library, 4.9
  - chimeric clones, 4.10, 4.62
    - detection of, 4.61
    - frequency of, 4.62
  - choosing for genomic library construction, 4.7–4.10
  - DNA preparation, 4.67–4.71
    - small-scale, 4.70–4.71
  - features of, 4.58–4.60
  - genomic libraries
    - characterization, 4.61
    - construction, 4.60
    - mapping inserts, 4.63
    - rescuing termini of genomic DNAs, 4.63
    - screening, 4.61–4.62
    - subcloning from, 4.64
  - growth of cultures from, 4.64–4.66
  - insert size, 4.61
  - instability and rearrangement, 4.61–4.62
  - overview, 4.2, 4.58
  - PCR analysis of yeast colonies, 4.72–4.73
  - preparation for pulsed-field gel electrophoresis, 5.65–5.67
  - problems with, 4.61–4.63
  - purification, 4.62–4.63
  - retrofitting with selectable marker, 4.63–4.64
  - screening recombinants, 4.60
  - stability of cloned sequences, 4.10
  - storage of yeast cultures, 4.66
  - subcloning inserts from, 4.64
  - transformation, 4.60, 4.63–4.64
- YEp (yeast episomal plasmid), A3.5
- Ylp (yeast integrating plasmid), A3.4
- YK537 *E. coli* strain, 15.37, A3.10
- YPD medium, 4.65, 18.18, A2.11
- YRp (yeast replicating plasmid), A3.5
- YT medium recipe, A2.4
- Z gene,  $\lambda$ , 2.15
- ZAP Express vector, 2.23
- Zeo<sup>R</sup> (Zeocin), 17.74, 18.14, 18.19
- Zygosaccharomyces*, 4.85
- Zymolyase, 4.60, 5.66–5.67, 18.39, 18.41, A1.8

VOLUME 2

---

# Molecular Cloning

A LABORATORY MANUAL

---

THIRD EDITION

[www.MolecularCloning.com](http://www.MolecularCloning.com)

Joseph Sambrook

David W. Russell



COLD SPRING HARBOR LABORATORY PRESS

# Chapter 8

---

## In Vitro Amplification of DNA by the Polymerase Chain Reaction

### INTRODUCTION

### PROTOCOLS

1	The Basic Polymerase Chain Reaction	8.18
2	Purification of PCR Products in Preparation for Cloning	8.25
3	Removal of Oligonucleotides and Excess dNTPs from Amplified DNA by Ultrafiltration	8.27
	Introduction to Cloning PCR Products (Protocols 4–7)	8.30
4	Blunt-end Cloning of PCR Products	8.32
5	Cloning PCR Products into T Vectors	8.35
6	Cloning PCR Products by Addition of Restriction Sites to the Termini of Amplified DNA	8.37
7	Genetic Engineering with PCR	8.42
8	Amplification of cDNA Generated by Reverse Transcription of mRNA (RT-PCR)	8.46
9	Rapid Amplification of 5' cDNA Ends (5'-RACE)	8.54
10	Rapid Amplification of 3' cDNA Ends (3'-RACE)	8.61
11	Mixed Oligonucleotide-primed Amplification of cDNA (MOPAC)	8.66
12	Rapid Characterization of DNAs Cloned in Prokaryotic Vectors	8.72
	• Additional Protocol: Screening Yeast Colonies by PCR	8.75
	• Additional Protocol: Screening Bacteriophage $\lambda$ Libraries	8.76
13	Long PCR	8.77
14	Inverse PCR	8.81
15	Quantitative PCR	8.86
16	Differential Display-PCR (DD-PCR)	8.96

### INFORMATION PANELS

Multiplex PCR	8.107
<i>Taq</i> DNA Polymerase	8.108
Hot Start PCR	8.110
Ribonuclease H	8.111
Terminal Transferase	8.111
Touchdown PCR	8.112
Use of Inosine in Degenerate Pools of Oligonucleotides Used for PCR	8.113
Universal Primers	8.113

*The principles for extensive synthesis of the duplexed tRNA genes which emerge from the present work are the following. The DNA duplex would be denatured to form single strands. This denaturation step would be carried out in the presence of a sufficiently large excess of the two appropriate primers. Upon cooling, one would hope to obtain two structures, each containing the full length of the template strand appropriately complexed with the primer. DNA polymerase will be added to complete the process of repair replication. Two molecules of the original duplex should result. The whole cycle could be repeated, there being added every time a fresh dose of the enzyme. It is, however, possible that upon cooling after denaturation of the DNA duplex, renaturation to form the original duplex would predominate over the template-primer complex formation. If this tendency could not be circumvented by adjusting the concentrations of the primers, clearly one would have to resort to the separation of the strands and then carry out repair replication. After every cycle of repair replication, the process of strand separation would have to be repeated. Experiments based on these lines of thought are in progress.*

K. Kleppe, E. Ohtsuka., R. Kleppe, I. Molineux, and H.G. Khorana.  
Studies on polynucleotides. XCVI. Repair replications of short synthetic DNA's  
as catalyzed by DNA polymerases (*J. Mol. Biol.* 56: 341 [1971]).



Sometimes a good idea comes to you when you are not looking for it. Through an improbable combination of coincidences, naïveté and lucky mistakes, such a revelation came to me one Friday night in April, 1983, as I gripped the steering wheel of my car and snaked along a moonlit mountain road into northern California's redwood country. That was how I stumbled across a process that could make unlimited numbers of copies of genes, a process now known as the polymerase chain reaction (PCR).

One Friday evening late in the spring I was driving to Mendocino County with a chemist friend. She was asleep. U.S. 101 was undemanding. I liked night driving; every weekend I went north to my cabin and sat still for three hours in the car, my hands occupied, my mind free. On that particular night I was thinking about my proposed DNA-sequencing experiment.

Around Cloverdale, where California 128 branches northwest from U.S. 101 and winds upward through the coastal range, I decided the determination would be more definitive if, instead of just one oligonucleotide, I used two... . By directing one oligonucleotide to each strand of the sample DNA target, I could get complementary sequencing information about both strands. The experiment would thereby contain an internal control at no extra inconvenience.

Although I did not realize it at that moment, with the two oligonucleotides poised in my mind, their three-prime ends pointing at each other on opposite strands of the gene target, I was on the edge of discovering the polymerase chain reaction. Yet what I most felt on the edge of was the mountain road.

That night the air was saturated with moisture and the scent of flowering buckeye. The reckless white stalks poked from the roadside into the glare of my headlights... . Excited, I started running powers of two in my head: two, four, eight, 16, 32... . I remembered vaguely that two to the tenth power was about 1000 and that therefore two to the twentieth was around a million. I stopped the car at a turnout overlooking Anderson Valley. From the glove compartment I pulled a pencil and paper — I needed to check my calculations. Jennifer, my sleepy passenger, objected groggily to the delay and the light, but I exclaimed that I had discovered something fantastic. Nonplussed, she went back to sleep. I confirmed that two to the twentieth power really was over a million and drove on.

About a mile farther down the road I realized something else about the products of the reaction. After a few rounds of extending the primers, dis-sociating the extension products, rehybridizing new primers and extending them, the length of the exponentially accumulating DNA strands would be fixed because their ends would be sharply defined by the five-prime ends of the oligonucleotide primers. I could replicate larger fragments of the original DNA sample by designing primers that hybridized farther apart on it. The fragments would always be discrete entities of a specified length.

I stopped the car again and started drawing lines of DNA molecules hybridizing and extending, the products of one cycle becoming the templates for the next in a chain reaction... . Jennifer protested again from the edge of sleep. "You're not going to believe this, I crowed. It's incredible."

She refused to wake up. I proceeded to the cabin without further stops. The deep end of Anderson Valley is where the redwoods start and where the "ne'er-do-wells" have always lived. My discovery made me feel as though I was about to break out of that old valley tradition. It was difficult for me to sleep that night with deoxyribonuclear bombs exploding in my brain.

K.B. Mullis

The unusual origin of the polymerase chain reaction (*Sci. Am.* 262: 56 [1990]).

**A** TRIUMVIRATE OF METHODS — CLONING, DNA SEQUENCING, AND PCR (polymerase chain reaction) — underlies almost all of modern molecular biology. Of these three, the PCR is the oldest in theory and the most versatile in practice. The method was first proposed in the early 1970s by H. Ghobind Khorana and his colleagues as a strategy to lessen the labor involved in chemical synthesis of genes (Kleppe et al. 1971). Their ideas, however, did not seem practicable at a time when genes had not yet been sequenced, thermostable DNA polymerases had not been described, and synthesis of oligonucleotide primers was more of an art than a science. Not surprisingly, Khorana's ideas were quickly forgotten. The technique was independently conceived 15 years later, given its present name, and put into practice by Kary Mullis and coworkers at Cetus Corporation, who described in vitro amplification of single-copy mammalian genes using the Klenow fragment of *Escherichia coli* DNA polymerase I (Saiki et al. 1985; Mullis et al. 1986; Mullis and Faloona 1987). Even so, PCR would probably have remained a clumsy laboratory curiosity were it not for the discovery of thermostable DNA polymerases (Chien et al. 1976; Kaledin et al. 1980). The use of a thermostable polymerase from *Thermus aquaticus* (Saiki et al. 1988) greatly increased the efficiency of PCR and opened the door to automation of the method. By the end of the 1980s, cloning was no longer the only way to isolate genes: DNA sequencing had been revolutionized and PCR had become a fundamental cornerstone of genetic and molecular analyses.

In addition to its simplicity, PCR is robust, speedy, and most of all, flexible. An enormous number of variations on the method have been described and entire journals and books have been devoted to the technique. In this chapter, we first discuss the parameters that affect PCR and then furnish core protocols that can be used to amplify DNA fragments and characterize them.

The first description of PCR — precise, laconic, and impersonal — was published by Kleppe et al. in 1971; a second — incarnadine, self-indulgent, and visionary — was published by Kary Mullis in 1990.

## PARAMETERS THAT AFFECT POLYMERASE CHAIN REACTIONS

---

### Essential Components of Polymerase Chain Reactions

PCRs contain seven essential components:

- **A thermostable DNA polymerase to catalyze template-dependent synthesis of DNA.** A wide choice of enzymes is now available that vary in their fidelity, efficiency, and ability to synthesize large DNA products (for discussion, please see Thermostable DNA Polymerases on p. 8.6). For routine PCRs, *Taq* polymerase (0.5–2.5 units per standard 25–50- $\mu$ l reaction) remains the enzyme of choice. The specific activity of most commercial preparations of *Taq* is  $\sim$ 80,000 units/mg of protein. Standard PCRs therefore contain  $2 \times 10^{12}$  to  $10 \times 10^{12}$  molecules of enzyme. Since the efficiency of primer extension with *Taq* polymerase is generally  $\sim$ 0.7 (e.g., please see Gelfand and White 1990; Lubin et al. 1991), the enzyme becomes limiting when  $1.4 \times 10^{12}$  to  $7 \times 10^{12}$  molecules of amplified product have accumulated in the reaction.
- **A pair of synthetic oligonucleotides to prime DNA synthesis.** Of the many factors that influence the efficiency and specificity of the amplification reaction, none are more crucial than the design of oligonucleotide primers. Careful design of primers is required to obtain the desired products in high yield, to suppress amplification of unwanted sequences, and to facilitate subsequent manipulation of the amplified product. Given that primers so heavily influence the

success or failure of PCR protocols, it is ironic that the guidelines for their design are largely qualitative and are based more on common sense than on well-understood thermodynamic or structural principles. Compliance with these empirical rules does not guarantee success. Disregarding them, however, is likely to lead to failure. For more information, please see Design of Oligonucleotide Primers for Basic PCR on p. 8.13.

In certain situations, it may be desirable to amplify several segments of target DNA simultaneously. In these cases, an amplification reaction termed “multiplex PCR” is used that includes more than one pair of primers in the reaction mix. For further details on this variation, please see the information panel on **MULTIPLEX PCR** at the end of this chapter. Standard reactions contain nonlimiting amounts of primers, typically 0.1–0.5  $\mu\text{M}$  of each primer ( $6 \times 10^{12}$  to  $3 \times 10^{13}$  molecules). This quantity is enough for at least 30 cycles of amplification of a 1-kb segment of DNA. Higher concentrations of primers favor mispriming, which may lead to nonspecific amplification.

Oligonucleotide primers synthesized on an automated DNA synthesizer can generally be used in standard PCRs without further purification. However, amplification of single-copy sequences from mammalian genomic templates is often more efficient if the oligonucleotide primers are purified by chromatography on commercially available resins (e.g., NENSORB, NEN Life Science Products) or by denaturing polyacrylamide gel electrophoresis, as described in Chapter 10, Protocol 1.

- **Deoxynucleoside triphosphates (dNTPs).** Standard PCRs contain equimolar amounts of dATP, dTTP, dCTP, and dGTP. Concentrations of 200–250  $\mu\text{M}$  of each dNTP are recommended for *Taq* polymerase in reactions containing 1.5 mM  $\text{MgCl}_2$ . In a 50- $\mu\text{l}$  reaction, these amounts should allow synthesis of ~6–6.5  $\mu\text{g}$  of DNA, which should be sufficient even for multiplex reactions in which eight or more primer pairs are used at the same time. High concentrations of dNTPs (>4 mM) are inhibitory, perhaps because of sequestering of  $\text{Mg}^{2+}$ . However, a satisfactory amount of amplified product can be produced with dNTP concentrations as low as 20  $\mu\text{M}$  — 0.5–1.0 pmole of an amplified fragment ~1 kb in length.

Several manufacturers (e.g., Boehringer Mannheim) sell stocks of dNTPs that are made specifically for PCR. These stocks are free of pyrophosphates that may inhibit PCR and are adjusted with NaOH to a pH of ~8.1, which protects the dNTPs to some extent from damage during freezing and thawing. To avoid problems, stocks of dNTPs (100–200 mM) — whether homemade or purchased — should be stored at  $-20^\circ\text{C}$  in small aliquots that should be discarded after the second cycle of freezing/thawing. During long-term storage at  $-20^\circ\text{C}$ , small amounts of water evaporate and then freeze on the walls of the vial. To minimize changes in concentration, vials containing dNTP solutions should be centrifuged, after thawing, for a few seconds in a microfuge.

- **Divalent cations.** All thermostable DNA polymerases require free divalent cations — usually  $\text{Mg}^{2+}$  — for activity. Some polymerases will also work, albeit less efficiently with buffers containing  $\text{Mn}^{2+}$  (please see Thermostable DNA Polymerases below). Calcium ions are quite ineffective (Chien et al. 1976). Because dNTPs and oligonucleotides bind  $\text{Mg}^{2+}$ , the molar concentration of the cation must exceed the molar concentration of phosphate groups contributed by dNTPs plus primers. It is therefore impossible to recommend a concentration of  $\text{Mg}^{2+}$  that is optimal in all circumstances. Although a concentration of 1.5 mM  $\text{Mg}^{2+}$  is routinely used, increasing the concentration of  $\text{Mg}^{2+}$  to 4.5 mM or 6 mM has been reported to decrease nonspecific priming in some cases (e.g., please see Krawetz et al. 1989; Riedel et al. 1992) and to increase it in others (e.g., please see Harris and Jones 1997). The optimal concentration of  $\text{Mg}^{2+}$  must therefore be determined empirically for each combination of primers

and template. Many companies (e.g., Invitrogen, Perkin-Elmer, and Stratagene) sell optimizer kits containing various buffer formulations that enable investigators to determine optimal reaction conditions for particular primer-template combinations. Once these conditions have been identified, the best buffer can then be purchased in volume or assembled in the laboratory. Alternatively, optimization can be achieved by comparing the yield obtained from a series of ten PCRs containing concentrations of  $Mg^{2+}$  ranging from 0.5 mM to 5.0 mM, in 0.5 mM increments. Sometimes a second round of optimization is necessary using a narrower range of  $Mg^{2+}$ , in 0.2 mM increments. If possible, preparations of template DNA should not contain significant amounts of chelating agents such as EDTA (ethylenediaminetetraacetic acid) or negatively charged ions, such as  $PO_4^{3-}$ , which can sequester  $Mg^{2+}$ .

- **Buffer to maintain pH.** Tris-Cl, adjusted to a pH between 8.3 and 8.8 at room temperature, is included in standard PCRs at a concentration of 10 mM. When incubated at 72°C (the temperature commonly used for the extension phase of PCR), the pH of the reaction mixture drops by more than a full unit, producing a buffer whose pH is ~7.2.
- **Monovalent cations.** Standard PCR buffer contains 50 mM KCl and works well for amplification of segments of DNA >500 bp in length. Raising the KCl concentration to ~70–100 mM often improves the yield of shorter DNA segments.
- **Template DNA.** Template DNA containing target sequences can be added to PCR in single- or double-stranded form. Closed circular DNA templates are amplified slightly less efficiently than linear DNAs. Although the size of the template DNA is not critical, amplification of sequences embedded in high-molecular-weight DNA (>10 kb) can be improved by digesting the template with a restriction enzyme that does not cleave within the target sequence.

When working at its best, PCR requires only a single copy of a target sequence as template (Li et al. 1990). More typically, however, several thousand copies of the target DNA are seeded into the reaction. In the case of mammalian genomic DNA, up to 1.0  $\mu$ g of DNA is utilized per reaction, an amount that contains  $\sim 3 \times 10^5$  copies of a single-copy autosomal gene. The typical amounts of yeast, bacterial, and plasmid DNAs used per reaction are 10 ng, 1 ng, and 1 pg, respectively.

## Thermostable DNA Polymerases

Thermostable DNA polymerases are isolated from two classes of organisms: the thermophilic and hyperthermophilic eubacteria Archaeobacteria, whose most abundant DNA polymerases are reminiscent of DNA polymerase I of mesophilic bacteria; and thermophilic Archaea, whose chief DNA polymerases belong to the polymerase  $\alpha$  family. *T. aquaticus*, an organism from the thermophilic Archaea family (please see Figure 8-1 and Brock 1995a,b, 1997). *Taq* (*T. aquaticus*) DNA polymerase, the first isolated and best understood of the thermostable DNA polymerases, remains the workhorse of PCR in most laboratories.

Unfortunately, preparations of *Taq* polymerase sold by different manufacturers are not identical: Variations have been reported in the yield, length, and fidelity of the amplified product generated by different commercial preparations of *Taq* in standardized PCRs (e.g., please see Linz et al. 1990). It is therefore important to optimize PCRs every time for each new batch of *Taq*. Despite these annoyances, *Taq* polymerase remains the enzyme of choice for routine amplification of small segments of DNA. However, when greater fidelity is required, when the length of the target amplicon exceeds a few thousand bases, or when cloning mRNA by reverse transcriptase-PCR (RT-PCR), other thermostable enzymes may have significant advantages. The choice among enzymes should be determined by the purpose of the experiment. For example, if the goal



**FIGURE 8-1** The Brock Expedition

Thomas D. Brock (a microbial ecologist at the University of Wisconsin, Madison) is standing next to Mushroom Spring in Yellowstone National Park, June 23, 1967. *T. aquaticus* strain YT-1 was isolated from a sample taken in the previous year from the outflow channel (visible on the left side of the photo) by Tom Brock and his undergraduate student, Hudson Freeze. Their work is elegantly and proudly described in autobiographical memoirs by Tom Brock (Brock 1995a,b, 1997). The subsequent impact of “extremophilic” microorganisms on the biotechnology industry is described by Madigan and Marrs (1997). (Reprinted, with permission, from Brock 1995b.)

is to make faithful copies of a gene, an enzyme with proofreading function is required, whereas if the goal is to clone an amplified product, an enzyme that generates blunt ends may be of advantage. Until recently, these choices often involved compromise on the part of the investigator. However, mixtures of two or more DNA polymerases can significantly increase yield and enhance amplification, particularly of longer target DNAs (Barnes 1994; Cheng et al. 1994; Cohen 1994). This improvement is presumed to be due to the capacity of one enzyme to complement the inability of another to extend a primer through potential obstructions on the template strand. These obstructions include regions of high secondary structure (Eckert and Kunkel 1993), abasic gaps that cannot be bridged by polymerases lacking terminal transferase activity (Hu 1993), and mismatched bases that cause nonproofreading polymerases to stall and dissociate from the primer:template (Barnes 1994). Several manufacturers now sell cocktails of thermostable polymerases that allow desirable features to be assembled in one reaction mixture. For example, cocktails of *Tbr* and *Taq*, sold under the trade name DyNAzyme (MJ Research Inc.) exhibit high fidelity because of the proofreading function of *Tbr* and the high efficiency that is characteristic of *Taq*. Similarly, a mixture of *Taq* and *Pfu* polymerases sold by Stratagene (*TaqPlus* Long PCR System) and Boehringer Mannheim (Expand Long Template PCR System) generates high yields of long targets (up to 35 kb).

The enzymatic properties and applications of the best known of the commercially produced thermostable DNA polymerases are summarized in Table 8-1. Details of the isolation and physical properties of the purified enzymes may be found in the many reviews (Erlich 1989; Gelfand and White 1990; Cha and Thilly 1993; Bej and Mahbubani 1994; Cohen 1994; Perler et al. 1996) and books on this topic (Innis et al. 1990; Griffin and Griffin 1994; Dieffenbach and Dveksler 1995). In addition, a summary of the error rates for thermostable-resistant DNA polymerases may be found at <http://listeria.nwfsc.noaa.gov/protocols/taq-errors.html>. However, in some cases, the only source of information is the indefatigably optimistic material supplied by the manufacturer.

## Programming Polymerase Chain Reactions

PCR is an iterative process, consisting of three elements: denaturation of the template by heat, annealing of the oligonucleotide primers to the single-stranded target sequence(s), and extension of the annealed primers by a thermostable DNA polymerase.

- **Denaturation.** Double-stranded DNA templates denature at a temperature that is determined in part by their G+C content. The higher the proportion of G+C, the higher the temperature required to separate the strands of template DNA. The longer the DNA molecules, the greater the time required at the chosen denaturation temperature to separate the two strands completely. If the temperature for denaturation is too low or if the time is too short, only AT-rich regions of the template DNA will be denatured. When the temperature is reduced later in the PCR cycle, the template DNA will reanneal into a fully native condition.

In PCRs catalyzed by *Taq* DNA polymerase, denaturation is carried out at 94–95°C, which is the highest temperature that the enzyme can endure for 30 or more cycles without sustaining excessive damage. In the first cycle of PCR, denaturation is sometimes carried out for 5 minutes to increase the probability that long molecules of template DNA are fully denatured. However, in our experience, this extended period of denaturation is unnecessary for linear DNA molecules and may sometimes be deleterious (Gustafson et al. 1993). We recommend denaturation for 45 seconds at 94–95°C for routine amplification of linear DNA templates whose contents of G+C is 55% or less.

Higher temperatures may be required to denature template and/or target DNAs that are rich in G+C (>55%). DNA polymerases isolated from Archaea are more heat-tolerant than *Taq* and are therefore preferred for amplification of GC-rich DNAs.

- **Annealing of primers to template DNA.** The temperature used for the annealing step ( $T_a$ ) is critical. If the annealing temperature is too high, the oligonucleotide primers anneal poorly, if at all, to the template and the yield of amplified DNA is very low. If the annealing temperature is too low, nonspecific annealing of primers may occur, resulting in the amplification of unwanted segments of DNA. Annealing is usually carried out 3–5°C lower than the calculated melting temperature at which the oligonucleotide primers dissociate from their templates. Many formulas exist to determine the theoretical melting temperature, but none of them are accurate for oligonucleotide primers of all lengths and sequences (please see Calculating Melting Temperatures of Hybrids between Oligonucleotide Primers and Their Target Sequences on p. 8.15). It is best to optimize the annealing conditions by performing a series of trial PCRs at temperatures ranging from 2°C to 10°C below the lower of the melting temperatures calculated for the two oligonucleotide primers. Alternatively, the thermal cycler can be programmed to use progressively lower annealing temperatures in consecutive pairs of cycles (“touchdown” PCR; Don et al. 1991). Instead of surveying a variety of annealing con-

ditions in separate PCRs, optimization is achieved by exposing a single PCR to a sequential series of annealing temperatures in successive cycles of the reaction. For many investigators, touchdown PCR bypasses the need to determine the optimum annealing temperature for every pair of primers and is used to obtain acceptable yields of amplified products in routine PCR (Peterson and Tjian 1993; Roux 1995; Hecker and Roux 1996; Roux and Hecker 1997; please see the information panel on **TOUCHDOWN PCR**).

- **Extension of oligonucleotide primers** is carried out at or near the optimal temperature for DNA synthesis catalyzed by the thermostable polymerase, which in the case of *Taq* DNA polymerase is 72–78°C. In the first two cycles, extension from one primer proceeds beyond the sequence complementary to the binding site of the other primer. In the next cycle, the first molecules are produced whose length is equal to the segment of DNA delimited by the binding sites of the primers. From the third cycle onward, this segment of DNA is amplified geometrically, whereas longer amplification products accumulate arithmetically (Mullis and Faloona 1987). The polymerization rate of *Taq* polymerase is ~2000 nucleotides/minute at the optimal temperature (72–78°C) and as a rule of thumb, extension is carried out for 1 minute for every 1000 bp of product. For the last cycle of PCR, many investigators use an extension time that is three times longer than in the previous cycles, ostensibly to allow completion of all amplified products. However, in our experience, the result of the PCR is not significantly altered by tinkering with the extension time in this way.
- **Number of cycles.** As discussed in the panel on **PCR IN THEORY** (p. 8.12), the number of cycles required for amplification depends on the number of copies of template DNA present at the beginning of the reaction and the efficiency of primer extension and amplification. Once established in the geometric phase, the reaction proceeds until one of the components becomes limiting. At this point, the yield of specific amplification products should be maximal, whereas nonspecific amplification products should be barely detectable, if at all. This is generally the case after ~30 cycles in PCRs containing ~10<sup>5</sup> copies of the target sequence and *Taq* DNA polymerase (efficiency ~0.7). At least 25 cycles are required to achieve acceptable levels of amplification of single-copy target sequences in mammalian DNA templates.

### Optional Components of Polymerase Chain Reactions

A number of cosolvents and additives have been reported to reduce unacceptably high levels of mispriming and to increase the efficiency of amplification of G+C-rich templates (Pomp and Medrano 1991; Newton and Graham 1994; Varadaraj and Skinner 1994). Cosolvents include formamide (1.25–10% v/v) (Sarkar et al. 1990), dimethylsulfoxide (up to 15% v/v) (Bookstein et al. 1990), and glycerol (1–10% v/v) (Lu and Nègre 1993). Additives include tetramethylammonium chloride (Hung et al. 1990; Chevet et al. 1995), potassium glutamate (10–200 mM), ammonium sulfate (Schoettlin et al. 1993), nonionic and cationic detergents (Bachmann et al. 1990; Pontius and Berg 1991), and certain as yet unidentified “Specificity Enhancers” such as Perfect Match Polymerase Enhancer (Stratagene) and GC-Melt (CLONTECH). Many of these additives and cosolvents inhibit PCR when used at high concentrations, and the optimum concentration must be determined empirically for each combination of primers and template DNA. Rather than reaching for these enhancers at the first sign of trouble, it is far better in our view to optimize the regular components of the reaction, particularly the concentrations of Mg<sup>2+</sup> and K<sup>+</sup> ions (Krawetz et al. 1989; Riedel et al. 1992). The one exception to this general rule concerns the use of GC-Melt, which in our hands often overcomes problems of low-efficiency amplification with uncooperative G+C-rich templates.

TABLE 8-1 Properties and Applications of Thermostable DNA Polymerases

ENZYME	MANUFACTURER <sup>a</sup>	ORGANISM	OPTIMUM TEMP. (°C)	EXONUCLEASE ACTIVITY	FIDELITY	STABILITY (MINUTES AT SPECIFIED TEMPERATURE)	K <sub>m</sub> dNTP (μM)	K <sub>cat</sub>	COMMENTS
<i>Taq</i>	BM, LT, Pro, Strat, P-E, T	<i>T. aquaticus</i>	75–80	5'–3'	low	9 min at 97.5°C	10–16	60–150	°C
<i>Taq</i> Stoffel fragment	P-E	<i>T. aquaticus</i>	75–80	none	low	21 min at 97.5°C	–	130	The Stoffel fragment consists of the 544 carboxy-terminal amino acid residues of <i>Taq</i> polymerase. The processivity of the Stoffel fragment is ~10-fold lower than the processivity of full-length <i>Taq</i> polymerase.
<i>rTth</i>	BM, ET, P-E	<i>T. thermophilus</i>	75–80	5'–3'	low	20 min at 95°C	115	25	<i>rTth</i> , the recombinant form of <i>Tth</i> DNA polymerase, can use Mg <sup>2+</sup> or Mn <sup>2+</sup> as a cofactor. In the presence of Mn <sup>2+</sup> , the reverse transcriptase activity of <i>rTth</i> is enhanced.
<i>Tfi</i>	Pro	<i>T. flavus</i>	70	none	low	120 min at 70°C	63	–	Useful for amplification of large segments of DNA.
<i>Hot Tub</i>	Amr	<i>T. ubiquitous</i>	–	none	low	–	–	–	–
<i>Tbr</i>	Amr, Finnz	<i>T. brockianus</i>	75–80	5'–3'	low	150 min at 96°C	–	–	–
<i>U'ima</i>	P-E, Roche	<i>Thermotoga maritima</i>	75–80	3'–5'	high	50 min at 95°C	–	–	–
<i>rBst</i>	ET	<i>Bacillus sterothermophilus</i>	60–65	5'–3' (3'–5') <sup>b</sup>	–	–	–	–	Conflicting data exist in the literature about exonuclease activities associated with <i>Bst</i> DNA polymerase. Two widely differing estimates have been published for the K <sub>m</sub> of the enzyme for dNTPs. <i>Bst</i> DNA polymerase is used mainly for DNA sequencing. The enzyme, which will readily accept nucleotide analogs (e.g., dITP) as substrates, is used to sequence regions of DNA rich in GC and/or containing a high degree of secondary structure.
<b>Isotherm <i>Bst</i> large fragment</b>	ET, Bio-Rad	<i>Bacillus sterothermophilus</i>	60–65	–	high	–	7–85	–	The large fragment, which consists only of the polymerase domain, is obtained from the <i>Bst</i> holoenzyme



<i>Pwo</i>	BM	<i>Pyrococcus woesei</i>	60–65	3'–5'	high	>2 hr at 100°C	–	–	by proteolytic digestion, and is used for sequencing difficult tracts of DNA.
<i>Tli</i>	Pro	<i>Thermococcus litoralis</i>	70–80	3'–5'	low	100 min at 100°C	66	60	<i>Vent</i> and <i>Tli</i> are suitable for primer-extension and PCRs requiring a high-fidelity highly stable DNA polymerase. Most of the products generated in PCRs are blunt-ended, which simplifies cloning. <i>Vent</i> is useful for long PCR. Neither <i>Vent</i> nor <i>Tli</i> is recommended for DNA sequencing. However, derivatives of <i>Vent</i> with reduced exonuclease activity have been generated and are sold by NEB. These enzymes are used as catalysts in cycle-sequencing reactions.
<i>DeepVent</i>	NEB	<i>Pyrococcus</i> strain GB-D	70–80	3'–5'	high	480 min at 100°C	50	–	<i>DeepVent</i> is suitable for primer-extension and PCRs requiring a high-fidelity highly stable DNA polymerase. Enzymes with reduced exonuclease activity have been generated and are sold by NEB.
<i>Pfu</i>	Strat	<i>Pyrococcus furiosus</i>	72–78	3'–5'	high	240 min at 95°C	–	–	<i>Pfu</i> is suitable for primer-extension reactions and PCRs requiring a high-fidelity highly stable DNA polymerase. The published error rate of <i>Pfu</i> per nucleotide is the lowest of any DNA polymerase (Cline et al. 1996). A variant of <i>Pfu</i> lacking exonuclease activity has been generated and is sold by Stratagene. This enzyme is well-suited as a catalyst in cycle-sequencing reactions. Stratagene also markets <i>PfuTurbo</i> , which is a mixture of <i>Pfu</i> and a newly discovered factor that enhances both yield and size of the amplified product.

Data for this table were taken from reviews by Perler et al. (1996) and Bej and Mahbubani (1994), from Internet sources, and from literature distributed by commercial manufacturers. For details of the reaction conditions that are optimal for each enzyme, please consult the instructions supplied with the enzyme by the manufacturer.

<sup>a</sup>(BM) Boehringer Mannheim; (ET) Epicenter Technologies; (LT) Life Technologies; (Pro) Promega; (NEB) New England Biolabs; (P-E) Perkin-Elmer; (T) TaKaRa; (Strat) Stratagene; (Amr) Amresco; (Finnz) Finnzymes OY.

<sup>b</sup>Suspected activity.

**PCR IN THEORY**

When amplifying a small segment of a larger double-stranded DNA template, the desired blunt-ended fragments first appear in the third cycle of PCR. The amplified products then accumulate exponentially, as described in Equation 1 (Keohavong et al. 1988):

$$N_i = N_o (1 + Y)^n \quad (1)$$

where  $N_i$  is the copy number of the amplified sequence after  $n$  cycles of amplification,  $N_o$  is the initial copy number of the target sequence in the DNA template, and  $Y$  is the efficiency of amplification per cycle.

This equation only applies to the exponential phase of amplification, which continues until one of the components in the reaction becomes limiting. In a standard PCR containing ~1 unit of thermostable DNA polymerase, the enzyme becomes limiting when the copy number of the target sequence approaches  $10^{12}$ . At this point, the efficiency of the reaction drops precipitously and the product no longer accumulates in a geometric fashion. Knowing the final yield of amplified product at the end of the exponential phase, the overall efficiency of the exponential reaction can be calculated from Equation 2:

$$Y = \left[ \frac{N_i}{N_o} \right]^{1/n} - 1 \quad (2)$$

where  $Y$  is the efficiency of amplification per cycle, and  $N_i - N_o$  is the number of amplified molecules produced in  $n$  cycles of exponential amplification.

Knowing the initial copy number and the efficiency of the reaction, the number of cycles required to generate the desired number of copies (e.g.,  $10^{12}$ ) of the target DNA can be calculated by substitution in Equation 1. For example, when the initial number of template molecules =  $3 \times 10^5$  and the efficiency of the exponential phase of the reaction is 70%, Equation 1 becomes  $10^{12} = 3 \times 10^5 (1 + 0.7)^n$ . Solving for  $n$  yields 28.6. Twenty-nine cycles of exponential amplification will therefore be needed to generate  $10^{12}$  molecules of product.

The efficiency of PCR is determined chiefly by the quality of the thermostable DNA polymerase. Because of the geometric nature of PCR, the penalty for using an inefficient enzyme is severe. For example, Linz et al. (1990) found that after 20 cycles of exponential amplification, the amount of product varied over a 200-fold range depending on the polymerase used. This large difference in yield was attributed to a 2-fold difference in the efficiency of the enzymes during the exponential phase of the reaction.

Table 8-2 shows the theoretical number of cycles required to generate 10 ng of a 200-bp product in PCRs running at various efficiencies and containing different numbers of initial template DNAs.

**TABLE 8-2 Theoretical Number of Cycles Required for PCR**

Y	TARGETS					
	1	10	100	1,000	10,000	100,000
1.00	34	30	27	24	20	17
0.95	35	32	28	25	21	18
0.90	36	33	29	26	22	18
0.85	38	34	30	27	23	19
0.80	40	36	32	28	24	20
0.75	42	38	33	29	25	21
0.70	44	40	35	31	27	22
0.65	46	42	37	33	28	23
0.60	49	45	40	35	30	25
0.55	53	48	43	37	32	27
0.50	57	52	46	40	35	29
0.45	62	56	50	44	38	31
0.40	69	62	55	48	42	35
0.35	77	70	62	54	47	39
0.30	88	79	71	62	53	44
0.25	104	93	83	73	62	52
0.20	127	114	102	89	76	64
0.15	165	149	132	116	99	83
0.10	242	218	194	170	145	121

Reprinted, with permission, from Rameckers et al. (1997 [©Springer-Verlag]).

Number of PCR cycles (rounded) required to reach 10 ng of DNA (based on a 200-bp PCR product) at various efficiency levels (Y) and various target numbers (targets).

## Inhibitors

Almost anything will inhibit PCRs if present in excess. The common culprits include proteinase K (which, if given the opportunity, can degrade thermostable DNA polymerase), phenol, and EDTA. Other substances that can cause problems are ionic detergents (Weyant et al. 1990), heparin (Beutler et al. 1990), polyanions such as spermidine (Ahokas and Erkkila 1993), hemoglobin, and gel-loading dyes such as bromophenol blue and xylene cyanol (Hoppe et al. 1992). In many cases, the chief cause of low or erratic yields are contaminants in the template DNA, which is often the only component of the reaction supplied by the investigator. Many problems with PCR can be cured simply by cleaning up the template by dialysis, ethanol precipitation, extraction with chloroform, and/or chromatography through a suitable resin.

## DESIGN OF OLIGONUCLEOTIDE PRIMERS FOR BASIC PCR

The chief goal of primer design is *specificity*, which is achieved only when each member of a primer pair anneals in a stable fashion to its target sequence in the template DNA. As a rule of thumb, the longer an oligonucleotide, the higher its specificity for a particular target. The following equations can be used to calculate the probability that a sequence exactly complementary to a string of nucleotides will occur by chance within a DNA sequence space that consists of a random sequence of nucleotides (Nei and Li 1979).

$$K = [g/2]^{G+C} \times [(1-g)/2]^{A+T}$$

where  $K$  is the expected frequency of occurrence within the sequence space,  $g$  is the relative G+C content of the sequence space, and G, C, A, and T are the number of specific nucleotides in the oligonucleotide. For a double-stranded genome of size  $N$  (in nucleotides), the expected number ( $n$ ) of sites complementary to the oligonucleotide is  $n = 2NK$ .

These equations predict that an oligonucleotide of 15 nucleotides would be represented only once in a mammalian genome where  $N$  is  $\sim 3.0 \times 10^9$ . In the case of a 16-mer, there is only one chance in ten that a typical mammalian cDNA library (complexity  $\sim 10^7$  nucleotides) will fortuitously contain a sequence that exactly matches that of the oligonucleotide. However, these calculations are based on the assumption that the distribution of nucleotides in mammalian genomes is random. This is not the case because of bias in codon usage (Lathe 1985) and because a significant fraction of the genome is composed of repetitive DNA sequences and gene families (Bains 1994). To minimize problems of nonspecific annealing, it is advisable to use oligonucleotide primers longer than the statistically indicated minimum. Because of the presence of repetitive elements, no more than 85% of the mammalian genome can be targeted precisely, even by primers that are 20 or more nucleotides in length (Bains 1994). Before synthesizing an oligonucleotide primer, it is prudent to scan DNA databases to check that the proposed sequence occurs only in the desired gene and not in vectors, undesired genes, or repetitive elements (e.g., please see Mitsuhashi et al. 1994).

Table 8-3 presents information on the design of oligonucleotide primers for basic PCR. Failures will be rare if the advice provided in the table is followed carefully.

## Selecting PCR Primers

Listed below are several steps involved in the selection of oligonucleotide primers:

- **Analysis of the target gene for potential priming sites** that are free of homopolymeric tracts, have no obvious tendency to form secondary structures, are not self-complementary, and have no significant homology with other sequences on either strand of the target genome.

- **Creation of lists of possible forward and reverse primers** based on the criteria listed in the Table 8-3. Calculate the melting temperatures of the oligonucleotides from the formulae given in the following section on Calculating Melting Temperatures of Hybrids between Oligonucleotide Primers and Their Target Sequences.
- **Selection of well-matched pairs of forward and reverse primers** that are similar in their content of G+C and will generate an amplified product of the appropriate size and base composition. The GC content of both primers and the amplified product should be similar and lie between 40% and 60%.

**TABLE 8-3 Primer Design: Properties of Oligonucleotides That Influence the Efficiency of Amplification**

PROPERTY	OPTIMAL DESIGN
Base composition	G+C content should be between 40% and 60%, with an even distribution of all four bases along the length of the primer (e.g., no polypurine tracts or polypyrimidine tracts and no dinucleotide repeats).
Length	The region of the primer complementary to the template should be 18–25 nucleotides long. Members of a primer pair should not differ in length by >3 bp.
Repeated and self-complementary sequences	No inverted repeat sequences or self-complementary sequences >3 bp in length should be present. Sequences of this type tend to form hairpin structures, which, if stable under PCR conditions, can effectively prevent the oligonucleotide from annealing to its target DNA.
Complementarity between members of a primer pair	The 3' terminal sequences of one primer should not be able to bind to any site on the other primer. Because primers are present at high concentration in PCR, even weak complementarity between them leads to hybrid formation and the consequent synthesis and amplification of primer dimers. If primer dimers form early in PCR, they can compete for DNA polymerase, primers, and nucleotides and so can suppress amplification of the target DNA. Formation of primer dimers can be reduced by careful primer design, by the use of hot start or touchdown PCR, and/or by the use of specially formulated DNA polymerases (e.g., AmpliGold, Perkin-Elmer). When more than one primer pair is used in a single PCR, check that none of the 3' ends have detectable complementarity to any other primers in the reaction.
Melting temperatures ( $T_m$ )	Calculated $T_m$ values of members of a primer pair should not differ by >5°C. The $T_m$ of the amplified product should not differ from the $T_m$ values of the primer pairs by >10°C. This property ensures that the amplified product will be efficiently denatured during each cycle of PCR.
3' Termini	The nature of the 3' end of primers is crucial. If possible, the 3' base of each primer should be G or C. However, primers with a ....NNCG or ....NNGC sequence at their 3' termini are not recommended because the unusually high $\Delta G$ of the terminal GC bases promotes the formation of hairpin structures and may generate primer dimers.
Adding restriction sites, bacteriophage promoters, and other sequences to the 5' termini of primers	Useful sequences not complementary to the target DNA are commonly added to the 5' end of the primer. In general, the presence of such sequences does not significantly affect annealing of the oligonucleotide to its target DNA. These additional sequences include bacteriophage promoters (Kain et al. 1991) and GC clamps (Sheffield et al. 1989). Restriction sites are a special case. Because the efficiency of cleavage of restriction sites located at the 5' termini of DNA molecules is poor, the primer should be extended by at least three additional nucleotides beyond the recognition sequence of the restriction enzyme. New England Biolabs' catalog contains information on the efficiency with which different restriction enzymes cleave sites near the termini of DNA molecules.
Placement of priming sites	Depending on the purpose of the experiment, the placement of priming sites may be constrained by the location of mutations, restriction sites, coding sequences, microsatellites, or <i>cis</i> -acting elements. When designing primers for use on cDNA templates, it is best to use forward and reverse primers that bind to sequences in different exons. This allows amplification products derived from cDNA and contaminating genomic DNA to be easily distinguished.
Primers for degenerate PCR	When a short sequence of amino acids has been obtained by sequencing a purified protein, pools of degenerate oligonucleotides containing all possible coding combinations can be used to amplify the corresponding genomic or cDNA sequences. For more details, please see Protocol 11 on MOPAC.

Many excellent reviews on primer design are available, including Piechocki and Hines (1994), Sharrocks (1994), Dieffenbach et al. (1995), Rychlik (1995), and Mitsuhashi (1996).

- **Refining the length and/or placement of the oligonucleotides** so that the 3'-terminal nucleotide is a G or a C. Check that the two oligonucleotides do not display significant complementarity. As a rule of thumb, no more than three consecutive nucleotides on one primer should be complementary to the other primer.

## Computer-assisted Design of Oligonucleotide Primers

To avoid boredom, save time, and minimize problems, use computer programs to optimize the design, selection, and placement of oligonucleotide primers. Many stand-alone computer programs can be obtained to search sequences for priming sites that fit a set of user-defined parameters. Such programs generate a hierarchy of potentially specific primers whose melting temperatures have been calculated, generally using the nearest-neighbor method, in which the thermodynamic stability of the primer:template duplex is derived from the sum of the stacking interactions of neighboring bases (e.g., please see Breslauer et al. 1986; Rychlik 1995; Owczarzy et al. 1997).

Most of the programs use graphic tools, employ user-friendly interfaces, and rank potential primers and primer pairs according to the weight assigned to various parameters. Some of the programs contain, for example, facile searching of databases for unintentional matches to the primer, optimization of conditions for the amplification reaction, translation of amino acid sequences into populations of degenerate oligonucleotides, and elimination of primers capable of forming stable secondary structures. All of the popular DNA analysis packages contain sophisticated modules for primer design (please see Appendix 11).

## Calculating Melting Temperatures of Hybrids between Oligonucleotide Primers and Their Target Sequences

Several equations are available to calculate the melting temperature of hybrids formed between an oligonucleotide primer and its complementary target sequence. Since none of these are perfect, the choice between them is largely a matter of personal preference. The melting temperatures of each member of a primer pair should obviously be calculated using the same equation.

- An empirical and convenient equation, known as "The Wallace rule" (Suggs et al. 1981; Thein and Wallace 1986), can be used to calculate the melting temperature for perfect duplexes 15–20 nucleotides in length in solvents of high ionic strength (e.g., 1 M NaCl):

$$T_m \text{ (in } ^\circ\text{C)} = 2(\text{A}+\text{T}) + 4(\text{G}+\text{C})$$

where (A+T) is the sum of the A and T residues in the oligonucleotide and (G+C) is the sum of G and C residues in the oligonucleotide.

- The equation derived originally by Bolton and McCarthy (1962) and later modified by Baldino et al. (1989) predicts reasonably well the melting temperature of oligonucleotides, 14–70 nucleotides in length, in cation concentrations of 0.4 M or less:

$$T_m \text{ (in } ^\circ\text{C)} = 81.5^\circ\text{C} + 16.6 (\log_{10}[\text{K}^+]) + 0.41(\%[\text{G}+\text{C}]) - (675/n)$$

where  $n$  is the number of bases in the oligonucleotide. This equation can also be used to calculate the melting temperature of an amplified product whose sequence and size are both known. When PCR amplification is carried out under standard conditions, the calculated

melting temperature of the amplified product should not exceed  $\sim 85^{\circ}\text{C}$ , which will ensure complete separation of its strands during the denaturation step. Note that the denaturation temperature in PCR is more accurately defined as the temperature of irreversible strand separation of a homogeneous population of molecules. The temperature of irreversible strand separation is several degrees higher than the melting temperature (typically,  $92^{\circ}\text{C}$  for DNA whose content of G+C is 50%) (Wetmur 1991).

None of the above equations take into account the effect of base sequence (as opposed to base composition) on the melting temperature of oligonucleotides. A more accurate estimate of melting temperature can be obtained by incorporating nearest-neighbor thermodynamic data into the equations (Breslauer et al. 1986; Freier et al. 1986; Rychlik et al. 1990; Wetmur 1991; Rychlik 1994). However, the Wallace rule and the Baldino algorithm are far simpler to apply and are perfectly adequate for most purposes.

### **CONTAMINATION IN PCR**

A problem commonly encountered in PCR is contamination with exogenous DNA sequences that can be amplified by the oligonucleotide primers. In every case, this contamination is the fault of sloppy work by investigators or their colleagues, who inadvertently introduce potential target sequences into equipment, solutions, and enzymes used in PCR. The first sign of trouble is generally the appearance of an amplification product in the negative controls that lack template DNA. From that moment on, all amplified products obtained in the reactions containing test DNAs must be regarded as suspect. In our experience, little is gained in searching for the source(s) of the contamination. Instead, it is simpler, less expensive, and less disruptive for all concerned to discard *all* solutions and reagents and *all* disposables, to decontaminate instruments, and to take steps such as those described below to reduce the risk of contamination in the future.

#### **Laboratory Space**

In an ideal world, PCRs would be assembled in a separate laboratory that has its own set of equipment and freezers for storing buffers and enzymes. A more practical alternative for most investigators, however, is to designate a particular section of the laboratory for setting up PCRs. The assembly of PCRs is best carried out in a laminar flow hood equipped with UV lights. These lights should be turned on whenever the hood is not in use. Keep in the hood a microfuge, disposable gloves, supplies, and sets of pipetting devices used to handle only reagents for PCR. Because the barrels of automatic pipetting devices are common sources of contamination, positive-displacement pipettes equipped with disposable tips and plungers should be used to prepare and handle reagents.

Alternatively, use preplugged, sterile, disposable pipette tips (e.g., Aerosol Resistant Tips, Research Products International) on automatic air-displacement pipetting devices. Disposable items such as pipette tips and tubes should be used directly from the manufacturer's packaging and should not be autoclaved before use. Thermal cyclers should be located in a separate area of the laboratory, well separated from the hood used for assembly of PCR and for preparation of reagents.

#### **Rules for Assembling and Performing PCRs**

Below is a list of rules for assembling and performing PCRs. Investigators who will be setting up PCRs must have an understanding of these rules and agree to follow them:

- Keep to a minimum all traffic in and out of the laboratory area designated for assembly of PCRs.
- Wear gloves when working in the area and change them frequently. Use face masks and head caps to reduce contamination from facial skin and hair cells.
- Make up your own set of reagents and disposable items (including PCR tubes, mineral oil, and wax beads). Use new glassware, plasticware, and pipettes that have not been exposed to DNAs in the laboratory to make

up and store solutions. Store buffers and enzymes in small aliquots, in a designated section of a freezer located near the flow hood. Discard aliquots of reagents after use. *Never* use PCR reagents for other purposes.

- Before opening microfuge tubes containing reagents used in PCRs, centrifuge them briefly (10 seconds) in the microfuge located in the laminar flow hood. This centrifugation deposits the fluid in the base of the tube and reduces the possibility of contamination of gloves or pipetting devices.
- Prepare dilutions of DNA used as templates in PCR at your own laboratory bench and then take only as much of the dilution as needed into the PCR area.
- At the end of the PCR, do not take the tubes containing amplified DNA into the PCR area. Instead, open the tubes and carry out postamplification processing at your laboratory bench.

#### Decontamination of Solutions and Equipment

Contaminating DNA can be inactivated by irradiating certain reagents (buffers minus dNTPs and H<sub>2</sub>O) with UV light at 254-nm wavelength. UV light forms dimers between adjacent pyrimidine residues in contaminating DNAs and renders them inactive as templates in the PCR. Irradiation (200–300 mJ/cm<sup>2</sup> for 5–20 minutes) is most readily accomplished in translucent white microfuge tubes using a commercially available UV cross-linker (e.g., Stratalinker, Stratagene). dNTPs are resistant to UV, but *Taq* DNA polymerase is not. The sensitivity of primers to UV is variable and unpredictable (Ou et al. 1991).

UV irradiation can also be used to decontaminate the outer surfaces of small pieces of equipment (racks, pipettes, etc). Work areas, nonmetallic surfaces of microfuges, and thermal cyclers can be decontaminated with weak solutions of bleach (e.g., 10% Clorox; Prince and Andrus 1992).

#### Preventing Contamination of One PCR by the Products of Another

Uracil *N*-glycosylase can be used to destroy amplified DNAs that are unintentionally carried from one PCR to another (Longo et al. 1990; Thornton et al. 1992; for review, please see Hartley and Rashtchian 1993). This enzyme will cleave uracil-glycosidic bonds in DNA that contains dU residues incorporated in place of dT residues, but will not cleave RNA or double-stranded DNA that contains rU or dT residues, respectively. The contamination protocol is initiated by routinely substituting dUTP for dTTP in PCR. This substitution has little effect on the specificity of the PCR or the analysis of PCR products. However, the yield of amplified products may be slightly reduced (Persing 1991). Nevertheless, when subsequent sets of PCRs are briefly treated with uracil *N*-glycosylase, contaminating DNA containing uracil residues is destroyed. The use of dUTP and uracil *N*-glycosylase to reduce contamination is most helpful when a small number of DNA fragments are to be amplified from many hundreds of samples, for example, as part of a large genetic screen. However, it is important to realize that decontamination by uracil *N*-glycosylase is helpful but not completely effective (Niederhauser et al. 1994): It should therefore be viewed only as a single component of a more comprehensive program to manage and prevent contamination.

# Protocol 1

---

## The Basic Polymerase Chain Reaction

**T**HIS PROTOCOL OUTLINES A PROTOTYPE AMPLIFICATION (please see Figure 8-2). Special reagents and equipment for typical amplification reactions are described below with general considerations for their preparation and use. For optimization of particular reaction conditions, please see Parameters That Affect Polymerase Chain Reactions in the introduction to this chapter. Below is a list of reagents and equipment for the basic PCR.

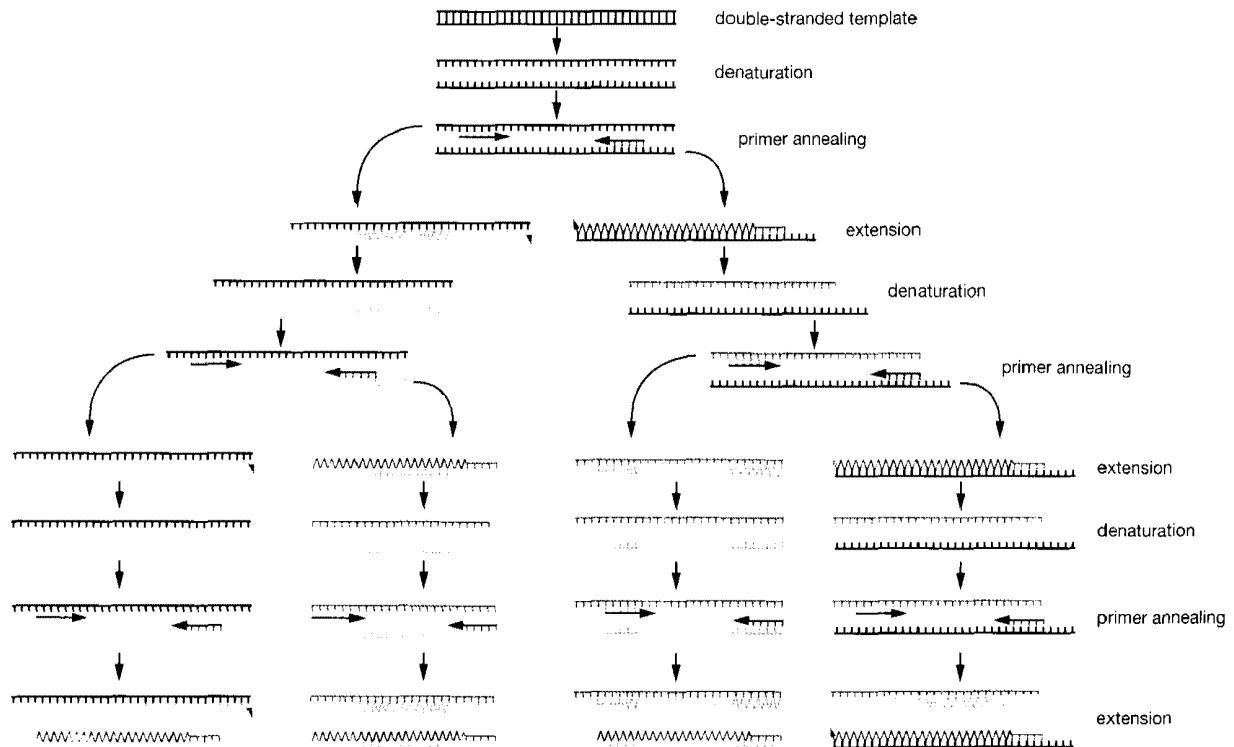
- **Primers.** Each primer should be 20–30 nucleotides in length and contain approximately equal numbers of the four bases, with a balanced distribution of G and C residues and a low propensity to form stable secondary structures. For further details, please see Design of Oligonucleotide Primers for Basic PCR in the introduction to this chapter. As discussed below, restriction sites are always designed into adaptor-primers; however, they can also be incorporated into the gene-specific oligonucleotides. Amplification using primers of this type generates amplified cDNAs carrying restriction sites at both ends, which can facilitate cloning.

If necessary, the yield of desired product can be improved by setting up a second round of amplification using another pair of primers that bind to sequences within the amplified segment of target DNA. After this second round of nested amplification, almost all of the product detected by ethidium bromide staining contains the desired segment of DNA.

Oligonucleotide primers synthesized on an automated DNA synthesizer can generally be used in standard PCR without further purification. However, amplification of single-copy sequences from mammalian genomic templates is often more efficient if the oligonucleotide primers are purified by chromatography on commercially available resins (e.g., NENSORB, NEN Life Science Products) or by denaturing polyacrylamide gel electrophoresis, as described in Chapter 10, Protocol 1.

- **Template DNA.** The template can be a fragment of DNA, a preparation of genomic DNA, a recombinant plasmid or bacteriophage  $\lambda$ , or any other DNA-containing sample. Template DNA is dissolved in 10 mM Tris-Cl (pH 7.6) containing a low concentration of EDTA (<0.1 mM).
- **Thermostable DNA polymerase.** *Taq* DNA polymerase is the standard and appropriate enzyme for the amplification stage of most forms of PCR. However, where elongation from 3′-mismatched primers is suspected, a thermostable DNA polymerase with 3′→5′ proofreading activity may be preferred (Chiang et al. 1993). Please see Thermostable DNA Polymerases (p. 8.6) and the information panel on **TAQ DNA POLYMERASE**.





**FIGURE 8-2** Sequence of Amplification in the PCR

The diagram shows the steps involved in the first few rounds of a PCR. The original template (*top line*) is double-stranded DNA and the leftward and rightward oligonucleotide primers are shown as ← and →, respectively. The products of the first few rounds of the amplification reaction are heterogeneous in size; however, the tract of DNA lying between the two primers is preferentially amplified and quickly becomes the dominant product of the amplification reaction.

*Taq* DNA polymerase is supplied in a storage buffer containing 50% glycerol. Because this solution is very viscous and difficult to pipette accurately, the best method is to centrifuge the tube containing the enzyme at maximum speed for 10 seconds at 4°C in a microfuge and then to withdraw the required amount of enzyme using a positive-displacement pipette.

- **Automatic pipetting devices.** Automatic micropipetting devices equipped with barrier tips should be used to assemble the components of PCRs. Disposable barrier tips are fitted with a hydrophobic barrier to prevent the accidental passage of liquids into a micropipetting device. This arrangement reduces the potential for cross-contamination of PCRs and DNA samples. Barrier micropipette tips are sold by several commercial companies (e.g., ART Barrier tips from Molecular Bioproducts, Inc.).
- **Positive-displacement pipette.** Positive-displacement pipetting, in which the piston is in direct contact with the liquid, is used for accurate transfer of high-viscosity liquids.
- **Microfuge tubes or microtiter plates.** Thin-walled plastic tubes that fit snugly in the block of the thermal cycler are used for amplification. Their use facilitates heat transfer and greatly reduces much of the time lag in reaching programmed temperatures.
- **Thermal cycler programmed with desired amplification protocol.** A large number of programmable thermal cyclers marketed by different commercial companies are licensed by Perkin-Elmer for use in PCR. The choice among these instruments depends on the investiga-

tor's inclination, the available budget, and the range of uses to which the machine will be put. Before purchasing a thermal cycler, we recommend soliciting as many opinions as possible to find out the pros and cons of different machines. If the machine is not licensed for use in PCR, investigators must negotiate their own financial arrangements with Perkin-Elmer. *The Scientist* profiles thermal cyclers every year ([www.the-scientist.com](http://www.the-scientist.com)).

## MATERIALS

▲ **IMPORTANT** To reduce the chance of contamination with exogenous DNAs, prepare and use a special set of reagents and solutions for PCR only. Bake all glassware for 6 hours at 15°C and autoclave all plasticware. For more information, please see the panel on **CONTAMINATION IN PCR** in the introduction to this chapter.

**CAUTION:** Please see Appendix 12 for appropriate handling of materials marked with <!.>.

### Buffers and Solutions

Please see Appendix 1 for components of stock solutions, buffers, and reagents. Dilute stock solutions to the appropriate concentrations.

*10x Amplification buffer*

*Chloroform <!.>*

*dNTP solution (20 mM) containing all four dNTPs (pH 8.0)*

### Enzymes and Buffers

*Thermostable DNA polymerase*

### Gels

*Polyacrylamide <!.> or agarose gel*

Please see Step 4.

### Nucleic Acids and Oligonucleotides

*Bystander DNA*

Please see the panel to Step 1.

*Forward primer (20 μM) in H<sub>2</sub>O and Reverse primer (20 μM) in H<sub>2</sub>O*

Please see the discussion on Primers in the protocol introduction.

Use the following formula to calculate the molecular weight of the oligonucleotides:

$$M_r = (C \times 289) + (A \times 313) + (T \times 304) + (G \times 329)$$

where *C* is the number of C residues in the oligonucleotide, *A* is the number of A residues, *T* is the number of T residues, and *G* is the number of G residues. The molecular mass of a 20-mer will be ~6000 daltons; 100 pmoles of the oligonucleotide will be equivalent to ~0.6 μg.

*Template DNA*

Dissolve template DNA in 10 mM Tris-Cl (pH 7.6) containing a low concentration of EDTA (<0.1 mM) at the following concentrations: mammalian genomic DNA, 100 μg/ml; yeast genomic DNA, 1 μg/ml; bacterial genomic DNA, 0.1 μg/ml; and plasmid DNA, 1–5 ng/ml.

### Special Equipment

*Barrier tips for automatic micropipetting device*

*Microfuge tubes (0.5 ml, thin-walled for amplification reactions) or Microtiter plates*

*Positive-displacement pipette*

*Thermal cycler programmed with desired amplification protocol*

If the thermal cycler is not equipped with a heated lid, use either mineral oil or paraffin wax to prevent evaporation of liquid from the reaction mixture during PCR. Paraffin wax not only prevents evaporation, but also maintains separation between components (e.g., primer and template) until the reaction mixture is heated. This separation prevents nonspecific binding of primers during the initial phase of the reaction (please see the information panel on **HOT START PCR**).

**Additional Reagents**

*Step 4 of this protocol may require the reagents listed in Chapter 6, Protocol 10, and/or Chapter 12, Protocol 6.*

**METHOD**

1. In a sterile 0.5-ml microfuge tube, amplification tube, or the well of a sterile microtiter plate, mix in the following order:

10x amplification buffer	5 $\mu$ l
20 mM solution of four dNTPs (pH 8.0)	1 $\mu$ l
20 $\mu$ M forward primer	2.5 $\mu$ l
20 $\mu$ M reverse primer	2.5 $\mu$ l
1–5 units/ $\mu$ l thermostable DNA polymerase	1–2 units
H <sub>2</sub> O	28–33 $\mu$ l
template DNA	5–10 $\mu$ l
Total volume	50 $\mu$ l

The table below provides standard reaction conditions for PCR.

Mg <sup>2+</sup>	KCl	dNTPs	Primers	DNA polymerase	Template DNA
1.5 mM	50 mM	200 $\mu$ M	1 $\mu$ M	1–5 units	1 pg to 1 $\mu$ g

The pH of the reaction buffer should be 8.3 when measured at 25°C. Because of the high temperature dependence of the pKa of Tris, the pH of the reaction will drop to ~7.2 at 72°C (Good et al. 1966; Ferguson et al. 1980). The amount of template DNA required varies according to the complexity of its sequence. In the case of mammalian DNA, up to 1.0  $\mu$ g is used per reaction. Typical amounts of yeast, bacterial, and plasmid DNAs used per reaction are 10 ng, 1 ng, and 10 pg, respectively.

Each set of PCRs must always include positive and negative controls. Positive controls are required to monitor the efficiency of the PCR, whereas negative controls are required to detect contamination with DNAs that contain the target sequence.

	Bystander DNA <sup>a</sup>	Template DNA <sup>b</sup>	Target DNA <sup>c</sup>	Specific Primers <sup>d</sup>
<b>Positive Controls</b>				
1	+	–	+	+
2	–	–	+	+
<b>Negative Controls</b>				
3	–	–	–	+
4	+	–	–	+

<sup>a</sup>Bystander DNA does not contain target sequences. It should resemble the template DNA in all other respects: complexity, size, and concentration.

<sup>b</sup>Template DNA is the DNA under test.

<sup>c</sup>Target DNA contains the target sequence. It can be a recombinant DNA clone, a purified DNA fragment, or a sample of genomic DNA. It should be added to the positive control at concentrations equivalent to those expected in the template DNA. It is often necessary to set up a series of positive controls containing different amounts of target DNA spanning the amount predicted in the template DNA. An appropriate dilution of the target sequence should be prepared ahead of time in an area of the laboratory different from that used for the preparation of other PCR reagents. This precaution reduces the risk of contaminating equipment and plasticware in the area of the laboratory set aside for PCRs.

<sup>d</sup>Specific Primers are oligonucleotide primers specific for the segment of target DNA.

- If the thermal cycler is not fitted with a heated lid, overlay the reaction mixtures with 1 drop (~50  $\mu$ l) of light mineral oil to prevent evaporation of the samples during repeated cycles of heating and cooling. Alternatively, place a bead of wax into the tube if using a hot start protocol. Place the tubes or the microtiter plate in the thermal cycler.
- Amplify the nucleic acids using the denaturation, annealing, and polymerization times and temperatures listed below.

Cycle Number	Denaturation	Annealing	Polymerization
30 cycles	30 sec at 94°C	30 sec at 55°C	1 min at 72°C
Last cycle	1 min at 94°C	30 sec at 55°C	1 min at 72°C

These times are suitable for 50- $\mu$ l reactions assembled in thin-walled 0.5-ml tubes and incubated in thermal cyclers such as the Perkin-Elmer 9600 or 9700, Master Cycler (Eppendorf), and PTC 100 (MJ Research). Times and temperatures may need to be adapted to suit other types of equipment and reaction volumes.

Polymerization should be carried out for 1 minute for every 1000 bp of length of the target DNA. Most thermal cyclers have an end routine in which the amplified samples are incubated at 4°C until they are removed from the machine. Samples can be left overnight at this temperature, but should be stored thereafter at -20°C.

- Withdraw a sample (5–10  $\mu$ l) from the test reaction mixture and the four control reactions and analyze them by electrophoresis through an agarose or polyacrylamide gel. Be sure to include DNA markers of an appropriate size. Stain the gel with ethidium bromide or SYBR Gold to visualize the DNA.

A successful amplification reaction should yield a readily visible DNA fragment of the expected size. The identity of the band can be confirmed by DNA sequencing (please see Chapter 12, Protocol 6), Southern hybridization (please see Chapter 6, Protocol 10), and/or restriction mapping.

If all has gone well, lanes of the gel containing samples of the two positive controls (Tubes 1 and 2) and the template DNA under test should contain a prominent band of DNA of the appropriate molecular weight. This band should be absent from the lanes containing samples of the negative controls (Tubes 3 and 4). If, on the other hand, all is not well, please see Tables 8-4 and 8-5.

- If mineral oil was used to overlay the reaction (Step 2), remove the oil from the sample by extraction with 150  $\mu$ l of chloroform.

The aqueous phase, which contains the amplified DNA, will form a micelle near the meniscus. The micelle can be transferred to a fresh tube with an automatic micropipette.

For many purposes, e.g., purification of the amplified DNA using a Centricon microconcentrator or cloning amplification products, it is desirable to remove the oil from the sample before proceeding.

**▲ IMPORTANT** Do not attempt chloroform extractions in microtiter plates. The plastic used in these plates is not resistant to organic solvents.

## OPTIMIZATION OF PCRs

When setting up PCRs for first time with new template DNA, new primers, or a new preparation of thermostable DNA polymerase enzyme, amplification will generally be less than optimal. Fine tuning of the reaction is usually required to suppress nonspecific amplification and/or to enhance the yield of the desired DNA product. Table 8-4 lists some commonly observed problems and suggests ways in which the reaction can be optimized.

**TABLE 8-4 Troubleshooting Amplifications**

PROBLEM	EXPLANATION	SUGGESTED REMEDY
Bands of the desired product are sharp but very faint in both positive controls <i>and</i> test PCR. Bands of the desired product smear into the portion of the gel containing lower-molecular-weight DNAs.	Inefficient priming or inefficient extension.	<p>Set up a series of PCRs containing different concentrations of the two primers. Find the optimal concentration and then set up a series of touchdown PCRs containing different concentrations of <math>Mg^{2+}</math> to find the optimal concentration.</p> <p>Include GC-Melt (CLONTECH) in the reaction mixture</p> <p>Use the minimum possible temperature during the annealing step.</p> <p>Consider adding adjuvants such as BSA (0.2–0.6 mg/ml), DMSO (5%), or glycerol (5%) to the reaction mixture.</p>
Bands of the desired product are very faint in the test sample and in positive control 2. The band in positive control 1 is much stronger.	Dirty template DNA.	Repurify the template DNA by extraction (twice) with phenol:chloroform and ethanol precipitation. Dissolve the purified DNA in $H_2O$ (no EDTA).
Bands in the negative controls.	Contamination of solutions or plasticware with template DNA.	Please see the panel on <b>CONTAMINATION IN PCR</b> (Introduction) and then make up new reagents.
Distinct band(s) of the wrong molecular weight.	Nonspecific priming by one or both primers.	Decrease the annealing time and/or increase the annealing temperature.
A generalized smear of amplified DNA that may obscure the desired product.	Amplification of primer dimers. Too much template DNA.	<p>Check that neither primer has homology with highly repetitive sequences in the template DNA. Optimize the concentrations of each primer independently.</p> <p>Use touchdown PCR and/or hot start PCR (please see the information panels).</p> <p>Reduce the amount of template DNA by factors of 2.5 and 10.</p>

## TROUBLESHOOTING MAJOR PROBLEMS THAT OCCUR IN PCRS

Table 8-5 describes problems that may be encountered in amplification reactions and provides guidance for how to address major difficulties.

**TABLE 8-5 Troubleshooting PCRs**

SYMPTOM	POSSIBLE CAUSES	POSSIBLE REMEDIES
Amplification weak or nondetectable.	Defective reagent(s); defective thermal cycler; programming error.	Compare the yields obtained from fresh and old reagents in PCRs incubated in two different thermal cyclers.
	Suboptimal annealing conditions.	Recalculate $T_m$ of primers. Use touchdown PCR, preferably in combination with hot start PCR. Verify the concentration of primers and, if necessary, optimize their concentration. If the primers appear to be the cause of the problem, design and synthesize new primers.
	Suboptimal extension of annealed primers.	Optimize the concentration of $MgCl_2$ , template DNA, and dNTPs. Test a range of pH values in the PCR. Consider replacing Tris with tricine, bicine, or EPPs which have a lower temperature coefficient than Tris (Cheng et al. 1994). Use a fresh preparation of thermostable DNA polymerase. Repurify the template DNA to remove inhibitors. Increase the number of cycles at constant annealing temperature (55°C). If problems persist, add an enhancer (e.g., 10% DMSO, 5% PEG 6000, or 10% glycerol). If problems still persist, <i>either</i> reamplify a 1:100 dilution of the PCR in fresh PCR buffer and primers for 30 cycles at a constant annealing temperature <i>or</i> carry out nested PCR. Use GC-Melt (CLONTECH) in the reaction mixture.
	Ineffective denaturation.	Increase the time or temperature of denaturation.
Multiple amplification products.	Distance between primers too large.	Use preparations of thermostable polymerases capable of amplifying long segments of DNA.
		Use touchdown PCR, preferably in combination with hot start or booster PCR. Optimize the concentration of $MgCl_2$ , template DNA, thermostable DNA polymerase, and dNTPs. Test a range of pH values. <i>Either</i> reamplify a 1:100 dilution of the PCR in fresh PCR buffer and primers for 30 cycles at a constant annealing temperature (55°C) <i>or</i> carry out nested PCR <i>or</i> recover the desired band of DNA from a gel and reamplify. Verify the concentration of primers and, if necessary, optimize their concentration. If the problem persists, design and synthesize new primers.
Excessive amounts of primer-dimers.		Use touchdown PCR, preferably in combination with hot start or booster PCR. If the problem persists, design and synthesize new primers, paying particular attention to the sequences of the 3' ends.

# Protocol 2

---

## Purification of PCR Products in Preparation for Cloning

**T**AQ POLYMERASE, AND PRESUMABLY OTHER THERMOSTABLE DNA polymerases, survive extraction with phenol:chloroform, ethanol precipitation, and other regimens commonly used to purify the products of PCRs (Crowe et al. 1991; Barnes 1992). The continuing presence of the DNA polymerase together with residual dNTPs often thwarts methods to tailor the ends of the amplified DNA for cloning. For example, the surviving DNA polymerase will fill recessed 3' termini created by digestion with restriction enzymes. Undoubtedly, the durability of *Taq* explains in large part the difficulties encountered by many laboratories in cloning PCR products after digestion with restriction enzymes (Bennett and Molenaar 1994).

The following method of purification of amplified DNA is based on procedures described by Crowe et al. (1991) and Wybranietz and Lauer (1998).

### MATERIALS

---

**CAUTION:** Please see Appendix 12 for appropriate handling of materials marked with <!.>.

#### Buffers and Solutions

Please see Appendix 1 for components of stock solutions, buffers, and reagents. Dilute stock solutions to the appropriate concentrations.

*Ammonium acetate (10 M)*

*Chloroform <!.>*

*Ethanol*

*Phenol:chloroform (1:1, v/v) <!.>*

*TE (pH 8.0)*

#### Enzymes and Buffers

*Proteinase K (20 mg/ml)*

Please see Appendix 4.

#### Gels

*Agarose gel containing 0.5 µg/ml ethidium bromide <!.>*

Please see Step 8. Be sure to include DNA markers of an appropriate size (please see Protocol 1).

## Nucleic Acids and Oligonucleotides

*Amplified DNA from polymerase chain reactions*

### Special Equipment

*DNA purification resin*

Optional, please see note to Step 6.

*Water bath preset to 75°C*

### METHOD

---

1. Pool up to eight PCRs (400  $\mu$ l) containing 1  $\mu$ g of the desired amplification product.  
If nonspecific amplification products are present at significant levels (e.g., are detectable by gel electrophoresis), purify the desired product by electrophoresis through low-melting-temperature agarose before proceeding (please see Chapter 5, Protocol 6).  
If mineral oil was used to prevent evaporation during PCR, centrifuge the pooled samples briefly and transfer the lower (aqueous) phase to a fresh microfuge tube.
2. Add 0.2 volume of 5x proteinase K buffer and proteinase K to a final concentration of 50  $\mu$ g/ml. Incubate the mixture for 60 minutes at 37°C.
3. Inactivate the proteinase K by heating the reaction mixture to 75°C for 20 minutes.
4. Extract the reaction mixture once with phenol:chloroform and once with chloroform.
5. Add 0.2 volume of 10 M ammonium acetate and 2.5 volumes of ethanol. Mix the solution well and store it for 30 minutes at 4°C.  
dNTPs carried over from the PCR are soluble in ethanolic solutions of ammonium acetate and will not precipitate with the desired product (Okayama and Berg 1983).
6. Recover the precipitated DNA by centrifugation at maximum speed for 5 minutes at 4°C in a microfuge. Discard the supernatant and then wash the pellet with 70% ethanol. Centrifuge the solution again, remove the supernatant, and then allow the pellet of DNA to dry in the air.  
The DNA may be further purified by chromatography on resins such as Wizard PCR Preps Purification System (Promega) or QIAquick (Qiagen) or by gel electrophoresis. This step is recommended when primers have been used to add restriction sites to the ends of the amplified DNA. Unused primers and primer-dimers should be removed before digesting the DNA with the appropriate restriction enzymes (please see Protocol 3).
7. Dissolve the pellet in TE (pH 8.0). Assume that the recovery of amplified DNA is 50–80% and dissolve the DNA in TE (pH 8.0) at an estimated concentration of 25  $\mu$ g/ml (25 ng/ $\mu$ l).
8. Analyze ~25 ng of the purified DNA by agarose-ethidium bromide gel electrophoresis, using markers of an appropriate size. Check that the amplified band fluoresces with the intensity expected of ~25 ng of DNA. If necessary, adjust the estimate of the concentration of the purified DNA.



# Protocol 3

---

## Removal of Oligonucleotides and Excess dNTPs from Amplified DNA by Ultrafiltration

**T**HERE ARE VERY GOOD REASONS TO REMOVE UNUSED OLIGONUCLEOTIDE primers, primer-dimers, and excess dNTPs from preparations of amplified DNA. First, residual dNTPs in the continuing presence of residual thermostable DNA polymerase can compromise many of the methods designed to tailor the ends of the amplified DNA in preparation for cloning (please see Protocols 4, 5, and 6). Second, the overabundance of the oligonucleotide primers used to generate the amplified DNA may lower the efficiency of subsequent PCRs in which the amplified DNA is used as a template. Third, primer-dimers may contribute high concentrations of restriction sites that may successfully compete with the termini of amplified DNA for cleavage. Several methods are available to cleanse amplified DNA of unwanted contaminants, including:

- the traditional extraction with phenol:chloroform (slow, messy, and comparatively inefficient, but good for simultaneous processing of many samples)
- chromatography on anionic silica gel resins (such QIAprep or Qiagen PCR Purification kits), glassmilk (BIO101 GeneClean II), or chaotropic silica-based resins (Promega's Wizard PCR Preps). The strengths and limitations of these chromatographic methods are discussed in detail in Chapter 1, Protocol 9.

Recently, an additional method — spin dialysis through a porous membrane — has become widely popular, which is odd because spin dialysis is slower, less efficient, and less able than chromatography to deal with many samples simultaneously (e.g., please see Mezei and Storts 1994). Despite these problems, spin dialysis, if carried out carefully, can reproducibly deliver amplified DNA in reasonable yield and free of significant amounts of dNTPs and oligonucleotides.

During spin dialysis, the solvent, together with low-molecular-weight solutes, is centrifuged through an anisotropic, hydrophilic, nonabsorbent, porous membrane. Macromolecules larger than the membrane pores are retained in the sample reservoir in a small volume of solvent. Following removal of the solutes, the concentrated sample is reconstituted to the original volume using the desired solvent. This process is repeated until the concentration of the original solutes is reduced to acceptable levels. Commercial concentrators are supplied with membranes of several different porosities that are characterized by a nominal molecular-weight cut-off. For removal of oligonucleotides, and dNTPs, Centricon-100 or Microcon-100 microconcentrators, which retain proteins with a molecular weight of >100,000, are routinely used. These devices allow oligonucleotide primers up to 48 bases in length to pass through the filter, and they retain dou-

ble-stranded PCR products as small as 125 bp (Krowczynska and Henderson 1992). Longer oligonucleotides are best removed by purifying the amplified DNA by gel electrophoresis.

This protocol is a modified version of a method supplied by M.B. Henderson that was originally described by Krowczynska and Henderson (1992).

## MATERIALS

---

**CAUTION:** Please see Appendix 12 for appropriate handling of materials marked with <!>.

### Buffers and Solutions

Please see Appendix 1 for components of stock solutions, buffers, and reagents. Dilute stock solutions to the appropriate concentrations.

*Chloroform* <!>

*Ethanol*

*Sodium acetate* (3 M)

*TE* (pH 8.0)

### Nucleic Acids and Oligonucleotides

*Amplification reaction products* (20–200  $\mu$ l)

### Centrifuges and Rotors

*Preparative centrifuge or microfuge*

Centricon-100 units will fit in any fixed-angle rotor with adaptors capable of supporting 17  $\times$  150-mm tubes. The centrifuge must be capable of generating a steady force of 1000g. Microcon-100 units require a variable-speed microfuge.

### Special Equipment

*Concentrators* (*Centricon-100* or *Microcon-100*, Amicon)

## METHOD

---

1. Place 2 ml of TE (pH 8.0) in the reservoir chamber of a Centricon-100 unit. Carefully separate the amplification reaction products from the upper mineral oil layer by pipetting or by extraction with chloroform. Transfer the amplification reaction products to the reservoir chamber of the Centricon-100 unit.
2. Place the entire unit into an appropriate rotor of a preparative centrifuge (e.g., a fixed-angle rotor). Insert the microconcentrator into the centrifuge with the filtrate cup (translucent portion) toward the bottom of the rotor. Use a concentrator filled with an equivalent amount of fluid or a standard balance tube as a counterbalance.  
**▲ IMPORTANT** Do not touch the membrane with pipette or pipette tips when loading the microconcentrator.
3. Centrifuge the loaded concentrator at 1000g for 30 minutes at a temperature between 4°C and 25°C.
4. Remove the concentrator from the centrifuge, and discard the filtrate cup. Invert the unit, and replace it in the centrifuge (i.e., the retentate tube should now be placed toward the bottom of the rotor). Centrifuge at 300–1000g for 2 minutes.

5. Remove the concentrator from the centrifuge; remove the retentate cup and discard the rest of the device. Transfer the fluid in the retentate cup to a fresh microfuge tube.
6. If necessary, precipitate the sample by adding one-tenth volume of 3 M sodium acetate and 2–3 volumes of ethanol. The amplified sample is now ready for subsequent manipulation (DNA sequencing and ligation).

A single centrifugation step through a Centricon-100 membrane removes ~95% of the primers and deoxynucleotides from the PCR. This process also inactivates the thermostable DNA polymerase (presumably by absorption to the membrane). A single purification step is usually sufficient for most subsequent manipulation steps. If necessary, trace oligonucleotide primers can be further removed by performing a second 30-minute centrifugation step. At Step 4 above, empty the translucent filtrate cup, reassemble the device, and add another 2-ml aliquot of TE (pH 8.0) to the reservoir chamber. Repeat Steps 2 through 4.

Smaller-scale and faster purification can be carried out using Microcon-100 units. The overall procedure is the same as that outlined above except that 400  $\mu$ l of TE is added to the reservoir chamber in Step 1, followed by 20–100  $\mu$ l of PCR. Centrifugation is carried out in a variable-speed microfuge at 3000g for 5–7 minutes. After inversion, the sample is transferred to the retentate cup by a 1-minute spin at 300–1000g. This procedure removes ~90% of the oligonucleotide primers and deoxynucleotides and can be repeated as described above to obtain further purification of the amplified DNA.

## Cloning PCR Products

**C** LONING AMPLIFIED SEGMENTS OF DNA GENERATED BY PCRS into plasmid or phagemid vectors turns out to be easier said than done. Many products of PCR are recalcitrant to cloning by the usual methods because:

- Several of the commonly used thermostable DNA polymerases possess a template-independent terminal transferase activity (extendase activity) that results in the addition of a single, unpaired nucleotide at the 3' ends of amplified DNA fragments (Clark 1988; Mole et al. 1989; Hu 1993). The nucleotide added to the 3' end depends both on the adjacent base and on the particular DNA polymerase used during PCR (Hu 1993). For example, when the 3'-terminal base of the template DNA is cytidine, *Taq* polymerase will efficiently transfer an adenine residue to the end of the completed chain (Clark 1988; Hu 1993).
- *Taq* polymerase and presumably other thermostable DNA polymerases survive extraction with phenol:chloroform, ethanol precipitation, and other regimens commonly used to purify the products of PCRs (Crowe et al. 1991; Barnes 1992). The continuing presence of the DNA polymerase together with residual dNTPs often thwarts methods to tailor the ends of the amplified DNA for cloning. For example, the surviving DNA polymerase will fill recessed 3' termini created by digestion with restriction enzymes. Undoubtedly, this carry-over explains in large part the difficulties encountered by many laboratories in cloning PCR products after digestion with restriction enzymes.

Over the years, many methods — some good and some bad — have been devised to circumvent these difficulties (for review, please see Levis 1995). These include:

- **Using the 3'→5' exonuclease activity of bacteriophage T4 DNA polymerase** or *Pfu* DNA polymerase to polish the termini of PCR products that contain extended bases (Hemsley et al. 1989). The polished DNAs can then be phosphorylated by T4 polynucleotide kinase and cloned into a blunt-ended dephosphorylated vector.
- **Cloning blunt-ended DNA fragments generated by thermostable DNA polymerases** such as *Pwo* and *Pfu*, which do not exhibit terminal transferase activity and generate blunt-ended products (Hinnisdaels et al. 1996). Blunt-end cloning is notoriously inefficient. Even in the presence of large amounts of bacteriophage T4 DNA ligase, the cloning efficiency of blunt-ended DNA is 10–100-fold lower than the efficiencies attained with DNAs equipped with cohesive termini. In addition, blunt-end ligation provides no opportunity to direct the orien-

tation of the amplified fragment of DNA within the vector. For these reasons, blunt-ended cloning of PCR products has fallen from favor in the last few years and has been largely replaced by methods that rely on ligation of cohesive ends.

- **Using a linearized plasmid vector fitted with a protruding 3' thymidylate** residue at each of its 3' termini. These T vectors are used to clone DNA fragments that carry a nontemplated, unpaired deoxyadenosyl residue at their 3' termini (Holton and Graham 1991; Hengen 1995a). A single unpaired 3' thymidine residue may not seem like much of a cohesive end, but it is enough to provide a strong toehold for the unpaired adenine residue on DNAs amplified in PCRs catalyzed by *Taq* or any other thermostable DNA polymerase that adds 3' adenosyl overhangs. Cloning into T vectors is reportedly 50 times more efficient than blunt-end cloning of amplified DNA fragments (Holton and Graham 1991; Marchuk et al. 1991). This is almost equal to the efficiency of cloning that can be achieved with DNAs whose 3' protrusions are a more respectable length.
- **Adding restriction sites to the 5' termini of the oligonucleotides** used to prime PCR. These primer-specific restriction sites are transferred to the termini of the target DNA during amplification (Scharf et al. 1986) and can then be cleaved with appropriate restriction enzymes to generate amplified segments of DNA with cohesive termini. Because the restriction sites may be identical or different in the two primers, this modification allows the investigator to tailor the termini of the amplified DNA fragment to the vectors best suited to the task at hand.

For years, this method of cloning PCR products was plagued with traps that, if not avoided, would ensnare entire experiments and visit sharp misery upon the investigator. These included the inability of some restriction enzymes to cleave sites efficiently near the termini of DNA molecules and the possible presence of internal restriction sites within amplified DNAs whose internal sequences were unknown (Crouse and Amorese 1986; Jung et al. 1990; Kaufman and Evans 1990). The problems have largely been solved by improving the design of oligonucleotide primers; by understanding the strengths and limitations of restriction enzymes; by converting terminal restriction sites to internal sites by concatemerization of amplified DNAs; and by devising better methods to eliminate primers, dNTPs, and thermostable DNA polymerase from the amplified product before digestion with restriction enzyme(s). For a more detailed discussion, please see the introduction to Protocol 6.

In addition to the basic methods discussed so far, a large variety of more esoteric techniques to clone amplified fragments of DNA have been described in hundreds of papers published over the years. These techniques include ligation-independent cloning (Aslanidis and de Jong 1990; Shuldiner et al. 1991; Haun et al. 1992; Kaluz and Flint 1994; Temesgen and Eschrich 1996; Shuldiner and Tanner 1997), UDG cloning (Nisson et al. 1991; Rashtchian et al. 1992; Smith et al. 1993; for review, please see Levis 1995), directional cloning using exonuclease III (Kaluz et al. 1992), in vivo cloning (Jones and Howard 1991; Oliner et al. 1993), and turbo cloning (Boyd 1993). Many of these methods require special strains of *E. coli*, particular vectors, oligonucleotide primers that contain modified bases, and/or the use of several different enzymes. Although these methods under special circumstances may have some advantage, it is difficult to think of cloning predicaments where the use of occult techniques would be obligatory.

The following four protocols describe how to clone amplified fragments of DNA by blunt-end ligation (Protocol 4), annealing to T vectors (Protocol 5), and addition of terminal restriction sites (Protocol 6) and by use of the principles of genetic engineering (Protocol 7).

# Protocol 4

---

## Blunt-end Cloning of PCR Products

**T**HE FOLLOWING ELEGANT AND SIMPLE PROTOCOL FOR POLISHING the termini of amplified DNA, adapted from Weiner (1993) and Chuang et al. (1995), builds on the earlier work of Liu and Schwartz (1992), who showed that incubation of a ligation reaction in the presence of an excess amount of restriction enzyme can dramatically increase the yield of recombinant plasmids. The role of the restriction enzyme is to cleave circular and linear concatemers at restriction sites that are regenerated when plasmid molecules ligate to themselves. The method requires that ligation of the plasmid to a target DNA molecule destroy the restriction site. This prevents the restriction enzyme from destroying recombinants generated during the ligation reaction. The net effect of constant reclamation of unit-length linear vector molecules is to drive the equilibrium of the ligation reaction strongly in favor of recombinants between vector and insert.

The method is efficient because regeneration of vector DNA, ligation, and polishing the termini of PCR-generated fragments of DNA all occur simultaneously in the same reaction mixture.

### MATERIALS

---

**CAUTION:** Please see Appendix 12 for appropriate handling of materials marked with <!.>.

#### Buffers and Solutions

Please see Appendix 1 for components of stock solutions, buffers, and reagents. Dilute stock solutions to the appropriate concentrations.

ATP (10 mM)

dNTP solution (2 mM) containing all four dNTPs

10x Universal KGB buffer

1 M potassium acetate

250 mM Tris-acetate (pH 7.6)

100 mM magnesium acetate tetrahydrate

5 mM  $\beta$ -mercaptoethanol <!.>

100  $\mu$ g/ml bovine serum albumin

#### Enzymes and Buffers

*Bacteriophage T4 DNA ligase*

*Bacteriophage T4 DNA polymerase*

Do not use the Klenow fragment of *E. coli* DNA polymerase as a polishing enzyme because it carries an endogenous terminal transferase activity.

*Restriction endonuclease for cloning*

The restriction enzyme should generate blunt ends, cleave the vector once, and *not* cleave the amplified DNA (please see Step 1).

*Restriction endonucleases*

Please see Step 4.

**Gels***Agarose gel*

Please see Step 5.

**Nucleic Acids and Oligonucleotides***Closed circular plasmid DNA (50 µg/ml)*

Choose a plasmid vector containing a single site for a restriction enzyme that generates blunt ends (e.g., *Sma*I, *Srf*I, and *Eco*RV). The restriction site should not be present in the amplified DNA, and ligation of the target fragment to the vector should not regenerate the restriction site. Among the plasmid vectors that are commonly used for cloning of blunt-ended PCR products are the Bluescript-type plasmids and plasmids containing abbreviated multiple cloning sites (e.g., pCR-Script Direct, Stratagene). The plasmid vector and its bacterial host should carry a blue/white screening system.

*Target DNA (25 µg/ml), amplified by PCR*

When the PCR mixture contains more than one or two bands of amplified DNA, purify the target fragment by electrophoresis through low melting/gelling temperature agarose (please see Chapter 5, Protocol 6). If not purified by gel electrophoresis, PCR-amplified DNA should be prepared for ligation by extraction with phenol:chloroform and ultrafiltration through a Centricon-100 filter (please see Protocol 3).

**Special Equipment**

*Water bath preset to 22°C*

**Additional Reagents**

*Step 3 of this protocol requires the reagents listed in Chapter 1, Protocol 25 or 26 and Protocol 27.*

*Step 4 of this protocol may require the reagents listed in Protocol 12 of this chapter.*

*Step 6 of this protocol requires the reagents listed in Chapter 12, Protocol 6, or Chapter 6, Protocol 10.*

**METHOD****1.** In a microfuge tube, mix the following in the order shown:

50 µg/ml closed circular plasmid vector	1 µl
25 µg/ml amplified target DNA	8 µl
10x universal KGB buffer	2 µl
H <sub>2</sub> O (please see note below)	5 µl
10 mM ATP	1 µl
2 mM dNTPs	1 µl
restriction enzyme	2 units
T4 DNA polymerase	1 unit
T4 DNA ligase	3 units

Adjust the amount of H<sub>2</sub>O added so that the final reaction volume is 20 µl.

Set up a control reaction that contains all of the reagents listed above except the amplified target DNA.

2. Incubate the ligation mixture for 4 hours at 22°C.  
The restriction enzyme cleaves the plasmid DNA; the 3'-exonuclease activity of T4 DNA polymerase polishes the ends of the amplified DNA in the presence of dNTP.
3. Dilute 5 µl of each of the two ligation mixtures with 10 µl of H<sub>2</sub>O and transform a suitable strain of competent *E. coli* to antibiotic resistance as described in Chapter 1, Protocol 25 or 26. Plate the transformed cultures on media containing IPTG and X-gal (please see Chapter 1, Protocol 27) and the appropriate antibiotic.
4. Calculate the number of colonies obtained from each of the ligation mixtures. Pick a number of white colonies obtained by transformation with the ligation reaction containing the target DNA. Confirm the presence of the amplified fragment by (i) isolating the plasmid DNAs and digesting them with restriction enzymes whose sites flank the insert in the multiple cloning site or (ii) colony PCR (Protocol 12).
5. Fractionate the restricted DNA by electrophoresis through an agarose gel using appropriate DNA size markers. Measure the size of the cloned fragments.
6. Confirm the identity of the cloned fragments by DNA sequencing, restriction mapping, or Southern hybridization.



# Protocol 5

---

## Cloning PCR Products into T Vectors

**T**HE SINGLE 3' ADENOSYL EXTENSION GENERATED by *Taq* DNA polymerase provides a highly efficient method to clone PCR products into a vector (T vector) containing a complementary unpaired 3' thymidyl residue (Holton and Graham 1991; Marchuk et al. 1991). T vectors may be created by the following three methods (Mezei and Storts 1994):

- Digest a vector with restriction enzymes such as *XcmI*, *HphI*, and *MboII* that generate 3'-terminal unpaired deoxythymidine residues (Kovalic et al. 1991; Mead et al. 1991; Chuang et al. 1995; Borovkov and Rivkin 1997).
- Use terminal transferase and dideoxyTTP to add a single protruding T residue to the 3' termini of a linearized vector (Holton and Graham 1991).
- Use the template-independent terminal transferase activity of *Taq* DNA polymerase to catalyze the addition of a T residue to the terminal 3'-hydroxyl groups of a linearized vector (Marchuk et al. 1991).

Alternatively, T vectors can be purchased ready-made from many commercial suppliers as components of cloning kits (e.g., pCR-Script [SK+] from Stratagene; pCRII in the TA Cloning kit from Invitrogen; pGEM-T from Promega) (Hengen 1995a).

### MATERIALS

---

#### Enzymes and Buffers

*Bacteriophage T4 DNA ligase*

#### Gels

*Agarose gel*

Please see Step 5.

#### Nucleic Acids and Oligonucleotides

*Target DNA (25 µg/ml), amplified by PCR*

When the PCR mixture contains more than one or two bands of amplified DNA, purify the target fragment by electrophoresis through low melting/gelling temperature agarose (please see Chapter 5,

Protocol 6). If not purified by gel electrophoresis, PCR-amplified DNA should be prepared for ligation by extraction with phenol:chloroform and ultrafiltration through a Centricon-100 filter (please see Protocol 3).

## Vectors

### *T* vector

For an outline of the generation of *T* vectors, please see the introduction to this protocol. *T* vectors and target DNAs tend to lose their unpaired 3' residues when frozen and thawed many times.

## Special Equipment

Water bath preset to 14°C

## Additional Reagents

Step 3 of this protocol requires the reagents listed in Chapter 1, Protocol 25 or 26 and Protocol 27.

Step 6 of this protocol requires the reagents listed in Chapter 12, Protocol 6, or Chapter 6, Protocol 10.

## METHOD

---

1. In a microfuge tube, set up the following ligation mixture:

25 µg/ml amplified target DNA	1 µl
T-tailed plasmid	20 ng
10x ligation buffer	1 µl
bacteriophage T4 DNA ligase	3 units
H <sub>2</sub> O	to 10 µl

If necessary, add ATP to a final concentration of 1 mM. A 1:5 molar ratio of vector:amplified DNA fragment is recommended.

Set up a control reaction that contains all the reagents listed above except the amplified target DNA.

2. Incubate the ligation mixture for 4 hours at 14°C.
3. Dilute 5 µl of each of the two ligation mixtures with 10 µl of H<sub>2</sub>O and transform a suitable strain of competent *E. coli* to antibiotic resistance as described in Chapter 1, Protocol 25 or 26. Plate the transformed cultures on media containing IPTG and X-gal (please see Chapter 1, Protocol 27) and the appropriate antibiotic.
4. Calculate the number of colonies obtained from each of the ligation mixtures. Pick a number of white colonies obtained by transformation with the ligation reaction containing the target DNA. Confirm the presence of the amplified fragment by (i) isolating the plasmid DNAs and digesting them with restriction enzymes whose sites flank the insert in the multiple cloning site or (ii) colony PCR (Protocol 12).  
The ratio of blue:white colonies varies between 1:5 and 2:1.
5. Fractionate the restricted DNA by electrophoresis through an agarose gel using appropriate DNA size markers. Measure the size of the cloned fragments.
6. Confirm the identity of the cloned fragments by DNA sequencing, restriction mapping, or Southern hybridization.

# Protocol 6

---

## Cloning PCR Products by Addition of Restriction Sites to the Termini of Amplified DNA

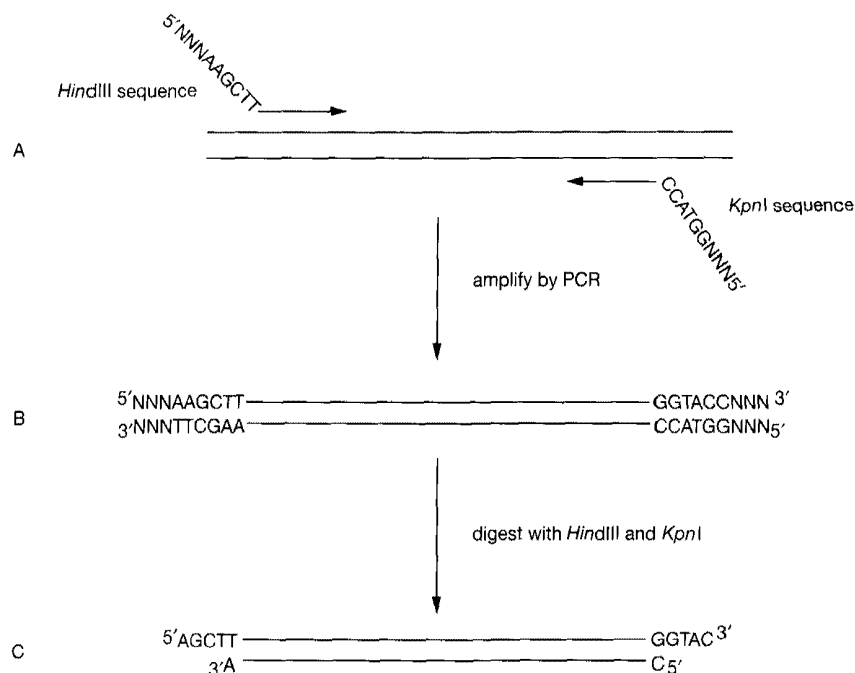
**P**AIRS OF OLIGONUCLEOTIDE PRIMERS USED IN PCR are often designed with restriction sites in their 5' regions. In many cases, the sites are different in the two primers. In this case, amplification generates a target fragment whose termini now carry new restriction sites that can be used for directional cloning into plasmid vectors (Scharf et al. 1986; Kaufman and Evans 1990). The purified fragment and the vector are digested with the appropriate restriction enzymes, ligated together, and transformed into *E. coli* (please see Figure 8-3).

For years, this method of cloning PCR products was beset with technical difficulties. Fortunately, most of these problems have been solved, bringing great improvements in both the efficiency and reproducibility of the technique. However, beware of the following pitfalls.

- Many restriction enzymes fail to cleave recognition sequences located close to the ends of DNA fragments, particularly those generated by PCR (e.g., please see Kaufmann and Evans 1990; Larrick 1992; Jung et al. 1993; Rychlik 1995; Zimmermann et al. 1998).
- The presence of residual polymerase activity and dNTPs after cleavage of the PCR product by restriction enzymes can regenerate a blunt-ended DNA.
- The presence in the reaction mixture of residual single-stranded primers or double-stranded primer-dimers may reduce the efficient cleavage of terminal restriction sites in amplified DNA molecules.

Solutions to these problems lie in the design of the oligonucleotide primers, the choice of restriction enzymes, and, as described above, in the elimination of primers, dNTPs, and thermostable DNA polymerase from the amplified product before digestion with restriction enzyme(s). Listed below are some helpful hints for designing primers.

- Wherever possible, design primers that create a different restriction site on each end of the amplified DNA. Directional cloning can then be used to attach the fragment to an appropriately prepared plasmid.
- Many restriction enzymes fail to cleave recognition sequences located close to the ends of DNA fragments, particularly those generated by PCR (e.g., please see Crouse and Amorese 1986; Ho et al. 1990; Jung et al. 1990, 1993; Kaufman and Evans 1990; Larrick 1992; Rychlik 1995; Zimmermann et al. 1998). Wherever possible, avoid using restriction enzymes such as *Hind*III,



**FIGURE 8-3 Cloning PCR Products by Addition of Restriction Sites**

Specific PCR primers (represented by arrows) are designed to amplify a region of interest with the desired recognition sequence for the restriction endonuclease included at the 5' end of the primer. The sense-strand primer contains the sense strand of a restriction site, and the antisense primer contains the complementary sequence of a second restriction site. (A) To achieve high efficiency digestion, additional nucleotides must be included on both sides of the restriction endonuclease sequence. In this example, proper recognition and cutting requires at least three additional bases on either side of the *HindIII* site, and at least two additional nucleotides on either side of the *KpnI* site. (B) Amplification by PCR produces a specific product with an *HindIII* site at the 5' end and a *KpnI* site at the 3' end. (C) Digestion with *HindIII* and *KpnI* produces a PCR product that can be cloned directionally.

*Sall*, *XbaI*, *XhoI*, and *NotI*, which are known to cleave terminal and subterminal recognition sites inefficiently. The catalogs of many commercial suppliers of enzymes (e.g., New England Biolabs) contain information about the efficiency of cleavage of these sites by restriction enzymes (see Appendix 4). Wherever possible, avoid using restriction enzymes that display "star" activity.

- Wherever possible, avoid using restriction sites that are known to occur naturally within the amplified segment of DNA. If the location and type of restriction sites are unknown, use restriction enzymes that are known to cleave the particular species of DNA very rarely.
- Design a "clamp" sequence at the extreme 5' ends of the oligonucleotide primers to hold together the ends of the amplified DNA and to provide an adequate toehold for the restriction enzymes. Unfortunately, there is no agreement about the minimal number of additional bases required to stabilize the termini of the amplified DNA. Early estimates ranged from 4 (Jung et al. 1990) to 20 (Ho et al. 1990) additional bases. More recent data (Zimmermann et al. 1998) suggest that in most cases, only 3 additional bases are required for efficient digestion by a variety of restriction enzymes. Perhaps the best advice is to add as many bases as reason and budget will allow to the 5' ends of the oligonucleotide primers.

## MATERIALS

---

**CAUTION:** Please see Appendix 12 for appropriate handling of materials marked with <!.>.

### Buffers and Solutions

Please see Appendix 1 for components of stock solutions, buffers, and reagents. Dilute stock solutions to the appropriate concentrations.

Chloroform <!.>  
 EDTA (0.5 M, pH 8.0)  
 Ethanol  
 Phenol:chloroform (1:1, v/v) <!.>  
 Sodium acetate (3 M, pH 5.2)  
 TE (pH 7.5)

### Enzymes and Buffers

Bacteriophage T4 DNA ligase  
 Restriction endonucleases

### Gels

Agarose gel  
 Please see Step 12.

### Nucleic Acids and Oligonucleotides

*Forward primer (20 μM) in H<sub>2</sub>O and Reverse primer (20 μM) in H<sub>2</sub>O*

Design forward and reverse primers carrying the appropriate restriction sites. The 3' end of each primer should be an exact complement of ~15 consecutive bases at a selected site in the target DNA. The 5' terminus of each primer serves as a clamp to hold together the termini of the amplified DNA and to provide a landing site for the restriction enzyme. The clamp should be 3–10 nucleotides in length. The mid-portion of the primer contains the recognition site for the restriction enzyme. Each primer should therefore be 24–31 nucleotides in length and contain approximately equal numbers of the four bases, with a balanced distribution of G and C residues and a low propensity to form stable secondary structures. For further details, please see the introduction to this protocol and the introduction to this chapter (Design of Oligonucleotide Primers for Basic PCR).

Oligonucleotide primers synthesized on an automated DNA synthesizer can generally be used in standard PCR without further purification.

*Target DNA*

### Vectors

*Plasmid DNA cleaved with the appropriate restriction enzyme(s) and purified by gel electrophoresis*

If the linearized plasmid DNA carries compatible termini that can be ligated to each other, use alkaline phosphatase to remove the 5'-phosphate groups and suppress self-ligation (please see Chapter 1, Protocol 20).

### Special Equipment

*Water bath preset to 16°C*  
*Water bath preset to optimum temperature for the restriction endonuclease digestions*  
 Please see Step 3.

### Additional Reagents

*Step 1 of this protocol requires the reagents listed in Protocol 1 of this chapter.*  
*Step 10 of this protocol requires the reagents listed in Chapter 1, Protocol 25 or 26 and Protocol 27.*  
*Step 11 of this protocol may require the reagents listed in Protocol 12 of this chapter.*  
*Step 13 of this protocol requires the reagents listed in Chapter 12, Protocol 6, or Chapter 6, Protocol 10.*

## METHOD

---

1. Use forward and reverse primers designed as outlined in the Materials section of this protocol to set up and carry out four identical amplification reactions (50- $\mu$ l volume) to amplify the target fragment (please see Protocol 1). Combine the four PCRs, which, in aggregate, should contain 200–500 ng of the desired amplification product.
2. If the PCR mixture contains more than one or two bands of amplified DNA, purify the target fragment by electrophoresis through low melting/gelling temperature agarose (please see Chapter 5, Protocol 6). If not purified by gel electrophoresis, prepare PCR-amplified DNA for ligation by extraction with phenol:chloroform and ultrafiltration through a Centricon-100 filter (please see Protocol 3). Dissolve the purified product in TE (pH 7.5) at a concentration of 25  $\mu$ g/ml.
3. In a reaction volume of 20  $\mu$ l, digest ~100 ng of purified PCR product with 1.0–2.0 units of the relevant restriction enzyme(s). Incubate the reactions for 1 hour at the optimum temperature for digestion.
4. At the end of the digestion, adjust the volume of the reaction mixture to 100  $\mu$ l with H<sub>2</sub>O, and add 0.5 M EDTA to a final concentration of 5 mM. Extract the reaction mixture once with phenol:chloroform and once with chloroform.
5. Transfer the aqueous phase to a fresh tube and add 3 M sodium acetate (pH 5.2) to achieve a final concentration of 0.3 M. Add 2 volumes of ethanol. Store the mixture for 30 minutes at 0°C.
6. Recover the precipitated DNA by centrifugation at maximum speed for 5 minutes at 4°C in a microfuge. Discard the supernatant, and then wash the pellet with 70% ethanol. Centrifuge the solution again, remove the supernatant, and allow the pellet of DNA to dry in the air for a few minutes.
7. Dissolve the DNA in 10  $\mu$ l of H<sub>2</sub>O.
8. In a microfuge tube, set up the following ligation mixture:
 

25 $\mu$ g/ml amplified target DNA	1.0 $\mu$ l
plasmid DNA	20 ng
10x ligation buffer	1.0 $\mu$ l
T4 DNA ligase	1 unit
H <sub>2</sub> O	to 10 $\mu$ l

If necessary, add ATP to a final concentration of 1 mM.  
When directional cloning is used, the ligation mixture should contain an ~1:1 molar ratio of purified target DNA to cleaved plasmid vector.

Set up a control reaction that contains all the reagents listed above except the amplified target DNA.
9. Incubate the ligation mixtures for 4 hours at 16°C.
10. Dilute 5  $\mu$ l of each of the two ligation mixtures with 10  $\mu$ l of H<sub>2</sub>O and transform a suitable strain of competent *E. coli* to antibiotic resistance as described in Chapter 1, Protocol 25 or 26. Plate the transformed cultures on media containing IPTG and X-gal (please see Chapter 1, Protocol 27) and the appropriate antibiotic.

11. Calculate the number of colonies obtained from each of the ligation mixtures. Pick a number of white colonies obtained by transformation with the ligation reaction containing the target DNA. Confirm the presence of the amplified fragment by (i) isolating the plasmid DNAs and digesting them with restriction enzymes whose sites flank the insert in the multiple cloning site or (ii) colony PCR (Protocol 12).

In different experiments, the ratio of blue:white colonies can vary between 1:5 and 2:1.

12. Fractionate the restricted DNA by electrophoresis through an agarose gel using appropriate DNA size markers. Measure the size of the cloned fragments.
13. Confirm the identity of the cloned fragments by DNA sequencing, restriction mapping, or Southern hybridization.

#### **TROUBLESHOOTING**

The absence of transformed, white colonies containing the PCR product of interest may be due to low efficiencies of transformation or inefficient ligation. For each experiment, include a positive control to monitor the efficiency of transformation of the preparation of competent *E. coli*. Confirm that the concentrations of vector and target DNAs are correct by analyzing samples of the ligation mixtures and controls using gel electrophoresis.

A high background of nonrecombinant colonies is most likely due to incomplete cleavage of the vector by restriction enzymes.

# Protocol 7

---

## Genetic Engineering with PCR

**T**HIS PROTOCOL (PROVIDED BY STEFAN ANDERSSON, UNIVERSITY OF TEXAS Southwestern Medical Center, Dallas) describes a method to introduce simultaneously restriction endonuclease sites at the 5' and 3' ends of a cloned mammalian cDNA and to change several codons at the 5' end of the cDNA to those preferentially utilized in *E. coli*. These types of end modifications are frequently used in engineering cDNAs, or genes, before cloning in various eukaryotic and prokaryotic expression vectors (please see Chapters 15 and 16). Additional methods for modifying the ends of DNA molecules are described in the panel below.

### **MORE STRATEGIES FOR MUTAGENESIS**

The variations on end modification of DNA are numerous. Several clever strategies use this type of amplification reaction in site-directed mutagenesis. For example, Hemsley et al. (1989) describe a modified form of inverse PCR in which the starting plasmid vector and the insert to be mutated are amplified at the same time. The oligonucleotide primers contain the mutations or modifications to be incorporated into the cDNA or gene and proceed outward from two adjacent nucleotides in the target DNA. The amplification reaction produces linear products from the circular plasmid DNA. Intramolecular ligation of the products gives rise to circular molecules, which can be used to transform *E. coli*, a proportion of which contain the desired changes. This method works well for repeated mutagenesis of a previously constructed expression vector. The procedure potentially suffers from two drawbacks: the overall size limit of the PCR (~4 kb) and the tendency of some thermostable DNA polymerases to add unpaired nucleotide residues to the 3' ends of amplified DNA. A long PCR protocol can overcome the size limit problem (please see Protocol 13) (Barnes 1994). Several remedies to the latter problem are discussed in the introduction to Protocol 1.

End modification can be combined with standard bacteriophage M13 site-specific mutagenesis (please see Chapter 13, Protocol 2) to enact domain swaps between different proteins (Clackson and Winter 1989) and to create cDNA or gene chimeras via overlap extension (Horton et al. 1990). Finally, a deletion can also be introduced into a cloned fragment of DNA by use of inverse PCR and two oligonucleotide primers that abut the desired deletion endpoints (Imai et al. 1991).



## MATERIALS

---

▲ **IMPORTANT** To reduce the chance of contamination with exogenous DNAs, prepare and use a special set of reagents and solutions for PCR only. Bake all glassware for 6 hours at 150°C and autoclave all plasticware. For more information, please see the panel on **CONTAMINATION IN PCR** in the chapter introduction.

**CAUTION:** Please see Appendix 12 for appropriate handling of materials marked with <!>.

### Buffers and Solutions

Please see Appendix 1 for components of stock solutions, buffers, and reagents. Dilute stock solutions to the appropriate concentrations.

*10x Amplification buffer*

*dNTP solution (20 mM) containing all four dNTPs (pH 8.0)*

### Enzymes and Buffers

*Appropriate restriction endonucleases*

*Thermostable DNA polymerase*

### Gels

*Agarose or Polyacrylamide gel <!>*

*Please see Step 5.*

### Nucleic Acids and Oligonucleotides

*Oligonucleotide primer 1 (10 μM) in TE (pH 8.0) and Oligonucleotide primer 2 (10 μM) in TE (pH 8.0)*

*Positive control DNA*

*Template DNA*

*The template DNA could be, for example, a cloned gene or cDNA in a vector or genomic DNA.*

### Vectors

*Vector DNA cleaved with the appropriate restriction enzyme(s) and purified by gel electrophoresis*

*If the restricted vector DNA carries compatible termini that can be ligated to each other, use alkaline phosphatase to remove the 5'-phosphate groups and suppress self-ligation (please see Chapter 1, Protocol 20).*

### Special Equipment

*Barrier tips for automatic micropipetting device*

*Microfuge tubes (0.5 ml, thin-walled for amplification) or Microtiter plates*

*Positive-displacement pipette*

*Thermal cycler programmed with desired amplification protocol*

*If the thermal cycler is not equipped with a heated lid, use either mineral oil or paraffin wax to prevent evaporation of liquid from the reaction mixture during PCR.*

### Additional Reagents

*Step 5 of this protocol requires the reagents listed in Chapter 5, Protocol 2, Chapter 12, Protocol 6, or Chapter 6, Protocol 10.*

*Step 6 of this protocol requires the reagents listed in Protocol 3 of this chapter.*

*Step 7 of this protocol requires the reagents listed in Protocol 6 of this chapter.*

## METHOD

1. Design and synthesize the appropriate oligonucleotide primers for the end modifications desired.

In this example, two primers derived from the 5' sequence (5' dATCATATGGCTCTGGATGA ACTGTGCCTGCTGGACATGCT 3') and the 3' sequence (5' dATAAGCTTTTATTAAGACAGAC TCAGCTCATGGGAGGCAA 3') of the starting cDNA template are used to introduce an *Nde*I (CATATG) site at the 5' end of the cDNA and to change several codons to those preferentially used in *E. coli*. The underlined nucleotides indicate differences between the oligonucleotide primers and the cDNA template. The number of perfectly matched nucleotides required at the 3' end of the oligonucleotide primers for a successful amplification has not been rigorously determined; however, eight to ten generally work well.

2. In a sterile 0.5-ml microfuge tube, amplification tube, or the well of a sterile microtiter plate, mix in the following order:

100 ng template DNA	10 $\mu$ l
10 $\times$ amplification buffer	5 $\mu$ l
20 mM solution of four dNTPs	5 $\mu$ l
10 $\mu$ M primer 1 (50 pmoles)	5 $\mu$ l
10 $\mu$ M primer 2 (50 pmoles)	5 $\mu$ l
1–2 units of thermostable DNA polymerase	1 $\mu$ l
H <sub>2</sub> O	to 50 $\mu$ l

Set up two control reactions. In one reaction, include all of the above additions, except the template DNA. In the other reaction, include a DNA template that has previously yielded a positive result in the PCR. Carry the controls through all subsequent steps of the protocol.

3. If the thermal cycler is not fitted with a heated lid, overlay the reaction mixtures with 1 drop (~50  $\mu$ l) of light mineral oil. This prevents evaporation of the samples during repeated cycles of heating and cooling. Alternatively, place a bead of wax into the tube if using hot start PCR. Place the tubes or the microtiter plate in the thermal cycler.
4. Amplify the nucleic acids using the denaturation, annealing, and polymerization times and temperatures listed in the table.

Cycle Number	Denaturation	Annealing/Polymerization
20 cycles	1 min at 94°C	3 min at 68°C
Last cycle	1 min at 94°C	15 min at 68°C

These times are suitable for 50- $\mu$ l reactions assembled in thin-walled 0.5-ml tubes and incubated in thermal cyclers such as the Perkin-Elmer 9600 or 9700, Master Cycler (Eppendorf), and PTC 100 (MJ Research). Times and temperatures may need to be adapted to suit other types of equipment and reaction volumes.

A small number of cycles are performed to decrease the chance of introducing spurious mutations.

5. Analyze 5–10% of the amplification on an agarose or polyacrylamide gel and estimate the concentration of the amplified target DNA. Be sure to include DNA markers of an appropriate size. Stain the gel with ethidium bromide or SYBR Gold to visualize the DNA.

A successful amplification reaction should yield a readily visible DNA fragment of the expected size. The identity of the band can be confirmed by DNA sequencing (please see Chapter 12), Southern hybridization (please see Chapter 6), and/or restriction mapping.

6. If mineral oil was used to overlay the reaction (Step 3), remove the oil from the sample by extraction with 150  $\mu$ l of chloroform.

The aqueous phase, which contains the amplified DNA, will form a micelle near the meniscus. The micelle can be transferred to a fresh tube with an automatic micropipette.

For many purposes, for example, purification of the amplified DNA using a Centricon microconcentrator or cloning amplification products, it is desirable to remove the oil from the sample before proceeding.

**▲ IMPORTANT** Do not attempt chloroform extractions in microtiter plates. The plastic used in these plates is not resistant to organic solvents.

7. For subsequent cloning, cleave the DNA fragment at the restriction sites placed (or located) at the 5' ends of the primers (with *Nde*I and *Hind*III in the above example). Purify the digested fragment using gel electrophoresis or ultrafiltration (please see Protocol 3).
8. Set up the appropriate ligation reaction with the desired vector DNA. Use a molar ratio of insert to vector of 3:1 in the ligation reactions.

Because of the error rate of thermostable DNA polymerases, it is very important to verify the sequence of the amplified DNA after cloning into the expression vector.

#### **TROUBLESHOOTING**

The most common result in a failed reaction is the appearance of a smear of bands on the ethidium-bromide-stained gel. This is usually due to the use of too much input template DNA. In this situation, carry out several pilot PCRs in which the amount of input DNA is varied over at least a 100-fold range (i.e., 1–100 ng).

# Protocol 8

---

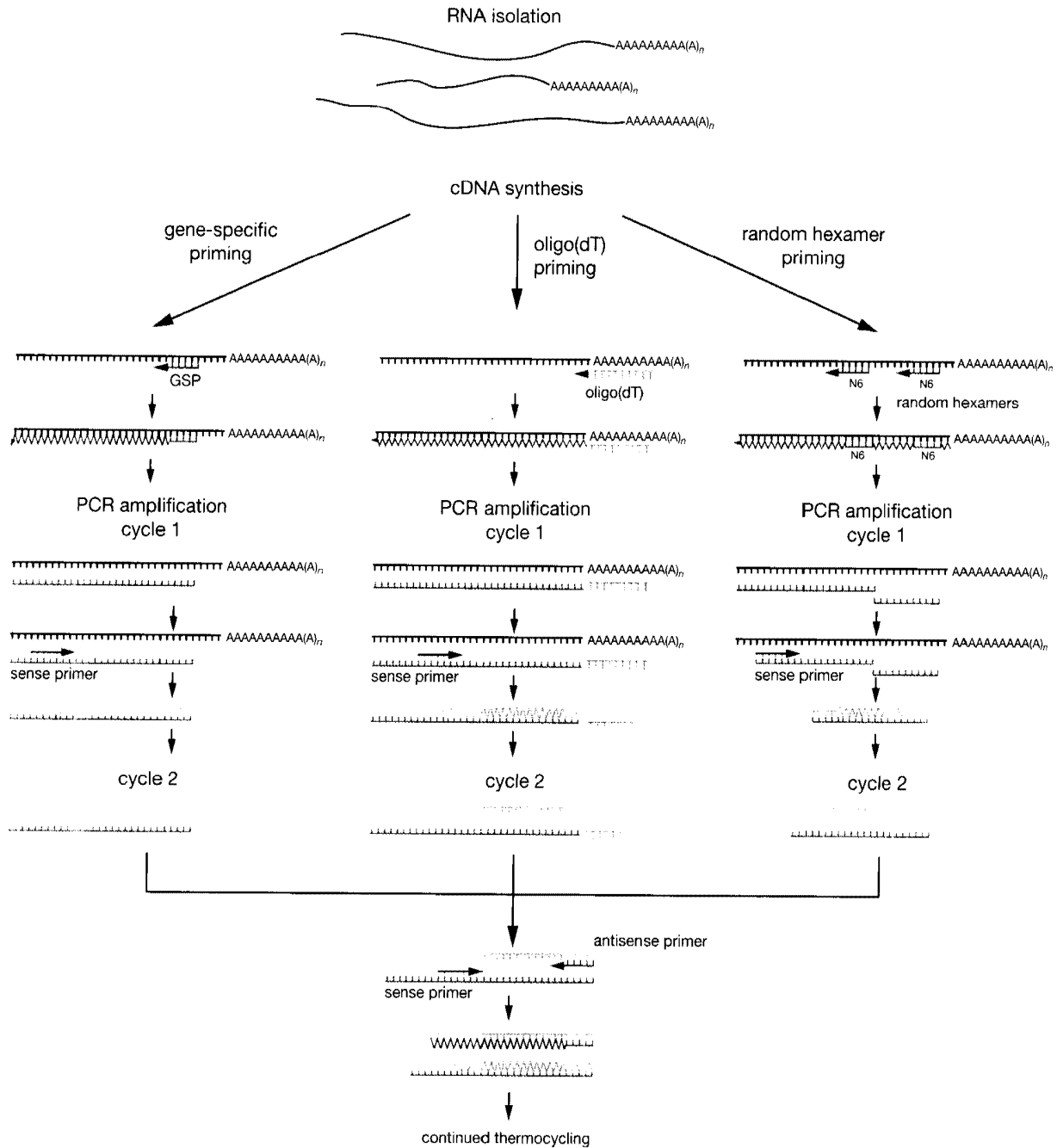
## Amplification of cDNA Generated by Reverse Transcription of mRNA

**R**EVERSE TRANSCRIPTASE-PCR (RT-PCR) IS A METHOD used to amplify cDNA copies of RNA. Sensitive and versatile, RT-PCR is used to retrieve and clone the 5' and 3' termini of mRNAs and to generate large cDNA libraries from very small amounts of mRNA. In addition, RT-PCR can be easily adapted to identify mutations and polymorphisms in transcribed sequences and to measure the strength of gene expression when the amounts of available mRNA are limited and/or when the RNA of interest is expressed at very low levels.

The literature is abundantly adorned with descriptions of variants of RT-PCR, many of which have their own acronym. The technical details may vary from one paper to the next, but the underlying concepts are constant and relatively simple: In every case, the first step is the enzymatic conversion of RNA to a single-stranded cDNA template. An oligodeoxynucleotide primer is hybridized to the mRNA and is then extended by an RNA-dependent DNA polymerase to create a cDNA copy that can be amplified by PCR. Depending on the purpose of the experiment, the primer for first-strand cDNA synthesis can be specifically designed to hybridize to a particular target gene or it can bind generally to all mRNAs (please see Figure 8-4).

- Oligo(dT), which binds to the endogenous poly(A)<sup>+</sup> tails of mammalian mRNAs, can be used as a universal primer for conventional first-strand cDNA synthesis. Subsequent amplification by PCR generally utilizes one or more internal, gene-specific primers and oligo(dT) to generate copies of the 3'-terminal sequences of a particular mRNA (3'-RACE; please see Protocol 10).
- cDNA synthesis can be primed by a synthetic antisense oligonucleotide that hybridizes specifically to a chosen region in a particular target RNA or family of mRNAs. Amplification of the desired portion of cDNA can be achieved in PCRs primed, for example, by sense and antisense oligonucleotide primers corresponding to specific sequences in particular cDNAs. For maximum specificity, the antisense primer should be located upstream of the oligonucleotide used to prime cDNA synthesis.

Wherever possible, oligonucleotides that bind to sequences located in different exons of the target RNA should be used as sense and antisense primers for amplification of the cDNA product. In this way, amplification products derived from cDNA and contaminating genomic DNA can be easily distinguished. However, transcripts of intronless genes cannot be differentiated unambiguously from contaminating genomic sequences. In these circumstances, treating the RNA preparation with RNase-free DNase may be helpful (Grillo and Margolis 1990; please see Chapter 9, Protocol 8).



**FIGURE 8-4 Schematic Representation of Various Methods for the Amplification of RNA by PCR**

The first-strand synthesis of cDNA may be primed using either a gene-specific primer (GSP), oligo(dT), or a random hexamer sequence. Second-strand synthesis (amplification cycle 1) is primed with the sense primer. Amplification of cDNA continues in the presence of both sense and antisense primers. (Modified, with permission, from Dieffenbach and Dveksler 1995.)

- Random hexanucleotides, which are capable of priming cDNA synthesis at many points along RNA templates, generate fragmentary copies of the entire population of RNA molecules. They are useful when the target RNA is extremely long or contains so much secondary structure that cDNA synthesis cannot be efficiently primed by oligo(dT) or synthetic oligonucleotide(s) (Lee and Caskey 1990). Because all mRNAs in the population can serve as templates, gene-specific

amplification is achieved by using sense and antisense primers targeted to sequences in the cDNA.

In most cases, investigators aim to generate a first strand of cDNA that is as long as possible and contains a high proportion of molecules complementary to the target RNA. Synthetic gene-specific oligonucleotides that bind to the 3'-untranslated regions of the target mRNA are therefore the primers of choice. Oligo(dT) is the next best option, and random hexamers, which have no specificity and generate both long and short molecules of cDNA, are used when the other methods of priming fail.

A second primer and a thermostable DNA polymerase are then added for the subsequent PCR-driven amplification step. Positive and negative controls should always be included when setting up RT-PCRs. Negative controls are generated by omitting essential components of the RT stage of the RT-PCR. Positive controls, however, are much trickier because they require standards that can be transcribed into cDNA and amplified in parallel with the authentic target sequence. Ideally, these standards should consist of known amounts of a synthetic RNA transcribed in vitro

#### REVERSE TRANSCRIPTASES USED IN RT-PCR

The discovery of DNA-dependent RNA polymerases in 1970 solved the long-standing puzzle of how the RNA genomes of certain tumor viruses could be copied into DNA in infected and/or transformed cells (Baltimore 1970; Temin and Mizutani 1970). The name *reverse transcriptase* was coined as a joke by John Tooze, who first used it in an anonymous News and Views article in *Nature*. Much to the annoyance of purists and the delight of Tooze, the name stuck and quickly became iconic.

Three forms of RNA-dependent DNA polymerases are now used in vitro to catalyze the synthesis of DNA complementary to an RNA template:

- **Mesophilic enzymes encoded by avian myeloblastosis virus (AMV) and the Moloney strain of murine leukemia virus (Mo-MLV).** Both enzymes require an RNA or DNA template with an RNA or DNA primer bearing a 3'-hydroxyl group. Lacking an editing 3'→5' exonuclease activity, both enzymes are prone to error. The  $K_m$  values for their dNTP substrates are very high, in the millimolar range. To ensure complete transcription of template RNAs, it is essential to include a high concentration of dNTPs in the reaction.

The enzyme encoded by AMV has a powerful RNase H activity that can digest the RNA moiety of RNA-DNA hybrids and can cleave the template near the 3' terminus of the growing DNA strand if reverse transcriptase pauses during synthesis (Kotewicz et al. 1988). Thus, the high level of RNase H activity associated with the avian reverse transcriptase tends to suppress the yield of cDNA and restrict its length (for further details, please see the information panel on **RIBONUCLEASE H**).

The murine enzyme is far better suited for RT-PCR because its RNase H activity is comparatively weak (Gerard et al. 1997). However, the Mo-MLV enzyme reaches maximum activity at a lower temperature (37°C) than the avian enzyme (42°C), which may be a slight disadvantage if the RNA template has a high degree of secondary structure.

- **Variants of Mo-MLV reverse transcriptase that lack RNase H activity.** Several such enzymes are sold commercially (e.g., *Superscript* from Life Technologies and *StrataScript* from Stratagene). The modified reverse transcriptases transcribe a greater proportion of the template molecules and synthesize longer cDNA molecules than the wild-type enzyme (Gerard et al. 1988, 1997; Kotewicz et al. 1988; Telesnitsky and Goff 1993). In addition, they are capable of cDNA synthesis at high temperatures (up to 50°C in some cases), which is an advantage when the template RNA is rucked into secondary structures.
- **Thermostable Tth DNA polymerase,** which is encoded by the thermophilic eubacterium *Thermus thermophilus* and exhibits reverse transcriptase activity in the presence of  $Mn^{2+}$  (Myers and Gelfand 1991). The chief advantage of using *Tth* polymerase in RT-PCR is that both phases of the reaction (reverse transcription and amplification) are carried out in the same reaction tube (Myers et al. 1994). In our view, this increase in convenience is not sufficient to compensate for the disadvantages of *Tth* polymerase, which are that the average size of the cDNA synthesized by *Tth* is only ~1–2 kb, far less than can be achieved with Mo-MLV reverse transcriptase (~10 kb); in addition, the use of  $Mn^{2+}$  is a worry because of the lowered fidelity of DNA synthesis in the presence of this cation. Finally, *Tth* cannot be used with oligo(dT) or random hexamers as primers, since the hybrids will be unstable at temperatures at which the thermostable DNA polymerase is active.

from a cloned, mutated segment of the target DNA. The perfect standard would differ in sequence from the target RNA by only one or two bases required to create one or more novel restriction site(s) in the amplified cDNA products. Both the target RNA and the standard should be able to be amplified with the same pair of primers (Becker-André and Hahlbrock 1989; Wang et al. 1989; Gilliland et al. 1990; Siebert and Larrick 1992). After amplification, the two PCR products are distinguished by digestion with restriction enzyme(s) and agarose gel electrophoresis (for review, please see Becker-André 1993).

Generating a perfect standard requires detailed planning and considerable labor. Most investigators therefore settle for internal standards that fall short of perfection, for example, a cloned segment of cDNA that can be added in varying quantities to the RNA template, or, less desirably, a completely unrelated, endogenous RNA species that can be amplified only with separate primers. Such imperfect controls may be malodorous to purists, but they are certainly preferable to no controls at all. At least they provide a means to measure the overall efficiency of reverse transcription and amplification and provide some indication of the quality of the RNA preparation.

## MATERIALS

▲ **IMPORTANT** To reduce the chance of contamination with exogenous DNAs, prepare and use a special set of reagents and solutions for PCR only. Bake all glassware for 6 hours at 150°C and autoclave all plasticware. For more information, please see the panel on **CONTAMINATION IN PCR** in the chapter introduction.

**CAUTION:** Please see Appendix 12 for appropriate handling of materials marked with <!>.

### Buffers and Solutions

Please see Appendix 1 for components of stock solutions, buffers, and reagents. Dilute stock solutions to the appropriate concentrations.

10x Amplification buffer

Chloroform <!>

dNTP (20 mM) solution containing all four dNTPs (pH 8.0)

Ethanol

MgCl<sub>2</sub> (50 mM)

Phenol:chloroform (1:1, v/v) <!>

Placental RNase inhibitor (20 units/μl)

Please see the information panel on **INHIBITORS OF RNASES** in Chapter 7.

### Enzymes and Buffers

*Reverse transcriptase (RNA-dependent DNA polymerase)*

Please see the panel on **REVERSE TRANSCRIPTASES USED IN RT-PCR** in the introduction to this protocol.

*Thermostable DNA-dependent DNA polymerase*

*Taq* DNA polymerase is the standard and appropriate enzyme for the amplification stage of most forms of RT-PCR. However, where elongation from 3'-mismatched primers is suspected, a thermostable DNA polymerase with 3'→5' proofreading activity may be preferred (Chiang et al. 1993).

### Gels

Agarose or polyacrylamide gel <!>

Please see Step 8.

## Nucleic Acids and Oligonucleotides

### Exogenous reference RNA

Please see Step 2.

### Oligonucleotide primers for synthesis of cDNA:

Oligo(dT)<sub>12-18</sub> (100 µg/ml) in TE (pH 8.0)

Random hexanucleotides (1 mg/ml) in TE (pH 8.0)

Gene-specific oligonucleotide (20 µM) in H<sub>2</sub>O (20 pmoles/µl)

The gene-specific oligonucleotide should be complementary to a known sequence in the target mRNA.

Depending on the experiment, oligo(dT)<sub>12-18</sub>, random hexanucleotides, or gene-specific antisense oligonucleotides can be used as primers for synthesis of first-strand cDNA (please see the introduction to this protocol).

### Sense and antisense oligonucleotide primers for amplification of cDNA by PCR

The primer used to generate cDNA may also be used as the antisense primer in the amplification stage of standard RT-PCR. However, the specificity of amplification can be improved by using an antisense primer that binds to an upstream sequence in the target transcript. Both sense and antisense primers are gene-specific synthetic oligonucleotides, which should be 20–30 nucleotides in length and contain approximately equal numbers of the four bases, with a balanced distribution of G and C residues, and a low propensity to form stable secondary structures. Wherever possible, use specific oligonucleotides that bind to sequences located in different exons of the target RNA as sense and antisense primers for amplification of the cDNA product. In this way, amplification products derived from cDNA and contaminating genomic DNA can be easily distinguished. For further details, please see Design of Oligonucleotide Primers for Basic PCR in the introduction to this chapter.

Bases encoding restriction sites can be added to the 5' termini of the sense and antisense primers used in PCR (please see Protocol 6). This addition greatly facilitates cloning of the amplified product.

Oligonucleotide primers synthesized on an automated DNA synthesizer can generally be used in standard RT-PCR without further purification. However, amplification of low-abundance mRNAs is often more efficient if the oligonucleotide primers are purified by chromatography on commercially available resins (e.g., NENSORB, NEN Life Science Products) or by denaturing polyacrylamide gel electrophoresis, as described in Chapter 10, Protocol 1.

Use the following formula to calculate the molecular weight of the oligonucleotides:

$$M_r = (C \times 289) + (A \times 313) + (T \times 304) + (G \times 329)$$

where C = number of C residues in the oligonucleotide

A = number of A residues

T = number of T residues

G = number of G residues

The gram molecular weight of a 20-mer will be ~6000; 100 pmoles of the oligonucleotide will be equivalent to ~0.6 µg.

### Total RNA (100 µg/ml) in H<sub>2</sub>O or Poly(A)<sup>+</sup> RNA (10 µg/ml) in H<sub>2</sub>O

Total RNA extracted from cells with chaotropic agents is generally the template of choice for RT-PCR for mRNAs that are expressed at moderate to high abundance (Liedtke et al. 1994). Poly(A)<sup>+</sup> is preferred as a template for all forms of RT-PCR when the target mRNA is expressed at low abundance. RNA suitable for use as a template in RT-PCR may be prepared from small numbers of cultured cells as follows:

- i. Pellet the cells (10–100 cells) by centrifugation for 5 seconds at 4°C in a microfuge.
- ii. Remove the supernatant by aspiration. Add 10–20 µl of an ice-cold lysis solution of 0.5% Nonidet P-40 (NP-40), 10 mM Tris-Cl (pH 8.0), 10 mM NaCl, 3 mM MgCl<sub>2</sub>. Vortex the tube very gently to disperse the cells throughout the lysis solution.
- iii. Store the tube for 5 minutes on ice, and then centrifuge at maximum speed for 2 minutes at 4°C in a microfuge. Use the supernatant directly as the template in a cDNA-driven PCR as described below.

Note that it may be necessary to carry out preliminary experiments to determine the optimum concentration of NP-40 in the lysis buffer. The concentration of 0.5% recommended in the protocol works well for lymphocytes. Higher concentrations may be required for other types of mammalian cells.



## Special Equipment

Barrier tips for automatic micropipettes

Microfuge tubes (0.5 ml, thin-walled for amplification) or Microtiter plates

Positive-displacement pipette

Thermal cycler programmed with desired amplification protocol

If the thermal cycler is not equipped with a heated lid, use either mineral oil or paraffin wax to prevent evaporation of liquid from the reaction mixture during PCR.

Water baths preset to 75°C and 95°C

## Additional Reagents

Step 8 of this protocol requires the reagents listed in Chapter 5, Protocol 2, Chapter 12, Protocol 6, or Chapter 6, Protocol 10.

Step 10 of this protocol requires the reagents listed in Protocols 3 and 4, 5, or 6 of this chapter.

## METHOD

1. Transfer 1 pg to 100 ng of poly(A)<sup>+</sup> mRNA or 10 pg to 1 µg of total RNA to a fresh microfuge tube. Adjust the volume to 10 µl with H<sub>2</sub>O. Denature the RNA by heating at 75°C for 5 minutes, followed by rapid chilling on ice.

2. To the denatured RNA add:

10x amplification buffer	2 µl
20 mM solution of four dNTPs (pH 8.0)	1 µl
primers (optimized, please see below)	1 µl
~20 units/µl placental RNase inhibitor	1 µl
50 mM MgCl <sub>2</sub>	1 µl
100–200 units/µl reverse transcriptase	1 µl
H <sub>2</sub> O	to 20 µl

Incubate the reaction for 60 minutes at 37°C.

MgCl<sub>2</sub> is added to meet the needs of the reverse transcriptase.

The optimum ratio of primer to template should be ascertained empirically for each preparation of RNA. As a starting point for optimization, we recommend adding varying amounts of primers to 20-µl reactions:

synthetic oligonucleotide complementary to the target RNA:	5–20 pmoles
oligo(dT) <sub>12–18</sub> :	0.1–0.5 µg
random hexanucleotides:	1–5 µg

cDNA synthesis can be measured by determining the proportion of radioactivity incorporated in reactions that have been supplemented with 10–20 µCi of [<sup>32</sup>P]dCTP (sp. act. 3000 Ci/mmol). The size of the first-strand cDNA molecules can be estimated by electrophoresis through alkaline agarose gels (please see Chapter 5, Protocol 8).

Set up three negative control reactions. In one reaction, include all of the components of the first-strand reaction, except the RNA template. In another reaction, include all of the components, except the reverse transcriptase. Omit primers from the third reaction. Carry the controls through all subsequent steps of the protocol. These controls provide reassurance that the cDNA product is not due to contamination or self-priming by RNA.

Whenever possible, set up positive controls containing varying amounts of an exogenous reference RNA equipped with a set of primer annealing sites identical to those used in the authentic target

RNA (Wang et al. 1989). With some foresight, it is often possible to generate an appropriate reference by cloning synthetic copies of the sense and antisense primer-binding sites on either side of an exogenous DNA sequence. The recombinant clone may then be transcribed in vitro into an RNA template that can serve as a positive control in RT-PCR.

3. Inactivate the reverse transcriptase and denature the template-cDNA complexes by heating the reaction to 95°C for 5 minutes.

The reverse transcriptase must be inactivated to ensure efficient synthesis during the amplification phase of RT-PCR (Sellner et al. 1992; Chumakov 1994). Sometimes, inactivation of reverse transcriptase by heat is not sufficient. It is then necessary to purify the first-strand cDNA by extraction with phenol:chloroform and precipitation with ethanol before setting up the PCRs. Presumably, contaminants in the reverse transcriptase enzyme lead to a decreased efficiency of the amplification reactions.

4. Adjust the reaction mixture so that it contains 20 pmoles of the sense and antisense primers.

The 20 pmoles of antisense oligonucleotide primer in the amplification reaction includes any gene-specific oligonucleotide used to prime the synthesis of the first-strand cDNA. The presence of excess oligonucleotide primers can lead to amplification of undesirable (nontarget) sequences, whereas a dearth of primers reduces the efficiency of amplification. It may be necessary to remove excess oligonucleotide and random hexamer primers from the cDNA preparation and then to optimize the concentrations of the sense and antisense primers in the amplification reaction (please see Step 3 of Protocol 9).

5. Add to the reaction mixture:

1x amplification buffer (or volume required to bring reaction mixture to 99 $\mu$ l)	77 $\mu$ l
1–2 units thermostable DNA polymerase	1 $\mu$ l

6. If the thermal cycler is not fitted with a heated lid, overlay the reaction mixtures with 1 drop (~50  $\mu$ l) of light mineral oil. Alternatively, place a bead of paraffin wax into the tube if using a hot start protocol. Place the tubes or the microtiter plate in the thermal cycler.
7. Amplify the nucleic acids using the denaturation, annealing, and polymerization times and temperatures listed in the table.

Cycle Number	Denaturation	Annealing	Polymerization
35 cycles	45 sec at 94°C	45 sec at 55°C	1 min 15 sec at 72°C
Last cycle	1 min at 94°C	45 sec at 55°C	1 min 15 sec at 72°C

These times are suitable for 100- $\mu$ l reactions assembled in thin-walled 0.5-ml tubes and incubated in thermal cyclers such as the Perkin-Elmer 9600 or 9700, Master Cycler (Eppendorf), and PTC 100 (MJ Research). Times and temperatures may need to be adapted to suit other types of equipment and reaction volumes.

Polymerization should be carried out for 1 minute for every 1000 bp of length of the target DNA.

Most thermal cyclers have an end routine in which the amplified samples are incubated at 4°C until they are removed from the machine. Samples can be left overnight at this temperature, but should be stored thereafter at -20°C.

8. Withdraw a sample (5–10  $\mu$ l) from the test reaction mixture and the four control reactions and analyze them by electrophoresis through an agarose or polyacrylamide gel. Be sure to include DNA markers of an appropriate size. Stain the gel with ethidium bromide or SYBR Gold to visualize the DNA.

A successful amplification reaction should yield a readily visible DNA fragment of the expected size. The identity of the band can be confirmed by DNA sequencing (please see Chapter 12, Protocol 6), Southern hybridization (please see Chapter 6, Protocol 10), and/or restriction mapping.

If no product is visible after 30 cycles of amplification, add fresh *Taq* polymerase and continue the amplification reaction for a further 15–20 cycles.

9. If mineral oil was used to overlay the reaction (in Step 6), remove the oil from the sample before cloning by extraction with 150  $\mu$ l of chloroform.

The aqueous phase, which contains the amplified DNA, will form a micelle near the meniscus. The micelle can then be transferred to a fresh tube with an automatic micropipette.

**▲ IMPORTANT** Do not attempt chloroform extractions in microtiter plates. The plastic used in these plates is not resistant to organic solvents.

10. Clone the amplified products into an appropriately prepared vector by any of the methods described in Protocol 4, 5, or 6. Before cloning, separate the amplified DNA from the residual thermostable DNA polymerase and dNTPs (please see Protocol 3). The DNA can then be ligated to a blunt-ended vector or a T vector, or it can be digested with restriction enzymes and ligated to a vector with compatible termini.

Poor yields of product in RT-PCR may be due to inefficient cDNA synthesis or, more frequently, to ineffective amplification of cDNA. Investigate the latter possibility by setting up a series of reactions in which variable amounts of cDNA template are added to the PCR. Suboptimal amounts of cDNA template may generate a number of discrete amplification products, which may be larger or smaller than the authentic target sequence. A more common problem is a nonspecific smear of amplified products, as visualized on a stained gel. This outcome is caused by spurious priming, which occurs when excess cDNA template is present in the PCR. For this reason, many experimenters use  $\leq 10\%$  of the cDNA generated in the reverse transcriptase reaction as template in the subsequent PCR. In this case, additional dNTPs must be added to the PCR.

Once the best concentration of template has been established, the other parameters of PCR can be optimized in a systematic fashion by varying the concentration of  $Mg^{2+}$ , altering annealing conditions, and so on. If problems still persist:

- Check the integrity of the RNA preparation by electrophoresis through an agarose gel containing formaldehyde.
- Set up test reactions containing a control mRNA, an oligo(dT) primer, and a radiolabeled tracer to measure the efficiency of cDNA synthesis. The total amounts of first-strand cDNA synthesis can be measured by determining the proportion of radioactivity incorporated in reactions that have been supplemented with 10–20  $\mu$ Ci of [ $^{32}$ P]dCTP (sp. act. 3000 Ci/mmol). The size of the first-strand cDNA molecules can be estimated by electrophoresis through alkaline agarose gels (see Chapter 5, Protocol 8).
- Test for the presence of inhibitors in the preparation of RNA by mixing varying amounts of the preparation with a control and comparing the yields of cDNA.
- Purify the cDNA as described in the footnote to Step 3 before proceeding to PCR.

# Protocol 9

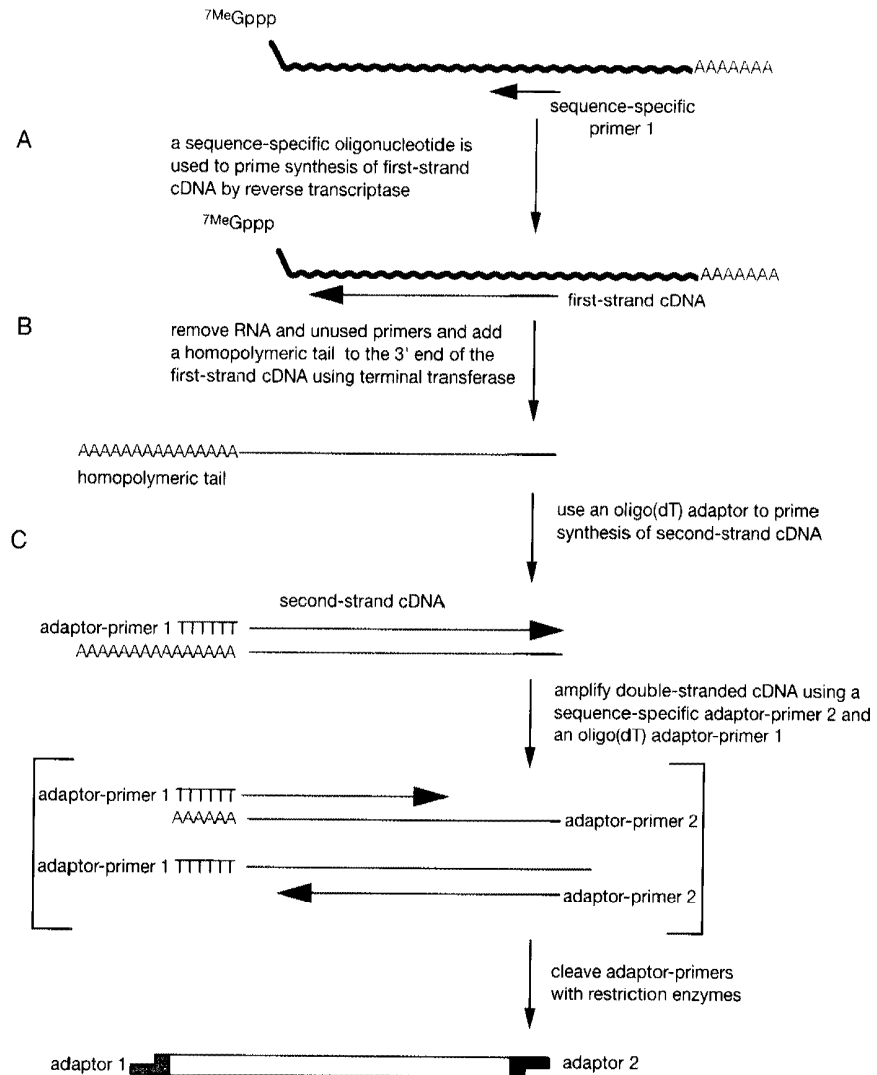
---

## Rapid Amplification of 5' cDNA Ends

**N**OTHING IN MOLECULAR CLONING IS MORE FRUSTRATING than to isolate a cDNA clone that lacks sequences representative of the 5' end of the corresponding mRNA. Partial clones of this type, which occur commonly in cDNA libraries, arise when reverse transcriptase fails to extend first-strand cDNA along the full length of the mRNA template. The longer the starting mRNA and the higher its content of secondary structure, the greater the risk of isolating an incomplete cDNA clone. Before the advent of PCR, the investigator's best hope of rectifying the situation was to re-screen the cDNA library in greater depth in the hope of fastening onto a full-length clone. In many instances, however, the consequence was further frustration and redoubled disappointment. The only course then open was to generate and screen additional cDNA libraries. In the late 1980s, however, a better solution was found when methods were devised to capture missing segments of cDNA and to amplify them by PCR. Frohman et al. (1988) described a general procedure for the rapid amplification of cDNA ends (RACE); Loh et al. (1989) designed anchored PCR to clone the variable 5' regions of mRNAs encoding T-cell receptors; and Ohara et al. (1989) used essentially the same technique (One-sided PCR) to clone full-length cDNAs corresponding to mRNAs encoding skeletal muscle  $\alpha$ -tropomyosins of the European common frog and zebrafish (*Brachydanio rerio*).

These techniques differ from conventional PCR in that they require knowledge of only a small region of sequence within either the target RNA or a partial clone of cDNA (please see Figure 8-5). During PCR, the thermostable DNA polymerase is directed to the appropriate target RNA by a single primer derived from the region of known sequence; the second primer required for PCR is complementary to a general feature of the target — in the case of 5'-RACE, to a homopolymeric tail added (via terminal transferase) to the 3' termini of cDNAs transcribed from a preparation of mRNA. In effect, this synthetic tail provides a primer-binding site upstream of the unknown 5' sequence of the target mRNA. The products of the amplification reaction are cloned into a plasmid vector for sequencing and subsequent manipulation.

5'-RACE is not as easy as its sounds. The technique involves three sequential enzymatic steps (reverse transcription, addition of homopolymeric tails, and PCR), none of which is fool-proof. The specificity of amplification depends entirely on the anchoring primer and is generally low. The population of amplified DNAs is therefore enriched for 5' sequences of the target mRNA but is by no means pure. In addition, the amplified DNAs are of such variable length that they usually appear as a smear on an agarose gel. Finally, the fraction of amplified DNAs that extends to the 5' terminus of the target RNA is small, perhaps because reverse transcriptase has difficulty in transcribing RNA templates that have a high degree of secondary structure in their 5' regions.



**FIGURE 8-5 Determination of the 5' End of mRNA Using 5'-RACE**

(A) A sequence-specific primer 1 complementary to a region of known sequence is annealed to the RNA. First-strand synthesis is achieved using reverse transcriptase and dNTP. The DNA extends to the 5' end of the mRNA. (B) The primers are removed from the reaction products by spin dialysis, and a homopolymeric tail is added to the 3' end of the DNA using terminal transferase. Typically, dATP is used to generate a poly(dA) tail; however, some investigators prefer to use dCTP to make a poly(dC) tail, particularly if terminal As are already present from reverse transcription of the RNA. (C) The (dT)<sub>17</sub> adaptor-primer 1 is used to prime the synthesis of the second strand. Amplification is continued to generate enough product for cloning into a plasmid vector and for subsequent sequencing.

Truncated cDNAs generated during 5'-RACE have the same termini as full-length molecules (i.e., a primer at their 3' end and a homopolymeric tail at their 5' end). Both full-length and truncated molecules are therefore amplified in the PCR phase of 5'-RACE. Many refinements of the original techniques have been introduced to alleviate these and other problems (for reviews, please see Frohman 1995; Schaefer 1995; Chen 1996). The following protocol is based on a modification by W.J. Chen (Glaxo-Wellcome) of the original method of Frohman et al. (1988). Further elaborations and modifications drawn from a variety of other sources are described at the end of the protocol.

## MATERIALS

▲ **IMPORTANT** To reduce the chance of contamination with exogenous DNAs, prepare and use a special set of reagents and solutions for PCR only. Bake all glassware for 6 hours at 150°C and autoclave all plasticware. For more information, please see the panel on **CONTAMINATION IN PCR** in the chapter introduction.

**CAUTION:** Please see Appendix 12 for appropriate handling of materials marked with <!>.

### Buffers and Solutions

Please see Appendix 1 for components of stock solutions, buffers, and reagents. Dilute stock solutions to the appropriate concentrations.

10x Amplification buffer

Chloroform <!>

dATP (1 mM) (disodium salt)

dNTP (20 mM) solution containing all four dNTPs (pH 8.0)

Placental RNase inhibitor (20 units/μl)

Please see the information panel on **INHIBITORS OF RNASES** in Chapter 7.

TE (pH 7.6)

### Enzymes and Buffers

5x Reverse transcriptase buffer

Reverse transcriptase (RNA-dependent DNA polymerase)

Please see the panel on **REVERSE TRANSCRIPTASES USED IN RT-PCR** in Protocol 8.

Terminal deoxynucleotidyl transferase (terminal transferase)

Please see the information panel on **TERMINAL TRANSFERASE**.

5x Terminal transferase buffer

Thermostable DNA polymerase

*Taq* DNA polymerase is the standard and appropriate enzyme for the amplification stage of most forms of RT-PCR. However, where elongation from 3'-mismatched primers is suspected, a thermostable DNA polymerase with 3'→5' proofreading activity may be preferred (Chiang et al. 1993).

### Gels

Agarose or polyacrylamide gel <!>

Please see Step 9.

### Nucleic Acids and Oligonucleotides

Adaptor-primer (10 μM) (5' GACTCGAGTCGACATCG 3') in H<sub>2</sub>O (10 pmoles/μl)

The adaptor-primer is used in conjunction with a gene-specific sense primer to amplify a particular target cDNA. After amplification, the desired product can comprise as little as 1% and as much as 100% of the total yield of DNA. If necessary, the yield of desired product can be improved by setting up a second round of amplification using the adaptor-primer and a nested gene-specific antisense primer that binds to a sequence within the amplified segment of target DNA. After this second round of nested amplification, almost all of the product detected by ethidium bromide staining contains sequences corresponding to the 5' region of the desired mRNA.

Oligonucleotide primers synthesized on an automated DNA synthesizer can generally be used in standard RT-PCR without further purification. However, amplification of low-abundance mRNAs is often more efficient if the oligonucleotide primers are purified by chromatography on commercially available resins (e.g., NENSORB, NEN Life Science Products) or by denaturing polyacrylamide gel electrophoresis, as described in Chapter 10, Protocol 1.

(dT)<sub>17</sub>-Adaptor-primer (10 μM) (5' GACTCGAGTCGACATCGA(T)<sub>17</sub> 3') in H<sub>2</sub>O (10 pmoles/μl)

The (dT)<sub>17</sub>-adaptor-primer binds to the poly(A)<sup>+</sup> tract added to the 5' terminus of cDNAs by terminal transferase. In the example given in this protocol, one of the termini of the amplified DNAs becomes equipped with recognition sites for *Xho*I, *Sal*I, *Acl*I, *Hin*II, and *Cla*I restriction enzymes.

*Gene-specific antisense oligonucleotide primers (10  $\mu$ M) in H<sub>2</sub>O (10 pmoles/ $\mu$ l)*

The gene-specific antisense primers should be complementary to the known sequence of the target mRNA, should be 20–30 nucleotides in length, and should contain approximately equal numbers of the four bases, with a balanced distribution of G and C residues and a low propensity to form stable secondary structures. For further details, please see Design of Oligonucleotide Primers for Basic PCR in the introduction to this chapter. Gene-specific primer 1 is used in the reverse transcriptase reaction (Step 2) to prime synthesis of gene-specific first-strand cDNA. Gene-specific primer 2 is complementary to a sequence in the target mRNA that is 5' to primer 1 and is used in the amplification stage of the reaction. As discussed below, restriction sites are always designed into adaptor-primers. However, they can also be incorporated into the gene-specific oligonucleotides. The presence of restriction sites simplifies cloning of the amplified cDNAs.

*Random hexanucleotides (1 mg/ml) in TE (pH 8.0) (optional)*

In an emergency, random hexanucleotides can be used in place of the gene-specific antisense oligonucleotide to prime synthesis of cDNA (Harvey and Darlison 1991). Subsequent use of a gene-specific sense primer in the PCR phase of the 5'-RACE reaction generates the desired product (Harvey and Darlison 1991; Apte and Siebert 1993). Random oligonucleotides are clearly not the first choice for 5'-RACE since they do not have the ability to discriminate between the target and any other sequence in the starting population of mRNAs. They may provide a way to leap the hurdle of cDNA synthesis in the absence of a gene-specific antisense oligonucleotide, but they also delay the introduction into the 5'-RACE protocol of a crucial selective step. Because only a small fraction of the cDNAs generated by random priming will also contain a binding site for the gene-specific sense primer, the yields of amplified product are typically very low when random hexanucleotides are used to prime cDNA synthesis in RACE.

*Total RNA (100  $\mu$ g/ml) in H<sub>2</sub>O or Poly(A)<sup>+</sup> RNA (10  $\mu$ g/ml) in H<sub>2</sub>O*

Total RNA extracted from cells with chaotropic agents is generally the template of choice for RT-PCR for mRNAs that are expressed at moderate to high abundance (Liedtke et al. 1994). Poly(A)<sup>+</sup> is preferred as a template for all forms of RT-PCR when the target mRNA is expressed at low abundance. RNA suitable for use as a template in RT-PCR may be prepared from small numbers of cultured cells according to the directions in Protocol 8.

**Centrifuges and Rotors***Preparative centrifuge*

Centricon-100 devices will fit in any fixed-angle rotor with adaptors capable of supporting 17 × 150-mm tubes. The centrifuge must be capable of generating a steady force of 1000g.

*Sorvall SS-34 rotor***Special Equipment***Barrier tips for automatic micropipettes**Concentrators (Centricon-100, Amicon)**Microfuge tubes (0.5 ml, thin-walled for amplification) or Microtiter plates**Positive-displacement pipette**Thermal cycler programmed with desired amplification protocol*

If the thermal cycler is not equipped with a heated lid, use either mineral oil or paraffin wax to prevent evaporation of liquid from the reaction mixture during PCR.

*Rotary vacuum evaporator (Optional)*

For example, the Speed-vac from Savant Inc. (Hicksville, New York). Please see Step 3.

*Water baths preset to 75°C and 80°C***Additional Reagents**

Step 9 of this protocol requires the reagents listed in Chapter 5, Protocol 2, Chapter 12, Protocol 6, or Chapter 6, Protocol 10.

Step 11 of this protocol requires the reagents listed in Protocols 3 and 4, 5, or 6 of this chapter.

**METHOD****Reverse Transcription**

The success or failure of 5'-RACE is determined here, at the beginning of the experiment. If the reverse transcription step works efficiently, the chance of isolating clones that contain the 5'-termi-

nal sequences of the target mRNA is high. On the other hand, no amount of work on the later steps of the protocol can compensate for ineffective reverse transcription. It is therefore worthwhile to take the time to optimize the reverse transcriptase reaction by determining the optimum ratio of primer to template for each preparation of RNA and by varying the concentration of  $Mg^{2+}$  in the reaction.

1. Transfer 1 pg to 100 ng of poly(A)<sup>+</sup> mRNA or 10 pg to 1 µg of total RNA to a fresh microfuge tube. Adjust the volume to 9 µl with H<sub>2</sub>O. Denature the RNA by heating for 5 minutes at 75°C, followed by rapid chilling on ice.

2. To the denatured RNA add:

5x reverse transcriptase buffer	4 µl
20 mM solution of four dNTPs (pH 8.0)	1 µl
10 µM gene-specific antisense primer 1	4 µl
~20 units/µl placental RNase inhibitor	1 µl
100–200 units/µl reverse transcriptase	1 µl
H <sub>2</sub> O	to 20 µl

Incubate the reaction for 60 minutes at 37°C. Set up three negative control reactions. In one reaction, include all of the components of the first-strand reaction, except the RNA template. In another reaction, include all of the components, except the reverse transcriptase. Omit primer from the third reaction. Carry the controls through all subsequent steps of the protocol. These controls provide reassurance that the cDNA product synthesized in the main reaction is not due to contamination with genomic DNA or oligonucleotide fragments, or self-priming by template molecules.

*Total* cDNA synthesis can be estimated from the proportion of trichloroacetic acid (TCA)-precipitable radioactivity incorporated in reverse transcription reactions supplemented with 10–20 µCi of [<sup>32</sup>P]dCTP (sp. act. 3000 Ci/mmol; please see Appendix 8). Be sure to set up a control reaction that contains no oligonucleotide primer. Radioactivity incorporated in the absence of primer results from self-priming of RNA molecules. The length of the population of first-strand cDNA molecules can be estimated by electrophoresis of the radiolabeled products through an alkaline agarose gel (Chapter 5, Protocol 8), followed by autoradiography.

To monitor the efficiency of *gene-specific* DNA synthesis, set up a primer-extension reaction containing the gene-specific antisense oligonucleotide radiolabeled at its 5' end by bacteriophage T4 polynucleotide kinase and [<sup>32</sup>P]ATP (please see Chapter 7, Protocol 12). The products of the reverse transcriptase reaction, which in general will be heterogeneous in length, should be analyzed by electrophoresis through an alkaline agarose gel (Chapter 5, Protocol 8), followed by autoradiography. Extended exposure times (>24 hours) will most likely be required to detect the primer-extension product(s) complementary to low-abundance mRNAs.

### Purification of the Reverse Transcriptase Products

Unused dNTPs and primers must be removed at the completion of the reverse transcriptase reaction. Otherwise, there is a chance that dNTPs will be incorporated into the tail added to the 3' end of the cDNA by terminal transferase. This would be a total disaster as the presence of unwanted bases would compromise the ability of the tail to serve as a primer-binding site. The presence of unused primers would also be a problem because their 3' termini would compete with cDNA in the tailing reaction.

3. Remove excess oligonucleotide or random hexanucleotide primer by diluting the reverse transcriptase reaction to a final volume of 2 ml with H<sub>2</sub>O and then applying the solution to a Centricon-100 microconcentrator (Frohman 1993; for a description of this procedure, please see Protocol 3). Centrifuge the solution at 500–1100g (2000–3000 rpm in a Sorvall SS-34 rotor) for 20 minutes at a temperature between 4°C and 25°C. Repeat the dilution step and centrifuge again. Transfer the retentate to a fresh 0.5-ml microfuge tube and reduce the volume to ~10 µl in a rotary vacuum evaporator.



Alternatively, remove the dNTPs and unused primers by precipitating the cDNA twice in 2.5 M ammonium acetate and 3 volumes of ethanol. Two sequential precipitations of DNA in the presence of 2.5 M ammonium acetate result in the removal of >99% of dNTPs and oligonucleotides from preparations of DNA (Okayama and Berg 1983).

4. To the cDNA in a volume of 10 µl add:

5x terminal transferase buffer	4 µl
1 mM dATP	4 µl
terminal transferase	10–25 units

Incubate the reaction for 15 minutes at 37°C.

The tailing reaction can be optimized by setting up mock reactions containing ~50 ng of a control DNA fragment, 100–200 nucleotides in length. After tailing, the size of the fragment should increase by 20–100 nucleotides as measured by electrophoresis through a 1% neutral agarose gel. More accurate estimates of the average number of bases added to 3' termini can be obtained by setting up a control reaction containing ~10 ng of a synthetic oligonucleotide ~30 bases in length and labeled at its 5' terminus with <sup>32</sup>P (please see Chapter 10, Protocol 2). The products of the tailing reaction are separated by electrophoresis through a 10% polyacrylamide sequencing gel and analyzed by autoradiography. The tailed products form a ladder of bands differing in length by a single nucleotide. Ideally, the homopolymeric tails should, on average, be ~20 nucleotides in length and should be attached to the vast majority of the cDNA substrates.

5. Inactivate the terminal transferase by heating the reaction for 3 minutes at 80°C. Dilute the dA-tailed cDNA to a final volume of 1 ml with TE (pH 7.6).

## Amplification

6. In a sterile 0.5-ml microfuge tube, amplification tube, or the well of a sterile microtiter plate, set up a series of PCRs containing the following:

diluted cDNA	0–20 µl
10x amplification buffer	5 µl
20 mM solution of four dNTPs	5 µl
10 µM (dT) <sub>17</sub> -adaptor-primer (16 pmoles)	1.6 µl
10 µM adaptor-primer (32 pmoles)	3.2 µl
10 µM gene-specific primer 2 (32 pmoles)	3.2 µl
1–2 units of thermostable DNA polymerase	1 µl
H <sub>2</sub> O	to 50 µl

It is essential to set up a series of amplification reactions to find the amount of tailed cDNA that generates the largest quantity of amplified 5' termini. The control reaction containing no cDNA template serves as a control for contamination.

7. If the thermal cycler is not fitted with a heated lid, overlay the reaction mixtures with 1 drop (~50 µl) of light mineral oil. Alternatively, place a bead of paraffin wax into the tube if using a hot start protocol. Place the tubes or the microtiter plate in the thermal cycler.
8. Amplify the nucleic acids using the denaturation, annealing, and polymerization times and temperatures listed in the table.

Cycle Number	Denaturation	Annealing	Polymerization
First cycle	5 min at 94°C	5 min at 50–58°C	40 min at 72°C
Subsequent cycles (30)	40 sec at 94°C	1 min at 50–58°C	3 min at 72°C
Last cycle	40 sec at 94°C	1 min at 50–58°C	15 min at 72°C

These times are suitable for 50-µl reactions assembled in thin-walled 0.5-ml tubes and incubated in thermal cyclers such as the Perkin-Elmer 9600 or 9700, Master Cycler (Eppendorf), and PTC 100 (MJ Research). Times and temperatures may need to be adapted to suit other types of equipment and reaction volumes.

The polymerization reaction in the first cycle is carried out for an extended period of time (40 minutes) to ensure the synthesis of long cDNAs by the thermostable DNA polymerase.

The optimum temperature for annealing of the oligonucleotide primers should be determined empirically. Start at 50°C and gradually work up to the highest temperature that generates the maximum yield of specific product.

9. Withdraw a sample (5–10  $\mu$ l) from the test reaction mixture and the four control reactions and analyze them by electrophoresis through an agarose or polyacrylamide gel. Be sure to include DNA markers of an appropriate size. Stain the gel with ethidium bromide or SYBR Gold to visualize the DNA.

A successful amplification reaction should yield a readily visible DNA fragment of the expected size. The identity of the band can be confirmed by DNA sequencing (please see Chapter 12, Protocol 6), Southern hybridization (please see Chapter 6, Protocol 10), and/or restriction mapping.

If no product is visible after 30 cycles of amplification, add fresh *Taq* polymerase and continue the amplification reaction for a further 15–20 cycles.

If amplification of the tailed cDNA preparation results in a smear of DNA after gel electrophoresis, recover the longest products of the amplification reaction from a preparative agarose gel. An aliquot of this material can then be reamplified for a limited number (15–20) of additional cycles of PCR.

10. If mineral oil was used to overlay the reaction (in Step 7), remove the oil from the sample before cloning by extraction with 150  $\mu$ l of chloroform.

The aqueous phase, which contains the amplified DNA, will form a micelle near the meniscus. The micelle can be transferred to a fresh tube with an automatic micropipette.

▲ **IMPORTANT** Do not attempt chloroform extractions in microtiter plates. The plastic used in these plates is not resistant to organic solvents.

11. Separate the amplified DNA from the residual thermostable DNA polymerase and dNTPs (please see Protocol 3).

The DNA can now be ligated to a blunt-ended vector or a T vector, or it can be digested with restriction enzymes and ligated to a vector with compatible termini (please see Protocols 4, 5, and 6).

#### LOW YIELDS OF FULL-LENGTH CLONES

Many of the problems with low yields of full-length clones are due to the inefficiency of the reverse transcription step. If the RNA is degraded or if the 5' end of the target mRNA is rich in GC, reverse transcriptase may have difficulty in traversing the resulting stable secondary structures. The yield of clones can be enhanced by one of the following methods:

- **Carrying out the reverse transcriptase reaction at higher temperatures** (up to 55°C with murine reverse transcriptase), or use a thermostable reverse transcriptase (e.g., *Tth* polymerase, Retrotherm).
- **Fractionating the cDNA products on agarose or polyacrylamide gels** before homopolymeric tailing and amplification.
- **Incorporating modified bases, such as 7-deaza-dGTP**, that reduce secondary structure (McConlogue et al. 1988). Bear in mind that the incorporation of 7-deaza-dGTP into the first-strand cDNA product may increase the efficiency of the amplification step, but it may also block subsequent cleavage of the amplified DNA by some restriction enzymes, including *AluI*, *DdeI*, *HinfI*, *Sau3AI*, *AccI*, *BamHI*, *EcoRI*, *PstI*, *Sall*, and *SmaI*. However, DNAs modified with 7-deaza-GTP are cleaved efficiently by *MaeI*, *HindIII*, and *XbaI*.
- **Carrying out five cycles of linear amplification** on the d(A)-tailed cDNA with the gene-specific primer before adding the d(T) adaptor-primer (Rother 1992).
- **Purifying the tailed and amplified DNA by electrophoresis** through an agarose or polyacrylamide gel. The longest molecules are then recovered from the gel and subjected to a second round of amplification using the adaptor-primer and the gene-specific primer.

For further suggestions, please see the panel at the end of Protocol 8.

# Protocol 10

---

## Rapid Amplification of 3' cDNA Ends

**P**ARTIAL CDNA CLONES THAT LACK SEQUENCES CORRESPONDING to the 3' regions of the cognate mRNA occur infrequently in oligo(dT)-primed cDNA libraries. How and when these rarities arise during cDNA synthesis and cloning is not known for certain. Possibilities include random breakage of first-strand cDNA, failure of the DNA polymerase to reach the end of the template strand during synthesis of the second strand of cDNA, priming on internal adenylate tracts, or deletion of 3' sequences adjacent to poly(dA:dT) tracts during cloning. Partial cDNAs that lack 3' regions are common in random hexamer-primed cDNA libraries because these primers anneal at many positions in the mRNA.

3'-RACE reactions are used to isolate unknown 3' sequences and to map the 3' termini of mRNAs, for example, when investigators are faced with multiple mRNA species transcribed from a single gene, arising from differential polyadenylation.

3'-RACE like its more illustrious sibling, 5'-RACE, requires knowledge of a small region of sequence within either the target RNA or a partial clone of cDNA (Figure 8-6). A population of mRNAs is transcribed into cDNA with an adaptor-primer consisting at its 3' end of a poly(T) tract and at its 5' end of an arbitrary sequence of 30–40 nucleotides. Reverse transcription is usually followed by two successive PCRs. The first is primed by a gene-specific sense oligonucleotide and the antisense (dT)adaptor-primer. If necessary, the products of the first PCR can be used as templates for a second, nested PCR, which is primed by a gene-specific sense oligonucleotide internal to the first, and a second antisense oligonucleotide whose sequence is identical to the central region of the (dT)adaptor-primer. The products amplified in the second PCR are isolated from an agarose gel, cloned, and characterized.

The following protocol is based on a modification by W.J. Chen (Glaxo-Wellcome) of the methods first described by Frohman et al. (1988) and elaborated in later publications (e.g., please see Frohman 1995; Schaefer 1995; Bespalova et al. 1998)

### MATERIALS

---

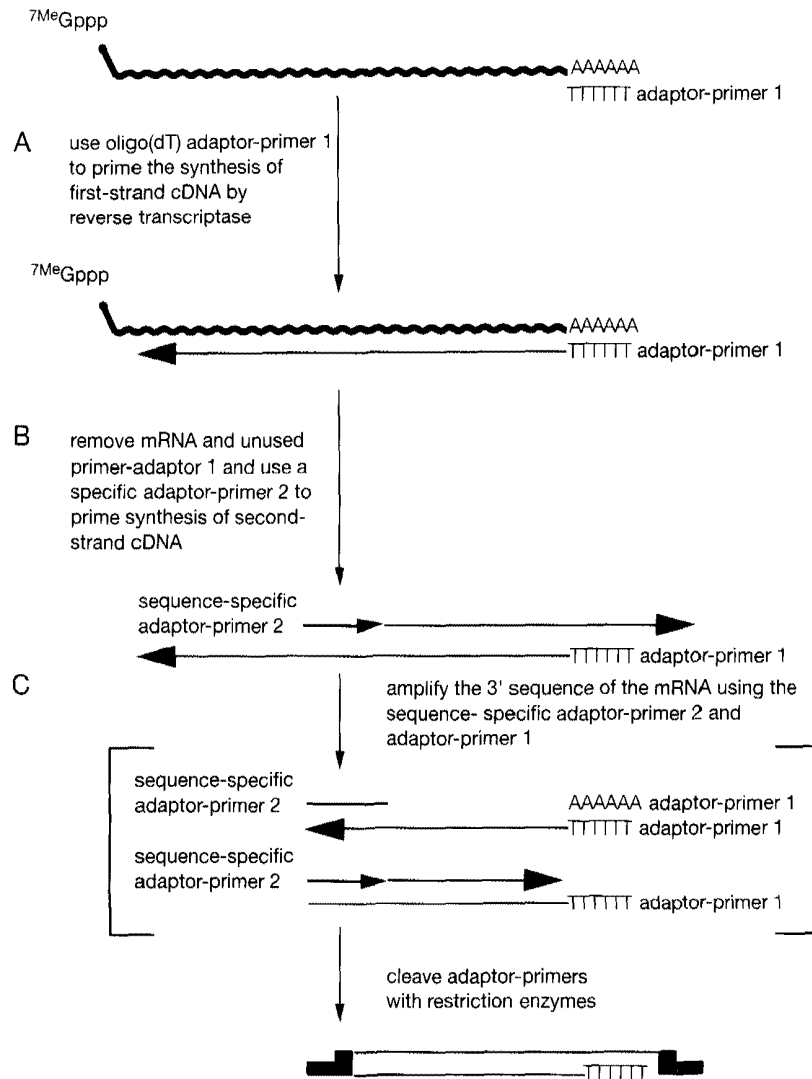
▲ **IMPORTANT** To reduce the chance of contamination with exogenous DNAs, prepare and use a special set of reagents and solutions for PCR only. Bake all glassware for 6 hours at 150°C and autoclave all plasticware. For more information, please see the panel on **CONTAMINATION IN PCR** in the chapter introduction.

**CAUTION:** Please see Appendix 12 for appropriate handling of materials marked with <!>.

### Buffers and Solutions

Please see Appendix 1 for components of stock solutions, buffers, and reagents. Dilute stock solutions to the appropriate concentrations.

10x Amplification buffer  
Chloroform <!>



**FIGURE 8-6 Determination of the 3' End of mRNA Using 3'-RACE**

The strategy known as 3'-RACE is used to isolate unknown 3' sequences and to map the 3' termini of mRNA. (A) The (dT)<sub>17</sub>-adaptor-primer (represented by the black arrow) is annealed to the population of mRNA. First-strand synthesis (primed by (dT)<sub>17</sub>) is achieved using reverse transcriptase and dNTPs. (B) Second-strand synthesis is primed by a sequence-specific primer. (C) Amplification is continued in the presence of the sequence specific primers and a primer complementary to the arbitrary adaptor sequence, to generate sufficient product for cloning into a plasmid vector and for subsequent sequencing.

*dNTP (20 mM) solution containing all four dNTPs (pH 8.0)*

*Placental RNase inhibitor (20 units/μl)*

Please see the information panel on **INHIBITORS OF RNASES** in Chapter 7.

*TE (pH 7.6)*

## Enzymes and Buffers

*Reverse transcriptase (RNA-dependent DNA polymerase)*

Please see the panel on **REVERSE TRANSCRIPTASES USED IN RT-PCR** in Protocol 8.

*5x Reverse transcriptase buffer*

*Thermostable DNA polymerase*

*Taq* DNA polymerase is the standard and appropriate enzyme for the amplification stage of most forms of RT-PCR. However, where elongation from 3'-mismatched primers is suspected, a thermostable DNA polymerase with 3'→5' proofreading activity may be preferred (Chiang et al. 1993).

**Gels**

*Agarose or polyacrylamide gel* <1>

Please see Step 6.

**Nucleic Acids and Oligonucleotides**

*Adaptor-primer (10 μM) (5' GACTCGAGTCGACATCG 3') in H<sub>2</sub>O (10 pmoles/μl)*

The adaptor-primer is used in conjunction with a gene-specific sense primer to amplify a particular target cDNA. After amplification, the desired product can comprise as little as 1% and as much as 100% of the total yield of DNA. If necessary, the yield of desired product can be improved by setting up a second round of amplification using the adaptor-primer and another gene-specific sense primer that binds to a sequence within the amplified segment of target DNA. After this second round of nested amplification, almost all of the product detected by ethidium bromide staining contains sequences corresponding to the 3' region of the desired mRNA.

Oligonucleotide primers synthesized on an automated DNA synthesizer can generally be used in standard RT-PCR without further purification. However, amplification of low-abundance mRNAs is often more efficient if the oligonucleotide primers are purified by chromatography on commercially available resins (e.g., NENSORB, NEN Life Science Products) or by denaturing polyacrylamide gel electrophoresis, as described in Chapter 10, Protocol 1.

*(dT)<sub>17</sub>-Adaptor-primer (10 μM) (5' GACTCGAGTCGACATCGA(T)<sub>17</sub> 3') in H<sub>2</sub>O (10 pmoles/μl)*

The oligo(dT) region of the (dT)<sub>17</sub>-adaptor antisense primer binds to the poly(A)<sup>+</sup> tract at the 3' end of mRNA, leaving the adaptor sequences unpaired. During amplification, the adaptor sequences are converted to double-stranded cDNA that, in the example given in this protocol, is equipped with recognition sites for *Xho*I, *Sal*I, *Acl*I, *Hinc*II, and *Cla*I restriction enzymes.

*Gene-specific sense oligonucleotide primer (10 μM) in H<sub>2</sub>O (10 pmoles/μl)*

The gene-specific sense primer should encode a known region of sequence of the target mRNA, should be 20–30 nucleotides in length and contain approximately equal numbers of the four bases, with a balanced distribution of G and C residues and a low propensity to form stable secondary structures. For further details, please see Design of Oligonucleotide Primers for Basic PCR in the introduction to this chapter. As discussed below, restriction sites are always designed into adaptor-primers. However, they can also be incorporated into the gene-specific oligonucleotides. This addition generates amplified cDNAs carrying restriction sites at both ends, which can facilitate cloning.

*Total RNA (100 μg/ml) in H<sub>2</sub>O or Poly(A)<sup>+</sup> RNA (10 μg/ml) in H<sub>2</sub>O*

Total RNA extracted from cells with chaotropic agents is generally the template of choice for RT-PCR (Liedtke et al. 1994) for mRNAs that are expressed at moderate to high abundance. Poly(A)<sup>+</sup> is preferred as a template for all forms of RT-PCR when the target mRNA is expressed at low abundance. RNA suitable for use as a template in RT-PCR may be prepared from small numbers of cultured cells according to the directions in Protocol 8.

**Special Equipment**

*Barrier tips for automatic micropipettes*

*Microfuge tubes (0.5 ml, thin-walled for amplification) or Microtiter plates*

*Positive-displacement pipette*

*Thermal cycler programmed with desired amplification protocol*

If the thermal cycler is not equipped with a heated lid, use either mineral oil or paraffin wax to prevent evaporation of liquid from the reaction mixture during PCR.

*Water baths preset to 75°C*

**Additional Reagents**

*Step 6 of this protocol requires the reagents listed in Chapter 5, Protocol 2, Chapter 12, Protocol 6, or Chapter 6, Protocol 10.*

*Step 8 of this protocol requires the reagents listed in Protocols 3 and 4, 5, or 6 of this chapter.*

## METHOD

### Reverse Transcription

The success or failure of 3'-RACE is determined here, at the beginning of the experiment. If the reverse transcription step works efficiently, the chance of isolating clones that contain the 3'-terminal sequences of the target mRNA is high. On the other hand, no amount of work on the later steps of the protocol can compensate for ineffective reverse transcription. It is therefore worthwhile to take the time to optimize the reverse transcriptase reaction by determining the optimum ratio of primer to template for each preparation of RNA and by varying the concentration of  $Mg^{2+}$  in the reaction.

1. Transfer 1 pg to 100 ng of poly(A)<sup>+</sup> mRNA or 10 pg to 1 µg of total RNA to a fresh microfuge tube. Adjust the volume to 10 µl with H<sub>2</sub>O. Denature the RNA by heating at 75°C for 5 minutes, followed by rapid chilling on ice.

2. To the denatured RNA add:

5x reverse transcriptase buffer	10 µl
20 mM solution of four dNTPs	1.5 µl
10 µM (dT) <sub>17</sub> -adaptor-primer (80 pmoles)	8.0 µl
~20 units/µl placental RNase inhibitor	1 µl
100–200 units/µl reverse transcriptase	1 µl
H <sub>2</sub> O	to 50 µl

Incubate the reaction for 60 minutes at 37°C. Set up three negative control reactions. In one reaction, include all of the components of the first-strand reaction, except the RNA template. In another reaction, include all of the components, except the reverse transcriptase. Omit primer from the third reaction. Carry the controls through all subsequent steps of the protocol. These controls provide reassurance that the cDNA product synthesized in the main reaction is not due to contamination with genomic DNA, oligonucleotide fragments, or self-priming by template molecules.

Total cDNA synthesis can be estimated from the proportion of TCA-precipitable radioactivity incorporated in reverse transcriptase reactions supplemented with 10–20 µCi of [<sup>32</sup>P]dCTP (sp. act. 3000 Ci/mmmole; please see Appendix 8). Be sure to set up a control reaction that contains no (dT)<sub>17</sub> adaptor antisense primer. Radioactivity incorporated in the absence of primer results from self-priming of RNA molecules. The length of the population of first-strand cDNA molecules can be estimated by electrophoresis of the radiolabeled products through an alkaline agarose gel (Chapter 5, Protocol 8), followed by autoradiography.

3. Dilute the reverse transcriptase reaction (cDNA) to a final volume of 1 ml with TE (pH 7.6).

It may be necessary to remove excess oligonucleotide and random hexamer primers from the cDNA preparation and then to optimize the concentrations of the sense and antisense primers in the amplification reaction (please see Step 3 of Protocol 9).

### Amplification

4. In a sterile 0.5-ml microfuge tube, amplification tube, or the well of a sterile microtiter plate, set up a series of PCRs containing the following:

diluted cDNA	0–20 µl
10x amplification buffer	5 µl
20 mM solution of four dNTPs	5 µl
10 µM (dT) <sub>17</sub> -adaptor-primer (16 pmoles)	1.6 µl
10 µM adaptor-primer (32 pmoles)	3.2 µl
10 µM gene-specific, sense oligonucleotide primer (32 pmoles)	3.2 µl
1–2 units thermostable DNA polymerase	1 µl
H <sub>2</sub> O	to 50 µl

It is essential to set up a series of amplification reactions to find the amount of cDNA that generates the largest quantity of amplified 3' termini. The control containing no cDNA template serves as a control for contamination.

5. If the thermal cycler is not fitted with a heated lid, overlay the reaction mixtures with 1 drop (~50  $\mu$ l) of light mineral oil. Alternatively, place a bead of paraffin wax into the tube if using a hot start protocol. Place the tubes or the microtiter plate in the thermal cycler. Amplify the nucleic acids using the denaturation, annealing, and polymerization times and temperatures listed in the table.

Cycle Number	Denaturation	Annealing	Polymerization
First cycle	5 min at 94°C	5 min at 50–58°C	40 min at 72°C
Subsequent cycles (20)	40 sec at 94°C	1 min at 50–58°C	3 min at 72°C
Last cycle	40 sec at 94°C	1 min at 50–58°C	15 min at 72°C

These times are suitable for 50- $\mu$ l reactions assembled in thin-walled 0.5-ml tubes and incubated in thermal cyclers such as the Perkin-Elmer 9600 or 9700, Master Cycler (Eppendorf), and PTC 100 (MJ Research). Times and temperatures may need to be adapted to suit other types of equipment and reaction volumes.

The polymerization reaction in the first cycle is carried out for an extended period of time (40 minutes) to ensure the synthesis of long 5'-extended cDNAs by the thermostable DNA polymerase.

6. Withdraw a sample (5–10  $\mu$ l) from the test reaction mixture and the four control reactions and analyze them by electrophoresis through an agarose or polyacrylamide gel. Be sure to include DNA markers of an appropriate size. Stain the gel with ethidium bromide or SYBR Gold to visualize the DNA.

A successful amplification reaction should yield a readily visible DNA fragment of the expected size. The identity of the band can be confirmed by DNA sequencing (please see Chapter 12, Protocol 6), Southern hybridization (please see Chapter 6, Protocol 10), and/or restriction mapping.

If no product is visible after 30 cycles of amplification, add fresh *Taq* polymerase and continue the amplification reaction for a further 15–20 cycles.

If amplification of the tailed cDNA preparation results in a smear of DNA after gel electrophoresis, the longest products of the amplification reaction should be recovered from a preparative agarose gel. An aliquot of this material can then be reamplified for a limited number (15–20) of additional cycles of PCR.

7. If mineral oil was used to overlay the sample, remove the oil from the sample before cloning by extraction with 150  $\mu$ l of chloroform.

The aqueous phase, which contains the amplified DNA, will form a micelle near the meniscus. The micelle can be transferred to a fresh tube with an automatic micropipette.

**▲ IMPORTANT** Do not attempt chloroform extractions in microtiter plates. The plastic used in these plates is not resistant to organic solvents.

8. Separate the amplified DNA from the residual thermostable DNA polymerase and dNTPs (please see Protocol 3).

The DNA can now be ligated to a blunt-ended vector or a T vector, or it can be digested with restriction enzymes and ligated to a vector with compatible termini (please see Protocols 4, 5, and 6).

If problems arise, please see the remedies and variations described for the 5'-RACE reaction (Protocol 9) which apply also to the 3'-RACE procedure.

# Protocol 11

---

## Mixed Oligonucleotide-primed Amplification of cDNA

**T**HESE DAYS, THE BEST WAY TO CLONE A GENE WHEN ONLY a fragmentary sequence of the protein is known is to use amino acid sequences to design oligonucleotides that can be used either as probes to screen libraries or to amplify the target sequence by PCR. An obvious problem with both methods is the degeneracy of the genetic code. There are 64 possible codons and only 20 amino acids; most amino acids are represented by more than one codon. Because there are no rules that guarantee selection of the correct codon, a certain sequence of amino acids can be encoded by a large number of different oligonucleotides. Unless the designer is incredibly lucky and chooses the correct codon in every single position, the oligonucleotide will not form a perfect hybrid with the target gene or cDNA.

Oligonucleotide probes used to screen genomic and cDNA libraries by hybridization usually correspond to amino acid sequences that are 5–25 amino acids in length. Because of the degeneracy of the genetic code, there obviously are many thousands of nucleotide sequences that could code for such a sequence of amino acids. Until the advent of PCR-based methods such as mixed oligonucleotide-primed amplification of cDNA (MOPAC), investigators simply made intelligent guesses about the most likely codon used at each position and then synthesized an oligonucleotide probe — a “guessmer” — that incorporated all of these hunches (Lathe 1985). The aim was to generate a probe of sufficient length so that the detrimental effects of the inevitable mismatches were outweighed by the stability of extensive tracts of perfectly matched bases. Guessmers reached their height of popularity in the mid 1980s when fledgling recombinant DNA companies were desperately trying to clone genes of commercial value. For them, serendipity was often handsomely rewarded since the cDNA and genomic DNA clones of many useful and lucrative genes were obtained during this period.

In recent years, however, guessmers have been eclipsed by PCRs primed by degenerate pools of oligonucleotides. These pools are not random samples of all possible sequences that can encode a particular peptide. Rather, they are skewed populations of oligonucleotides that, on statistical grounds, are most likely to correspond to the coding sequence of the authentic gene. In PCRs containing genomic or cDNA templates, there is a good chance that the degenerate pools of oligonucleotides will drive amplification of part of the gene of interest with high specificity. The resulting DNA product is identical in sequence to a segment of the target gene and can be used under conditions of high stringency to probe cDNA and genomic libraries and to detect



homologous sequences in Southern and northern blots. Experience indicates that the MOPAC procedure is more reliable and more sensitive than direct screening of libraries with guessmers. This advantage is chiefly because PCR-based methods such as MOPAC require far shorter tracts of amino acid sequence and because PCR methods are more tolerant of redundancy. Pools of highly degenerate primers (even those consisting of a mixture of 60 or more different oligonucleotides) work well in PCR (Girgis et al. 1988; Knoth et al. 1988; Lee et al. 1988).

In the standard MOPAC procedure, the amino-terminal and carboxy-terminal sequences of a peptide are used to design two redundant families of oligonucleotides encoding the amino- and carboxy-terminal sequences of the peptide (Lee et al. 1988). The primers are used either to amplify a segment of cDNA prepared by RT-PCR from a tissue known to express the protein or to amplify a segment of DNA from an established genomic or cDNA library. Because the length of the peptide is known, the size of the expected PCR product can be predicted exactly. After gel electrophoresis to resolve the amplification products, DNAs of the correct size are isolated, cloned, and sequenced. At least some of the clones should contain a DNA segment of the correct length that specifies the sequence of the starting peptide. Once identified, the entire cloned segment or the unique sequence lying between the two oligonucleotide primers is used as a probe to screen a cDNA library. Variations on this general protocol involve:

- **Using degenerate oligonucleotide primers derived from two separate peptide sequences**, each at least 6–7 amino acids in length, to amplify the segment of DNA that codes for the tract of amino acids located between the two peptides. Since in many cases, the relative orientation of the peptides in the protein will be unknown, pools of degenerate oligonucleotides derived from both strands of the DNA must be synthesized and used in different combinations. The length of the amino acid sequence lying between the two peptides may also be unknown, which eliminates the possibility of purifying a PCR product of the correct length prior to cloning.
- **Using only one degenerate primer in combination with a unique primer** that binds to flanking sequences in the cloning vector or to a synthetic homopolymeric tail attached to first-strand cDNA. The chief problem with this approach is the high background of clones that results from using a primer that recognizes every clone in a library. If sufficient amino acid sequence is available, a second set of oligonucleotides can be used to prime a nested PCR using DNA templates generated by the original outer primer pair.

The crucial step in MOPAC is the design of degenerate pools of oligonucleotides. Although no rules exist that guarantee selection of the correct codon at a position of ambiguity, the chance of success can be increased by following these simple rules.

- **Use the region of the available amino acid sequence** that has the least degeneracy. If possible, choose a region that is rich in Met and Trp, each of which has one codon. Cys, Asp, Glu, Phe, His, Lys, Gln, and Tyr are also desirable amino acids because they each have only two codons. Avoid regions rich in Leu, Arg, and Ser (each specified by six codons).
- **Design the longest primers possible** without allowing the number of oligonucleotides in the degenerate pool to exceed 64. The specificity of primers reduces markedly when their length is <17 nucleotides. Both the efficiency and specificity of priming by degenerate pools of oligonucleotides decrease as a function of their complexity.
- **Consult tables of codon usage** (Wada et al. 1992; please see Appendix 7). For amino acids specified by three or more codons, use the two codons that are most prevalent in genes of the organism under study.

- **When necessary, limit the degeneracy of primers** by using a universal nucleotide such as inosine, whose neutral base, hypoxanthine, forms stable base pairs with cytosine, thymine, and adenine (please see the information panel on the **USE OF INOSINE IN DEGENERATE POOLS OF OLIGONUCLEOTIDES USED FOR PCR**).
- **Wherever possible, end the oligonucleotides** at a Met or Trp residue. This strategy guarantees that the three nucleotides at the 3' ends of all of the oligonucleotides in the degenerate pool will form an exact match with the target sequence precisely. Alternatively, end the oligonucleotides at the second position of a codon specifying Cys, Asp, Glu, Phe, His, Lys, Gln, or Tyr. This strategy guarantees that the two bases at the 3' ends of all of the oligonucleotides will match the target sequence. Do not use inosine at the 3' end of the degenerate oligonucleotides (Sommer and Tautz 1989). As with other types of PCR, the 5' end of the degenerate oligonucleotides may be designed to carry restriction sites and other useful features.

The DNA template for MOPAC reactions can consist of cDNA prepared from a source that expresses the target protein, genomic DNA, or total DNA from a cDNA or genomic library (representing at least  $10^5$  to  $10^6$  clones) that is thought to contain the cDNA or gene of interest. If there is uncertainty regarding the tissue specificity of a particular mRNA, start with cDNA prepared from a tissue with a high complexity of transcribed genes, such as the mammalian brain (Sutcliffe 1988) or from a source of germ cells (e.g., mammalian testes; Strathmann et al. 1989). In the case of cDNA libraries cloned in bacteriophage  $\lambda$  vectors, an aliquot of the bacteriophage preparation itself can sometimes be amplified without purification of the DNA. However, in general, the cleaner the input template, the more efficient the MOPAC reaction. It is essential to remove any primers used to generate the cDNA template by centrifugation through Centricon-100 microconcentrators (Protocol 3) before carrying out the MOPAC reaction.

Finally, pools of highly degenerate primers can be used for purposes other than to clone genes from fragmentary protein sequences, including isolation of members of multigene families from a particular species (e.g., please see Buck and Axel 1991) and isolation of the homologous genes from diverse species (please see the section below, Screening of Libraries for Related Genes Using MOPAC; for reviews, please see Preston 1993; Peterson and Tjian 1993). Highly degenerate primers may also be used for rapid amplification of cDNA ends (5'- and 3'-RACE) (please see Protocols 9 and 10) (Frohman et al. 1988).

## SCREENING OF LIBRARIES FOR RELATED GENES USING MOPAC

---

Variations on the MOPAC theme can be used to isolate members of a multigene family (e.g., please see Buck and Axel 1991), homologs from evolutionarily distant species (e.g., please see Lewis and Pelham 1990), or isozymes (e.g., please see Strathmann et al. 1989). For such purposes, oligonucleotides representing amino acid sequences conserved between members of protein families are used as primers to screen cDNA or genomic libraries. The exact size of the desired product cannot be predicted with confidence because insertions and deletions may have occurred during evolution of the target gene. However, amplified products that fall within a chosen size range can be isolated and analyzed. In the design of the oligonucleotide primers and the choice of starting template, reasonable assumptions can be made concerning the positions of introns if a gene structure of a family member or homolog is known.

## MATERIALS

▲ **IMPORTANT** To reduce the chance of contamination with exogenous DNAs, prepare and use a special set of reagents and solutions for PCR only. Bake all glassware for 6 hours at 150°C and autoclave all plasticware. For more information, please see the panel on **CONTAMINATION IN PCR** in the chapter introduction.

**CAUTION:** Please see Appendix 12 for appropriate handling of materials marked with <!.>.

### Buffers and Solutions

Please see Appendix 1 for components of stock solutions, buffers, and reagents. Dilute stock solutions to the appropriate concentrations.

*10x Amplification buffer*

*dNTP solution (20 mM) containing all four dNTPs (pH 8.0)*

### Enzymes and Buffers

*Thermostable DNA polymerase*

*Taq* DNA polymerase is the standard and appropriate enzyme for the amplification stage of most forms of RT-PCR. However, where elongation from 3'-mismatched primers is suspected, a thermostable DNA polymerase with 3'→5' proofreading activity may be preferred (Chiang et al. 1993).

### Gels

*Polyacrylamide gel <!.>*

Please see Step 4.

### Nucleic Acids and Oligonucleotides

*DNA template (100 µg/ml) (cDNA, genomic DNA, or cDNA library) in TE (pH 8.0)*

Any DNA that contains the target sequence(s) can be used as a template in MOPAC reactions. Genomic DNA, uncloned preparations of cDNA, or cDNAs extracted from established libraries have all been used successfully. However, the chance of success increases as a function of the concentration of target sequences in the preparation. Thus, cDNAs prepared from mRNAs that contain the target sequence in abundance are more likely to succeed than the corresponding genomic DNAs. As in all forms of PCR, the cleaner the template DNA, the more efficient the amplification. Nevertheless, in the case of cDNA libraries cloned in bacteriophage λ vectors, an aliquot of the bacteriophage preparation itself can sometimes be used as a template without further purification of the DNA. Before carrying out the MOPAC, it is essential to remove any primers (such as oligo[dT]) that were used to prime synthesis of cDNA templates (for details, please see Protocol 3).

*Family of antisense oligonucleotide primers (10 µM) in TE (pH 8.0)*

Oligonucleotide primers synthesized on an automated DNA synthesizer can generally be used in standard RT-PCR without further purification. However, amplification of low-abundance mRNAs is often more efficient if the oligonucleotide primers are purified by chromatography on commercially available resins (e.g., NENSORB, NEN Life Science Products) or by denaturing polyacrylamide gel electrophoresis, as described in Chapter 10, Protocol 1.

For details on the use of primers containing inosine, please see the information panel on **USE OF INOSINE IN DEGENERATE POOLS OF OLIGONUCLEOTIDES USED FOR PCR**.

*Family of sense oligonucleotide primers (10 µM) in TE (pH 8.0)*

### Special Equipment

*Barrier tips for automatic micropipettes*

*Microfuge tubes (0.5 ml, thin-walled for amplification) or Microtiter plates*

*Positive-displacement pipette*

*Thermal cycler programmed with desired amplification protocol*

If the thermal cycler is not equipped with a heated lid, use either mineral oil or paraffin wax to prevent evaporation of liquid from the reaction mixture during PCR.

### Additional Reagents

*Step 4 of this protocol requires the reagents listed in Chapter 5, Protocol 2, and Chapter 12, Protocol 6.*

## METHOD

1. In a sterile 0.5-ml microfuge tube, amplification tube, or the well of a sterile microtiter plate, mix in the following order:

0.5 µg of template DNA	5 µl
10x amplification buffer	5 µl
20 mM solution of four dNTPs	5 µl
10 µM sense primer family (70 pmoles)	7 µl
10 µM antisense primer family (70 pmoles)	7 µl
1–2 units thermostable DNA polymerase	1 µl
H <sub>2</sub> O	to 50 µl

Set up several control reactions. In one reaction, include all of the above components, except the template DNA. In two other reactions, include all the components minus one or the other of the oligonucleotide primers.

These controls show whether amplified DNAs arise from a single primer, information that is remarkably useful if the desired product is not detected and new families of degenerate primers are required (Bernasconi et al. 1989).

2. If the thermal cycler is not fitted with a heated lid, overlay the reaction mixtures with 1 drop (~50 µl) of light mineral oil. Alternatively, place a bead of paraffin wax into the tube if using a hot start protocol. Place the tubes or the microtiter plate in the thermal cycler.
3. Amplify the nucleic acids using the denaturation, annealing, and polymerization times and temperatures listed in the table.

Cycle Number	Denaturation	Annealing	Polymerization
First cycle	5 min at 94°C	2.5 min at 40°C	5 min at 50°C
Subsequent cycles (35)	1.5 min at 94°C	2.5 min at 40°C	5 min at 50°C

These times are suitable for 50-µl reactions assembled in thin-walled 0.5-ml tubes and incubated in thermal cyclers such as the Perkin-Elmer 9600 or 9700, Master Cycler (Eppendorf), and PTC 100 (MJ Research). Times and temperatures may need to be adapted to suit other types of equipment and reaction volumes.

The amplification conditions described above are based on 32-member degenerate families of oligonucleotide primers that are 17–20 bases in length. Higher annealing and polymerization temperatures can be used with longer and/or less complex mixtures of oligonucleotides. However, if too many amplification products are obtained, or if no specific products are synthesized, optimum annealing and polymerization temperatures, as well as cycle number and ionic conditions, should be determined in a series of test reactions.

The specificity of MOPAC can be increased (i) by using a thermal cycler program that includes a temperature ramping protocol (Kolodkin et al. 1993), (ii) by using touchdown PCR (Don et al. 1991; please see the information panel on **TOUCHDOWN PCR**), or (iii) by incorporating cosolvents into the amplification reactions.

4. Withdraw a sample (5–10 µl) from the test reaction mixture and the control reactions and analyze them by electrophoresis through a neutral polyacrylamide gel. Be sure to include DNA markers of an appropriate size. Stain the gel with ethidium bromide or SYBR Gold to visualize the DNA.

A successful amplification reaction should yield a readily visible DNA fragment of the expected size. The identity of the band can be confirmed by DNA sequencing (please see Chapter 12, Protocol 6). If the band of interest is only one of a number of amplified fragments, please see the panel on **BAND-STAB PCR**.

If a single contiguous amino acid sequence was used to design both sense and antisense primers for the MOPAC reaction, the exact size of the desired product will be known. In most cases, thin polyacrylamide gels ( $\leq 6\%$ ) should allow size fractionation at nucleotide resolution and unambiguous identification of the desired product. Once identified, the product can be end-labeled (Chapter 9, Protocol 14) and subjected to chemical sequencing (Chapter 12, Protocol 7) to determine a unique sequence linking the two families of oligonucleotide probes. This unique sequence can in turn be synthesized and used as a probe to isolate longer cDNAs. Alternatively, the MOPAC product itself can be radiolabeled during a second round of PCR and used as a probe. If restriction sites are incorporated at the 5' ends of the starting oligonucleotide primers, then the amplified product can easily be cloned after digestion with the appropriate enzyme into appropriate plasmid or bacteriophage vectors. Blunt-ended fragments can be cloned as indicated in Protocol 4.

5. If mineral oil was used to overlay the reaction (Step 2), remove the oil from the sample by extraction with 150  $\mu$ l of chloroform.

The aqueous phase, which contains the amplified DNA, will form a micelle near the meniscus. The micelle can be transferred to a fresh tube with an automatic micropipette.

For many purposes, e.g., purification of the amplified DNA using a Centricon microconcentrator or cloning amplification products, it is desirable to remove the oil from the sample before proceeding.

▲ **IMPORTANT** Do not attempt chloroform extractions in microtiter plates. The plastic used in these plates is not resistant to organic solvents.

#### **BAND-STAB PCR**

Amplification of DNA using MOPAC often generates a number of products of differing molecular weights. Many of these DNAs are irrelevant and unwanted since they are generated by nonspecific priming; others may contain the desired target sequences. In some cases, when a suitable probe is available, the desired fragment(s) can be located by Southern hybridization; in others, all of the amplified bands must be recovered and tested individually. This sampling is best achieved by Band-Stab PCR (Bjourson and Cooper 1992) as described below.

After the agarose gel has been stained with ethidium bromide and analyzed by UV illumination, remove excess fluid by placing a piece of Whatman 3MM paper on the surface for a few seconds. Remove the damp paper and sample each band of interest by stabbing perpendicularly into the gel with the beveled tip of a 21-gauge hypodermic needle. Be careful to avoid parallax errors and use a fresh needle for each band. Withdraw the needle from the gel and then wash the tip in a fresh PCR mixture and reamplify the band of DNA. Whenever possible, reamplification should be carried out using nested PCR.

When recovering bands from polyacrylamide gels by band-stab PCR, *do not use* Whatman 3MM paper to dry the surface of the gel. Instead, carefully remove as much fluid as possible by gentle wiping with a gloved hand. Then use a needle to transfer a small fragment of polyacrylamide containing the band of interest to the fresh PCR. Allow the template DNA to diffuse into the reaction mixture for an hour or two before beginning the amplification.

# Protocol 12

---

## Rapid Characterization of DNAs Cloned in Prokaryotic Vectors

**T**HE POLYMERASE CHAIN REACTION CUTS THE TIME REQUIRED to characterize segments of cDNA cloned in bacteriophage  $\lambda$  and plasmid vectors from several days to a few hours, with a commensurate reduction in effort (Güssow and Clackson 1989; Dorfman 1993; Costa and Weiner 1995). Transformed bacterial cells or bacteriophage  $\lambda$  particles can be picked from colonies or plaques and transferred directly into the PCR mixtures lacking thermostable DNA polymerase but containing primers targeted to vector sequences immediately flanking the putative segment of cloned DNA. The reaction mixtures are heated to boiling to liberate template DNA and to inactivate nucleases and proteases. A thermostable DNA polymerase is then added and ~30 cycles of standard PCR are performed. A successful amplification reaction yields a DNA fragment whose size can be estimated by agarose gel electrophoresis and whose identity can be confirmed by DNA sequencing (Chapter 12), Southern hybridization (Chapter 6), and/or restriction mapping.

Many colonies or plaques can be assayed simultaneously and, because the technique is so rapid, there is usually no need to store large numbers of candidate clones for extended periods of time. The method can easily be adapted to screen cDNA libraries in a stepwise fashion (please see Chapter 11), to work out the orientation of foreign segments of DNA within individual recombinant clones, and to generate templates for DNA sequencing (Krishnan et al. 1991). Finally, the technique can be extended to eukaryotic cells and used, for example, to analyze gene disruptions in yeasts (please see the additional protocols at the end of this protocol) and to identify clones of murine ES cells that have undergone modification by homologous recombination (Loukianov et al. 1997). For further details, please see the additional protocols at the end of this protocol.

The following protocol, modified from Saiki et al. (1988), Güssow and Clackson (1989), and Sandhu et al. (1993), was provided by Diane F. Jelinek (Mayo Clinic, Rochester, Minnesota).

## MATERIALS

---

▲ **IMPORTANT** To reduce the chance of contamination with exogenous DNAs, prepare and use a special set of reagents and solutions for PCR only. Bake all glassware for 6 hours at 150°C and autoclave all plasticware. For more information, please see the panel on **CONTAMINATION IN PCR** in the chapter introduction.

### Buffers and Solutions

Please see **Appendix 1** for components of stock solutions, buffers, and reagents. Dilute stock solutions to the appropriate concentrations.

*10x Amplification buffer*

*dNTP solution (20 mM) containing all four dNTPs (pH 8.0)*

*Tris-Cl (10 mM, pH 7.6)*

### Enzymes and Buffers

*Thermostable DNA polymerase*

### Gels

*Agarose gel*

Please see Step 9.

### Nucleic Acids and Oligonucleotides

*Forward primers (20 μM) in H<sub>2</sub>O and Reverse primers (20 μM) in H<sub>2</sub>O (20 pmoles/μl)*

Oligonucleotide primers used for sequencing DNA segments cloned into most common prokaryotic and eukaryotic vectors may be purchased commercially or synthesized locally. For details, please see the information panel on **UNIVERSAL PRIMERS** and the accompanying tables of primer sequences.

Oligonucleotide primers synthesized on an automated DNA synthesizer can generally be used to screen bacteriophage λ plaques or lysed bacterial colonies in PCR without further purification.

*Template DNAs*

This method uses unpurified templates obtained by cracking bacteriophage λ particles or transformed bacterial cells. Essentially the same methods can be used to analyze viral DNAs in productively infected mammalian or yeast cells transformed by multicopy vectors. For further details, please see the panels on **ADDITIONAL PROTOCOL: SCREENING YEAST COLONIES BY PCR** and **ADDITIONAL PROTOCOL: SCREENING BACTERIOPHAGE λ LIBRARIES**.

### Special Equipment

*Barrier tips for automatic micropipettes*

*Boiling water bath*

*Microfuge tubes (0.5 ml) or Microtiter plates*

*Positive-displacement pipette*

*Thermal cycler programmed with desired amplification protocol*

If the thermal cycler is not equipped with a heated lid, use either mineral oil or paraffin wax to prevent evaporation of liquid from the reaction mixture during PCR.

### Additional Reagents

*Step 9 of this protocol may require the reagents listed in Chapter 5, Protocol 2, and Chapter 6, Protocol 10.*

## METHOD

Screening Individual Bacterial Colonies or Bacteriophage  $\lambda$  Plaques

1. Calculate the number of bacterial colonies or bacteriophage  $\lambda$  plaques that are to be screened. Prepare the appropriate amount of master mix; analysis of each colony or plaque requires 25  $\mu$ l of master mix; 1 ml of master mix contains:

10 $\times$ amplification buffer	100 $\mu$ l
20 mM solution of four dNTPs	50 $\mu$ l
forward primer	1 nmole
reverse primer	1 nmole
H <sub>2</sub> O	to 1 ml

2. Dispense 25- $\mu$ l aliquots of the master mix into the appropriate number of amplification tubes.
3. Use a sterile 200- $\mu$ l pipette tip (NOT a toothpick) to touch each bacterial colony or bacteriophage  $\lambda$  plaque. Working quickly, wash the pipette tip in 25  $\mu$ l of master mix.

Please see the panel on **TROUBLESHOOTING** following Step 9.

4. Close the caps of the tubes. Incubate the closed tubes in a boiling water bath for 10 minutes (bacterial colonies) or 2 minutes (bacteriophage  $\lambda$  plaques).

When screening bacterial colonies, it is important not to skimp on this step, which is required to liberate and denature the DNA templates and to inactivate proteases and nucleases. Bacteriophage  $\lambda$  plaques, by contrast, do not always require boiling. In some protocols (e.g., please see Dorfman 1993), individual plaques are transferred directly into complete reaction mixtures, which are then used immediately in conventional PCR. In our hands, however, boiling for a short time before the addition of *Taq* DNA polymerase improves the consistency of the method and enhances the yield of amplified product.

5. While the tubes are incubating, dilute the required amount of *Taq* DNA polymerase to a concentration of 1 unit/ $\mu$ l in 10 mM Tris (pH 7.6). Store the diluted enzyme on ice until needed.
6. Allow the samples (from Step 4) to cool to room temperature. Centrifuge the tubes briefly to deposit all of the fluid in the bottom and then add 1  $\mu$ l of the diluted *Taq* DNA polymerase to each tube.
7. Set up two control reactions. In one reaction, include all of the components, except the template DNA. In the other reaction, include a recombinant bacteriophage  $\lambda$  plaque or transformed bacterial lysate that has previously produced a positive result in this assay. The fragment amplified in the positive control reaction should be larger than the fragment expected in the test reactions. Successful amplification of the larger, control fragment provides some assurance that the thermostable DNA polymerase is capable of amplifying fragments of the appropriate length.
8. If the thermal cycler does not have a heated lid, overlay the reaction mixtures with 1 drop (~50  $\mu$ l) of light mineral oil. Place the tubes in the thermal cycler. Amplify the nucleic acids using the denaturation, annealing, and polymerization times and temperatures listed in the table.

Cycle Number	Denaturation	Annealing	Polymerization
30 cycles	1 min at 94°C	2 min at 50°C	2 min at 72°C

These times are suitable for reactions assembled in thin-walled 0.5-ml tubes and incubated in thermal cyclers such as the Perkin-Elmer 9600 or 9700, Master Cycler (Eppendorf), and PTC 100 (MJ Research). Times and temperatures may need to be adapted to suit other types of equipment and reaction volumes.



9. Withdraw a sample (5–10  $\mu$ l) from the test reaction mixture and the control reactions and analyze them by electrophoresis through an agarose gel. Be sure to include DNA markers of an appropriate size. Stain the gel with ethidium bromide or SYBR Gold to visualize the DNA.

A successful amplification reaction should yield a readily visible DNA fragment. Nonrecombinant PCR products will be equal to the length of DNA between the locations of the 5' termini of the two primers in the cloning vector. Recombinant PCR products will be the sum of (i) the length of the insert and (ii) the distance between the 5' termini of two primers in the vector. If necessary, the identity of the band can be confirmed by restriction mapping and Southern hybridization.

The technique can be easily adapted to screen large numbers of bacterial colonies or bacteriophage M13 clones by setting up PCRs in 96-well microtiter dishes (Trower 1996).

#### TROUBLESHOOTING

The chief causes of failure with this method are (i) the addition of too much bacterial lysate, which may alter the ionic balance of the reaction and (ii) the accidental inclusion of agar fragments in the reaction mixture, which may inhibit amplification by the thermostable DNA polymerase. Because only a few hundred molecules of template DNA are required, avoid overloading the reaction with template when sampling plaques and colonies.

The absence of a PCR product in the control and test reactions may indicate that the insert is simply too large to amplify efficiently. In this case, a preparation of thermostable DNA polymerase capable of amplifying longer templates can be used instead of conventional *Taq* DNA polymerase. Alternatively, a primer specific to the insert can be used in place of one of the vector-specific primers. The orientation of the cloned segment within the vector can be ascertained by using an insert-specific primer with primers from each of the flanking regions of the vector.

#### ADDITIONAL PROTOCOL: SCREENING YEAST COLONIES BY PCR

##### Additional Materials

*Boiling water bath*  
*Yeast colonies*

##### Method

1. Use a sterile 200- $\mu$ l pipette tip to transfer a small amount of a yeast colony that has been growing for 2–4 days to an amplification tube containing 50  $\mu$ l of PCR master mix (please see Step 1 of the main protocol). Resuspend the cells by pipetting up and down five times.
2. Boil the suspension of yeast cells for 5 minutes.
3. Proceed with Steps 5–9 of the main protocol.

Some investigators (e.g., please see Huxley et al. 1990; Sathe et al. 1991) omit the boiling step and proceed directly to PCR after suspending the cells in master mix containing a thermostable DNA polymerase. Other investigators (Ling et al. 1995) lyse the cells with zymolyase before setting up the PCR. In our experience, the boiling step increases the efficiency of PCR, whereas converting cells to spheroplasts with zymolyase is unnecessary and, in our hands, gives erratic results.

**ADDITIONAL PROTOCOL: SCREENING BACTERIOPHAGE  $\lambda$  LIBRARIES**

Screening bacteriophage  $\lambda$  libraries for clones of interest is usually carried out according to the Benton-Davis method of hybridization (Benton and Davis 1977). However, PCR can also be used to find out whether a given library contains a desired clone and to screen cDNA libraries in a stepwise fashion for one or more targets (e.g., please see Griffin et al. 1993; Israel 1993; McAlinden and Krawetz 1994; Watanabe et al. 1997; for review, please see Yu and Bloem 1996). The technique is particularly useful when screening cDNA libraries for clones that contain sequences from the 5' or 3' ends of cDNA.

**Additional Materials**

Bacteriophage  $\lambda$  library  
 Boiling water bath  
 Nitrocellulose filters (132 mm)  
 Petri dishes (150 mm)  
 SM

**Method**

1. Plate the bacteriophage  $\lambda$  library in top agarose on 150-mm plates as described in Chapter 2, Protocol 1. Incubate the plates and transfer the colonies onto numbered nitrocellulose filters as described in Steps 4–6 of Protocol 21 (Chapter 2). There is no need to key the filters to the plates.

Nitrocellulose filters are preferred to nylon filters since they are less expensive. Charged nylon filters should not be used because the bacteriophage  $\lambda$  particles stick so tightly that they cannot easily be washed free.

2. Use blunt-ended forceps to remove the filters carefully one by one. Place each filter in a separate 150-mm dish containing 3–5 ml of SM. Jiggle the filter to encourage the bacteriophage particles to float into the fluid phase. Remove the filter and hold it over the dish until no more bacteriophage suspension drips from the filter. Discard the filter.

Wrap the numbered agar plates in Saran Wrap. Store the plates at 4°C.

3. Transfer the bacteriophage suspension to a sterile, labeled tube. Use a separate tube for each plate. These tubes provide a source of material that can be screened many times without further plating of the library.
4. Transfer 25  $\mu$ l of each of the bacteriophage suspensions to an amplification tube. Close the tube and heat it in a boiling water bath for 5 minutes.
5. Chill the boiled suspension in ice and then use 5  $\mu$ l of the supernatant as a template in PCRs primed by oligonucleotides that are specific for the target sequence.

When screening libraries for clones containing the 5' or 3' sequences of cDNAs, one of the primers should anneal to the appropriate flanking vector sequences and the other should anneal to the desired region of the target gene.

Wherever possible, include both positive and negative controls with each batch of PCRs. For example, each of the bacteriophage suspensions can be spiked with a known amount of a purified clone. Sets of primers specific for the known clone and the target clone can then be used simultaneously in the same PCR.

6. After a desired recombinant has been identified, replat the appropriate bacteriophage suspension(s). Plate enough bacteriophages to obtain fivefold coverage of the subpopulation of the library. Transfer the bacteriophages to a nitrocellulose filter that has been previously marked into 12 or more sectors. Before removing the filter from the plate, orient the filter to the plate and mark the locations of the sectors on the bottom of the plate.

Wrap the sectored agar plate in Saran Wrap. Store the plate at 4°C.

7. Transfer the nitrocellulose filter (bacteriophage side uppermost) to a sterile Petri dish. Working quickly, cut the filter into sectors and recover the bacteriophage particles from each segment in  $\sim$ 0.5 ml of SM.
8. Using  $\sim$ 25  $\mu$ l of each of the secondary suspensions (Step 7), repeat Steps 4 and 5 to detect the desired recombinant by PCR.

Continue this step-wise analysis for one or two more rounds, until the calculated complexity of the last suspension is  $<10^4$  recombinant bacteriophages. At this stage, the suspension should be plated onto 10–20 plates at a density of  $\sim$ 2500 pfu/plate. The resulting plaques should be screened by conventional Benton-Davis hybridization to identify and isolate the clone of interest (please see Chapter 2, Protocol 22). If necessary, the sectored agar plates (Step 6) can be used as an additional source of bacteriophages.

A similar stepwise procedure can be used to screen cDNA libraries constructed in plasmid vectors (Trower 1996; Takumi 1997).

# Protocol 13

---

## Long PCR

**U**NDER STANDARD REACTION CONDITIONS, PCR IS EASILY CAPABLE of amplifying segments of DNA 1–2 kb in length. This capacity is sufficient for many routine manipulations of DNA (e.g., sequencing and mutagenesis), but it is not enough to amplify an entire mammalian gene — even one of modest size — nor a cDNA of average dimensions. Explanations proposed for the inability of standard PCR to amplify long segments of DNA include:

- **Damage to the template and product DNAs** during exposure to high temperature in buffers that may not adequately maintain control over pH.
- **The presence of stray divalent cations** ( $Mn^{2+}$  is always the prime suspect) that may promote cleavage of DNA at high temperature.
- **Difficulties in denaturing very long DNA molecules** during the heating step of the PCR cycle.
- **The inability of DNA polymerases to remain attached** to the template DNA, particularly in regions of secondary structure.
- **The high rate of incorporation of incorrect bases** by thermostable polymerases such as *Taq* that lack an editing function. The incorporation of a mismatched base at the 3' end of a growing strand may cause the enzyme to seize up and may limit the size of the PCR product.

Four of these problems were fixed (at least in part) by simple adjustments to the reaction conditions (for review, please see Foord and Rose 1994). The fifth, however, required an original thought. Wayne Barnes (1994) realized that the obstacles created by mismatched 3' termini could be eliminated by using two different thermostable DNA polymerases to catalyze the amplification reaction. One of the polymerases would be an efficient but error-prone workhorse (Klentaq1, in Barnes' case), whereas the second, used in much smaller amounts, would provide a 3'→5' exonuclease function that would resect mismatched ends (e.g., *Pfu*). These improvements have become embodied in cocktails, sold by a number of manufacturers (e.g., TaqPlus Long PCR System, Stratagen; Expand Long Template PCR System, Boehringer Mannheim), that generate high yields from long targets.

The following protocol, supplied by Rob Rawson (University of Texas Southwestern Medical Center, Dallas) can be used to amplify DNA over the entire length (up to 25 kb) of genomic DNA segments cloned in bacteriophage  $\lambda$  vectors or smaller segments (10–12 kb) of preparations of total mammalian DNA.

## MATERIALS

▲ **IMPORTANT** To reduce the chance of contamination with exogenous DNAs, prepare and use a special set of reagents and solutions for PCR only. Bake all glassware for 6 hours at 150°C and autoclave all plasticware. For more information, please see the panel on **CONTAMINATION IN PCR** in the chapter introduction.

**CAUTION:** Please see Appendix 12 for appropriate handling of materials marked with <!>.

### Buffers and Solutions

Please see Appendix 1 for components of stock solutions, buffers, and reagents. Dilute stock solutions to the appropriate concentrations.

*Chloroform* <!>

*dNTP solution (20 mM) containing all four dNTPs (pH 8.0)*

*10x Long PCR buffer*

500 mM Tris-Cl (pH 9.0 at room temperature)

160 mM ammonium sulfate

25 mM MgCl<sub>2</sub>

1.5 mg/ml bovine serum albumin

Sterilize the 10x buffer by filtration through an 0.22- $\mu$ m membrane. Divide the sterile buffer into aliquots and store the aliquots at -20°C.

Higher concentrations of Tris are used to maintain correct pH during the long extension times required for amplification of long templates (Ohler and Rose 1992). The pH of the stock solution is also increased to 9.0 (at room temperature) to compensate for the large downward shift in pK<sub>a</sub> that occurs when Tris buffers are heated (Good et al. 1966; Ferguson et al. 1980); for further details, please see Appendix 1. Alternatively, Tris can be replaced by Tricine (pH 8.4 at room temperature; final concentration 30 mM) (Ponce and Micol 1991). The temperature dependence of the pK<sub>a</sub> of Tricine buffers is far less than that of Tris (Good and Izawa 1972).

KCl (100 mM) can be used in place of ammonium sulfate in the 10x long PCR buffer, and gelatin can be used at a concentration of 0.01% in the final reaction in place of bovine serum albumin.

Additional components reported by Foord and Rose (1994) to improve the efficiency of long PCR include *glycerol* at a concentration of 5% (v/v) in the final reaction mixture to promote separation of DNA strands at lower temperatures, and *EDTA* at a concentration of 0.75 mM in the final reaction mixture to chelate divalent cations such as Mn<sup>2+</sup> that might promote scission of DNA strands.

### Enzymes and Buffers

*Thermostable DNA polymerase mix*

Klentaq1 can be obtained from AB Peptides (St. Louis, Missouri), and *Pfu* polymerase can be obtained from Stratagene. A typical mixture contains 0.187 unit of *Pfu* and 33.7 units of Klentaq1 in a total volume of 1.2  $\mu$ l (Foord and Rose 1994).

### Gels

*Agarose gel*

Please see Step 4.

### Nucleic Acids and Oligonucleotides

*Template DNA*

Long PCR works well on a variety of templates including recombinant PACs, BACs, cosmids, and bacteriophage  $\lambda$  clones, as well as high-molecular-weight genomic DNAs. However, the quality of the DNA is paramount. The average length of the template DNAs (assayed by agarose gel or pulsed-field gel electrophoresis) should be at least three times greater than the length of the desired PCR product. The DNAs should also be extensively purified to reduce the concentration of inhibitors. It may seem to be outmoded, slow, and expensive, but in our hands, the best way to prepare genomic DNAs for long PCR is by equilibrium density centrifugation in CsCl gradients, followed by dialysis against TE (pH 8.0) (please see Chapter 1, Protocol 10).

*Forward primers (20  $\mu$ M) in H<sub>2</sub>O and Reverse primers (20  $\mu$ M) in H<sub>2</sub>O (20 pmoles/ $\mu$ l)*

The rules for the design of primers (please see Design of Oligonucleotide Primers for Basic PCR in the introduction to this chapter) must be followed closely. However, primers used for long PCR are generally slightly longer (25–30 nucleotides) than those used for standard PCR. It is particularly important to strive for equality between the melting temperatures of the two primers. If the difference in melting temperatures exceeds one centigrade degree, mispriming and preferential amplification of one strand may become a problem.

Oligonucleotide primers synthesized on an automated DNA synthesizer can sometimes be used successfully in long PCR without further purification. However, amplification is usually more efficient if the oligonucleotide primers are purified by chromatography on commercially available resins (e.g., NEN-SORB, NEN Life Science Products) or by denaturing polyacrylamide gel electrophoresis, as described in Chapter 10, Protocol 1.

**Special Equipment**

*Barrier tips for automatic micropipettes*

*Microfuge tubes (0.5 ml, thin-walled for amplification)*

*Positive-displacement pipette*

*Thermal cycler programmed with desired amplification protocol*

If the thermal cycler is not equipped with a heated lid, use either mineral oil or paraffin wax to prevent evaporation of liquid from the reaction mixture during PCR.

**Additional Reagents**

*Step 4 of this protocol requires the reagents listed in Chapter 5, Protocol 2, and Chapter 6, Protocol 10.*

**METHOD**

1. In a thin-walled amplification tube, add and mix in the following order:

10x long PCR buffer	5 $\mu$ l
20 mM solution of four dNTPs	5 $\mu$ l
20 mM forward primer	1 $\mu$ l
20 mM reverse primer	1 $\mu$ l
thermostable DNA polymerase mix	0.2 $\mu$ l
template DNA	100 pg to 2 $\mu$ g
H <sub>2</sub> O	to 50 $\mu$ l

Templates purified from individual recombinant clones constructed in bacteriophage  $\lambda$ , cosmid, bacteriophage P1, PAC, and BAC vectors should be used in amounts ranging from 100 pg to 300 ng. Larger amounts of total genomic DNAs are required, usually between 100 ng and 1  $\mu$ g per reaction. In long PCR, there is little flexibility in the amount of template used in the reaction. Too little and no product is detectable; too much and the loss of specificity can be dramatic. The optimum amount of template and the optimum ratio of primers:template should be ascertained empirically for each new preparation of DNA.

2. If the thermal cycler is not fitted with a heated lid, overlay the reaction mixtures with 1 drop (~50  $\mu$ l) of light mineral oil. Alternatively, place a bead of paraffin wax into the tube if using a hot start PCR. Place the tubes or the microtiter plate in the thermal cycler. Amplify the nucleic acids using the denaturation, annealing, and polymerization times and temperatures listed in the table.

Cycle Number	Denaturation	Annealing	Polymerization
24 cycles	1 min at 94°C	1 min at 60–67°C	5–20 min at 68°C

These times are suitable for 50- $\mu$ l reactions assembled in thin-walled 0.5-ml tubes and incubated in thermal cyclers such as the Perkin-Elmer 9600 or 9700, Master Cycler (Eppendorf), and PTC 100 (MJ Research). Times and temperatures may need to be adapted to suit other types of equipment and reaction volumes.

The temperature used for the annealing step depends on the melting temperature of the oligonucleotide primers. Because the primers used in long PCR are generally 27–30 nucleotides in length, the annealing temperatures used in long PCR can be considerably higher than those used in standard PCR.

Polymerization should be carried out for 1 minute for every 1000 bp of length of the target DNA. Foord and Rose (1994) recommend increasing the polymerization time by 30 seconds in each cycle of PCR. However, in our hands, extension of the polymerization time has not led to any improvements in specificity or yield.

3. If mineral oil was used to overlay the reaction (Step 2), remove the oil from the sample by extraction with 150  $\mu$ l of chloroform.

The aqueous phase, which contains the amplified DNA, will form a micelle near the meniscus. The micelle can be transferred to a fresh tube with an automatic micropipette.

**▲ IMPORTANT** Do not attempt chloroform extractions in microtiter plates. The plastic used in these plates is not resistant to organic solvents.

4. Analyze an aliquot of the aqueous phase by electrophoresis through an agarose gel using markers of an appropriate size. In many cases, the amount of amplified product may be too small to be detected by conventional staining with ethidium bromide. In this case, stain the DNA in the gel with SYBR Gold or transfer to a nylon or nitrocellulose filter and probe by Southern hybridization (please see Chapter 6, Protocol 10).

Although long PCR is more demanding than standard PCR, it does not differ in any essential principle. The problems with long PCR and standard PCR are similar and almost always involve specificity and yield. In the vast majority of cases, these can be solved by careful optimization of all phases of the reaction (please see Tables 8-4 and 8-5 in Protocol 1).

# Protocol 14

---

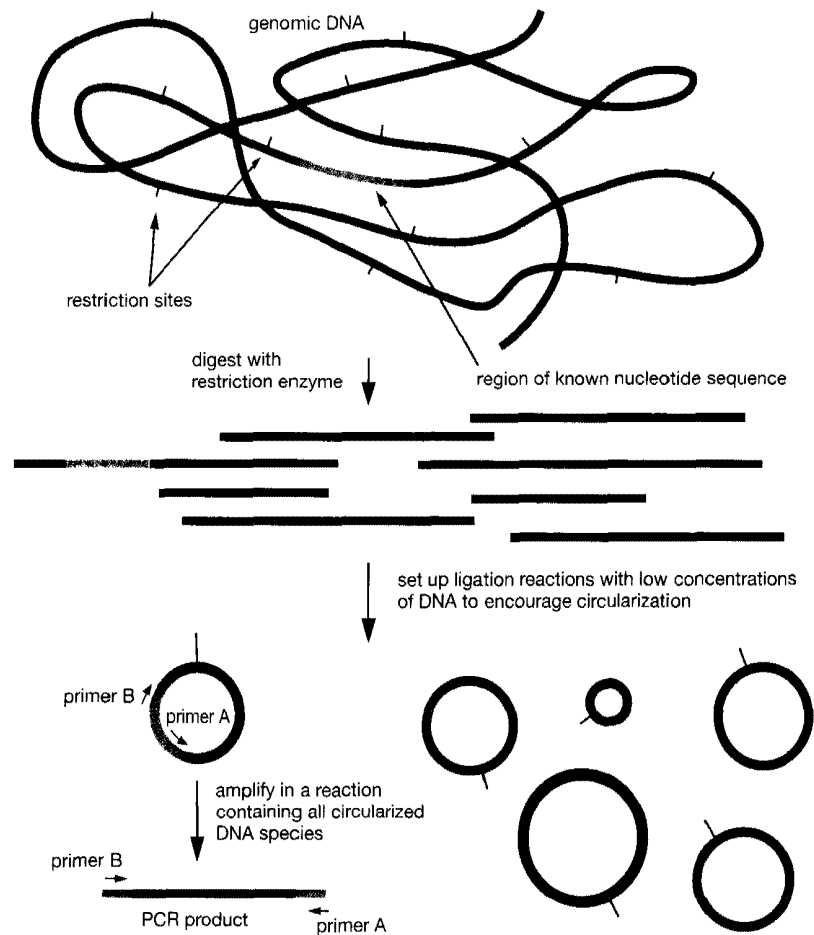
## Inverse PCR

**S**TANDARD PCR AMPLIFIES SEGMENTS OF DNA that lie between two inward-pointing primers. By contrast, inverse (also known as inverted or inside-out) PCR is used to amplify and clone unknown DNA that flanks one end of a known DNA sequence and for which no primers are available. The technique, developed independently by several groups (Ochman et al. 1988; Triglia et al. 1988; Silver and Keerikatte 1989), involves digestion by a restriction enzyme of a preparation of DNA containing the known sequence and its flanking region (please see Figure 8-7). The individual restriction fragments (many thousands in the case of total mammalian genomic DNA) are converted into circles by intramolecular ligation, and the circularized DNA is then used as a template in PCR. The unknown sequence is amplified by two primers that bind specifically to the known sequence and point in opposite directions.

The product of the amplification reaction is a linear DNA fragment containing a single site for the restriction enzyme originally used to digest the DNA. This site marks the junction between the previously cloned sequence and the flanking sequences. The size of the amplified fragment depends on the distribution of restriction sites within known and flanking DNA sequences. By setting up reactions with template DNA that has been cleaved by different restriction enzymes, as much as 4 kb of flanking DNA can be recovered by inverse PCR (Jones and Winistorfer 1993). Both upstream and downstream flanking regions can be obtained in a single inverse PCR by using a restriction enzyme that does not cleave within the known DNA sequence.

Inverse PCR has been used chiefly to generate end-specific probes for chromosome walking (Garza et al. 1989; Silverman et al. 1989; Silverman 1993, 1996), to clone unknown cDNA sequences from total RNA (Huang et al 1990, 1993), and to recover integration sites used by viruses, transgenes, and transposons (Ochman et al. 1988, 1990, 1993; Triglia et al. 1988; Silver and Keerikatte 1989). However, inverse PCR remains one of the more problematic techniques in molecular cloning and success is not guaranteed. Because the method works best with DNA templates whose sequence complexity is  $<10^9$  bp, it is unlikely that inverse PCR will work when total mammalian genomic DNA is used as a template. To increase the chance of success, genomic DNA can be fractionated according to size after digestion with a restriction enzyme, or genomic DNA libraries can be subdivided into aliquots whose sequence complexity is  $<10^9$  bp. The use of nested sets of primers in sequential reactions can also help (Takagi et al. 1992).

The following protocol, an amalgam of several reported in the literature, was provided by Dennis McKearin (University of Texas Southwestern Medical Center, Dallas).



**FIGURE 8-7 Schematic Representation of Inverse PCR**

Inverse PCR is used to amplify DNA of unknown sequence (*dark shading*) that is adjacent to known DNA sequence (*light shading*). Genomic DNA is digested with an enzyme that produces a fragment (among others) carrying the known DNA, as determined by Southern blotting. The DNA fragments are circularized by ligation, and specific sequence primers, designed to extend outward from the known sequence, are used to amplify unknown sequences adjacent to the region of known sequence.

## MATERIALS

▲ **IMPORTANT** To reduce the chance of contamination with exogenous DNAs, prepare and use a special set of reagents and solutions for PCR only. Bake all glassware for 6 hours at 150°C and autoclave all plasticware. For more information, please see the panel on **CONTAMINATION IN PCR** in the chapter introduction.

**CAUTION:** Please see Appendix 12 for appropriate handling of materials marked with <!>.

## Buffers and Solutions

Please see Appendix 1 for components of stock solutions, buffers, and reagents. Dilute stock solutions to the appropriate concentrations.

10x Amplification buffer

ATP (10 mM)



Chloroform <!\>  
 dNTP solution (20 mM) containing all four dNTPs (pH 8.0)  
 Ethanol  
 Phenol:chloroform (1:1, v/v) <!\>  
 Sodium acetate (3 M)  
 TE (pH 8.0)  
 Tris-Cl (10 mM, pH 7.6)

## Enzymes and Buffers

Bacteriophage T4 ligase (1 unit/ $\mu$ l)  
 Restriction endonucleases  
 Thermostable DNA polymerase

## Gels

Agarose or Polyacrylamide gel <!\>  
 Please see Step 7.

## Nucleic Acids and Oligonucleotides

*Oligonucleotide primer 1 (20  $\mu$ M) in H<sub>2</sub>O and Oligonucleotide primer 2 (20  $\mu$ M) in H<sub>2</sub>O*

There is nothing unusual about the primers used in inverse PCR except their placement on the template molecule (please see Figure 8-7). The standard rules for design of primers therefore apply. Each primer should be 20–30 nucleotides in length and should contain approximately equal numbers of the four bases, with a balanced distribution of G and C residues and a low propensity to form stable secondary structures. Restriction sites can be added to the 5' ends of the primers to facilitate subsequent cloning and manipulation of the amplified products. For further details, please see Design of Oligonucleotide Primers for Basic PCR in the introduction to this chapter.

Oligonucleotide primers synthesized on an automated DNA synthesizer can generally be used in standard PCR without further purification. However, amplification of single-copy sequences from mammalian genomic templates is often more efficient if the oligonucleotide primers are purified by chromatography on commercially available resins (e.g., NENSORB, NEN Life Science Products) or by denaturing polyacrylamide gel electrophoresis, as described in Chapter 10, Protocol 1.

*Template DNA in 10 mM Tris-Cl (pH 7.6) containing <0.1 mM EDTA*

Inverse PCR requires a circular DNA as template. Steps 1–4 of this protocol describe how such templates can be generated from conventional preparations of linear DNAs, which can be a purified fragment of DNA; a preparation of total genomic DNA, fractionated according to size; a bacteriophage  $\lambda$  cDNA library; an aliquot of a cosmid or bacteriophage P1 genomic library; or any other DNA whose sequence complexity is  $<10^9$  bp. Use at least 1  $\mu$ g of each linear DNA template to allow circularization and PCR to be carried out at several DNA concentrations.

## Special Equipment

Barrier tips for automatic micropipettes  
 Microfuge tubes (0.5 ml, thin-walled for amplification) or Microtiter plates  
 Positive-displacement pipette  
 Thermal cycler programmed with desired amplification protocol  
 If the thermal cycler is not equipped with a heated lid, use either mineral oil or paraffin wax to prevent evaporation of liquid from the reaction mixture during PCR.  
 Water bath preset to 16°C

## Additional Reagents

Step 7 of this protocol requires the reagents listed in chapter 5, Protocol 2, Chapter 6, Protocol 10, or Chapter 12, Protocol 6.

## METHOD

1. Design and synthesize oligonucleotide primers 1 and 2 based on the known sequence of DNA.
2. Digest 2–5 µg of DNA template (sequence complexity  $<10^9$  bp) with an appropriate restriction enzyme (please see note below). Extract the digested DNA with phenol:chloroform, and then with chloroform alone. Precipitate the DNA with 0.1 volume of 3 M sodium acetate and 2.5 volumes of ethanol. Recover the precipitated DNA by centrifugation and dissolve it in TE (pH 8.0) at a concentration of 100 µg/ml.

Alternatively, heat the digested DNA to 65°C for 15–20 minutes to inactivate the restriction enzyme.

Southern hybridization (Chapter 6, Protocol 10) may be used to identify a restriction enzyme that generates a fragment of the appropriate size (1–4 kb). Wherever possible, choose an enzyme that yields complementary cohesive termini. This choice increases the efficiency of circularization of the template DNA during ligation. Enzymes that generate blunt ends can be used as a last resort. In this case, however, polyethylene glycol should be added to the ligation buffer (please see Chapter 1, Protocol 19 and the information panel on **POLYETHYLENE GLYCOL** in Chapter 1) to promote circularization.

3. In sterile 0.5-ml microfuge tubes, amplification tubes, or the wells of a sterile microtiter plate, set up a series of ligation reactions containing cleaved template DNA at concentrations ranging from 0.1 to 1 µg/ml.

template DNA	10 ng to 100 ng
10x ligation buffer	10 µl
1 unit/µl bacteriophage T4 DNA ligase	4 µl
10 mM ATP	10 µl
H <sub>2</sub> O	to 100 µl

Incubate the reactions for 12–16 hours at 16°C.

Some commercial ligase buffers contain ATP. When using such buffers, the addition of ATP to the ligation reaction is no longer required.

Conditions that favor the formation of monomeric circles during ligation are well understood in theory (Collins and Weissman 1984) but are difficult to achieve in practice. The molar concentration of DNA ends must obviously be low in order to favor the formation of intramolecular circles over concatamers. However, it is difficult to calculate an appropriate concentration when the DNA molecules in the population differ in size and when the proportion of damaged termini is unknown. Under these circumstances, it is best to set up a series of ligation reactions with DNA concentrations ranging from 1 to 10 µg/ml and to carry the products of these reactions through the subsequent steps of the protocol.

4. Extract the ligated DNA with phenol:chloroform, and then with chloroform alone. Precipitate the DNA with 0.1 volume of 3 M sodium acetate and 2.5 volumes of ethanol. Recover the precipitated DNA by centrifugation and dissolve it in 10 mM Tris (pH 7.6) or H<sub>2</sub>O at a concentration of 100 µg/ml.
5. In a sterile 0.5-ml thin-walled amplification tube, add and mix in the following order:

10x amplification buffer	5 µl
20 mM solution of four dNTPs (pH 8.0)	1 µl
20 µM oligonucleotide primer 1	2.5 µl
20 µM oligonucleotide primer 2	2.5 µl
1–5 units/µl thermostable DNA polymerase	1.0 µl
H <sub>2</sub> O	28–33 µl
ligated template DNA	5–10 µl
Total volume	50 µl

The efficiency of inverse PCR is sometimes improved by amplification of linear, rather than circular, DNA templates. Linearization of the template can be achieved by digesting the circularized molecules with a restriction enzyme that cleaves in the region of known DNA, between the 5' termini of the two primers. Ideally, the enzyme should not cleave the unknown sequences. Alternatively, the circular molecules can be linearized, albeit less efficiently, by heating the samples to 100°C for 15 minutes before setting up the amplification reactions (Triglia et al. 1988; Ochman et al. 1993).

Set up two control reactions. In one reaction, include all of the above reagents, except the template DNA. In the other reaction, replace the template with a plasmid of known size, containing the DNA insert from which the oligonucleotide primers were derived. The first control ensures that any product visualized is not due to the presence of extraneous DNA. The second tests the fidelity of the PCR reagents. Carry each control reaction through all subsequent steps of the protocol.

6. If the thermal cycler is not fitted with a heated lid, overlay the reaction mixtures with 1 drop (~50 µl) of light mineral oil. This prevents evaporation of the samples during repeated cycles of heating and cooling. Alternatively, place a bead of wax into the tube if using hot start PCR. Place the tubes or the microtiter plate in the thermal cycler. Amplify the nucleic acids using the denaturation, annealing, and polymerization times and temperatures listed in the table.

Cycle Number	Denaturation	Annealing	Polymerization
30 cycles	30 sec at 94°C	30 sec at 60°C	2.5 min at 72°C
Last cycle	30 sec at 94°C	30 sec at 60°C	10 min at 72°C

These times are suitable for 50-µl reactions assembled in thin-walled 0.5-ml tubes and incubated in thermal cyclers such as the Perkin-Elmer 9600 or 9700, Master Cycler (Eppendorf), and PTC 100 (MJ Research). Times and temperatures may need to be adapted to suit other types of equipment and reaction volumes.

Most thermal cyclers have an end routine in which the amplified samples are incubated at 4°C until they are removed from the machine. Samples can be left overnight at this temperature, but should be stored thereafter at -20°C.

The exact annealing temperature should be established empirically for the primer pairs used in a given amplification reaction. An extended polymerization time (up to 10 minutes per cycle) should be tried if the target DNA is long (>4 kb). Alternatively, the use of mutant thermostable DNA polymerases that lack exonuclease activity (e.g., KlenTaq1 enzyme, AB Peptides, St. Louis, Missouri) and/or that contain a low level of 3'-exonuclease activity (e.g., *Pfu*, *Vent*, or *DeepVent* enzymes from Stratagene and New England Biolabs, respectively) may produce longer templates. Also, please see the note on long PCR in Protocol 13, Step 2.

7. Withdraw a sample (5–10 µl) from the test reactions and the control reactions and analyze them by electrophoresis through an agarose or polyacrylamide gel. Be sure to include DNA markers of an appropriate size. Stain the gel with ethidium bromide or SYBR Gold.

A successful amplification reaction should yield a readily visible DNA. The identity of the band can be confirmed by DNA sequencing (please see Chapter 12, Protocol 6), and/or restriction mapping and/or Southern hybridization using probes homologous to the known DNA sequence (please see Chapter 6, Protocol 10).

If low yields are a problem, the desired fragment can be purified by gel electrophoresis, isolated by band-stab (please see the panel on **BAND-STAB PCR** in Protocol 11), and reamplified using oligonucleotide primers 1 and 2.

If nonspecific amplification is a problem, nested primers should be used in the second round of PCR (Takagi et al. 1992).

# Protocol 15

---

## Quantitative PCR

**P**CR CAN BE USED TO ESTIMATE THE CONCENTRATION of a particular target DNA or RNA relative to a standard (for reviews, please see Ferre 1992; Foley et al. 1993; Raeymaekers 1993, 1995; Gause and Adamovicz 1994; Cross 1995; Reischl and Kochanowski 1995; Freeman et al. 1999; Halford 1999) (please see the panel on **REAL TIME PCR** at the end of this protocol). However, quantitative PCR, more than any other form of PCR, is littered with booby traps and is not for the technically challenged. Many of the difficulties stem from the nature of PCR itself. Because PCR is an exponential process, small differences in efficiency at each cycle of the reaction can lead to large differences in the yield of the amplified product. Anything that can affect exponential amplification can compromise quantitation of target sequences. For example, the presence of different amounts of inhibitors in a series of samples containing the same amount of template DNA could lead to differences in the final yield of amplified product, as could small differences in efficiency between primer pairs used to amplify standard and target sequences. So sensitive are PCRs to minor differences in conditions that the coefficient of variability of yield of amplified product is typically 10–20% in replicate samples (e.g., please see Wiesner et al. 1992; Hill et al. 1996; Halford et al. 1999). For this reason, methods that simply quantify the amount of amplified DNA that accumulates over the course of a PCR (so-called end-point methods) are generally regarded as unreliable. In recent years, more sophisticated methods have been developed in which amplified DNA is quantified during the exponential phase of the PCR. These methods, some of which have been automated (please see the panel on **REAL TIME PCR**), have eliminated much of the variation associated with end-point measurement.

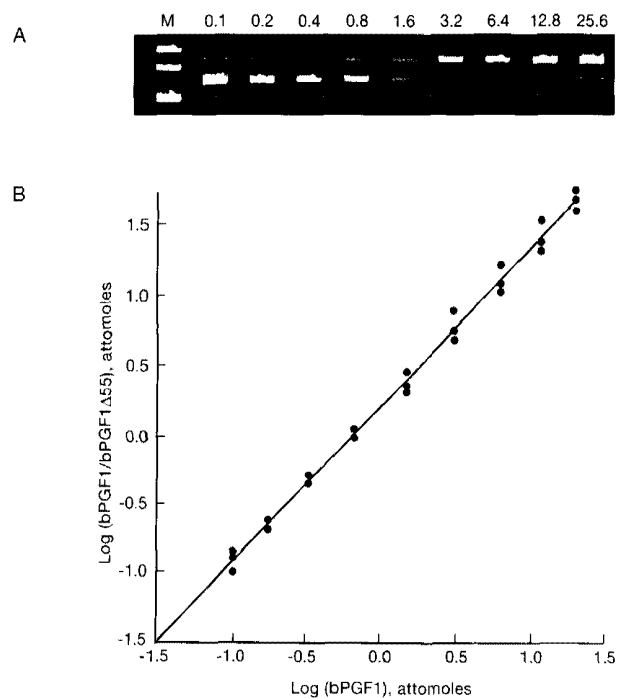
An early method of quantitative PCR involved comparing the amount of specific product generated in different samples from a particular target sequence. In this technique, the amounts of amplified product were measured at several time points during the exponential phase of the reaction and were then analyzed by linear regression (Wiesner et al. 1992; Clifford et al. 1994). When working at its best, this method could be used to detect picomolar concentrations of target sequence and was accurate enough to distinguish twofold differences in concentration of target sequence in different samples. However, the method often fell prey to tube-to-tube variability and, for this reason, is no longer in common use.

Two types of controls described below can be used to monitor tube-to-tube variability: endogenous standards and externally added references.

- **Endogenous standards** are control sequences (usually housekeeping genes or their mRNAs) that are present in the same preparation of DNA or RNA as the target sequences. Quantification is achieved by comparing the amount of amplified product generated by the

endogenous standard and the target sequence (Chelly et al. 1990). The method works well if the amplified products are measured during the exponential phase of the reaction, if the reference and target sequences are amplified with equal efficiency, and if they are present in the sample at approximately equal concentrations. However, these conditions are rarely fulfilled because the amplified products are almost always different from the endogenous reference in size, sequence, and abundance. These imbalances between reference and target become manifest as systematic differences in amplification efficiency between the two nucleic acids. In addition, there is no guarantee that the housekeeping genes chosen as endogenous standards are invariant in their levels of expression from one sample to the next. The levels of expression of these genes are not constant from one mammalian tissue to another nor from one cell line to another (e.g., please see Mansur et al. 1993; Spanakis 1993; Bhatia et al. 1994). Differences in the amount of amplified product generated by the reference and the target may therefore result from differential amplification or from changes in the level of transcription of the target gene and/or the standard gene, or from both.

- **Externally added reference** molecules are DNAs or RNAs that are added in known amounts to a series of amplification reactions (Wang et al. 1989; Gilliland et al. 1990). Because the reference templates and target sequences are present in the same amplification reaction and use the same primers (please see below), the effect of the variables mentioned earlier is nullified. Quantification is achieved by comparing the amount of amplified products generated by the reference and target sequences. The purpose of the experiment — to find out the ratio of reference sequences to target sequences in the reaction mixture at cycle zero — can be achieved in two ways. A series of reactions can be set up containing different ratios of reference and target molecules. A curve is constructed showing the relationship between the amount of amplified product and the amount of reference added to the reaction. The target sequence can then be quantified by interpolation (please see Figure 8-8). Thus, in a reaction that yields equal amounts of the two amplified products, the ratio of target molecules to reference molecules at the beginning of the PCR is said to be unity. However, this conclusion is true only if amplification efficiencies of target and reference molecules are equal throughout the course of the PCR.



**FIGURE 8-8 Quantitation of mRNA by Amplifying Varying Amounts of a Standard (Native) DNA Fragment with a Constant Amount of Competitor DNA**

In this example, a fragment of native bovine FP receptor cDNA (bPGF1) is amplified in the presence of a competitor fragment of bovine FP receptor DNA carrying an internal deletion of 55 bp (bPGF1Δ55). (A) Resulting amplification products from reactions containing different ratios of bPGF1 to bPGF1Δ55 are shown as ethidium-bromide-stained bands after separation by electrophoresis through 5% polyacrylamide. (B) Composite standard curve is derived from four independent experiments. The log ratio of native to competitor product was plotted against the log amount of initial native added to the RT-PCR. (Modified, with permission, from Tsai and Wiltbank 1996.)

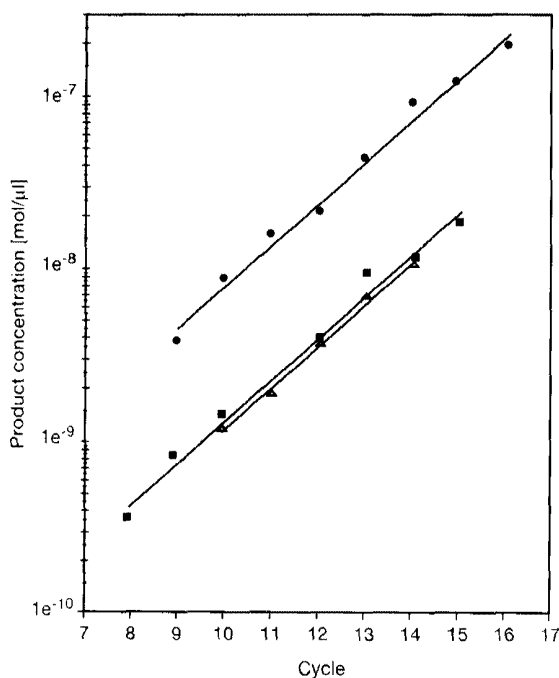
To eliminate this source of doubt, a more sophisticated method is available. This approach involves quantifying the amounts of reference and target sequences in consecutive cycles within the exponential phase of PCR. Amplified products accumulate during this phase according to the following equation (please see the panel on **PCR IN THEORY** in the chapter introduction):

$$\log N_f = n \log (1 + Y) + \log N_o$$

where  $N_f$  is the copy number of the amplified sequence after  $n$  cycles of amplification,  $N_o$  is the initial copy number of the target sequence in the DNA template, and  $Y$  is the efficiency of amplification per cycle.

A semilogarithmic graphical plot of log concentration of a particular amplified product against cycle number yields a straight line (please see Figure 8-9) (Tsai and Wiltbank 1996; Harting and Wiesner 1997). The equation describing the accumulation of the product can then be derived using regression analysis. If, as is most desirable, the target sequences and the reference sequences are amplified with equal efficiency, the regression lines will be parallel to each other. The ratio between the target and reference molecules can be calculated from the intersection of the regression lines with a single, midexponential cycle (Harting and Wiesner 1997).

DNAs encoding reference templates are constructed and cloned into vectors equipped with a promoter for bacteriophage-encoded DNA-dependent RNA polymerases. In most cases, the reference templates are constructed by modifying a clone of the target sequence in a way that allows the coamplified products to be distinguished from one another. For example, the reference and the target might differ slightly in size by insertion or deletion of a small fragment of DNA or in sequence by alteration of one or two bases that are required to create a new restriction site or remove a naturally occurring site. In general, references and targets that differ slightly in size are preferred because they can be easily distinguished by gel electrophoresis. In the case of RT-PCR, reference templates are transcribed from the engineered plasmid using a bacteriophage-encoded RNA polymerase, purified, and quantified by absorbance at 260 nm. Measured amounts of reference template are added to test RNAs prepared from a known number of cells expressing the genes of interest, and the mixture is converted into cDNA by reverse transcription. Because the reference and the target RNAs are both present throughout all phases of RT-PCR, they are copied



**FIGURE 8-9** Quantitation by Accumulation of Products in RT-PCR vs. Cycle Number

In this example, product accumulation is shown for amplification (RT-PCR) of three samples: 12S rRNA (*circles*), cytochrome C oxidase (COX I) mRNA (*squares*), and a reference template sequence from the D-loop region of mitochondrial DNA (*triangles*). The data are shown as product concentration vs. cycle number in a semi-logarithmic plot with respective linear regression lines. In this experiment, the ratios for 12S:D-loop and COX I:D-loop are 5.77 and 1.1, respectively. (Adapted, with permission, from Harting and Wiesner 1997.)

simultaneously into DNA by reverse transcription and are then coamplified using the same primers (Becker-André and Hahlbrock 1989; Wang et al. 1989; Gilliland et al. 1990; Siebert and Larrick 1992). For this reason, reference molecules of this type are sometimes called "competitors."

RNA references are not for the faint-hearted: They are the mark of investigators with a strong commitment to esthetic values and a high level of technical skill. A much easier alternative is to use DNA references, which are more durable and much easier to handle (e.g., please see Siebert and Larrick 1992). DNA references are entirely suitable for quantitative PCR of DNA templates, but they are clearly less appropriate for quantification of RNAs.

In summary, before attempting quantitative PCR, it is essential to address the following issues. First, rigorously optimize the reagents and conditions used in the amplification reaction (please see Parameters That Affect Polymerase Chain Reactions in the chapter introduction). Second, suppress the competing reactions that occur in the amplification reaction due to mispriming. This goal is best accomplished using a hot start PCR or touchdown PCR protocol. Third, carry out calibration experiments in which progressively smaller amounts of standard templates are amplified. Fourth, establish the reproducibility of the methods by performing a statistically significant number of multiple assays on the same sets of templates and, finally, on independently processed samples. Finally, perform control experiments showing that the efficiency of amplification of target and reference molecules are equal during the course of the PCR. With this groundwork in place, it becomes possible to draw confident conclusions about the relative or absolute concentration of the target sequence from the yield of amplified product in a standard PCR.

In its most basic form, quantitative RT-PCR involves coamplification of two templates: a constant amount of an RNA preparation containing the desired target sequence and serial dilutions of a reference template that is added in known amounts to a series of amplification reactions. The concentration of the target sequence is determined by simple interpolation into a standard curve (Gilliland et al. 1990; Freeman et al. 1999; please see Figure 8-9 and accompanying text). Once this basic technique is established in the laboratory, the method can easily be extended to include the more accurate regression analysis of the accumulation of the amplification products during successive cycles of PCR (Harting and Wiesner 1997). For a variation of this procedure, please see the panel on **MEASURING MULTIPLE GENE PRODUCTS BY RT-PCR**.

Because of the amount of work involved in setting up competitive quantitative PCR in a fashion that will satisfy sceptics, alternative methods (semiquantitative PCR) have been developed that do not include externally added standards. In some hands, these semiquantitative methods yield results that are identical to those obtained by more stringent experimentation (for review, please see Halford 1999). However, because the value of semiquantitative PCR remains controversial, it seems more prudent at the moment to include the full range of standards and reference templates.

In recent years, commercial systems have been developed to quantify specific sequences in preparations of DNA or RNA by measuring the intensity of signals emitted by DNAs generated in successive cycles of a PCR. Because these systems allow the simultaneous amplification and quantification of specific nucleic acid sequences in real time, they eliminate the need to withdraw aliquots at different stages during the PCR. Real time PCR and the commercial instruments needed to carry out the method are discussed in detail in the panel on **REAL TIME PCR** at the end of this protocol.

#### **MEASURING MULTIPLE GENE PRODUCTS BY RT-PCR**

A clever improvement of the method presented in this protocol is described by Wang et al. (1989). A plasmid vector is first engineered that contains a bacteriophage T7 RNA polymerase promoter and pairs of 5' and 3' oligonucleotide primer sequences derived from genes whose mRNA concentrations are to be measured. The pairs of oligonucleotide primers are derived from as many as 12 different genes and are spaced variable, but known, distances apart in the vector. The distance separating a gene-specific pair of oligonucleotide primers in the standard template plasmid is similar to, but slightly different from, the distance separating the primer sequences in the natural mRNA. This difference allows the amplification products from the cDNA and plasmid DNA templates to be distinguished.

## MATERIALS

---

▲ **IMPORTANT** To reduce the chance of contamination with exogenous DNAs, prepare and use a special set of reagents and solutions for PCR only. Bake all glassware for 6 hours at 150°C and autoclave all plasticware. For more information, please see the panel on **CONTAMINATION IN PCR** in the chapter introduction.

**CAUTION:** Please see Appendix 12 for appropriate handling of materials marked with <!>.

### Buffers and Solutions

Please see Appendix 1 for components of stock solutions, buffers, and reagents.  
Dilute stock solutions to the appropriate concentrations.

*10x Amplification buffer*

*dNTP solution (20 mM) containing all four dNTPs (pH 8.0)*

*MgCl<sub>2</sub> (50 mM)*

*Placental RNase inhibitor (20 units/μl)*

Please see the information panel on **INHIBITORS OF RNASES** in Chapter 7.

### Enzymes and Buffers

*Appropriate restriction endonuclease*

Please see Step 7.

*Reverse transcriptase (100–200 units/μl)*

*Thermostable DNA polymerase*

*Taq* DNA polymerase is the standard and appropriate enzyme for the amplification stage of most forms of quantitative PCR.

### Radioactive Compounds

*[α-<sup>32</sup>P]dCTP (sp. act. 3000 Ci/mmmole) at 10 mCi/ml <!>*

### Gels

*Agarose or Polyacrylamide gels <!>*

Please see Steps 1 and 7.

### Nucleic Acids and Oligonucleotides

*Externally added reference (either DNA or RNA) of known concentration*

For a discussion of the design of this template, please see the introduction to this protocol. Use a DNA reference to measure the concentration of DNA sequences by conventional PCR and, whenever possible, an RNA reference to measure the concentration of a target RNA by quantitative RT-PCR. The basic method for the construction of reference RNAs is described in Chapter 15, Protocol 2. For details on plasmid construction for synthesis of reference RNAs, please see Diviacco et al. (1992), Schneeberger et al. (1995), and Schneeberger and Zeillinger (1996).

*Sense primer (20 μM) in H<sub>2</sub>O and Antisense primer (20 μM) in H<sub>2</sub>O*

Each primer should be 20–30 nucleotides in length and contain approximately equal numbers of the four bases, with a balanced distribution of G and C residues and a low propensity to form stable secondary structures. For further details, please see Design of Oligonucleotide Primers for Basic PCR in the introduction to this chapter.

Oligonucleotide primers synthesized on an automated DNA synthesizer can generally be used in quantitative PCR without further purification.

*Target nucleic acid*

The target can be a preparation of DNA or RNA, either total or poly(A)<sup>+</sup>. Dissolve preparations of total RNA at a concentration of 0.5–1 mg/ml and preparations of poly(A)<sup>+</sup> RNA at a concentration of 10–100 μg/ml. Dissolve DNA targets in 10 mM Tris-Cl (pH 7.6) at the following concentrations: mammalian genomic DNA, 100 μg/ml; yeast genomic DNA, 1 μg/ml; bacterial genomic DNA, 0.1 μg/ml; and plasmid DNA, 1–5 ng/ml.



## Special Equipment

*Barrier tips for automatic micropipettes*

*Microfuge tubes (0.5 ml, thin-walled for amplification) or Microtiter plates*

*Positive-displacement pipette*

*Thermal cycler programmed with desired amplification protocol*

If the thermal cycler is not equipped with a heated lid, use either mineral oil or paraffin wax to prevent evaporation of liquid from the reaction mixture during PCR.

*Water baths, preset to 94°C and to 75°C and 95°C (for template RNA only)*

## METHOD

---

### Preparation of the Reference Template

1. Use the guidelines given in the introduction to design and prepare a reference template suitable for the task at hand. Measure the concentration of the reference template as carefully as possible, preferably by fluorometry (please see Appendix 6). Alternatively, estimate the amount of reference template after gel electrophoresis and ethidium bromide staining.
2. Make a series of tenfold dilutions (in H<sub>2</sub>O) containing concentrations of the reference template ranging from 10<sup>-6</sup> to 10<sup>-12</sup> M. After using the dilutions in Step 3, they should be stored at -70°C for use in Step 8.

It is important to use H<sub>2</sub>O rather than TE as the diluent to avoid altering the concentration of Mg<sup>2+</sup> in the PCR.

### Preparation of cDNA

3. If starting from RNA, denature the target RNA by incubating aliquots for 5 minutes at 75°C, followed by rapid chilling in ice water. Then, without delay, set up a series of reverse transcription reactions containing increasing amounts of reference template in sterile 0.5-ml microfuge tubes. For each reaction in the series, prepare the following:

10x amplification buffer	2 μl
20 mM solution of four dNTPs (pH 8.0)	1 μl
20 μM antisense primer	2.5 μl
~20 units/μl placental RNase inhibitor	1 μl
50 mM MgCl <sub>2</sub>	1 μl
denatured target RNA	10 pg to 1.0 μg
100–200 units/μl reverse transcriptase	1 μl
tenfold dilution of reference template	1 μl
H <sub>2</sub> O	to 20 μl

MgCl<sub>2</sub> is added to meet the needs of the reverse transcriptase.

For advice on setting up reverse transcriptase reactions, please see the panel on **REVERSE TRANSCRIPTASES USED IN RT-PCR** in Protocol 8.

Incubate the reaction for 60 minutes at 37°C and then denature the reverse transcriptase by heating to 95°C for 20 minutes.

## Amplification of Reference and Target Nucleic Acids

- In sterile 0.5-ml microfuge tubes, amplification tubes, or the wells of a sterile microtiter plate, set up amplification reactions with each reaction in the series from Step 3:

reverse transcriptase reaction (Step 3)	
or target DNA	5 $\mu$ l
20 $\mu$ M sense primer	1.5 $\mu$ l
20 $\mu$ M antisense primer	1.25 $\mu$ l
10x amplification buffer	5 $\mu$ l
[ $\alpha$ - $^{32}$ P]dCTP (3000 Ci/mmol)	10 $\mu$ Ci
20 mM solution of four dNTPs	1 $\mu$ l
<i>Taq</i> DNA polymerase	2 units
H <sub>2</sub> O	to 50 $\mu$ l

**▲ IMPORTANT** Do not reduce the concentration of unlabeled dCTP in the reaction mixture to increase the specific activity of the precursor pool. There is a danger that the amount of the nucleotide could become limiting at late stages in the amplification reaction.

- If the thermal cycler is not fitted with a heated lid, overlay the reaction mixtures with 1 drop (~50  $\mu$ l) of light mineral oil. This prevents evaporation of the samples during repeated cycles of heating and cooling. Alternatively, place a bead of wax into the tube if using hot start PCR. Place the tubes or the microtiter plate in the thermal cycler.
- Amplify the nucleic acids using the denaturation, annealing, and polymerization times and temperatures listed in the table.

Cycle Number	Denaturation	Annealing	Polymerization
30 cycles	30 sec at 95°C	30 sec at 55°C	1 min at 72°C
Last cycle	1 min at 94°C	30 sec at 55°C	1 min at 72°C

These times are suitable for 50- $\mu$ l reactions assembled in thin-walled 0.5-ml tubes and incubated in thermal cyclers such as the Perkin-Elmer 9600 or 9700, Master Cycler (Eppendorf), and PTC 100 (MJ Research). Times and temperatures may need to be adapted to suit other types of equipment and reaction volumes.

## Detection and Quantification of PCR Products

A variety of different methods have been used to detect and quantify amplified products. These include solid-phase assays, anion-exchange high-performance liquid chromatography (HPLC), and fluorescence labeling of amplified nucleic acids (please see Reischl and Kochanowski 1995). However, such recondite techniques are neither widely available nor strictly necessary. Excellent results can be obtained by gel electrophoresis followed by more standard methods, such as the use of fluorescently labeled primers quantified with an automated DNA sequencer (Porcher et al. 1992), fluorometry (please see Appendix 9), computer analysis of images of gels stained with ethidium bromide or other intercalating dyes (Schneeberger et al. 1995; Tsai and Wiltbank 1996), or measurement of radioactivity incorporated during amplification (as is done in this protocol).

- Analyze and quantitate the amplified products.

### WHEN USING A REFERENCE TEMPLATE THAT DIFFERS FROM THE TARGET SEQUENCE IN SIZE

- Analyze the sizes of the amplified products in a 20- $\mu$ l aliquot of each of the reactions by gel electrophoresis and autoradiography.

- b. Excise the amplified bands of the control template and target sequences from the gel, and measure the amount of radioactivity in each band in a liquid scintillation counter. Alternatively, scan the gel with the appropriate detector (e.g., Ambis scanner or phosphorimager).
- c. Calculate the relative amounts of the two radiolabeled DNAs in each of the PCRs.
 

Remember to correct the amount of radioactivity to allow for differences in the molecular weights of the two radiolabeled DNAs.

**WHEN USING A REFERENCE TEMPLATE THAT CONTAINS A NOVEL RESTRICTION SITE OR LACKS A NATURALLY OCCURRING SITE**

- a. Heat the samples to 94°C for 5 minutes following the final round of amplification.
  - b. Allow the samples to cool gradually to room temperature and then digest a 20- $\mu$ l aliquot of each of the reactions with the appropriate restriction enzyme.
  - c. Analyze the sizes of the amplified DNA fragments by gel electrophoresis and autoradiography.
  - d. Excise the amplified bands of the control template and target sequences from the gel, and measure the amount of radioactivity in each band in a liquid scintillation counter. Alternatively, scan the gel with the appropriate detector (e.g., Ambis scanner or phosphorimager).
  - e. Calculate the relative amounts of the two radiolabeled DNAs in each of the PCRs.
 

Remember to correct the amount of radioactivity to allow for differences in the molecular weights of the two radiolabeled DNAs.

The aim of this denaturation and reannealing step is to allow efficient formation of heteroduplexes consisting of one strand of reference template and one strand of target sequence. When equal concentrations of the two templates are present in the original reaction mixture, the reannealed products will consist of 50% heteroduplexes and 25% of each type of homoduplex. Only one of the two types of homoduplexes will be susceptible to digestion with the appropriate restriction enzyme. Thus, when the amplified products consist of equal quantities of target and reference templates, one quarter of the reannealed molecules will be susceptible to cleavage by a restriction enzyme. Which of the two types of homoduplexes will be susceptible to cleavage depends on whether the reference template carries an extra restriction site or lacks a site that is present in the target sequence.

Heteroduplex formation is far less efficient when the target and reference templates differ significantly in size. For example, very little heteroduplex formation can be observed between a target sequence of 300 nucleotides and a reference template of 250 nucleotides. Under these circumstances, the ratio of cleaved to uncleaved products can approach unity. If the fragments differ significantly in size, they can be directly separated by gel electrophoresis and quantified.
8. Examine the results to determine the concentration of reference template that yields approximately the same amount of amplified product as the target sequence. Set up a second series of amplification reactions (please see Step 4) containing a narrower range of concentrations of reference template.
 

It is best to generate this series of dilutions from the appropriate tenfold dilution of the reference template (Step 2).
  9. Repeat Steps 5, 6, and 7. For each amplification reaction, measure the ratio of the yield of amplified reference template to the yield of amplified target sequence. Plot this ratio against the amount of reference template added to each amplification reaction. From the resulting straight line, determine the equivalence point (i.e., the amount of reference template that gives exactly the same quantity of amplified product as the target sequence in the reaction). Calculate the concentration of the target sequence in the original sample.

**REAL TIME PCR**

Real time PCR (sometimes called kinetic PCR) is used in research laboratories to quantify gene expression and to confirm differential expression of genes detected by array technology. In analytical laboratories, real time PCR is used to measure the abundance of particular DNA or RNA sequences in clinical and industrial samples and, in both types of laboratories, to screen for mutations and single nucleotide polymorphisms. Real time PCR uses commercially available fluorescence-detecting thermocyclers to amplify specific nucleic acid sequences and measure their concentration simultaneously. Because the target sequences are amplified and detected in the same instrument, there is no need to withdraw aliquots during the reaction or to process them. Instead, the instrument plots the rate of accumulation of amplified DNA over the course of an entire PCR. The greater the initial concentration of target sequences in the reaction mixture, the fewer the number of cycles required to achieve a particular yield of amplified product (Becker et al. 1996; Gibson et al. 1996; Heid et al. 1996; Freeman et al. 1999). The initial concentration of target sequences can therefore be expressed as the fractional cycle number ( $C_T$ ) required to achieve a present threshold of amplification. A plot of  $C_T$  against the  $\log_{10}$  of the initial copy number of a set of standard DNAs yields a straight line (Higuchi et al. 1993). The target sequences in an unknown sample may be easily quantified by interpolation into this standard curve. Unlike other forms of quantitative PCR (please see the introduction to Protocol 15), internal standards are not required in real time PCR.

The ability to quantify the amplified DNA during the exponential phase of the PCR, when none of the components of the reaction are limiting, results in an improved precision in the quantitation of target sequences. By contrast to methods that measure the amount of product at the end of the reaction, real time PCR is not affected to a significant extent by slight variations in the components of the reaction and is less sensitive to differences in the efficiency of amplification.

The earliest of the real time PCR instruments used a fluorometer coupled to a thermal cycler to measure the enhanced fluorescence by dyes that intercalate into, or bind to the grooves of, double-stranded DNA. During the "exponential" phase of a PCR, the amount of amplified product synthesized in each cycle increases in a quasi-geometric fashion (please see the panel on **PCR IN THEORY** in the introduction to this chapter). The yield of amplified DNA may therefore be estimated at any point from the amount of fluorescence emitted by dyes such as ethidium bromide (Higuchi et al. 1992, 1993), SYBR Green I (Wittwer et al. 1997a), or certain oxazole yellow derivatives (Ishiguro et al. 1995).

Because of the high sensitivity of fluorometric detection, real time PCR is capable of measuring the initial concentration of target DNA over a range of five or six orders of magnitude (Heid et al. 1996; Wittwer et al. 1997a). Currently, the limit of detection when fluorescent dyes such as SYBR Green I are used is ~10–100 copies of template DNA in the starting specimen (Higuchi et al. 1993; Wittwer et al. 1997a).

Generic DNA-binding dyes such as ethidium bromide and SYBR Green I are universal probes that detect any double-stranded DNA generated during PCR, independent of the template and primers used in the reaction. Because many molecules of the dyes can bind to each DNA product, the intensity of signal generated is high and is proportional to the total mass of DNA generated during the PCR and is independent of the number of types of molecules produced. High levels of sensitivity are achieved only in real time PCRs that generate a single amplification product. Nonspecific amplification or the formation of primer-dimers can generate significant errors in quantifying small numbers of target molecules when universal dyes are used as reporters. In the worst cases, the emitted fluorescence may bear little or no relationship to the amount of starting target DNA or to the amount of full-length product produced. Several methods have been developed to confirm the specificity of the amplified products of real time PCRs:

- **Melting temperatures.** At the end of the PCR, the thermocycler/fluorometer can be programmed to generate a thermal denaturation curve of the amplified DNA and to measure the melting temperature ( $T_m$ ) of the PCR product(s). The shape of the melting curve indicates whether the amplified products are homogeneous and the  $T_m$  provides reassurance that the correct product has been specifically amplified. Primer-dimers, which generate much of the background noise in real time PCR, because of their short length, generally denature at much lower temperatures and can easily be distinguished from the amplified target DNA (Ririe et al. 1997).
- **Fluorescently labeled oligonucleotide probes.** Two methods have been developed in which fluorescently labeled oligonucleotide probes are used to quantify the amount of the target sequences generated by real time PCR. In each case, the fluorescent signal is generated after extension of the oligonucleotide by *Taq* polymerase. The strength of the signal is therefore proportional to the amount of the target DNA and is not influenced by the accumulation of nonspecific products such as primer-dimers, which do not hybridize to the labeled oligonucleotide probe.

- **The TaqMan method of real time PCR** (Holland et al. 1991; Livak et al. 1995), uses an oligonucleotide that anneals to an internal sequence within the amplified DNA fragment. The oligonucleotide, usually 20–24 bases in length, is labeled at one end with a fluorescent group (Fam < Hex or Tet) at its 5' end and a quenching group (usually Tamra) at its 3' end, which is blocked with PO<sub>4</sub>, NH<sub>2</sub>, or a blocked base. The labeled oligonucleotide is added to the PCR together with primers required to drive the amplification of the target sequence. When both the fluorescent and quenching groups are present in close apposition on the intact hybridization probe, any emission from the reporter dye during the course of real time PCR is absorbed by the quenching dye, and the fluorescent emission is low. As the reaction progresses, and the amount of target DNA increases, progressively greater quantities of oligonucleotide probe hybridize to the denatured target DNA. However, during the extension phase of the PCR cycle, the 5'→3' exonuclease activity of the thermostable polymerase cleaves the fluorophore from the probe. Because the fluorophore is no longer in close proximity to the quencher, it begins to fluoresce. The intensity of fluorescence is in direct proportion to the amount of target DNA synthesized during the course of the PCR. Both the LightCycler and the Prism system can use fluorogenic hydrolysis to detect multiple PCR products. The number of targets that can be detected simultaneously in a single PCR has increased recently through the use of Dabcyl, a universal quencher that can replace Tamra at the 3' end of TaqMan probes (Nasarabadi et al. 1999).
- **Binary hybridization probes** labeled with different fluorescent dyes can also be used to differentiate the products of real time PCRs (Lee et al. 1993; Wittwer et al. 1997a,b). By themselves, these probes emit only low levels of fluorescence. However, when brought into close proximity by hybridization to adjacent sequences in a target DNA during the course of real time PCR, the fluorescent dyes act in synergy to generate a powerful fluorescent emission. Binary oligonucleotide probes labeled with different fluorescent groups can also be used in conjunction with a multicolor detection system in the LightCycler to scan amplified segments of DNA for mutations of polymorphisms. Oligonucleotides that form a mismatched hybrid with the target DNA melt at a lower temperature than the corresponding perfectly matched hybrid. The resulting differences in melting temperature are sufficient to distinguish between target DNAs carrying wild-type or mutant sequences (Lay and Wittwer 1997; Bernard et al. 1998).

#### INSTRUMENTS FOR REAL TIME PCR

The three most popular real time PCR instruments are the GeneAmp 5700 Sequence Detection System and the ABI Prism 7700 Sequence Detection system (both marketed by Perkin-Elmer Biosystems) and the LightCycler (marketed by Roche).

The GeneAmp 5700 System consists of two instruments — an optical detector and a GeneAmp PCR System 9600 — whose activities are coordinated by software. Up to 96 PCRs can be run simultaneously, and the accumulation of amplified DNA at each cycle of the reaction is measured from the intensity of fluorescence emitted by SYBR I Green or TaqMan probes. Up to 96 reactions may be irradiated simultaneously, and the image is captured on a CCD array. Software provides spatial resolution of the 96 wells. The system is basically a single-color detector but is capable of using an internal reference dye (ROX) to eliminate well-to-well variation in base-line fluorescence.

The ABI Prism 7700 has a built-in thermal cycler and a laser whose beam is directed by fiber-optic cables to each of the 96 reactions. The wells are irradiated in sequence and the signals are captured and resolved on a CCD array. Unlike the GeneAmp 5700, the Prism system can detect signals across the entire fluorescent spectrum and is therefore capable of quantitating the signals from different fluorophores used in the same reaction. Like the 5700, the Prism system uses ROX as an internal reference dye. Fluorescent output from ROX is measured during the denaturing step of each cycle of PCR, thus providing a base line against which non-PCR-related, well-to-well variations can be normalized.

In the LightCycler (Roche), the amplification reactions are set up in small sealed glass capillaries that are heated and cooled in an airstream, which greatly reduces the time required for each cycle of PCR. The capillaries are rotated through a sensing station with a built-in three-channel fluorometer (Wittwer et al. 1997b). The data stream from the fluorometer is converted by software into an amplification plot for each of the reactions. Like the Prism system, the LightCycler is capable of distinguishing between fluorophores, so that probes labeled with different reporter groups can be used in the same PCR.

The chief advantages of real time PCR are its ability to measure the concentrations of nucleic acids over a vast dynamic range, its high sensitivity, and its capacity to process many samples simultaneously. Unlike the traditional "endpoint" measurement of PCR products, real time PCR provides immediate information about the kinetics of the PCR. Compensation for differences in efficiency of amplification between different samples can therefore be calculated as described by Hartling and Wiesner (1997) (please see Protocol 15) or embedded in the software used to calculate the concentration of target sequences in the initial reaction mixture.

The chief disadvantage of real time PCR is cost. The machines are expensive to purchase and the maintenance and running costs are considerable. For this reason, the chief beneficiaries of real time PCR have so far been laboratories with an extremely high throughput of samples of a similar type. However, we can hope that the costs of real time PCR will drop in the next few years to the point where the technology becomes readily accessible to individual research laboratories.

# Protocol 16

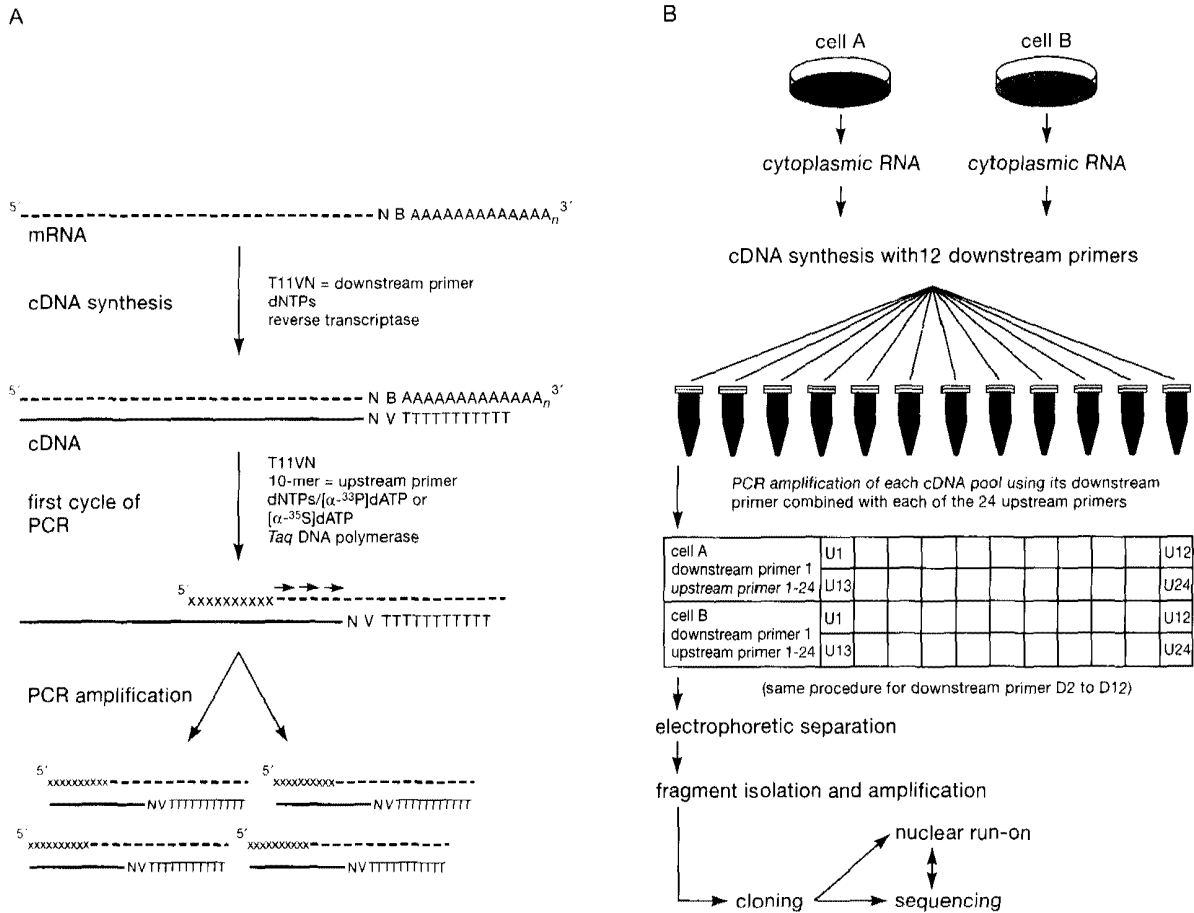
---

## Differential Display-PCR

**I**N 1992, LIANG AND PARDEE, AND INDEPENDENTLY, WELSH ET AL., described a method for using PCR to amplify and display many cDNAs derived from the mRNAs of a given cell or tissue type. The method relies on two different types of synthetic oligonucleotides: anchored antisense primers and arbitrary sense primers. A typical anchored primer is complementary to ~12 nucleotides of the poly(A) tail of mRNA and the adjacent two nucleotides of the transcribed sequence (please see the discussion on Primers Used in DD-PCR, p. 8.99). Anchored primers therefore anneal to the junction between the poly(A) tail and the 3'-untranslated region of mRNA templates, from where they can prime synthesis of first-strand cDNA. A second primer, an arbitrary sequence of ~10 nucleotides, is then added to the reaction mixture and double-stranded cDNAs are produced by conventional PCR, carried out at low stringency. The products of the amplification reaction are separated by electrophoresis through a denaturing polyacrylamide gel and visualized by autoradiography. By comparing the banding patterns of cDNA products derived from two different cell types, or from the same cell type grown under different conditions, it is sometimes possible to identify the products of differentially expressed genes. Bands of interest can then be recovered from the gel, amplified further, and cloned, and/or used as probes to screen, for example, northern blots and cDNA libraries (please see Figure 8-10).

Differential display offers several theoretical advantages over older methods, such as differential hybridization and differential cDNA cloning, that have been used to identify tissue- and cell-specific mRNAs. First, minimal amounts (0.1–0.5 µg) of poly(A)<sup>+</sup> RNA are required. Second, because differential display-PCR (DD-PCR) involves an amplification step, it can in theory be used to detect differential expression of mRNAs that are expressed in very low abundance. Third, because the amplification products from two or more sources are displayed on the same gel, it should be possible to identify both quantitative and qualitative changes in transcription. Finally, differential display can detect changes in expression of closely related RNAs that might be lost from the target population during construction of subtracted cDNA libraries.

Examples of the successful uses of differential display include comparisons of (1) normal and tumor cells (Liang and Pardee 1992), (2) normal and senescent cells (Linskens et al. 1995), (3) stages in developing *Xenopus* and mouse embryos (Zimmermann and Schultz 1994; Adati et al. 1995), (4) cells treated and untreated with hormones (Nitsche et al. 1996), and (5) genes expressed in response to dietary metal ions (Blanchard and Cousins 1996; Wang et al. 1996). The use of differential display has led to the identification of several genes involved in cancer (Liang et al. 1992; Sager et al. 1993), diabetes (Nishio et al. 1994), and heart disease (Utans et al. 1994). Despite these successes, differential display remains a problematic method. It is susceptible to a



**FIGURE 8-10 Schematic Representation of Differential Display**

(A) Principle of the reactions underlying DDRT-PCR analysis. *N* represents any of the four nucleotides G, A, T, or C. *V* can be any nucleotide except T. *B* can be any nucleotide except A. (B) Flow chart of DDRT-PCR analysis with subsequent confirmation of differential regulation and characterization of differentially expressed genes. (Reprinted, with permission, from Warthoe et al. 1995.)

large number of technical difficulties and artifacts, only some of which can be eliminated by control experiments. Although a very large number of projects have been initiated using differential display, the harvest of novel genes has been rather disappointing, and many groups have abandoned the technique in frustration.

Differential display, as presently practiced, is quite incapable of detecting all cDNAs synthesized in cells. First, only a fraction of the mRNA species in a cell fulfills the conditions required for amplification. For an mRNA to be amplified by differential display, it must be able to form a hybrid with a particular anchored 3' primer and with the arbitrary 5' primer. Furthermore, this 5'-priming site must lie within 500 bases of the poly(A) tail in order for the amplified product to be displayed on a conventional denaturing polyacrylamide gel. In consequence, only a subset of the mRNAs in a cell will be amplified by a particular pair of primers. With most pairs of primers, between 10 and 100 bands of amplified cDNAs, 100–500 nucleotides in length, are visible on the gel (Bauer et al. 1993; Liang et al. 1993).

Second, the amplification process in DD-PCR is essentially Darwinian in nature. Thus, only those mRNAs that are well-fitted for reverse transcription will be copied efficiently into cDNA. During the subsequent PCR, some of the resulting cDNAs will be more efficiently amplified than others. Over the course of 30 or more cycles of amplification, the population of cDNAs can be

expected to reduce in complexity as Darwinian selection works its will. The strength of selection will depend partly on the conditions used for PCR, partly on the degree of secondary structure in the mRNA, and its degree of complementarity to the arbitrary primer. An abundant mRNA that is poorly amplified may be underrepresented in the final population of cDNAs, whereas a minor RNA that is efficiently amplified may become vastly overrepresented. The population of amplified cDNAs may therefore bear little relationship to the population of mRNAs that engendered it.

Third, DD-PCR is both labor-intensive and expensive to perform. A typical screen using the original Liang and Pardee (1992) method involves setting up individual PCRs with all possible pairwise combinations of 16 5'-oligonucleotide primers and 12 3'-oligonucleotide primers, which works out to 192 separate PCRs (i.e.,  $12 \times 16 = 192$ ) for each mRNA population analyzed. If just two populations of mRNA are compared, then the number of PCRs doubles to 384, and since the reactions should be carried out in duplicate or triplicate to ensure reproducibility (Luce and Burrows 1998), the total number of PCRs increases to 768. Because each PCR is analyzed by electrophoresis on a single lane of a sequencing gel, at least 768 lanes are required to analyze all the reactions. A typical sequencing gel has 40 lanes, meaning that ~20 gels must be poured, run, dried, and subjected to autoradiography to generate the raw data for comparison. Finally, characterization of a cDNA product that exhibits differential expression is no small task. The cDNA band must be eluted from the sequencing gel, reamplified by PCR, subcloned into a plasmid, subjected to DNA sequencing, radiolabeled for use as a probe on an RNA blot to confirm the initial observation of differential expression, and eventually isolated as a full-length cDNA. Thereafter, the really hard work of identifying the physiological function of the encoded product begins. In addition to these concerns, DD-PCR has many other problems, some of which are listed below:

- More than half of the cDNAs that are identified as differentially expressed turn out to be false positives that cannot be confirmed by northern blotting or slot-blotting (e.g., please see Liang et al. 1993; Sager et al. 1993; Aiello et al. 1994; Li et al. 1994; Sun et al. 1994; Utans et al. 1994). It is possible that some of these phantom cDNAs may be derived from mRNAs that are expressed at very low levels in mammalian cells. However, this seems unlikely since differential display shows a strong overall bias toward abundant transcripts (Bertioli et al. 1995).
- The pattern of amplified bands changes when different preparations of RNA or different sources of *Taq* DNA polymerases are used (Haag and Raman 1994; Sompayrac et al. 1995; Sung and Denman 1997).
- Many repetitive sequences are identified as differentially expressed in most screens, and these are of little use in studying the biology of the system at hand.
- At least a portion of the mRNAs in the target cells is not amplified to high levels and is thus missed. These problems arise because of differences in the efficiency with which a given mRNA template is transcribed into cDNA and thereafter amplified. In addition, very short cDNA products and very long cDNA products are not well resolved on the sequencing gels and are thus overlooked.
- Many of the bands are doublets or closely spaced sets of three or four bands of equal intensity. Further analysis suggests that these families of bands correspond to the two complementary strands of the same fragment with or without dA, which is added by *Taq* polymerase at the 3' ends of completed DNA chains.
- About 25% of the bands can be reamplified solely by the arbitrary primer and not by the anchored primer (Welsh et al. 1992; Mou et al. 1994; McClelland et al. 1995; Jurecic et al. 1996; Graf et al. 1997; Guimaraes et al. 1997). These bands most likely arise as a consequence of amplification of internal sequences of the first-strand cDNA by the arbitrary primer.



- Some of the bands detected in DD-PCR are derived from introns or from sites far removed from the 3'-untranslated region of mRNAs. These problems are thought to arise from annealing of the anchoring primer to regions of the primary transcript that contain tracts of A residues (Luce and Burrows 1998).
- Cloning and sequencing show that many of the bands recovered from the gel contain a mixture of DNA fragments (Callard et al. 1994; Li et al. 1994). This result suggests that amplification by arbitrary primers may be promiscuous (Welsh et al. 1992) and may generate a background of DNA fragments that permeates the gel. Some investigators therefore recommend cloning the DNA eluted from gel and screening individual clones by northern, dot-blot, or slot-blot hybridization (Callard et al. 1994; Li et al. 1994).

## PRIMERS USED IN DD-PCR

---

### Anchored Primers

In the original description of this technique (Liang and Pardee 1992), the anchored (antisense) primer  $(T)_{11-12}XY$  was designed to be complementary to the poly(A) tail of mRNA and the last two nucleotides of the transcribed sequence.  $X$  may therefore be dG, dA, or dC and  $Y$  may be any one of the four deoxynucleotides. Because dT is not used in the penultimate position, there are 12 possible anchoring primers of this type, each having a different dinucleotide at the 3' end. Anchored primers with at least one G residue generate the largest number of amplified bands, whereas those ending in A or T are the least efficient (Mou et al. 1994).

A number of protocols have been published in which one (Wang et al. 1998), four (Liang and Pardee 1992), or three (Liang et al. 1994) anchored antisense primers have been used for DD-PCR instead of the original 12 (Liang and Pardee 1992; Bauer et al. 1994). In theory, reducing the number of anchored primers reduces the number of reactions that are required to achieve full coverage of the repertoire of mRNAs of a cell. However, reduction in the number of anchored primers also leads to an increase in the number of DD-PCR products generated in the reaction. Resolution of DNA bands sometimes deteriorates to the point where the bands cannot be adequately resolved.

Liang and Pardee (1992) calculate that 20 arbitrary decanucleotide 5' primers used in all possible pair-wise combinations with 12 anchoring primers of the sequence  $(T)_{11-12}XY$  would amplify the 3' termini of 10,000 different mRNA species. These estimates are based on the assumption that mRNAs are only copied into cDNAs when they form perfect hybrids with the anchoring 3' primer. However, there are strong indications that the penultimate 3' base of  $T_{12}XY$  primers can mispair with an mRNA template without greatly affecting the efficiency of reverse transcription (Liang et al. 1993). These results are depressing because the lack of specificity in the penultimate position effectively reduces the number of available anchoring primers. Since each of these primers generates between 10 and 100 resolvable bands on a gel when paired with any given 5' primer of arbitrary sequence, a "complete" display of the 3' termini of 10,000 mRNAs would require, as an absolute minimum, 60 different arbitrary 5' primers. Using a single "universal" anchoring primer (Wang et al. 1998) makes the problem even worse. In this case, a calculation suggests that a minimum of 200 arbitrary 5' primers would be required to obtain decent coverage of the mRNA population.

These calculations are only valid if each primer pair samples the same number of mRNAs with equal efficiency, if different cDNAs are amplified with equal efficiency, and if estimates of the number of mRNAs in a eukaryotic cell are accurate. The last of these assumptions is shaky, where-

as the first two are certainly wrong. Theoretical calculations therefore tend to overestimate — perhaps to a great extent — the depth of coverage that can be achieved by DD-PCR. In a given screen, the same differentially expressed mRNA can sometimes be identified with more than one primer pair. This could be interpreted to mean that the coverage of the mRNA population is deep enough to generate multiple hits on the same RNA molecule. However, we and others (Bertioli et al. 1995) find that clones identified by multiple hits tend to be derived from abundant mRNAs, suggesting that abundance can blur the already dubious specificity of primer pairs. The bands generated in DD-PCR may therefore reflect abundance, nucleotide sequence, or some amalgam of the two.

### Arbitrary Primers

Arbitrarily defined primers are at least ten nucleotides in length. They should be composed of equal numbers of AT and GC base pairs and should be predicted not to self-anneal or to form stem-loop structures. Arbitrary primers whose 5' dinucleotide is GC or CG generate the highest number of amplification products, and a G residue at the 3' terminus is also advantageous (Mou et al. 1994).

### Longer Arbitrary Primers

Longer arbitrary sense primers (25–28 mers) greatly increase the reproducibility of DD-PCR (Zhao et al. 1995). However, they also decrease the number of amplified bands detected by gel electrophoresis (Zhao et al. 1998). As the annealing temperature is increased, the stringency of primer annealing is also increased, leading to more specific and reproducible amplification of a smaller subset of cDNAs (Malhotra et al. 1998). The gain in specificity is achieved by reducing the number of cDNAs eligible for amplification.

## SUMMARY

---

The goal of DD-PCR is to display all of the mRNAs of a cell. In addition to the difficulties discussed elsewhere in this protocol, there are doubts about the power and specificity of the primer pairs. Until the problems that presently haunt differential display are solved, the future of the method will remain uncertain. Fortunately, new technologies are coming into use that offer alternative ways to trace the patterns of gene expression in cells. DNA arrays, for example, may be able to bypass many of the difficulties that have held up progress in this area for so long.

Differential display is a technique with high theoretical promise and many practical problems. The nature and dimensions of these problems are still not fully defined. Nevertheless, numerous improvements to the original technique have been reported over the years that have increased the efficiency with which differentially expressed genes can be identified and have decreased the amount of work required to identify these genes (e.g., please see Sompayrac et al. 1995; Zhao et al. 1995; Liang and Pardee 1997). This protocol, which incorporates some of these improvements, was provided by Charles P. Landrum (University of Texas Southwestern Medical Center, Dallas).

## MATERIALS

▲ **IMPORTANT** To reduce the chance of contamination with exogenous DNAs, prepare and use a special set of reagents and solutions for PCR only. Bake all glassware for 6 hours at 150°C and autoclave all plasticware. For more information, please see the panel on **CONTAMINATION IN PCR** in the chapter introduction. For an alternative approach to reagents, please see the panel on **DIFFERENTIAL DISPLAY KITS**.

**CAUTION:** Please see Appendix 12 for appropriate handling of materials marked with <!>.

### Buffers and Solutions

Please see Appendix 1 for components of stock solutions, buffers, and reagents. Dilute stock solutions to the appropriate concentrations.

*10x Amplification buffer*

*5x DD-PCR reverse transcriptase buffer*

250 mM Tris-Cl (pH 8.3)

375 mM KCl

15 mM MgCl<sub>2</sub>

Autoclave the 5x buffer for 10 minutes at 15 psi (1.05 kg/cm<sup>2</sup>) on liquid cycle. Divide the sterile buffer into aliquots. Store the aliquots at -20°C.

*Dithiothreitol (DTT) (100 mM)*

*dNTP solution (20 mM) containing all four dNTPs (pH 8.0)*

*Placental RNase inhibitor (20 units/ml)*

Please see the information panel on **INHIBITORS OF RNASES** in Chapter 7.

*5x Sequencing gel-loading buffer*

### Enzymes and Buffers

*Reverse transcriptase (RNA-dependent DNA polymerase)*

Please see the panel on **REVERSE TRANSCRIPTASES USED IN RT-PCR** in Protocol 8. For DD-PCR, a reverse transcriptase that is deficient in RNase H is required (e.g., Superscript from Life Technologies or StrataScript from Stratagene).

*Thermostable DNA polymerase*

Taq DNA polymerase is the standard and appropriate enzyme for the amplification stage of most forms of DD-PCR.

### Nucleic Acids and Oligonucleotides

*Anchoring 3' oligonucleotide primers (300 µg/ml) in 10 mM Tris-Cl (pH 7.6), 0.1 mM EDTA*

The anchoring 3' oligonucleotides are a family of 12 primers with the general structure 5'-d(T)<sub>12</sub>VN-3', where V is either C, A, or G, and N is C, T, A, or G. For example, one primer in the series is 5'-d(T)<sub>12</sub>CC-3', the next is 5'-d(T)<sub>12</sub>CT-3', etc.

Purify each oligonucleotide primer by chromatography on commercially available resins (e.g., NENSORB, NEN Life Science Products) or by denaturing polyacrylamide gel electrophoresis, as described in Chapter 10, Protocol 1.

*Arbitrary 5' oligodeoxynucleotide primers (50 µg/ml) in 10 mM Tris-Cl (pH 7.6), 0.1 mM EDTA*

Sixteen arbitrary 5' oligonucleotide primers are required, each ten nucleotides in length. The sequence of each primer is chosen at random, but it should contain approximately equal numbers of the four bases, with a balanced distribution of G and C residues, and a low propensity to form stable secondary structures.

Purify each oligonucleotide primer by chromatography on commercially available resins (e.g., NENSORB, NEN Life Science Products) or by denaturing polyacrylamide gel electrophoresis, as described in Chapter 10, Protocol 1.

*Total RNA (100 µg/ml)*

Total RNA extracted from cells with chaotropic agents is generally the template of choice for DD-PCR. RNAs to be compared by DD-PCR should be prepared in an identical fashion. Poly(A)<sup>+</sup> RNA is not ideal as a template in differential display because the methods used for isolation of Poly(A)<sup>+</sup> RNA often contaminate the preparation with significant amounts of oligo(dT) that can prime DNA synthesis at various points along the poly(A) tail, resulting in smearing of bands on the gel (Liang et al. 1995).

## Gels

*Agarose gel (1%)*

Please see Step 20.

*Electrolyte gradient sequencing gel*

For details on setting up this gel, please see Chapter 12, Protocol 10. Please see Steps 10 and 13.

## Radioactive Compounds

*Radiolabeled dATP (10  $\mu$ Ci/ $\mu$ l, sp. act. 3000 Ci/mmole) <!>*

DNA labeled with  $\alpha$ -<sup>35</sup>S or  $\alpha$ -<sup>33</sup>P generates sharper bands on autoradiographs than does DNA labeled with  $\alpha$ -<sup>32</sup>P.

## Special Equipment

*Barrier tips for automatic micropipettes*

*Microfuge tubes (0.5 ml, thin-walled for amplification) or Microtiter plates*

Use 96-well plates designed for use in a thermal cycler.

*Positive-displacement pipette*

*Thermal cycler programmed with desired amplification protocol*

If the thermal cycler is not equipped with a heated lid, use either mineral oil or paraffin wax to prevent evaporation of liquid from the reaction mixture during PCR.

*Water baths preset to 65°C and 94°C*

## Additional Reagents

*Steps 10 and 13 of this protocol require the reagents listed in Chapter 12, Protocols 10 and 11.*

*Step 22 of this protocol requires the reagents listed in Protocol 5 of this chapter.*

*Step 23 of this protocol requires the reagents listed in Protocol 12 of this chapter.*

*Step 24 of this protocol requires the reagents listed in Chapter 7, Protocol 8 or 11, and Protocol 15 of this chapter.*

### DIFFERENTIAL DISPLAY KITS

Several companies sell DD-PCR kits that contain control mRNAs, purified oligonucleotide primers, and appropriate instructions for programming a thermal cycler. The kits differ mainly in the sequences of the primers used in the PCRs, with some being similar to those described in the original Liang and Pardee study (1992). Other kits contain oligonucleotides that (1) reduce the complexity of the banding pattern, (2) increase the length of the PCR products obtained, and (3) facilitate subsequent analysis of the differential display products. Given the capricious nature of DD-PCR, this may be one of the few occasions when the purchase of a kit actually makes sense.

## METHOD

---

### Optimizing RNA Concentrations: Preparation of First-strand cDNAs

1. In sterile 0.5-ml microfuge tubes, set up a series of trial reactions to establish the optimum concentrations of "control" and "test" RNAs required to produce a pattern of 100–300 amplified cDNA bands after gel electrophoresis and autoradiography. Make fivefold serial dilutions in H<sub>2</sub>O of the RNA preparations to produce concentrations of between 1  $\mu$ g/ml and 100  $\mu$ g/ml.

2. Choose one or more primers from the collection of anchored 3' oligonucleotides and set up a series of annealing reactions that contain different amounts of diluted RNA templates:

template RNA	8.0 $\mu$ l
anchored 3' oligonucleotide primer	2.0 $\mu$ l

Incubate the reactions for 10 minutes at 65°C and then place them in a 37°C water bath.

The total amount of RNA in the annealing reactions should vary between 8 ng and 800 ng.

3. Add the following to the annealing reactions:

5x DD-PCR reverse transcriptase buffer	4 $\mu$ l
100 mM dithiothreitol	2 $\mu$ l
200 $\mu$ M solution of four dNTPs	2 $\mu$ l
~25 units/ $\mu$ l placental RNase inhibitor	0.25 $\mu$ l
200 units/ $\mu$ l reverse transcriptase	0.25 $\mu$ l
H <sub>2</sub> O	to 20 $\mu$ l

Incubate the tubes at 37°C for 1 hour.

A reverse transcriptase that is deficient in RNase H is required for DD-PCR (e.g., Superscript from Life Technologies or StrataScript from Stratagene).

To test for contaminating genomic DNA, set up one or more control reactions that contain no reverse transcriptase enzyme and carry these through Step 10 of the protocol. Contamination with genomic DNA is not usually a problem unless the RNA has been prepared from cells that are undergoing apoptosis or from tissue that is necrotic. If necessary, the RNA preparation can be treated with RNase-free DNase I either as a separate step during purification or in the same reaction tube that will later be used to synthesize cDNA (Dilworth and McCarrey 1992; Huang et al. 1996; please see the entry on DNase I in Appendix 4).

4. Inactivate the reverse transcriptase by incubating the reaction mixtures for 10 minutes at 94°C.

Steps 3 and 4 can be carried out in a thermal cycler programmed with a single cycle of 37°C for 1 hour/94°C for 10 minutes, followed by a 4°C hold.

### Optimizing RNA Concentrations: Preparation and Amplification of Double-stranded cDNAs

5. Set up two series of eight 0.5-ml amplification tubes. Each tube should contain:

10x amplification buffer	2 $\mu$ l
anchored 3' oligonucleotide primer	2 $\mu$ l
20 mM solution of four dNTPs (pH 8.0)	1 $\mu$ l
[ $\alpha$ - <sup>33</sup> P]dATP or [ $\alpha$ - <sup>35</sup> S]dATP (3000 Ci/mmol)	1 $\mu$ l
H <sub>2</sub> O	9 $\mu$ l
5 units/ $\mu$ l thermostable DNA polymerase	1 unit

To each tube, add 2  $\mu$ l of a different arbitrary 5' primer. Mix the contents by tapping the sides of the tubes.

Wherever possible, use the 10x amplification buffer supplied by the manufacturer of the *Taq* DNA polymerase.

6. Into one series of eight tubes, dispense ~3- $\mu$ l aliquots of the reverse transcriptase reaction containing the test RNA. Into the other series of eight tubes dispense ~3- $\mu$ l aliquots of the reverse transcriptase reaction containing the preparation of control RNA. Close the tubes and mix the contents gently.
7. If the thermal cycler is not fitted with a heated lid, overlay the reaction mixtures with 1 drop (~50  $\mu$ l) of light mineral oil. Place the tubes in the thermal cycler.

8. Amplify the nucleic acids using the denaturation, annealing, and polymerization times and temperatures listed in the table.

Cycle Number	Denaturation	Annealing	Polymerization
30 cycles	15 sec at 94°C	30 sec at 42°C	15 sec at 72°C
Last cycle	15 sec at 94°C	30 sec at 42°C	2 min at 72°C

These times are suitable for 20- $\mu$ l reactions assembled in thin-walled 0.5-ml tubes and incubated in thermal cyclers such as the Perkin-Elmer 9600 or 9700, Master Cycler (Eppendorf), and PTC 100 (MJ Research). Times and temperatures may need to be adapted to suit other types of equipment and reaction volumes.

Most thermal cyclers have an end routine in which the amplified samples are incubated at 4°C until they are removed from the machine. Samples can be left overnight at this temperature, but should be stored thereafter at -20°C.

9. At the end of the program, remove the tubes from the thermal cycler and add 5  $\mu$ l of 5x sequencing gel-loading buffer to each.
10. Separate the radiolabeled products of the reactions by electrophoresis through an electrolyte gradient polyacrylamide gel of the type used for DNA sequencing. Electrophoresis is carried at constant electrical power until the xylene cyanol tracking dye has migrated about two-thirds of the length of the gel (please see Chapter 12, Protocols 10 and 11). Dry the gel and expose it to autoradiographic film.
11. Examine the pattern of DNA bands arising from reactions containing different concentrations of control and test RNAs. A good differential display contains between 100 and 250 well-resolved bands. The optimum amount of template RNA varies from preparation to preparation and from one pair of primers to another. Select the concentration of test and control RNAs that work well with the largest number of primer pairs.

### Preparation of Amplified cDNAs for Differential Display

12. Repeat the annealing, reverse transcriptase, and amplification reactions using all combinations of primer pairs and the optimum amount of RNA templates. Set up the reactions in 96-well microtiter plates designed for use in a thermal cycler.
13. Separate the products of the amplification reactions by electrophoresis through polyacrylamide sequencing gels, as in Steps 9 and 10.

Load the reactions generated with each primer pair in adjacent lanes on the gel, i.e., load the reaction obtained with primer pair A + B from one RNA preparation next to the reaction obtained with primer pair A + B from the other RNA preparation. Ordering samples in this way greatly simplifies comparison of the autoradiographic patterns.

14. Compare the patterns of bands obtained with each primer pair from the different RNA populations.

When a differentially expressed band is identified, it is advisable to repeat the experiment to make sure that the initial finding is reproducible. Ideally, different batches of the two RNAs should be used, although this precaution may not always be practicable.

### Recovery and Reamplification of the Differentially Displayed cDNAs

15. Recover target bands from the dried polyacrylamide gel. Lay the autoradiogram on top of the gel and use a soft pencil to lightly mark the position of the desired band on the autoradiogram. Cutting through the autoradiogram with a clean razor blade, excise each target band and the attached Whatman 3MM paper. Soak each sliver of dried gel/paper overnight at room temperature in a separate 0.5-ml microfuge tube containing 50  $\mu$ l of sterile H<sub>2</sub>O.

16. Puncture the bottom of each 0.5-ml tube with a small-gauge needle. Place each punctured tube inside a 1.5-ml microfuge tube. Centrifuge the tubes for 20 seconds to transfer the eluate to the larger tube. Discard the amplification tube containing the residue of the Whatman 3MM paper and polyacrylamide.

17. Amplify the eluted fragment in a reaction containing the following:

10x amplification buffer	2 $\mu$ l
DNA eluted from polyacrylamide gel	3 $\mu$ l
arbitrary 5' oligonucleotide primer	2 $\mu$ l
anchoring 3' oligonucleotide primer	2 $\mu$ l
20 mM solution of four dNTPs (pH 7.0)	1 $\mu$ l
H <sub>2</sub> O	9.5 $\mu$ l
5 units/ $\mu$ l <i>Taq</i> thermostable DNA polymerase	2 units

To facilitate cloning of the DNA fragment, use a thermostable DNA polymerase such as *Taq* that places a dA residue at the 3' end of the amplified DNA. Wherever possible, use the 10x amplification buffer supplied by the manufacturer of the *Taq* DNA polymerase.

18. If the thermal cycler is not fitted with a heated lid, overlay the reaction mixtures with 1 drop (~50  $\mu$ l) of light mineral oil. Place the tubes in a thermal cycler.

19. Amplify the nucleic acids using the denaturation, annealing, and polymerization times and temperatures listed in the table.

Cycle Number	Denaturation	Annealing	Polymerization
30 cycles	15 sec at 94°C	30 sec at 42°C	15 sec at 72°C
Last cycle	15 sec at 94°C	30 sec at 42°C	2 min at 72°C

Polymerization should be carried out for 1 minute for every 1000 bp of length of the target DNA.

Most thermal cyclers have an end routine in which the amplified samples are incubated at 4°C until they are removed from the machine. Samples can be left overnight at this temperature, but should be stored thereafter at -20°C

20. Estimate the concentration of the reamplified DNA fragment by electrophoresis of 5–10% of the reaction through a 1% (w/v) agarose gel.

21. If mineral oil was used to overlay the reaction (Step 18), remove the oil from the sample by extraction with 150  $\mu$ l of chloroform.

The aqueous phase, which contains the amplified DNA, will form a micelle near the meniscus. The micelle can be transferred to a fresh tube with an automatic micropipette.

**▲ IMPORTANT** Do not attempt chloroform extractions in microtiter plates. The plastic used in these plates is not resistant to organic solvents.

22. Ligate the DNA into a vector that has been tailed with dT (e.g., pGEM T vector from Promega) (please see Protocol 5) and transform *E. coli* with aliquots of the ligation reaction.

23. Isolate plasmid DNA from six or more recombinants and compare the sizes of the inserts released by restriction enzyme digestion.

The sequence of the insert DNA can be established by using universal primers that bind to the flanking regions of the vector. These oligonucleotides can also be used as primers to check the size of the inserts by PCR (please see Protocol 12).

It is important to isolate and sequence more than one plasmid recombinant from the ligation reaction because there may have been more than one DNA fragment in the slice excised from the gel. Compare the cDNA sizes and sequences to each other and to those in the various databases.

24. Confirm the differential expression of a candidate cDNA/mRNA in as many ways as possible, including northern hybridization (Chapter 7, Protocol 8), RNase protection (Chapter 7, Protocol 11), or quantitative PCR (Protocol 15 of this chapter). In situ mRNA hybridization can be used to localize the transcript to a diseased or developing tissue.

To increase the chances of success with DD-PCR:

- Focus on cDNA products that show all-or-none differences in their expression patterns in the mRNA populations being compared. Apparent quantitative differences in expression are frequently the result of artifacts and vagaries of PCR or idiosyncrasies of sampling. Many all-or-none differences, however, turn out to be real, i.e., they can be confirmed by independent methods such as northern hybridization.
- Wherever possible, isolate the RNA used for DD-PCR from pure cell populations. Consistent patterns of differential gene expression can be obtained by comparing RNAs isolated from cultured mammalian cells derived from a single cell type (e.g., epithelia). Most tissues are dynamic and complex and may respond to physiological changes by altering the ratio of one cell type to another. This response may appear in DD-PCR as a change in the apparent abundance of mRNAs, but in reality, it is not. The same caveat holds when comparing normal and cancerous tissues because most tumorigenesis involves transformation of a single cell type, followed by expansion and rapid evolution of the population.
- Just about any insult to cells leads to differential expression of repetitive sequences in the genome, including transposable elements, SINE and LINE sequences, endogenous retroviruses, and other assorted repetitive DNAs. In most instances, it will prove extremely difficult to relate the expression of such sequences to the biology or pathology being studied. Amplification of repetitive DNA sequences can also be substantially reduced by ensuring that the starting mRNA sample is free from contamination by trace amounts of genomic DNA (please see the entry on DNase I in Appendix 4).
- Ignore/discard all cDNAs identified by DD-PCR that do not produce a signal on a northern blot or in an RNase protection assay. The origin(s) of these DNAs is unknown. Perhaps they come from low abundance mRNAs, from introns, or from fragments of genomic DNA that contaminate the preparations of RNA. Whatever their provenance, the differential expression of these RNAs cannot be confirmed and there is no reason to study them further.

*By the glare of false science betray'd,  
That leads to bewilder, and dazzles to blind.*

James Beattie 1735–1803. *The Hermit*

*I can forgive Alfred Nobel for having invented dynamite, but only a fiend in human form could have invented the Nobel Prize.*

George Bernard Shaw



---

**MULTIPLEX PCR**

---

Multiplex PCR is the term used when more than one pair of primers is used in a polymerase chain reaction. The goal of multiplex PCR is to amplify several segments of target DNA simultaneously and thereby to conserve template DNA, save time, and minimize expense. The yield of each amplified product is reduced in proportion to the number of primer pairs included in the reaction. However, as a general rule, up to eight primer pairs can be used simultaneously in a standard PCR before the yield of each amplified product is reduced to the point of invisibility on an agarose gel.

Unfortunately, multiplex PCR is very tricky to set up. Great care must be taken to ensure that all of the primers in the reaction have approximately the same melting temperature, that the primers are unlikely to interact with one another, and that the amplified products are of approximately the same size but can be unambiguously distinguished from one another by gel electrophoresis. The multiplex reaction must then be optimized as follows.

- Check that all target loci can be amplified efficiently in separate reactions using the same PCR program.
- Titrate the amount of each primer pair to achieve maximum amplification in separate reactions using the same PCR program and reaction conditions.
- Balance the amount of each primer pair in the multiplex reaction to achieve acceptable amplification of all target regions.

The last requirement usually causes the most problems. Frequently, one or two regions of the target DNA yield little or no amplified product, whereas all other primer pairs behave perfectly. The best option is to increase progressively the concentration of the recalcitrant primer pairs while reducing the concentration of the well-behaved primer pairs. Consider adjusting the reaction conditions only if this strategy fails; for example, alter the concentrations of  $Mg^{2+}$  or KCl in the reaction mixture. However, if the yields of the multiplex reaction are systematically biased in favor of longer PCR products, the best option is to reoptimize the amount of each primer pair in a series of multiplex reactions containing increased concentrations of KCl (1.0–2.0-fold) and a constant concentration of  $Mg^{2+}$  (1.5 mM). Conversely, if the yields are biased in favor of smaller PCR products, increase the concentration of Mg progressively (up to 4.5 mM) while maintaining a constant concentration of KCl.

If all of the products are poorly amplified, try increasing the concentration of template and thermostable DNA polymerase. If no improvement is noted, increase the concentration of all primer pairs by a factor of 2 and use a touchdown program in which the annealing and extension temperatures are decreased in 2°C intervals (please see the information panel on **TOUCHDOWN PCR**).

If nonspecific amplification is a problem, try to identify the guilty primer pairs by setting up another series of amplification reactions each containing only one primer pair. If a particular primer pair can be identified, redesign both primers. Alternatively, if no particular primer pair can be identified, consider the possibility that nonspecific amplification may be the result from synthesis primed with the forward primer of one pair and the reverse primer of another. The best way to unravel this situation is to set up a series of multiplex PCRs, each lacking one primer pair. By a process of elimination, it is usually possible to find out which combinations of primer pairs are responsible for nonspecific amplification.

**TAQ DNA POLYMERASE**

- *Taq*, a thermostable DNA-dependent DNA polymerase, was first isolated from the thermophilic eukaryote *Thermus aquaticus* in 1976 (Chien et al. 1976; Kaledin et al. 1980). Some years later, the enzyme became famous for its use in PCR (Saiki et al. 1988) and was designated in 1989 as Molecule of the Year (Koshland 1989), for whatever that may mean.
- The gene for *Taq* (Lawyer et al. 1989) encodes an 832-amino-acid protein ( $M_r = 93.9$  kD) consisting of two domains. The amino-terminal region (residues 1–290) is similar in sequence and structure to the 5'→3' exonuclease domain of members of the polymerase I family of DNA polymerases (including *E. coli* DNA polymerase I and related bacteriophage-encoded polymerases) (Gutman and Minton 1993). The properties of the 5'→3' exonuclease are described by Longley et al. (1990). The carboxy-terminal domain contains a catalytically inactive 3'→5' exonuclease (residues 294–422) and a polymerase subdomain of *Taq* (residues 424–831), whose structure is very similar to that of the Klenow fragment of *E. coli* DNA polymerase I. The residues critical for catalytic activity are conserved in both polymerases (for reviews, please see Joyce and Steitz 1994, 1995; Pelletier 1994; Perler et al. 1996).
- The thermal stability of *Taq* DNA polymerase is thought to result from increased hydrophobicity of the core of the enzyme, improved stabilization of electrostatic forces, and enhanced interaction with solvent molecules, due to the presence of additional proline residues on the surface of the enzyme (Kim et al. 1995; Korolev et al. 1995).
- The enzyme originally isolated by Chien et al. (1976) was smaller than the full-length *Taq* protein, had slightly different catalytic properties, and in all probability was a proteolytic fragment that lacked part of the amino-terminal domain. In *T. aquaticus*, *Taq* polymerase is expressed at such low levels (0.01–0.02% of the cellular protein) that commercial production is not a viable proposition. These days, the enzyme is produced from versions of the *Taq* gene that have been engineered so as to obtain high levels of expression in *E. coli*. Most of these alterations involve modification of the DNA sequences that precede and immediately follow the initiating ATG codon (e.g., please see Engelke et al. 1990; Lawyer et al. 1993; Ishino et al. 1994; Desai and Pfaffle 1995). Since the clones used by various commercial manufacturers may have been engineered in different ways and since the protocols used for purification of the enzyme may also be different, preparations obtained from different manufacturers do not necessarily deliver identical results. However, homemade *Taq* polymerase, which is simple to prepare (Engelke et al. 1990; Pluthero 1993; Desai and Pfaffle 1995), is consistently of high quality and shows little batch to batch variation. Preparations of *Taq* DNA polymerase typically display the following properties:

Optimal reaction temperature: 75–80°C

Optimal reaction conditions: 1.5 mM MgCl<sub>2</sub>, 50–55 mM KCl (pH 7.8–9.0)

$K_m$  dNTPs: 10–15 μM

$K_m$  DNA: 1.5 nM

Extension rates (dNTPs/sec/enzyme molecule):

75°C	150
70°C	<60
55°C	24
37°C	1.25
22°C	0.25

Processivity (dNTPs/sec/enzyme molecule): 42

Half-life of enzyme:

97.5°C	5–6 minutes
95°C	40 minutes
92.5°C	130 minutes

Error rates: Error rates ranging from  $8.9 \times 10^{-5}$  to  $1.1 \times 10^{-4}$  have been reported by various groups over the years. For more details, please see posting by Paul Hengen (1995b) on the newsgroup [bionet.molbio.methods-reagnts](mailto:bionet.molbio.methods-reagnts).

- To initiate DNA synthesis, *Taq* polymerase, like other DNA polymerases, requires a primer that is annealed to the template strand and carries a hydroxyl group at its 3' end (please see Primers in the introduction to Protocol 1). During the extension reaction in vitro, *Taq* polymerase removes oligonucleotides carrying a 5'-hydroxyl group that are annealed to the template strand ahead of the growing strand. However, 5'-phosphorylated oligonucleotides cannot be displaced from the template strand of DNA by *Taq* polymerase. The enzyme is not able to continue synthesis when it encounters a depurinated base in the template. Depurination occurs at a significant rate when DNA is incubated at high temperatures, which may place limits on the length of DNA that can be amplified by *Taq* polymerase (Barnes 1994).
- All essential metal-binding sites in the amino-terminal 3'→5' exonuclease subdomain of *Taq* have been eliminated by mutation (Kim et al. 1995; Korolev et al. 1995). Because of the lack of a proofreading function, the rate of misincorporation of dNTPs is high in PCRs catalyzed by *Taq* (or by other thermostable DNA polymerases that also lack an editing function) (Tindall and Kunkel 1988). More than 50% of the DNA molecules produced after 25 cycles of *Taq*-driven amplification of a 200-bp fragment can be expected to carry mutations of one sort or another.

- During the past years, the enzymatic and physical properties of *Taq* have been summarized by many reviewers, including Cha and Thilly (1993), Bej and Mahbubani (1994), Perler et al. (1996), and Fanning and Gibbs (1997). These reviews provide comprehensive lists of primary references from which the data in this information panel are derived.
- A number of commercial preparations of *Taq* are available that lack 5'→3' exonuclease activity. These include the Stoffel fragment (Perkin-Elmer), a number of deletion variants, and a number of site-directed mutants (Merkens et al. 1995). In general, these enzymes are less efficient and less processive than *Taq*.
- The cloned gene for *Taq* DNA polymerase I of *T. aquaticus* strain YT-1 is available from ATCC (40336). The pros and cons of isolating and purifying *Taq* polymerase for in-house use are discussed in intelligent articles by Sederoff (1993) and Hengen (1995b). Hoffman-La Roche Inc. currently has legal rights over PCR and *Taq* (U.S. Patents #05352600 and #4889818). However, this position may change in the future because Hoffman-La Roche's claims are under challenge. Many investigators have in the past been wary of purifying their own *Taq* because of the uncertainty about what they can and cannot do without running afoul of the patent law. However, there are several Internet sites that offer useful information on this topic, e.g., <http://www.promega.com>. The history of the patent disputes between Hoffman-La-Roche, Cetus Inc., and Promega is recounted in News and Views articles by Dickson (1994, 1996) and Abbott (1996).

---

**HOT START PCR**

---

Hot start is a method to optimize the yield of the desired amplified product in polymerase chain reactions and, simultaneously, to suppress nonspecific amplification. This is done by withholding an essential component of the PCR — the DNA polymerase or  $Mg^{2+}$ , for example — until the reaction mixture has been heated to a temperature that inhibits nonspecific priming and primer oligomerization.

In the first description of hot start PCR (D'Aquila et al. 1991; Erlich et al. 1991; Mullis 1991), template DNA and primers were mixed together and held at a temperature above the threshold of nonspecific binding of primer to template. All of the components necessary for the extension phase of the PCR were then added except the thermostable polymerase. Thermal cycling was initiated after the final addition of the DNA polymerase to the preheated reaction mixture. The elimination of the warm-up phase preceding the first cycle of PCR reduced the opportunities for nonspecific annealing of oligonucleotide primers, whereas the absence of DNA polymerase activity prevented extension of mismatched primers.

The original method was difficult because the reaction mixtures were assembled in tubes whose temperature was maintained by a heating block. These days, hot start PCR is more easily accomplished. The most popular method involves creating a physical barrier of wax between components of the reaction. For example, the primers,  $Mg^{2+}$ , dNTPs, and buffer can be mixed at room temperature in the bottom of the reaction tube and then covered with melted wax (e.g., Ampliwax PCR Gems from Perkin-Elmer or a commercial wax that melts at low temperature [melting point = 53–55°C]). The wax solidifies on cooling and confines the reagents to the bottom of the tube. The remaining components of the reaction are then mixed on top of the wax barrier. During the denaturation step of the first cycle of PCR, the wax barrier melts, allowing the components of the reaction to merge. The melted wax floats to the top of the reaction mixture where it now acts as a barrier to evaporation.

More esoteric variants of hot start PCR include the use of neutralizing monoclonal antibodies to inhibit polymerase activity during the assembly and warm-up phase of the reactions. When the temperature increases, the antibody dissociates from the enzyme and is inactivated during the denaturation step of the first cycle of PCR (Kellogg et al. 1994). Polymerase-antibody complexes are sold by several companies including CLONTECH (TaqStart and tThStart) and Life Technologies (Platinum *Taq* Polymerase). A similar idea is used by Perkin-Elmer, whose enzyme, AmpliTaq Gold, requires heating to ~93°C for ~10 minutes during a specially programmed first cycle of PCR to become fully active (Birch et al. 1996; Kebelmann-Betzing et al. 1998). In another variation,  $Mg^{2+}$  embedded in wax beads (HotWax Beads) is released into the reaction mixture as the wax melts. The manufacturer, Invitrogen, claims that the absence of  $Mg^{2+}$  during the initial warm-up phase of the reaction significantly reduces nonspecific priming. HotWax Beads are sold in several formulations that provide predetermined concentrations of  $Mg^{2+}$  for PCRs of standard volume.

Hot start PCR is not essential in optimized simple PCRs that contain a single pair of well-designed oligonucleotide primers and generate high yields of a specific amplified product. However, the method comes into its own when nonspecific amplification is a problem — for example, when fewer than  $10^4$  copies of template DNA are present in the reaction, when the template DNA is highly complex (e.g., mammalian genomic DNA), or when PCRs contain several pairs of oligonucleotides (multiplex PCR). In all of these cases, hot start PCR is best used in conjunction with a “touchdown” protocol (please see the information panel on **TOUCHDOWN PCR**).

---

## RIBONUCLEASE H

---

Ribonuclease H (RNase H) catalyzes the endonucleolytic degradation of the RNA moiety of DNA-RNA hybrids, generating oligoribonucleotides, of varying chain lengths with 3'-hydroxyl and 5'-phosphate termini. It was first recognized and isolated from calf thymus (Stein and Hausen 1969; Hausen and Stein 1970), but it is now known to be present in a wide variety of mammalian tissues, yeasts, prokaryotes, and virus particles. Many types of cells contain more than one RNase H.

In many retroviruses, RNase H is associated with the multifunctional enzyme reverse transcriptase and carries out important functions at several stages during the transcription of the viral genome into DNA. In eubacteria, it is believed to be required for the removal of RNA primers from Okazaki fragments, for processing of transcripts into primers used by DNA polymerase I to initiate DNA synthesis, and to remove R-loops that provide sites for opportunistic initiation of unregulated DNA synthesis at the chromosomal origin of replication in *E. coli*. RNase H is presumed to carry out similar functions in eukaryotic cells.

RNase H has been reported to increase markedly the inhibition of gene expression by antisense oligodeoxynucleotides. Hybrids between these oligonucleotides and specific sequences in mRNAs are sensitive to degradation by the enzyme. RNase H is required for initiation of replication at the origin (*ori*) of colicin E1 (*colE1*)-type plasmids in vitro. The enzyme also seems to suppress initiation of DNA synthesis at sites other than *ori*.

X-ray crystallographic analysis shows that *E. coli* RNase H consists of two domains, one of which contains an Mg<sup>2+</sup>-binding site enmeshed in  $\beta$ -strands — a fold previously recognized in DNase I. For further information and references, please see Crouch (1990), Wintersberger (1990), Hostomsky et al. (1993), Jung and Lee (1995), Kanaya and Ikehara (1995), Rice et al. (1996), and Crooke (1998).

---

## TERMINAL TRANSFERASE

---

Terminal deoxyribonucleotidyl transferase, Tdt, a monomeric enzyme of ~510 amino acids, catalyzes the addition of dNTPs to the 3' termini of DNA molecules (for review, please see Bollum et al. 1974). Of the several enzymes that are capable of this type of template-independent DNA synthesis, terminal transferase is by far the most efficient: Whereas DNA polymerases such as the Klenow fragment of *E. coli* DNA polymerase and *Taq* have the ability to add single nucleotides to DNA substrates, terminal transferase can, under the right conditions, catalyze the addition of hundreds of nucleotides.

In molecular cloning, terminal transferase is now used chiefly to catalyze the addition of homopolymeric tails to single-stranded DNAs generated in 5'-RACE and 3'-RACE reactions. The enzyme was in considerably greater demand a few years ago when cDNAs were routinely equipped with dG tails and cloned into dC-tailed plasmid vectors. This tailing was always a messy reaction, difficult to control, since the kinetics of the tailing reaction are wonderfully odd, and often disastrous, and since the early commercial preparations of the enzyme were often contaminated with both endo- and exonucleases.

Homopolymeric tailing follows entirely predictable kinetics when all substrates are present in the reaction at high concentrations and when all termini are identical. However, when faced with a set of heterogeneous 3' termini, the enzyme will first catalyze the rapid tailing of molecules carrying 3'-unpaired extensions, then blunt-ended molecules, and finally, with great reluctance, molecules with recessed 3' termini. In the case of blunt-ended molecules, the crucial rate-limiting step is the addition of the first nucleotide: Blunt ends that are clamped shut by G:C base pairs are poor substrates, whereas blunt ends rich in A:T are more permissive and are tailed more rapidly and synchronously. If the enzyme finds a blunt-ended molecule with a frayed 3' terminus and catalyzes the addition of a single nucleotide, subsequent elongation of the homopolymeric tail will proceed rapidly. The more heterogeneous the population of termini, the more quirky and asynchronous the kinetics of the tailing reaction.

Terminal transferase has strange requirements. It is inhibited by many of the cations routinely included in reaction buffers, including ammonium, chloride, and phosphate ions (for review, please see Bollum 1974). Most reactions are carried out in cacodylate (dimethyl arsenic acid) buffers (Kato et al. 1967), although 100 mM Tris-acetate (pH 7.2) is almost as good. Homopolymeric tailing reactions that use dTTP or dCTP as substrates are carried out in the presence of Co<sup>2+</sup>; Mn<sup>2+</sup> is the preferred cofactor for homopolymeric tailing reactions involving polymerization of purine residues.

Terminal transferase is expressed in pre-B and pre-T lymphocytes and is routinely used as a marker for certain types of leukemia arising from these cells. During maturation of the immune system, TdT mediates the expansion and diversification of the T-cell receptor repertoire by adding template-independent nucleotides and disrupting homology-directed recombination (for review, please see Gilfillan et al. 1995). For reviews of the molecular biology and enzymology of terminal transferase, please see Chang and Bollum (1986).

---

## TOUCHDOWN PCR

---

Touchdown PCR is a simple method to optimize yields of amplified DNA when the melting temperature of hybrids between the oligonucleotide primers and their target sequences is not known with certainty, for example:

- when the primers have been designed from amino acid sequences
- when amplifying members of a multigene family
- when the template DNA is extremely complex and occupies a large sequence space
- when amplifying DNA from a species other than that for which the primers were designed
- when using primers containing "universal" bases such as inosine.

In all of these circumstances, mismatches between the oligonucleotide primers and the template DNA can be anticipated, with the potential to generate undesirable nonspecific amplification products. Because neither the number, the location, nor the type of these mismatches is known, it is not possible to calculate from first principles an annealing temperature that will maximize the yield of the desired amplification product while minimizing nonspecific priming. Instead, the optimum annealing temperature must be determined empirically.

One method of optimization involves setting up a series of PCRs that are annealed at different temperatures but are identical in all other respects. However, this type of experiment is both laborious and inefficient unless a special type of thermal cycler (e.g., Stratagene's Robocycler) is available. For most investigators, a better alternative is touchdown PCR (Don et al. 1991; Peterson and Tjian 1993; Roux 1995; Hecker and Roux 1996; Roux and Hecker 1997), in which a range of annealing temperatures are utilized in a single PCR. In touchdown PCR, the annealing temperature during the first two cycles of amplification is set  $\sim 3^{\circ}\text{C}$  above the calculated melting temperature of a perfect hybrid formed between the most GC-rich oligonucleotide primer in the reaction and its target DNA. The annealing temperature is then reduced by one centigrade degree for each pair of subsequent cycles. At some point, a temperature permissive for specific priming will be reached and amplification of the target sequence will begin. The onset of nonspecific amplification will be delayed for several additional cycles until the annealing temperature has been lowered to the point where nonspecific priming can occur. However, by this time, the specific amplification product will have hegemony over the reaction and will effectively suppress the accumulation of nonspecific amplification products. In theory, a perfectly matched primer-target hybrid will have a 1024-fold advantage over mismatched hybrids whose melting temperature is  $5^{\circ}\text{C}$  lower. Touchdown PCR therefore gives a selective advantage to amplification products generated from correctly primed reactions. In our laboratory, touchdown PCR is the quickest method to optimize PCRs when using new combinations of oligonucleotides and templates, and it, together with hot start PCR or the addition of GC-Melt, is a remedy of first resort when faced with problems such as inefficient priming, mispriming, and formation of primer-dimers.

Modern thermal cyclers such as MJ Research model PTC 100, Perkin-Elmer model 9600, and Master Cycler (Eppendorf) are easily programmed to accommodate touchdown PCR. However, in some types of basic thermal cyclers, programming of a progressive reduction of annealing temperature becomes a nightmare. Individual files for each pair of cycles must be serially linked into a series using extensive commands, a process that is laborious and utilizes large amounts of programming space. A possible compromise is to use fewer but steeper temperature steps to link the initial and final annealing temperatures (Roux 1995; Hecker and Roux 1996). In either case, touchdown PCR works best in conjunction with techniques such as hot start PCR or booster PCR which limit the opportunities for both nonspecific binding between oligonucleotide primers and the template DNA and for formation of primer dimers (please see the information panel on **HOT START PCR**).

---

**USE OF INOSINE IN DEGENERATE POOLS OF OLIGONUCLEOTIDES USED FOR PCR**


---

Below is a list of recommended codons for designing oligonucleotides that are to be used for screening primate cDNA or mammalian cDNA libraries and that contain inosine at positions of ambiguity. The recommendations take into account the natural usage of codons in human genes and the fact that the sequence CpG is underrepresented in human DNA.

Amino Acid	Codon
A (Ala)	GCI
C (Cys)	TGC <sup>a</sup>
D (Asp)	GAT
E (Glu)	GAI
F (Phe)	TTC <sup>a</sup>
G (Gly)	GGI
H (His)	CAC <sup>a</sup>
I (Iso)	ATI
K (Lys)	AAI
L (Leu)	CTI <sup>c</sup>
M (Met)	ATG
N (Asn)	AAC <sup>a</sup>
P (Pro)	CCI
Q (Gln)	CAI
R (Arg)	CGI <sup>c</sup>
S (Ser)	TCC <sup>b,c</sup>
T (Thr)	ACI
V (Val)	GTI
W (Trp)	TGG
Y (Tyr)	TAC <sup>a</sup>

<sup>a</sup>If the first nucleotide of the succeeding codon is G, use T in the third position.

<sup>b</sup>If the first nucleotide of the succeeding codon is G, use I in the third position.

<sup>c</sup>Try to avoid amino acids with six codons if at all possible.

---

**UNIVERSAL PRIMERS**


---

Universal primers are synthetic oligonucleotides that anneal to one side or the other of cloning sites in plasmid, phagemid, bacteriophage  $\lambda$ , and bacteriophage M13 vectors. These primers may be used to amplify by PCR or to sequence by the dideoxy method any segment of foreign DNA that has been cloned into these sites. In addition to conventional single-stranded templates, universal primers can be used in sequencing protocols that have been optimized for double-stranded DNA templates.

Universal primers are commercially available for a great variety of vectors. The lists of primers provided in the following tables, which are by no means comprehensive, cover only the most popular standard vectors. We recommend that investigators who wish to amplify or to sequence inserts cloned into more esoteric vectors, particularly commercial expression vectors, to read the relevant catalogs. Most responsible companies now sell universal primers for use with their own specialized vectors.

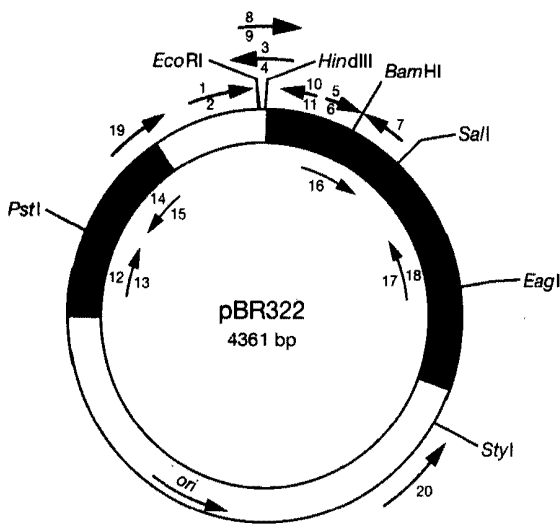
**Primers for Cloning Sites in pBR322**

Table 8-6 provides a list of primers that can be used for amplifying or for sequencing target DNAs cloned into pBR322. The accompanying figure (Figure 8-11) illustrates the locations of the sites corresponding to these primer sequences on the plasmid. These primers, which were originally developed in Bruce Wallace's laboratory (Wallace et al. 1981) are sold by New England Biolabs, from whose catalog the figure is reproduced.

**TABLE 8-6 Primers for pBR322**

CLONING SITE	CODE	DIRECTION OF PRIMING	SEQUENCE OF PRIMER
<i>EcoRI</i>	1	clockwise	5'd(GTATACGAGGCCCT)3'
<i>EcoRI</i>	2	clockwise	5'd(CCTATAAAAATAGGCGTATCAGGAGGCCCT)3'
<i>EcoRI</i>	3	counterclockwise	5'd(GATAAGCTGTCAAAC)3'
<i>EcoRI</i>	4	counterclockwise	5'd(TTAAAGCTTATCGATGATAAGCTGTCAAAC)3'
<i>BamHI</i>	5	clockwise	5'd(CACTATCGACTACGCGATCA)3'
<i>BamHI</i>	6	clockwise	5'd(TACTTGGAGCCACTATCGACTACGCGATCA)3'
<i>BamHI</i>	7	counterclockwise	5'd(ATGCGTCCGGCGTAGA)3'
<i>HindIII</i>	8	clockwise	5'd(GACAGCTTATCATCG)3'
<i>HindIII</i>	9	clockwise	5'd(AGAATTCTCATGTTTGACAGCTTATCATCG)3'
<i>HindIII</i>	10	counterclockwise	5'd(GCAATTTAACTGTGAT)3'
<i>HindIII</i>	11	counterclockwise	5'd(GCCTGACTGCGTTAGCAATTTAACTGTGAT)3'
<i>PstI</i>	12	clockwise	5'd(GCTAGAGTAAGTAGTT)3'
<i>PstI</i>	13	clockwise	5'd(ATTGTTGCCGGAAGCTAGAGTAAGTAGTT)3'
<i>PstI</i>	14	counterclockwise	5'd(AACGACGAGCGTGAC)3'
<i>PstI</i>	15	counterclockwise	5'd(AATGAAGCCATACCAAACGACGAGCGTGAC)3'
<i>SalI</i>	16	clockwise	5'd(ATGCAGGAGTCGCAT)3'
<i>SalI</i>	17	clockwise	5'd(CTGGGCTGCTTCCTAATGCAGGAGTCGCAT)3'
<i>SalI</i>	18	counterclockwise	5'd(AGTCATGCCCCGCG)3'
<i>SspI</i>	19	clockwise	5'd(GGAAATGTTGAATACTC)3'
<i>SlyI</i>	20	counterclockwise	5'd(GCTGGAGATGGCGGACGC)3'

For primer map positions, please see the corresponding codes in Figure 8-11. Modified, with permission, from New England Biolabs, Inc. (©1998/99 New England Biolabs Catalog, pp. 118–119).



**FIGURE 8-11 Positions of Synthetic Primers Used to Determine the Sequence of DNA Cloned into Various Sites of pBR322**

For specific primer sequences, please see Table 8-6. (Modified, with permission, from New England Biolabs [©1998/99 New England Biolabs Catalog, p. 118].)



**Primers for Cloning Sites in Bacteriophage M13/pUC Vectors**

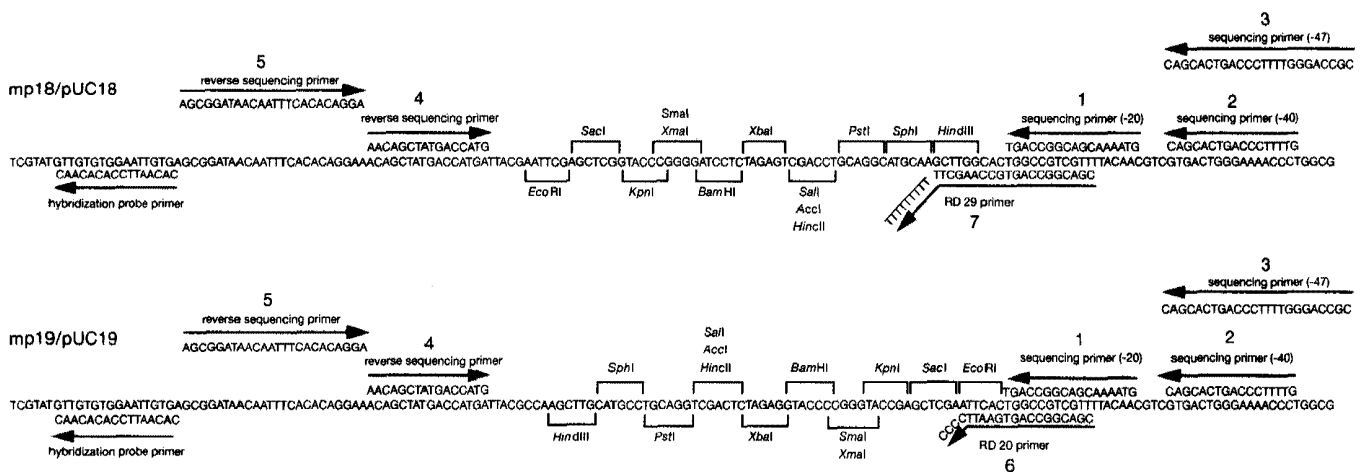
Table 8-7 provides a list of primers that can be used for amplifying or for sequencing target DNAs cloned into M13/pUC vectors. The accompanying figure (Figure 8-12) illustrates the alignments of these primer sequences along the bacteriophage or plasmid sequence. These primers are sold by New England Biolabs, from whose catalog the figure is reproduced.

A report published in *Nucleic Acids Research* describes a pUC18 variant that is present in many laboratories (Lobet et al. 1989). The mutation consists of a deletion of the cytosine nucleotide from the second codon of the *lacZ* gene, just upstream of the polylinker region. Difficulties arise when sequencing with primers that overlap this mutation. DNA sequencing with this pUC18 mutant with New England Biolabs' reverse sequencing primer 1201, a 16-mer whose 3' end overlaps the mutation, has been difficult even when using conditions of low stringency. To avoid any problems, NEB recommends using the reverse sequencing primer 1233, a 24-mer located immediately upstream (5') of the position of primer 1201. Primer 1201 can still be used with all similar *lacZ* vectors, including M13 vectors and other pUC vectors for which this deletion has not been found. A forward primer (5'GGITTTCCCAGTCACGACG) that binds to bacteriophage M13/pUC vectors at a region ~40 nucleotides upstream of the polylinker has been reported to prime spuriously from a site in the vector sequences (Steffens et al. 1993). This problem can be avoided by using a primer (5' CACGACGTTG-TAAAACGAC) that binds to a region ~29 nucleotides upstream of the polylinker.

**TABLE 8-7 Primers for M13/pUC**

VECTOR	CODE	DIRECTION OF PRIMING	SEQUENCE OF PRIMER
M13/pUC universal primer	1	forward	5'd(GTAAAACGACGGCCAGT)3'
M13/pUC	2	forward	5'd(GTTTTCCCAGTCACGAC)3'
M13/pUC	3	forward	5'd(CGCCAGGGTTTTCCCAGTCACGAC)3'
M13/pUC	4	reverse	5'd(AACAGCTATGACCATG)3'
M13/pUC	5	reverse	5'd(AGCGGATAACAATTCACACAGGA)3'
mp19 RD20 primer	6	forward	5'd(CGACGGCCAGTGAATTC)3'
mp18 RD29 primer	7	forward	5'd(CGACGGCCAGTGCCAAGCTTTTTTTTTT)3'

For primer map positions, please see the corresponding codes in Figure 8-12. Modified, with permission, from New England Biolabs, Inc. (©1998/99 New England Biolabs Catalog, p. 116)



**FIGURE 8-12 Positions of Synthetic Primers Used to Determine the Sequence of DNA Cloned into Various Sites of mp18 and mp19**

For specific primer sequences, please see Table 8-7. (Modified, with permission, from New England Biolabs, Inc. [©1998/99 New England Biolabs Catalog, p. 116].)

### Primers for Cloning in Bacteriophage $\lambda$ gt10 and $\lambda$ gt11 Vectors

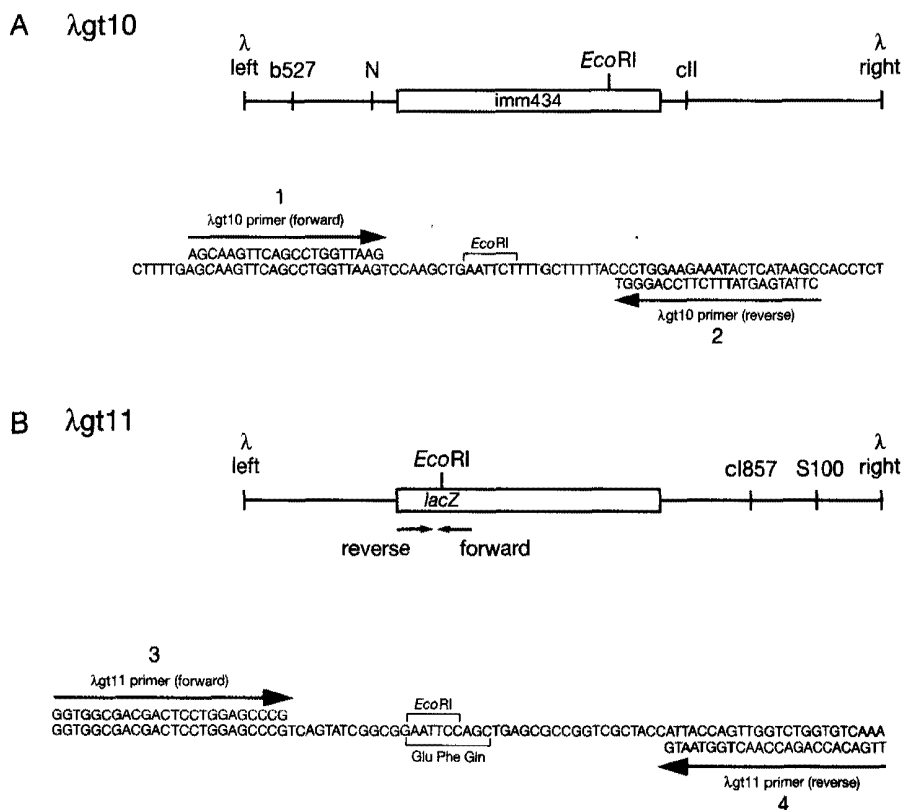
Table 8-8 provides a list of primers that can be used for amplifying or for sequencing target DNAs cloned into bacteriophage  $\lambda$ gt10 and  $\lambda$ gt11 vectors. The accompanying figure (Figure 8-13) illustrates the locations of the sites corresponding to these primer sequences on the bacteriophage genome. These primers are sold by New England Biolabs, from whose catalog the figure is reproduced.

**TABLE 8-8 Primer Sequences for Bacteriophage  $\lambda$ gt10 and  $\lambda$ gt11**

VECTOR	CODE	DIRECTION OF PRIMING	SEQUENCE OF PRIMER
$\lambda$ gt10 left arm	1	forward	5'd(AGCAAGTTCAGCCTGGTTAAG)3'
$\lambda$ gt10 right arm	2	reverse	5'd(CTTATGAGTATTTCTTCCAGGGTA)3'
$\lambda$ gt11 left arm	3	forward	5'd(GGTGGCGACGACTCCTGGAGCCCG)3'
$\lambda$ gt11 right arm	4	reverse	5'd(TTGACACCAGACCAACTGGTAATG)3'

For primer map positions, please see the corresponding codes in Figure 8-13.

Modified, with permission, from New England Biolabs (©1998/99 New England Biolabs Catalog, p. 117).



**FIGURE 8-13 Positions of Synthetic Primers Used to Determine the Sequence of DNA Cloned into Various Sites of  $\lambda$ gt10 and  $\lambda$ gt11**

For specific primer sequences, please see Table 8-8. (Modified, with permission, from New England Biolabs, Inc. [©1998/99 New England Biolabs Catalog, p. 117].)

### Transcription Promoter Primers

Table 8-9 provides a list of primers that can be used for amplifying or for sequencing target DNAs cloned into plasmids containing T7, T3, or SP6 RNA polymerase promoter sequences. These primers are sold by New England Biolabs and Stratagene, from whose catalogs the following table is adapted.

**TABLE 8-9 Transcription Promoter Primer Sequences**

PROMOTER	DIRECTION OF PRIMING	SEQUENCE OF PRIMER
SP6	forward	5'd(CATACGATTTAGGTGACACTATAG)3'
T7		5'd(TAATACGACTCACTATAGGGAGA)3'
T3		5'd(ATTAACCCTCACTAAAGGGA)3'
P <sub>lac</sub>	forward	5'd(GAGCGGATAACAATTCACACAGG)3'
SK	forward	5'd(CGCTCCTAGAAGTGGATC)3'
KS	forward	5'd(TCGAGGTCGACGGTATC)3'

Modified, with permission, from New England Biolabs (©1998/99 New England Biolabs Catalog, p. 121).

The *Bam*HI cloning site in sCOS1 vectors is flanked by promoters derived from bacteriophages T3 and T7. Primers that are complementary to sequences within these promoters and that work well for cycle sequencing of linearized cosmid DNA are given in Dugaiczky et al. (1992).

## REFERENCES

- Abbott A. 1996. Roche faces charges over Taq patent claim. *Nature* **382**: 660.
- Adati N., Ito T., Koga C., Kito K., Sakaki Y., and Shiokawa K. 1995. Differential display analysis of gene expression in developing embryos of *Xenopus laevis*. *Biochim. Biophys. Acta* **1262**: 43–51.
- Ahokas H. and Erkkila M.J. 1993. Interference of PCR amplification by the polyamines, spermine and spermidine. *PCR Methods Appl.* **3**: 65–68.
- Aiello L.P., Robinson G.S., Lin Y.W., Nishio Y., and King G.L. 1994. Identification of multiple genes in bovine retinal pericytes altered by exposure to elevated levels of glucose by using mRNA differential display. *Proc. Natl. Acad. Sci.* **91**: 6231–6235.
- Apte A.N. and Siebert P.D. 1993. Anchor-ligated cDNA libraries: A technique for generating a cDNA library for the immediate cloning of the 5' ends of mRNAs. *BioTechniques* **15**: 890–893.
- Aslanidis C. and de Jong P.J. 1990. Ligation-independent cloning of PCR products (LIC-PCR). *Nucleic Acids Res.* **18**: 6069–6074.
- Bachmann B., Luke W., and Hunsmann G. 1990. Improvement of PCR amplified DNA sequencing with the aid of detergents. *Nucleic Acids Res.* **18**: 1309.
- Bains W. 1994. Selection of oligonucleotide probes and experimental conditions for multiplex hybridization experiments. *Genet. Anal. Tech. Appl.* **11**: 49–62.
- Baldino Jr., F., Chesselet M.F., and Lewis M.E. 1989. High-resolution in situ hybridization histochemistry. *Methods Enzymol.* **168**: 761–777.
- Baltimore D. 1970. RNA-dependent DNA polymerase in virions of RNA tumour viruses. *Nature* **226**: 1209–1211.
- Barnes W.M. 1992. The fidelity of Taq polymerase catalyzing PCR is improved by an N-terminal deletion. *Gene* **112**: 29–35.
- . 1994. PCR-amplification of up to 35-kb DNA with high fidelity and high yield from lambda bacteriophage templates. *Proc. Natl. Acad. Sci.* **91**: 2216–2220.
- Bauer D., Warthoe P., Rohde M., and Strauss M. 1994. Detection and differential display of expressed genes by DDRT-PCR. *PCR Methods Appl.* **4**: S97–S108.
- Bauer D., Muller H., Reich J., Riedel H., Ahrenkiel V., Warthoe P., and Strauss M. 1993. Identification of differentially expressed mRNA species by an improved display technique (DDRT-PCR). *Nucleic Acids Res.* **21**: 4272–4280.
- Becker A., Reith A., Napiwotzki J., and Kadenbach B. 1996. A quantitative method of determining initial amounts of DNA by polymerase chain reaction cycle titration using digital imaging and a novel DNA stain. *Anal. Biochem.* **237**: 204–207.
- Becker-André M. 1993. Absolute levels of mRNA by polymerase chain reaction-aided transcript titration assay. *Methods Enzymol.* **218**: 420–445.
- Becker-André M. and Hahlbrock K. 1989. Absolute mRNA quantification using the polymerase chain reaction (PCR). A novel approach by a PCR-aided transcript titration assay (PATTY). *Nucleic Acids Res.* **17**: 9437–9446.
- Bej A.K. and Mahbubani M.H. 1994. Thermostable DNA polymerases for *in vitro* DNA amplifications. In *PCR technology current innovations* (ed. H.G. Griffin and A.M. Griffin), pp. 219–238. CRC Press, Boca Raton, Florida.
- Bennett B.L. and Molenaar A.J. 1994. Cloning of PCR products can be inhibited by Taq polymerase carryover. *BioTechniques* **16**: 32, 37.
- Benton W.D. and Davis R.W. 1977. Screening lambda<sub>gt</sub> recombinant clones by hybridization to single plaques in situ. *Science* **196**: 180–182.
- Bernard P.S., Lay M.J., and Wittwer C.T. 1998. Integrated amplification and detection of the C677T point mutation in the methylenetetrahydrofolate reductase gene by fluorescence resonance energy transfer and probe melting curves. *Anal. Biochem.* **255**: 101–107.
- Bernasconi P., Rausch T., Gogarten J.P., and Taiz L. 1989. The H<sup>+</sup> ATPase regulatory subunit of *Methanococcus thermoautotrophicus*: Amplification of an 800 bp fragment by polymerase chain reaction. *FEBS Lett.* **251**: 132–136.
- Bertioli D.J., Schlichter U.H., Adams M.J., Burrows P.R., Steinbiss H.H., and Antoniw J.F. 1995. An analysis of differential display shows a strong bias towards high copy number mRNAs. *Nucleic Acids Res.* **23**: 4520–4523.
- Bespalova I.N., Adkins S., and Burmeister M. 1998. 3'-RACE: Skewed ratio of specific to general PCR primers improves yield and specificity. *BioTechniques* **24**: 575–577.
- Beutler E., Gelbart T., and Kuhl W. 1990. Interference of heparin with the polymerase chain reaction. *BioTechniques* **9**: 166.
- Bhatia P., Taylor W.R., Geenberg A.H., and Wright J.A. 1994. Comparison of glyceraldehyde-3-phosphate dehydrogenase and 28S-ribosomal RNA gene expression as RNA loading controls for northern blot analysis of cell lines of varying malignant potential. *Anal. Biochem.* **216**: 223–226.
- Birch D.E., Kolmodin L., Laird W.J., McKinney N., Wong J., Young K.K.Y., Zangenberg G.A., and Zoccoli M.A. 1996. Simplified hot start PCR. *Nature* **381**: 445–446.
- Bjourson A.J. and Cooper J.E. 1992. Band-stab PCR: A simple technique for the purification of individual PCR products. *Nucleic Acids Res.* **20**: 4675.
- Blanchard R.K. and Cousins R.J. 1996. Differential display of intestinal mRNAs regulated by dietary zinc. *Proc. Natl. Acad. Sci.* **93**: 6863–6868.
- Bollum F.J. 1974. Terminal deoxynucleotidyl transferase. In *The enzymes* (ed. P.D. Boyer), vol. 10, pp. 37–61. Academic Press, New York.
- Bollum F.J., Chang L.M., Tsiapalis C.M., and Dorson J.W. 1974. Nucleotide polymerizing enzymes from calf thymus gland. *Methods Enzymol.* **29**: 70–81.
- Bolton E.T. and McCarthy B.J. 1962. A general method for isolation of RNA complementary to DNA. *Proc. Natl. Acad. Sci.* **48**: 1390–1396.
- Bookstein R., Lai C.-C., To H., and Lee W.-H. 1990. PCR-based detection of a polymorphic BamHI site in intron 1 of the human retinoblastoma (RB) gene. *Nucleic Acids Res.* **18**: 1666.
- Borovkov A.Y. and Rivkin M.I. 1997. *Xcml*-containing vector for direct cloning of PCR products. *BioTechniques* **22**: 812–814.
- Boyd A.C. 1993. Turbo cloning: A fast, efficient method for cloning PCR products and other blunt-ended DNA fragments into plasmids. *Nucleic Acids Res.* **21**: 817–821.
- Breslauer K.J., Frank R., Blöcker H., and Marky L.A. 1986. Predicting DNA duplex stability from the base sequence. *Proc. Natl. Acad. Sci.* **83**: 3746–3750.
- Brock T.D. 1995a. The road to Yellowstone — and beyond. *Annu Rev. Microbiol.* **49**: 1–28.
- . 1995b. Photographic supplement to “The road to Yellowstone — and beyond”. Available from T.D. Brock,

- Madison, Wisconsin.
- . 1997. The value of basic research: Discovery of *Thermus aquaticus* and other extreme thermophiles. *Genetics* **146**: 1207–1210.
- Buck L. and Axel R. 1991. A novel multigene family may encode odorant receptors: A molecular basis for odor recognition. *Cell* **65**: 175–187.
- Callard D., Lescure B., and Mazzolini L. 1994. A method for the elimination of false positives generated by the mRNA differential display technique. *BioTechniques* **16**: 1096–1103.
- Cha R.S. and Thilly W.G. 1993. Specificity, efficiency and fidelity of PCR. *PCR Methods Appl.* **3**: S18–S29.
- Chang L.M. and Bollum F.J. 1986. Molecular biology of terminal transferase. *CRC Crit. Rev. Biochem.* **21**: 27–52.
- Chelly J., Montarras D., Pinset C., Berwald-Netter Y., Kaplan J.C., and Kahn A. 1990. Quantitative estimation of minor mRNAs by cDNA-polymerase chain reaction. Application to dystrophin mRNA in cultured myogenic and brain cells. *Eur. J. Biochem.* **187**: 691–698.
- Chen Z. 1996. Simple modifications to increase specificity of the 5'-RACE procedure. *Trends Genet.* **12**: 87–88.
- Cheng S., Fockler C., Barnes W.M., and Higuchi R. 1994. Effective amplification of long targets from cloned inserts and human genome DNA. *Proc. Natl. Acad. Sci.* **91**: 5695–5699.
- Chevet E., Lemaitre G., and Katinka D.K. 1995. Low concentrations of tetramethylammonium chloride increase yield and specificity of PCR. *Nucleic Acids Res.* **23**: 3343–3344.
- Chiang C.M., Chow L.T., and Broker T.R. 1993. Identification of alternatively spliced mRNAs and localization of 5' ends by polymerase chain reaction amplification. *Methods Mol. Biol.* **15**: 189–198.
- Chien A., Edgar D.B., and Trela J.M. 1976. Deoxyribonucleic acid polymerase from the extreme thermophile *Thermus aquaticus*. *J. Bacteriol.* **127**: 1550–1557.
- Chuang S.E., Wang K.C., and Cheng A.L. 1995. Single-step direct cloning of PDC products. *Trends Genet.* **11**: 7–8.
- Chumakov K.M. 1994. Reverse transcriptase can inhibit PCR and stimulate primer-dimer formation. *PCR Methods Appl.* **4**: 62–64.
- Clackson T. and Winter G. 1989. 'Sticky feet'-directed mutagenesis and its application to swapping antibody domains. *Nucleic Acids Res.* **17**: 10163–10170.
- Clark J.M. 1988. Novel non-templated nucleotide addition reactions catalyzed by prokaryotic and eucaryotic DNA polymerases. *Nucleic Acids Res.* **16**: 9677–9686.
- Clifford S.C., Thomas D.J., Neal D.E., and Lunec J. 1994. Increased *mdr1* gene transcript levels in high grade carcinoma of the bladder determined by quantitative PCR-based assay. *Br. J. Cancer* **69**: 680–686.
- Cline J., Braman J.C., and Hogrefe H.H. 1996. PCR fidelity of pfu DNA polymerase and other thermostable DNA polymerases. *Nucleic Acids Res.* **24**: 3546–3551.
- Cohen J. 1994. 'Long PCR' leaps into larger DNA sequences. *Science* **263**: 1564–1565.
- Collins F.S. and Weissman S.M. 1984. Directional cloning of DNA fragments at a large distance from an initial probe: A circularization method. *Proc. Natl. Acad. Sci.* **81**: 6812–6816.
- Costa G.L. and Weiner M.P. 1995. Cloning and analysis of PCR-generated DNA fragments. In *PCR primer: A laboratory manual* (ed. C.W. Dieffenbach and G.S. Dveksler), pp. 555–580. Cold Spring Harbor Laboratory Press, Cold Spring Harbor, New York.
- Crooke S.T. 1998. Molecular mechanisms of antisense drugs: RNase H. *Antisense Nucleic Acid Drug Dev.* **8**: 133–134.
- Cross N.C. 1995. Quantitative PCR techniques and applications. *J. Haematol.* **89**: 693–697.
- Crouch R. 1990. Ribonuclease H: From discovery to 3D structure. *New Biol.* **2**: 771–777.
- Crouse J. and Amorese D. 1986. Double digestions of the multiple cloning site. *Focus (Life Technologies)* **8**: 9.
- Crowe J.S., Cooper H.S., Smith M.A., Parker D., and Gewert D. 1991. Improved cloning efficiency of polymerase chain reaction (PCR) products after proteinase K digestion. *Nucleic Acids Res.* **19**: 184.
- D'Aquila R.T., Bechtel L.J., Videler J.A., Eron J.J., Gorczyca P., and Kaplan J.C. 1991. Maximizing sensitivity and specificity of PCR by pre-amplification heating. *Nucleic Acids Res.* **19**: 3749.
- Desai U.J. and Pfaffle P.K. 1995. Single-step purification of a thermostable DNA polymerase expressed in *Escherichia coli*. *BioTechniques* **19**: 780–782.
- Dickson D. 1994. Promega files court challenge to Roche's Taq enzyme patent. *Nature* **372**: 714
- . 1996. Roche claims victory in bid for European Taq patent. *Nature* **384**: 100.
- Dieffenbach C.W. and Dveksler G.S., eds. 1995. *PCR primer: A laboratory manual*. Cold Spring Harbor Laboratory Press, Cold Spring Harbor, New York
- Dieffenbach C.W., Lowe T.M.J., and Dveksler G.S. 1995. General concepts for PCR primer design. In *PCR primer: A laboratory manual* (ed. C.W. Dieffenbach and G.S. Dveksler), pp. 133–142. Cold Spring Harbor Laboratory Press, Cold Spring Harbor, New York.
- Dilworth D.D. and McCarrey J.R. 1992. Single-step elimination of contaminating DNA prior to reverse transcriptase PCR. *PCR Methods Appl.* **1**: 279–282.
- Diviacco S., Norio P., Zentilin L., Menzo S., Clementi M., Biamonti G., Riva S., Falaschi A., and Giacca M. 1992. A novel procedure for quantitative polymerase chain reaction by coamplification of competitive templates. *Gene* **122**: 313–320.
- Don R.H., Cox P.T., Wainwright B.J., Baker K., and Mattick J.S. 1991. "Touchdown" PCR to circumvent spurious priming during gene amplification. *Nucleic Acids Res.* **19**: 4008.
- Dorfman D.M. 1993. Amplification of bacteriophage library inserts using polymerase chain reaction. *Methods Enzymol.* **218**: 336–340.
- Dugaiczky A., Goold R., diSibio G., and Myers R.M. 1992. Improved sequencing of cosmids using new primers and linearized DNA. *Nucleic Acids Res.* **20**: 6421–6422.
- Eckert K.A. and Kunkel T.A. 1993. Effect of reaction pH on the fidelity and processivity of exonuclease-deficient Klenow polymerase. *J. Biol. Chem.* **268**: 13462–13471.
- Engelke D.R., Krikos A., Bruck M.E., and Ginsburg D. 1990. Purification of *Thermus aquaticus* DNA polymerase expressed in *Escherichia coli*. *Anal. Biochem.* **191**: 396–400
- Erlich H.A. 1989. Polymerase chain reaction. *J. Clin. Immunol.* **9**: 437–447.
- Erlich H.A., Gelfand D., and Sninsky J.J. 1991. Recent advances in the polymerase chain reaction. *Science* **252**: 1643–1651.
- Fanning S. and Gibbs R.A. 1997. PCR in genome analysis. In *Genome analysis: A laboratory manual*, vol. 1: *Analyzing DNA* (ed. B. Birren et al.), pp. 249–299. Cold Spring Harbor Laboratory Press, Cold Spring Harbor, New York.
- Ferguson W.J., Braunschweiger K.I., Braunschweiger W.R., Smith J.R., McCormick J.J., Wasmann C.C., Jarvis N.P., Bell D.H.,

- and Good N.E. 1980. Hydrogen ion buffers for biological research. *Anal. Biochem.* **104**: 300–310.
- Ferre F. 1992. Quantitative or semi-quantitative PCR: Reality versus myth. *PCR Methods Appl.* **2**: 1–9.
- Foley K.P., Leonard M.W., and Engel J.D. 1993. Quantitation of RNA using the polymerase chain reaction. *Trends Genet.* **9**: 380–385.
- Foord O.S. and Rose E.A. 1994. Long-distance PCR. *PCR Methods Appl.* **3**: S149–161.
- Freeman W.M., Walker S.J., and Vrana K.E. 1999. Quantitative RT-PCR: Pitfalls and potential. *BioTechniques* **26**: 112–125.
- Freier S.M., Kierzek R., Jaeger J.A., Sugimoto N., Caruthers M.H., Neilson T., and Turner D.H. 1986. Improved free-energy parameters for predictions of RNA duplex stability. *Proc. Natl. Acad. Sci.* **83**: 9373–9377.
- Frohman M.A. 1993. Rapid amplification of complementary DNA ends for generation of full-length complementary DNAs: Thermal RACE. *Methods Enzymol.* **218**: 340–356.
- . 1995. Rapid amplification of cDNA ends. In *PCR primer: A laboratory manual* (ed. C.W. Deffenbach and G.S. Dveksler), pp. 381–409. Cold Spring Harbor Laboratory Press, Cold Spring Harbor, New York.
- Frohman M.A., Dush M.K., and Martin G.R. 1988. Rapid production of full-length cDNAs from rare transcripts: Amplification using a single gene-specific oligonucleotide primer. *Proc. Natl. Acad. Sci.* **85**: 8998–9002.
- Garza D., Ajioka J.W., Burke D.T., and Hartl D.L. 1989. Mapping the *Drosophila* genome with yeast artificial chromosomes. *Science* **246**: 641–646.
- Gause W.C. and Adamovicz J. 1994. The use of PCR to quantitate gene expression. *PCR Methods Appl.* **3**: S123–135.
- Gelfand D.H. and White T.J. 1990. Thermostable DNA polymerases. In *PCR protocols: A guide to methods and applications* (ed. M.A. Innis et al.), pp. 129–141. Academic Press, San Diego, California.
- Gerard G.F., Fox D.K., Nathan M., and D'Alessio J.M. 1997. Reverse transcriptase. The use of cloned Moloney murine leukemia virus reverse transcriptase to synthesize DNA from RNA. *Mol. Biotechnol.* **8**: 61–77.
- Gerard G.F., Schmidt B.J., Kotewicz M.L., and Campbell J.H. 1988. cDNA synthesis by Moloney murine leukemia virus RNase H-minus reverse transcriptase possessing full DNA polymerase activity. *Focus (Life Technologies)* **14**: 91–93.
- Gibson U.E., Heid C.A., and Williams P.M. 1996. A novel method for real time quantitative RT-PCR. *Genome Res.* **6**: 995–1001.
- Gillfillan S., Benoist C., and Mathis D. 1995. Mice lacking terminal deoxynucleotidyl transferase: Adult mice with a fetal antigen receptor repertoire. *Immunol. Rev.* **148**: 201–219.
- Gilliland G., Perrin S., Blanchard K., and Bunn H.F. 1990. Analysis of cytokine mRNA and DNA: Detection and quantitation by competitive polymerase chain reaction. *Proc. Natl. Acad. Sci.* **87**: 2725–2529.
- Girgis S.I., Alevizaki M., Denny P., Ferrier G.J., and Legon S. 1988. Generation of DNA probes for peptides with highly degenerate codons using mixed primer PCR. *Nucleic Acids Res.* **16**: 10371.
- Good N.E. and Izawa S. 1972. Hydrogen ion buffers. *Methods Enzymol.* **24**: 53–68.
- Good N.E., Winget G.D., Winter W., Connolly T.N., Izawa S., and Singh R.M. 1966. Hydrogen ion buffers for biological research. *Biochemistry* **5**: 467–177.
- Graf D., Fisher A.G., and Merckenschlager M. 1997. Rational primer design greatly improves differential display-PCR (DD-PCR). *Nucleic Acids Res.* **25**: 2239–2240.
- Griffin H.G. and Griffin A.M. 1994. *PCR technology: Current innovations*. CRC Press, Boca Raton, Florida.
- Griffin H.G., J'Anson K.J., and Gasson M.J. 1993. Rapid isolation of genes from bacterial lambda libraries by direct polymerase chain reaction screening. *FEMS Microbiol. Lett.* **112**: 49–53.
- Grillo M. and Margolis F.L. 1990. Use of reverse transcriptase polymerase chain reaction to monitor expression of intronless genes. *BioTechniques* **9**: 262–268.
- Guimaraes M.J., McClanahan T., and Bazan J.F. 1997. Application of differential display in studying developmental processes. *Methods Mol. Biol.* **85**: 175–194.
- Güssow D. and Clackson T. 1989. Direct clone characterization from plaques and colonies by the polymerase chain reaction. *Nucleic Acids Res.* **17**: 4000.
- Gustafson C.E., Alm R.A., and Trust T.J. 1993. Effect of heat denaturation of target DNA on the PCR amplification. *Gene* **123**: 241–244.
- Gutman P.D. and Minton K.W. 1993. Conserved sites in the 5'-3' exonuclease domain of *Escherichia coli* DNA polymerase. *Nucleic Acids Res.* **21**: 4406–4407.
- Haag E. and Raman V. 1994. Effects of primer choice and source of Taq DNA polymerase on the banding patterns of differential display RT-PCR. *BioTechniques* **17**: 226–228.
- Halford W.P. 1999. The essential prerequisites for quantitative PCR. *Nat. Biotechnol.* **17**: 835.
- Halford W.P., Falco V.C., Gebhardt B.M., and Carr D.J. 1999. The inherent quantitative capacity of the reverse transcription-polymerase chain reaction. *Anal. Biochem.* **266**: 181–191.
- Harris S. and Jones D.B. 1997. Optimisation of the polymerase chain reaction. *Br. J. Biomed. Sci.* **54**: 166–173.
- Harting I. and Wiesner R.J. 1997. Quantification of transcript-to-transcript ratios as a measure of gene expression using RT-PCR. *BioTechniques* **23**: 450–455.
- Hartley J.L. and Rashtchian A. 1993. Dealing with contamination: Enzymatic control of carryover contamination in PCR. *PCR Methods Appl.* **3**: S10–S14.
- Harvey R.J. and Darlison M.G. 1991. Random-primed cDNA synthesis facilitates the isolation of multiple 5'-cDNA ends by RACE. *Nucleic Acids Res.* **19**: 4002.
- Haun R.S., Serventi I.M., and Moss J. 1992. Rapid, reliable ligation-independent cloning of PCR products using modified plasmid vectors. *BioTechniques* **13**: 515–518.
- Hausen P. and Stein H. 1970. Ribonuclease H. An enzyme degrading the RNA moiety of DNA-RNA hybrids. *Eur. J. Biochem.* **14**: 278–283.
- Hecker K.H. and Roux K.H. 1996. High and low annealing temperatures increase both specificity and yield in touchdown and stepdown PCR. *BioTechniques* **20**: 478–485.
- Heid C.A., Stevens J., Livak K.J., and Williams P.M. 1996. Real time quantitative PCR. *Genome Res.* **6**: 986–994.
- Hemsley A., Arnheim N., Toney M.D., Cortopassi G., and Galas D.J. 1989. A simple method for site-directed mutagenesis using the polymerase chain reaction. *Nucleic Acids Res.* **17**: 6545–6551.
- Hengen P.N. 1995a. Methods and reagents. Cloning PCR products using T-vectors. *Trends Biochem. Sci.* **20**: 85–86.
- . 1995b. Fidelity of DNA polymerases for PCR. *Trends Biochem. Sci.* **20**: 324–325.
- Higuchi R., Dollinger G., Walsh P.S., and Griffith R. 1992. Simultaneous amplification and detection of specific DNA sequences. *Bio/Technology* **10**: 413–417.
- Higuchi R., Fockler C., Dollinger G., and Watson R. 1993. Kinetic

- PCR analysis: Real-time monitoring of DNA amplification reactions. *BioTechnology* **11**: 1026–1030.
- Hill J.M., Halford W.P., Wen R., Engel L.S., Green L.C., and Gebhardt B.M. 1996. Quantitative analysis of polymerase chain reaction products by dot blot. *Anal. Biochem.* **235**: 44–48.
- Hinnisdaels S., Del-Favero J., and Vauterin M. 1996. Direct cloning of PCR products amplified with *Pwo* DNA polymerase. *BioTechniques* **20**: 186–188.
- Ho S.N., Pullen J.K., Horton R.M., Hunt H.D., and Pease L.R. 1990. DNA and protein engineering using the polymerase chain reaction: Splicing by overlap extension. *DNA Protein Eng. Tech.* **2**: 50–55.
- Holland P.M., Abramson R.D., Watson R., and Gelfand D.H. 1991. Detection of specific polymerase chain reaction product by utilizing the 5'–3' exonuclease activity of *Thermus aquaticus* DNA polymerase. *Proc. Natl. Acad. Sci.* **88**: 7276–7280.
- Holton T.A. and Graham M.W. 1991. A simple and efficient method for direct cloning of PCR products using ddT-tailed vectors. *Nucleic Acids Res.* **19**: 1156.
- Hoppe B.L., Conti-Tronconi B.M., and Horton R.M. 1992. Gel-loading dyes compatible with PCR. *BioTechniques* **12**: 679–680.
- Horton R.M., Cai Z.L., Ho S.N., and Pease L.R. 1990. Gene splicing by overlap extension: Tailor-made genes using the polymerase chain reaction. *BioTechniques* **8**: 528–535.
- Hostomsky Z., Hostomska Z., and Matthews D.A. 1993. Ribonucleases H. In *Nucleases*, 2nd edition (ed. S.M. Linn et al.), pp. 341–376. Cold Spring Harbor Laboratory Press, Cold Spring Harbor, New York.
- Hu G. 1993. DNA polymerase-catalyzed addition of non-templated extra nucleotides to the 3' end of a DNA fragment. *DNA Cell Biol.* **12**: 763–770.
- Huang S.H., Hu Y.Y., Wu C.H., and Holcenberg J. 1990. A simple method for direct cloning cDNA sequence that flanks a region of known sequence from total RNA by applying the inverse polymerase chain reaction. *Nucleic Acids Res.* **18**: 1922.
- Huang S.H., Wu C.H., Cai B., and Holcenberg J. 1993. cDNA cloning by inverse polymerase chain reaction. *Methods Mol. Biol.* **15**: 349–356.
- Huang Z., Fasco M.J., and Kaminsky L.S. 1996. Optimization of Dnase I removal of contaminating DNA from RNA for use in quantitative RNA-PCR. *BioTechniques* **20**: 1012–1020.
- Hung T., Mak K., and Fong K. 1990. A specificity enhancer for polymerase chain reaction. *Nucleic Acids Res.* **18**: 4953.
- Huxley C., Green E.D., and Dunham I. 1990. Rapid assessment of *S. cerevisiae* mating type by PCR. *Trends Genet.* **6**: 236.
- Imai Y., Matsushima Y., Sugimura T., and Terada M. 1991. A simple and rapid method for generating a deletion by PCR. *Nucleic Acids Res.* **19**: 2785.
- Innis M.A., Gelfand D.H., Sninsky J.J., and White T.J. 1990. *PCR protocols. A guide to methods and applications*. Academic Press, New York.
- Ishiguro T., Saitoh J., Yawata H., Yamagishi H., Iwasaki S., and Mitoma Y. 1995. Homogeneous quantitative assay of hepatitis C virus RNA by polymerase chain reaction in the presence of a fluorescent intercalator. *Anal. Biochem.* **229**: 207–213.
- Ishino Y., Ueno T., Miyagi M., Uemori T., Imamura M., Tsunasawa S., and Kato I. 1994. Overproduction of *Thermus aquaticus* DNA polymerase and its structural analysis by ion-spray mass spectrometry. *J. Biochem.* **116**: 1019–1024.
- Israel D.I. 1993. A PCR-based method for high stringency screening of DNA libraries. *Nucleic Acids Res.* **21**: 2627–2631.
- Jones D.H. and Howard B.H. 1991. A rapid method for recombination and site-specific mutagenesis by placing homologous ends on DNA using polymerase chain reaction. *BioTechniques* **10**: 62–66.
- Jones D.H. and Winistorfer S.C. 1993. A method for the amplification of unknown flanking DNA: Targeted inverted repeat amplification. *BioTechniques* **15**: 894–904.
- Joyce C.M. and Steitz T.A. 1994. Function and structure relationships in DNA polymerases. *Annu. Rev. Biochem.* **63**: 777–822.
- . 1995. Polymerase structures and function: Variations on a theme? *J. Bacteriol.* **177**: 6321–6329.
- Jung V., Pestka S.B., and Pestka S. 1990. Efficient cloning of PCR generated DNA containing terminal restriction endonuclease recognition sites. *Nucleic Acids Res.* **18**: 6156.
- . 1993. Cloning of polymerase chain reaction-generated DNA containing terminal restriction endonuclease recognition sites. *Methods Enzymol.* **218**: 357–362.
- Jung Y.H. and Lee Y. 1995. RNases in ColE1 DNA metabolism. *Mol. Biol. Rep.* **22**: 195–200.
- Jurecic R., Nguyen T., and Belmont J.W. 1996. Differential mRNA display using anchored oligo-dT and long sequence-specific primers as arbitrary primers. *Trends Genet.* **12**: 502–504.
- Kain K.C., Orlandi P.A., and Lanar D.E. 1991. Universal promoter for gene expression without cloning: Expression PCR. *BioTechnology* **10**: 366–374.
- Kaledin A.S., Sliusarenko A.G., and Gorodetskii S.I. 1980. Isolation and properties of DNA polymerase from extreme thermophilic bacteria *Thermus aquaticus* YT-1. *Biokhimiya* **45**: 644–651.
- Kaluz S. and Flint A.P. 1994. Ligation-independent cloning of PCR products with primers containing nonbase residues. *Nucleic Acids Res.* **22**: 4845.
- Kaluz S., Kolble K., and Reid K.B. 1992. Directional cloning of PCR products using exonuclease III. *Nucleic Acids Res.* **20**: 4369–4370.
- Kanaya S. and Ikehara M. 1995. Functions and structures of ribonuclease H enzymes. *Subcell. Biochem.* **24**: 377–422.
- Kato K.I., Gonçalves J.M., Houts G.E., and Bollum F.J. 1967. Deoxynucleotide-polymerizing enzymes of calf thymus gland. II. Properties of the terminal deoxynucleotidyltransferase. *J. Biol. Chem.* **242**: 2780–2789.
- Kaufman D.L. and Evans G.A. 1990. Restriction endonuclease cleavage at the termini of PCR products (erratum *BioTechniques* [1990] **9**: 720). *BioTechniques* **9**: 304–306.
- Kebelmann-Betz C., Seeger K., Dragon S., Schmitt G., Moricke A., Schild T.A., Henze G., and Beyermann B. 1998. Advantages of a new Taq DNA polymerase in multiplex PCR and time-release PCR. *BioTechniques* **24**: 154–158.
- Kellogg D.E., Rybalkin I., Chen S., Mukhamedova N., Vlasik T., Siebert P.D., and Chenchik A. 1994. TaqStart antibody: "Hot start" PCR facilitated by a neutralizing monoclonal antibody directed against Taq DNA polymerase. *BioTechniques* **16**: 1134–1137.
- Keohavong P., Wang C.C., Cha R.S., and Thilly W.G. 1988. Enzymatic amplification and characterization of large DNA fragments of genomic DNA. *Gene* **71**: 211–216.
- Kim Y., Eom S.H., Wang J., Lee D.-S., Suh S.W., and Steitz T.A. 1995. Crystal structure of *Thermus aquaticus* DNA polymerase. *Nature* **376**: 612–616.
- Kleppe K., Ohtsuka E., Kleppe R., Molineux I., and Khorana H.G. 1971. Studies on polynucleotides. XCVI. Repair replications

- of short synthetic DNA's as catalyzed by DNA polymerases. *J. Mol. Biol.* **56**: 341–361.
- Knoth K., Roberds S., Poteet C., and Tamkun M. 1988. Highly degenerate, inosine-containing primers specifically amplify rare cDNA using the polymerase chain reaction. *Nucleic Acids Res.* **16**: 10932.
- Kolodkin A.L., Matthes D.J., and Goodman C.S. 1993. The semaphorin genes encode a family of transmembrane and secreted growth cone guidance molecules. *Cell* **75**: 1389–1399.
- Korolev S., Nayal M., Barnes W.M., Di Cera E., and Waksman G. 1995. Crystal structure of the large fragment of *Thermus aquaticus* DNA polymerase I at 2.5-Å resolution: Structural basis for thermostability. *Proc. Natl. Acad. Sci.* **92**: 9264–9268.
- Koshland Jr., D.E. 1989. The molecule of the year. *Science* **246**: 1541.
- Kotewicz M.L., Sampson C.M., D'Alessio J.M., and Gerard G.F. 1988. Isolation of a cloned Moloney murine leukemia virus reverse transcriptase lacking ribonuclease H activity. *Nucleic Acids Res.* **16**: 265–277.
- Kovalic D., Kwak J.H., and Weisblum B. 1991. General method for direct cloning of DNA fragments generated by the polymerase chain reaction. *Nucleic Acids Res.* **19**: 4560.
- Krawetz S.A., Pon R.T., and Dixon G.H. 1989. Increased efficiency of the Taq polymerase catalyzed polymerase chain reaction. *Nucleic Acids Res.* **17**: 819.
- Krishnan B.R., Blakesley R.W., and Berg D.E. 1991. Linear amplification DNA sequencing directly from single phage plaques and bacterial colonies. *Nucleic Acids Res.* **19**: 1153.
- Krowczynska A.M. and Henderson M.B. 1992. Efficient purification of PCR products using ultrafiltration. *BioTechniques* **13**: 286–289.
- Larrick J.W. 1992. Message amplification phenotyping (MAPPING)—Principles, practice and potential. *Trends Biotechnol.* **10**: 146–152.
- Lathe R. 1985. Synthetic oligonucleotide probes deduced from amino acid sequence data. *J. Mol. Biol.* **183**: 1–12.
- Lawyer F.C., Stoffel S., Saiki R.K., Myambo K., Drummond R., and Gelfand D.H. 1989. Isolation, characterization and expression in *Escherichia coli* of the DNA polymerase gene from *Thermus aquaticus*. *J. Biol. Chem.* **264**: 6427–6437.
- Lawyer F.C., Stoffel S., Saiki R.K., Chang, S.Y., Landre, P.A., Abramson, R.D., and Gelfand, D.H. 1993. High-level expression, purification and enzymatic characterization of full-length *Thermus aquaticus* DNA polymerase and a truncated form deficient in 5' to 3' exonuclease activity. *PCR Methods Appl.* **2**: 275–287.
- Lay M.J. and Wittwer C.T. 1997. Real-time fluorescence genotyping of factor V Leiden during rapid-cycle PCR. *Clin. Chem.* **43**: 2262–2267.
- Lee C.C. and Caskey C.T. 1990. cDNA cloning using degenerate primers. In *PCR protocols: A guide to methods and applications* (ed. M.A. Innis et al.), pp. 46–53. Academic Press, San Diego, California.
- Lee C.C., Wu X.W., Gibbs R.A., Cook R.G., Muzny D.M., and Caskey C.T. 1988. Generation of cDNA probes directed by amino acid sequence: Cloning of urate oxidase. *Science* **239**: 1288–1291.
- Lee L.G., Connell C.R., and Bloch W. 1993. Allelic discrimination by nick-translation PCR with fluorogenic probes. *Nucleic Acids Res.* **21**: 3761–3766.
- Levis R. 1995. Strategies for cloning PCR products. In *PCR primer: A laboratory manual* (ed. C.W. Dieffenbach and G.S. Dveksler), pp. 539–554. Cold Spring Harbor Laboratory Press, Cold Spring Harbor, New York.
- Lewis M.J. and Pelham H.R. 1990. The sequence of the *Kluyveromyces lactis* BiP gene. *Nucleic Acids Res.* **18**: 6438.
- Li F., Barnathan E.S., and Kariko K. 1994. Rapid method for screening and cloning cDNAs generated in differential mRNA display: Application of northern blot for affinity capturing of cDNAs. *Nucleic Acids Res.* **22**: 1764–1765.
- Li H., Cui X., and Arnheim N. 1990. Direct electrophoretic detection of the allelic state of single DNA molecules in human sperm by using polymerase chain reaction. *Proc. Natl. Acad. Sci.* **87**: 4580–4584.
- Liang P. and Pardee A.B. 1992. Differential display of eukaryotic messenger RNA by means of the polymerase chain reaction. *Science* **257**: 967–971.
- . 1997. Differential display. A general protocol. *Methods Mol. Biol.* **85**: 3–11.
- Liang P., Averboukh L., and Pardee A.B. 1993. Distribution and cloning of eukaryotic mRNAs by means of differential display: Refinements and optimization. *Nucleic Acids Res.* **21**: 3269–3275.
- Liang P., Averboukh L., Keyomarsi K., Sager R., and Pardee A.B. 1992. Differential display and cloning of messenger RNAs from human breast cancer versus mammary epithelial cells. *Cancer Res.* **52**: 6966–6968.
- Liang P., Bauer D., Averboukh L., Warthoe P., Rohrwild M., Muller H., Strauss M., and Pardee A.B. 1995. Analysis of altered gene expression by differential display. *Methods Enzymol.* **254**: 304–321.
- Liang P., Zhu W., Zhang X., Guo Z., O'Connell R.P., Averboukh L., Wang F., and Pardee A.B. 1994. Differential display using one-base anchored oligo-dT primers. *Nucleic Acids Res.* **22**: 5763–5764.
- Liedtke W., Battistini L., Brosnan C.F., and Raine C.S. 1994. A comparison of methods for RNA extraction from lymphocytes for RT-PCR. *PCR Methods Appl.* **4**: 185–187.
- Ling M., Merante F., and Robinson B.H. 1995. A rapid and reliable DNA preparation method for screening a large number of yeast clones by polymerase chain reaction. *Nucleic Acids Res.* **23**: 4924–4925.
- Linskens M.H., Feng J., Andrews W.H., Enlow B.E., Saati S.M., Tonkin L.A., Funk W.D., and Villeponteau B. 1995. Cataloging altered gene expression in young and senescent cells using enhanced differential display. *Nucleic Acids Res.* **23**: 3244–3251.
- Linz U., Delling U., and RübSamen-Waigmann H. 1990. Systematic studies on parameters influencing the performance of the polymerase chain reaction. *J. Clin. Chem. Clin. Biochem.* **28**: 5–13.
- Liu Z.G. and Schwartz L.M. 1992. An efficient method for blunt-end ligation of PCR products. *BioTechniques* **12**: 28–30.
- Livak K.J., Flood S.J., Marmaro J., Giusti W., and Deetz K. 1995. Oligonucleotides with fluorescent dyes at opposite ends provide a quenched probe system useful for detecting PCR product and nucleic acid hybridization. *PCR Methods Appl.* **4**: 357–362.
- Lobet Y., Peacock M., and Cieplak Jr., W. 1989. Frame-shift mutation in the lacZ gene of certain commercially available pUC18 plasmids. *Nucleic Acids Res.* **17**: 4897.
- Loh E.Y., Elliott J.F., Cwirla S., Lanier L.L., and Davis M.M. 1989. Polymerase chain reaction with single-sided specificity: Analysis of T cell receptor delta chain. *Science* **243**: 217–220.
- Longley M.J., Bennett S.E., and Mosbaugh D.W. 1990. Characterization of the 5' to 3' exonuclease associated with



- Thermus aquaticus* DNA polymerase. *Nucleic Acids Res.* **18**: 7317–7322.
- Longo M.C., Berninger M.S., and Hartley J.L. 1990. Use of uracil DNA glycosylase to control carry-over contamination in polymerase chain reactions. *Gene* **93**: 125–128.
- Loukianov E.V., Loukianova T., and Periasamy M. 1997. Identification of targeted embryonic stem cells using long-distance PCR. *BioTechniques* **23**: 376–378, 380.
- Lu Y.H. and Negre S. 1993. Use of glycerol for enhanced efficiency and specificity of PCR amplification. *Trends Genet.* **9**: 297.
- Lubin M.B., Elashoff J.D., Wang S.J., Rotter J.L., and Toyoda H. 1991. Precise gene dosage determination by polymerase chain reaction: Theory, methodology, and statistical approach. *Mol. Cell. Probes* **5**: 307–317.
- Luce M.J. and Burrows P.D. 1998. Minimizing false positives in differential display. *BioTechniques* **24**: 766–768, 770.
- Madigan M.T. and Marrs B.L. 1997. Extremophiles. *Sci. Am.* **276**: 82–87.
- Malhotra K., Foltz L., Mahoney W.C., and Schueler P.A. 1998. Interaction and effect of annealing temperature on primers used in differential display RT-PCR. *Nucleic Acids Res.* **26**: 854–856.
- Mansur N.R., Meyer-Siegler K., Wurzer J.C., and Sirover M.A. 1993. Cell cycle regulation of the glyceraldehyde-3-phosphate dehydrogenase/uracil DNA glycosylase gene in normal human cells. *Nucleic Acids Res.* **21**: 993–998.
- Marchuk D., Drumm M., Saulino A., and Collins F.S. 1991. Construction of T-vectors, a rapid and general system for direct cloning of unmodified PCR products. *Nucleic Acids Res.* **19**: 1154.
- McAlinden T.P. and Krawetz S.A. 1994. A practical method to screen libraries of cloned DNA. *Anal. Biochem.* **218**: 237–238.
- McClelland M., Mathieu-Daude F., and Welsh J. 1995. RNA fingerprinting and differential display using arbitrarily primed PCR. *Trends Genet.* **11**: 242–246.
- McConlogue L., Brow M.A., and Innis M.A. 1988. Structure-independent DNA amplification by PCR using 7-deaza-2'-deoxyguanosine. *Nucleic Acids Res.* **16**: 9869.
- Mead D.A., Pey N.K., Herrstadt C., Marcil R.A., and Smith L.M. 1991. A universal method for the direct cloning of PCR amplified nucleic acid. *BioTechnology* **9**: 657–663.
- Merkens L.S., Bryan S.K., and Moses R.E. 1995. Inactivation of the 5'-3' exonuclease of *Thermus aquaticus* DNA polymerase. *Biochim. Biophys. Acta* **1264**: 243–248.
- Mezei L.M. and Storts D.R. 1994. Cloning PCR products. In *PCR technology: Current innovations* (ed. H.G. Griffin and A.M. Griffin), pp. 21–28. CRC Press, Boca Raton, Florida.
- Mitsuhashi M. 1996. Technical report: Part 2. Basic requirements for designing optimal PCR primers. *J. Clin. Lab. Anal.* **10**: 285–293.
- Mitsuhashi M., Cooper A., Ogura M., Shinagawa T., Yano K., and Hosokawa T. 1994. Oligonucleotide probe design—A new approach. *Nature* **367**: 759–761.
- Mole S.E., Iggo R.D., and Lane D.P. 1989. Using the polymerase chain reaction to modify expression plasmids for epitope mapping. *Nucleic Acids Res.* **17**: 3319.
- Mou L., Miller H., Li J., Wang E., and Chalifour L. 1994. Improvements to the differential display method for gene analysis. *Biochem. Biophys. Res. Commun.* **199**: 564–569.
- Mullis K.B. 1990. The unusual origin of the polymerase chain reaction. *Sci. Am.* **262**: 56–65.
- . 1991. The polymerase chain reaction in an anemic mode: How to avoid cold oligodeoxyribonuclear fusion. *PCR Methods Appl.* **1**: 1–4.
- Mullis K.B. and Faloona F.A. 1987. Specific synthesis of DNA *in vitro* via a polymerase-catalyzed reaction. *Methods Enzymol.* **155**: 335–350.
- Mullis K., Faloona F., Scharf S., Saiki R., Horn G., and Erlich H. 1986. Specific enzymatic amplification of DNA *in vitro*: The polymerase chain reaction. *Cold Spring Harbor Symp. Quant. Biol.* **51**: 263–273.
- Myers T.W. and Gelfand D.H. 1991. Reverse transcription and DNA amplification by a *Thermus thermophilus* DNA polymerase. *Biochemistry* **30**: 7661–7666.
- Myers T.W., Sigua C.L., and Gelfand D.H. 1994. High temperature reverse transcription and PCR with a *Thermus thermophilus* DNA polymerase. *Nucleic Acids Symp. Ser.* **30**: 87.
- Nasarabadi S., Milanovich F., Richards J., and Belgrader P. 1999. Simultaneous detection of TaqMan probes containing Fam and Tamra reporter fluorophores. *BioTechniques* **27**: 1116–1118.
- Nei M. and Li W.H. 1979. Mathematical model for studying genetic variation in terms of restriction endonucleases. *Proc. Natl. Acad. Sci.* **76**: 5269–5273.
- Newton C.R. and Graham A. 1994. *PCR*. BIOS Scientific, Oxford, United Kingdom.
- Niederhauser C., Hofelein C., Wegmuller B., Luthy J., and Candrian U. 1994. Reliability of PCR decontamination systems. *PCR Methods Appl.* **4**: 117–123.
- Nishio Y., Aiello L.P., and King G.L. 1994. Glucose induced genes in bovine aortic smooth muscle cells identified by mRNA differential display. *FASEB J.* **8**: 103–106.
- Nisson P.E., Rashtchian A., and Watkins P.C. 1991. Rapid and efficient cloning of Alu-PCR products using uracil DNA glycosylase. *PCR Methods Appl.* **1**: 120–123.
- Nitsche E.M., Moquin A., Adams P.S., Guenette R.S., Lakin J.N., Sinnecker G.H., Kruse K., and Tenniswood M.P. 1996. Differential display RT PCR of total RNA from human foreskin fibroblasts for investigation of androgen-dependent gene expression. *Am. J. Med. Genet.* **63**: 231–238.
- Ochman H., Ayala F.J., and Hartl D.L. 1993. Use of polymerase chain reaction to amplify segments outside boundaries of known sequences. *Methods Enzymol.* **218**: 309–321.
- Ochman H., Gerber A.S., and Hartl D.L. 1988. Genetic applications of an inverse polymerase chain reaction. *Genetics* **120**: 621–623.
- Ochman H., Ajioka J.W., Garza D., and Hartl D.L. 1990. Inverse polymerase chain reaction. *BioTechnology* **8**: 759–760.
- Ohara O., Dorit R.L., and Gilbert W. 1989. One-sided polymerase chain reaction: The amplification of cDNA. *Proc. Natl. Acad. Sci.* **86**: 5673–5677.
- Ohler L.D. and Rose E.A. 1992. Optimization of long-distance PCR using a transposon-based model system. *PCR Methods Appl.* **2**: 51–59.
- Okayama H. and Berg P. 1983. A cDNA cloning vector that permits expression of cDNA inserts in mammalian cells. *Mol. Cell. Biol.* **3**: 280–289.
- Oliner J.D., Kinzler K.W., and Vogelstein B. 1993. *In vivo* cloning of PCR products in *E. coli*. *Nucleic Acids Res.* **21**: 5192–5197.
- Ou C.Y., Moore J.L., and Schochetman G. 1991. Use of UV irradiation to reduce false positivity in polymerase chain reaction. *BioTechniques* **10**: 442–446.
- Owczarzy R., Vallone P.M., Gallo F.J., Paner T.M., Lane M.J., and Benight A.S. 1997. Predicting sequence-dependent melting stability of short duplex DNA oligomers. *Biopolymers* **44**: 217–239.

- Pelletier H. 1994. Polymerase structures and mechanism. *Science* **266**: 2025–2026.
- Perler F.B., Kumar S., and Kong H. 1996. Thermostable DNA polymerases. *Adv. Protein Chem.* **48**: 377–435.
- Persing D.H. 1991. Polymerase chain reaction: Trenches to benches. *J. Clin. Microbiol.* **29**: 1281–1285.
- Peterson M.G. and Tjian R. 1993. Cross-species polymerase chain reaction: Cloning of TATA box-binding proteins. *Methods Enzymol.* **218**: 493–507.
- Piechocki M.P. and Hines R.N. 1994. Oligonucleotide design and optimized protocol for site-directed mutagenesis. *BioTechniques* **16**: 702–707.
- Pluthero F.G. 1993. Rapid purification of high-activity Taq DNA polymerase. *Nucleic Acids Res.* **21**: 4850–4851.
- Pomp D. and Medrano J.F. 1991. Organic solvents as facilitators of polymerase chain reaction. *BioTechniques* **10**: 58–59.
- Ponce M.R. and Micol J.L. 1991. PCR amplification of long DNA fragments. *Nucleic Acids Res.* **20**: 623.
- Pontius B.W. and Berg P. 1991. Rapid renaturation of complementary DNA strands mediated by cationic detergents: A role for high-probability binding domains in enhancing the kinetics of molecular assembly processes. *Proc. Natl. Acad. Sci.* **88**: 8237–8241.
- Porcher C., Malinge M.C., Picat C., and Grandchamp B. 1992. A simplified method for determination of specific DNA or RNA copy number using quantitative PCR and an automated DNA sequencer. *BioTechniques* **13**: 106–114.
- Preston G.M. 1993. Use of degenerate oligonucleotide primers and polymerase chain reaction to clone gene family members. *Methods Mol. Biol.* **15**: 317–337.
- Prince A.M. and Andrus L. 1992. PCR: How to kill unwanted DNA. *BioTechniques* **12**: 358–360.
- Raeymaekers L. 1993. Quantitative PCR: Theoretical considerations with practical implications. *Anal. Biochem.* **214**: 582–585.
- . 1995. A commentary on the practical applications of competitive PCR. *Genome Res.* **5**: 91–94.
- Rameckers J., Hummel S., and Herrmann B. 1997. How many cycles does a PCR need? Determinations of cycle numbers depending on the number of targets and the reaction efficiency factor. *Naturwissenschaften* **84**: 259–262.
- Rashtchian A., Buchman G.W., Schuster D.M., and Berninger M.S. 1992. Uracil DNA glycosylase-mediated cloning of polymerase chain reaction-amplified DNA application to genomic and cDNA cloning. *Anal. Biochem.* **206**: 91–97.
- Reischl U. and Kochanowski B. 1995. Quantitative PCR. A survey of the present technology. *Mol. Biotechnol.* **3**: 55–71.
- Rice P., Craigie R., and Davies D.R. 1996. Retroviral integrases and their cousins. *Curr. Opin. Struct. Biol.* **6**: 76–83.
- Riedel K.H., Wingfield B.D., and Britz T.J. 1992. Combined influence of magnesium concentration and polymerase chain reaction specificity enhancers. *FEMS Microbiol. Lett.* **92**: 69–72.
- Ririe K.M., Rasmussen R.P., and Wittwer C.T. 1997. Product differentiation by analysis of DNA melting curves during the polymerase chain reaction. *Anal. Biochem.* **245**: 154–160.
- Rother R.P. 1992. Increasing the specificity of oligo(dT)-primed PCR. *BioTechniques* **13**: 524–527.
- Roux K.H. 1995. Optimization and troubleshooting in PCR. In *PCR primer: A laboratory manual* (ed. C.W. Dieffenbach and G.S. Dveksler), pp. 53–62. Cold Spring Harbor Laboratory Press, Cold Spring Harbor, New York.
- Roux K.H. and Hecker K.H. 1997. One-step optimization using touchdown and stepdown PCR. *Methods Mol. Biol.* **67**: 39–45.
- Rychlik W. 1994. New algorithm for determining primer efficiency in PCR and sequencing. *J. NIH Res.* **6**: 78.
- . 1995. Selection of primers for polymerase chain reaction. *Mol. Biotechnol.* **3**: 129–134.
- Rychlik W., Spencer W.J., and Rhoads R.E. 1990. Optimization of the annealing temperature for DNA amplification *in vitro* (erratum *Nucleic Acids Res.* [1991] **19**: 698). *Nucleic Acids Res.* **18**: 6409–6412.
- Sager R., Anisowicz A., Neveu M., Liang P., and Sotiropoulou G. 1993. Identification by differential display of alpha 6 integrin as a candidate tumor suppressor gene. *FASEB J.* **7**: 964–970.
- Saiki R.K., Scharf S., Faloona F., Mullis K.B., Horn G.T., Erlich H.A., and Arnheim N. 1985. Enzymatic amplification of beta-globin genomic sequences and restriction site analysis for diagnosis of sickle cell anemia. *Science* **230**: 1350–1354.
- Saiki R.K., Gelfand D.H., Stoffel S., Scharf S.J., Higuchi R., Horn G.T., Mullis K.B., and Erlich H.A. 1988. Primer-directed enzymatic amplification of DNA with a thermostable DNA polymerase. *Science* **239**: 487–491.
- Sandhu G.S., Precup J.W., and Kline B.C. 1993. Characterization of recombinant DNA vectors by polymerase chain reaction analysis of whole cells. *Methods Enzymol.* **218**: 363–368.
- Sarkar G., Kapelner S., and Sommer S.S. 1990. Formamide can dramatically improve the specificity of PCR. *Nucleic Acids Res.* **18**: 7465.
- Sathe G.M., O'Brien S., McLaughlin M.M., Watson F., and Livi G.P. 1991. Use of polymerase chain reaction for rapid detection of gene insertions in whole yeast cells. *Nucleic Acids Res.* **19**: 4775.
- Schaefer B.C. 1995. Revolutions in rapid amplification of cDNA ends: New strategies for polymerase chain reaction cloning of full-length cDNA ends. *Anal. Biochem.* **227**: 255–273.
- Scharf S.J., Horn G.T., and Erlich H.A. 1986. Direct cloning and sequence analysis of enzymatically amplified genomic sequences. *Science* **233**: 1076–1078.
- Schneeberger C. and Zeillinger R. 1996. PCR-mediated synthesis of exogenous competitors for quantitative RT-PCR. *BioTechniques* **20**: 360–362.
- Schneeberger C., Speiser P., Kury F., and Zeillinger R. 1995. Quantitative detection of reverse transcriptase-PCR products by means of a novel and sensitive DNA stain. *PCR Methods Appl.* **4**: 234–238.
- Schoettlin W., Nielson K.B., and Mathur E. 1993. Optimization of PCR using the opti-prime kit. *Strategies Newsletter* **6**: 43–44. Stratagene, La Jolla, California.
- Sederoff R. 1993. Availability of Taq polymerase. *Science* **259**: 1521–1522.
- Sellner L.N., Coelen R.J., and Mackenzie J.S. 1992. Reverse transcriptase inhibits Taq polymerase activity. *Nucleic Acids Res.* **20**: 1487–1490.
- Sharrocks A.D. 1994. The design of primers for PCR. In *PCR technology: Current innovations* (ed. H.G. Griffin and A.M. Griffin), pp. 5–11. CRC Press, Boca Raton, Florida.
- Sheffield V.C., Cox D.R., Lerman L.S., and Myers R.M. 1989. Attachment of a 40-base pair G + C-rich sequence (GC-clamp) to genomic DNA fragments by polymerase chain reaction results in an improved detection of single base changes. *Proc. Natl. Acad. Sci.* **86**: 232–236.
- Shuldiner A.R. and Tanner K. 1997. Rapid (ligase-free) subcloning of PCR products. *Methods Mol. Biol.* **67**: 69–78.
- Shuldiner A.R., Tanner K., Scott L.A., Moore C.A., and Roth J. 1991. Ligase-free subcloning: A versatile method to subclone

- polymerase chain reaction (PCR) products in a single day. *Anal. Biochem.* **194**: 9–15.
- Siebert P.D. and Larrick J.W. 1992. Competitive PCR. *Nature* **359**: 557–558.
- Silver J. and Keerikatte V. 1989. Novel use of polymerase chain reaction to amplify cellular DNA adjacent to an integrated provirus (erratum *J. Virol.* [1990] **64**: 3150). *J. Virol.* **63**: 1924–1928.
- Silverman G.A. 1993. Isolating vector-insert junctions from yeast artificial chromosomes. *PCR Methods Appl.* **3**: 141–150.
- . 1996. End-rescue of YAC clone inserts by inverse PCR. *Methods Mol. Biol.* **54**: 145–155.
- Silverman G.A., Ye R.D., Pollock K.M., Sadler J.E., and Korsmeyer S.J. 1989. Use of yeast artificial chromosome clones for mapping and walking within human chromosome segment 18q21.3. *Proc. Natl. Acad. Sci.* **86**: 7485–7489.
- Smith C., Day P.J., and Walker M.R. 1993. Generation of cohesive ends on PCR products by UDG-mediated excision of dU, and application for cloning into restriction digest-linearized vectors. *PCR Methods Appl.* **2**: 328–332.
- Sommer R. and Tautz D. 1989. Minimal homology requirements for PCR primers. *Nucleic Acids Res.* **17**: 6749.
- Sompayrac L., Jane S., Burn T.C., Tenen D.G., and Danna K.J. 1995. Overcoming limitations of the mRNA differential display technique. *Nucleic Acids Res.* **23**: 4738–4739.
- Spanakis E. 1993. Problems related to the interpretation of autoradiographic data on gene expression using common constitutive transcripts as controls. *Nucleic Acids Res.* **21**: 3809–3819.
- Steffens D.L., Sutter S.L., and Roemer S.C. 1993. An alternate universal forward primer for improved automated DNA sequencing of M13. *BioTechniques* **15**: 580–581.
- Stein H. and Hausen P. 1969. Enzyme from calf thymus degrading the RNA moiety of DNA-RNA hybrids: Effect on DNA-dependent RNA polymerase. *Science* **166**: 393–395.
- Strathmann M., Wilkie T.M., and Simon M.I. 1989. Diversity of the G-protein family: Sequences from five additional alpha subunits in the mouse. *Proc. Natl. Acad. Sci.* **86**: 7407–7409.
- Suggs S.V., Hirose T., Miyake T., Kawashima E.H., Johnson M.J., Itakura K., and Wallace R.B. 1981. Use of synthetic oligodeoxyribonucleotides for the isolation of specific cloned DNA sequences. In *Developmental biology using purified genes* (ed. D.D. Brown), pp. 683–693. Academic Press, New York.
- Sun Y., Hegamyer G., and Colburn N.H. 1994. Molecular cloning of five messenger RNAs differentially expressed in preneoplastic or neoplastic JB6 mouse epidermal cells: One is homologous to human tissue inhibitor of metalloproteinases-3. *Cancer Res.* **54**: 1139–1144.
- Sung Y.J. and Denman R.B. 1997. Use of two reverse transcriptases eliminates false-positive results in differential display. *BioTechniques* **23**: 462–468.
- Sutcliffe J.G. 1988. mRNA in the mammalian central nervous system. *Annu. Rev. Neurosci.* **11**: 157–198.
- Takagi S., Kimura M., and Katsuki M. 1992. A rapid and efficient protocol of the inverted PCR using two primer pairs. *BioTechniques* **13**: 176–178.
- Takumi T. 1997. Use of PCR for cDNA library screening. *Methods Mol. Biol.* **67**: 339–344.
- Telesnitsky A. and Goff S.P. 1993. RNase H domain mutations affect the interaction between Moloney murine leukemia virus reverse transcriptase and its primer-template. *Proc. Natl. Acad. Sci.* **90**: 1276–1280.
- Temesgen B. and Eschrich K. 1996. Simplified method for ligase-free cloning of PCR products. *BioTechniques* **2**: 828–832.
- Temin H.M. and Mizutani S. 1970. RNA-dependent DNA polymerase in virions of Rous sarcoma virus. *Nature* **226**: 1211–1213.
- Thein S.L. and Wallace R.B. 1986. The use of synthetic oligonucleotides as specific hybridization probes in the diagnosis of genetic disorders. In *Human genetic diseases: A practical approach* (ed. K.E. Davies), pp. 33–50. IRL Press, Oxford, United Kingdom.
- Thornton C.G., Hartley J.L., and Rashtchian A. 1992. Utilizing uracil DNA glycosylase to control carryover contamination in PCR: Characterization of residual UDG activity following thermal cycling. *BioTechniques* **13**: 180–184.
- Tindall K.R. and Kunkel T.A. 1988. Fidelity of DNA synthesis by the *Thermus aquaticus* DNA polymerase. *Biochemistry* **27**: 6008–6013.
- Triglia T., Peterson M.G., and Kemp D.J. 1988. A procedure for in vitro amplification of DNA segments that lie outside the boundaries of known sequences. *Nucleic Acids Res.* **16**: 8186.
- Trower M.K. 1996. A rapid PCR-based colony screening protocol for cloned inserts. *Methods Mol. Biol.* **58**: 329–333.
- Tsai S.J. and Wiltbank M.C. 1996. Quantification of mRNA using competitive RT-PCR with standard-curve methodology. *BioTechniques* **21**: 862–866.
- Utans U., Liang P., Wyner L.R., Karnovsky M.J., and Russell M.E. 1994. Chronic cardiac rejection: Identification of five up-regulated genes in transplanted hearts by differential mRNA display. *Proc. Natl. Acad. Sci.* **91**: 6463–6467.
- Varadaraj K. and Skinner D.M. 1994. Denaturants or cosolvents improve the specificity of PCR amplification of a G + C-rich DNA using genetically engineered DNA polymerases. *Gene* **140**: 1–5.
- Wada K., Wada Y., Ishibashi F., Gojobori T., and Ikemura T. 1992. Codon usage tabulated form the GenBank genetic sequence data. *Nucleic Acids Res.* **20**: 2111–2118.
- Wallace R.B., Johnson M.J., Suggs S.V., Miyoshi K., Bhatt R., and Itakura K. 1981. A set of synthetic oligodeoxyribonucleotide primers for DNA sequencing in the plasmid vector pBR322. *Gene* **16**: 21–26.
- Wang A.M., Doyle M.V., and Mark D.F. 1989. Quantitation of mRNA by the polymerase chain reaction (erratum *Proc. Natl. Acad. Sci.* [1990] **87**: 2865). *Proc. Natl. Acad. Sci.* **86**: 9717–9721.
- Wang X., Li X., and Feuerstein G.Z. 1998. Use of novel downstream primers for differential display RT-PCR. *BioTechniques* **24**: 382–386.
- Wang Y.R., Wu J.Y., Reaves S.K., and Lei K.Y. 1996. Enhanced expression of hepatic genes in copper-deficient rats detected by the messenger RNA differential display method. *J. Nutr.* **126**: 1772–1781.
- Warthoe P., Bauer D., Rohde M., and Strauss M. 1995. Detection and identification of expressed genes by differential display. In *PCR primer: A laboratory manual* (ed. C.W. Dieffenbach and G.S. Dveksler), pp. 421–438. Cold Spring Harbor Laboratory Press, Cold Spring Harbor, New York.
- Watanabe K., Sakai F., and Orii H. 1997. Stepwise dilution screening of a cDNA library by polymerase chain reaction. *Anal. Biochem.* **252**: 213–214.
- Weiner M.P. 1993. Directional cloning of blunt-ended PCR products. *BioTechniques* **15**: 502–505.
- Welsh J., Chada K., Dalal S.S., Cheng R., Ralph D., and McClelland M. 1992. Arbitrarily primed PCR fingerprinting

- of RNA. *Nucleic Acids Res.* **20**: 4965–4970.
- Wetmur J.G. 1991. DNA probes: Applications of the principles of nucleic acid hybridization. *Crit. Rev. Biochem. Mol. Biol.* **26**: 227–259.
- Weyant R.S., Edmonds P., and Swaminathan B. 1990. Effect of ionic and nonionic detergents on the Taq polymerase. *BioTechniques* **9**: 308–309.
- Wiesner R.J., Rüegg J.C., and Morano I. 1992. Counting target molecules by exponential polymerase chain reaction: Copy number of mitochondrial DNA in rat tissues. *Biochem. Biophys. Res. Commun.* **183**: 553–559.
- Wintersberger U. 1990. Ribonucleases H of retroviral and cellular origin. *Pharmacol. Ther.* **48**: 259–280.
- Wittwer C.T., Herrmann M.G., Moss A.A., and Rasmussen R.P. 1997a. Continuous fluorescence monitoring of rapid cycle DNA amplification. *BioTechniques* **22**: 130–138.
- Wittwer C.T., Ririe K.M., Andrew R.V., David D.A., Gundry R.A., and Balis U.J. 1997b. The LightCycler: A microvolume multi-sample fluorimeter with rapid temperature control. *BioTechniques* **22**: 176–181.
- Wybranietz W.A. and Lauer U. 1998. Distinct combination of purification methods dramatically improves cohesive-end subcloning of PCR products. *BioTechniques* **24**: 578–580.
- Yu L. and Bloem L.J. 1996. Use of polymerase chain reaction to screen phage libraries. *Methods Mol. Biol.* **58**: 335–339.
- Zhao S., Ooi S.L., and Pardee A.B. 1995. New primer strategy improves precision of differential display. *BioTechniques* **18**: 842–850.
- Zhao S., Molnar G., Zhang J., Zheng L., Averboukh L., and Pardee A.B. 1998. 3'-end cDNA pool suitable for differential display from a small number of cells. *BioTechniques* **24**: 842–852.
- Zimmermann J.W. and Schultz R.M. 1994. Analysis of gene expression in the preimplantation mouse embryo: Use of mRNA differential display. *Proc. Natl. Acad. Sci.* **91**: 5456–5460.
- Zimmermann K., Schögl D., and Mannhalter J.W. 1998. Digestion of terminal restriction endonuclease recognition sites on PCR products. *BioTechniques* **24**: 582–584.

# Chapter 9

---

## Preparation of Radiolabeled DNA and RNA Probes

### INTRODUCTION

### PROTOCOLS

- 1 Random Priming: Radiolabeling of Purified DNA Fragments by Extension of Random Oligonucleotides 9.4
- 2 Random Priming: Radiolabeling of DNA by Extension of Random Oligonucleotides in the Presence of Melted Agarose 9.9
  - Nick Translation: An Historical Note 9.12
- 3 Radiolabeling of DNA Probes by the Polymerase Chain Reaction 9.14
  - Additional Protocol: Asymmetric Probes 9.18
- 4 Synthesis of Single-stranded DNA Probes of Defined Length from Bacteriophage M13 Templates 9.19
- 5 Synthesis of Single-stranded DNA Probes of Heterogeneous Length from Bacteriophage M13 Templates 9.25
- 6 Synthesis of Single-stranded RNA Probes by In Vitro Transcription 9.29
  - Additional Protocol: Using PCR to Add Promoters for Bacteriophage-encoded RNA Polymerases to Fragments of DNA 9.36
- 7 Synthesis of cDNA Probes from mRNA Using Random Oligonucleotide Primers 9.38
- 8 Synthesis of Radiolabeled, Subtracted cDNA Probes Using Oligo(dT) as a Primer 9.41
- 9 Radiolabeling of Subtracted cDNA Probes by Random Oligonucleotide Extension 9.46
- 10 Labeling 3' Termini of Double-stranded DNA Using the Klenow Fragment of *E. coli* DNA Polymerase I 9.51
- 11 Labeling 3' Termini of Double-stranded DNA with Bacteriophage T4 DNA Polymerase 9.57
- 12 End Labeling Protruding 3' Termini of Double-stranded DNA with [ $\alpha$ - $^{32}$ P]Cordycepin 5'-Triphosphate or [ $\alpha$ - $^{32}$ P]dideoxyATP 9.60
- 13 Dephosphorylation of DNA Fragments with Alkaline Phosphatase 9.62
- 14 Phosphorylation of DNA Molecules with Protruding 5'-Hydroxyl Termini 9.66
- 15 Phosphorylation of DNA Molecules with Dephosphorylated Blunt Ends or Recessed 5' Termini 9.70
- 16 Phosphorylation of DNA Molecules with Protruding 5' Termini by the Exchange Reaction 9.73

## INFORMATION PANELS

Nonradioactive Labeling of Nucleic Acids	9.76
<i>E. coli</i> DNA Polymerase I and the Klenow Fragment	9.82
In Vitro Transcription Systems	9.87
Isolating Differentially Expressed cDNAs by Differential Screening and Cloning	9.89
Alkaline Phosphatase	9.92

**L** ABELED NUCLEIC ACIDS ARE USED IN MOLECULAR CLONING either as reagents or as probes:

- Labeled fragments of cloned DNA and oligonucleotides of defined size are used as *reagents* in chemical and enzymatic sequencing, nuclease S1 analysis of RNA, and band-shift experiments. In these cases, the labeled reagent is converted to products of different sizes, which can be detected by a variety of methods, gel electrophoresis being the most common.
- Labeled DNA, RNA, and oligonucleotide *probes* are used in hybridization-based techniques to locate and bind DNAs and RNAs of complementary sequence. These techniques include colony and plaque screening, Southern and northern analyses, in situ hybridization, and sequencing by hybridization.

In both cases, success depends on the facile introduction of labels into DNA or RNA by methods such as end-labeling, random priming, nick translation, in vitro transcription, and variations of the polymerase chain reaction (PCR). Some of these methods place the label in specific locations within the nucleic acid (e.g., at the 5' or 3' terminus); others generate molecules that are labeled internally at multiple sites. Some methods yield labeled single-stranded products, whereas others generate double-stranded nucleic acids. Finally, some generate probes of defined length, and others yield a heterogeneous population of labeled molecules. Table 9-1 summarizes the options available for radiolabeling nucleic acids and guides investigators to a method of labeling that suits the task at hand.

*Basic research may seem very expensive. I am a well-paid scientist. My hourly wage is equal to that of a plumber, but sometimes my research remains barren of results for weeks, months or years and my conscience begins to bother me for wasting the taxpayer's money. But in reviewing my life's work, I have to think that the expense was not wasted. Basic research, to which we owe everything, is relatively very cheap when compared with other outlays of modern society. The other day I made a rough calculation which led me to the conclusion that if one were to add up all the money ever spent by man on basic research, one would find it to be just about equal to the money spent by the Pentagon this past year.*

Albert Szent-Györgyi, *The Crazy Ape*

**TABLE 9-1 Methods Used to Radiolabel Nucleic Acids In Vitro**

METHOD	TYPE OF PROBE	POSITION OF RADIOLABEL	SIZE OF PROBE	CHIEF USES	SPECIFIC ACTIVITY	PROTOCOL NUMBER
Random priming using DNA templates	double-stranded DNA	internal	~400–600 nucleotides	Southern and northern blotting and for screening libraries	$\sim 2 \times 10^9$ dpm/ $\mu$ g	1,2
Random priming using RNA templates	single-stranded DNA or DNA-RNA hybrids	internal	~400–600 nucleotides	differential screening of cDNA libraries; subtracted probes; differential display	$\sim 1 \times 10^9$ dpm/ $\mu$ g	7,9
Oligo(dT) priming of cDNA synthesis from RNA templates	single-stranded cDNA or cDNA-RNA hybrids	internal	~400–600 nucleotides	subtracted probes; differential display	$\sim 1 \times 10^9$ dpm/ $\mu$ g	8
PCR	single- or double-stranded DNA	internal	generates radiolabeled DNAs of defined length, depending on the spacing of primers	mapping 5' termini and splice junctions in mRNA by nuclease S1 or mung bean nuclease; Southern and northern blotting and for screening libraries by hybridization; the probe represents a specific portion of the target gene	$\sim 1 \times 10^9$ to $2 \times 10^9$ dpm/ $\mu$ g	3
Nick translation	double-stranded DNA	internal	~400 nucleotides	Southern and northern blotting and for screening libraries	$5 \times 10^8$ to $1 \times 10^9$ dpm/ $\mu$ g	2 <sup>a</sup>
Primer extension using universal or target-specific primers and single-stranded DNA templates	double-stranded DNA	internal	generates radiolabeled DNAs of defined length from bacteriophage M13 or phagemid DNA templates; the length of the DNAs may be 150 bp to 2 kb, depending on the spacing of the primer on the template DNA	mapping 5' termini and splice junctions in mRNA by nuclease S1 or mung bean nuclease; Southern and northern blotting and for screening libraries by hybridization; the probe represents a specific portion of the target gene	$\sim 1 \times 10^9$ to $2 \times 10^9$ dpm/ $\mu$ g	4
Primer extension using two primers and single-stranded DNA templates	double-stranded DNA	internal	generates probes of heterogeneous length (usually 200–300 nucleotides)	Southern and northern blotting and for screening libraries	$\sim 1 \times 10^9$ to $2 \times 10^9$ dpm/ $\mu$ g	5
In vitro transcription of double-stranded DNA templates	single-stranded RNA	internal	generates radiolabeled RNAs of defined length	mapping the termini and splice junctions in mRNAs by RNase protection; Southern and northern blotting and for screening libraries; in situ hybridization	$\sim 1 \times 10^9$ dpm/ $\mu$ g	6
Addition of nucleotides to recessed or protruding 3' termini of double-stranded DNA	double-stranded DNA	3'-terminal	generates radiolabeled DNAs of defined length that are labeled in defined positions	Maxam-Gilbert sequencing; mapping the termini and splice junctions in mRNA by nuclease S1 or mung bean nuclease; radiolabeled DNA size markers; footprinting and ribonuclease protection	$1 \times 10^8$ to $2 \times 10^8$ dpm/ $\mu$ g	10,11,12
Phosphorylation of 5' termini of double-stranded DNA	double-stranded DNA	5'-terminal	generates radiolabeled DNAs of defined length that are labeled in defined positions	Maxam-Gilbert sequencing; mapping the termini and splice junctions in mRNA by nuclease S1 or mung bean nuclease; radiolabeled DNA size markers; footprinting and ribonuclease protection	$1 \times 10^8$ to $2 \times 10^8$ dpm/ $\mu$ g	13,14, 15, 16

<sup>a</sup>Please see Nick Translation: An Historical Note following Protocol 2 and *Molecular Cloning: A Laboratory Manual* (2nd edition, pages 10.6–10.12).

# Protocol 1

---

## Random Priming: Radiolabeling of Purified DNA Fragments by Extension of Random Oligonucleotides

**O**LIGONUCLEOTIDES CAN SERVE AS PRIMERS for initiation of DNA synthesis on single-stranded templates by DNA polymerases (Goulian 1969). If the oligonucleotides are heterogeneous in sequence, they will form hybrids at many positions, so that the complement of every nucleotide of the template (except those at the extreme 5' terminus) will be incorporated at equal frequency into the product. These products of DNA synthesis can be radiolabeled by using one [ $\alpha$ - $^{32}$ P]dNTP and three unlabeled dNTPs as precursors, generating probes with specific activities of  $5 \times 10^8$  to  $5 \times 10^9$  dpm/ $\mu$ g.

Taylor et al. (1976) reported the first use of random priming to generate radiolabeled probes for hybridization. However, the method did not find wide acceptance until the mid 1980s, when the ready availability of commercial DNA polymerases and oligonucleotide primers allowed Feinberg and Vogelstein (1983, 1984) to develop a set of standardized and hardy reaction conditions. These conditions have since been incorporated into labeling kits, which are marketed by several commercial manufacturers. However, random priming reactions are so robust and simple that kits are an unnecessary luxury. Labeling can be carried out with equal efficiency and greater economy using components purchased individually.

Random priming is inherently simpler than nick translation because the requirements for two nuclease activities (DNase I and 5'  $\rightarrow$  3' exonuclease) are eliminated. The radiolabeled products of random priming reactions are therefore more homogeneous in size and behave more reproducibly in hybridization reactions. In nick translation, the average size of the radiolabeled products cannot be controlled with great accuracy. In random priming, however, the average size of the probe DNA is under the control of the investigator since probe length is an inverse function of the primer concentration (Hodgson and Fisk 1987). These advantages have proven to be so decisive that random priming has almost completely replaced nick translation as the standard method of labeling of double-stranded DNA probes.



## COMPONENTS OF RANDOM PRIMING REACTIONS

---

### DNA Polymerase

Random priming reactions may be catalyzed by any of several DNA polymerases including, for example, *Taq* (Sayavedra-Soto and Gresshoff 1992). However, by virtue of its efficiency and tolerance of a wide range of conditions, the enzyme of choice is the Klenow fragment of *Escherichia coli* DNA polymerase I. As discussed in the information panel on **E. COLI DNA POLYMERASE I AND THE KLENOW FRAGMENT**, the Klenow fragment lacks 5'→3' exonuclease activity, so that the radioactive product is synthesized exclusively by primer extension rather than by nick translation and is not subject to exonuclease degradation. The reaction can be carried out at pH 6.6, where the 3'→5' exonuclease activity of the standard Klenow enzyme is much reduced (Lehman and Richardson 1964). Alternatively, Sequenase version 2.0 (USB Specialty Biochemicals) or variants of the Klenow fragment that lack 3'→5' exonuclease activity (Stratagene or New England Biolabs) can be used. Both of these enzymes lack the 3'→5' exonuclease activity of the Klenow fragment.

### Radiolabel

Random priming reactions typically contain one radiolabeled [ $\alpha$ -<sup>32</sup>P]dNTP (sp. act. 3000 Ci/mmol) and three unlabeled dNTPs as precursors. Under the reaction conditions described in this protocol, 40–80% of the [ $\alpha$ -<sup>32</sup>P]dNTP is incorporated into DNA and the specific activity of the radiolabeled product varies from  $1 \times 10^9$  to  $4 \times 10^9$  dpm/ $\mu$ g, depending on the amount of template DNA in the reaction. Although higher specific activities can be generated using two [ $\alpha$ -<sup>32</sup>P]dNTPs as precursors, the resulting probes degrade very rapidly due to radiochemical decay (Stent and Fuerst 1960) and must therefore be used without delay. When [ $\alpha$ -<sup>32</sup>P]dNTP of lower specific activity is used as a precursor (e.g., 800 Ci/mmol), the yield of DNA is increased fourfold and its specific activity is reduced to  $<10^9$  dpm/ $\mu$ g. Such probes are more than adequate for most purposes and can be stored frozen for several days before radiolytic degradation becomes a problem.

Deoxynucleotide triphosphates that carry reporter groups such as digoxigenin can be substituted for radioactive nucleotides. Approximately one modified base is incorporated per 25–35 nucleotides of DNA synthesized during a standard random priming reaction (Kessler et al. 1990). For further information, please see Appendix 9.

### Primers

Oligonucleotide primers can be generated by DNase I digestion of calf thymus DNA, by synthesis on an automated DNA synthesizer, or, far more easily, by purchase from a commercial source. The length of the primers is crucial. Oligonucleotides shorter than six bases in length are very poor primers, whereas those longer than seven bases in length have progressively greater tendency to self-anneal and self-prime (Suganuma and Gupta 1995). Ideally, therefore, populations of oligonucleotides used in random priming should be either six or seven nucleotides in length. All possible sequences should be represented in the population at equal frequencies.

The average size of the probe generated during random priming reactions is an inverse function of the concentration of primer (Hodgson and Fisk 1987): The length of radiolabeled product =  $k/\sqrt{\ln P_c}$ , where  $P_c$  is the concentration of primer.

The standard priming reaction described in this protocol contains between 60 ng and 125 ng of random hexamers or heptamers and generates radiolabeled products that are ~400–600

nucleotides in length, as determined by electrophoresis through either an alkaline agarose gel or a denaturing polyacrylamide gel. Higher concentrations of primer lead to steric hindrance or to exhaustion of the [ $\alpha$ - $^{32}$ P]dNTP precursor with a concomitant depression of yield; lower concentrations of primer generate populations of radiolabeled products that are so heterogeneous in length (0.4–4 kb; Hodgson and Fisk 1987) that they would be expected to hybridize with anomalous kinetics.

## Template DNA

The reaction conditions given in this protocol, adapted from Feinberg and Vogelstein (1983, 1984), are optimized for labeling of linear double-stranded DNA templates up to 1 kb in length. Shorter DNA templates generate probes of low specific activity that do not hybridize well under stringent conditions. Closed circular, double-stranded DNAs are inefficient templates and should be converted to linear molecules by digestion with a restriction enzyme before use in a random priming reaction. Wherever practicable, a purified segment of target DNA should be used as a template, rather than an entire plasmid. This greatly suppresses the level of background when the radiolabeled DNA is used as a hybridization probe (Feinberg and Vogelstein 1983, 1984).

## MATERIALS

---

**CAUTION:** Please see Appendix 12 for appropriate handling of materials marked with <!>.

### Buffers and Solutions

**Please see Appendix 1 for components of stock solutions, buffers, and reagents. Dilute stock solutions to the appropriate concentrations.**

*Ammonium acetate (10 M)*

Optional, please see Step 5.

*Ethanol*

Optional, please see Step 5.

*NA stop/storage buffer*

50 mM Tris-Cl (pH 7.5)

50 mM NaCl

5 mM EDTA (pH 8.0)

0.5% (w/v) SDS

*5× Random priming buffer*

250 mM Tris (pH 8.0)

25 mM MgCl<sub>2</sub>

100 mM NaCl

10 mM dithiothreitol

1 M HEPES (adjusted to pH 6.6 with 4 M NaOH)

Use a fresh dilution in H<sub>2</sub>O of 1 M dithiothreitol stock, stored at –20°C. Discard the diluted dithiothreitol after use.

### Enzymes and Buffers

*Klenow fragment of E. coli DNA polymerase I*

### Gels

*Alkaline agarose gel or denaturing polyacrylamide gel <!>*

Please see Step 4.

## Nucleic Acids and Oligonucleotides

### *dNTP solution containing three unlabeled dNTPs, each at 5 mM*

The composition of this solution depends on the [ $\alpha$ - $^{32}$ P]dNTP to be used. If radiolabeled dATP is used, the mix should contain dCTP, dTTP, and dGTP each at a concentration of 5 mM. If two radiolabeled dNTPs are used, this solution should contain the other two dNTPs each at a concentration of 5 mM. For advice on making and storing stock solutions of dNTPs, please see the information panel on **PREPARATION OF STOCK SOLUTIONS OF dNTPs AND ddNTPs FOR DNA SEQUENCING** in Chapter 12.

### *Random deoxynucleotide primers six or seven bases in length (125 ng/ $\mu$ l in TE, pH 7.6)*

Because of their uniform length and lack of sequence bias, synthetic oligonucleotides of random sequence are the primers of choice. Oligonucleotides of optimal length (hexamers and heptamers; Saganuma and Gupta 1995) can be purchased from a commercial source (e.g., Pharmacia or Boehringer Mannheim) or synthesized locally on an automated DNA synthesizer. Store the solution of primers at  $-20^{\circ}\text{C}$  in small aliquots.

### *Template DNA (5–25 ng/ $\mu$ l) in TE (pH 7.6)*

Purify the DNA to be radiolabeled by one of the methods described in Chapter 5.

This protocol works best when 25 ng of template DNA is used in a standard 50- $\mu$ l reaction. Larger amounts of DNA generate probes of lower specific activity; smaller amounts of DNA require longer reaction times. Please see note to Step 4.

## Radioactive Compounds

### *[ $\alpha$ - $^{32}$ P]dNTP (10 mCi/ml, sp. act. $>3000$ Ci/mmole) <!>*

To minimize problems caused by radiolysis of the precursor, it is best, whenever possible, to prepare radiolabeled probes on the day the [ $^{32}$ P]dNTP arrives in the laboratory.

## Special Equipment

*Boiling water bath or heating block preset to  $95^{\circ}\text{C}$*

*Microfuge tubes (0.5 ml)*

*Sephadex G-50 spun column, equilibrated in TE (pH 7.6)*

Optional, please see Step 5.

## METHOD

---

1. In a 0.5-ml microfuge tube, combine template DNA (25 ng) in 30  $\mu$ l of  $\text{H}_2\text{O}$  with 1  $\mu$ l of random deoxynucleotide primers (~125 ng). Close the top of the tube tightly and place the tube in a boiling water bath for 2 minutes.
2. Remove the tube and place it on ice for 1 minute. Centrifuge the tube for 10 seconds at  $4^{\circ}\text{C}$  in a microfuge to concentrate the mixture of primer and template at the bottom of the tube. Return the tube to the ice bath.
3. To the mixture of primer and template, add:
 

5 mM dNTP solution	1 $\mu$ l
5x random priming buffer	10 $\mu$ l
10 mCi/ml [ $\alpha$ - $^{32}$ P]dNTP (sp. act. 3000 Ci/mmole)	5 $\mu$ l
$\text{H}_2\text{O}$	to 50 $\mu$ l
4. Add 5 units (~1  $\mu$ l) of the Klenow fragment. Mix the components by gently tapping the outside of the tube. Centrifuge the tube at maximum speed for 1–2 seconds in a microfuge to transfer all the liquid to the bottom of the tube. Incubate the reaction mixture for 60 minutes at room temperature.

To label larger amounts of DNA, assemble reaction mixtures as described in Steps 3 and 4 and then incubate the reaction for 60 minutes. To label smaller amounts of DNA, incubate the reactions for times that are in inverse proportion to the amount of template added. For example, random priming reactions containing 10 ng of template DNA should be incubated for 2.5 hours.

To monitor the course of the reaction, measure the proportion of radiolabeled dNTPs that either is incorporated into material precipitated by trichloroacetic acid (TCA) or adheres to a DE-81 filter (please see Appendix 8).

Under these reaction conditions, the length of the radiolabeled product is ~400–600 nucleotides, as determined by electrophoresis through an alkaline agarose gel (Chapter 5, Protocol 8) or a denaturing polyacrylamide gel (Chapter 12, Protocol 8).

5. Add 10  $\mu$ l of NA stop/storage buffer to the reaction, and proceed with one of the following options as appropriate.

- Store the radiolabeled probe at  $-20^{\circ}\text{C}$  until it is needed for hybridization.

*or*

- Separate the radiolabeled probe from unincorporated dNTPs by either spun-column chromatography (please see Appendix 8) or selective precipitation of the radiolabeled DNA with ammonium acetate and ethanol (please see Appendix 8). This step is generally not required if >50% of the radiolabeled dNTP has been incorporated during the reaction.

Assuming that 50% of the radioactivity has been incorporated into TCA-precipitable material during the random priming reaction and that 90% of this material has been generated by random priming events on the template DNA (rather than self-priming of oligonucleotides), then the probe DNA would contain a total of  $\sim 4.5 \times 10^7$  dpm (enough for two to five Southern hybridizations of mammalian genomic DNA). The specific activity of the probe would be  $\sim 1.8 \times 10^9$  dpm/ $\mu$ g and the weight of DNA synthesized during the reaction would be 9.7 ng, which is enough to detect single-copy sequences in mammalian DNA by Southern analysis.

# Protocol 2

---

## Random Priming: Radiolabeling of DNA by Extension of Random Oligonucleotides in the Presence of Melted Agarose

**A** VARIATION OF THE METHOD DESCRIBED IN PROTOCOL 1 can be used to radiolabel DNA in slices cut from gels cast with low-melting-temperature agarose (Feinberg and Vogelstein 1983, 1984). Most of the materials required for this protocol are the same as those used in Protocol 1. However, the labeling buffer has been slightly modified to include unlabeled dNTPs and random oligonucleotide primers. According to the investigator's needs, the labeling reaction can be assembled from its individual components, as described in Protocol 1, or from the composite buffer, as described here. For further details concerning materials required for the method and on the specific activity and length of the generated probe, please see the introduction to Protocol 1.

### MATERIALS

---

**CAUTION:** Please see Appendix 12 for appropriate handling of materials marked with <!.>.

#### Buffers and Solutions

**Please see Appendix 1 for components of stock solutions, buffers, and reagents. Dilute stock solutions to the appropriate concentrations.**

*Ammonium acetate (10 M)*

Optional, please see Step 5.

*Bovine serum albumin (10 mg/ml)*

*Ethanol*

Optional, please see Step 5.

*Ethidium bromide <!.> (10 mg/ml) or SYBR Gold staining solution <!.>*

*NA stop/storage buffer*

50 mM Tris-Cl (pH 7.5)

50 mM NaCl

5 mM EDTA (pH 8.0)

0.5% (w/v) SDS

*5x Oligonucleotide labeling buffer*

250 mM Tris-Cl (pH 8.0)

25 mM MgCl<sub>2</sub>

20 mM dithiothreitol

2 mM each of the unlabeled dNTPs

1 M HEPES (adjusted to pH 6.6 with 4 N NaOH)

1 mg/ml random deoxynucleotide primers, six bases in length

Store the buffer in small aliquots at -20°C. The buffer may be frozen and thawed several times without harm.

The composition of the 5x oligonucleotide labeling buffer depends on the [ $\alpha$ -<sup>32</sup>P]dNTP to be used. If radiolabeled dATP is to be used, the buffer should contain dCTP, dTTP, and dGTP. If two radiolabeled dNTPs are used, the buffer should contain two unlabeled dNTPs. For advice on making and storing stock solutions of dNTPs, please see the information panel on **PREPARATION OF STOCK SOLUTIONS OF dNTPs AND ddNTPs FOR DNA SEQUENCING** in Chapter 12.

## Enzymes and Buffers

*Klenow fragment of E. coli DNA polymerase*

The Klenow fragment (5 units) is required in each random priming reaction.

## Gels

*Alkaline agarose gel or Denaturing polyacrylamide gel <!>*

Please see Step 4.

## Nucleic Acids and Oligonucleotides

*Random deoxynucleotide primers six or seven bases in length (125 ng/ $\mu$ l in TE, pH 7.6)*

Because of their uniform length and lack of sequence bias, synthetic oligonucleotides of random sequence are the primers of choice. Oligonucleotides of optimal length (hexamers or heptamers; Saganuma and Gupta 1995) can be purchased from a commercial source (e.g., Pharmacia or Boehringer Mannheim), or synthesized locally on an automated DNA synthesizer. Store the solution of primers at -20°C in small aliquots. Primers are incorporated into the 5x oligonucleotide labeling buffer.

*Template DNA*

The DNA to be labeled is recovered after electrophoresis through a low-melting-temperature agarose gel (e.g., FMC SeaPlaque LMT Agarose) (please see Steps 1-3 of this protocol). The gel should be cast and run in 1x Tris-acetate electrophoresis buffer (TAE). For details on casting and running low-melting-temperature gels, please see Chapter 5.

This protocol works best when 25 ng of template DNA is used in a standard 50- $\mu$ l reaction. Larger amounts of DNA generate probes of lower specific activity; smaller amounts of DNA require longer reaction times. Please see note to Step 4.

## Radioactive Compounds

*[ $\alpha$ -<sup>32</sup>P]dNTP (10 mCi/ml, sp. act. >3000 Ci/mmol) <!>*

To minimize problems caused by radiolysis of the precursor, it is best, whenever possible, to prepare radiolabeled probes on the day the [<sup>32</sup>P]dNTP arrives in the laboratory.

## Special Equipment

*Boiling water bath*

*Sephadex G-50 spun column, equilibrated in TE (pH 7.6)*

Optional, please see Step 5.

## METHOD

1. After electrophoresis, stain the gel with ethidium bromide (final concentration 0.5 µg/ml) or SYBR Gold, and excise the desired band, eliminating as much extraneous agarose as possible.
2. Place the band in a preweighed microfuge tube and measure its weight. Add 3 ml of H<sub>2</sub>O for every gram of agarose gel.
3. Place the microfuge tube in a boiling water bath for 7 minutes to melt the gel and denature the DNA.

If radiolabeling is to be carried out immediately, store the tube at 37°C until the template is required. Otherwise, store the tube at -20°C. After each removal from storage, reheat the DNA/gel slurry to 100°C for 3–5 minutes and then store at 37°C until the radiolabeling reaction is initiated.

4. To a fresh microfuge tube in a 37°C water bath or heating block, add in the following order:

5x oligonucleotide labeling buffer	10 µl
10 mg/ml bovine serum albumin solution	2 µl
DNA in a volume no greater than 32 µl	20–50 ng
10 mCi/ml [ $\alpha$ - <sup>32</sup> P]dNTP (sp. act. >3000 Ci/mmol)	5 µl
Klenow fragment (5 units)	1 µl
H <sub>2</sub> O	to 50 µl

Mix the components completely with a micropipettor. Incubate the reaction for 2–3 hours at room temperature or for 60 minutes at 37°C.

To label larger amounts of DNA, adjust the volume of the reaction mixture proportionately and incubate the reaction for 60 minutes. To label smaller amounts of DNA, incubate the reactions for times that are in inverse proportion to the amount of template added. For example, random priming reactions containing 10 ng of template DNA should be incubated for 2.5 hours.

To monitor the course of the reaction, measure the proportion of radiolabeled dNTPs that either are incorporated into material precipitated by TCA or that adhere to a DE-81 filter (please see Appendix 8).

Under these reaction conditions, the length of the radiolabeled product is ~400–600 nucleotides, as determined by electrophoresis through an alkaline agarose gel (Chapter 5, Protocol 8) or a denaturing polyacrylamide gel (Chapter 5, Protocol 9).

5. Add 50 µl of NA stop/storage buffer to the reaction, and proceed with one of the following options as appropriate:

- Store the radiolabeled probe at -20°C until it is needed for hybridization.

*or*

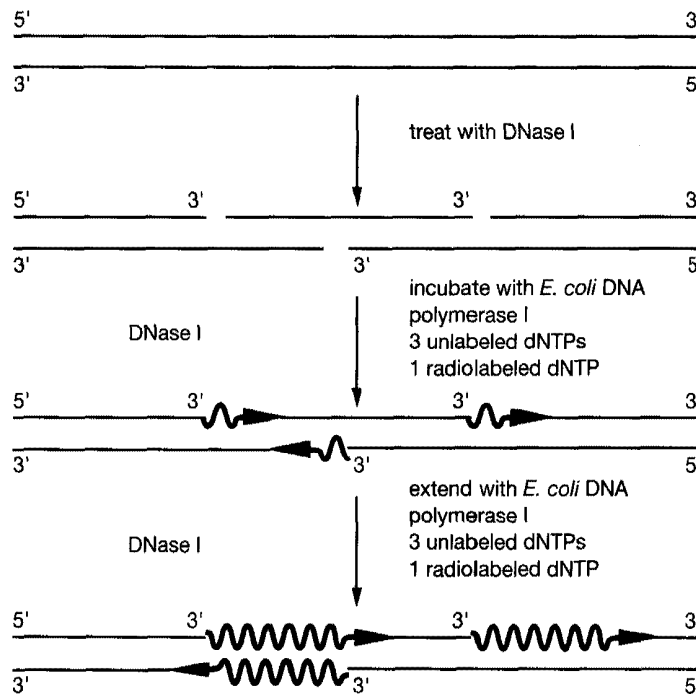
- Separate the radiolabeled probe from unincorporated dNTPs by either spun-column chromatography (please see Appendix 8) or selective precipitation of the radiolabeled DNA with ammonium acetate and ethanol (please see Appendix 8). This step is not required if >50% of the radiolabeled dNTP has been incorporated during the reaction.

Assuming that 50% of the radioactivity has been incorporated into TCA-precipitable material during the random priming reaction and that 90% of this material has been generated by random priming events on the template DNA (rather than self-priming of oligonucleotides), then the probe DNA would contain a total of  $\sim 4.5 \times 10^7$  dpm (enough for two to five Southern hybridizations of mammalian genomic DNA). The specific activity of the probe would be  $\sim 1.8 \times 10^9$  dpm/µg and the weight of DNA synthesized during the reaction would be 9.7 ng, which is enough to detect single-copy sequences.

**NICK TRANSLATION: AN HISTORICAL NOTE**

Until the early 1970s, radioactivity could be incorporated into nucleic acids only by metabolic labeling, in which radioactive precursors (usually in the form of  $H_3^{32}PO_4$ ) were introduced into cells that were synthesizing the DNA of interest. This procedure required amounts of radioactivity that would be unthinkable in today's more conservative climate; it involved laborious purification of the radiolabeled nucleic acids, and it could be applied only to a small number of DNAs (e.g., viral genomes). Salvation came in the mid 1970s when nick translation was developed as a method to radiolabel DNAs to high specific activity in vitro (Maniatis et al. 1975; Rigby et al. 1977).

Nick translation requires the activity of two different enzymes (please see Figure 9-1). DNase I is used to cleave (nick) phosphodiester bonds at random sites in both strands of a double-stranded target DNA. *E. coli* DNA polymerase I is used to add deoxynucleotides to the 3'-hydroxyl termini created by DNase I. In addition  
*(Continued on facing page.)*



**FIGURE 9-1 Nick Translation Using *E. coli* DNA Polymerase**

Single-stranded nicks are introduced into the DNA by treatment with DNase I. *E. coli* DNA polymerase (Pol I) binds to the nick or short gap in duplex DNA, and the 5'→3' exonuclease activity of Pol I then removes nucleotides from one strand of the DNA, creating a template for simultaneous synthesis of the growing strand of DNA. The original nick is therefore translated along the DNA molecule by the combined action of the 5'→3' exonuclease and the 5'→3' polymerase. In the reaction represented here, the nick in the upper strand of duplex DNA is translated from left to right by *E. coli* DNA polymerase in the presence of dNTPs. In the lower strand of duplex DNA, nick translation occurs from right to left. The stretches of newly synthesized DNA are represented by the colored wavy arrows.



to its polymerizing activity, DNA polymerase I carries a 5'→3' exonucleolytic activity that removes nucleotides from the 5' side of the nick. The simultaneous elimination of nucleotides from the 5' side and the addition of radiolabeled nucleotides to the 3' side result in movement of the nick (nick translation) along the DNA, which becomes labeled to high specific activity (Kelly et al. 1970). The reaction requires 100-fold less radioactive precursor than metabolic labeling while producing double-stranded probes whose specific activity is up to 200-fold higher. Such probes can be used for a variety of purposes including screening genomic and cDNA libraries and Southern and northern hybridizations.

After occupying a dominant position for many years, nick translation has been largely displaced by random oligonucleotide priming, which requires only one enzyme, as the method of choice for radiolabeling double-stranded DNA. A major problem with nick translation has always been the difficulty in balancing the activities of DNA polymerase I and DNase I used in the procedure. With the advent of nick translation kits (e.g., NIK-IT, Worthington Biochemical Inc.), this difficulty has been solved, although not in time to blunt the advance of random priming. Nevertheless, in a few laboratories, nick translation is still practiced — chiefly by those who remember its place in the history of cloning.

### Optimizing Nick Translation Reactions

The amount of radiolabel incorporated during nick translation depends on the number of 3'-hydroxyl termini created in the template DNA by DNase I. Too much nicking creates an excess of initiation sites, which leads to maximal incorporation of radiolabel but yields DNA fragments that are too short to be useful as hybridization probes. Too little nicking, on the other hand, restricts the number of sites available for initiation of nick translation, resulting in a product of low specific activity. (For additional details on DNase I, please see Appendix 4.) The activity of DNase I varies between preparations, and the amount of DNase contaminating preparations of *E. coli* DNA polymerase I can also differ. It is therefore necessary to titrate each new batch of DNase I to find a concentration that yields probes with the desired specific activity and length. The nicking and polymerization reactions can be carried out simultaneously; in which case, a slight lag is observed before incorporation of nucleotides begins (Rigby et al. 1977), reflecting the time required for DNase I to generate nicks in the template. This lag, which is usually of little practical significance, can be eliminated by carrying out the nicking and polymerization reactions sequentially, rather than simultaneously (Koch et al. 1986).

The aim is to establish empirically a concentration of DNase I that results in incorporation of ~40% of the [ $\alpha$ -<sup>32</sup>P]dNTP. A standard nick translation reaction carried out under these conditions yields a product whose specific activity exceeds 10<sup>8</sup> cpm/ $\mu$ g and whose radiolabeled DNA strands are ~400–750 nucleotides in length. It is thus necessary to determine empirically the optimum amounts of each enzyme required to obtain both high specific activity and appropriate probe length. This optimization is best accomplished by keeping the amount of DNA polymerase added constant (e.g., at 2.5 units) and varying the concentration of input DNase I.

Although *E. coli* DNA polymerase I works adequately with concentrations of dNTPs as low as 2  $\mu$ M, the enzyme catalyzes DNA synthesis much more efficiently when supplied with higher concentrations of substrates. For reasons of cost, nick translation reactions usually contain minimal concentrations of radiolabeled dNTPs (0.5–5  $\mu$ M) and much greater concentrations of unlabeled dNTPs (1 mM). The specific activity of the final product depends in large part on the specific activity of the radiolabeled dNTP used in the reaction. By diluting the radiolabeled dNTP with the homologous unlabeled dNTP, it is possible to prepare DNA labeled to different specific activities. If high specific activities (>5 × 10<sup>8</sup> dpm/ $\mu$ g) are required (e.g., for screening recombinant DNA libraries or for detecting single-copy sequences in Southern hybridizations of complex mammalian genomes), the nick translation reaction should contain all four radiolabeled dNTPs (sp. act. >800 Ci/mmole) and no unlabeled dNTPs. For most other purposes, it is adequate to use one dNTP labeled with  $\alpha$ -<sup>32</sup>P (800 Ci/mmole) and three unlabeled dNTPs, or to dilute each [ $\alpha$ -<sup>32</sup>P]dNTP with an appropriate amount of the unlabeled dNTP. The amount of radiolabeled dNTP in a solution of specific activity 800 Ci/mmole (~12 pmoles/ $\mu$ l) is ~3.75-fold higher than that in a solution of specific activity 3000 Ci/mmole (~3.3 pmoles/ $\mu$ l).

# Protocol 3

---

## Radiolabeling of DNA Probes by the Polymerase Chain Reaction

**T**HE POLYMERASE CHAIN REACTION (PCR) (PLEASE SEE CHAPTER 8) can be used to produce DNA probes with high specific activity. Listed below are the advantages of the method.

- Defined segments of the target DNA can be amplified and labeled independently of the location or type of restriction sites.
- There is no need to isolate fragments of DNA or to subclone them into vectors containing bacteriophage promoters.
- Only small amounts of template DNA are required (2–10 ng or ~1 fmole).
- The specific activity of the radiolabeled amplified DNA can exceed  $10^9$  dpm/ $\mu$ g.

Four different methods have been described for simultaneous amplification and radiolabeling of DNA. The first three methods require some information about the sequence of the target DNA, but the fourth method does not.

- **Double-stranded DNA probes can be produced in conventional PCRs** containing equal concentrations of two primers, three unlabeled dNTPs at concentrations exceeding the  $K_m$ , and one [ $\alpha$ - $^{32}$ P]dNTP at a concentration at or slightly above the  $K_m$  (2–3  $\mu$ M) (Jansen and Ledley 1989; Schowalter and Sommer 1989).
- **Radiolabeled probes biased heavily in favor of one strand of DNA** can be produced in PCRs in which the concentration of one primer exceeds the other by a factor of 20–200. During the initial cycles of the PCR, double-stranded DNA is synthesized in a conventional exponential fashion. However, when the concentration of one primer becomes limiting, the reaction generates single-stranded DNA that accumulates at an arithmetic rate. By the end of the reaction, the concentration of one strand of DNA is three to five times greater than the concentration of the other (Scully et al. 1990). (For more information, please see the panel on **ADDITIONAL PROTOCOL: ASYMMETRIC PROBES** at the end of this protocol.)
- **Radiolabeled probes consisting entirely of one strand of DNA** can be synthesized in thermal cycling reactions that contain a double-stranded DNA template but only one primer. Double-stranded template DNA (20 ng) generates ~200 ng of single-stranded probe over the course of 40 cycles. The length of the probe can be defined by cleaving the template DNA at a restriction site downstream from the binding site of the primer (e.g., please see Stürzl and Roth 1990; Finckh et al. 1991).

- **The target DNA may be digested with CviII**, a restriction enzyme that uses ATP as a cofactor to cleave the recognition sequence GC (except YGCR, where Y is a pyrimidine and R a purine) (Swaminathan et al. 1996). Because the dinucleotide GC occurs frequently in most DNAs, the modal size of the resulting blunt-ended DNA fragments is small — between 20 and 60 nucleotides. These fragments can be used as sequence-specific primers in PCRs in which an aliquot of the target DNA is used as template. The product is a heterogeneous population of double-stranded molecules whose size ranges from a minimum of ~60 bp to a maximum that exceeds the size of the target (Swaminathan et al. 1994). These larger molecules are thought to be complex scrambled versions of the target DNA that are generated from chimeric templates and/or primers. Investigators who feel uneasy about using a probe whose sequence is not colinear with the original template DNA may wish to avoid this method; others wanting to use a PCR-based technique in the absence of DNA sequence information may embrace it.

The following protocol, provided by Mala Mahendroo and Galvin Swift (University of Texas Southwestern Medical Center, Dallas), remains close to the original procedure of Schowalter and Sommer (1989) for the generation of double-stranded radiolabeled probes. A modification that describes how to generate asymmetric probes by PCR is presented in the panel on **ADDITIONAL PROTOCOL: ASYMMETRIC PROBES** at the end of this protocol.

## MATERIALS

**CAUTION:** Please see Appendix 12 for appropriate handling of materials marked with <!>.

### Buffers and Solutions

Please see Appendix 1 for components of stock solutions, buffers, and reagents. Dilute stock solutions to the appropriate concentrations.

*Ammonium acetate (10 M)*

*10x Amplification buffer*

*Carriers used during ethanol precipitation of radiolabeled probe (please see Step 5)*

Use either glycogen (stock solution = 50 mg/ml in H<sub>2</sub>O) or yeast tRNA (stock solution 10 mg/ml in H<sub>2</sub>O). For more information, please see Appendix 8.

*Chloroform <!>*

*Ethanol*

*TE (pH 7.6)*

### Enzymes and Buffers

*Thermostable DNA polymerase (e.g., Taq DNA polymerase)*

Thermostable DNA polymerase (2.5 units) is required for each amplification/labeling reaction.

### Nucleic Acids and Oligonucleotides

*dCTP (0.1 mM)*

Dilute 1 volume of a stock solution of 10 mM dCTP with 99 volumes of 10 mM Tris-Cl (pH 8.0). Store the diluted solution at -20°C in 50- $\mu$ l aliquots.

*dNTP solution containing dATP, dGTP, and dTTP, each at 10 mM*

For advice on making and storing stock solutions of dNTPs, please see the information panel on **PREPARATION OF STOCK SOLUTIONS OF dNTP AND ddNTPs FOR DNA SEQUENCING** in Chapter 12.

*Forward primer (20  $\mu$ M) in H<sub>2</sub>O and Reverse primer (20  $\mu$ M) in H<sub>2</sub>O*

Each primer should be 20–30 nucleotides in length and contain approximately equal numbers of the four bases, with a balanced distribution of G and C residues and a low propensity to form stable secondary structures. Store the stock solutions of primers at -20°C.

Oligonucleotide primers synthesized on an automated DNA synthesizer can generally be used in standard PCR without further purification. However, amplification and radiolabeling of single-copy sequences from mammalian genomic templates is often more efficient if the oligonucleotide primers are purified by chromatography on commercially available resins (e.g., NENSORB, NEN Life Science products) or by denaturing polyacrylamide gel electrophoresis, as described in Chapter 10, Protocol 1.

#### Template DNA (2–10 ng)

A variety of templates can be used in this protocol, including crude minipreparations of plasmid DNAs (please see Chapter 1, Protocol 1), purified bacteriophage  $\lambda$  DNA or plaque eluates (please see Chapter 2, Protocol 23), bacteriophage M13 single-stranded or double-stranded DNAs (please see Chapter 3, Protocol 5), purified DNA fragments isolated from agarose or polyacrylamide gels (please see Chapter 5, Protocol 1), and genomic DNAs from organisms with low complexity (e.g., bacteria and yeast).

When using the DNAs of recombinant bacteriophage  $\lambda$  or plasmids as templates, a small proportion of the radiolabeled probe may be derived from the vector sequences. This contamination arises if the oligonucleotide primers are complementary to flanking vector sequences or because the PCR will generate long “read-through” strands on the starting template DNA. For most hybridization applications, the presence of low levels of vector sequences will not interfere with the experiment. However, when screening libraries made in bacteriophage  $\lambda$  vectors or high-copy-number plasmid vectors (e.g., pUC, pBluescript, and pGEM vectors), the presence of vector sequences in the probe can lead to a substantial background. To manage this problem (1) use forward and reverse primers that are located within the target region, (2) use a gel-purified DNA fragment as a starting template for the amplification, and (3) cleave the template DNA with restriction enzyme(s) to prevent the synthesis of read-through strands.

## Radioactive Compounds

[ $\alpha$ - $^{32}\text{P}$ ]dCTP (10 mCi/ml, sp. act. 3000 Ci/mmol) <1>

To minimize problems caused by radiolysis of the precursor, it is best, whenever possible, to prepare radiolabeled probes on the day the [ $^{32}\text{P}$ ]dNTP arrives in the laboratory.

## Special Equipment

Barrier tips for automatic micropipettes

Microfuge tubes (0.5 ml, thin-walled tubes designed for PCR)

Positive-displacement pipette

Sephadex G-75 spun column, equilibrated in TE (pH 7.6)

Thermal cycler programmed with desired amplification protocol

If the thermal cycler is not equipped with a heated lid, use either mineral oil or a bead of paraffin wax to prevent evaporation of liquid from the reaction mixture during PCR.

## METHOD

1. In a 0.5-ml thin-walled microfuge tube, set up an amplification/radiolabeling reaction containing:

10x amplification buffer	5.0 $\mu\text{l}$
10 mM dNTP solution	1.0 $\mu\text{l}$
0.1 mM dCTP	1.0 $\mu\text{l}$
20 $\mu\text{M}$ forward oligonucleotide primer	2.5 $\mu\text{l}$
20 $\mu\text{M}$ reverse oligonucleotide primer	2.5 $\mu\text{l}$
template DNA (2–10 ng or $\sim$ 1 fmole)	5–10 $\mu\text{l}$
10 mCi/ml [ $\alpha$ - $^{32}\text{P}$ ]dCTP (sp. act. 3000 Ci/mmol)	5.0 $\mu\text{l}$
H <sub>2</sub> O	to 48 $\mu\text{l}$

Add 2.5 units of thermostable DNA polymerase to the reaction mixture. Gently tap the side of the tube to mix the ingredients.

If more than one DNA fragment is to be radiolabeled using a single pair of primers, make up and dispense a master mix consisting of all the reaction components except the DNA templates to the PCR tubes. Individual DNA templates can then be added to each tube just before addition of enzyme and initiation of the reaction.

2. If the thermal cycler is not fitted with a heated lid, overlay the reaction mixture with 1 drop (50  $\mu$ l) of light mineral oil or a bead of paraffin wax to prevent evaporation of the samples during repeated cycles of heating and cooling. Place the tubes in a thermal cycler.
3. Amplify the samples using the denaturation, annealing, and polymerization times listed in the table.

Cycle Number	Denaturation	Annealing	Polymerization
30 cycles	30–45 sec at 94°C	30–45 sec at 55–60°C	1–2 min at 72°C
Last cycle	1 min at 94°C	30 sec at 55°C	1 min at 72°C

These times are suitable for 50- $\mu$ l reactions assembled in thin-walled 0.5-ml tubes and incubated in thermal cyclers such as the Perkin-Elmer 9600 or 9700, Master Cycler (Eppendorf), and PTC 100 (MJ Research). Times and temperatures may need to be adapted to suit other types of equipment and reaction volumes.

Polymerization should be carried out for 1 minute for every 1000 bp of length of the target DNA.

Most thermal cyclers have an end routine in which the amplified samples are incubated at 4°C until they are removed from the machine. Samples can be left overnight at this temperature, but should be stored thereafter at -20°C.

4. Remove the tubes from the thermal cycler. Use a micropipettor to remove as much mineral oil from the top of the reaction mixture as possible. Extract the reaction mix with 50  $\mu$ l of chloroform to remove the remaining mineral oil. Separate the aqueous and organic layers by centrifugation for 1 minute at room temperature in a microfuge.
5. Remove the upper, aqueous layer to a fresh microfuge tube, add carrier tRNA (10–100  $\mu$ g) or glycogen (5  $\mu$ g), and precipitate the DNA with an equal volume of 4 M ammonium acetate and 2.5 volumes of ethanol. Store the tube for 1–2 hours at -20°C or for 10–20 minutes at -70°C. Collect the precipitated DNA by centrifugation at maximum speed for 5–10 minutes at 4°C.
6. Dissolve the DNA in 20  $\mu$ l of TE (pH 7.6) and remove remaining unincorporated dNTPs and the oligonucleotide primers by spun-column chromatography through Sephadex G-75 as described in Appendix 8.

Approximately 60% of the radioactivity should have been incorporated into DNA that elutes in the void volume during spun-column chromatography.

7. Use a liquid scintillation counter to measure the amount of radioactivity in 1.0  $\mu$ l of the void volume of the spun column. Store the remainder of the radiolabeled DNA at -20°C until required.

The yield of radiolabeled DNA ranges from 20 ng to 50 ng, and its specific activity is  $1 \times 10^9$  to  $2.5 \times 10^9$  dpm/ $\mu$ g.

**ADDITIONAL PROTOCOL: ASYMMETRIC PROBES**

By limiting the amount of one primer in the amplification reaction, a preponderance of one strand of the double-stranded DNA template will be synthesized during the amplification reaction (Gyllensten and Erlich 1988; Innis et al. 1988; Shyamala and Ames 1989, 1993; McCabe 1990; Scully et al. 1990). The resulting asymmetric probes can be used in northern hybridization to determine which strand of an unknown DNA represents the sense strand of a gene and which represents the antisense strand of a gene.

To synthesize an asymmetric probe in the above reaction, substitute a 0.4  $\mu\text{M}$  solution of *either* the forward oligonucleotide primer or the reverse primer for one of the standard 20  $\mu\text{M}$  primer solutions (please see Step 1 of the main protocol). Carry out the remainder of the protocol exactly as described.

Keep in mind that asymmetric amplification initially proceeds at an exponential rate and then slows to an arithmetic rate when the amount of one oligonucleotide primer becomes limiting. The specific activity of the asymmetric probe is the same as that produced in the normal PCR, but the amount of DNA synthesized in the reaction will be much less. Setting up multiple reactions at Step 1 can help compensate for the decrease in total yield of probe.

Also keep in mind that the bias in favor of one radiolabeled strand over the other is usually not more than a factor of 5. If necessary, this ratio can be improved (1) by separating the single- and double-stranded DNA products of the PCR by gel electrophoresis or anion-exchange chromatography (please see Appendix 8) or (2) by using a more complex, two-stage amplification procedure that enables a single-stranded probe to be produced in >20-fold excess (Finckh et al. 1991).

# Protocol 4

---

## Synthesis of Single-stranded DNA Probes of Defined Length from Bacteriophage M13 Templates

**I**N THIS PROTOCOL AND IN PROTOCOL 5, A SYNTHETIC OLIGONUCLEOTIDE annealed to single-stranded DNA derived from a recombinant bacteriophage M13 or phagemid template is used to prime the synthesis of complementary radiolabeled DNA (Ley et al. 1982). Synthesis is catalyzed by the Klenow fragment of *E. coli* DNA polymerase I, which extends the annealed primer for various distances along the single-stranded template DNA. The products of the reaction, which are heterogeneous both in length and in the amount of incorporated radiolabeled dNTPs, are digested with a restriction enzyme to create double-stranded DNA fragments of uniform length, which are subsequently purified by agarose gel electrophoresis. These probes are ideal for nuclease S1 or mung bean nuclease mapping of the 5' ends of mRNAs, for determining the positions of exons in a gene, for use in solution hybridization to quantitate mRNA, or for producing a probe that lacks vector sequences or represents only a small region of a cDNA or gene.

The oligonucleotide primer is usually complementary to a region of the *lac* gene immediately 3' to the polycloning site in the mp series of bacteriophage M13 vectors (Yanisch-Perron et al. 1985). This "universal" primer, which is sold by several companies, has the advantage that it can be used to prepare probes complementary to any segment of DNA that has been cloned into any restriction site in the polylinker of the vector (for further details, please see the information panel on **UNIVERSAL PRIMERS** in Chapter 8). However, custom-made oligonucleotides complementary to specific sequences within the cloned DNA can also be used to prepare probes that represent only a portion of the cloned sequence.

The size, specific activity, and yield of the probe synthesized by the Klenow fragment are affected by the relative concentrations of primer, template, and dNTPs. When the concentration of each of the four dNTPs in the reaction is greater than the  $K_m$  of the Klenow enzyme, synthesis of DNA occurs at a maximal rate. If the concentration of any one of the four precursors falls below the  $K_m$ , the rate of synthesis drops dramatically. Thus, when each of the four dNTPs is present at a concentration less than the  $K_m$ , as is often the case when only radiolabeled nucleotides are used as precursors, the yield of product can be extremely low. To avoid this problem, primer-extension reactions are usually carried out with three unlabeled dNTPs, each at a concentration in excess of the  $K_m$ , and one radiolabeled dNTP at a lower concentration, which is usually below the  $K_m$ . Under these conditions, the proportion of radiolabeled dNTPs incorporated into DNA is very high, even though the rate of the reaction may be far from maximal. The  $K_m$  of the enzyme is different for each deoxynucleoside triphosphate: 200  $\mu\text{M}$  for dCTP, 140  $\mu\text{M}$  for TTP, 45  $\mu\text{M}$  for dGTP, and 12  $\mu\text{M}$  for dATP (Travaglini et al. 1975).

When one or more dNTPs are present at limiting concentrations, the size of the product may be unacceptably small unless the amount of template in the reaction is also reduced. For example, in a reaction containing three unlabeled dNTPs each at a concentration in excess of the  $K_m$ , 16 pmoles (50  $\mu$ Ci) of a radiolabeled dNTP (sp. act. 3000 Ci/mmole), and 2 pmoles of template ( $\sim$ 1  $\mu$ g), an average of only 28 nucleotides will be added to each primer molecule before the synthesis is brought to a halt by a lack of the radiolabeled dNTP. However, if the template concentration is reduced 100-fold to 0.02 pmole ( $\sim$ 10 ng), an average of 3000 nucleotides will be added to each primer before the pool of precursors is exhausted.

To maximize the efficiency with which template molecules are used, the primer must be present in molar excess and the concentrations of primer and template must be high enough to drive the formation of primer-template hybrids to completion. These conditions are met when the primer is present in tenfold molar excess and its concentration is 200 pmoles/ml or greater. For some purposes, however, it is desirable to utilize the primer efficiently (e.g., when the primer is end-labeled). In this case, the primer:template ratio is reversed, so that the reaction contains a five- to tenfold molar excess of template.

Primer-extension reactions are usually carried out in the presence of excess Klenow fragment. If the enzyme is limiting, the number of DNA molecules initiated in the reaction (and hence the overall yield) will be reduced. However, the newly synthesized DNA molecules will be longer, on average, than DNA molecules synthesized when the enzyme is in excess.

Because it is possible to affect the size, specific activity, and yield of the probe by adjusting the conditions of the reaction, it is important to decide what particular combination of properties would be best suited for the task at hand. In RNA blotting and Southern hybridizations, where maximal sensitivity is often the overriding concern, the amount of template in the reaction should be kept to a minimum and the concentration of radiolabeled dNTP(s) should be increased as much as is practicable. When choosing which of the four radiolabeled dNTPs to use in the primer-extension reaction, consider the base composition of the probe to be synthesized and the  $K_m$  of the DNA polymerase for the individual dNTPs (please see above). When uniformly labeled probes are prepared for analysis of mRNAs by nuclease S1, the yield of full-length probe may be more important than its specific activity. In this case, the radiolabeled dNTP may be supplemented with unlabeled precursor until their combined concentration approaches the  $K_m$ . The yield of the reaction is determined by measuring the incorporation of radioactivity into either TCA-precipitable material or DE-81-bound molecules (please see Appendix 8), whereas the size of the product is assayed by gel electrophoresis.

## MATERIALS

**CAUTION:** Please see Appendix 12 for appropriate handling of materials marked with <!>.

### Buffers and Solutions

Please see Appendix 1 for components of stock solutions, buffers, and reagents. Dilute stock solutions to the appropriate concentrations.

*Ammonium acetate (10 M)*

*Dithiothreitol (1 M)*

*EDTA (0.5 M, pH 8.0)*

*Ethanol*

*NaCl (5 M)*

*Phenol:chloroform (1:1, v/v) <!>*

*5x TBE electrophoresis buffer*

Optional, please see Step 16.



Tris-Cl (1 M, pH 7.6)  
Optional, please see Step 16.

## Enzymes and Buffers

10× Klenow basic buffer

500 mM Tris-Cl (pH 7.5)

100 mM MgSO<sub>4</sub>

Sterilize the buffer by filtration and store it in small aliquots at -20°C.

Klenow fragment of *E. coli* DNA polymerase I

Restriction enzyme(s), as appropriate for generation of the desired probe

The restriction enzyme used to cleave the products of the labeling reaction should cleave between 200 bp and 1 kb downstream from the primer-binding site.

## Gels

Denaturing polyacrylamide gel <!> or alkaline agarose gel

Please see Step 13.

## Nucleic Acids and Oligonucleotides

dNTP solution containing unlabeled dCTP, dGTP, and dTTP, each at 20 mM

The composition of this solution depends on the [ $\alpha$ -<sup>32</sup>P]dNTP to be used. If, as in this protocol, radiolabeled dATP is used, the mix should contain dCTP, dTTP, and dGTP each at a concentration of 20 mM. If two radiolabeled dNTPs are used, this solution should contain the other two dNTPs. For advice on making and storing stock solutions of dNTPs, please see the information panel on **PREPARATION OF STOCK SOLUTIONS OF dNTPS AND ddNTPS FOR DNA SEQUENCING** in Chapter 12.

dATP (40  $\mu$ M and 20 mM)

Oligonucleotide primer (bacteriophage M13 Universal Primer or custom-synthesized oligonucleotide)

The best results are obtained with a purified oligonucleotide (please see the purification strategies using either gel electrophoresis or the oligonucleotide purification cartridge in Chapter 10, Protocol 1). Resuspend the oligonucleotide at a concentration of 5 pmoles/ $\mu$ l in TE (pH 7.6).

Template DNA

Purify the single-stranded bacteriophage M13 or phagemid DNA as described in Chapter 3, Protocol 4 or 8. Measure the concentration of the DNA by absorption spectrophotometry or staining with SYBR Gold as described in Appendix 9. Approximately 1  $\mu$ g of template DNA in a volume of 15  $\mu$ l or less is required for each synthetic reaction.

## Radioactive Compounds

[ $\alpha$ -<sup>32</sup>P]dATP (10 mCi/ml, sp. act. 800–3000 Ci/mmmole) <!>

To minimize problems caused by radiolysis of the precursor and the probe, it is best, whenever possible, to prepare radiolabeled probes on the day the [<sup>32</sup>P]dNTP arrives in the laboratory.

## Special Equipment

Adhesive dots marked with radioactive ink <!> or phosphorescent adhesive dots (e.g., Glogos from Stratagene)

Beaker (250 ml) filled with water at 85°C and a Microfuge tube holder

For an alternative, please see Step 2.

Sephadex G-50 spun column, equilibrated in TE (pH 7.6)

Optional, please see Step 12.

Water baths or heating blocks preset to 68°C and 85°C

Water bath preset to the appropriate temperature for restriction endonuclease digestion

## Additional Reagents

Step 17 of this protocol requires the reagents listed in Chapter 5, Protocol 4 or 12.

## METHOD

---

1. In a 0.5-ml microfuge tube, mix:

single-stranded template (bacteriophage M13 or phagemid DNA) (~0.5 pmole)	1 $\mu$ g
oligonucleotide primer	5 pmoles
10x Klenow basic buffer	3 $\mu$ l
H <sub>2</sub> O	to 20 $\mu$ l

2. Heat the mixture to 85°C for 5 minutes and then let it cool slowly to 37°C.

This slow cooling can be achieved by floating the microfuge tube in a piece of Styrofoam in a 250-ml beaker filled with water equilibrated to 85°C. Place the beaker containing the primer-template mix at room temperature until the temperature of the water falls to 37°C (~30 minutes). The same result can be achieved using a thermal cycler programmed to heat at 85°C for 5 minutes before ramping down to 37°C over a 30-minute period.

3. To the tube of annealed primer and template, add:

0.1 M dithiothreitol	2 $\mu$ l
10 mCi/ml [ $\alpha$ - <sup>32</sup> P]dATP (sp. act. 3000 Ci/mmol)	5 $\mu$ l
40 $\mu$ M dATP	1 $\mu$ l
20 mM solution of dTTP, dCTP, and dGTP	1 $\mu$ l

Mix the reagents by gently tapping the side of the tube. Centrifuge the tube at maximum speed for 1–2 seconds in a microfuge to transfer all of the liquid to the bottom.

As an alternative, substitute [ $\alpha$ -<sup>32</sup>P]dNTPs of sp. act. 800 Ci/mmol in this reaction, in which case, omit the 1  $\mu$ l of 40  $\mu$ M dATP.

4. Transfer 0.5  $\mu$ l of the mixture to a microfuge tube containing 15  $\mu$ l of 20 mM EDTA (pH 8.0). Store the tube on ice.
5. Add 1  $\mu$ l (5 units) of the Klenow fragment to the remainder of the mixture. Mix the components of the reaction by gently tapping the side of the tube. Incubate the reaction for 30 minutes at room temperature.  
Approximately 5 units of the Klenow fragment are required for each labeling reaction.
6. Transfer 0.5  $\mu$ l of the reaction to a fresh microfuge tube containing 20  $\mu$ l of 0.5 M EDTA (pH 8.0). Store the tube on ice.
7. Add 1  $\mu$ l of 20 mM unlabeled dATP to the remainder of the reaction. Mix by gently tapping the side of the tube. Centrifuge the tube at maximum speed for 1–2 seconds in a microfuge to transfer all of the liquid to the bottom. Incubate the reaction mixture for a further 20 minutes at room temperature.

The addition of unlabeled dATP increases the concentration of the precursor ~500-fold and ensures that all newly synthesized products will be extended past the site of restriction enzyme cleavage. If the reaction has gone well, 50–80% of the radioactivity will have been incorporated into DNA. Even though the proportion of the radiolabeled dNTP that has been incorporated is large, the length of the newly synthesized product is small when the sample is withdrawn from the reaction (Step 6). For example, suppose that 50% of the [ $\alpha$ -<sup>32</sup>P]dATP is incorporated into DNA. Since the reaction contained a total of 56 pmoles of dATP (16 pmoles radiolabeled and 40 pmoles unlabeled), a total of 28 pmoles of dATP has been incorporated into DNA. Assuming that each of the four dNTPs is equally represented in the product, a total of  $4 \times 28 = 112$  pmoles of dNTP has been incorporated into DNA. If primer binds to every molecule of template DNA in the reaction and if the Klenow fragment is in excess, then the average length of the product will be 224 nucleotides.

8. During the 20-minute incubation (Step 7), measure the fraction of radioactivity in the samples stored in Steps 4 and 6 that either has become insoluble in 10% TCA or that adheres to a DE-81 filter as described in Appendix 8.
9. Heat the reaction to 68°C for 10 minutes to inactivate the Klenow fragment.
10. Adjust the concentration of NaCl in the reaction to achieve optimal conditions for cleavage of the product by the selected restriction enzyme.

Remember that the concentration of NaCl in the primer-extension reaction is 50 mM.

If the restriction enzyme works best in the absence of NaCl, or if the enzyme requires unusual conditions (e.g., high concentrations of Tris or the presence of detergent), transfer the radiolabeled DNA to the appropriate buffer by one of the following two methods. (i) Purify the products of the primer-extension reaction by extraction with phenol:chloroform and precipitate with ethanol. After dissolving the precipitated DNA in 27  $\mu$ l of TE (pH 7.6), add 3  $\mu$ l of the appropriate 10x restriction buffer. (ii) Exchange the primer extension buffer by spun-column centrifugation before digestion (please see Appendix 8).
11. Add 20 units of the desired restriction enzyme, and incubate the reaction for 1 hour at the appropriate temperature.
12. Purify the DNA by standard extraction with phenol:chloroform, and remove unincorporated dNTPs by spun-column chromatography or differential precipitation with 2.5 M ammonium acetate and ethanol (for these procedures, please see Appendix 8). Add 0.5 M EDTA (pH 8.0) to a final concentration of 10 mM.

**▲ IMPORTANT** It is essential that free magnesium ions not be present when the DNA is exposed to alkali in the next step. Otherwise, the DNA will form an insoluble complex with  $Mg(OH)_2$ .
13. Isolate the radiolabeled DNA by electrophoresis through a denaturing polyacrylamide gel (please see Chapter 12, Protocol 8) or an alkaline agarose gel (please see Chapter 5, Protocol 8), depending on the size of the fragment.
14. After electrophoresis, prepare the gel for autoradiography. Expose the gel to X-ray film for 5–10 minutes.
15. Align the developed film with the gel, using the images from the phosphorescent dots (Glogos) or radioactive ink spots. Tape the film to the gel and mark the position of the primer-extended radioactive DNA fragment on the back of the gel plate. Remove the film and cut out the segment of the gel containing the desired fragment of DNA.
16. If a polyacrylamide gel was used to separate the DNA fragment from the template, proceed to Step 17. If an alkaline agarose gel was used, neutralize the gel by gentle shaking for 45 minutes in 0.5 M Tris-Cl (pH 7.6), followed by shaking for an additional 45 minutes in 0.5x TBE before the radiolabeled DNA is eluted.
17. Extract the DNA from the gel by electroelution or by crushing and soaking the polyacrylamide gel slice in an appropriate buffer (please see Chapter 5, Protocols 4 and 12, respectively).

Check the efficiency of the elution process with a hand-held minimonitor.

The eluted DNA is ready for use as a probe and does not need to be denatured further.

**TROUBLESHOOTING: PREMATURE TERMINATION OF NEWLY SYNTHESIZED DNA CHAINS**

The most common problem with synthesis of single-stranded probes by primer extension is premature termination of synthesis. This termination occurs for a variety of reasons, most of which originate with the radiolabeled dNTP, which is the rate-limiting component in the reaction mixture. Obviously, if the single-stranded DNA synthesis does not extend to a restriction site either within or downstream from the region of interest, the probe cannot be recovered as a discrete band by gel electrophoresis. To minimize this problem, try the following:

- **Use fresh radioisotopes.** Radioactive dNTPs that have been thawed more than twice are incorporated less efficiently into DNA by DNA polymerases.
- **Use a freshly made reaction mixture.** Dilute solutions of dNTPs are not stable for long periods when stored at  $-20^{\circ}\text{C}$ .
- **Keep the amount of template in the reaction to a minimum.** The greater the number of template molecules in the reaction, the shorter the length of the newly synthesized chains.
- **Engineer the bacteriophage M13 or phagemid recombinant so that the probe will be as short as possible.** If the average length of the DNA synthesized during the first stage of the reaction (i.e., before addition of the unlabeled dNTP) is less than the final length of the probe, the specific activity of the 5' terminus of the probe will be considerably higher than that of the 3' terminus. In general, this asymmetry does not matter when the probes are to be used in northern or Southern hybridization. However, it can vitiate attempts to use the probe in nuclease S1 mapping of RNAs. This problem can be minimized by ensuring that the final length of the probe is less than the length of the DNA synthesized during the first stage of the reaction.

# Protocol 5

---

## Synthesis of Single-stranded DNA Probes of Heterogeneous Length from Bacteriophage M13 Templates

**T**HE METHOD DESCRIBED IN PROTOCOL 4 GENERATED PROBES of defined length; however, the technique described in this protocol produces a heterogeneous population of radiolabeled molecules of differing lengths. These probes are synthesized, as before, from a single-stranded DNA template but are then separated from the template by electrophoresis through a denaturing gel from which they are eluted directly into hybridization buffer. During synthesis, the low concentration of radiolabeled dNTP limits the length of the probes to 200–300 nucleotides. However, the length of the newly synthesized DNA can be adjusted from 100 to 1000 nucleotides by varying the concentration of input template and dNTPs as discussed in the introduction to Protocol 4. Probes within this size range work well in most hybridization formats.

The following protocol, based on the method of Church and Gilbert (1984) and provided by M. Lehrman and D. Davis (University of Texas Southwestern Medical Center, Dallas), is useful for synthesizing single-stranded DNA probes of very high specific activity for Southern analysis of single-copy genes in complex genomes or for northern analysis of rare species of mRNAs.

### MATERIALS

---

**CAUTION:** Please see Appendix 12 for appropriate handling of materials marked with <!.>.

#### Buffers and Solutions

**Please see Appendix 1 for components of stock solutions, buffers, and reagents. Dilute stock solutions to the appropriate concentrations.**

*Elution buffer (1x SSPE containing 0.5% SDS)*

*Formamide dye buffer <!.>*

*MgCl<sub>2</sub> (1 M)*

*NaOH (10 N) <!.>*

*3x Probe synthesis buffer*

62 μM each dATP, dTTP, dGTP

0.5 mg/ml bovine serum albumin (Fraction V, Sigma)

625 μM dithiothreitol

32 mM Tris-Cl (pH 7.5)

6.5 mM MgSO<sub>4</sub>

Store the buffer at –20°C in 100-μl aliquots. Use a fresh aliquot for each batch of radiolabeled probe.

Discard the unused portion of each aliquot.

## Enzymes and Buffers

*Klenow fragment of E. coli DNA polymerase I*

## Gels

*Polyacrylamide gel (5%) containing 7 M urea <1>*

Cast and run the gel in 0.5x TBE as described in Chapter 12, Protocol 8.

## Nucleic Acids and Oligonucleotides

*Oligonucleotide primer (bacteriophage M13 Universal Primer or custom-synthesized oligonucleotide)*

The best results are obtained with a purified oligonucleotide (please see the purification strategies using either gel electrophoresis or an oligonucleotide purification cartridge in Chapter 10, Protocol 1). Resuspend the oligonucleotide at a concentration of 5 pmoles/ $\mu$ l in TE (pH 7.6).

*Template DNA*

Purify the single-stranded bacteriophage M13 or phagemid DNA as described in Chapter 3, Protocol 4 or 8, respectively. Measure the concentration of the DNA by absorption spectrophotometry as described in Appendix 8. Approximately 0.3  $\mu$ g of template DNA in a volume of 2–3  $\mu$ l is required for each synthesis.

## Radioactive Compounds

*[ $\alpha$ - $^{32}$ P]dCTP (10 mCi/ml, sp. act. 800–3000 Ci/mmmole) <1>*

To minimize problems caused by radiolysis of the precursor and the probe, it is best, whenever possible, to prepare radiolabeled probes on the day the [ $^{32}$ P]dNTP arrives in the laboratory.

## Special Equipment

*Air incubator or shaking water bath preset to 50°C*

*Boiling water bath*

*Disposable inoculating stick*

*Fritted column (e.g., Quik-sep columns, Isolab, Inc.)*

*Heating block preset to 57°C*

*Plastic snap-cap tubes (12 x 17 mm)*

## METHOD

---

1. In a 0.5-ml microfuge tube, mix:

single-stranded template (bacteriophage M13 or phagemid DNA) (~0.15 pmole, ~0.1 $\mu$ g/ $\mu$ l)	0.3 $\mu$ g
oligonucleotide primer (5 pmoles/ $\mu$ l)	1 $\mu$ l
25 mM MgCl <sub>2</sub>	1 $\mu$ l

If possible, include in each experiment a reaction tube containing a control DNA template and an oligonucleotide that has worked well previously. This reaction serves as a positive control.

2. Cap the tube and incubate the reaction mixture for 5–10 minutes at 57°C in a heating block.

3. Transfer the tube from the heating block to a bucket of ice, and add to the reaction mixture:

3x probe synthesis buffer	4 $\mu$ l
10 mCi/ml [ $\alpha$ - $^{32}$ P]dCTP (sp. act. 3000 Ci/mmol)	3 $\mu$ l
Klenow fragment (~2.5 units)	0.5 $\mu$ l

Mix the reagents by gently tapping the side of the tube. Centrifuge the tube at maximum speed for 1–2 seconds in a microfuge to transfer all of the liquid to the bottom. Incubate the reaction at 37°C for 40 minutes.

4. While the primer reaction is incubating, pour a 5% polyacrylamide gel containing 7 M urea in 1x TBE buffer (please see Chapter 12, Protocol 8). The gel should be 1.5-mm thick, at least 15-cm long, with 2.5-cm wide slots. Prerun the gel for 15 minutes at 20–25 V/cm of gel length to remove ammonium persulfate from the wells.
5. Stop the primer-extension reaction by adding 25  $\mu$ l of formamide dye buffer and heating the reaction mixture in a boiling water bath for 3–5 minutes. Transfer the tube to an ice bucket and add 1  $\mu$ l of 1 N NaOH.

6. Wash urea and loose fragments of polyacrylamide from the wells of the gel using a syringe loaded with 1x TBE, and immediately load the DNA samples. Separate the radiolabeled probe from the template DNA by electrophoresis for 30 minutes at 20–25 V/cm of gel length.

It is unnecessary to include DNA size standards on the polyacrylamide gel because the xylene cyanol dye migrates to a position comparable to that of a DNA fragment of ~125 bases.

7. After 30 minutes, separate the gel plates, cover the gel with Saran Wrap, and locate the radiolabeled DNA by autoradiography (please see Appendix 9). Expose the gel to X-ray film for ~1 minute.

The majority of the radiolabeled DNA should have migrated slightly slower than the xylene cyanol (green) tracking dye. Although a continuous smear of radiolabeled material is the expected result, in practice, between three and ten bands of discrete length are usually detected that may be spaced over a distance of 2–3 cm of the gel. The cause of the discrete bands is presumed to be secondary structures in the particular single-stranded DNA template used in the reaction.

8. Cut the radioactive bands out of the gel with a clean razor blade. Place them in the bottom of a 12 x 17-mm plastic snap-cap tube and crush with a disposable inoculating stick. Add 1–2 ml of elution buffer and shake the fragments of gel for >3 hours at 50°C.

Elution of the radioactive probe is more efficient if individual bands are cut from the gel, rather than excising a wide swath of polyacrylamide that spans all the bands.

9. Place the eluate in a fritted column, place the column in a 12 x 17-mm plastic snap-cap tube, and centrifuge in a desktop clinical centrifuge for 1–2 minutes. Measure the amount of radioactivity in 1  $\mu$ l of the radioactive probe by liquid scintillation spectroscopy.

A successful synthesis should yield ~10,000–20,000 dpm/ $\mu$ l.

#### TROUBLESHOOTING

If the DNA synthesis reaction is inefficient, little or no radiolabeled material will be detected above the position of xylene cyanol in the gel. In the worst case, all of the radioactivity, which corresponds to unincorporated [ $\alpha$ - $^{32}\text{P}$ ]dCTP, will migrate with the bromophenol blue dye. The causes of these problems vary and include:

- **The quality of the 3 $\times$  probe synthesis buffer.** Because this buffer contains dNTPs and dithiothreitol, it is not stable to repeated thawing and freezing. Store the buffer in small aliquots and discard unused buffer after each reaction.
- **The integrity of the template and the concentration of the oligonucleotide primer.** Confirm that the template is intact and its concentration is correct by analyzing a small sample by agarose gel electrophoresis. Purify the oligonucleotide primer by polyacrylamide gel electrophoresis or by column chromatography (please see Chapter 10, Protocol 1). If problems persist, purify a new batch of template DNA and resynthesize the primer.
- **The age and quality of the radioactive dNTP.** Probes of the highest specific activity and correct length are synthesized on the day of arrival of a radioactive shipment from the manufacturer. As the radiolabeled dNTP decays, the effective concentration of the precursor falls and the size of the DNA products decreases.
- **The age and quality of the Klenow enzyme.** Problems with the enzyme can be detected by including an appropriate positive control reaction (please see Step 1).



# Protocol 6

---

## Synthesis of Single-stranded RNA Probes by In Vitro Transcription

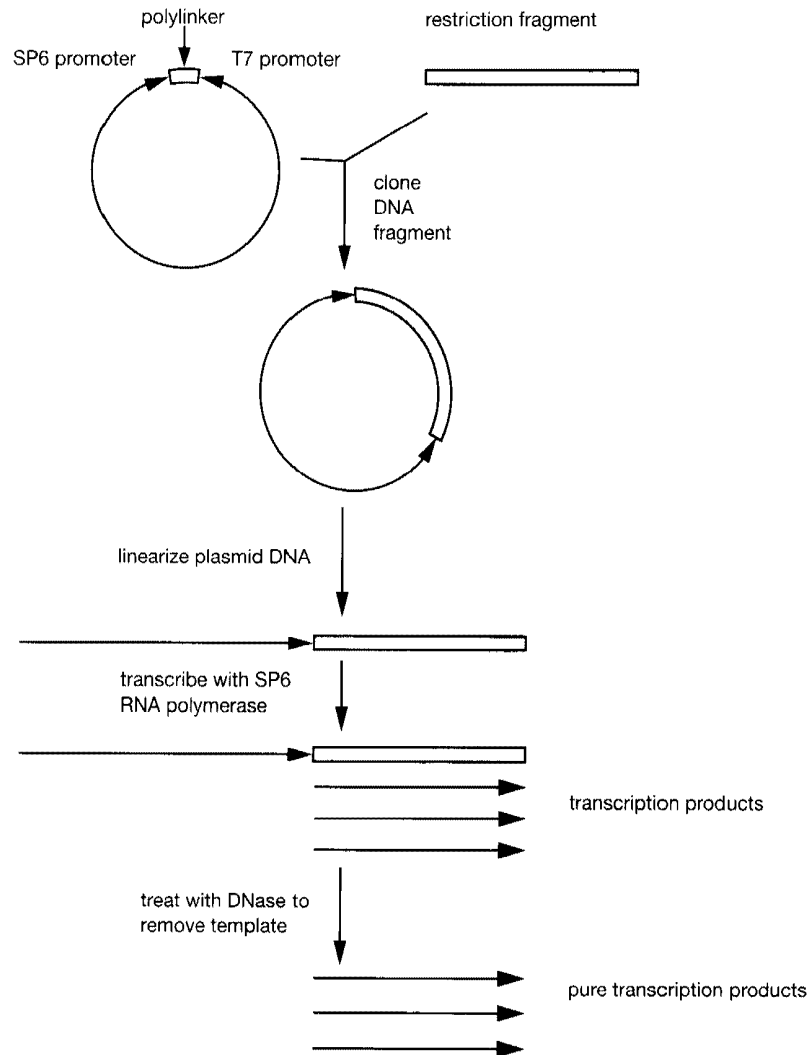
**S**TRAND-SPECIFIC, SINGLE-STRANDED RNA PROBES not only are easier to make than DNA probes, but also generally yield stronger signals in hybridization reactions than do DNA probes of equal specific activity. This is probably a result of the innately higher stability of hybrids involving RNA (Casey and Davidson 1977). DNA probes continue to be of general utility in, for example, northern and Southern hybridizations, but radiolabeled RNAs are now the probes of choice when analyzing transcripts of mammalian genes. Instead of digesting DNA-RNA hybrids with the idiosyncratic nuclease S1, RNA-RNA hybrids are digested with RNase A, a durable and obedient enzyme that can be used at a wide range of concentrations without compromising the results of the experiment (Zinn et al. 1983; Melton et al. 1984) (please see Chapter 7, Protocol 11).

The templates for transcribing RNA probes are generated by linearizing recombinant plasmids that carry a powerful bacteriophage promoter immediately upstream of the DNA fragment of interest (please see Figure 9-2) or by using PCR to generate templates whose 5' ends encode a bacteriophage promoter (please see the panel on **ADDITIONAL PROTOCOL: USING PCR TO ADD PROMOTERS FOR BACTERIOPHAGE-ENCODED RNA POLYMERASES TO FRAGMENTS OF DNA** at the end of this protocol).

### PLASMID VECTORS USED FOR IN VITRO TRANSCRIPTION

---

Many plasmid and phagemid vectors are commercially available that contain various combinations of bacteriophage promoters and polycloning sites (e.g., the pGEM series and the pSP series; please see Appendix 3). Some of these vectors also encode the *lacZ*  $\alpha$ -complementing fragment, which allows selection by color of recombinants on plates containing X-gal (5-bromo-4-chloro-3-indolyl- $\beta$ -D-galactopyranoside). The choice among these vectors is largely a matter of personal preference. However, if transcripts of both strands of the template are required, it is better to use a vector carrying two different bacteriophage promoters than to clone the template in two orientations in a vector carrying a single promoter. It is also important to consider the disposition of restriction sites within the template DNA and downstream from it. The 5' terminus of the transcript is fixed by the bacteriophage promoter, but the 3' terminus is defined by the downstream site of cleavage by the restriction enzyme. By using different restriction enzymes, RNAs of various lengths can be synthesized from a series of linear templates generated from the same plasmid.



**FIGURE 9-2 In Vitro Synthesis of RNA by Bacteriophage-encoded RNA Polymerases**

The DNA sequence to be transcribed is cloned into a restriction site in a polycloning region that is flanked by promoters for two bacteriophage polymerases (usually T7 and SP6). The DNA is then linearized with a restriction enzyme that cleaves downstream from the region to be transcribed. This cleavage prevents synthesis of multimeric transcripts from circular template DNA. Transcription begins from the promoter proximal to the insert when the appropriate polymerase and rNTPs are added in a suitable buffer. The RNA products, which are complementary to one strand of the template, are equal in length to the distance between the active promoter and the end of the linear DNA distal to the target sequences. At the end of the reaction, the template is removed by digestion with RNase-free DNase. Unincorporated nucleotides and oligodeoxynucleotides produced by digestion of the template DNA with DNase can be removed by chromatography through Sephadex G-75. (Adapted, with permission, from Krieg and Melton 1987 [©Academic Press].)

However, the presence of plasmid sequences in RNA probes can increase the level of background hybridization to levels that are unacceptable if the probe is to be used to screen a plasmid or cosmid library.

During generation of template DNAs, complete cleavage of superhelical plasmid DNA by a restriction enzyme is essential. Small amounts of circular plasmid DNAs will dramatically reduce yields by producing multimeric transcripts. Restriction enzymes that generate blunt or 5'-pro-

truding termini produce the best linear templates. However, both of these types of termini yield RNA products that show heterogeneity at their 3' ends (Melton et al. 1984; Milligan and Uhlenbeck 1989). Transcription of templates with 3'-protruding termini results in the synthesis of significant amounts of RNA molecules that are aberrantly initiated at the termini of the templates and thus in the production of double-stranded RNA molecules (Schenborn and Mierendorf 1985). Restriction enzymes that generate protruding 3' termini should therefore be avoided.

In addition to plasmids, some bacteriophage and cosmid vectors also contain bacteriophage promoters, usually arranged in opposite orientations on either side of the cloning site for foreign DNA. When a recombinant constructed in a vector of this type is digested with a restriction enzyme that cleaves many times within the foreign DNA, a large number of fragments are generated, one of which contains a particular bacteriophage promoter and the foreign sequences that lie immediately adjacent to it. If the fragments do not carry protruding 3' termini, only the fragment bearing the bacteriophage promoter serves as a template for *in vitro* transcription. The resulting radiolabeled RNA, which is complementary to sequences located at one end of the original segment of foreign DNA, can then be used as a probe to isolate overlapping clones from genomic DNA or cDNA libraries. These vectors greatly simplify the task of "walking" from one recombinant clone to another along the chromosome. The following are two highly efficient methods available to generate strand-specific RNA probes:

- The relevant DNA fragment may be cloned or subcloned into specialized plasmids that contain promoters for bacteriophage-encoded DNA-dependent RNA polymerases. The recombinant plasmids are a source of double-stranded templates that can be transcribed *in vitro* into single-stranded RNAs of defined length and strand specificity (Zinn et al. 1983; Melton et al. 1984).
- The DNA fragment to be transcribed may be amplified in PCRs with primers whose 5' ends encode synthetic promoters for bacteriophage-encoded DNA-dependent RNA polymerases. Following purification, the products of the PCRs are used as double-stranded templates for *in vitro* transcription reactions (Logel et al. 1992; Bales et al. 1993; Urrutia et al. 1993).

In both cases, the synthesis of RNA is remarkably efficient. When *in vitro* transcription reactions are saturated with ribonucleoside triphosphates (rNTPs), the templates can be transcribed many times, yielding a mass of RNA that exceeds the weight of the template severalfold. In addition, because bacteriophage-encoded DNA-dependent RNA polymerases function efficiently *in vitro* in the presence of relatively low concentrations of rNTPs (1–20  $\mu\text{M}$ ), full-length probes of high specific activity can be synthesized relatively inexpensively. Finally, RNA probes can be freed from template DNA by treating the reaction products with RNase-free DNase I. Probes usually do not need to be purified by gel electrophoresis. However, when using RNA probes of high specific activity to detect rare mRNA transcripts, background hybridization can be kept to a minimum using probes purified by denaturing gel electrophoresis.

In this protocol, we describe procedures for synthesizing RNA probes of high specific activity from plasmids containing promoters for bacteriophage-encoded RNA polymerases. An additional protocol deals with the generation and transcription of PCR products. Guidance and background information on both methods are provided in the information panels:

- The enzymatic properties of RNA polymerases used in the transcription reactions are described in the information panel on **IN VITRO TRANSCRIPTION SYSTEMS** at the end of this chapter.
- Necessary precautions to reduce problems with contaminating RNases are outlined in the information panel on **HOW TO WIN THE BATTLE WITH RNASE** in Chapter 7.

## MATERIALS

▲ **IMPORTANT** Prepare all reagents used in this protocol with DEPC-treated H<sub>2</sub>O (please see the information panel on **HOW TO WIN THE BATTLE WITH RNASE** in Chapter 7).

**CAUTION:** Please see Appendix 12 for appropriate handling of materials marked with <!.>.

### Buffers and Solutions

Please see Appendix 1 for components of stock solutions, buffers, and reagents.  
Dilute stock solutions to the appropriate concentrations.

*Ammonium acetate (10 M)*

Optional, please see Step 8.

*Bovine serum albumin (2 mg/ml, Fraction V, Sigma)*

*Dithiothreitol (1 M)*

*Ethanol*

*Phenol:chloroform (1:1, v/v) <!.>*

*Placental RNase inhibitor (20 units/μl)*

*Sodium acetate (3 M, pH 5.2)*

*10x Transcription buffer*

400 mM Tris-Cl (pH 7.5 at 37°C)

60 mM MgCl<sub>2</sub>

20 mM spermidine HCl

50 mM NaCl

Sterilize the 10x buffer by filtration and then store it in small aliquots at -20°C. Discard each aliquot after use.

### Enzymes and Buffers

*Appropriate restriction enzymes*

Please see Step 1.

*DNA-dependent RNA polymerase of bacteriophage T3, T7, or SP6*

These enzymes are available from several companies and are usually supplied at concentrations of 10–20 units/μl. Most manufacturers also supply a 10x transcription buffer that has presumably been optimized for their particular preparation of the DNA-dependent RNA polymerase. The generic 10x transcription buffer (listed under Buffers and Solutions) can be used if the manufacturer's buffer is in short supply.

Kits for *in vitro* transcription are sold by many manufacturers (e.g., MAXIscript and MEGAscript from Ambion and Riboprobe Gemini Systems from Promega). These kits are convenient for investigators who are using *in vitro* transcription methods for the first time, and they are certainly a marvelous help if something goes wrong with the technique. However, the reagents and buffers supplied in the kits can be easily assembled in the laboratory by any competent worker, and the enzymes can be purchased inexpensively as separate items.

*RNase-free pancreatic DNase I (1 mg/ml)*

This enzyme is available from several manufacturers (e.g., RQ1 RNase-free DNase I from Promega). Alternatively, contaminating RNase can be removed from standard preparations of DNase I by affinity chromatography on agarose 5'-(4-aminophenylphosphoryl)-uridine-2'(3')-phosphate (Maxwell et al. 1977). Please see Appendix 8 for details.

### Gels

*Agarose gel (0.8–1.0%)*

Please see Step 1.

### Nucleic Acids and Oligonucleotides

*rNTP solution containing rATP, rCTP, and rUTP, each at 5 mM*

rGTP (0.5 mM)

Optional, please see Step 5.

#### Template DNA

The DNA fragment to be transcribed should be cloned into one of the commercially available plasmids containing bacteriophage RNA polymerase promoters on both sides of the polycloning sequence (e.g., pGEM from Promega or pBluescript from Stratagene). Purify the superhelical recombinant plasmid by one or more of the methods described in Chapter 1.

The DNA used as a template in the in vitro transcription reaction need not be highly purified — crude minipreparations work well. The essential requirement is that the template be free of RNase, a criterion that can usually be fulfilled by extracting the preparation of plasmid DNA twice with phenol:chloroform. However, if RNase was added to the plasmid at a late stage in the purification process, i.e., after deproteinization, it should be removed by treatment with proteinase K, as follows:

1. Add to the plasmid DNA preparation: 0.1 volume of 10x proteinase K buffer (100 mM Tris-Cl [pH 8.0]/50 mM EDTA [pH 8.0]/500 mM NaCl), 0.1 volume of 5% (w/v) SDS, and proteinase K (20 mg/ml to a final concentration of 100 µg/ml).
2. Incubate the reaction for 1 hour at 37°C.
3. Extract the DNA with phenol:chloroform and recover the DNA by standard precipitation with ethanol.
4. Resuspend the DNA in RNase-free TE (pH 7.6) at a concentration of ≥100 µg/ml.

## Radioactive Compounds

[ $\alpha$ -<sup>32</sup>P]rGTP (10 mCi/ml, sp. act. 400–3000 Ci/mmole) <1>

To minimize problems caused by radiolysis of the precursor, it is best, whenever possible, to prepare radiolabeled probes on the day the [<sup>32</sup>P]dNTP arrives in the laboratory.

## Special Equipment

Microfuge tubes (0.5 ml)

Sephadex G-50 spun column, equilibrated with 10 mM Tris-Cl (pH 7.5)

Optional, please see Step 8.

Water bath preset to 40°C (if using bacteriophage SP6 DNA-dependent RNA polymerase in Step 4)

## Additional Reagents

Step 2 of this protocol requires the reagents listed in Protocol 11 of this chapter.

Step 8 of this protocol may require the reagents listed in Chapter 5, Protocols 9, 11, and 12.

## METHOD

1. Prepare 5 pmoles of linear template DNA by digestion of superhelical plasmid DNA with a suitable restriction enzyme. Analyze an aliquot (100 ng) of the digested DNA by agarose gel electrophoresis. If necessary, add more restriction enzyme and continue incubation until there is no trace of the undigested DNA.

Approximately 2 µg of a plasmid 3 kb in length is ~1 pmole.

▲ **IMPORTANT** It is essential that plasmid DNA templates be cleaved to completion, since trace amounts of closed circular plasmid DNA result in the generation of extremely long transcripts that include plasmid sequences. Because of their length, these transcripts can account for a substantial proportion of the incorporated radiolabeled rNTP.

2. If restriction enzymes, such as *Pst*I or *Sst*I, that generate protruding 3' termini must be used, treat the digested DNA with bacteriophage T4 DNA polymerase in the presence of all four dNTPs to remove the 3' protrusion (please see Protocol 11).

Protruding 3' termini create an opportunity for the DNA-dependent RNA polymerase to transfer to the complementary strand of the template and to generate long U-turn transcripts with extensive secondary structure.

3. Purify the template DNA by extraction with phenol:chloroform and standard precipitation with ethanol. Dissolve the DNA in H<sub>2</sub>O at a concentration of 100 nM (i.e., 200 µg/ml for a 3-kb plasmid).
4. Warm the first six components listed below to room temperature, and in a sterile 0.5-ml microfuge tube, mix *in the following order at room temperature*:

template DNA	0.2 pmole (400 ng for a 3-kb plasmid)
RNase-free H <sub>2</sub> O	to 6 µl
5 mM rNTP solution	2 µl
100 mM dithiothreitol	2 µl
10× transcription buffer	2 µl
2 mg/ml bovine serum albumin	1 µl
10 mCi/ml [ $\alpha$ - <sup>32</sup> P]rGTP (sp. act. 400–3000 Ci/mmol)	5 µl

Mix the components of the mixture by gently tapping the outside of the tube. Then add:

placental RNase inhibitor (10 units)	1 µl
bacteriophage DNA-dependent RNA polymerase (~10 units)	1 µl

▲ **IMPORTANT** The components are added in the order shown and at room temperature to avoid the possibility that the template DNA may be precipitated by the high concentration of spermidine in the transcription buffer.

Mix the reagents by gently tapping the outside of the tube. Centrifuge the tube for 1–2 seconds to transfer all of the liquid to the bottom. Incubate the reaction for 1–2 hours at 37°C (bacteriophages T3 and T7 DNA-dependent RNA polymerases) or 40°C (bacteriophage SP6 DNA-dependent RNA polymerase).

The reaction may be scaled from 20 µl to 50 µl to accommodate more dilute reagents.

When the reaction is carried out as described above, 80–90% of the radiolabel will be incorporated into RNA. The yield of RNA will be ~20 ng (sp. act.  $4.7 \times 10^9$  dpm/µg) when the specific activity of the [ $\alpha$ -<sup>32</sup>P]GTP is 3000 Ci/mmol and ~150 ng (sp. act.  $6.2 \times 10^8$  dpm/µg) when the specific activity of the precursor is 400 Ci/mmol.

5. (*Optional*) If full-length transcripts are desired, add 2 µl of 0.5 mM rGTP and incubate the reaction mixture for an additional 60 minutes at the temperature appropriate for the polymerase.
6. Terminate the *in vitro* transcription reaction by adding 1 µl of 1 mg/ml RNase-free pancreatic DNase I to the reaction tube. Mix the reagents by gently tapping the outside of the tube. Incubate the reaction mixture for 15 minutes at 37°C.
7. Add 100 µl of RNase-free H<sub>2</sub>O, and purify the RNA by extraction with phenol:chloroform. If the probe will be used in experiments where length is important (e.g., RNase protection), purify the radiolabeled RNA by polyacrylamide gel electrophoresis (please see Chapter 5, Protocol 9). The aim of this extra step is to eliminate truncated radiolabeled molecules from the preparation.
8. Transfer the aqueous phase to a fresh microfuge tube, and separate the radiolabeled RNA from undesired small RNAs and rNTPs by one of three methods:

#### TO PURIFY RNA BY ETHANOL PRECIPITATION

- a. Add 30 µl of 10 M ammonium acetate to the aqueous phase. Mix, and then add 250 µl of ice-cold ethanol to the tube. After storage for 30 minutes on ice, collect the RNA by centrifugation at maximum speed for 10 minutes at 4°C in a microfuge.

- b. Remove as much of the ethanol as possible by gentle aspiration, and leave the open tube on the bench for a few minutes to allow the last visible traces of ethanol to evaporate. Dissolve the RNA in 100  $\mu$ l of RNase-free H<sub>2</sub>O.
- c. Add 2 volumes of ice-cold ethanol to the tube and store the RNA at  $-70^{\circ}\text{C}$  until needed.
 

To recover the RNA, transfer an aliquot of the ethanolic solution to a fresh microfuge tube. Add 0.25 volume of 10 M ammonium acetate, mix, and then store the tube for at least 15 minutes at  $-20^{\circ}\text{C}$ . Centrifuge the solution at maximum speed for 10 minutes at  $4^{\circ}\text{C}$  in a microfuge. Remove the ethanol by aspiration, and dissolve the RNA in the desired volume of the appropriate RNase-free buffer.

#### TO PURIFY RNA BY SPUN-COLUMN CHROMATOGRAPHY

- a. Prepare a Sephadex G-50 spun column (please see Appendix 8) that has been autoclaved in 10 mM Tris-Cl (pH 7.5).
- b. Purify the RNA by spun-column chromatography according to the protocol in Appendix 8.
- c. Store the eluate in a microfuge tube at  $-70^{\circ}\text{C}$  until the RNA is needed.

#### TO PURIFY RNA BY GEL ELECTROPHORESIS

- a. Prepare a neutral polyacrylamide gel according to Chapter 5, Protocol 9.
- b. Add the appropriate gel-loading buffer to the aqueous phase and purify the RNA by gel electrophoresis.
- c. Locate the RNA by autoradiography according to Chapter 5, Protocol 11
- d. Purify the RNA from the gel slice using the crush and soak method according to Chapter 5, Protocol 12.
- e. Store the RNA at  $-70^{\circ}\text{C}$  until needed.

Any of these purification schemes should remove >99.0% of unincorporated rNTPs from the RNA.

#### RNA PROBES FOR IN SITU HYBRIDIZATION

RNA probes for in situ hybridization to mRNA or DNA can be synthesized with radiolabeled ( $^3\text{H}$ ,  $^{33}\text{P}$ ,  $^{35}\text{S}$ ,  $^{125}\text{I}$ ) or derivatized (biotinylated, digoxigenin, fluorescein) nucleotides in place of  $^{32}\text{P}$ -labeled nucleotides.  $^3\text{H}$ -,  $^{35}\text{S}$ -, and  $^{33}\text{P}$ -labeled nucleotides can be used in this protocol, provided the rGTP form of these labeled nucleotides is used. If another nucleotide is substituted for rGTP, then the composition of the 5 mM rNTP solution should be changed accordingly.

To use a biotinylated nucleotide (e.g., biotinylated rUTP), substitute a nucleotide solution containing 5 mM rCTP, rATP, and rGTP, and 2.5 mM rUTP for the nucleotide solution of Step 4 and add 1  $\mu$ l of a 10 mM solution of biotinylated-rUTP in place of the radiolabeled rNTP. To use a digoxigenin-labeled NTP (e.g., digoxigenin-UTP; Hölte and Kessler 1990), replace the 5 mM rNTP solution and the radiolabeled rNTP with 0.1 volume of an rNTP solution containing 10 mM rATP, rCTP, and rGTP, 6.5 mM rUTP, and 3.5 mM digoxigenin-rUTP, all in 25 mM Tris-Cl (pH 8.0).

In the case of biotin- and digoxigenin-labeled rNTPs, the modified nucleotide is used at a low concentration in the reaction to ensure that only a few labeled nucleotides are incorporated per molecule of probe ( $\sim 1$  labeled nucleotide for every 20–25 nucleotides polymerized). The posthybridization recognition of these labels by antibodies is most efficient when only a few bases are replaced by their labeled counterparts. Greater incorporation of the modified nucleotide can also decrease hybridization of the probe to target mRNAs or DNAs.

Fragments of RNA larger than  $\sim 300$  nucleotides are unsuitable as in situ hybridization probes. Because small fragments penetrate tissue more efficiently, larger fragments of RNA must be reduced in size by limited alkaline hydrolysis (Cox et al. 1984; Angerer et al. 1987; Bales et al. 1993).

**TROUBLESHOOTING: NO RNA IS SYNTHESIZED**

The most common cause of an apparent lack of RNA synthesis is contamination of tubes or reagents with RNase. This contamination can be avoided by taking the precautions described in the introduction to Chapter 7.

Less frequently, failure to synthesize RNA is a consequence of precipitation of the DNA template by the spermidine in the 10x transcription buffer. Make sure that the components of the reaction are assembled at room temperature and in the stated order. If necessary, the presence of soluble template can be confirmed by analyzing an aliquot of the reaction by electrophoresis through an agarose gel.

**Transcription Is from the Wrong Strand of DNA**

Usually, >99.8% of transcripts synthesized *in vitro* by bacteriophage DNA-dependent RNA polymerases are derived from the correct DNA strand (Melton et al. 1984). However, this high degree of specificity is only achieved provided templates are both linear and lacking protruding 3' termini. Contamination of the template with superhelical plasmid DNA causes an increase in aberrant initiation of RNA chains on both strands of the DNA. The presence of a protruding 3' terminus downstream from the bacteriophage promoter leads to the synthesis of transcripts complementary to the full length of the wrong strand of DNA (i.e., U-turn transcripts). Both of these problems can be avoided by careful preparation of the template (please see Steps 1 and 2).

**Synthesized Transcripts Are Shorter Than the Desired Length**

Synthesis of abbreviated transcripts can be due to the chance occurrence in the template of sequences that terminate transcription by the particular DNA-dependent RNA polymerase being used. Another contributing factor can be limiting concentrations of precursor (usually the radiolabeled rNTP).

The first of these obstacles may be resolved by constructing a new plasmid in which transcription of the desired sequence is driven by a polymerase from a different bacteriophage. Transcription terminator sequences are not always recognized equally by the various bacteriophage DNA-dependent RNA polymerases.

Although the strengths of transcription termination signals vary greatly, all but the strongest of them can be overcome, at least in part, by increasing the concentration of the limiting rNTP. In most cases, it is impractical to increase the concentration of the rNTP that is radiolabeled in the reaction, since the improvement in yield of full-length product is gained at the expense of reducing the specific activity of the probe. In this case, a number of additional steps can be taken:

- Lower the temperature of incubation of the transcription reaction to 30°C (Krieg and Melton 1987).
- Pare the sequences to be transcribed to the minimum. In this way, it may be possible to eliminate the termination sequences from the clone.
- Purify the desired product by electrophoresis through a polyacrylamide or agarose gel as described in Chapter 5, Protocol 1. The transcription reactions are so efficient that it is often possible to purify sufficient quantities of the desired RNA, even if it is only a relatively minor proportion of the total RNA synthesized in the reaction.

**ADDITIONAL PROTOCOL: USING PCR TO ADD PROMOTERS FOR BACTERIOPHAGE-ENCODED RNA POLYMERASES TO FRAGMENTS OF DNA**

Templates for bacteriophage-encoded RNA polymerases may be generated by cloning target DNA fragments into plasmids carrying bacteriophage promoters (main protocol). Alternatively, templates can be synthesized in PCRs using gene-specific primers whose 5' ends encode synthetic promoters for bacteriophage-encoded DNA-dependent RNA polymerases. Following purification, the products of the PCRs are used as double-stranded templates for *in vitro* transcription reactions (Logel et al. 1992; Bales et al. 1993; Urrutia et al. 1993). By using pairs of primers that encode different promoters, DNA fragments are generated that may be transcribed in a strand-specific manner by the appropriate RNA polymerase. The advantages of the PCR method include:

- Probes may be generated directly from DNA templates amplified from a heterogeneous population of DNA fragments.
- The need for cloning and preparation of plasmids is obviated.
- The probes contain no plasmid or polylinker sequences.
- Probes of high specificity and of virtually any size can be created.



RNA polymerases encoded by bacteriophages T3 and T7 transcribe PCR-amplified DNA carrying the appropriate promoters with high specificity. However, the yields of RNA are generally three- to fourfold lower than can be obtained from linearized plasmid templates. When using amplified DNA templates, between 20% and 30% of the labeled rNTP is converted into acid-insoluble material, compared to >75% in reactions containing linearized plasmid DNAs as templates (Logel et al. 1992). Nevertheless, the yield and specific activity of the RNA generated from the amplified products of PCRs are more than sufficient for most purposes. The RNA polymerase encoded by bacteriophage SP6 is reported to transcribe PCR-amplified DNA much less efficiently than linearized plasmid DNAs (Logel et al. 1992). For this reason, we recommend using primers that encode promoters for bacteriophages T3 and T7.

### Primer Design

The primers are usually quite long (>50 nucleotides) and consist of three regions:

5' clamp (~10 nucleotides)	core promoter (~22 nucleotides)	gene-specific sequence (20 nucleotides) 3'
----------------------------------	------------------------------------	---

The sequences of the core promoters recognized by the bacteriophage T3 and T7 RNA polymerases are taken from Jorgensen et al. (1991) (please see the information panel on **IN VITRO TRANSCRIPTION SYSTEMS**):

Bacteriophage T7 core promoter:	5' TAATACGACTCACTATAGGGAGA 3'
Bacteriophage T3 core promoter:	5' ATTAACCCTCACTAAAGGGAGA 3'

For the T3 promoter, the 3'-most dinucleotide can be GA or AG.

Use a different clamp sequence for each member of a primer pair. Suggested clamp sequences are (Logel et al. 1992) 5' CAGAGATGCA 3' and 5' CCAAGCCTTC 3'. The gene-specific segment of the primer should be designed according to the usual rules (please see the discussion on Primer Design in the introduction to Chapter 8).

### Amplification Conditions

The amplification reactions contain 10–20 pg of a single species of template DNA or proportionately more of complex populations of DNAs. The remainder of the reagents in the amplification reactions are used at standard concentrations (please see Chapter 8, Protocol 1). The denaturation, annealing, and polymerization times listed below are suitable for 50- $\mu$ l reactions assembled in thin-walled 0.5-ml tubes and incubated in thermal cyclers such as the Perkin-Elmer 9600 or 9700, Master Cycler (Eppendorf), and PTC 100 (MJ Research). Times and temperatures may need to be adapted to suit other types of equipment and reaction volumes.

Cycle Number	Denaturation	Annealing	Polymerization
1–4	1 min at 94°C	2 min at 54 °C	3 min at 72°C
5–36	1 min at 94°C	1 min at 65 °C	3 min at 72°C

Polymerization should be carried out for 1 minute for every 1000 bp of length of the target DNA.

Most thermocyclers have an end routine in which the amplified samples are incubated at 4°C until removed from the machine. Samples can be left overnight at this temperature, but should be stored thereafter at –20°C.

### Purification of Amplified DNA

Although amplified DNA may be used without purification as a template in the in vitro transcription reaction (Bales et al. 1993; Urrutia et al. 1993), the efficiency of RNA synthesis is improved if unused primers and the by-products of the amplification reaction are removed by electrophoresis through a gel cast with low-melting-temperature agarose, by spun-column chromatography through Sephadex G-75, or by absorption/elution on a commercial resin such as Wizard PCR Preps Purification System (Promega) or QIAquick (Qiagen) (please see Chapter 8, Protocol 2).

### In Vitro Transcription of Amplified DNA

Approximately 0.5  $\mu$ g of purified amplified DNA may be used as template in standard transcription reactions catalyzed by the appropriate bacteriophage-encoded DNA-dependent RNA polymerase (please see the main protocol).

# Protocol 7

---

## Synthesis of cDNA Probes from mRNA Using Random Oligonucleotide Primers

**T**HIS PROTOCOL DESCRIBES THE GENERATION OF cDNA probes from poly(A)<sup>+</sup> RNA in a random priming reaction. Probes of this type are used for differential screening of cDNA libraries. For additional details, please see the information panel on **ISOLATING DIFFERENTIALLY EXPRESSED cDNAs BY DIFFERENTIAL SCREENING AND CLONING**.

### MATERIALS

---

▲ **IMPORTANT** Prepare all reagents used in this protocol with DEPC-treated H<sub>2</sub>O (please see the information panel on **HOW TO WIN THE BATTLE WITH RNASE** in Chapter 7).

**CAUTION:** Please see Appendix 12 for appropriate handling of materials marked with <!>.

### Buffers and Solutions

Please see Appendix 1 for components of stock solutions, buffers, and reagents. Dilute stock solutions to the appropriate concentrations.

*Ammonium acetate (10 M)*

*Dithiothreitol (1 M)*

*EDTA (0.5 M, pH 8.0)*

*Ethanol*

*HCl (2.5 N) <!>*

*NaOH (3 N) <!>*

*Phenol:chloroform (1:1, v/v) <!>*

*Placental RNase inhibitor (20 units/μl)*

These inhibitors are sold by several manufacturers under various trade names (e.g., RNAsin, Promega; Prime Inhibitor, 5 Prime→3 Prime; RNaseOUT, Life Technologies). For more details, please see the information panel on **INHIBITORS OF RNASES** in Chapter 7.

*SDS (10% w/v)*

*Tris-Cl (1 M, pH 7.4)*

## Enzymes and Buffers

### *Reverse transcriptase*

Reverse transcriptase derived from the *pol* gene of the Moloney murine leukemia virus (Mo-MLV) is more efficient in cDNA synthesis than that obtained from the avian myeloblastosis virus (e.g., please see Fagnoli et al. 1990). The cloned version of reverse transcriptase encoded by the Mo-MLV enzyme is the enzyme of choice in this protocol. Mutants of the enzyme that lack RNase H activity (e.g., StrataScript, from Stratagene or Superscript II from Life Technologies) have some advantages over the wild-type enzyme since they (1) produce higher yields of full-length extension product and (2) work equally well at both 47°C and 37°C (Gerard and D'Alessio 1993).

Mo-MLV reverse transcriptase is temperature-sensitive and should be stored at -20°C until needed at Step 2.

### *10x Reverse transcriptase buffer*

## Nucleic Acids and Oligonucleotides

### *dNTP solution containing dATP, dGTP, and dTTP, each at 20 mM*

For advice on making and storing solutions of dNTPs, please see the information panel on **PREPARATION OF STOCK SOLUTIONS OF dNTP AND ddNTPS FOR DNA SEQUENCING** in Chapter 12.

### *dCTP (125 μM)*

Add 1 μl of a 20 mM stock solution of dCTP to 160 μl of 25 mM Tris-Cl (pH 7.6). Store the diluted solution in small aliquots at -20°C.

### *Random deoxynucleotide primers, six or seven bases in length*

Because of their uniform length and lack of sequence bias, synthetic oligonucleotides of random sequence are the primers of choice. Oligonucleotides of optimal length (hexamers or heptamers; Suganuma and Gupta 1995) can be purchased from a commercial source (e.g., Pharmacia and Boehringer Mannheim) or synthesized locally on an automated DNA synthesizer. Store the solution of primers at 0.125 μg/μl in TE (pH 7.6) at -20°C in small aliquots.

### *Template mRNA*

Prepare poly(A)<sup>+</sup> RNA as described in Chapter 7, Protocol 3 or 4, and dissolve in RNase-free H<sub>2</sub>O at a concentration of 250 μg/ml.

## Radioactive Compounds

### *[α-<sup>32</sup>P]dCTP (10 mCi/ml, sp. act. >3000 Ci/mmole) <math>\langle ! \rangle</math>*

To minimize problems caused by radiolysis of the precursor and the probe, it is best, whenever possible, to prepare radiolabeled probes on the day the [<sup>32</sup>P]dNTP arrives in the laboratory.

## Special Equipment

### *Ice water bath*

### *Sephadex G-50 spun column, equilibrated in TE (pH 7.6)*

Optional, please see Step 7.

### *Water baths or heating blocks preset to 45°C, 68°C, and 70°C*

## METHOD

---

1. Transfer 1 μg of poly(A)<sup>+</sup> RNA to a sterile microfuge tube. Adjust the volume of the solution to 4 μl with RNase-free H<sub>2</sub>O. Heat the closed tube for 5 minutes at 70°C, and then quickly transfer the tube to an ice-water bath.
2. To the chilled solution in the microfuge tube, add:

10 mM dithiothreitol	2.5 $\mu$ l
placental RNase inhibitor	20 units
random deoxyoligonucleotide primers	5 $\mu$ l
10x reverse transcriptase buffer	2.5 $\mu$ l
20 mM solution of dGTP, dATP, and dTTP	1 $\mu$ l
125 $\mu$ M solution of dCTP	1 $\mu$ l
10 mCi/ml [ $\alpha$ - <sup>32</sup> P]dCTP (sp. act. >3000 Ci/mmol)	10 $\mu$ l
RNase-free H <sub>2</sub> O	to 24 $\mu$ l
reverse transcriptase (200 units)	1 $\mu$ l

**▲ IMPORTANT** Add the reverse transcriptase last.

Reverse transcriptase supplied by different manufacturers varies in its activity per unit. When using a new batch of enzyme, set up a series of extension reactions containing equal amounts of poly(A)<sup>+</sup> RNA and oligonucleotide primer and different amounts of enzyme. If possible, the primer should be specific for an mRNA present at moderate abundance in the preparation of poly(A)<sup>+</sup> RNA. Assay the products of each reaction by gel electrophoresis as described in this protocol. Use the minimal amount of enzyme required to produce the maximum yield of extension product. The units used in this protocol work well with most batches of StrataScript and Superscript II.

Mix the components by gently tapping the side of the tube. Remove bubbles by brief centrifugation in a microfuge. Incubate the reaction mixture for 1 hour at 45°C.

As an alternative, [ $\alpha$ -<sup>32</sup>P]dCTP of specific activity 800 Ci/mmol can be substituted in this reaction. If this substitution is made, then omit the 125  $\mu$ M dCTP from the reaction mixture.

**3. Stop the reaction by adding:**

0.5 M EDTA (pH 8.0)	1 $\mu$ l
10% (w/v) SDS	1 $\mu$ l

Mix the reagents in the tube completely.

The single-stranded radiolabeled cDNA is quite sticky and adheres nonspecifically to glass, filters, and some plastics. For this reason, it is important to maintain a minimum of 0.05% (w/v) SDS in all buffers after Step 3 of the protocol, and 0.1–1.0% SDS in hybridization buffers.

- Add 3  $\mu$ l of 3 N NaOH to the reaction tube. Incubate the mixture for 30 minutes at 68°C to hydrolyze the RNA.
- Cool the reaction mixture to room temperature. Neutralize the solution by adding 10  $\mu$ l of 1 M Tris-Cl (pH 7.4), mixing well, and then adding 3  $\mu$ l of 2.5 N HCl. Check the pH of the solution by spotting a very small amount on pH paper.
- Purify the cDNA by extraction with phenol:chloroform.
- Separate the radiolabeled probe from the unincorporated dNTPs by either spun-column chromatography (please see Appendix 8) or selective precipitation by ethanol in the presence of 2.5 M ammonium acetate (please see Appendix 8).
- Measure the proportion of radiolabeled dNTPs that either are incorporated into material precipitated by TCA or adhere to a DE-81 filter (please see Appendix 8).

Assuming that 30% of the radioactivity has been incorporated into TCA-precipitable material during the random priming reaction and that 90% of this material has been generated by random priming events on the template mRNA (rather than self-priming of oligonucleotides), then the probe DNA would contain a total of  $\sim 6 \times 10^7$  dpm. The specific activity of the probe would be  $\sim 5 \times 10^9$  dpm/ $\mu$ g, and the weight of DNA synthesized during the reaction would be 11.7 ng.

If a larger amount of radiolabeled cDNA is required, then scale up the reaction by increasing the volumes of all components proportionally. It is important to maintain a ratio of 200 units of reverse transcriptase/ $\mu$ g of input mRNA to ensure maximum yield.

The purified radiolabeled cDNA can be used for hybridization without denaturation. Use  $5 \times 10^7$  dpm of radiolabeled cDNA for each 150-mm filter and  $5 \times 10^6$  to  $1 \times 10^7$  dpm for each 90-mm filter.

# Protocol 8

---

## Synthesis of Radiolabeled, Subtracted cDNA Probes Using Oligo(dT) as a Primer

**T**HIS PROTOCOL DESCRIBES THE PREPARATION OF SUBTRACTED cDNA probes by hybridization to an mRNA driver, followed by purification of the single-stranded radiolabeled cDNA by hydroxyapatite chromatography. For additional details, please see the information panel on **ISOLATING DIFFERENTIALLY EXPRESSED cDNAs BY DIFFERENTIAL SCREENING AND CLONING**.

### MATERIALS

---

▲ **IMPORTANT** Prepare all reagents used in this protocol with DEPC-treated H<sub>2</sub>O (please see the information panel on **HOW TO WIN THE BATTLE WITH RNASE** in Chapter 7).

**CAUTION:** Please see Appendix 12 for appropriate handling of materials marked with <!.>.

### Buffers and Solutions

Please see Appendix 1 for components of stock solutions, buffers, and reagents. Dilute stock solutions to the appropriate concentrations.

*Ammonium acetate (10 M)*

*Dithiothreitol (1 M)*

*EDTA (0.5 M, pH 8.0)*

*Ethanol*

*HCl (2.5 N) <!.>*

*Isobutanol <!.>*

*NaOH (3 N) <!.>*

*Phenol:chloroform (1:1, v/v) <!.>*

*Placental RNase inhibitor (20 units/μl)*

These inhibitors are sold by several manufacturers under various trade names (e.g., RNasin, Promega Inc; Prime Inhibitor, 5 Prime→3 Prime; RNaseOUT, Life Technologies). For more details, please see the information panel on **INHIBITORS OF RNASES** in Chapter 7.

*SDS (10% w/v)*

*SDS/EDTA solution*

30 mM EDTA (pH 8.0)

1.2% SDS

*Sodium phosphate buffer (2 M, pH 6.8)*

*SPS buffer*

0.12 M sodium phosphate buffer (pH 6.8)  
0.1% (w/v) SDS

*Tris-Cl (1 M, pH 7.4)*

## Enzymes and Buffers

*Reverse transcriptase*

Reverse transcriptase derived from the *pol* gene of Mo-MLV is more efficient in cDNA synthesis than that obtained from the avian myeloblastosis virus (e.g., please see Fagnoli et al. 1990). The cloned version of reverse transcriptase encoded by the Mo-MLV enzyme is the enzyme of choice in this protocol. Mutants of the enzyme that lack RNase H activity (e.g., StrataScript from Stratagene or Superscript II from Life Technologies) have some advantages over the wild-type enzyme since they (1) produce higher yields of full-length extension product and (2) work equally well at both 47°C and 37°C (Gerard and D'Alessio 1993).

*10x Reverse transcriptase buffer*

## Nucleic Acids and Oligonucleotides

*dCTP (125 μM)*

Add 1 μl of a 20 mM stock solution of dCTP to 160 μl of 25 mM Tris-Cl (pH 7.6). Store the diluted solution in small aliquots at -20°C.

*dNTP solution containing dATP, dGTP, and dTTP, each at 20 mM*

For advice on making and storing solutions of dNTPs, please see the information panel on **PREPARATION OF STOCK SOLUTIONS OF dNTPs AND ddNTPs FOR DNA SEQUENCING** in Chapter 12.

*Driver mRNA*

Please see Steps 9 and 19.

*Oligo(dT)<sub>12-18</sub>*

Purchase and dissolve oligo(dT)<sub>12-18</sub> at 1 mg/ml in TE (pH 7.6). Store at -20°C.

Random deoxynucleotide primers can also be substituted in the cDNA synthesis reaction (please see Protocol 7). Although cDNA synthesized with oligo(dT) tends to be longer than that synthesized with random primers, this is of little advantage in hybridization reactions. The choice of primer depends on the method used to construct the cDNA library to be screened. Use oligo(dT) as a primer in this protocol if the cDNA library was constructed with oligo(dT). Use random primers if the cDNA library was manufactured in any other way.

In rare instances, mRNAs contain middle repetitive sequences in their 3'-untranslated regions and these can cross-hybridize to repetitive sequences in nonhomologous cDNAs derived from the nonexpressing cell. In such cases, synthesize the radiolabeled probe with random primers.

*Template mRNA*

Prepare poly(A)<sup>+</sup> RNA as described in Chapter 7, Protocol 3 or 4, and dissolve in RNase-free H<sub>2</sub>O at a concentration of 250 μg/ml.

## Radioactive Compounds

*[α-<sup>32</sup>P]dCTP (10 mCi/ml, sp. act. >3000 Ci/mmmole) <1>*

To minimize problems caused by radiolysis of the precursor and the probe, it is best, whenever possible, to prepare radiolabeled probes on the day the [<sup>32</sup>P]dNTP arrives in the laboratory.

## Special Equipment

*Apparatus for separation of single-stranded and double-stranded nucleic acids by hydroxyapatite chromatography at 60°C.*

Please see Appendix 8.

*Boiling water bath*

*Ice water bath*

*Mineral oil and pipette tips drawn out to be attached to an automatic pipette or Siliconized, disposable 20-μl glass capillary tubes and file or diamond pen*

*Sephadex G-50 column (5 ml), equilibrated in TE (pH 8.0)*

*Sephadex G-50 spun column, equilibrated in TE (pH 8.0) containing 0.1% (w/v) SDS*

*Siliconized microfuge tubes (1.5 ml)*

*Water baths or heating blocks preset to 45°C, 68°C, and 70°C*

## METHOD

▲ **IMPORTANT** Before preparing the probe, it is a good idea to have filters (which contain the cDNA library to be screened) ready to hybridize.

1. Transfer 5–10 µg of poly(A)<sup>+</sup> RNA to a sterile microfuge tube. Adjust the volume of the solution to 40 µl with RNase-free H<sub>2</sub>O. Heat the closed tube to 70°C for 5 minutes, and then quickly transfer the tube to an ice water bath.

2. To the chilled microfuge tube, add:

0.1 M dithiothreitol	2.5 µl
placental RNase inhibitor	200 units
oligo(dT) <sub>12–18</sub>	10 µl
10x reverse transcriptase buffer	25 µl
20 mM solution of dGTP, dATP, and dTTP	10 µl
125 µM dCTP	10 µl
10 mCi/ml [ $\alpha$ - <sup>32</sup> P]dCTP (sp. act. >3000 Ci/mmol)	100 µl
RNase-free H <sub>2</sub> O	to 240 µl
reverse transcriptase (2000 units)	10 µl

▲ **IMPORTANT** Add the reverse transcriptase last.

Reverse transcriptase supplied by different manufacturers varies in its activity per unit. When using a new batch of enzyme, set up a series of extension reactions containing equal amounts of poly(A)<sup>+</sup> RNA and oligonucleotide primer, and different amounts of enzyme. If possible, the primer should be specific for an mRNA present at moderate abundance in the preparation of poly(A)<sup>+</sup> RNA. Assay the products of each reaction by gel electrophoresis as described in this protocol. Use the minimal amount of enzyme required to produce the maximum yield of extension product. The units used in this protocol work well with most batches of StrataScript and Superscript II.

Mix the components by gently tapping the side of the tube. Collect the reaction mixture in the bottom of the tube by brief centrifugation in a microfuge. Incubate the reaction for 1 hour at 45°C.

As an alternative, [ $\alpha$ -<sup>32</sup>P]dCTP of specific activity 800 Ci/mmol can be substituted in this reaction. If this substitution is made, then omit the 125 µM dCTP from the reaction mixture.

3. Stop the reaction by adding:

0.5 M EDTA (pH 8.0)	10 µl
10% (w/v) SDS	10 µl

Mix the reagents in the tube well.

The single-stranded, radiolabeled cDNA is quite sticky and adheres nonspecifically to glass, filters, and some plastics. For this reason, it is important to maintain a minimum of 0.05% (w/v) SDS in all buffers after Step 3 of the protocol, and 0.1–1.0% SDS in hybridization buffers.

4. Add 30 µl of 3 N NaOH to the reaction tube. Incubate the mixture for 30 minutes at 68°C to hydrolyze the RNA.
5. Cool the mixture to room temperature. Neutralize the solution by adding 100 µl of 1 M Tris-HCl (pH 7.4), mixing well, and then adding 30 µl of 2.5 N HCl. Check the pH of the solution by spotting <1 µl on pH paper.
6. Purify the cDNA by extraction with phenol:chloroform (please see Appendix 8).
7. Measure the proportion of radiolabeled dNTPs that either are incorporated into material precipitated by TCA or adhere to a DE-81 filter (please see Appendix 8). Calculate the yield of cDNA as follows:

In a reaction containing 1.5 nmoles of the limiting dNTP:

$$\frac{\text{cpm incorporated}}{\text{total cpm}} \times 1.5 \text{ nmoles dCTP} \times 330 \text{ ng/nmole} \times 160 = \text{ng of cDNA synthesized}$$

8. Separate the radiolabeled probe from the unincorporated dNTPs by chromatography through a 5-ml column of Sephadex G-50 (please see Appendix 8).

▲ **IMPORTANT** Perform this step and all subsequent steps with siliconized tubes (please see Appendix 8).

9. To the radiolabeled cDNA, add tenfold excess by weight of the driver RNA that will be used to subtract the cDNA probe, 0.2 volume of 10 M ammonium acetate, and 2.5 volumes of ice-cold ethanol. Incubate the mixture for 10–15 minutes at 0°C, and then recover the nucleic acids by centrifugation at maximum speed for 5 minutes at 4°C in a microfuge.
10. Remove all of the ethanol by aspiration, and store the open tube on the bench to allow most of the remaining ethanol to evaporate. Dissolve the nucleic acids in 6  $\mu$ l of RNase-free H<sub>2</sub>O.
11. To the dissolved nucleic acids, add:

2 M sodium phosphate (pH 6.8)	2 $\mu$ l
SDS/EDTA solution	2 $\mu$ l

12. *Either* cover the solution with a drop of light mineral oil *or* draw the mixture into a siliconized, disposable 20- $\mu$ l glass capillary tube and seal the ends of the tube in the flame of a Bunsen burner.
13. Place the microfuge tube or sealed capillary tube in a boiling water bath for 5 minutes. Transfer to a water bath set at 68°C, and allow the nucleic acids to hybridize to  $C_{t_0} t = 1000$  moles seconds/liter.

To calculate the time required to reach this  $C_{t_0} t$ , solve the following equation for  $t$ :

$$D/D_0 = e^{-kC_{t_0} t}$$

where  $D$  is the remaining single-stranded cDNA at time  $t$ ,  $D_0$  is the total amount of input cDNA,  $e$  is the natural logarithm,  $k$  is a rate constant for the formation of RNA-DNA hybrids that is dependent on the complexity of the mRNA population and may be assumed to be  $\sim 6.7 \times 10^{-3}$  liters/mol-sec, and  $C_{t_0}$  is the initial concentration of the RNA driver (which does not change appreciably during the hybridization reaction). (For a lucid description of this equation, please see Sargent [1987] and for additional information, page 538 in Davidson [1986].)

14. Remove the microfuge tube or capillary tube from the water bath. Use a drawn-out pipette tip attached to a micropipettor to remove the hybridization solution from the microfuge tube, or open the ends of the capillary tube with a file or diamond pen. Transfer the hybridization mixture into a tube containing 1 ml of SPS buffer.
15. Separate the single-stranded and double-stranded nucleic acids by chromatography on hydroxyapatite at 60°C as described in Appendix 8.

Measure the amount of radioactivity in each fraction by liquid scintillation counting. At least 90% of the input [<sup>32</sup>P]cDNA should have hybridized to the mRNA and be present in the >0.36 M sodium phosphate wash.

16. Pool the fractions containing the single-stranded cDNA and concentrate them by *repeated* extractions with isobutanol extraction: Add an equal volume of isobutanol. Mix the two phases by vortexing, and centrifuge the mixture at maximum speed for 2 minutes at room temperature in a microfuge. Discard the upper (organic) phase. Repeat the extraction with isobutanol until the volume of the aqueous phase is <100  $\mu$ l.



17. Remove salts from the cDNA by spun-column chromatography through Sephadex G-50 equilibrated in TE (pH 8.0) containing 0.1% SDS (please see Appendix 8).

▲ **IMPORTANT** Do not use ethanol precipitation to concentrate the cDNA as the presence of phosphate ions interferes with precipitation. Do not use dialysis to remove phosphate ions, as the cDNA will stick to the dialysis bag.

18. Measure the amount of radioactivity in the sample and calculate the weight of DNA in the subtracted probe.

19. Repeat Steps 9–18.

Between 10% and 30% of the cDNA will form hybrids with the driver RNA during the second round of hybridization.

It is not necessary to concentrate or remove salts from the final preparation of cDNA if it is to be used to probe a cDNA library. The radiolabeled cDNA can be used for hybridization without denaturation. Probes radiolabeled to high specific activity are rapidly damaged by radiochemical decay. The subtractive hybridizations should therefore be carried out as rapidly as practicable, and the probe should be used without delay. Use  $5 \times 10^7$  dpm of radiolabeled cDNA for each 150-mm filter and  $5 \times 10^6$  to  $1 \times 10^7$  dpm for each 90-mm filter.

If a genomic DNA library is screened with the radiolabeled subtracted probe, oligo(dA) can be added to the prehybridization and hybridization reactions at 1  $\mu$ g/ml to prevent nonspecific hybridization between the oligo(dT) tails of the cDNA and oligo(dA) tracts in the genomic DNA.

# Protocol 9

---

## Radiolabeling of Subtracted cDNA Probes by Random Oligonucleotide Extension

**I**N THIS PROCEDURE, SYNTHESIS OF cDNA IS CARRIED OUT in the presence of saturating concentrations of all four dNTPs and trace amounts of a single radiolabeled dNTP. After subtraction hybridization, the enriched single-stranded cDNA is radiolabeled to high specific activity in a second synthetic reaction by extension of random oligonucleotide primers using the Klenow fragment of *E. coli* DNA polymerase I. Because the concentrations of dNTP in the first reaction are nonlimiting, both the amounts and size of cDNA generated are greater than those achieved in standard labeling protocols (e.g., please see Protocol 8). The subtractive hybridization step can therefore be carried out with higher efficiency. Because the resulting population of cDNA is not vulnerable to radiolytic cleavage, it can be stored indefinitely and radiolabeled to higher specific activity when needed.

The protocol works best when the cDNA synthesized in the initial synthetic reaction is full length or close to it. For this reason, synthesis of cDNAs is primed by oligo(dT) rather than random hexanucleotide primers. By contrast, the subsequent radiolabeling reaction is primed by random oligonucleotides, yielding shorter DNA products whose size is ideal for hybridization.

The cDNA prepared as described in Steps 1–10 of this protocol can be converted into double-stranded DNA (please see Chapter 11, Protocol 1 [Stage 2]) and cloned into a bacteriophage or plasmid vector to produce a subtracted cDNA library (e.g., please see Sargent and Dawid 1983; Davis 1986; Rhyner et al. 1986; Fagnoli et al. 1990). The cDNA library can then be screened with a subtracted probe. Because subtracted libraries are enriched for cDNA clones corresponding to nonabundant mRNAs, the amount of screening required to find a clone corresponding to a rare mRNA may be reduced by a factor of 10. Subtracted probes radiolabeled as described here can detect cDNAs corresponding to mRNAs expressed at a level as low as five molecules/mammalian cell. For additional details, please see the information panel on **ISOLATING DIFFERENTIALLY EXPRESSED cDNAs BY DIFFERENTIAL SCREENING AND CLONING**.

## MATERIALS

▲ **IMPORTANT** Prepare all reagents used in this protocol with DEPC-treated H<sub>2</sub>O (please see the information panel on **HOW TO WIN THE BATTLE WITH RNASE** in Chapter 7).

**CAUTION:** Please see Appendix 12 for appropriate handling of materials marked with <!.>.

### Buffers and Solutions

Please see Appendix 1 for components of stock solutions, buffers, and reagents. Dilute stock solutions to the appropriate concentrations.

*Dithiothreitol (1 M)*

*EDTA (0.5 M, pH 8.0)*

*Ethanol*

*HCl (2.5 N) <!.>*

*NaOH (3 N) <!.>*

*Phenol:chloroform (1:1, v/v) <!.>*

*Placental RNase inhibitor*

These inhibitors are sold by several manufacturers under various trade names (e.g., RNasin, Promega; Prime Inhibitor, 5 Prime→3 Prime; RNaseOUT, Life Technologies). For more details, please see the information panel on **INHIBITORS OF RNASES** in Chapter 7.

*5x Random primer buffer*

250 mM Tris (pH 8.0)

25 mM MgCl<sub>2</sub>

100 mM NaCl

10 mM dithiothreitol

1 M HEPES (adjusted to pH 6.6 with 4 M NaOH)

Use a fresh dilution in H<sub>2</sub>O of 1 M dithiothreitol stock, stored at -20°C. Discard the diluted dithiothreitol after use.

*SDS (20% w/v)*

*Sodium acetate (3 M, pH 5.2)*

*Tris-Cl (1 M, pH 7.4)*

### Enzymes and Buffers

*Klenow fragment of E. coli DNA polymerase I*

*Reverse Transcriptase*

Reverse transcriptase derived from the *pol* gene of Mo-MLV is more efficient in cDNA synthesis than that obtained from the avian myeloblastosis virus (e.g., please see Fagnoli et al. 1990). The cloned version of reverse transcriptase encoded by the Mo-MLV enzyme is the enzyme of choice in this protocol. Mutants of the enzyme that lack RNase H activity (e.g., StrataScript from Stratagene or Superscript II from Life Technologies) have some advantages over the wild-type enzyme since they (1) produce higher yields of full-length extension product and (2) work equally well at both 47°C and 37°C (Gerard and D'Alessio 1993).

*10x Reverse transcriptase buffer*

### Nucleic Acids and Oligonucleotides

*dNTP solution (complete) containing four dNTPs, each at 5 mM*

*dNTP solution containing dCTP, dGTP, and dTTP, each at 5 mM*

▲ **IMPORTANT** Omit the dATP from this solution.

For advice on making and storing solutions of dNTPs, please see the information panel on **PREPARATION OF STOCK SOLUTIONS OF dNTPs AND ddNTPs FOR DNA SEQUENCING** in Chapter 12.

*Oligo(dT)<sub>12-18</sub>*

Purchase and dissolve oligo(dT)<sub>12-18</sub> at 1 mg/ml in TE (pH 7.6). Store at -20°C.

*Random deoxynucleotide primers six or seven bases in length*

Because of their uniform length and lack of sequence bias, synthetic oligonucleotides of random sequence are the primers of choice. Oligonucleotides of optimal length (hexamers and heptamers; Suganuma and Gupta 1995) can be purchased from a commercial source (e.g., Pharmacia and Boehringer Mannheim) or synthesized locally on an automated DNA synthesizer. Store the solution of primers at 0.125 µg/µl in TE (pH 7.6) at -20°C in small aliquots.

*Template RNAs:*

*Two-pass poly(A)<sup>+</sup>-enriched mRNA prepared from cells or tissue that expresses the mRNA(s) of interest*

*Two-pass poly(A)<sup>+</sup>-enriched mRNA prepared from cells or tissue that does not express the mRNA(s) of interest*

For mRNA preparation and oligo(dT) chromatography, please see Chapter 7. Both RNAs should be dissolved in H<sub>2</sub>O at a concentration of ~1 mg/ml.

**Radioactive Compounds**

[α-<sup>32</sup>P]dATP (10 mCi/ml, sp. act. >3000 Ci/mmol) <!<sup>></sup>

[α-<sup>32</sup>P]dCTP (10 mCi/ml, sp. act. 800–3000 Ci/mmol) <!<sup>></sup>

To minimize problems caused by radiolysis of the precursor and the probe, it is best, whenever possible, to prepare radiolabeled probes on the day the [<sup>32</sup>P]dNTP arrives in the laboratory.

**Special Equipment**

*Sephadex G-50 spun column, equilibrated in TE (pH 7.6)*

*Siliconized microfuge tubes (1.5 ml)*

*Water baths preset to 45°C, 60°C, and 68°C*

**Additional Reagents**

*Steps 8 and 9 of this protocol require reagents listed in Protocol 8 of this chapter.*

**METHOD**

1. To synthesize first strand cDNA, mix the following ingredients at 4°C in a sterile microfuge tube:

template RNA (1 mg/ml)	10 µl
oligo(dT) <sub>12-18</sub> (1 mg/ml)	10 µl
5 mM dNTP solution (complete)	10 µl
50 mM dithiothreitol	1 µl
10x reverse transcriptase buffer	5 µl
10 mCi/ml [α- <sup>32</sup> P]dCTP (sp. act. 800 or 3000 Ci/mmol)	5 µl
placental RNase inhibitor	25 units
RNase-free H <sub>2</sub> O	to 46 µl
reverse transcriptase (~800 units)	4 µl

▲ **IMPORTANT** Add the reverse transcriptase last.

Reverse transcriptase supplied by different manufacturers varies in its activity per unit. When using a new batch of enzyme, set up a series of extension reactions containing equal amounts of poly(A)<sup>+</sup> RNA and oligonucleotide primer, and different amounts of enzyme. If possible, the primer should be specific for a mRNA present at moderate abundance in the preparation of poly(A)<sup>+</sup> RNA. Assay the products of each reaction by gel electrophoresis as described in this protocol. Use the minimal amount of enzyme required to produce the maximum yield of extension product. The units used in this protocol work well with most batches of StrataScript and Superscript II.

Mix the components by gently tapping the side of the tube. Collect the reaction mixture in the bottom of the tube by brief centrifugation in a microfuge. Incubate the reaction for 1 hour at 45°C.

[α-<sup>32</sup>P]dCTP is used as a tracer to measure the synthesis of the first strand of cDNA.

2. Measure the proportion of radiolabeled dNTPs that either are incorporated into material precipitated by TCA or adhere to a DE-81 filter (please see Appendix 8). Calculate the yield of cDNA using the equation below.

In a reaction containing 50 nmoles of each dNTP:

$$\frac{\text{cpm incorporated}}{\text{total cpm}} \times 200 \text{ nmoles dNTP} \times 330 \text{ ng/nmole} = \text{ng of cDNA synthesized}$$

3. Stop the reaction by adding:

0.5 M EDTA (pH 8.0)	2 $\mu$ l
20% (w/v) SDS	2 $\mu$ l

Mix the reagents in the tube completely.

The single-stranded, radiolabeled cDNA is quite sticky and adheres nonspecifically to glass, filters, and some plastics. For this reason, it is important to maintain a minimum of 0.05% (w/v) SDS in Step 3 of the protocol, and 0.1–1.0% SDS in hybridization buffers.

4. Add 5  $\mu$ l of 3 N NaOH to the reaction tube. Incubate the mixture for 30 minutes at 68°C to hydrolyze the RNA.
5. Cool the mixture to room temperature. Neutralize the solution by adding 10  $\mu$ l of 1 M Tris-Cl (pH 7.4), mixing well, and then adding 5  $\mu$ l of 2.5 N HCl. Check the pH of the solution by spotting <1  $\mu$ l on pH paper.
6. Purify the cDNA by extraction with phenol:chloroform (please see Appendix 8).
7. Separate the radiolabeled probe from the unincorporated dNTPs by chromatography through a spun column of Sephadex G-50 (Appendix 8).
8. Carry out two rounds of subtractive hybridization as described in Protocol 8, Steps 9–19.
9. Concentrate the final preparation of cDNA by sequential extractions with isobutanol, and remove salts by chromatography on Sephadex G-50 as described in Protocol 8, Steps 16 and 17.
10. Recover the cDNA by standard precipitation with ethanol (please see Appendix 8). Dissolve the cDNA in H<sub>2</sub>O at a concentration of 15 ng/ $\mu$ l.

▲ **IMPORTANT** Perform this step and all subsequent steps with siliconized tubes (please see Appendix 8).

▲ **IMPORTANT** Do not attempt to precipitate the cDNA with ethanol before removing the phosphate ions by spun-column chromatography. The presence of phosphate ions interferes with DNA precipitation.

The subtracted cDNA prepared through Step 10 of this protocol can be converted into double-stranded DNA (please see Chapter 11, Protocol 1 [Stage 2]) and cloned into a bacteriophage or plasmid vector to produce a subtracted cDNA library (e.g., please see Sargent and Dawid 1983; Davis 1986; Rhyner et al. 1986; Fargnoli et al. 1990).

11. To radiolabel the subtracted cDNA to high specific activity, mix the following in a 0.5-ml microfuge tube:

subtracted cDNA	5 $\mu$ l
random deoxynucleotide primers (125 $\mu$ g/ml)	5 $\mu$ l

12. Heat the mixture to 60°C for 5 minutes, and then cool it to 4°C.

13. To the primer:cDNA template mixture, add:

5x random primer buffer	10 $\mu$ l
5 mM dNTP solution of dCTP, dGTP, and dTTP	5 $\mu$ l
10 mCi/ml [ $\alpha$ - <sup>32</sup> P]dATP (sp. act. >3000 Ci/mmol)	25 $\mu$ l
Klenow fragment (12.5 units)	2.5 $\mu$ l
H <sub>2</sub> O	to 50 $\mu$ l

Incubate the reaction for 4–6 hours at room temperature.

10–15 units of the Klenow fragment are required in each random priming reaction.

14. Stop the reaction by adding:

0.5 M EDTA (pH 8.0)	1 $\mu$ l
20% (w/v) SDS	2.5 $\mu$ l

15. Separate the radiolabeled cDNA from the unincorporated dNTPs by spun-column chromatography through Sephadex G-50 (please see Appendix 8).

The radiolabeled cDNA should be denatured by heating to 100°C for 5 minutes before it is used for hybridization. Use  $5 \times 10^7$  dpm of radiolabeled cDNA for each 138-mm filter and  $5 \times 10^6$  to  $1 \times 10^7$  dpm for each 82-mm filter. Once radiolabeled, use the probe immediately to avoid damage by radiochemical decay.

# Protocol 10

---

## Labeling 3' Termini of Double-stranded DNA Using the Klenow Fragment of *E. coli* DNA Polymerase I

**T**HE SIMPLEST WAY TO LABEL LINEAR DOUBLE-STRANDED DNA is to use the Klenow fragment of *E. coli* DNA polymerase I to catalyze the incorporation of one or more [ $\alpha$ - $^{32}\text{P}$ ]dNTPs into a recessed 3' terminus (Telford et al. 1979; Cobianchi and Wilson 1987). For a summary of other methods that may be used to label the termini of DNA, please see Table 9-2 at the end of this protocol. Fragments suitable as templates for the end-filling reaction are produced by digestion of DNA with an appropriate restriction enzyme. The Klenow enzyme is then used to catalyze the attachment of dNTPs to the recessed 3'-hydroxyl groups (please see the information panel on ***E. COLI* DNA POLYMERASE I AND THE KLENOW FRAGMENT**). The labeling reaction is versatile and quick and has the advantage that it can be carried out in the restriction digest, without any change of buffer. Because the Klenow enzyme has an indolent 3'→5' exonuclease activity, its ability to incorporate nucleotides at blunt or 3'-protruding termini is limited. One or both of the 3' ends of a linear double-stranded DNA molecule can therefore be labeled, depending on the nature of the termini and radiolabeled nucleotide included in the labeling reaction (please see Labeling Recessed and Blunt-ended 3' Termini below). However, under most circumstances, it is best to include unlabeled dNTPs in the labeling reaction. This allows the labeling of the recessed 3' terminus at any position. In addition, unlabeled dNTPs incorporated downstream from the labeled dNTP shield the labeled nucleotide from the action of the indolent 3'→5' exonuclease. Fragments labeled at both 3' termini are used as:

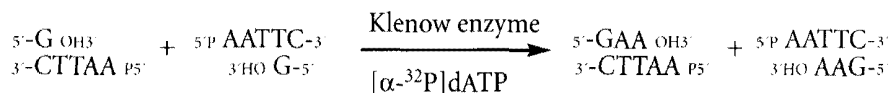
- molecular-weight standards in Southern blotting (please see the panel on **PREPARING RADIO-LABELED SIZE MARKERS FOR GEL ELECTROPHORESIS** following Step 4)
- probes in gel-retardation experiments
- tracers for small quantities of DNAs on gels
- low-specific-activity probes for screening bacterial colonies or bacteriophage plaques and for Southern analysis of recombinant cosmids, plasmids, or bacteriophage  $\lambda$

Fragments labeled at only one terminus are used as:

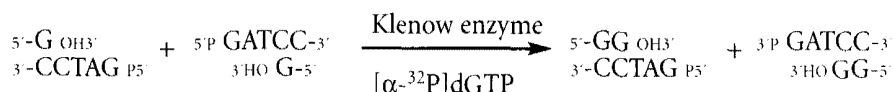
- substrates for sequencing by the Maxam-Gilbert method (Chapter 12, Protocol 7)
- probes for RNA mapping with either nuclease S1 or mung bean nuclease (Chapter 7, Protocol 10)
- primers in primer-extension reactions

### LABELING RECESSED AND BLUNT-ENDED 3' TERMINI

This protocol requires that the DNA to be end-labeled contain a sequence recognized and cleaved by a restriction endonuclease that generates 3'-recessed ends. The choice of which [ $\alpha$ - $^{32}$ P]dNTPs to use for the reaction depends on the sequence of the protruding 5' termini at the ends of the DNA and on the objective of the experiment. For example, ends created by cleavage of DNA with *EcoRI* can be labeled with [ $\alpha$ - $^{32}$ P]dATP:



The two proximal 5'-protruding nucleotides are both thymidine residues, and the Klenow enzyme can therefore insert two adenine residues. The resulting fragment with two identical radiolabeled nucleotides incorporated into its 3' terminus would not be suitable for Maxam-Gilbert sequencing, because a doublet pattern would be obtained on the sequencing autoradiogram. For other purposes, however, such as radiolabeling of DNAs to be used as size standards or generating probes, the incorporation of two identical radiolabeled deoxynucleotides would not compromise the results. Termini created by cleavage of DNA with *BamHI* can be labeled with [ $\alpha$ - $^{32}$ P] dGTP:

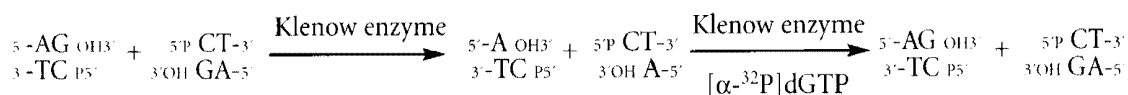


Note that only one radiolabeled nucleotide can be incorporated per end in a reaction utilizing [ $\alpha$ - $^{32}$ P]dGTP as the radiolabeled substrate. However, if unlabeled dGTP, dATP, and dTTP were included in the polymerization reaction, then the DNA fragment could be radiolabeled with [ $\alpha$ - $^{32}$ P]dCTP. The addition of unlabeled dNTPs (1) allows the use of any available radiolabeled dNTP whose complement is included in the protruding 5' end, (2) eliminates the possibility of exonucleolytic removal of nucleotides from the 3' terminus of the template by the Klenow enzyme's 3'→5' exonuclease activity, and (3) ensures that all radiolabeled DNA products will be the same length.

By choosing the appropriate [ $\alpha$ - $^{32}$ P]dNTP, it is possible to label only one end of a double-stranded DNA molecule. For example, DNA cleaved by *EcoRI* at one end and by *BamHI* at the other end can be labeled selectively by including either [ $\alpha$ - $^{32}$ P]dATP (to radiolabel the *EcoRI* site) or [ $\alpha$ - $^{32}$ P]dGTP (to radiolabel the *BamHI* site). Furthermore, if the DNA sequence of a fragment to be end-labeled is known, the N nucleotide in the recognition sequence of certain restriction enzymes can be used to label one end of a DNA molecule preferentially. For example, the restriction enzyme *HinfI* recognizes the sequence 5'-GANTC-3' and cleaves between the G and A to yield a 3'-recessed end. If the *HinfI* recognition sequence at the 5' end of a DNA fragment is 5'-GACTC-3' and at the 3' end the sequence is 5'-GAGTC-3', then the DNA fragment can be selectively labeled at the 5' end by including unlabeled dATP and [ $\alpha$ - $^{32}$ P]dGTP in the reaction or at the 3' end by including unlabeled dATP and [ $\alpha$ - $^{32}$ P]dCTP in the reaction. Numerous variations on this strategy can be used with restriction enzymes such as *DdeI*, *Fnu4H*, *Bsu36I*, and *EcoO109I*.

The terminal nucleotide of a blunt-ended DNA fragment can be replaced by exploiting the weak 3'→5' exonucleolytic and strong polymerizing activities of the Klenow fragment. For example, incubation of DNA fragments produced by the restriction enzyme *AluI*, which recognizes the sequence 5'-AGCT-3' and cleaves between the G and C, with the Klenow enzyme and [ $\alpha$ - $^{32}$ P]dGTP results in exonucleolytic removal of the dGMP and replacement with the radiolabeled guanine nucleotide:





Although the specific activity of radiolabeled blunt-ended DNA fragments is not high, it is generally sufficient to allow the fragments to be used as size standards in gel electrophoresis. Blunt-ended molecules can be labeled more efficiently using bacteriophage T4 DNA polymerase, which has a much more powerful 3'→5' exonuclease than the Klenow fragment.

Finally, the end-filling reaction catalyzed by the Klenow enzyme is not limited to radiolabeled dNTPs. Deoxynucleotides modified with haptens such as biotin, fluorescein, and digoxigenin can also be used. The  $K_m$  values for incorporation of these modified nucleotides are usually less than the  $K_m$  values of the standard dNTPs and depends on the nature of the hapten. Follow the recommendations of the manufacturer when using modified nucleotides as substrates in labeling reactions catalyzed by the Klenow enzyme.

## MATERIALS

**CAUTION:** Please see Appendix 12 for appropriate handling of materials marked with <!>.

### Buffers and Solutions

Please see Appendix 1 for components of stock solutions, buffers, and reagents. Dilute stock solutions to the appropriate concentrations.

*Ammonium acetate (10 M)*

Optional, please see Step 4.

*Ethanol*

### Enzymes and Buffers

*Appropriate restriction enzyme(s)*

Choose enzymes that produce 3'-recessed termini.

*Klenow fragment of E. coli DNA polymerase I*

### Nucleic Acids and Oligonucleotides

*dNTP solution containing the appropriate unlabeled dNTPs, each at 1 mM*

For advice on making and storing solutions of dNTPs, please see the information panel on **PREPARATION OF STOCK SOLUTIONS OF dNTPs AND ddNTPs FOR DNA SEQUENCING** in Chapter 12.

*Template DNA (0.1–5 μg)*

Use linear, double-stranded DNA carrying appropriate recessed 3' termini.

### Radioactive Compounds

*[α-<sup>32</sup>P]dNTP (10 mCi/ml, sp. act. 800–3000 Ci/mmol) <!>*

To minimize problems caused by radiolysis of the precursor and the probe, it is best, whenever possible, to prepare radiolabeled probes on the day the [<sup>32</sup>P]dNTP arrives in the laboratory.

### Special Equipment

*Sephadex G-50 spun column, equilibrated in TE (pH 7.6)*

Optional, please see Step 4.

*Water bath preset to 75°C*

**METHOD**

1. Digest up to 5  $\mu\text{g}$  of template DNA with the desired restriction enzyme in 25–50  $\mu\text{l}$  of the appropriate restriction enzyme buffer.

The labeling reaction may be carried out immediately after digesting the DNA with a restriction enzyme. There is no need to remove the restriction enzyme or to inactivate it. Because the Klenow fragment works well under a variety of conditions (as long as  $\text{Mg}^{2+}$  is present in millimolar concentrations), it is unnecessary to change buffers. At the end of the restriction reaction, the Klenow enzyme, unlabeled dNTPs, and the appropriate [ $\alpha$ - $^{32}\text{P}$ ]dNTP are added and the reaction is incubated for a further 15 minutes at room temperature, as described below. The procedure works well even on relatively crude DNA preparations (e.g., minipreparations of plasmids).

2. To the completed restriction digest, add:

10 mCi/ml [ $\alpha$ - $^{32}\text{P}$ ]dNTP (sp. act. 800–3000 Ci/mmol)	2–50 $\mu\text{Ci}$
unlabeled dNTPs	to a final concentration of 100 $\mu\text{M}$
Klenow fragment	1–5 units

Incubate the reaction for 15 minutes at room temperature.

Approximately 0.5 unit of the Klenow enzyme is required for each  $\mu\text{g}$  of template DNA (1  $\mu\text{g}$  of a 1000-bp fragment is equivalent to  $\sim 3.1$  pmoles of termini of double-stranded DNA; Appendix 6). The Klenow enzyme works well in almost all buffers used for digestion by restriction enzymes.

Reverse transcriptase (1–2 units) can be used in place of the Klenow enzyme in this protocol. However, reverse transcriptase is not as forgiving of buffer conditions as the Klenow enzyme and is therefore used chiefly to label purified DNA fragments in reactions containing conventional reverse transcriptase buffer.

When the labeled DNA is to be used for sequencing by the Maxam-Gilbert technique (please see Chapter 12, Protocol 7) or for mapping mRNA by the nuclease S1 method (please see Chapter 7, Protocol 10), the concentration of labeled dNTP in the reaction should be increased to the greatest level that is practicable. After the reaction has been allowed to proceed for 15 minutes at room temperature, add all four unlabeled dNTPs to a final concentration of 0.2 mM for each dNTP, and continue the incubation for a further 5 minutes at room temperature. This cold chase ensures that each recessed 3' terminus will be completely filled and that all labeled DNA molecules will be exactly the same length.

3. Stop the reaction by heating it for 10 minutes at 75°C.
4. Separate the radiolabeled DNA from unincorporated dNTP by spun-column chromatography through Sephadex G-50 (please see Appendix 8) or by two rounds of precipitation with ethanol in the presence of 2.5 M ammonium acetate (please see Appendix 8).

**PREPARING RADIOLABELED SIZE MARKERS FOR GEL ELECTROPHORESIS**

This protocol generates labeled DNA fragments that can be used as size markers during gel electrophoresis. Because the fragments are labeled in proportion to their molar concentrations and not their sizes, both small and large fragments in a restriction enzyme digest become labeled to an equal extent. Bands of DNA that are too small to be visualized by staining with ethidium bromide can therefore be located by autoradiography.

It is desirable, but not necessary, to remove unincorporated [ $\alpha$ - $^{32}\text{P}$ ]dNTP from the radiolabeled DNA before gel electrophoresis. The [ $\alpha$ - $^{32}\text{P}$ ]dNTP migrates faster than bromophenol blue on both polyacrylamide and agarose gels and does not interfere with the detection of anything but the smallest of DNA fragments. However, removing the unincorporated radiolabel has some advantages: It avoids the possibility of contaminating the anodic buffer chamber of the electrophoresis tank with radioactivity, it allows the amount of radiolabeled DNA applied to the gel to be estimated by a hand-held minimonitor, and it reduces the possibility of radiochemical damage to the DNA.

TABLE 9-2 End-labeling of DNA

TEMPLATE	DESIRED POSITION OF LABEL	PREFERRED METHODS
Single-stranded DNA or RNA	5' terminus	<p><i>Kinase reaction:</i> A hydroxyl group is first created by removing the unlabeled phosphate residue from the 5' end of the nucleic acid with an alkaline phosphatase such as CIP or SAP (<b>Protocol 13</b>). Bacteriophage T4 polynucleotide kinase is then used to transfer the label from the <math>\gamma</math> position of ATP to the newly created 5'-hydroxyl group (Wu et al. 1976) (<b>Protocols 14 and 15</b>). These reactions can be carried out sequentially in one tube but require inhibition of phosphatase with inorganic phosphate (Chaconas and van de Sande 1980; Cobianchi and Wilson 1987). An alternative procedure has been described in which digestion with a restriction endonuclease and 5'-end labeling with polynucleotide kinase can be carried out in one step without the benefit of alkaline phosphatase (Oommen et al. 1990). The mechanism of this reaction is obscure.</p> <p><i>Exchange reaction:</i> The unlabeled phosphate residue is transferred from the 5' terminus of the nucleic acid to ADP and is then replaced by labeled phosphate from the <math>\gamma</math> position of ATP (<b>Protocol 16</b>). Both of these reactions are catalyzed by bacteriophage T4 polynucleotide kinase and proceed simultaneously in the same test tube in the presence of excess ADP and limiting amounts of <math>\gamma</math>-labeled ATP (Berkner and Folk 1977). When labeling single-stranded DNAs that are &gt;300 nucleotides in length, the overall efficiency of the exchange reaction is greatly improved by including a macromolecular crowding agent such as polyethylene glycol (4–10%) in the reaction mixture (Harrison and Zimmerman 1986a,b). Even so, the specific activity of the 5'-labeled DNA is always less than can be achieved with the kinase reaction.</p> <p><i>Note:</i> Bacteriophage T4 polynucleotide kinase carries a 3'-phosphatase activity that degrades ATP. Several commercial suppliers prepare the enzyme from cells infected with a strain of bacteriophage T4 (amN81 <i>pseT1</i>) that carries a mutated version of the gene encoding polynucleotide kinase. This mutant form of the enzyme lacks 3'-phosphatase activity.</p>
Single-stranded DNA	3' terminus	<p>Template-independent polymerization of [<math>\alpha</math>-<math>^{32}</math>P]NTP to the 3' terminus of single-stranded DNA is catalyzed by calf thymus terminal deoxynucleotidyl transferase. If the DNA is to be used for Maxam-Gilbert sequencing, use a radiolabeled <i>ribonucleotide</i> as the substrate for the transferase reaction, which then requires <math>\text{Co}^{2+}</math> as a cofactor (Deng and Wu 1983). The radiolabeled DNA is then exposed to alkali and treated with alkaline phosphatase to generate a uniformly labeled DNA fragment of defined length (Roychoudhury et al. 1976, 1979; Wu et al. 1976). Alternatively, incorporation at the 3' terminus can be limited to just one nucleotide by using [<math>\alpha</math>-<math>^{32}</math>P]dideoxyATP (Yousaf et al. 1984) or [<math>\alpha</math>-<math>^{32}</math>P]cordycepin triphosphate (Tu and Cohen 1980) as a substrate for terminal transferase (<b>Protocol 12</b>). Because neither of these molecules carries a 3'-hydroxyl group, no additional molecules can be incorporated. Under most circumstances, [<math>\alpha</math>-<math>^{32}</math>P]dideoxyATP is the preferred substrate for labeling 3' termini because it is incorporated more efficiently than [<math>\alpha</math>-<math>^{32}</math>P]cordycepin triphosphate. However, DNA molecules carrying cordycepin residues at their 3' termini have one advantage: They are resistant to digestion with contaminating exonucleases that may remove 3'-terminal ribonucleotide labels from single-stranded DNA.</p> <p>Terminal transferase can also be used to add biotinylated or fluoresceinated deoxy- or dideoxynucleotides to the 3' termini of single-stranded DNA fragments (e.g., please see Vincent et al. 1982; Schneider et al. 1994).</p>
Double-stranded DNA with protruding 5' terminus	5' termini	Labeling is carried out with polynucleotide kinase as described above for labeling of the 5' termini of single-stranded DNA ( <b>Protocol 14</b> ).
Double-stranded DNA with blunt-ended or recessed 5' termini	5' termini	Labeling is carried out with polynucleotide kinase as described above for labeling of the 5' termini of single-stranded DNA ( <b>Protocol 15</b> ). However, double-stranded DNA molecules with blunt ends or recessed 5' termini are labeled less efficiently by polynucleotide kinase than molecules with protruding 5' termini. Even a partial reaction at recessed 5' termini requires large amounts of enzyme and [ $\gamma$ - $^{32}$ P]ATP.
Double-stranded DNA with blunt-ended or recessed 3' termini	3' termini	The Klenow fragment, which retains the template-dependent deoxynucleotide polymerizing activity and the 3'→5' exonuclease of the holoenzyme but lacks its powerful 5'→3' exonuclease activity, is used to fill recessed 3' termini of double-stranded DNA ( <b>Protocol 10</b> ). Usually, only one of the four dNTPs present in the reaction mixture is radiolabeled. The presence of the three unlabeled dNTPs serves two purposes: It blocks exonucleolytic removal of nucleotides from the 3' terminus of the template, and it allows the radiolabeled dNTP to be the second, third, or fourth nucleotide added to the recessed 3' terminus. The presence of only one radiolabeled dNTP in the reaction mixture some-

(Continued on following page.)

TABLE 9-2 (Continued)

TEMPLATE	DESIRED POSITION OF LABEL	PREFERRED METHODS
		<p>times permits double-stranded DNA that has been cleaved with two different restriction endonucleases to be labeled selectively at only one end. For example, a DNA that has been cleaved with</p> <p style="text-align: center;"> <math display="block">\begin{array}{c} \text{G} \qquad \qquad \qquad \text{G} \\ \text{BamHI CCTAG and EcoRI CT} \end{array}</math> </p> <p>can be selectively labeled at the <i>Bam</i>HI terminus by using [<math>\alpha</math>-<math>^{32}</math>P]dGTP as the sole source of radioactivity in the fill-in reaction. Alternatively, DNA can be cleaved with one restriction enzyme, radiolabeled, and then cleaved with a second enzyme to generate two DNA fragments, each of which carries radiolabel at only one end.</p> <p>Specialized vectors have been constructed that facilitate the asymmetric labeling of DNA fragments. For example, pSP64CS and pSP65CS contain sites that are cleaved by the restriction enzyme <i>Tth</i>1111, which recognizes the redundant sequence</p> <p style="text-align: center;"> <math display="block">\begin{array}{c} \downarrow \\ 5' \text{ GACN} \overline{\text{N}} \text{NGTC } 3' \\ 3' \text{ CTGN} \overline{\text{N}} \text{NCAG } 5' \\ \uparrow \end{array}</math> </p> <p>and generates a terminus with a single protruding 5' nucleotide. The DNA of interest is cloned between two <i>Tth</i>1111 sites that yield DNAs with different protruding nucleotides at their termini. After cleavage, the DNA can be selectively labeled at one or both ends by the Klenow fragment and the appropriate [<math>\alpha</math>-<math>^{32}</math>P]dNTP(s) (Volkaert et al. 1984; Eckert 1987).</p> <p>Blunt-ended DNA fragments can be labeled by template-independent addition of a single nucleotide (usually [<math>\alpha</math>-<math>^{32}</math>P]dATP) catalyzed by <i>Taq</i> polymerase.</p>
Double-stranded DNA with protruding 3' termini	3' termini	<p>Bacteriophage T4 DNA polymerase carries a 5'→3' polymerase and a 3'→5' exonuclease activity that is more active on single-stranded DNA than double-stranded DNA. The exonuclease of bacteriophage T4 DNA polymerase is ~200 times more potent than the equivalent exonuclease of the Klenow fragment. T4 DNA polymerase is used to end-label DNA molecules with protruding 3' termini (<b>Protocol 11</b>). This reaction works in two stages. First, the powerful 3'→5' exonuclease removes the protruding tails from the DNA and creates recessed 3' termini. Then, in the presence of high concentrations of radiolabeled precursor(s), exonucleolytic degradation is balanced by incorporation of dNTPs at the 3' termini. This reaction, which consists of cycles of removal and replacement of the 3'-terminal nucleotides from recessed or blunt-ended DNA, is sometimes called an exchange or replacement reaction (O'Farrell et al. 1980).</p> <p>Alternatively, protruding 3' termini can be labeled by template-independent addition of nucleotides catalyzed by calf thymus terminal deoxynucleotidyl transferase, poly(A) polymerase (please see 3'-terminal labeling of single-stranded DNA and <b>Protocol 12</b>) or certain thermostable DNA polymerases, for example, <i>Taq</i> (please see Table 8-1 in Chapter 8 and Protocol 3 of this chapter).</p>
RNA	3' termini	<p>Bacteriophage T4 RNA ligase catalyzes the joining of a terminating radioactive bisphosphate nucleotide ([5'-<math>^{32}</math>P]pNp) to a 3'-hydroxyl terminus of RNA (Uhlenbeck and Gumpert 1982). The reaction extends the length of the RNA molecule by one nucleotide and generates a phosphorylated 3' terminus with a [<math>^{32}</math>P]phosphate in the last internucleotide linkage (England et al. 1977; Kikuchi et al. 1978; Tyc and Steitz 1989). The terminal 3'-phosphate group acts as a chain terminator by preventing formation of further phosphodiester bonds. This method of labeling has been used chiefly with small RNAs. However, perhaps because of steric effects caused by secondary structure, the amount of label incorporated seriously misrepresents the relative abundance of the RNAs used as substrates.</p> <p>Poly(A) polymerase catalyzes the template-independent addition of A residues to the 3' terminus of RNA. When [<math>\alpha</math>-<math>^{32}</math>P]ATP is used as a substrate, the phosphodiester bonds in the poly(A) tract contain <math>^{32}</math>P atoms (Lingner and Keller 1993). Substitution of cordycepin triphosphate (3'-dATP) for ATP results in the addition of a single 3'-dA residue to the end of the RNA, which is a useful method for radiolabeling RNA at the 3' end. Yeast poly(A) polymerase preferentially labels longer RNA molecules, whereas short RNA molecules are labeled more efficiently by RNA ligase. Terminal transferase has been used to add a biotin-labeled dideoxynucleotide to the 3' terminus of RNA (Schneider et al. 1994). However, the efficiency of this reaction has not been thoroughly investigated.</p>

# Protocol 11

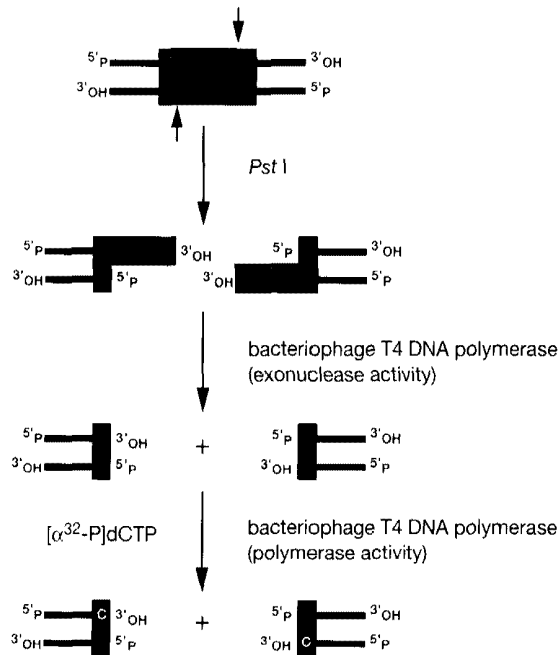
---

## Labeling 3' Termini of Double-stranded DNA with Bacteriophage T4 DNA Polymerase

**R**ESTRICTION ENZYMES SUCH AS *Pst*I, *Pvu*I, AND *Sac*I CLEAVE DNA asymmetrically to produce fragments with protruding 3' ends. The termini of these fragments are difficult to label in reactions catalyzed by the Klenow fragment, in part because this enzyme has a weak 3'→5' exonuclease activity. However, the DNA polymerase encoded by gene 43 of bacteriophage T4 carries a 3'→5' exonucleolytic activity that is more active against single-stranded substrates than double-stranded substrates and ~200-fold more powerful than the Klenow enzyme. The bacteriophage-encoded enzyme rapidly digests 3'-protruding termini and then continues at a slower pace to remove 3' nucleotides from the double-stranded portion of the DNA substrate. In the absence of dNTPs, the enzyme degrades double-stranded molecules to approximately half-length single strands. However, in the presence of high concentrations of dNTPs, recessed 3'-hydroxyl termini generated by exonucleolytic activity act as primers for template-directed addition of mononucleotides by the 5'→3' polymerase. Because the synthetic capacity of bacteriophage T4 DNA polymerase exceeds its exonucleolytic abilities, protruding 3' termini are converted to termini with flush ends (Richardson et al. 1964b). If one of the four dNTPs is radiolabeled, the resulting blunt-ended double-stranded molecules will be labeled at or near their 3' termini (Goulian et al 1968). For a summary of methods used to label the termini of DNA, please see Table 9-2 in Protocol 10.

Careful studies of the kinetics of the exonuclease and fill-in reactions catalyzed by bacteriophage T4 DNA polymerase indicate that the incorporation of radiolabel into DNA is nonrandom (Bortner and Griffith 1993). Thus, radiolabeled fragments typically have extensive tracts of newly synthesized DNA, rather than all DNA templates being end-labeled. This labeling pattern apparently arises because the initiation of the exonuclease reaction is the rate-limiting step. Once started, the enzyme continues to digest the DNA in the 3'→5' direction for a considerable length and then subsequently fills in the resected DNA. If the goal is the generation of an end-labeled population of DNA molecules from a blunt-ended or 5'-recessed template, it is best to carry out a two-stage reaction in which the template is first digested with exonuclease III at reduced temperatures and then regenerated by bacteriophage T4 DNA polymerase (Bortner and Griffith 1993).

In the presence of a single  $\alpha$ -radiolabeled dNTP (e.g., [ $\alpha$ -<sup>32</sup>P]dCTP), the enzyme progressively removes nucleotides until it exposes a G residue on the complementary DNA strand. An idling-turnover reaction is then established in which the radiolabeled C residue is removed by the exonuclease and replaced with a fresh radiolabeled residue by the polymerase (Young et al. 1992). In the case of DNA fragments generated by *Pst*I, the idling-turnover reaction may be outlined as shown in Figure 9-3.



**FIGURE 9-3 Labeling Using the Idling/Turnover Feature**

Please see text for details.

Fragments radiolabeled by the idling-turnover reaction can be used as probes for mapping RNA with nuclease S1 or mung bean nuclease (Chapter 7, Protocol 10); for Southern analysis of cosmid, plasmid, or bacteriophage DNAs; or for screening bacterial colonies and bacteriophage plaques. In addition, the labeled fragments can be used as size markers during gel electrophoresis and as primers in primer-extension reactions. For further details, please see the introduction to Protocol 10.

## MATERIALS

**CAUTION:** Please see Appendix 12 for appropriate handling of materials marked with <!>.

### Buffers and Solutions

Please see Appendix 1 for components of stock solutions, buffers, and reagents. Dilute stock solutions to the appropriate concentrations.

Ammonium acetate (10 M)

Ethanol

Phenol:chloroform (1:1, v/v) <!>

### Enzymes and Buffers

*Appropriate restriction enzyme(s)*

Choose enzymes that produce blunt or 3'-protruding termini. In many cases, digestion can be carried out in T4 DNA polymerase buffer, allowing the digestion and labeling reactions to be carried out sequentially without an intermediate extraction with phenol:chloroform and precipitation with ethanol. However, not all restriction enzymes work in bacteriophage T4 DNA polymerase buffer, and it is advisable to follow the manufacturer's advice and/or to carry out pilot reactions with the particular restriction enzyme before using this shortcut.

*Bacteriophage T4 DNA polymerase*

*10x Bacteriophage T4 DNA polymerase buffer*

## Nucleic Acids and Oligonucleotides

*dNTP solution containing three unlabeled dNTPs, each at 2 mM*

The three dNTPs to be included in this solution depend on the DNA sequence of the restriction endonuclease site to be radiolabeled. None of them should carry the same base as the radiolabeled nucleotide (please see the introduction to Protocol 10). For advice on making and storing solutions of dNTPs, please see the information panel on **PREPARATION OF STOCK SOLUTIONS OF dNTPs AND ddNTPs FOR DNA SEQUENCING** in Chapter 12.

*dNTP solution containing one unlabeled dNTP at a concentration of 2 mM*

▲ **IMPORTANT** The dNTP used here should carry the same base as the radiolabeled dNTP.

*Template DNA (0.1–5 µg)*

Use linear, double-stranded DNA carrying appropriate blunt or protruding 3' termini.

## Radioactive Compounds

*[ $\alpha$ -<sup>32</sup>P]dNTP (10 mCi/ml, sp. act. 800–3000 Ci/mmol) <!>*

To minimize problems caused by radiolysis of the precursor and the probe, it is best, whenever possible, to prepare radiolabeled probes on the day the [<sup>32</sup>P]dNTP arrives in the laboratory.

## Special Equipment

*Sephadex G-50 spun column, equilibrated in TE (pH 7.6)*

Optional, please see Step 6.

*Water bath preset to 70°C*

## METHOD

---

1. Digest 0.1–5.0 µg of the template DNA with a restriction enzyme(s) that generates a blunt or 3'-protruding end.

Please see the note under Appropriate restriction enzymes in the Materials section of this protocol.

2. Purify the DNA by extraction with phenol:chloroform and precipitation with ethanol in the presence of 2.5 M ammonium acetate (please see Appendix 8).

3. Dissolve the DNA pellet in:

10x bacteriophage T4 DNA polymerase buffer	2 µl
2 mM solution of three unlabeled dNTPs	1 µl
10 mCi/ml [ $\alpha$ - <sup>32</sup> P]dNTP (800–3000 Ci/mmol)	1 µl
bacteriophage T4 DNA polymerase (2.5 units/µl)	1 µl
H <sub>2</sub> O	to 20 µl

Incubate the reaction for 5 minutes at 37°C.

4. Add 1 µl of a 2 mM solution of the unlabeled fourth dNTP. Continue the incubation for a further 10 minutes.
5. Stop the reaction by heating it to 70°C for 5 minutes.
6. Separate the labeled DNA from unincorporated dNTPs by spun-column chromatography through Sephadex G-50 (please see Appendix 8) or by two rounds of precipitation with ethanol in the presence of 2.5 M ammonium acetate (please see Appendix 8).

# Protocol 12

---

## End Labeling Protruding 3' Termini of Double-stranded DNA with [ $\alpha$ - $^{32}$ P]Cordycepin 5'-Triphosphate or [ $\alpha$ - $^{32}$ P]dideoxyATP

**T**HE 3'-PROTRUDING ENDS OF DNA, SUCH AS THOSE GENERATED by *Pst*I or *Sac*I or other restriction enzymes, can be labeled by using the enzyme calf thymus terminal transferase to catalyze the transfer of [ $\alpha$ - $^{32}$ P]dideoxyATP (Yousaf et al. 1984) or [ $\alpha$ - $^{32}$ P]cordycepin triphosphate (Tu and Cohen 1980). Because neither of these molecules carries a 3'-hydroxyl group, no additional nucleotides can be attached to the protruding 3' end. Under most circumstances, [ $\alpha$ - $^{32}$ P]dideoxyATP is the preferred substrate for labeling 3' termini because it is incorporated more efficiently than [ $\alpha$ - $^{32}$ P]cordycepin triphosphate. However, DNA molecules carrying cordycepin residues at their 3' termini have one advantage: They are resistant to digestion with contaminating exonucleases that can remove 3'-terminal labels from DNA. For a summary of methods used to label the termini of DNA, please see Table 9-2 in Protocol 10.

### MATERIALS

---

**CAUTION:** Please see Appendix 12 for appropriate handling of materials marked with <!>.

#### Buffers and Solutions

Please see Appendix 1 for components of stock solutions, buffers, and reagents.  
Dilute stock solutions to the appropriate concentrations.

*Ammonium acetate (10 M)*

Optional, please see Step 6.

*Ethanol*

*Phenol:chloroform (1:1, v/v) <!>*

#### Enzymes and Buffers

*Appropriate restriction enzyme(s)*

Choose enzymes that produce 3'-protruding termini.

*Calf thymus terminal transferase*

*5x Terminal transferase buffer*



## Nucleic Acids and Oligonucleotides

Template DNA (0.1–5 µg)

Use linear, double-stranded DNA carrying appropriate protruding 3' termini.

## Radioactive Compounds

[ $\alpha$ - $^{32}$ P]Cordycepin triphosphate (10 mCi/ml, sp. act. 5000 Ci/mmole) <1>

Cordycepin (3'-deoxyadenosine), isolated from the culture fluids of *Cordyceps militaris* (a club-shaped mushroom), was the first nucleotide antibiotic to be discovered (Cunningham et al. 1951).

or

[ $\alpha$ - $^{32}$ P]DideoxyATP (10 mCi/ml, sp. act. 3000 Ci/mmole) <1>

To minimize problems caused by radiolysis of the precursor and the probe, it is best, whenever possible, to prepare radiolabeled probes on the day the  $^{32}$ P-labeled nucleotide arrives in the laboratory.

## Special Equipment

Sephadex G-50 spun column, equilibrated in TE (pH 7.6)

Optional, please see Step 6.

## METHOD

---

1. Digest 0.1–5 µg of template DNA with the appropriate restriction enzyme.
2. Purify the DNA by extraction with phenol:chloroform and standard precipitation with ethanol.
3. Dissolve the digested DNA in 10 µl of 5x terminal transferase buffer and 34 µl of H<sub>2</sub>O.
4. Add 5 µl of 10 mCi/ml [ $\alpha$ - $^{32}$ P]cordycepin 5'-triphosphate (5000 Ci/mmole) or [ $\alpha$ - $^{32}$ P]dideoxyATP (3000 Ci/mmole) and 1 µl of calf thymus terminal transferase (~20 units).  
20 units of calf thymus terminal transferase are required to catalyze the radiolabeling of ~10 pmoles of protruding 3' termini.
5. Incubate the reaction for 1 hour at 37°C.
6. Separate the labeled DNA from unincorporated [ $\alpha$ - $^{32}$ P]cordycepin 5'-triphosphate (or [ $\alpha$ - $^{32}$ P]dideoxyATP) by spun-column chromatography through Sephadex G-50 or by two rounds of precipitation with ethanol in the presence of 2.5 M ammonium acetate (please see Appendix 8).

RNA can be end-labeled with [ $^{32}$ P]cordycepin and yeast-encoded poly(A) polymerase, an enzyme that catalyzes the addition of adenosine residues onto the terminal 3'-hydroxyl group of any oligo- or polyribonucleotide (Lingner and Keller 1993). Substitution of radiolabeled cordycepin triphosphate (3'-dATP) for ATP results in the addition of a single 3'-dA residue to the 3' end of the RNA. Yeast poly(A) polymerase preferentially labels longer RNA molecules, whereas short RNA molecules are labeled more efficiently by RNA ligase.

Alternatively, radiolabeled [ $^{32}$ P]pCp can be attached to the 3' ends of RNA substrates with RNA ligase, an enzyme coded by bacteriophage T4 that catalyzes the ATP-dependent intra- and intermolecular formation of phosphodiester bonds between 5'-phosphate and 3'-hydroxyl termini of single-stranded RNA or DNA. The minimal substrate is a nucleoside 3',5'-diphosphate such as pCp (Uhlenbeck and Gumpert 1982).

# Protocol 13

---

## Dephosphorylation of DNA Fragments with Alkaline Phosphatase

**T**HE REMOVAL OF 5' PHOSPHATES FROM NUCLEIC ACIDS is used to enhance subsequent labeling with [ $\gamma$ - $^{32}$ P]ATP, to reduce the circularization of plasmid vectors in ligation reactions, and to render DNA susceptible or resistant to other enzymes that act on nucleic acids (e.g.,  $\lambda$  exonuclease). Essentially any nucleotide phosphatase (e.g., bacterial alkaline phosphatase, calf intestinal alkaline phosphatase [CIP], placental alkaline phosphatase, shrimp alkaline phosphatase [SAP], or several acid phosphatases such as sweet potato and prostate acid phosphatase) will catalyze the removal of 5' phosphates from nucleic acid templates. In fact, these enzymes prefer small substrates such as *p*-nitrophenyl phosphate and the exposed 5' phosphates of nucleic acids to bulky globular protein substrates. For additional details on alkaline phosphatases, please see the information panel on **ALKALINE PHOSPHATASE**.

Because CIP and SAP are commercially available and readily inactivated, they are the most widely used phosphatases in molecular cloning. Although CIP is less expensive per unit of activity, SAP enzyme has the advantage of being readily inactivated in the absence of chelators. DNA modification reactions (e.g., phosphorylation and ligation) can therefore be carried out in serial fashion in the same reaction tube, thereby avoiding extraction with phenol:chloroform and precipitation with ethanol.

### MATERIALS

---

**CAUTION:** Please see Appendix 12 for appropriate handling of materials marked with <!.>.

#### Buffers and Solutions

Please see Appendix 1 for components of stock solutions, buffers, and reagents. Dilute stock solutions to the appropriate concentrations.

*Chloroform* <!.>

*EDTA (0.5 M, pH 8.0) or EGTA (0.5 M, pH 8.0), if using CIP*

*Ethanol*

*Phenol:chloroform (1:1, v/v) <!.>*

*SDS (10% w/v), if using CIP*

Sodium acetate (3 M, pH 7.0 [if using CIP] and pH 5.2)

The 3 M sodium acetate solution at pH 7.0 is used because EDTA precipitates from solution at acid pH.

TE (pH 7.6)

Tris-Cl (1 M, pH 8.5)

## Enzymes and Buffers

Calf intestinal alkaline phosphatase (CIP) or Shrimp alkaline phosphatase (SAP) (US Biochemicals, Boehringer Mannheim, or Worthington Biochemicals)

10x CIP dephosphorylation buffer or 10x SAP dephosphorylation buffer

Proteinase K

Restriction enzyme(s)

## Nucleic Acids and Oligonucleotides

DNA sample (0.1–10 µg [1–100 pmoles])

Dephosphorylation reactions are usually carried out in a volume of 25–50 µl containing 1–100 pmoles of 5'-phosphorylated termini of DNA.

## Special Equipment

Water baths or heating blocks preset to 56°C, 65°C, or 75°C (CIP) or 70°C (SAP)

### CALCULATING THE AMOUNT OF 5' ENDS IN A DNA SAMPLE

Use the following formulas to calculate the number of pmoles of 5' ends present in a given DNA sample.

#### For double-stranded DNA

Amount of 5' ends (in pmoles) =  $[X/(Y \times 660 \text{ g/mole/base pair})] \times 10^{12} \text{ pmoles/mole} \times 2 \text{ ends/molecule}$

Where X is the mass of DNA fragment in grams and Y is the length of DNA fragment in base pairs. For example, 1 µg of linearized 3-kb plasmid DNA = 1 pmole 5' ends, and 1 µg of a 1-kb double-stranded DNA fragment = 3 pmoles 5' ends.

#### For single-stranded DNA

pmole 5' ends =  $[X/(Y \times 330 \text{ g/mole/nucleotide})] \times 10^{12} \text{ pmoles/mole}$

Where X is the mass of DNA fragment in grams and Y is the length of DNA fragment in nucleotides. For example, 1 µg (~0.03 OD<sub>260</sub>) of a 25-mer oligodeoxynucleotide is 120 pmoles 5' ends.

## METHOD

1. Use the restriction enzyme of choice to digest to completion 1–10 µg (10–100 pmoles) of the DNA to be dephosphorylated.

Follow the restriction enzyme manufacturer's recommendations for incubation time and temperature. The progress of the digest can be analyzed by agarose gel electrophoresis.

CIP and SAP will dephosphorylate DNA at a slightly reduced efficiency in restriction buffers that have been adjusted to pH 8.5 with 10x CIP or 10x SAP buffer, as is done in the next step. If this is unacceptable, the restricted DNA may be purified by extraction with phenol:chloroform and standard precipitation with ethanol and then dissolved in a minimal volume of 10 mM Tris-Cl (pH 8.5).

## 2. Dephosphorylate the 5' ends of the restricted DNA with either CIP or SAP.

**TO DEPHOSPHORYLATE DNA USING CIP****a.** Add to the DNA:

10x CIP dephosphorylation buffer	5 $\mu$ l
H <sub>2</sub> O	to 48 $\mu$ l

**b.** Add the appropriate amount of CIP.

1 unit of CIP will dephosphorylate ~1 pmole of 5'-phosphorylated termini (5'-recessed or blunt-ended DNA) or ~50 pmoles of 5'-protruding termini. These amounts may vary slightly from one manufacturer to the next.

- c.** Incubate the reaction for 30 minutes at 37°C, add a second aliquot of CIP, and continue incubation for a further 30 minutes.
- d.** To inactivate CIP at the end of the incubation period, add SDS and EDTA (pH 8.0) to final concentrations of 0.5% and 5 mM, respectively. Mix the reagents well, and add proteinase K to a final concentration of 100  $\mu$ g/ml. Incubate for 30 minutes at 56°C.
- e.** Cool the reaction to room temperature and purify the DNA by extracting it twice with phenol:chloroform and once with chloroform alone.

Proteinase K and SDS used to inactivate and digest CIP must be completely removed by extraction with phenol:chloroform prior to subsequent enzymatic treatments (phosphorylation by polynucleotide kinase, ligation, etc.).

▲ **IMPORTANT** A single extraction with chloroform alone is insufficient to reduce the concentration of SDS to the point where it no longer will inhibit polynucleotide kinase. Kurien et al. (1997) suggest that up to four extractions with chloroform may be required.

Glycogen or linear polyacrylamide (Gaillard and Strauss 1990) can be added as a carrier before phenol:chloroform extraction if small amounts of DNA (<100 ng) were used in the reaction. Do not add carrier nucleic acid (tRNA, salmon sperm DNA, etc.), as it will compete with the dephosphorylated DNA for the radiolabeled ATP during the kinasing reaction.

Alternatively, CIP can be inactivated by heating to 65°C for 30 minutes (or 75°C for 10 minutes) in the presence of 10 mM EGTA (pH 8.0)

▲ **IMPORTANT** Use EGTA not EDTA.

**TO DEPHOSPHORYLATE DNA USING SAP****a.** Add to the DNA:

10x SAP dephosphorylation buffer	5 $\mu$ l
H <sub>2</sub> O	to 48 $\mu$ l

**b.** Add the appropriate amount of SAP.

1 unit of SAP will dephosphorylate ~1 pmole of 5'-phosphorylated termini (3'-recessed or 5'-recessed) or ~0.2 pmole of blunt-ended DNA. These amounts may vary slightly from one enzyme manufacturer to the next.

- c.** Incubate the reaction for 1 hour at 37°C.
- d.** To inactivate SAP, transfer the reaction to 70°C, incubate for 20 minutes, and cool to room temperature.
- 3.** Transfer the aqueous phase to a clean microfuge tube, and recover the DNA by standard ethanol precipitation in the presence of 0.1 volume of 3 M sodium acetate (pH 5.2) if SAP was used or 0.1 volume of 3 M sodium acetate (pH 7.0) if CIP was used.

4. Allow the precipitate to dry at room temperature before dissolving it in TE (pH 7.6) at a DNA concentration of >2 nmoles/ml.

To remove 5' phosphates from RNA, use 0.01 unit of CIP/pmole of 5' termini. Incubate for 15 minutes at 37°C, followed by 30 minutes at 55°C. Alternatively, use 0.01–0.1 unit of SAP/pmole of 5' ends to dephosphorylate RNA in a 1-hour incubation at 37°C.

If the dephosphorylated DNA is to be used as a substrate for polynucleotide kinase, it must be rigorously purified by spun-column chromatography, gel electrophoresis, density gradient centrifugation, or chromatography on columns of Sepharose CL-4B to free it from low-molecular-weight nucleic acids. Although such contaminants may make up only a small fraction of the weight of the nucleic acid in the preparation, they contribute a much larger proportion of the 5' termini. Unless steps are taken to remove them, contaminating low-molecular-weight DNA and RNA molecules can be the predominant species of nucleic acids that are labeled in reactions catalyzed by bacteriophage T4 polynucleotide kinase.

Because ammonium ions are strong inhibitors of bacteriophage T4 polynucleotide kinase, dephosphorylated DNAs should not be dissolved in, or precipitated from, buffers containing ammonium salts prior to treatment with polynucleotide kinase.

# Protocol 14

---

## Phosphorylation of DNA Molecules with Protruding 5'-Hydroxyl Termini

**T**HE REMOVAL OF 5' PHOSPHATES FROM NUCLEIC ACIDS with phosphatases and their readdition in radiolabeled form by bacteriophage T4 polynucleotide kinase is a widely used technique for generating <sup>32</sup>P-labeled probes (please see the panel on **LABELING THE 5' TERMINI OF DNA WITH BACTERIOPHAGE T4 POLYNUCLEOTIDE KINASE**). When the reaction is carried out efficiently, 40–50% of the protruding 5' termini in the reaction becomes radiolabeled (Berkner and Folk 1977). However, the specific activity of the resulting probes is not as high as that obtained by other radiolabeling methods since only one radioactive atom is introduced per DNA molecule. Nevertheless, the availability of [ $\gamma$ -<sup>32</sup>P]ATP with specific activities in the 3000–7000 Ci/mmmole range allows the synthesis of probes suitable for many purposes, including:

- as hybridization probes to determine the structure and copy number of mRNAs
- as primers in primer-extension experiments to map the 5' ends of mRNAs
- as substrates in the analysis of RNA structure by nuclease S1 or mung bean nuclease
- as probes in fingerprinting and footprinting experiments
- as primers in DNA sequencing
- as probes in electrophoretic mobility shift assays

This protocol describes a method to label dephosphorylated protruding 5' termini. For a summary of methods used to label the termini of DNA, please see Table 9-2 in Protocol 10.

**LABELING THE 5' TERMINI OF DNA WITH BACTERIOPHAGE T4 POLYNUCLEOTIDE KINASE**

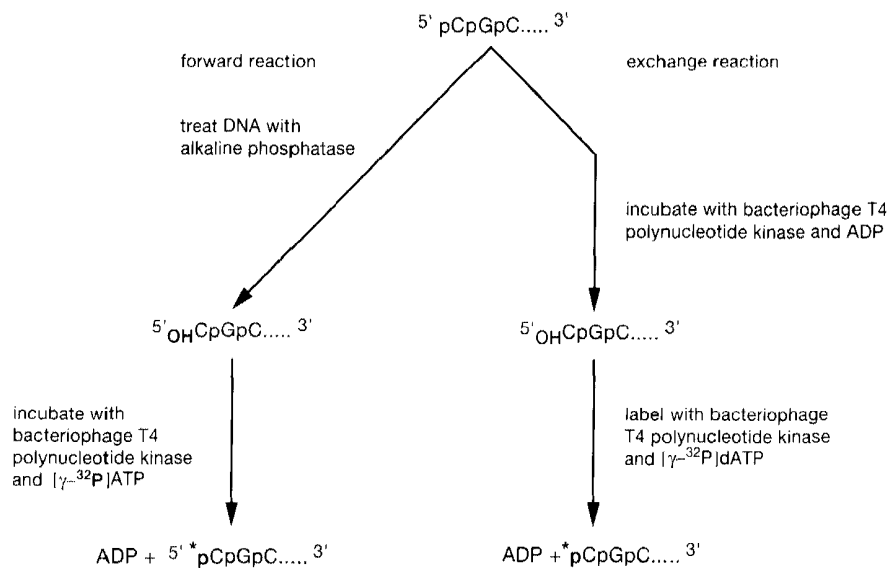
The enzyme of choice to catalyze the labeling of 5' termini of nucleic acids is bacteriophage T4 polynucleotide kinase, which facilitates transfer of  $\gamma$ -phosphate residues from [ $\gamma$ - $^{32}$ P]ATP to the 5'-hydroxyl termini of dephosphorylated single- and double-stranded DNAs and RNA. In addition, the enzyme will, with much lower efficiency, restore phosphate residues to 5'-hydroxyl groups located at nicks in double-stranded DNA. T4 polynucleotide kinase is a tetrameric protein of  $M_r \sim 142,000$  composed of four identical subunits encoded by the structural gene *pseT* of bacteriophage T4 (for reviews, please see Richardson 1971; Maunders 1993). Transfer of  $^{32}$ P to the 5' terminus of DNA catalyzed by bacteriophage T4 polynucleotide kinase can be carried out in two ways (please see Figure 9-4):

- **In the forward reaction**, single- or double-stranded DNA is first treated with a phosphatase (CIP or SAP) to remove phosphate residues from the 5' termini (Protocol 13). The resulting 5'-hydroxyl termini are then rephosphorylated by transferring the  $\gamma$ -phosphate from [ $\gamma$ - $^{32}$ P]ATP in a reaction catalyzed by polynucleotide kinase (this protocol and Protocol 15). The efficiency of radiolabeling depends on the purity of the DNA (due to kinase inhibitors present in an unpurified DNA solution) and on the sequence at the 5' terminus of the DNA. For unknown reasons, oligonucleotides with a cytosine residue at their 5' termini are labeled fourfold less efficiently than oligonucleotides beginning with A or T, and sixfold less efficiently than oligonucleotides beginning with G (van Houten et al. 1998).

Some DNA templates, such as synthetic oligonucleotides, do not have to be treated with a phosphatase enzyme before kinasing. Oligonucleotides are almost invariably synthesized with a free 5'-hydroxyl group. Because the phosphorylation reaction is reversible, T4 polynucleotide kinase will catalyze dephosphorylation of 5' termini in the presence of a molar excess of a nucleotide diphosphate acceptor, such as ADP (van de Sande et al. 1973). The second method of labeling (the exchange reaction) uses both the forward and reverse reactions catalyzed by the enzyme.

- **In the exchange reaction** (Protocol 16), the unlabeled phosphate residues are transferred from the 5' termini of DNA to ADP. The newly created 5'-hydroxyl residues are then rephosphorylated as described above in the forward reaction.

Because T4 polynucleotide kinase will work, albeit inefficiently, in restriction buffers, the exchange reaction can be carried out at the same time as restriction of DNA with enzymes that generate protruding 5' termini. The resulting DNA can be used as radiolabeled size markers for gel electrophoresis (Oommen et al. 1990).



**FIGURE 9-4 Forward and Exchange Reactions of Bacteriophage T4 Polynucleotide Kinase**

Two different reactions catalyzed by bacteriophage T4 polynucleotide kinase can be used to label the 5' termini of DNA molecules. The forward reaction is shown in the left arm of the figure, and the exchange reaction is shown in the right arm. For details, please see text.

**MATERIALS**

**CAUTION:** Please see Appendix 12 for appropriate handling of materials marked with <!>.

**Buffers and Solutions**

Please see Appendix 1 for components of stock solutions, buffers, and reagents. Dilute stock solutions to the appropriate concentrations.

*Ammonium acetate (10 M)*

Optional, please see Step 3.

*EDTA (0.5 M, pH 8.0)*

*Ethanol*

**Enzymes and Buffers**

*Bacteriophage T4 polynucleotide kinase*

Wild-type polynucleotide kinase is a 5'-phosphotransferase and a 3'-phosphatase (Depew and Cozzarelli 1974; Sirotkin et al. 1978). However, mutant forms of the enzyme (Cameron et al. 1978) are commercially available (e.g., Boehringer Mannheim) that lack the phosphatase activity but retain a fully functional phosphotransferase. We recommend that the mutant form of the enzyme be used for 5' labeling whenever possible; 10–20 units of the enzyme are required to catalyze the phosphorylation of 10–50 pmoles of dephosphorylated 5'-protruding termini.

*10× Bacteriophage T4 polynucleotide kinase buffer*

**Nucleic Acids and Oligonucleotides**

*DNA (10–50 pmoles)*

The DNA should be dephosphorylated as described in Protocol 13 or synthesized with a 5'-hydroxyl moiety. Please see the panel on **CALCULATING THE AMOUNT OF 5' ENDS IN A DNA SAMPLE** in Protocol 13.

**Radioactive Compounds**

*[ $\gamma$ -<sup>32</sup>P]ATP (10 mCi/ml, sp. act. 3000–7000 Ci/mmmole) <!>*

To minimize problems caused by radiolysis of the precursor and the probe, it is best, whenever possible, to prepare radiolabeled probes on the day the [<sup>32</sup>P]dNTP arrives in the laboratory.

**Special Equipment**

*Liquid scintillation spectrometer, capable of quantifying <sup>32</sup>P by Cerenkov radiation*

*Sephadex G-50 spun column, equilibrated in TE (pH 7.6)*

or

*Sephadex G-50 column (1 ml), equilibrated in TE (pH 7.6)*

Both optional, please see Step 3.

**METHOD**

1. In a microfuge tube, mix the following reagents:

dephosphorylated DNA	10–50 pmoles
10× bacteriophage T4 polynucleotide kinase buffer	5 $\mu$ l
10 mCi/ml [ $\gamma$ - <sup>32</sup> P]ATP (sp. act. 3000–7000 Ci/mmmole)	50 pmoles
bacteriophage T4 polynucleotide kinase	10 units
H <sub>2</sub> O	to 50 $\mu$ l



Incubate the reaction for 1 hour at 37°C.

Ideally, ATP should be in a fivefold molar excess over DNA 5' ends, and the concentration of DNA termini should be  $\geq 0.4 \mu\text{M}$ . The concentration of ATP in the reaction should therefore be  $> 2 \mu\text{M}$ , but this is rarely achievable in practice. To increase the specific activity of the radiolabeled DNA product, increase the amount of  $[\gamma\text{-}^{32}\text{P}]\text{ATP}$  used in the phosphorylation reaction. Decrease the volume of  $\text{H}_2\text{O}$  to maintain a reaction volume of 50  $\mu\text{l}$ .

2. Terminate the reaction by adding 2  $\mu\text{l}$  of 0.5 M EDTA (pH 8.0). Measure the total radioactivity in the reaction mixture by Cerenkov counting in a liquid scintillation counter.
3. Separate the radiolabeled probe from unincorporated dNTPs by either:
  - spun-column chromatography through Sephadex G-50 (please see Appendix 8)
  - or
  - conventional size-exclusion chromatography through 1-ml columns of Sephadex G-50 (equilibrated in TE)
  - or
  - two rounds of selective precipitation of the radiolabeled DNA with ammonium acetate and ethanol (please see Appendix 8)
4. Measure the amount of radioactivity in the probe preparation by Cerenkov counting. Calculate the efficiency of transfer of the radiolabel to the 5' termini by dividing the amount of radioactivity in the probe by the total amount in the reaction mixture (Step 2).

# Protocol 15

---

## Phosphorylation of DNA Molecules with Dephosphorylated Blunt Ends or Recessed 5' Termini

**D**NA SUBSTRATES WITH BLUNT ENDS, RECESSED 5' TERMINI, or internal nicks are labeled less efficiently in the forward reaction of T4 polynucleotide kinase than are molecules with protruding 5' termini. For example, the incorporation of phosphate residues at internal nicks in DNA is 30-fold less efficient than transfer to 5' termini (Lillehaug et al. 1976; Berkner and Folk 1977). However, the difficulty of labeling such substrates can be overcome by (1) increasing the concentration of ATP to astronomical levels ( $>100 \mu\text{M}$ ) (Lillehaug and Kleppe 1975a) or (2) including polyamines or polyethylene glycol 8000 (PEG 8000) in the reaction (Lillehaug and Kleppe 1975b; Harrison and Zimmerman 1986a). In the presence of PEG and magnesium, DNA collapses into a highly condensed state (Lerman 1971). The increased efficiency of the subsequent phosphorylation reaction is thought to be a consequence of the resulting macromolecular crowding (Harrison and Zimmerman 1986b; for review, please see Zimmerman and Minton 1993). The amount of stimulation is crucially dependent on the concentration of PEG. It may therefore be useful to test the efficiency of the reaction in concentrations of PEG ranging between 4% and 10%. The beneficial effects of PEG only become apparent when using DNAs longer than 300 bp. Smaller fragments of DNA are probably too rigid to collapse into a condensed state. For additional information on labeling DNA with T4 polynucleotide kinase, please see the panel on **LABELING THE 5' TERMINI OF DNA WITH BACTERIOPHAGE T4 POLYNUCLEOTIDE KINASE** in the introduction to Protocol 14. For a summary of methods used to label the termini of DNA, please see Table 9-2 in Protocol 10.

In this protocol, PEG is included, along with high concentrations of ATP and polynucleotide kinase, to enhance the labeling of DNA fragments with blunt-ended or 5'-recessed termini.

### MATERIALS

---

**CAUTION:** Please see Appendix 12 for appropriate handling of materials marked with <!>.

#### Buffers and Solutions

Please see Appendix 1 for components of stock solutions, buffers, and reagents. Dilute stock solutions to the appropriate concentrations.

*Ammonium acetate (10 M)*

Optional, please see Step 5.

EDTA (0.5 M, pH 8.0)

Ethanol

10x Imidazole buffer

500 mM imidazole-Cl (pH 6.4)

180 mM MgCl<sub>2</sub>

50 mM dithiothreitol

1 mM spermidine HCl

1 mM EDTA (pH 8.0)

Polyethylene glycol (24% w/v PEG 8000) in H<sub>2</sub>O

## Enzymes and Buffers

*Bacteriophage T4 polynucleotide kinase*

Wild-type polynucleotide kinase is a 5'-phosphotransferase and a 3'-phosphatase (Depew and Cozzarelli 1974; Sirotkin et al. 1978). However, mutant forms of the enzyme (Cameron et al. 1978) are commercially available (e.g., Boehringer Mannheim) that lack the phosphatase activity but retain a fully functional phosphotransferase. We recommend that the mutant form of the enzyme be used for 5' labeling whenever possible.

## Nucleic Acids and Oligonucleotides

DNA (10–50 pmoles in a volume of ≤11 μl)

Dephosphorylate the DNA as described in Protocol 13 or synthesize with a 5'-hydroxyl moiety. Please see the panel on **CALCULATING THE AMOUNT OF 5' ENDS IN A DNA SAMPLE** in Protocol 13.

## Radioactive Compounds

[γ-<sup>32</sup>P]ATP (10 mCi/ml, sp. act. 3000 Ci/mmmole) <!>

To minimize problems caused by radiolysis of the precursor and the probe, it is best, whenever possible, to prepare radiolabeled probes on the day the [<sup>32</sup>P]dNTP arrives in the laboratory.

## Special Equipment

Liquid scintillation spectrometer, capable of quantifying <sup>32</sup>P by Cerenkov radiation

Sephadex G-50 spun column, equilibrated in TE (pH 7.6)

or

Sephadex G-50 column (1 ml), equilibrated in TE (pH 7.6)

Both optional, please see Step 5.

## METHOD

1. In a microfuge tube, mix *in the order given*:

dephosphorylated DNA	10–50 pmoles
10x imidazole buffer	4 μl
H <sub>2</sub> O	to 15 μl
24% (w/v) PEG	10 μl

2. Add 40 pmoles of [γ-<sup>32</sup>P]ATP (10 mCi/ml; sp. act. 3000 Ci/mmmole) to the tube and bring the final volume of the reaction to 40 μl with H<sub>2</sub>O.

Ideally, ATP should be in a fivefold molar excess over DNA 5' ends, and the concentration of DNA termini should be ≥0.4 μM. The concentration of ATP in the reaction should therefore be >2 μM, but this is rarely achievable in practice. To increase the specific activity of the radiolabeled DNA product, increase the amount of [γ-<sup>32</sup>P]ATP used in the phosphorylation reaction. Decrease the volume of H<sub>2</sub>O to maintain a reaction volume of 40 μl.

3. Add 40 units of bacteriophage T4 polynucleotide kinase to the reaction. Mix the reagents gently by tapping the side of tube, and incubate the reaction for 30 minutes at 37°C.

4. Terminate the reaction by adding 2  $\mu$ l of 0.5 M EDTA (pH 8.0). Measure the total radioactivity in the reaction mixture by Cerenkov counting in a liquid scintillation counter.
5. Separate the radiolabeled probe from unincorporated dNTPs by either:
  - spun-column chromatography through Sephadex G-50 (please see Appendix 8)  
or
  - conventional size-exclusion chromatography through 1-ml columns of Sephadex G-50 (equilibrated in TE)  
or
  - two rounds of selective precipitation of the radiolabeled DNA with ammonium acetate and ethanol (please see Appendix 8)
6. Measure the amount of radioactivity in the probe preparation by Cerenkov counting. Calculate the efficiency of transfer of the radiolabel to the 5' termini by dividing the amount of radioactivity in the probe by the total amount in the reaction mixture (Step 4).

# Protocol 16

---

## Phosphorylation of DNA Molecules with Protruding 5' Termini by the Exchange Reaction

**T**HE EXCHANGE REACTION CATALYZED BY BACTERIOPHAGE T4 polynucleotide kinase (van de Sande et al. 1973; Berkner and Folk 1977) is a rapid method to label the 5' termini of DNA because, unlike the forward reaction, it does not require that the DNA be dephosphorylated. The reaction is carried out at a slightly acidic pH (6.4) in imidazole buffers to stimulate dephosphorylation by the enzyme (Berkner and Folk 1977). Because the optimal  $K_m$  values for the exchange reaction (300  $\mu$ M for ADP and 10  $\mu$ M for ATP) are higher than can be readily achieved in the test tube, the efficiency of labeling hardly ever exceeds 30%. However, the efficiency of the exchange reaction is greatly improved by including spermidine and polyethylene glycol in the reaction mixture (Lillehaug et al. 1976; Harrison and Zimmerman 1986a). For additional information on labeling DNA with T4 polynucleotide kinase, please see the panel on **LABELING THE 5' TERMINI OF DNA WITH BACTERIOPHAGE T4 POLYNUCLEOTIDE KINASE** in the introduction to Protocol 14. For a summary of methods used to label the termini of DNA, please see Table 9-2 in Protocol 10.

### MATERIALS

---

**CAUTION:** Please see Appendix 12 for appropriate handling of materials marked with <!>.

#### Buffers and Solutions

**Please see Appendix 1 for components of stock solutions, buffers, and reagents.  
Dilute stock solutions to the appropriate concentrations.**

*ADP (1 mM)*

Dissolve solid adenosine diphosphate in sterile 25 mM Tris-Cl (pH 8.0). Store small aliquots (~20  $\mu$ l) of the solution at -20°C.

*Ammonium acetate (10 M)*

Optional, please see Step 3.

*ATP (10 mM)*

Dissolve solid adenosine triphosphate in sterile 25 mM Tris-Cl (pH 8.0). Store small aliquots (~20  $\mu$ l) of the solution at -20°C.

*EDTA (0.5 M, pH 8.0)*

*Ethanol*

*10x Imidazole buffer*

500 mM imidazole·Cl (pH 6.4)  
 180 mM MgCl<sub>2</sub>  
 50 mM dithiothreitol  
 1 mM spermidine HCl  
 1 mM EDTA (pH 8.0)

*Polyethylene glycol <1> (24% w/v PEG 8000) in H<sub>2</sub>O*

**Enzymes and Buffers***Bacteriophage T4 polynucleotide kinase*

Wild-type polynucleotide kinase is a 5'-phosphotransferase and a 3'-phosphatase (Depew and Cozzarelli 1974; Sirotkin et al. 1978). However, mutant forms of the enzyme (Cameron et al. 1978) are commercially available (e.g., Boehringer Mannheim) that lack the phosphatase activity but retain a fully functional phosphotransferase. We recommend that the mutant form of the enzyme be used for 5'-labeling whenever possible; 20 units of the enzyme are required to catalyze an exchange reaction containing 10–50 pmoles of phosphorylated 5' termini.

**Nucleic Acids and Oligonucleotides***DNA (10–50 pmoles of 5'-phosphorylated termini)*

Please see the panel on **CALCULATING THE AMOUNT OF 5' ENDS IN A DNA SAMPLE** in Protocol 13.

**Radioactive Compounds.***[ $\gamma$ -<sup>32</sup>P]ATP (10 mCi/ml, sp. act. 3000–7000 Ci/mmole) <1>*

To minimize problems caused by radiolysis of the precursor and the probe, it is best, whenever possible, to prepare radiolabeled probes on the day the [<sup>32</sup>P]dNTP arrives in the laboratory.

**Special Equipment**

*Liquid scintillation spectrometer, capable of quantifying <sup>32</sup>P by Cerenkov radiation*

*Sephadex G-50 spun column, equilibrated in TE (pH 7.6)*

or

*Sephadex G-50 column (1 ml), equilibrated in TE (pH 7.6)*

Both optional, please see Step 3.

**METHOD****1. Mix the following reagents in a microfuge tube in the order given:**

DNA with 5' terminal phosphates	10–50 pmoles
10x imidazole buffer	5 $\mu$ l
1 mM ADP	5 $\mu$ l
50 nM ATP	1 $\mu$ l
10 mCi/ml [ $\gamma$ - <sup>32</sup> P]ATP (sp. act. 3000–7000 Ci/mmole)	20–100 pmoles
H <sub>2</sub> O	to 40 $\mu$ l
24% (w/v) PEG	10 $\mu$ l
bacteriophage T4 polynucleotide kinase (20 units)	1 $\mu$ l

Mix the reagents gently by tapping side of tube, and incubate the reaction for 30 minutes at 37°C.

The concentration of ADP at the beginning of the reaction is 10<sup>5</sup>-fold higher than that of ATP.

2. Terminate the reaction by adding 2  $\mu$ l of 0.5 M EDTA (pH 8.0). Measure the total radioactivity in the reaction mixture by Cerenkov counting in a liquid scintillation counter.
3. Separate the radiolabeled probe from unincorporated dNTPs by either:
  - spun-column chromatography through Sephadex G-50 (please see Appendix 8)  
or
  - conventional size-exclusion chromatography through 1-ml columns of Sephadex G-50 (equilibrated in TE)  
or
  - two rounds of selective precipitation of the radiolabeled DNA with ammonium acetate and ethanol (please see Appendix 8)
4. Measure the amount of radioactivity in the probe preparation by Cerenkov counting. Calculate the efficiency of transfer of the radiolabel to the 5' termini by dividing the amount of radioactivity in the probe by the total amount in the reaction mixture (Step 2).

---

**NONRADIOACTIVE LABELING OF NUCLEIC ACIDS**

---

Methods developed in the 1960s to detect and measure reassociation between complementary strands of nucleic acids led an entire generation of molecular biologists to rely exclusively on radioactive isotopes — usually  $^{32}\text{P}$  — to detect hybridization between labeled probes and target sequences. The protocol most familiar to investigators today involves the detection of target nucleic acids immobilized on nitrocellulose or nylon membranes. This method descends from the work of Nygaard and Hall (1963, 1964), who were the first to immobilize DNA on nitrocellulose sheets; Denhardt (1966) and Gillespie and Spiegelman (1965), who detected such fixed nucleic acids with radioactive probes; and Southern (1975), who developed methods to detect target sequences in populations of nucleic acid molecules that had been separated according to size by gel electrophoresis. After hybridization, the  $\beta$  particles emitted by radioactive probes were measured and localized by liquid scintillation counting, autoradiography, or more recently, phosphorimaging. Thus, for 30 years, hybridization of nucleic acids and radioactivity were closely intertwined; methods were designed with radioactivity in mind, and laboratory experiments were scheduled around the regular delivery of standing orders of radiolabeled compounds. In this way, both the advantages and impediments of radioactive isotopes became institutionalized and part of the culture of molecular cloning.

Although  $^{32}\text{P}$ -labeled probes can detect minute quantities of immobilized target DNA (<1 pg), they suffer from a short half-life (14.3 days) and the inability to be used for high-resolution imaging. Furthermore, when used in large quantity as orthophosphate,  $^{32}\text{P}$  must be handled in specially designed isotope laboratories. The exposure of personnel to radiation from the energetic  $\beta$  particles released by decaying  $^{32}\text{P}$  may be significant. Not surprisingly, the amount of paperwork and equipment required to order and monitor the use and disposal of radiolabeled materials has increased significantly over the years to the point where it has become a real burden. In addition, the physical and political difficulties in the storage and disposal of low-level radioactive waste have become significant, and they continue to grow. The confluence of these forces has led to a search for alternative methods that are as sensitive, but less hazardous and less costly than radiochemical techniques.

**Indirect Nonradioactive Detection Systems**

In conventional radiolabeling, fissile atoms are simply woven into the natural fabric of the probe in place of their nonradioactive homologs. In nonradioactive methods, a chemical group or compound not normally found in nucleic acids is conjugated to the probe via enzymatic, photochemical, or synthetic reactions (for reviews, please see Kricka 1992; Mansfield et al. 1995). After hybridization to the target nucleic acid, the modifying groups on the probe are detected by an appropriate indicator system. The first nonradioactive methods of detection developed in the 1980s were based on the labeling of the nucleic acid probe with dinitrophenol (Keller et al. 1988), bromodeoxyuridine (Traincard et al. 1983), or biotin (Langer et al. 1981; Chu and Orgel 1985; Reisfeld et al. 1987). It was this latter compound that provided the most durable and sensitive of these prototypic systems. After hybridization, the biotinylated probe was detected via interaction with streptavidin that had been conjugated to a reporter enzyme — usually alkaline phosphatase. The membrane was then exposed to an enzyme capable of hydrolyzing a colorigenic, fluorogenic, or chemiluminescent substrate. The sensitivity of this system derives from the rapid enzymatic conversion of the substrate to a product that is colored or emits visible or UV light at a specific wavelength. The distribution and intensity of the product correspond to the spatial distribution and concentration of target sequences on the membrane.

Because the reporter enzyme is not conjugated directly to the probe but is linked to it through a bridge (in this case, streptavidin-biotin), this type of nonradioactive detection is known as an *indirect* system. Many of the kits marketed today by commercial companies rely on indirect detection systems that are elaborations of the original biotin:streptavidin:reporter enzyme method. Most of these kits use biotinylated nucleotides (e.g., bio-11-dUTP or bio-7-dUTP) as labeling agents. The biotin moiety is conjugated to the nucleotide via a spacer 4–16 carbon atoms long, which reduces the possibility of steric hindrance during synthesis and detection of biotinylated nucleic acid probes. Under most circumstances, biotinylated probes work very well and are free from problems. However, because biotin (vitamin H) is a ubiquitous constituent of mammalian tissues and because biotinylated probes tend to stick doggedly to certain types of nylon membranes, high levels of background can occur during *in situ*, northern, and Southern hybridizations. These difficulties can be avoided by labeling probes with a compound that (1) has a low affinity for mem-





**FIGURE 9-5** *Digitalis purpurea*

(Redrawn from *A Manual of Materia Medica and Pharmacology*, 7th ed. [D.M.R. Culbreth, 1927; Lea & Febiger, Philadelphia, Pennsylvania].)

*Digitalis purpurea*.

branes of all types and (2) does not occur naturally in eukaryotic animals. The cardenolide digoxigenin (Pataki et al. 1953), which is synthesized exclusively by *Digitalis* plants (Hegnauer 1971), fulfills both of these criteria (please see Figure 9-5 and Appendix 9).

Digoxigenin (DIG), like biotin, can be chemically coupled to linkers and nucleotides and, as described below, DIG-substituted nucleotides incorporated into nucleic acid probes by any of the standard enzymatic methods. These probes generally yield significantly lower backgrounds than those labeled with biotin. DIG-labeled hybrids are detected with an anti-DIG Fab fragment conjugated to a reporter enzyme (usually alkaline phosphatase; less frequently, horseradish peroxidase; and even less frequently,  $\beta$ -galactosidase, xanthine oxidase, or glucose oxidase) (Höltke et al. 1990, 1995; Seibl et al. 1990; Kessler 1991).

Kits to synthesize and detect biotinylated probes are marketed by many commercial suppliers (for review, please see Party and Gershey 1995). However, nonradioactive detection systems that use DIG are sold exclusively by Boehringer Mannheim. The availability of two different labels and reporter systems allows two different probes to be used simultaneously to analyze the same blot or histological preparation. A few companies sell systems using fluorescein-labeled probes (fluorescein-12-UTP or -dUTP) that are detected by anti-fluorescein antibodies conjugated to alkaline phosphatase. Labeling of nucleic acids with fluorescein, biotin, or DIG is equally easy, and the sensitivity of indirect systems based on fluorescein is at least equal to those based on biotin and DIG. All three labeling systems are capable of detecting sub-picogram quantities of target nucleic acids on Southern and northern blots. Nevertheless, for reasons that are unclear, indirect systems based on fluorescein have not yet achieved the same degree of acceptance as those based on biotin and DIG.

## Methods to Label Probes with Biotin, Digoxigenin, or Fluorescein

### Enzymatic Methods

Biotinylated, digoxigeninated, or fluoresceinated nucleotides can be used to label DNA by any of the standard enzymatic techniques: priming with random oligonucleotides, PCR, nick translation, or tailing with

terminal transferase. Labeled RNA can be synthesized *in vitro* in transcription reactions catalyzed by SP6, T3, or T7 RNA polymerases. The label in all of these reactions is provided as modified uridine ribo- or deoxyribotriphosphates that are used in place of UTP or dTTP in the labeling reaction. For most enzymatic labeling reactions, the substrates of choice are uridine triphosphates carrying adducts at the -11 or -12 position (e.g., biotin-11-UTP, DIG-11-dUTP, or fluorescein-12-dUTP). However, biotin- and DIG-16-dUTP are the preferred substrates for labeling of 3' termini with terminal transferase. For recent reviews of labeling procedures, please see Viale and Dell'Orto (1992), Kessler (1992, 1994), Düring (1993), and Höltke et al. (1995).

By contrast to labeling with [<sup>32</sup>P]NTPs or [<sup>32</sup>P]dNTPs, where the efficiency of incorporation can be monitored and the specific activity of the final probe easily calculated, there is no simple or rapid method to monitor the progress of the nonisotopic labeling reactions or to calculate their efficiency. In the case of biotin- and DIG-labeled probes, the manufacturers recommend that no more than 30–35% of the thymidine residues in the probe be replaced by labeled uridine residues (please see Gebeyehu et al. 1987; Lanzillo 1990). Higher levels of replacement cause a reduction in the sensitivity with which target sequences can be detected, presumably because of the steric hindrance between closely spaced adducts during the hybridization step. However, because of a lack of an effective monitoring system, synthesis of nonradioactive probes remains an *ad hoc* affair. It is therefore best to carry out a pilot reaction in which samples are withdrawn at intervals during the course of the labeling reaction. The labeled products are tested in dot or slot blots against dilutions of the target DNA. Large-scale labeling reactions can then be designed and carried out with some confidence that the labeled product will have the required sensitivity.

### **Photolabeling**

Biotin and DIG can be attached to nucleic acids in photochemical reactions. In both cases, the label is linked to a nitrophenyl azido group that is converted by irradiation with UV or strong visible light to a highly reactive nitrene that can form stable covalent linkages to DNA and RNA (Forster et al. 1985; Habili et al. 1987). Photochemical labeling is far less efficient than enzymatic labeling: At best, only 1 base in 150 becomes modified, and the resulting probe is not potent enough to detect single-copy sequences in Southern analyses of mammalian DNA. Photoactivatable biotin (Photobiotin) is supplied by Life Technologies.

### **Detection of Nonradioactively Labeled Probes after Hybridization**

Two steps are required to detect probes labeled with biotin, fluorescein, or DIG residues after hybridization to Southern and northern blots. The membrane is first exposed to a synthetic conjugate consisting of the reporter enzyme and a ligand that binds tightly and with high specificity to the labeling moiety. In the case of biotin, most of the detection procedures exploit the high-affinity reaction between biotin and enzyme-conjugated streptavidin. Alternative procedures rely on specific monoclonal or polyclonal anti-biotin antibodies. Fluoresceinated or digoxigenated probes are routinely detected by interaction with specific enzyme-conjugated antibodies. The reporter enzyme is then assayed with colorimetric, fluorogenic, or chemiluminescent substrates.

In *colorimetric* assays (e.g., please see Leary et al. 1983; Urdea et al. 1988; Rihn et al. 1995), a combination of two dyes is used to detect alkaline phosphatase that has been captured by labeled hybrids. The enzyme catalyzes the removal of the phosphate group from BCIP (5-bromo-4-chloro-3-indolyl phosphate; Horwitz et al. 1966), generating a product that oxidizes and dimerizes to dibromodichloro indigo. The reducing equivalents produced during the dimerization reaction reduce NBT (nitroblue tetrazolium; McGadey 1970) to an insoluble purple dye, diformazan, that becomes visible at sites where the labeled probe has hybridized to its target (Leary et al. 1983; Chan et al. 1985). The results can be analyzed visually and recorded on conventional photographic film. Colorimetric detection works well with nitrocellulose and PVDF membranes, but less well with nylon and charged nylon. Unfortunately, even when working at their best, colorimetric methods are two or more orders of magnitude less sensitive than other nonradioactive detection methods, for example, chemiluminescence (Bronstein et al. 1989a; Beck and Köster 1990; Kerkhof 1992; Kricka 1992). Detection of single-copy sequences in mammalian genomes is therefore barely within the reach of colorimetric assays (Düring 1993). A final disadvantage is that the colored precipitates are difficult to remove from membranes, making reprobing difficult or impossible. In some cases, the procedures

used to strip the precipitates (100% formamide at 50–60°C) either dissolve the membrane or greatly increase its fragility.

*Fluorescent* assays for alkaline phosphatase make use of HNPP (2-hydroxy-3-naphthoic acid 2'-phenylamide phosphate; Kagiya et al. 1992). After dephosphorylation, HNPP generates a fluorescent precipitate on membranes that can be excited by irradiation at 290 nm from a transilluminator. Light emitted at 509 nm can be captured by CCD cameras or on Polaroid film using the same photographic set-up (filters, etc.) as for conventional ethidium-bromide-stained gels. Fluorescent assays using HNPP are more sensitive than colorimetric methods and are capable of detecting single-copy sequences in Southern blots of mammalian genomic DNA when the membrane is incubated with substrate for 2–10 hours (Diamandis et al. 1993; Höltke et al. 1995). The fluorescent precipitate can be easily removed by washing in ethanol and the filters used for several more rounds of hybridization before the signal-to-noise ratio increases to unacceptable levels.

*Chemiluminescence* is the fastest and most sensitive assay to detect DNA labeled with biotin, fluorescein, or DIG, via conjugates containing horseradish peroxidase (HRP) or alkaline phosphatase (S. Beck et al. 1989; Bronstein et al. 1989b,c; Schaap et al. 1989). The HRP-luminol detection system (Thorpe and Kricka 1986) is marketed exclusively by Amersham. HRP catalyzes the oxidation of luminol in the presence of hydrogen peroxide, generating a highly reactive endoperoxide that emits light at 425 nm during its decomposition to its ground state. A wide range of compounds, including benzothiazoles, phenols, naphthols, and aromatic amines, can significantly enhance the amount of light generated during the reaction (Thorpe and Kricka 1986; Pollard-Knight et al. 1990; Kricka and Ji 1995). This signal amplification, which can be as much as 1000-fold (Whitehead et al. 1983; Hodgson and Jones 1989), increases the sensitivity of the HRP-luminol system to the point where it can detect single-copy genes in Southern blots of mammalian DNA. Light is produced at a rapid rate for the first few minutes of the reaction, but thereafter declines and is no longer detectable after 1–2 hours. Under ideal conditions, ~1 pg ( $5 \times 10^{-17}$  M) of target DNA can be detected on Southern blots after 1 hour of exposure on gray-tinted, blue-light-sensitive X-ray film or a cooled CCD camera (Beck and Köster 1990; Durrant et al. 1990; Kessler 1992). The probes can be stripped from filters by heating to 80°C (Dubitsky et al. 1992).

Many commercial suppliers (please see Party and Gershey 1995) sell detection systems to detect alkaline phosphatase with dioxetane-based chemiluminescent substrates such as AMPPD and Lumigen-PPD and their more recent derivatives CSPD and CDP-*Star*, which is the most sensitive chemiluminescent substrate now available (Edwards et al. 1994; Höltke et al. 1994). CDP-*Star* differs from AMPPD in carrying halogen substituents at the 5 positions in its adamantyl and phenyl rings. This suppresses the tendency of the 1,2-dioxetane to aggregate and reduces background caused by thermal degradation (Bronstein et al. 1991). Cleavage of the phosphate ester of CDP-*Star* by alkaline phosphatase drastically reduces the thermal stability of the dioxetane ring, which consequently decomposes with emission of light at 465 nm. Nylon membranes (either amphoteric or positively charged) strongly enhance the signal (Tizard et al. 1990) by providing hydrophobic domains into which the dephosphorylated intermediate produced in the chemiluminescent reaction becomes sequestered. This stabilizes the intermediate and reduces its nonluminescent decomposition. In consequence, the intensity of the light emitted from the excited dioxetane anion begins as a glow that increases in intensity for several minutes and then persists for several hours (Martin and Bronstein 1994). The hydrophobic interactions between the nylon and the anion also cause a "blue shift" of ~10 nm in the emitted light, i.e., from 477 nm to 466 nm (Beck and Köster 1990; Bronstein 1990).

In most experimental situations, the extended kinetics of chemiluminescence on nylon filters are advantageous because they allow time to capture images at several exposures. However, the slow kinetics may be of practical importance when alkaline-phosphatase-triggered chemiluminescence is used to detect extremely low concentrations of DNA, RNA, or protein, for example, when the target band on a filter is expected to contain only  $10^{-18}$  moles. In such cases, a halogen-substituted derivative of AMPPD, for example, CSPD, may be a better choice. The addition of a chlorine atom to the 5 position of the adamantyl group restricts its interactions with nylon filters. With this compound, the time to reach maximum light emission is markedly reduced so that very small quantities of target molecules can be detected rapidly (e.g., please see Martin et al. 1991).

Under ideal conditions, as little as 1 zeptomole ( $10^{-21}$  M) of alkaline phosphatase or  $1 \times 10^{-19}$  moles of DNA can be detected (Schapp et al. 1989; Beck and Köster 1990; Bronstein 1990; Kricka 1992). Such sensitivity means that a single-copy gene in a Southern blot of mammalian genomic DNA can be detected after the nylon membrane has been exposed for ~5 minutes to gray-tinted, blue-light-sensitive X-ray film or a

cooled CCD camera (Höltke et al. 1995). The probes can be stripped by 50% formamide at 65°C (Dubitsky et al. 1992) and the nylon membranes can then be used for several further rounds of hybridization.

### Direct Nonradioactive Detection Systems

In this type of detection, nucleic acid probes are labeled directly with fluorescent dyes such as fluorescein, Texas red, or rhodamine (Agrawal et al. 1986); with lanthanide chelates (europium) (Templeton et al. 1991; Dahlén et al. 1994); with acridinium esters (Nelson et al. 1992); or with enzymes, for example, alkaline phosphatase (Jablonski et al. 1986) or horseradish peroxidase (Renz and Kurz 1984). The presence of such covalently attached adducts is assayed by any one of a number of techniques, including colorimetry, chemiluminescence, bioluminescence, time-resolved fluorometry, or energy transfer/fluorescence quenching. Of course, direct detection methods can be converted to indirect methods if an enzyme-antibody conjugate specific for the adduct is available.

Because it forms the basis of automated DNA sequencing methods (Smith et al. 1986; Ansoerge et al. 1987; Prober et al. 1987), direct labeling of nucleic acids with fluorescent compounds has revolutionized molecular biology. A single fluorescent adduct per DNA molecule is sufficient for detection by automated DNA sequencers when the DNA is in the gel. Furthermore, the ability of ABI-type automated sequencers to discriminate accurately between different fluors signifies that all four sequencing reactions can be analyzed in a single lane of a gel. The stunning success of direct labeling in automated DNA sequencing has, however, not spread to other areas of molecular cloning, where direct nonradioactive methods of detection are rarely used. This is because:

- The traditional methods used for the direct conjugation of enzymes such as alkaline phosphatase require the extensive use of column chromatography, polyacrylamide gel electrophoresis, and/or HPLC to obtain a pure product (Jablonski et al. 1986; Urdea et al. 1988; Farmar and Castaneda 1991). Commercial kits are available but are expensive and typically yield an impure product. Newer methods of conjugation (e.g., please see Reyes and Cockerell 1993) are simpler but slightly less efficient.

Whatever method is used, a separate conjugation step is required for each different probe. Once attached, large enzymes such as alkaline phosphatase may reduce the rate of annealing of probes and may be labile under the conditions conventionally used for annealing of nucleic acids. Hybridization and washing must therefore be carried out at low temperature (usually <50°C) in aqueous solvents. Under such nonstringent conditions, high backgrounds are an inevitable problem. Because of the presence of bulky, charged adducts, probes directly labeled with enzymes may bind nonspecifically but tightly to certain types of membranes. For example, the background signal from oligonucleotide probes directly conjugated to alkaline phosphatase is considerably greater on charged nylon than on neutral nylon membranes (Benzinger et al. 1995).

- The detection of single-copy sequences in Southern hybridization of mammalian DNAs lies close to the limit of sensitivity of many direct methods unless specialized equipment is available (Urdea et al. 1988). Detection of fluorescent adducts, for example, requires irradiating with light of one wavelength and acquiring data at another. The signal must then be enhanced electronically and stored digitally.

Because of these problems, it is not surprising that direct detection techniques have fallen from favor and that indirect detection has become the dominant nonradioactive method to locate target nucleic acids in Southern, northern, and in situ hybridizations. However, despite these problems, probes directly labeled with alkaline phosphatase are now produced commercially for forensic and pathological analyses. The sensitivity of these probes can approach that of isotopically labeled probes (Dimo-Simonin et al. 1992; Klevan et al. 1993; Benzing et al. 1995). The use of such standardized nonisotopically labeled probes is expected to increase greatly in laboratories involved, for example, in constructing large numbers of DNA profiles or in diagnosing infectious diseases.

### To Switch or Not to Switch

Great advances in nonradioactive detection methods have been made during the last decade, giving scientists today real choices. The advantages claimed for nonradioactive methods include faster results, more stable probes, and lower cost. However, investigators wishing to switch from radioactive to nonradioactive detection methods will be deluged with advertising from manufacturers of kits and equipment and unin-

dated with claims of superiority for one commercial product or another. The scientific literature is also large and balky, with many inconsistencies. The ranking of techniques and substrates according to the sensitivity of detection is inconsistent; well-controlled comparisons of efficiency are rarely reported, although more of this work is badly needed.

Approximately 50 different nonradioactive detection kits are now available on the commercial market and more are appearing all the time. Claims on the sensitivity and signal-to-noise ratios made on their behalf should be viewed with caution. Many of these claims are based on experiments carried out under idealized conditions, which cannot be immediately or easily reproduced by inexperienced investigators in the hurly-burly of a working laboratory. Frequently, the signal-to-noise ratio is higher than advertised and the neophyte will likely struggle to match the sensitivity of more traditional methods of radiolabeling. Many of the kits are expensive, and nonradioactive detection methods only become cost-effective after they have been optimized for the particular task at hand.

During the past 30 years, almost all of the problems with radiolabeled probes have been uncovered, analyzed, and, to a very large extent, solved. The collective wealth of knowledge about radioactive probes is both vast and easily accessible. This is not yet the case with nonradioactive detection systems, where there simply has not been time to build a body of reliable experimental lore. Nonradioactive detection of target nucleic acids is already well suited to laboratories that use a small number of probes to carry out a limited repertoire of repetitive tests under stringently controlled conditions. Research laboratories that use a wide variety of nucleic acid probes as well as forensic laboratories that must analyze irreplaceable and/or degraded DNA specimens may wish to be more circumspect and to delay embracing nonradioactive detection until the present confusion of claims and methods is resolved.

For recent reviews and papers that deal with various aspects of nonradioactive probes, please see Guesdon (1992), Viale and Dell'Orto (1992), Reischl et al. (1994), and Mansfield et al. (1995).

## E. COLI DNA POLYMERASE I AND THE KLENOW FRAGMENT

DNA polymerase I (Pol I) (Kornberg et al. 1956) consists of a single polypeptide chain ( $M_r \sim 103,000$ ; Joyce et al. 1982) encoded by the *E. coli polA* gene (De Lucia and Cairns 1969). In addition to a phosphate-exchange activity, Pol I carries out three enzymatic reactions that are performed by three distinct functional domains (please see Table 9-3).

During DNA replication in *E. coli*, the enzymatic activities of Pol I act in a coordinated fashion to remove the RNA primers from the 5' termini of nascent DNA and to fill gaps between adjacent tracts of DNA. For detailed descriptions of these processes, please see Kornberg and Baker (1992). Pol I can be cleaved by mild treatment with subtilisin into two fragments; the larger fragment (comprising residues 326–928) is known as the Klenow fragment. The DNA polymerase and the 3'→5' exonuclease activities of Pol I are carried on the Klenow fragment (Brutlag et al. 1969; Klenow and Henningsen 1970; Klenow and Overgaard-Hansen 1970; Klenow et al. 1971), whereas the 5'→3' exonuclease activity of the holoenzyme is carried on the smaller amino-terminal fragment (residues 1–325), which is nameless (for review, please see Joyce and Steitz 1987; please also see Table 9-3).

The Pol I gene has been sequenced (Joyce et al. 1982) and expressed from prokaryotic expression vectors (Murray and Kelley 1979), making it possible to purify large amounts of the protein for commercial purposes (Murray and Kelley 1979). The segment of the Pol I gene encoding the Klenow fragment has also been cloned into various expression vectors (e.g., please see Joyce and Grindley 1983; Pandey et al. 1993), thereby providing pure protein in amounts large enough for both commercial purposes and biophysical and biochemical studies.

Knowledge of the three-dimensional structure of Klenow fragment, which was obtained in 1985 by X-ray diffraction (Ollis et al. 1985), stimulated a series of elegant structural investigations (Beese and Steitz 1991; Beese et al. 1993a,b), kinetic studies (Kuchta et al. 1987, 1988; Cowart et al. 1989; Catalano et al. 1990; Guest et al. 1991), and mutational analyses (Freemont et al. 1986; Derbyshire et al. 1988, 1991; Polesky et al. 1990, 1992). The results of these various approaches are remarkably consonant, and they confirm that the active sites for polymerization of dNTPs and for 3'→5' exonucleolytic digestion reside on different structural domains of the Klenow fragment and are separated by 30–35 Å.

The exonuclease activity, which is carried on the smaller (22 kD) domain (Joyce and Steitz 1987), performs a proofreading function by resecting DNA that contains either mismatched bases or frameshift errors (Bebenek et al. 1990). 3'→5' digestion of double-stranded DNA is thought to follow a three-step pathway: binding of the substrate to a cleft in the polymerase domain, translocation of the 3' terminus to the active site of the exonuclease domain, and, finally, chemical catalysis (Catalano et al. 1990). During translocation, which is the rate-limiting step of the reaction, melting of the four or five terminal base pairs of duplex DNA (Cowart et al. 1989) generates a frayed 3' terminus that binds to the active site of the exonuclease domain,

**TABLE 9-3 The Domains of *E. coli* DNA Polymerase I**

DOMAIN	ACTIVITY	BIOCHEMICAL FUNCTION
Carboxy-terminal domain (residues 543–928, ~46 kD)	5'→3' DNA polymerase	Addition of mononucleotide residues generated from dNTPs to the 3'-hydroxyl termini of RNA or DNA primers. These termini can be provided by nicks or gaps in a duplex DNA, as well as by short segments of RNA or DNA that are base-paired to a single-stranded DNA molecule.
Central domain (residues 326–542, ~22 kD)	3'→5' exonuclease	Cleavage of nucleotide residues from 3'-hydroxyl termini creates recessed 3' termini.
Amino-terminal domain (residues 1–325)	5'→3' exonuclease	Cleavage of oligonucleotides from base-paired 5' termini.

The carboxy-terminal and central regions constitute the Klenow fragment of Pol I.

with  $K_m$  values in the nanomolar range (Kuchta et al. 1988). Three carboxylic acid residues in the active site interact directly with one or both of the divalent metal ions that are bound to the exonuclease domain and are crucial for enzymatic cleavage. The metals bound to the exonuclease domain interact with the terminal phosphate residue of the substrate (Derbyshire et al. 1991; Han et al. 1991), thereby allowing nucleophilic attack (probably from a hydroxide ion) on the exposed phosphodiester bond (Freemont et al. 1988). This reaction generates a product, dNMP, that at high concentrations can inhibit the 3'→5' exonuclease reaction (Que et al. 1978) by occupying the same site in the enzyme as the frayed terminus of single-stranded DNA (Ollis et al. 1985). The exonucleolytic degradation of double-stranded substrates is very slow with a  $k_{cat}$  of  $\sim 10^{-3} \text{ s}^{-1}$ . Digestion of single-stranded substrates, however, is  $\sim 100$  times faster, with a  $k_{cat}$  of  $0.09 \text{ s}^{-1}$  (Kuchta et al. 1988; Derbyshire et al. 1991). Using site-directed mutagenesis to change the amino acids within the active site, mutant forms of the Klenow enzyme have been constructed that retain normal polymerase activity but are essentially devoid of exonuclease activity (Derbyshire et al. 1988, 1991). The average error rate for these enzymes is  $\sim 1$  base substitution for each 10,000–40,000 bases polymerized. This rate is between 7- and 30-fold times higher than the error rate of the wild-type Klenow enzyme (Bebenek et al. 1990; Eger et al. 1991). Therefore, the high fidelity of the Klenow enzyme results more from highly accurate selection of bases by the polymerase domain than from postreplication editing by the exonuclease domain.

A large cleft in the polymerase domain is the binding site for the primer:template DNA (Beese et al. 1993a). The amino acid residues directly involved in substrate binding and catalysis have been identified by site-directed mutagenesis (Polesky et al. 1990, 1992) and confirmed by X-ray crystallographic analysis of the Klenow fragment bound to duplex DNA (Beese et al. 1993a). The polymerase domains of Pol I and several other type-B DNA polymerases, including those from *Thermus aquaticus* and bacteriophages T5 and T7, share a high degree of homology within the polymerase domain (Delarue et al. 1990; Blanco et al. 1991). This homology includes (1) a cluster of residues directly involved in catalysis and (2) a tyrosine residue involved in binding of dNTPs (Beese et al. 1993b). The current model of the orientation of the primer:template and the two domains of the Klenow fragment is shown in Figure 9-6.

## Uses of the Klenow Fragment of *E. coli* Polymerase I in Molecular Cloning

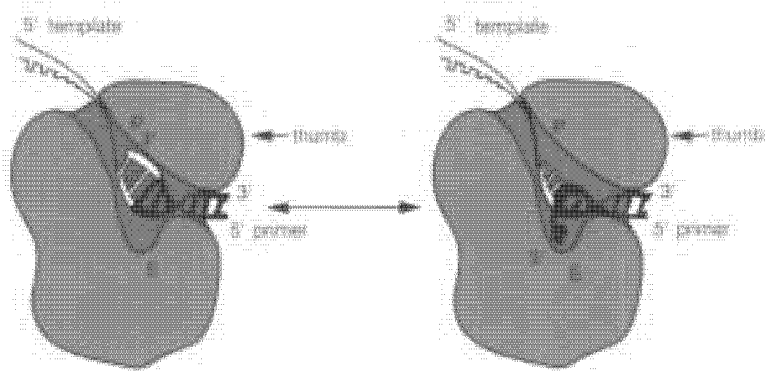
### **Filling the Recessed 3' Termini Created by Digestion of DNA with Restriction Enzymes**

In many cases, a single buffer can be used both for cleavage of DNA with a restriction enzyme and for the subsequent filling of recessed 3' termini. The end-filling reaction can be controlled by omitting one, two, or three of the four dNTPs from the reaction and thereby generating partially filled termini that contain novel cohesive ends (please see Figure 9-7 and Protocol 10).

### **Labeling the 3' Termini of DNA Fragments by Incorporation of Radiolabeled dNTPs**

In general, these labeling reactions contain three unlabeled dNTPs each at a concentration in excess of the  $K_m$  and one radiolabeled dNTP at a far lower concentration, which is usually below the  $K_m$ . Under these conditions, the proportion of label that is incorporated into DNA can be very high, even though the rate of the reaction may be far from maximal. The presence of high concentrations of three unlabeled dNTPs lessens the possibility of exonucleolytic removal of nucleotides from the 3' terminus of the template. Which of the four  $\alpha$ -labeled dNTPs is added to the reaction depends on the sequence and nature of the termini of the DNA.

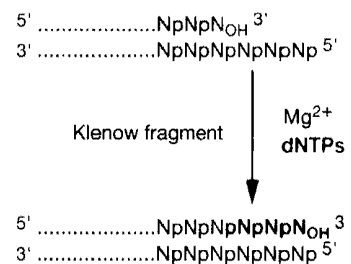
- **Recessed 3' termini** can be labeled with any dNTP whose base is complementary to an unpaired base in the protruding 5' terminus. Radioactivity can therefore be incorporated at any position within the rebuilt terminus depending on the investigator's choice of radiolabeled dNTP. To ensure that all of the radiolabeled molecules are the same length, it may be necessary to complete the end-filling reaction by carrying out a "chase" reaction containing high concentrations of all four unlabeled dNTPs.
- **Blunt-ended and protruding 3' termini** may be labeled in an enzymatic reaction that uses both domains of the Klenow fragment. First, the 3'→5' exonuclease activity removes any protruding tails from the DNA and creates a recessed 3' terminus. Then, in the presence of high concentrations of one radiola-



**FIGURE 9-6** A Model of DNA Bound to the Klenow DNA Polymerase

The model, which is based on the crystallographic structure of the complex between the Klenow fragment and duplex DNA (Beese et al. 1993a), shows a proposed arrangement of DNA bound at the active sites of the polymerase domain (P) and the exonuclease domain (E). The portion of the DNA observed in the crystal structure is indicated in solid black, and the portion that is modeled is shown in outline; 19–20 bp of DNA interact with the Klenow enzyme (Kolocheva et al. 1989). The template strand, which is bent at an angle of  $\sim 80^\circ$ , binds in the polymerase cleft and is base paired to the primer. The 3' end of the primer lies near the divalent metal ions that are believed to be important in the polymerase reaction (Polesky et al. 1992). The physical separation of the active sites for the polymerase and exonuclease domains by 30 Å creates problems of switching the primer 3' terminus from one site to another. The model shown in the figure does not really solve this problem but merely assumes that the growing nascent strand shuttles between the active sites of the exonuclease and polymerase domains. The dynamics of the pathway of the polymerase reaction have been elucidated in great detail: Rate constants have been measured for each of the individual steps in the pathway (Kuchta et al. 1988; Polesky et al. 1990, 1992; Dahlberg and Benkovic 1991). Current models suggest that the catalytic step — a nucleophilic attack on the  $\alpha$ -phosphate of the dNTP by the 3'-hydroxyl at the terminus of the primer — is the result of a conformational change in the enzyme caused by binding of DNA and dNTP (Dahlberg and Benkovic 1991). Following formation of the phosphodiester bond, the enzyme undergoes a second conformational change before release of pyrophosphate. The nature of these conformational changes is unknown, as is the mechanism by which translocation of the growing chain occurs at each reiteration of the polymerization step. (Adapted, with permission, from Beese et al. 1993a [Copyright 1993 American Association for the Advancement of Science].)

beled precursor, exonucleolytic degradation is balanced by incorporation of radiolabeled dNTP at the 3' terminus. This reaction, which consists of cycles of removal and replacement of the 3' terminus from recessed or blunt-ended DNA, is sometimes called an exchange or replacement reaction. The specific activities that can be achieved with this reaction are modest because the 3'→5' exonuclease of the Klenow enzyme is rather sluggish, especially on double-stranded substrates. T4 DNA polymerase carries a more potent 3'→5' exonuclease that is  $\sim 200$ -fold more active than the Klenow fragment and is the enzyme of choice for this type of reaction.



**FIGURE 9-7** Filling-in Recessed 3' Termini of DNA Fragments Using Klenow DNA Polymerase

The 3' termini generated by digestion with restriction endonucleases may be labeled using the Klenow fragment of DNA polymerase I in the presence of dNTPs and  $\text{Mg}^{2+}$ .



If a [ $^{35}\text{S}$ ]dNTP is used instead of the conventional [ $\alpha$ - $^{32}\text{P}$ ]dNTP, the reaction is limited to one cycle of removal and replacement since the 3'→5' exonuclease of *E. coli* DNA Pol I, unlike the exonuclease of T4 DNA polymerase, cannot attack thioester bonds (Kunkel et al. 1981; Gupta et al. 1984).

### **Labeling Single-stranded DNA by Random Priming**

For details, please see Feinberg and Vogelstein (1983, 1984) and Protocols 1 and 2.

### **Production of Single-stranded Probes by Primer Extension**

For details, please see Meinkoth and Wahl (1984), Studencki and Wallace (1984), and Chapter 7, Protocol 12. For many years, the Klenow fragment of Pol I was the highest-quality DNA polymerase that was commercially available and, in consequence, was the enzyme of first and last resort for in vitro synthesis of DNA. However, as polymerases that are better suited to various synthetic tasks have been discovered or engineered, Klenow has been gradually replaced and is no longer the enzyme of first choice for a variety of procedures in molecular cloning. These procedures include:

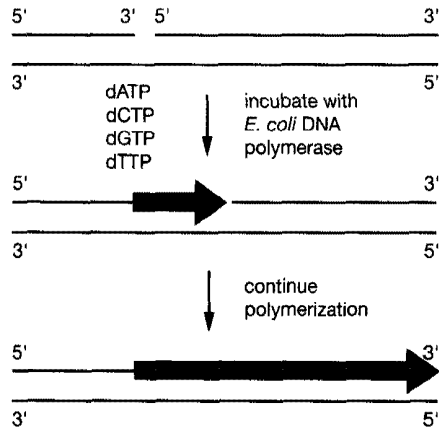
- **DNA sequencing by the Sanger method.** Klenow has been replaced by bacteriophage or thermostable polymerases that give longer read-lengths.
- **Synthesis of double-stranded DNA from single-stranded templates during in vitro mutagenesis.** Although the Klenow fragment is still widely used for in vitro synthesis of circular DNAs using mutagenic primers, it is not always the best enzyme for this purpose. Unless large quantities of ligase are present in the polymerization/extension reaction mixture, the Klenow enzyme can displace the mutagenic oligonucleotide primer from the template strand, thereby reducing the number of mutants obtained. This problem can be solved by using DNA polymerases that are unable to carry out strand displacement, including bacteriophage T4 DNA polymerase (Nossal 1974; Lechner et al. 1983; Geisselsoder et al. 1987), bacteriophage T7 DNA polymerase (Bebenek and Kunkel 1989), and Sequenase (Schna 1989). Bacteriophage T4 gene 32 protein (a single-stranded DNA-binding protein) can be used in primer-extension reactions catalyzed by DNA polymerases (including the Klenow enzyme) to alleviate stalling problems caused by templates rich in secondary structure (Craik et al. 1985; Kunkel et al. 1987).
- **Polymerase chain reactions.** The Klenow fragment was the enzyme used in the first polymerase chain reactions (Saiki et al. 1985). However, it has now been completely replaced by thermostable DNA polymerases that need not be replenished after each round of synthesis and denaturation.

### **Facts and Figures About the Klenow Fragment**

The standard assay used to measure the polymerase activity of the Klenow fragment is that of Setlow (1974) with poly(d[A-T]) as template. One unit of polymerizing activity is the amount of enzyme that catalyzes the incorporation of 3.3 nmoles of dNTP into acid-insoluble material in 10 minutes at 37°C. A sample of pure Klenow fragment has a specific activity of ~10,000 units/mg protein (Derbyshire et al. 1993). The reaction is usually carried out in the presence of  $\text{Mg}^{2+}$ . Substitution of  $\text{Mn}^{2+}$  for  $\text{Mg}^{2+}$  increases the rate of misincorporation and decreases the accuracy of proofreading (Carroll and Benkovic 1990). The  $K_m$  of the enzyme for the four dNTPs varies between 4 and 20  $\mu\text{M}$ . For methods to assay the exonuclease activity of the Klenow fragment, please see Freemont et al. (1986) and Derbyshire et al. (1988).

### **Uses of Pol I in Molecular Cloning**

- **Labeling of DNA by nick translation** (Maniatis et al. 1975; Rigby et al. 1977). In this reaction, the enzyme binds to a nick or short gap in duplex DNA. The 5'→3' exonuclease activity of Pol I then removes nucleotides from one strand of the DNA, creating a template for simultaneous synthesis of the growing strand of DNA. The original nick is therefore translated along the DNA molecule by the combined action of the 5'→3' exonuclease and the 5'→3' polymerase. In Figure 9-8, the nick in the upper strand of duplex DNA is translated from left to right and the patch of newly synthesized DNA is represented by the shaded arrow. Nick-translation reactions are usually carried out at 16°C to reduce the synthesis of "snap-

**FIGURE 9-8 Nick Translation Schematic**

*E. coli* DNA polymerase binds to the nick in duplex DNA, the exonuclease activity of Pol I then removes nucleotides from one strand of the DNA in a 5' → 3' direction from the nick, thereby creating a template for simultaneous synthesis of DNA by the polymerase function of Pol I. Please see the text of the information panel for additional details.

back" DNA, which is produced when the 3'-hydroxyl terminus of a growing strand of DNA loops back on itself and primes synthesis of hairpin-shaped molecules of DNA (Richardson et al. 1964a).

- **Replacement synthesis of second-strand cDNA** (e.g., please see Gubler and Hoffman 1983). In this method, the product of first-strand synthesis — a cDNA-mRNA hybrid — is used as a template for a nick-translation reaction. RNase H is used to generate nicks and gaps in the mRNA strand of the hybrid, creating a series of RNA primers that are used by Pol I to initiate the synthesis of second-strand cDNA.
- **End-labeling of DNA molecules with protruding 3' tails.** This reaction works in two stages: First, the 3'→5' exonuclease activity of the holoenzyme removes protruding 3' tails from the cDNA and creates a recessed 3' terminus. Then, in the presence of high concentrations of one radiolabeled precursor, continuing exonucleolytic degradation is balanced by incorporation of dNTPs at the 3' terminus. Although Pol I catalyzes this exchange or replacement reaction fairly efficiently, bacteriophage T4 DNA polymerase remains the enzyme of choice because of its more potent 3'→5' exonuclease activity.

### Facts and Figures About DNA Polymerase I

- **Most of the Pol I distributed by commercial manufacturers** is isolated (Kelley and Stump 1979) from a strain of *E. coli* that is lysogenic for a transducing bacteriophage  $\lambda$  carrying a copy of the *polA* gene (e.g., NM964; Murray and Kelley 1979).
- **One unit of DNA polymerase is the amount of enzyme** required to catalyze the conversion of 10 nmoles of total dNTPs to an acid-insoluble form in 30 minutes at 37°C using poly(d[A-T]) as the template primer (Richardson et al. 1964b). The specific activity of the commercial enzyme is usually ~5000 units/mg of protein.
- **Like all other DNA polymerases, Pol I requires divalent cations** for activity.  $Mg^{2+}$  is preferred for accurate replication, whereas  $Mn^{2+}$  may be used to increase the frequency of errors deliberately.

## IN VITRO TRANSCRIPTION SYSTEMS

Virtually all in vitro transcription of DNA into RNA is carried out with bacteriophage-encoded DNA-dependent RNA polymerases. The value of using bacteriophage-encoded DNA-dependent RNA polymerases arises because these enzymes (1) initiate efficient and selective transcription from well-defined cognate promoters (Melton et al. 1984) and (2) being composed of a single polypeptide chain (~900 amino acids), need no auxiliary transcription factors, perhaps because they have evolved to transcribe a small number of genes in a specialized genome with high efficiency.

The best-characterized bacteriophage RNA polymerases are those encoded by the *Salmonella typhimurium* bacteriophage, SP6 (Butler and Chamberlin 1982; Green et al. 1983), and the *E. coli* phages, T3 and T7 (Studier and Rosenberg 1981; Davanloo et al. 1984; Tabor and Richardson 1985). The genes encoding these three RNA polymerases have been isolated (Davanloo et al. 1984; Morris et al. 1986), sequenced (Moffatt et al. 1984; McGraw et al. 1985; Kotani et al. 1987), and expressed (Davanloo et al. 1984; Morris et al. 1986). In the case of the T7 polymerase, the crystal structure of the enzyme has been elucidated (Doublié et al. 1998). The SP6, T3, and T7 DNA-dependent RNA polymerases behave in a similar fashion, and there are no distinct biochemical advantages to using one RNA polymerase over the other. The SP6 enzyme is typically four to five times more expensive than the T7- and T3-encoded enzymes, even though it is the easiest of the three to prepare from bacteriophage-infected cells.

Although all three RNA polymerases have the ability to transcribe single-stranded DNA (Salvo et al. 1973; Milligan et al. 1987), virtually all in vitro transcription is carried out with double-stranded linear DNA templates that contain an appropriate promoter (please see Table 9-4).

Since the minimal promoter for bacteriophage RNA polymerases is just 21 bp in length (Jorgensen et al. 1991), portable bacteriophage promoters can easily be manufactured from synthetic oligonucleotides. Double-stranded DNA linkers containing a bacteriophage RNA polymerase promoter can also be ligated directly to purified DNA fragments (Loewy et al. 1989) or PCR products. By synthesizing the appropriate linker/adaptor, one fragment out of a mixture can be modified and subsequently transcribed in vitro.

Synthetic promoters can also be added to the 5' ends of primers used to amplify DNA by PCR (please see the panel on **ADDITIONAL PROTOCOL: USING PCR TO ADD PROMOTERS FOR BACTERIOPHAGE-ENCODED RNA POLYMERASES TO FRAGMENTS OF DNA** in Protocol 6). Essentially any DNA molecule can therefore be amplified with a bacteriophage promoter at one or both ends of the molecule. The amplified DNA is an efficient template for in vitro transcription reactions. PCR can also be used to introduce convenient restriction sites at the end of the DNA to facilitate linearization of templates and to introduce translation signals at the 5' end of a DNA fragment to allow the RNA product to be translated efficiently in cell-free protein-synthesizing systems (Browning 1989; Kain et al. 1991; please see Chapter 17).

The affinities of the bacteriophage polymerases for their promoters are rather low ( $\sim 10^{-7} M^{-1}$ ), and nucleoside triphosphates are required to stabilize transient promoter:enzyme complexes. After a short lag period, RNA synthesis rapidly reaches a rate (for T7 and T3 polymerases) of 200–300 nucleotides/second at 37°C, almost ten times faster than that of *E. coli* RNA polymerase, measured under the same conditions. The  $K_m$  values of the T3 and T7 RNA polymerases for ATP, UTP, and CTP are between 40 and 100  $\mu M$  (Oakley et

**TABLE 9-4 Promoter Sequences Recognized by Bacteriophage-encoded RNA Polymerases**

BACTERIOPHAGE	PROMOTER				
	-15	-10	-5	+1	+5
T7					
	TAATACGACTCACTATAGGGAGA				
T3	AATTAACCCTCACTAAAGGGAGA				
SP6	ATTTAGG	<sup>T</sup> <sub>G</sub>	GACACTATAGAAG		

The consensus sequences of promoters are recognized by three bacteriophage-encoded RNA polymerases: T7 (Dunn and Studier 1983), T3 (P.J. Beck et al. 1989), and SP6 (Brown et al. 1986). All of the bacteriophage promoters share a core sequence that extends from -7 to +1, suggesting that this region has a common role in promoter function. The promoters diverge in the region from -8 to -12, suggesting that promoter-specific contacts are made in this region. By convention, the sequence of the nontemplate strand is shown. (Adapted, with permission, from Jorgensen et al. 1991.)

al. 1979). GTP is anomalous, probably because it is used as a chain-initiating nucleotide: RNA chains initiated by T3 RNA polymerase, for example, start with pppGGGA and pppGGGG (for review, please see Chamberlin and Ryan 1982). When the concentration of template DNA is 20 nM and the concentration of each of the rNTPs is  $>50 \mu\text{M}$ , the rate of RNA synthesis is linear for at least 1 hour and is proportional to the amount of enzyme added to the reaction. During the course of the reaction, RNA chains are initiated many times on each molecule of template, and, under optimal conditions, between 10 and 20 moles of full-length transcript are generated per mole of template. However, when a radiolabeled or modified base is used as a precursor, the yield is much lower because reaction conditions are modified to optimize incorporation of the rare component. This is generally done by eliminating the homologous nucleotide from the reaction or by lowering its concentration drastically. However, if the concentration of nucleotide in the reaction drops below the  $K_m$  not only the total yield, but also the proportion of full-length RNA chains will drop markedly.

Although all three bacteriophage polymerases share many biochemical properties, each displays considerable preference for its own promoter and does not initiate transcription at other promoters at a substantial rate. The bacteriophage enzymes do not recognize bacterial or plasmid promoters or eukaryotic promoters in cloned DNA sequences. Because efficient signals for termination of RNA chains are also rare, bacteriophage-encoded polymerases are able to synthesize full-length transcripts of almost any DNA that is placed under the control of an appropriate promoter. Because these transcripts are complementary to only one strand of the template, they are excellent for use as probes in virtually any technique involving hybridization, including Southern and northern hybridization, in situ hybridization, and RNase protection assays. In addition, the ability to generate large quantities of long RNAs that are identical in sequence to unstable primary transcripts of mammalian genes has led to the development of in vitro assays for splicing and processing of 3' termini of eukaryotic mRNAs (e.g., please see Green 1991). Synthetic RNAs are also ligands for binding by regulatory proteins such as the *tat* gene product of the human immunodeficiency virus (Roy et al. 1990).

Full-length transcripts prepared in vitro are often used as mRNAs in eukaryotic cell-free protein synthesizing systems. These and other reactions (e.g., in vitro splicing reactions) work efficiently only if the template RNAs are capped at their 5' termini. The addition of a 5'-cap structure also greatly improves the stability of RNAs injected into oocytes (for references, please see Yisraeli and Melton 1989). Capped RNAs can be synthesized in vitro by lowering the concentration of GTP to  $50 \mu\text{M}$  and including a cap analog (such as G[5']ppp[5']G) at a tenfold molar excess in the reaction mixture (Contreras et al. 1982; Konarska et al. 1984). The great majority of transcripts synthesized under these conditions are initiated with a 5'-capped structure. However, once RNA synthesis has begun, the peculiar chemical structure of the cap analog (with two exposed 3'-hydroxyl residues) ensures that no further incorporation of the capping nucleotide can occur.

Finally, the high specificity of bacteriophage RNA polymerases has been exploited in the development of prokaryotic and eukaryotic expression systems. Here, a target cDNA or gene is cloned downstream from a bacteriophage promoter sequence and upstream of an appropriate transcription termination sequence. The resulting recombinant plasmid is then introduced into cells harboring a second plasmid that expresses the bacteriophage RNA polymerase in a regulated fashion. Induction of the polymerase gene results in the transcription of the target DNA on the first plasmid and subsequent abundant expression of its encoded product(s). In *E. coli*, the most widely used binary expression system employs the bacteriophage T7 RNA polymerase and promoter (Tabor and Richardson 1985; Studier and Moffatt 1986; Studier et al. 1990). In eukaryotic cells, the T7 RNA polymerase can be produced by infection with a recombinant vaccinia virus containing the T7 polymerase gene (Fuerst et al. 1986) or by transfection of an expression plasmid.

#### FACTS AND HINTS

To obtain milligram amounts of RNA from large-scale reactions, the concentration of  $\text{MgCl}_2$  in the reaction should be adjusted to 6 nM above the total concentration of nucleotides in the reaction (Milligan and Uhlenbeck 1989), and yeast inorganic pyrophosphatase should be included at a concentration of 5 units/ml (Cunningham and Ofengand 1990). The pyrophosphatase prevents sequestration of  $\text{Mg}^{2+}$  in the form of magnesium pyrophosphate.

Bacteriophage RNA polymerases will accept biotinylated nucleotides as precursors. However, compared to radiolabeled NTPs, incorporation is less efficient and the products of the reaction contain a higher proportion of truncated RNAs (Grabowski and Sharp 1986; Yisraeli and Melton 1989).

T7 RNA polymerase is strongly inhibited by T7 lysozyme (Moffatt and Studier 1987; Ikeda and Bailey 1992). Coexpression of the T7 lysozyme gene has been used as a method to reduce the activity of T7 polymerase in transformed bacteria (for review, please see Studier et al. 1990).

## ISOLATING DIFFERENTIALLY EXPRESSED cDNAs BY DIFFERENTIAL SCREENING AND CLONING

Estimates suggest that the human genome may encode 70,000–80,000 genes (Antequera and Bird 1993, 1994; Fields et al. 1994). Within a single type of cell, some genes are expressed at high levels and others at low levels. Measurements of the kinetics of reassociation of mRNA in the presence of a vast excess of genomic DNA (Melli et al. 1971; Hastie and Bishop 1976) show that ~20% of the mammalian mRNA population consists of abundant transcripts (1000–12,000 copies/cell). mRNAs of medium abundance (100–1000 copies/cell) account for a further 25% of the mRNA molecules, and the remaining 50% consist of a small number of copies ( $\leq 13$  copies/cell) of a large number (~30,000) of genes (Lewin 1975).

Particular types of mammalian cells express specific sets of genes, the majority of which belong to the medium- and low-abundance classes. For example, cultured human cells express 20,000–30,000 genes, over half of which are transcribed into low-abundance mRNAs (Bishop 1974; Bishop et al. 1974; Ryffel and McCarthy 1975). Mammalian brain cells may be exceptional in this regard in that they collectively appear to express almost the entire set of genes encoded by the genome (Bantle and Hahn 1976). In general, however, cells of the same lineage express similar sets of genes, whereas those from different lineages exhibit greater diversity in their expression patterns. For example, the organs of higher eukaryotes differ by expression of ~2000–4000 genes (Axel et al. 1976), whereas closely related cell types, such as B and T lymphocytes, differ by expression of only ~400 genes (Davis et al. 1982).

Differentially expressed genes include not only those that are transcribed in particular types of cells at specific stages of differentiation and development, but also those whose level of expression changes during the cell cycle or during tumorigenesis or as a consequence of pharmacological stimulation. Several methods, none of them easy, are available to isolate such genes, including random sampling and sequencing of cDNA clones, differential screening of cDNA libraries, construction and screening of subtracted cDNA libraries, and differential display (for reviews, please see Soares et al. 1994; Sagerström et al. 1997; Soares 1997; Hess et al. 1998).

### Random Sampling

Since the advent of high-throughput automated DNA sequencing, it has become possible to search for differentially expressed genes by sequencing large numbers of cDNA clones picked at random from each of two libraries (e.g., please see Frigerio et al. 1995). This type of large-scale, single-pass sequencing is also used to generate expressed sequence tags (ESTs), which contain enough information to identify a transcript (Adams et al. 1995; Hillier et al. 1996). Because most of the mRNAs in the highest-abundance class are the least likely to be differentially expressed, the chance of isolating differentially expressed gene by sequencing cDNAs at random is low. To avoid sequencing abundant transcripts time and time again, one or more rounds of differential screening can be used to remove clones that have been screened previously or that correspond to highly abundant mRNAs (e.g., please see Hoög 1991; Orr et al. 1994; Ji et al. 1997). Other methods to increase the probability of identifying cDNA clones corresponding to differentially expressed genes include the use of normalized or subtracted libraries (Spangrude et al. 1988; Patanjali et al. 1991; Soares et al. 1994; Bonaldo et al. 1996; Diatchenko et al. 1996), in which the imbalance in abundance between cDNAs is corrected to within one order of magnitude. However, the resulting increase in efficiency in screening comes at a price: mRNAs that display quantitative differences in expression are lost during the subtractive hybridization step required for construction of normalized or subtracted libraries. Consequently, cDNA clones corresponding only to mRNAs that are differentially expressed in an all-or-none fashion can be isolated.

### Differential Screening (also Referred to as Plus/Minus Screening)

In the simplest form of this technique (St. John and Davis 1979), a cDNA library is constructed from cells expressing the gene of interest. Duplicate copies of the library are screened separately with labeled cDNA probes synthesized from two preparations of mRNAs: One from a cell type or tissue that expresses the gene(s) of interest in high abundance and the other from a cell type or tissue with a lower abundance of the target mRNA(s). Recombinant clones that hybridize equally to both probes correspond to genes equivalently expressed in both cell types. These clones are not studied further. Recombinant clones that hybridize differentially to the two probes are isolated and analyzed by northern hybridization to determine whether they contain cDNAs derived from differentially expressed mRNAs.

In principle, this method of comparative screening can be used to identify any differentially regulated gene. However, because they are copied from the entire population of mRNAs, cDNA probes used in differential screening are of very high complexity, with each mRNA represented in proportion to its abundance. For the most part, mammalian mRNAs encoding proteins that regulate cellular behavior are expressed at low abundance and are therefore present at low concentration in the labeled probes. It is unlikely that such mRNAs will be detected by simple differential screening. As a rule of thumb, simple differential screening is successful only when the concentration of the target mRNAs in the two preparations differs by a factor of 5 or more, and when the abundance of the mRNA in one of the preparations exceeds 0.05% (for review, please see Sargent 1987).

The success of differential screening depends on the depth and quality of the cDNA library, the use of probes of high sequence complexity that are capable of detecting cDNAs corresponding to low-abundance mRNAs, and the ability to capture and quantify hybridization data efficiently. The efficiency of the technique is greatly improved if the cDNA libraries are organized into a format (e.g., wells of microtiter dishes) that is amenable to automation (e.g., please see Takahashi et al. 1995; Zhao et al. 1995; Schena et al. 1996; Perret et al. 1998). Although 100 or more differentially expressed genes have been identified using some form of plus-minus screening, the amount of labor involved in screening even a few thousand cDNA clones remains formidable. Until recently, efficient mining of differentially expressed genes from entire cDNA libraries was simply beyond reach.

Recently, however, differential screening has begun to bear spectacular and wonderful fruit. With the introduction of automated methods, more complex and more efficient forms of differential screening have been developed using densely arrayed libraries of cDNAs or synthetic oligonucleotides (for reviews, please see Ermolaeva et al. 1998; Khan et al. 1998; Bowtell 1999; Brown and Botstein 1999; Duggan et al. 1999; Rajeevan et al. 1999, and references therein). The arrays are probed with cDNAs that are prepared from two different sources and labeled with different chromophores. An image of the pattern of hybridization of the labeled cDNAs is then captured electronically and normalized by computer to compare the efficiency with which each of the probes hybridizes to each of the immobilized targets. Once differentially expressed genes have been identified, full-length cDNAs can be obtained from a repository.

Array technology is still some years away from routine use in conventional laboratories. To run efficiently, it requires high-speed robotic systems to print validated cDNAs in high-density arrays on to glass microscope slides, sophisticated readers to capture and manipulate images of the hybridization patterns, and access to state-of-the-art bioinformatics. However, the results already obtained give confidence that in the next few years, it will become possible to screen the entire complement of ~100,000 human genes and to map both physiological and pathological changes in the transcriptional landscape of cells and tissues (Schena et al. 1998). In the meantime, however, differential screening and subtractive screening and cloning (see below) remain viable, albeit laborious, options to detect temporal and topographic changes in gene expression.

## Subtractive Screening

Subtracted screening uses probes in which the concentration of cDNAs corresponding to highly redundant RNAs is reduced without significantly affecting the concentration of low-abundance sequences. In the simplest method, labeled cDNA generated from one population of mRNA (tester), which contains the sequences of interest, is hybridized to a driver that does not contain these sequences. The driver, which is used in molar excess in the hybridization reaction, is usually a preparation of mRNA from another, closely related source. The cDNA sequences complementary to mRNAs expressed in the driver population form DNA-RNA hybrids, whereas those that are unique to the tester population remain single-stranded. The hybrids are then removed by hydroxyapatite chromatography. Many more complex variations of this basic method have been described. For example:

- RNA labeled by photobiotinylation can be used as a driver, in which case the DNA-RNA hybrids can be removed by extraction with streptavidin-phenol (please see Table 9-5).
- Two cDNA libraries (from driver and tester mRNAs) are constructed by directional cloning in phagemid vectors. The libraries, which are arranged in opposite orientations, are used to generate complementary single-stranded cDNAs that can be used as driver and tester (Duguid et al. 1988; Rubenstein et al. 1990; Rothstein et al. 1993).

- Multiple rounds of subtraction can be carried out using PCR amplification of both the driver and the subtracted cDNAs (e.g., please see Hara et al. 1991, 1993; Wang and Brown 1991; Cecchini et al. 1993; López-Fernández and del Mazo 1993; Sharma et al. 1993; Lönneborg et al. 1995; Diatchenko et al. 1996; Jin et al. 1997; Konietzko and Kuhl 1998).

The decision between these methods turns on the amount of starting materials available and their complexity. The simplest method, where mRNA is used as the driver, may require as much as 20 µg of poly(A)<sup>+</sup> mRNA. It is frequently impossible to obtain sufficient mRNA to drive subtractive hybridization to completion. In other circumstances, because the amount of radioactivity in an absorbed probe complementary to any given cDNA is small, hybridization to a subtracted library may be inefficient, and satisfactory signals may be obtained only after prolonged exposure of autoradiographs. In either case, the probability of isolating a cDNA corresponding to a very rare mRNA is remote. If this amount is unavailable, a PCR-based scheme or a method involving hybridization of complementary cDNA libraries must be used.

The ultimate goal is to obtain a subtracted cDNA probe that can be used to screen a cDNA library constructed from mRNA extracted from the tester cell. A subtracted probe offers two potential benefits. First, because abundant sequences common to both cell types are removed, the proportion of radioactivity in the probe corresponding to rare mRNAs is increased, usually by a factor of ~10. Second, the removal of abundant sequences greatly reduces the chance that a rare clone of interest might be lost in the morass of cDNA clones that hybridize strongly to abundant sequences in the radiolabeled probe. This enhancement means that the cDNA library can be plated for screening at a higher density, with a commensurate reduction in the volume of hybridization solution and an increase in the concentration of the absorbed probe. The sensitivity of the probe is therefore increased, so that cDNA clones corresponding to rare mRNAs (0.005–0.01%) now fall within the range of detection (Wu et al. 1994). The increased level of sensitivity is sufficient to allow unambiguous discrimination between populations of mRNAs extracted, for example, from *Dictyostelium* at different stages of development (Timberlake 1980), from the gastrula and ovary of *Xenopus* (Sargent and Dawid 1983), from untransformed murine cells and murine cells transformed by SV40 (Scott et al. 1983), from myoblasts (Davis et al. 1987), from specialized populations of lymphocytes (Hedrick et al. 1984; Davis 1986 and references therein), from the neural plate of frog embryos (Klar et al. 1992), and from a cultured line of human neural tumor cells (el-Deiry et al. 1993).

**TABLE 9-5 Methods Commonly Used to Recover Single-stranded Nucleic Acids After Subtractive Hybridization with Driver**

METHOD	PROS AND CONS	REFERENCES
Chromatography on hydroxyapatite	efficient but messy	Please see Appendix 8 and the panel on <b>QUANTITATING RNA</b> in Chapter 7.
Biotinylation of driver	tricky to prepare drivers with the correct density of biotin residues <sup>1-4</sup> ; easy and efficient to separate biotinylated and nonbiotinylated molecules after hybridization by binding to immobilized streptavidin <sup>2,5,6</sup> or by extraction with streptavidin-phenol <sup>7-9</sup>	<sup>1</sup> Syvänen et al. (1986, 1988) <sup>2</sup> Wieland et al. (1990) <sup>3</sup> Swaroop et al. (1991) <sup>4</sup> Lebeau et al. (1991) <sup>5</sup> Syvänen et al. (1986, 1988) <sup>6</sup> López-Fernández and del Mazo (1993) <sup>7</sup> Sive and St. John (1988) <sup>8</sup> Duguid et al. (1988) <sup>9</sup> Rubenstein et al. (1990) <sup>10</sup> Rothstein et al. (1993)
Chromatography on oligo(dA) cellulose	efficient and simple	Batra et al. (1991); Wu et al. (1994)
Paramagnetic beads	simple but expensive	Rodriguez and Chader (1992); Sharma et al. (1993); Coche et al. (1994); Lönneborg et al. (1995); Aasheim et al. (1997); Coche (1997)

## ALKALINE PHOSPHATASE

Several types of alkaline phosphatases (or alkaline phosphomonoesterase) are commonly used in molecular cloning: bacterial alkaline phosphatase (BAP) and calf intestinal alkaline phosphatase (CIP, CIAP, or CAP). Similar enzymes isolated from more esoteric cold-blooded organisms (e.g., SAP from shrimp) have become available in recent years and have the advantage of being easier to inactivate than BAP or CIP at the end of dephosphorylation reactions. Alkaline phosphatases, which are all Zn(II) metalloenzymes, catalyze phosphate monoester hydrolysis through the formation of a phosphorylated serine intermediate. They are used for three purposes in molecular cloning:

- **To remove phosphate residues** from the 5' termini of nucleic acids before radiolabeling of the resulting 5'-hydroxyl group by transfer of  $^{32}\text{P}$  from  $\gamma$ -labeled ATP. This second reaction is catalyzed by bacteriophage T4 polynucleotide kinase (Chaconas and van de Sande 1980).
- **To remove 5'-phosphate residues** from fragments of DNA to prevent self-ligation. This dephosphorylation reaction is used chiefly to suppress self-ligation of vector molecules and therefore to decrease the number of "empty" clones that are obtained during cloning (Ullrich et al. 1977).
- **As reporter enzymes** in nonradioactive systems to detect and localize nucleic acids and proteins. In this case, the alkaline phosphatase is conjugated to a ligand such as streptavidin that specifically interacts with a biotinylated target molecule (Leary et al. 1983).

### Dephosphorylation Reactions

Alkaline phosphatases can remove 3'-phosphate groups from a variety of substrate molecules, including 3'-phosphorylated polynucleotides and deoxynucleoside 3'-monophosphates (Reid and Wilson 1971). However, the main use of BAP, CIP, and SAP in molecular cloning is to catalyze the removal of terminal 5'-phosphate residues from single- or double-stranded DNA and RNA. The resulting 5'-hydroxyl termini can no longer take part in ligation reactions but are substrates in radiolabeling reactions catalyzed by polynucleotide kinase (Chaconas and van de Sande 1980).

Although the usefulness of alkaline phosphatases in 5' labeling of nucleic acids is undisputed, their value in preventing self-ligation is more debatable. There is no doubt that dephosphorylation reduces recircularization of linear plasmid DNA and therefore diminishes the background of transformed bacterial colonies that carry "empty" plasmids (Ullrich et al. 1977; Ish-Horowitz and Burke 1981; Evans et al. 1992). All too frequently, however, there is a parallel decline in the number of colonies that carry the desired recombinant. In addition, some investigators believe that the presence of 5'-hydroxyl groups may lead to an increase in the frequency of rearranged or deleted clones. For these reasons, directional cloning is the preferred method whenever the appropriate restriction sites are available.

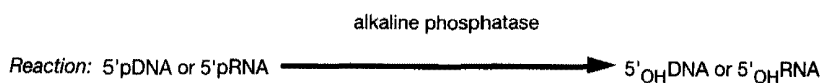
### Properties of Alkaline Phosphatases

Alkaline phosphatases used in molecular cloning display maximal activity in alkaline Tris buffers (pH 8.0 to pH 9.0) in the presence of low concentrations of  $\text{Zn}^{2+}$  (<1 mM).

- BAP is secreted in monomeric form ( $M_r = 47,000$ ) into the periplasmic space of *E. coli*, where it dimerizes and becomes catalytically active (Bradshaw et al. 1981). At neutral or alkaline pH, dimeric BAP contains up to six  $\text{Zn}^{2+}$  ions, two of which are essential for enzymatic activity (for review, please see Coleman and Gettins 1983). Only one of the two catalytic sites per dimer is active at low concentrations of artificial substrates, whereas both become active at higher concentrations (Heppel et al. 1962; Fife 1967). BAP

Activity: Phosphatase

Substrate: Single- or double-stranded DNA and RNA; rNTPs and dNTPs



**FIGURE 9-9** Dephosphorylation Activity of Alkaline Phosphatases



is a remarkably stable enzyme and is resistant to inactivation by heat and detergents. For this reason, BAP is difficult to remove at the end of dephosphorylation reactions.

- CIP is a dimeric glycoprotein, composed of two 514-residue monomers, that is bound to the plasma membrane by a phosphatidylinositol anchor (Hoffmann-Blume et al. 1991; Weissig et al. 1993) and whose optimal enzymatic activity depends on the concentrations of  $Mg^{2+}$  and  $Zn^{2+}$ . Some  $Zn^{2+}$ , bound at a catalytic site, is required for catalytic activity.  $Mg^{2+}$ , which binds at a different site, is an allosteric activator. However,  $Zn^{2+}$ , if present in high concentrations, will compete for the  $Mg^{2+}$  binding site and prevent the allosteric activation (Fernley 1971). CIP can be readily digested with proteinase K and/or inactivated by heating (to 65°C for 30 minutes or 75°C for 10–15 minutes) in the presence of 10 mM EGTA. The dephosphorylated DNA can then be purified by extraction with phenol:chloroform.
- SAP is isolated from arctic shrimp and its enzymatic properties are similar to those of CIP. Unlike BAP, SAP is unstable at elevated temperatures and, according to the manufacturers, can be completely inactivated by heating to 65°C for 15 minutes. However, molecular biology chat sites on the web frequently contain comments from customers who suggest that the enzyme may not be completely inactivated by brief heating. To be fair, about an equal number report that they have no problems in inactivating SAP. However, to be on the safe side, we recommend heating to 70°C for 20 minutes to ensure complete inactivation of SAP.

Alkaline phosphatases as a group are inhibited by inorganic orthophosphate (Zittle and Della Monica 1950), by chelators of metal ions such as EDTA and EGTA, but not to a significant extent by diisopropyl-fluorophosphate, a powerful inhibitor of other serine hydrolases (Dabich and Neuhaus 1966). L-phenylalanine is a noncompetitive inhibitor of CIP (Weissig et al. 1993).

## REFERENCES

- Aasheim H.C., Logtenberg T., and Larsen F. 1997. Subtractive hybridization for the isolation of differentially expressed genes using magnetic beads. *Methods Mol. Biol.* **69**: 115–128.
- Adams M.D., Kerlavage A.R., Fleischmann R.D., Fuldner R.A., Bult C.J., Lee N.H., Kirkness E.F., Weinstock K.G., Gocayne J.D., White O., et al. 1995. Initial assessment of human gene diversity and expression patterns based upon 83 million nucleotides of cDNA sequence. *Nature* (suppl. 6547) **377**: 3–174.
- Agrawal S., Christodoulou C., and Gait M.J. 1986. Efficient methods for attaching non-radioactive labels to the 5' ends of synthetic oligodeoxyribonucleotides. *Nucleic Acids Res.* **14**: 6227–6245.
- Angerer L.M., Cox K.H., and Angerer R.C. 1987. Demonstration of tissue-specific gene expression by in situ hybridization. *Methods Enzymol.* **152**: 649–661.
- Ansorge W., Sproat B., Stegemann J., Schwager C., and Zenke M. 1987. Automated DNA sequencing: Ultrasensitive detection of fluorescent bands during electrophoresis. *Nucleic Acids Res.* **15**: 4593–4602.
- Antequera F. and Bird A. 1993. Number of CpG islands and genes in human and mouse. *Proc. Natl. Acad. Sci.* **90**: 11995–11999.
- Antequera F. and Bird A. 1994. Predicting the total number of human genes (comment). *Nat. Genet.* **8**: 114.
- Axel R., Feigelson P., and Schutz G. 1976. Analysis of the complexity and diversity of mRNA from chicken liver and oviduct. *Cell* **7**: 247–254.
- Bales K.R., Hannon K., Smith II, C.K., and Santerre R.F. 1993. Single-stranded RNA probes generated from PCR-derived DNA templates. *Mol. Cell. Probes* **7**: 269–275.
- Bantle J.A. and Hahn W.E. 1976. Complexity and characterization of polyadenylated RNA in the mouse brain. *Cell* **8**: 139–50.
- Batra S.K., Metzgar R.S., and Hollingsworth M.A. 1991. A simple, effective method for the construction of subtracted cDNA libraries. *Genet. Anal. Tech. Appl.* **8**: 129–133.
- Bebenek K. and Kunkel T.A. 1989. The use of native T7 DNA polymerase for site-directed mutagenesis. *Nucleic Acids Res.* **17**: 5408.
- Bebenek K., Joyce C.M., Fitzgerald M.P., and Kunkel T.A. 1990. The fidelity of DNA synthesis catalyzed by derivatives of *Escherichia coli* DNA polymerase I. *J. Biol. Chem.* **265**: 13878–13887.
- Beck P.J., Gonzalez S., Ward C.L., and Molineux I.J. 1989. Sequence of bacteriophage T3 DNA from gene 2.5 through gene 9. *J. Mol. Biol.* **210**: 687–701.
- Beck S. and Köster H. 1990. Applications of dioxetane chemiluminescent probes to molecular biology (erratum *Anal. Chem.* [1991] **63**: 848). *Anal. Chem.* **62**: 2258–2270.
- Beck S., O'Keeffe T., Coull J.M., and Koster H. 1989. Chemiluminescent detection of DNA: Application for DNA sequencing and hybridization. *Nucleic Acids Res.* **17**: 5115–5123.
- Beese L.S. and Steitz T.A. 1991. Structural basis for the 3'-5' exonuclease activity of *Escherichia coli* DNA polymerase I: A two metal ion mechanism. *EMBO J.* **10**: 25–33.
- Beese L.S., Derbyshire V.C., and Steitz T.A. 1993a. Structure of DNA polymerase I Klenow fragment bound to duplex DNA. *Science* **260**: 352–355.
- Beese L.S., Friedman J.M., and Steitz T.A. 1993b. Crystal structures of the Klenow fragment of DNA polymerase I complexed with deoxynucleoside triphosphate and pyrophosphate. *Biochemistry* **32**: 14095–14101.
- Benzinger E.A., Riech A.K., Shirley R.E., and Kucharik K.R. 1995. Evaluation of the specificity of alkaline phosphatase-conjugated oligonucleotide probes for forensic DNA analysis. *Appl. Theor. Electrophor.* **4**: 161–165.
- Berkner K.L. and Folk W.R. 1977. Polynucleotide kinase exchange reaction: Quantitative assay for restriction endonuclease-generated 5'-phosphoryl termini in DNA. *J. Biol. Chem.* **252**: 3176–3184.
- Bishop J.O. 1974. The gene numbers game. *Cell* **2**: 81–86.
- Bishop J.O., Morton J.G., Rosbash M., and Richardson M. 1974. Three abundance classes in HeLa cell messenger RNA. *Nature* **250**: 199–204.
- Blanco L., Bernad A., Blasco M.A., and Salas M. 1991. A general structure for DNA-dependent DNA polymerases (erratum *Gene* [1991] **108**: 165). *Gene* **100**: 27–38.
- Bonaldo M.F., Lennon G., and Soares M.B. 1996. Normalization and subtraction: Two approaches to facilitate gene discovery. *Genome Res.* **6**: 791–806.
- Bortner C. and Griffith J. 1993. Labeling specific ends of DNA with biotin, biotin-streptavidin or radioactive nucleotides. *Comments* (U.S. Biochemical Corp.) **20**: 1–5.
- Bowtell D.D. 1999. Options available – from start to finish – for obtaining expression data by microarray. *Nat. Genet.* **21**: 25–32.
- Bradshaw R.A., Cancedda F., Ericsson L.H., Neumann P.A., Piccoli S.P., Schlesinger M.J., Shriefer K., and Walsh K.A. 1981. Amino acid sequence of *Escherichia coli* alkaline phosphatase. *Proc. Natl. Acad. Sci.* **78**: 3473–3477.
- Bronstein I. 1990. Chemiluminescent 1,2-dioxetane-based enzyme substrates and their applications. In *Luminescence immunoassays and molecular applications* (ed. K. Van Dyke and R. Van Dyke), pp. 255–274. CRC Press, Boca Raton, Florida.
- Bronstein I., Edwards B., and Voyta J.C. 1989a. 1,2-dioxetanes: Novel chemiluminescent enzyme substrates. Applications to immunoassays. *J. Biolumin. Chemilumin.* **4**: 99–111.
- Bronstein I., Voyta J.C., and Edwards B. 1989b. A comparison of chemiluminescent and colorimetric substrates in a hepatitis B virus DNA hybridization assay. *Anal. Biochem.* **180**: 95–98.
- Bronstein I., Joa R.R., Voyta J.C., and Edwards B. 1991. Novel chemiluminescent adamantyl 1,2-dioxetane enzyme substrates. In *Proceedings of the 6th International Symposium on Bioluminescence and Chemiluminescence: Current status* (ed. P.E. Stanley and L.J. Kricka), pp. 73–82. Wiley, Chichester, United Kingdom.
- Bronstein I., Cate R.L., Lazzarri K., Ramachandran K.L., and Voyta J.C. 1989c. Chemiluminescent 1,2-dioxetane based enzyme substrates and their application in the detection of DNA. *Photochem. Photobiol.* **49**: S9–S10.
- Brown J.E., Klement J.F., and McAllister W.T. 1986. Sequences of three promoters for the bacteriophage SP6 RNA polymerase. *Nucleic Acids Res.* **14**: 3521–3526.
- Brown P.O. and Botstein D. 1999. Exploring the new world of the genome with DNA microarrays. *Nat. Genet.* **21**: 33–37.
- Browning K.S. 1989. Transcription and translation of mRNA from polymerase chain reaction-generated DNA. *Amplifications* **3**: 15–16.
- Brutlag D., Atkinson M.R., Setlow P., and Kornberg A. 1969. An active fragment of DNA polymerase produced by proteolytic cleavage. *Biochem. Biophys. Res. Commun.* **37**: 982–989.

- Butler E.T. and Chamberlin M.J. 1982. Bacteriophage SP6-specific RNA polymerase. I. Isolation and characterization of the enzyme. *J. Biol. Chem.* **257**: 5772-5778.
- Cameron V., Soltis D., and Uhlenbeck O.C. 1978. Polynucleotide kinase from a T4 mutant which lacks the 3' phosphatase activity. *Nucleic Acids Res.* **5**: 825-833.
- Carroll S.S. and Benkovic S.J. 1990. Mechanistic aspects of DNA-polymerases: *Escherichia coli* DNA polymerase I (Klenow fragment) as a paradigm. *Chem. Rev.* **90**: 1291-1307.
- Casey J. and Davidson N. 1977. Rates of formation and thermal stabilities of RNA:DNA and DNA:DNA duplexes at high concentrations of formamide. *Nucleic Acids Res.* **4**: 1539-1552.
- Catalano C.E., Allen D.J., and Benkovic S.J. 1990. Interaction of *Escherichia coli* DNA polymerase I with azido DNA and fluorescent DNA probes: Identification of protein-DNA. *Biochemistry* **29**: 3612-3621.
- Cecchini E., Dominy P.J., Geri C., Kaiser K., Sentry J., and Milner J.J. 1993. Identification of genes up-regulated in dedifferentiating *Nicotiana glauca* pith tissue, using an improved method for constructing a subtractive cDNA library. *Nucleic Acids Res.* **21**: 5742-5747.
- Chaconas G. and van de Sande J.H. 1980. 5'-32P labeling of RNA and DNA restriction fragments. *Methods Enzymol.* **65**: 75-85.
- Chamberlin M. and Ryan T. 1982. Bacteriophage DNA-dependent RNA polymerases. In *The enzymes*, 3rd edition (ed. P.D. Boyer), vol. 15, pp. 87-108. Academic Press, New York.
- Chan V.T., Fleming K.A., and McGee J.O. 1985. Detection of subpicogram quantities of specific DNA sequences on blot hybridization with biotinylated probes. *Nucleic Acids Res.* **13**: 8083-8091.
- Chu B.C. and Orgel L.E. 1985. Detection of specific DNA sequences with short biotin-labeled probes. *DNA* **4**: 327-331.
- Church G.M. and Gilbert W. 1984. Genomic sequencing. *Proc. Natl. Acad. Sci.* **81**: 1991-1995.
- Cobianchi F. and Wilson S.H. 1987. Enzymes for modifying and labeling DNA and RNA. *Methods Enzymol.* **152**: 94-110.
- Coche T.G. 1997. Subtractive cDNA cloning using magnetic beads and PCR. *Methods Mol. Biol.* **67**: 371-387.
- Coche T., Dewez M., and Beckers M.C. 1994. Generation of an unlimited supply of a subtracted probe using magnetic beads and PCR. *Nucleic Acids Res.* **22**: 1322-1323.
- Coleman J.E. and Gettins P. 1983. Alkaline phosphatase, solution structure, and mechanism. *Adv. Enzymol. Relat. Areas Mol. Biol.* **55**: 381-452.
- Contreras R., Cheroutre H., Degrave W., and Fiers W. 1982. Simple, efficient in vitro synthesis of capped RNA useful for direct expression of cloned eukaryotic genes. *Nucleic Acids Res.* **10**: 6353-6362.
- Cowart M., Gibson K.J., Allen D.J., and Benkovic S.J. 1989. DNA substrate structural requirements for the exonuclease and polymerase activities of procaryotic and phage DNA polymerases. *Biochemistry* **28**: 1975-1983.
- Cox K.H., DeLeon D.V., Angerer L.M., and Angerer R.C. 1984. Detection of mRNAs in sea urchin embryos by in situ hybridization using asymmetric RNA probes. *Dev. Biol.* **101**: 485-502.
- Craik C.S., Largman C., Fletcher T., Rocznik S., Barr P.J., Fletterick R., and Rutter W.J. 1985. Redesigning trypsin: Alteration of substrate specificity. *Science* **228**: 291-297.
- Cunningham K.G., Hutchinson S.A., Manson W., and Spring F.S. 1951. Cordycepin, a metabolic product from cultures of *Cordyceps militaris* (Linn.) Link. I. Isolation and characterization. *J. Chem. Soc.* **1951**: 2299-2300.
- Cunningham P.R. and Ofengand J. 1990. Use of inorganic pyrophosphatase to improve the yield of in vitro transcription reactions catalyzed by T7 RNA polymerase. *BioTechniques* **9**: 713-714.
- Dabich, D. and O.W. Neuhaus. 1966. Purification and properties of bovine synovial fluid alkaline phosphatase. *J. Biol. Chem.* **241**: 415-420.
- Dahlberg M.E. and Benkovic S.J. 1991. Kinetic mechanism of DNA polymerase I (Klenow fragment): Identification of a second conformational change and evaluation of the internal equilibrium constant. *Biochemistry* **30**: 4835-4843.
- Dahlen P., Liukkonen L., Kwiatkowski M., Hurskainen P., Iitia A., Siitari H., Ylikoski J., Mukkala V.M., and Lovgren T. 1994. Europium-labeled oligonucleotide hybridization probes: Preparation and properties. *Bioconjug. Chem.* **5**: 268-272.
- Davanloo P., Rosenberg A.H., Dunn J.J., and Studier F.W. 1984. Cloning and expression of the gene for bacteriophage T7 RNA polymerase. *Proc. Natl. Acad. Sci.* **81**: 2035-2039.
- Davidson E.H. 1986. *Gene activity in early development*, 3rd edition, pp. 538-540. Academic Press, New York.
- Davis M.M. 1986. Subtractive cDNA hybridization and the T-cell receptor genes. In *Handbook of experimental immunology* (ed. D.M. Weir et al.), vol. 2, pp. 76.1-76.13. Blackwell Scientific, Oxford, United Kingdom.
- Davis M.M., Cohen D.I., Nielsen E.A., DeFranco A.L., and Paul W.E. 1982. The isolation of B and T cell specific genes. *UCLA Symp. Mol. Cell. Biol.* **24**: 215-220.
- Davis R.L., Weintraub H., and Lassar A.B. 1987. Expression of a single transfected cDNA converts fibroblasts to myoblasts. *Cell* **51**: 987-1000.
- Delarue M., Poch O., Tordo N., Moras D. and Argos P. 1990. An attempt to unify the structure of polymerases. *Protein Eng.* **3**: 461-467.
- De Lucia P. and Cairns J. 1969. Isolation of an *E. coli* strain with a mutation affecting DNA polymerase. *Nature* **224**: 1164-1166.
- Deng G. and Wu R. 1983. Terminal transferase: Use of the tailing of DNA and for in vitro mutagenesis. *Methods Enzymol.* **100**: 96-116.
- Denhardt D.T. 1966. A membrane-filter technique for the detection of complementary DNA. *Biochem. Biophys. Res. Commun.* **23**: 641-646.
- Depew R.E. and Cozzarelli N.R. 1974. Genetics and physiology of bacteriophage T4 3'-phosphatase: Evidence for involvement of the enzyme in T4 DNA metabolism. *J. Virol.* **13**: 888-897.
- Derbyshire V., Astatke M., and Joyce C.M. 1993. Re-engineering the polymerase domain of Klenow fragment and evaluation of overproduction and purification strategies. *Nucleic Acids Res.* **23**: 5439-5448.
- Derbyshire V., Grindley N.D.F., and Joyce C.M. 1991. The 3'-5' exonuclease of DNA polymerase I of *Escherichia coli*: Contribution of each amino acid at the active site to the reaction. *EMBO J.* **10**: 17-24.
- Derbyshire V., Freemont P.S., Sanderson M.R., Beese L., Friedman J.M., Joyce C.M., and Steitz T.A. 1988. Genetic and crystallographic studies of the 3',5'-exonucleolytic site of DNA polymerase I. *Science* **240**: 199-201.
- Diamandis E.P., Hassapoglidou S., and Bean C.C. 1993. Evaluation of nonisotopic labeling and detection techniques for nucleic acid hybridization. *J. Clin. Lab. Anal.* **7**: 174-179.
- Diatchenko L., Lau Y.F., Campbell A.P., Chenchik A., Moqadam F., Huang B., Lukyanov S., Lukyanov K., Gurskaya N.,

- Sverdlov E.D., and Siebert P.D. 1996. Suppression subtractive hybridization: A method for generating differentially regulated or tissue-specific cDNA probes and libraries. *Proc. Natl. Acad. Sci.* **93**: 6025–6030.
- Dimo-Simonin N., Brandt-Casadevall C., and Gujer H.R. 1992. Chemiluminescent DNA probes; evaluation and usefulness in forensic cases. *Forensic Sci. Int.* **57**: 119–127.
- Double S., Tabor S., Long A.M., Richardson C.C., and Ellenberger T. 1998. Crystal structure of a bacteriophage T7 DNA replication complex at 2.2 Å resolution. *Nature* **391**: 251–258.
- Dubitsky A., Brown J., and Brandwein H. 1992. Chemiluminescent detection of DNA on nylon membranes. *BioTechniques* **13**: 392–400.
- Duggan D.J., Bittner M., Chen Y., Meltzer P., and Trent J.M. 1999. Expression profiling using cDNA microarrays. *Nat. Genet.* **21**: 10–14.
- Duguid J.R., Rohwer R.G., and Seed B. 1988. Isolation of cDNAs of scrapie-modulated RNAs by subtractive hybridization of a cDNA library. *Proc. Natl. Acad. Sci.* **85**: 5738–5742.
- Dunn J.J. and Studier F.W. 1983. Complete nucleotide sequence of bacteriophage T7 DNA and the locations of T7 genetic elements. *J. Mol. Biol.* **166**: 477–535.
- Düring K. 1993. Non-radioactive detection methods for nucleic acids separated by electrophoresis. *J. Chromatogr.* **618**: 105–131.
- Durrant I., Bengel L.C., Sturrock C., Devenish A.T., Howe R., Roe S., Moore M., Scozzafava G., Proudfoot L.M., Richardson T.C., et al. 1990. The application of enhanced chemiluminescence to membrane-based nucleic acid detection. *BioTechniques* **8**: 564–570.
- Eckert R.L. 1987. New vectors for rapid sequencing of DNA fragments by chemical degradation. *Gene* **51**: 247–254.
- Edwards B., Sparks A., Voyta J.C., and Bronstein I. 1994. New chemiluminescent dioxetane enzyme substrates. In *Proceedings of the 8th International Symposium on Bioluminescence and Chemiluminescence: Fundamentals and applied aspects* (ed. A.K. Campbell et al.), pp. 56–59. Wiley, Chichester, United Kingdom.
- Eger B.T., Kuchta R.D., Carroll S.S., Benkovic P.A., Dahlberg M.E., Joyce C.M., and Benkovic S.J. 1991. Mechanism of DNA replication fidelity for three mutants of DNA polymerase I: Klenow fragment KF(exo+), KF(polA5) and KF(exo-). *Biochemistry* **30**: 1441–1448.
- el-Deiry W.S., Tokino T., Velculescu V.E., Levy D.B., Parsons R., Trent J.M., Lin D., Mercer W.E., Kinzler K.W., and Vogelstein B. 1993. WAF1, a potential mediator of p53 tumor suppression. *Cell* **75**: 817–825.
- England T.E., Gumpert R.L., and Uhlenbeck O.C. 1977. Dinucleoside pyrophosphate are substrates for T4-induced RNA ligase. *Proc. Natl. Acad. Sci.* **74**: 4839–4842.
- Ermolaeva O., Rastogi M., Pruitt K.D., Schuler G.D., Bittner M.L., Chen Y., Simon R., Meltzer P., Trent J.M., and Boguski M.S. 1998. Data management and analysis for gene expression arrays. *Nat. Genet.* **20**: 19–23.
- Evans G.A., Snider K., and Hermanson G.G. 1992. Use of cosmids and arrayed clone libraries for genome analysis. *Methods Enzymol.* **216**: 530–548.
- Fargnoli J., Holbrook N.J., and Fornace Jr., A.J. 1990. Low-ratio hybridization subtraction. *Anal. Biochem.* **187**: 364–373.
- Farmar J.G. and Castaneda M. 1991. An improved preparation and purification of oligonucleotide-alkaline phosphatase conjugates. *BioTechniques* **11**: 588–589.
- Feinberg A.P. and Vogelstein B. 1983. A technique for radiolabeling DNA restriction endonuclease fragments to high specific activity. *Anal. Biochem.* **132**: 6–13.
- . 1984. A technique for radiolabeling DNA restriction endonuclease fragments to high specific activity. Addendum. *Anal. Biochem.* **137**: 266–267.
- Fernley H.N. 1971. Mammalian alkaline phosphatases. In *The enzymes*, 3rd edition (ed. P.D. Boyer), vol. 4, pp. 417–447. Academic Press, New York.
- Fields C., Adams M.D., White O., and Venter J.C. 1994. How many genes in the human genome? *Nat. Genet.* **7**: 345–346.
- Fife W.K. 1967. Phosphorylation of alkaline phosphatase (*E. coli*) with o- and p-nitrophenyl phosphate at pH below 6. *Biochem. Biophys. Res. Commun.* **28**: 309–317.
- Finckh U., Lingenfelter P.A., and Myerson D. 1991. Producing single-stranded DNA probes with the Taq DNA polymerase: A high yield protocol (erratum *BioTechniques* [1992] **12**: 382). *BioTechniques* **10**: 35–39.
- Forster A.C., McInnes J.L., Skingle D.C., and Symons R.H. 1985. Non-radioactive hybridization probes prepared by the chemical labelling of DNA and RNA with a novel reagent, photobiotin. *Nucleic Acids Res.* **13**: 745–761.
- Freemont P.S., Ollis D.L., Steitz T.A., and Joyce C.M. 1986. A domain of the Klenow fragment of *Escherichia coli* DNA polymerase I has polymerase but no exonuclease activity. *Proteins* **1**: 66–73.
- Freemont P.S., Friedman J.M., Beese L.S., Sanderson M.R., and Steitz T.A. 1988. Cocrystal structure of an editing complex of Klenow fragment with DNA. *Proc. Natl. Acad. Sci.* **85**: 8924–8928.
- Frigerio J.M., Berthéze P., Garrido P., Ortiz E., Barthelémy S., Vasseur S., Sastre B., Seleznieff I., Dagorn J.C., and Iovanna J.L. 1995. Analysis of 2166 clones from a human colorectal cancer cDNA library by partial sequencing. *Hum. Mol. Genet.* **4**: 37–43.
- Fuerst T.R., Niles E.G., Studier F.W., and Moss B. 1986. Eukaryotic transient-expression system based on recombinant vaccinia virus that synthesizes bacteriophage T7 RNA polymerase. *Proc. Natl. Acad. Sci.* **83**: 8122–8126.
- Gaillard C. and Strauss E. 1990. Ethanol precipitation of DNA with linear polyacrylamide as carrier. *Nucleic Acids Res.* **18**: 378.
- Gebeyehu G., Rao P.Y., SooChan P., Simms D.A., and Klevan L. 1987. Novel biotinylated nucleotide — Analogs for labeling and colorimetric detection of DNA. *Nucleic Acids Res.* **15**: 4513–4534.
- Geisselsoder J., Witney E., and Yuckenberg P. 1987. Efficient site-directed *in vitro* mutagenesis. *BioTechniques* **5**: 786–791.
- Gerard G.F. and D'Alessio J.M. 1993. Reverse transcriptase (EC2.7.7.49): The use of cloned Moloney murine leukemia virus reverse transcriptase to synthesize DNA from RNA. In *Enzymes of molecular biology* (ed. M.M. Burrell), pp. 73–94. Humana Press, Totowa, New Jersey.
- Gillespie D. and Spiegelman S. 1965. A quantitative assay for DNA-RNA hybrids with DNA immobilized on a membrane. *J. Mol. Biol.* **12**: 829–842.
- Goulian M. 1969. Initiation of the replication of single-stranded DNA by *Escherichia coli* DNA polymerase. *Cold Spring Harbor Symp. Quant. Biol.* **33**: 11–20.
- Goulian M., Lucas Z.J., and Kornberg A. 1968. Enzymatic synthesis of deoxyribonucleic acid. XXV. Purification and properties of deoxyribonucleic acid polymerase induced by infection with phage T4. *J. Biol. Chem.* **243**: 627–638.

- Grabowski P.J. and Sharp P.A. 1986. Affinity chromatography of splicing complexes: U2, U5, and U4 + U6 small nuclear ribonucleoprotein particles in the spliceosome. *Science* **233**: 1294-1299.
- Green M.R. 1991. Biochemical mechanisms of constitutive and regulated pre-mRNA splicing. *Annu. Rev. Cell Biol.* **7**: 559-599.
- Green M.R., Maniatis T., and Melton D.A. 1983. Human  $\beta$ -globin pre-mRNA synthesized in vitro is accurately spliced in *Xenopus* oocyte nuclei. *Cell* **32**: 681-94.
- Gubler U. and Hoffman B.J. 1983. A simple and very efficient method for generating cDNA libraries. *Gene* **25**: 263-269.
- Guesdon J.L. 1992. Immunoenzymatic techniques applied to the specific detection of nucleic acids. A review. *J. Immunol. Methods* **150**: 33-49.
- Guest C.R., Hochstrasser R.A., Dupuy C.G., Allen D.J., Benkovic S.J., and Millar D.P. 1991. Interaction of DNA with the Klenow fragment of DNA polymerase I studied by time-resolved fluorescence spectroscopy. *Biochemistry* **30**: 8759-8770.
- Gupta A.P., Benkovic P.A., and Benkovic S.J. 1984. The effect of the 3',5' thiophosphoryl linkage on the exonuclease activities of T4 polymerase and the Klenow fragment. *Nucleic Acids Res.* **12**: 5897-911.
- Gyllensten U.B. and Erlich H.A. 1988. Generation of single-stranded DNA by the polymerase chain reaction and its application to direct sequencing of the HLA-DQA locus. *Proc. Natl. Acad. Sci.* **85**: 7652-7656.
- Habili N., McInnes J.L., and Symons R.H. 1987. Nonradioactive, photobiotin-labelled DNA probes for the routine diagnosis of barley yellow dwarf virus. *J. Virol. Methods* **16**: 225-237.
- Han H., Rifkind J.M., and Mildvan A.S. 1991. Role of divalent cations in the 3',5'-exonuclease reaction of DNA polymerase I. *Biochemistry* **30**: 11104-11108.
- Hara E., Kato T., Nakada S., Sekiya S., and Oda K. 1991. Subtractive cDNA cloning using oligo(dT)30-latex and PCR: Isolation of cDNA clones specific to undifferentiated human embryonal carcinoma cells. *Nucleic Acids Res.* **19**: 7097-7104.
- Hara E., Yamaguchi T., Tahara H., Tsuyama N., Tsurui H., Ide T., and Oda K. 1993. DNA-DNA subtractive cDNA cloning using oligo(dT)30-latex and PCR: Identification of cellular genes which are overexpressed in senescent human diploid fibroblasts. *Anal. Biochem.* **214**: 58-64.
- Harrison B. and Zimmerman S.B. 1986a. T4 polynucleotide kinase: Macromolecular crowding increases the efficiency of reaction at DNA termini. *Anal. Biochem.* **158**: 307-315.
- . 1986b. Stabilization of T4 polynucleotide kinase by macromolecular crowding. *Nucleic Acids Res.* **14**: 1863-1870.
- Hastie N.D. and Bishop J.O. 1976. The expression of three abundance classes of messenger RNA in mouse tissues. *Cell* **9**: 761-774.
- Hedrick S.M., Cohen D.I., Nielsen E.A., and Davis M.M. 1984. Isolation of cDNA clones encoding T cell-specific membrane-associated proteins. *Nature* **308**: 149-153.
- Hegnauer R. 1971. Pflanzenstoffe und Pflanzenzytometrik (plant constituents and plant taxonomy). *Naturwissenschaften* **58**: 585-598.
- Heppel L.A., Harkness D.R., and Hilmoer R.J. 1962. A study of the substrate specificity and other properties of the alkaline phosphatase of *Escherichia coli*. *J. Biol. Chem.* **237**: 841-846.
- Hess J., Laumen H., and Wirth T. 1998. Application of differential cDNA screening techniques to the identification of unique gene expression in tumours and lymphocytes. *Curr. Opin. Immunol.* **10**: 125-130.
- Hillier L.D., Lennon G., Becker M., Bonaldo M.F., Chiapelli B., Chissoe S., Dietrich N., DuBuque T., Favello A., Gish W., Hawkins M., Hultman M., Kucaba T., Lacy M., Le N., Mardis E., Moore B., Morris M., Parsons J., Prange C., Rifkin L., Rohlfling T., Schellenberg K., Marra M., et al. 1996. Generation and analysis of 280,000 human expressed sequence tags. *Genome Res.* **6**: 807-828.
- Hodgson C.P. and Fisk R.Z. 1987. Hybridization probe size control: Optimized "oligolabelling." *Nucleic Acids Res.* **15**: 6295.
- Hodgson M. and Jones P. 1989. Enhanced chemiluminescence in the peroxidase-luminol-H<sub>2</sub>O<sub>2</sub> system: Anomalous reactivity of enhancer phenols with enzyme intermediates. *J. Biolumin. Chemilumin.* **3**: 21-25.
- Hoffmann-Blume E., Garcia Marenco M.B., Ehle H., Bublitz R., Schulze M., and Horn A. 1991. Evidence for glycosylphosphatidylinositol anchoring of intraluminal alkaline phosphatase of the calf intestine. *Eur. J. Biochem.* **199**: 305-312.
- Höltke H.-J. and Kessler C. 1990. Non-radioactive labeling of RNA transcripts in-vitro with the hapten digoxigenin (DIG); hybridization and ELISA-based detection. *Nucleic Acids Res.* **18**: 5843-5851.
- Höltke H.-J., Seibl R., Burg J., Mühlegger K. and Kessler C. 1990. Non-radioactive labeling and detection of nucleic acids. II. Optimization of the digoxigenin system. *Biol. Chem. Hoppe-Seyler* **371**: 929-938.
- Höltke H.-J., Schneider S., Ettl I., Binsack R., Obermaier I., Seller M., and Sagner G. 1994. Rapid and highly sensitive detection of digoxigenin-labelled nucleic acids by improved chemiluminescent substrates. In *Proceedings of the 8th Symposium on Bioluminescence and Chemiluminescence: Fundamentals and applied aspects* (ed. A.K. Campbell et al.), pp. 273-276. Wiley, Chichester, United Kingdom.
- Höltke, H.-J., Ankenbauer W., Mühlegger K., Rein R., Sagner G., Seibl R., and Walter T. 1995. The digoxigenin (DIG) system for non-radioactive labelling and detection of nucleic acids — An overview. *Cell. Mol. Biol.* **41**: 883-905.
- Höög C. 1991. Isolation of a large number of novel mammalian genes by a differential cDNA library screening strategy. *Nucleic Acids Res.* **19**: 6123-6127.
- Horwitz J.P., Chua J., Noel M., Donatti J.T., and Freisler J. 1966. Substrates for cytochemical demonstration of enzyme activity. II. Some dihalo-3-indolyl phosphates and sulfates. *J. Med. Chem.* **9**: 447.
- Ikeda R.A. and Bailey P.A. 1992. Inhibition of T7 RNA polymerase by T7 lysozyme in vitro. *J. Biol. Chem.* **267**: 20153-20158.
- Innis M.A., Myambo K.B., Gelfand D.H., and Brow M.A.D. 1988. DNA sequencing with *Thermus aquaticus* DNA polymerase and direct sequencing of polymerase chain reaction-amplified DNA. *Proc. Natl. Acad. Sci.* **85**: 9436-9440.
- Ish-Horowicz D. and Burke J.F. 1981. Rapid and efficient cosmid cloning. *Nucleic Acids Res.* **9**: 2989-98.
- Jablonski E., Moomaw E.W., Tullis R.H., and Ruth J.L. 1986. Preparation of oligodeoxynucleotide-alkaline phosphatase conjugates and their use as hybridization probes. *Nucleic Acids Res.* **14**: 6115-6128.
- Jansen R. and Ledley F.D. 1989. Production of discrete high specific activity DNA probes using the polymerase chain reaction. *Gene Anal. Tech.* **6**: 79-83.
- Ji H., Liu Y.E., Jia T., Wang M., Liu J., Xiao G., Joseph B.K., Rosen C., and Shi Y.E. 1997. Identification of a breast cancer-specific gene, BCSG1, by direct differential cDNA sequencing. *Cancer Res.* **57**: 759-764.

- Jin H., Cheng X., Diatchenko L., Siebert P.D., and Huang C.C. 1997. Differential screening of a subtracted cDNA library: A method to search for genes preferentially expressed in multiple tissues. *BioTechniques* **23**: 1084–1086.
- Jorgensen E.D., Durbin R.K., Risman S.S., and McAllister W.T. 1991. Specific contacts between the bacteriophage T3, T7, and SP6 RNA polymerases and their promoters. *J. Biol. Chem.* **266**: 645–651.
- Joyce C.M. and Grindley N.D.F. 1983. Construction of a plasmid that overproduces the large proteolytic fragment (Klenow fragment) of DNA polymerase I of *Escherichia coli*. *Proc. Natl. Acad. Sci.* **80**: 1830–1834.
- Joyce C.M. and Steitz T.A. 1987. DNA polymerase I: From crystal structure to function via genetics. *Trends Biochem. Sci.* **12**: 288–292.
- Joyce C.M., Kelley W.S. and Grindley N.D.F. 1982. Nucleotide sequence of the *Escherichia coli* *polA* gene and primary structure of DNA polymerase I. *J. Biol. Chem.* **257**: 1958–1964.
- Kagiyama N., Fujita S., Momiyama M., Saito H., Shirahama H., and Hori S.H. 1992. A fluorescent detection method for DNA hybridization using 2-hydroxy-3-naphthoic acid-2-phenylamylid phosphate as a substrate for alkaline phosphatase. *Acta Histochem. Cytochem.* **25**: 467–471.
- Kain K.C., Orlandi P.A., and Lanar D.E. 1991. Universal promoter for gene expression without cloning: Expression-PCR. *BioTechniques* **10**: 366–374.
- Keller G.H., Cumming C.U., Huang D.P., Manak M.M., and Ting R. 1988. A chemical method for introducing haptens onto DNA probes. *Anal. Biochem.* **170**: 441–450.
- Kelley W.S. and Stump K.H. 1979. A rapid procedure for isolation of large quantities of *Escherichia coli* DNA polymerase utilizing a  $\lambda$ *polA* transducing phage. *J. Biol. Chem.* **254**: 3206–3210.
- Kelly R.B., Cozzarelli N.R., Deutscher M.P., Lehman I.R., and Kornberg A. 1970. Enzymatic synthesis of deoxyribonucleic acid. XXXII. Replication of duplex deoxyribonucleic acid by polymerase at a single strand break. *J. Biol. Chem.* **245**: 39–45.
- Kerkhof L. 1992. A comparison of substrates for quantifying the signal from a nonradiolabeled DNA probe. *Anal. Biochem.* **205**: 359–364.
- Kessler C. 1991. The digoxigenin:anti-digoxigenin (DIG) technology — A survey on the concept and realization of a novel bioanalytical indicator system. *Mol. Cell. Probes* **5**: 161–205.
- . 1992. Nonradioactive labeling for nucleic acids. In *Nonisotopic DNA probe techniques* (ed. L.J. Kricka), pp. 28–92. Academic Press, New York.
- . 1994. Non-radioactive analysis of biomolecules. *J. Biotechnol.* **35**: 165–189.
- Kessler C., Hölte H.-J., Seibl R., Burg J., and Mühlegger K. 1990. Non-radioactive labeling and detection of nucleic acids. I. A novel DNA labeling and detection system based on digoxigenin: Anti-digoxigenin ELISA principle (digoxigenin system). *Biol. Chem. Hoppe-Seyler* **371**: 917–927.
- Khan J., Simon R., Bittner M., Chen Y., Leighton S.B., Pohida T., Smith P.D., Jiang Y., Gooden G.C., Trent J.M., and Meltzer P.S. 1998. Gene expression profiling of alveolar rhabdomyosarcoma with cDNA microarrays. *Cancer Res.* **58**: 5009–5013.
- Kikuchi Y., Hishinuma F., and Sakaguchi K. 1978. Addition of mononucleotides to oligoribonucleotide acceptors with T4 RNA ligase. *Proc. Natl. Acad. Sci.* **75**: 1270–1273.
- Klar A., Baldassare M., and Jessell T.M. 1992. F-spondin: A gene expressed at high levels in the floor plate encodes a secreted protein that promotes neural cell adhesion and neurite extension. *Cell* **69**: 95–110.
- Klenow H. and Henningsen I. 1970. Selective elimination of the exonuclease activity of the deoxyribonucleic acid polymerase from *Escherichia coli* B by limited proteolytic digestion. *Proc. Natl. Acad. Sci.* **65**: 168–175.
- Klenow H. and Overgaard-Hansen K. 1970. Proteolytic cleavage of DNA polymerase from *Escherichia coli* B into an exonuclease unit and a polymerase unit. *FEBS Lett.* **6**: 25–27.
- Klenow H., Overgaard-Hansen K., and Patkar S.A. 1971. Proteolytic cleavage of native DNA polymerase into two different catalytic fragments. Influence of assay conditions on the change of exonuclease activity and polymerase-activity accompanying cleavage. *Eur. J. Biochem.* **22**: 371–381.
- Klevan L., Horton E., Carlson D.P., and Eisenberg A.J. 1993. Chemiluminescent detection of DNA probes in forensic analysis. *The 2nd International Symposium on the Forensic Aspects of DNA Analysis*. FBI Academy, Quantico, Virginia at <http://www.fbi.gov>
- Koch J., Kolvraa S., and Bolund L. 1986. An improved method for labelling of DNA probes by nick translation. *Nucleic Acids Res.* **14**: 7132.
- Kolocheva T.I., Nevinsky G.A., Volchkova V.A., Levina A.S., Khomov V.V., and Lavrik O.I. 1989. DNA polymerase I (Klenow fragment): Role of the structure and length of a template in enzyme recognition. *FEBS Lett.* **248**: 97–100.
- Konarska, M.M., R.A. Padgett, and Sharp P.A. 1984. Recognition of cap structure in splicing in vitro of mRNA precursors. *Cell* **38**: 731–736.
- Konietzko U. and Kuhl D. 1998. A subtractive hybridisation method for the enrichment of moderately induced sequences. *Nucleic Acids Res.* **26**: 1359–1361.
- Kornberg A. and Baker T.A. 1992. *DNA replication*, 2nd edition. W.H. Freeman, New York.
- Kornberg A., Lehman I.R., Bessman M.J., and Simms E.S. 1956. Enzymic synthesis of deoxyribonucleic acid. *Biochim. Biophys. Acta* **21**: 197–198.
- Kotani H., Ishizaki Y., Hiraoka N., and Obayashi A. 1987. Nucleotide sequence and expression of the cloned gene of bacteriophage SP6 RNA polymerase. *Nucleic Acids Res.* **15**: 2653–2664.
- Kricka L.J., ed. 1992. Nucleic acid hybridization test formats: Strategies and applications. In *Nonisotopic DNA probe techniques*, pp. 3–27. Academic Press, New York.
- Kricka L.J. and Ji X. 1995. 4-Phenylboronic acid: A new type of enhancer for the horseradish peroxidase catalysed chemiluminescent oxidation of luminol. *J. Biolumin. Chemilumin.* **10**: 49–54.
- Krieg P.A. and Melton D.A. 1987. In vitro RNA synthesis with SP6 RNA polymerase. *Methods Enzymol.* **155**: 397–415.
- Kuchta R.D., Benkovic P., and Benkovic S.J. 1988. Kinetic mechanism whereby DNA polymerase I (Klenow) replicates DNA with high fidelity. *Biochemistry* **27**: 6716–6725.
- Kuchta R.D., Mizrahi V., Benkovic P.A., Johnson K.A., and Benkovic S.J. 1987. Kinetic mechanism of DNA polymerase I (Klenow). *Biochemistry* **26**: 8410–8417.
- Kunkel T.A., Roberts J.D., and Zakour R.A. 1987. Rapid and efficient site-specific mutagenesis without phenotypic selection. *Methods Enzymol.* **154**: 367–382.
- Kunkel T.A., Eckstein F., Mildvan A.S., Koplitz R.M., and Loeb L.A. 1981. Deoxynucleoside [1-thio]triphosphates prevent proofreading during in vitro DNA synthesis. *Proc. Natl. Acad. Sci.* **78**: 6734–6738.

- Kurien B.T., Scofield R.H., and Broyles R.H. 1997. Efficient 5' end labeling of dephosphorylated DNA. *Anal. Biochem.* **245**: 123-126.
- Langer P.R., Waldrop A.A., and Ward D.C. 1981. Enzymatic synthesis of biotin-labeled polynucleotides: Novel nucleic acid affinity probes. *Proc. Natl. Acad. Sci.* **78**: 6633-6637.
- Lanzillo J.J. 1990. Preparation of digoxigenin-labeled probes by the polymerase chain reaction. *BioTechniques* **8**: 620-622.
- Leary J.J., Brigati D.J., and Ward D.C. 1983. Rapid and sensitive colorimetric method for visualizing biotin-labeled DNA probes hybridized to DNA or RNA immobilized on nitrocellulose: Bio-blots. *Proc. Natl. Acad. Sci.* **80**: 4045-4049.
- Lebeau M.C., Alvarez-Bolado G., Wahli W., and Catsicas S. 1991. PCR driven DNA-DNA competitive hybridization: A new method for sensitive differential cloning. *Nucleic Acids Res.* **19**: 4778.
- Lechner R.L., Engler M.J., and Richardson C.C. 1983. Characterization of strand displacement synthesis catalyzed by bacteriophage T7 DNA polymerase. *J. Biol. Chem.* **258**: 11174-11184.
- Lehman I.R. and Richardson C.C. 1964. The deoxyribonucleases of *Escherichia coli*. IV. An exonuclease activity present in purified preparations of deoxyribonucleic acid polymerase. *J. Biol. Chem.* **239**: 233-241.
- Lerman L.S. 1971. A transition to a compact form of DNA in polymer solutions. *Proc. Natl. Acad. Sci.* **68**: 1886-1890.
- Lewin B. 1975. Units of transcription and translation: The relationship between heterogeneous nuclear RNA and messenger RNA. *Cell* **4**: 11-20.
- Ley T.J., Anagnou N.P., Pepe G., and Nienhuis A.W. 1982. RNA processing errors in patients with  $\beta$ -thalassemia. *Proc. Natl. Acad. Sci.* **79**: 4775-4779.
- Lillehaug J.R. and Kleppe K. 1975a. Kinetics and specificity of T4 polynucleotide kinase. *Biochemistry* **14**: 1221-1225.
- . 1975b. Effect of salts and polyamines polynucleotide kinase. *Biochemistry* **14**: 1225-1229.
- Lillehaug J.R., Kleppe R.K., and Kleppe K. 1976. Phosphorylation of double-stranded DNAs by T4 polynucleotide kinase. *Biochemistry* **15**: 1858-1865.
- Lingner J. and Keller W. 1993. 3'-End labeling of RNA with recombinant yeast poly(A) polymerase. *Nucleic Acids Res.* **21**: 2917-2920.
- Loewy, Z.G., S.L. Leary, and H.J. Baum. 1989. Site-directed transcription initiation with a mobile promoter. *Gene* **83**: 367-370.
- Logel J., Dill D., and Leonard S. 1992. Synthesis of cRNA probes from PCR-generated DNA. *BioTechniques* **13**: 604-610.
- Lönneborg A., Sharma P., and Stougaard P. 1995. Construction of subtractive cDNA library using magnetic beads and PCR. *PCR Methods Appl.* **4**: S168-S176.
- López-Fernández L.A. and del Mazo J. 1993. Construction of subtractive cDNA libraries from limited amounts of mRNA and multiple cycles of subtraction. *BioTechniques* **15**: 654-659.
- Maniatis T., Jeffrey A., and Kleid D.G. 1975. Nucleotide sequence of the rightward operator of phage lambda. *Proc. Natl. Acad. Sci.* **72**: 1184-1188.
- Mansfield E.S., Worley J.M., McKenzie S.E., Surrey S., Rappaport E., and Fortina P. 1995. Nucleic acid detection using non-radioactive labelling methods. *Mol. Cell. Probes* **9**: 145-156.
- Martin C.S. and Bronstein I. 1994. Imaging of chemiluminescent signals with cooled CCD camera systems. *J. Biolumin. Chemilumin.* **9**: 145-153.
- Martin C.S., Bresnick L., Juo R.R., Voyta J.C., and Bronstein I. 1991. Improved chemiluminescent DNA sequencing. *BioTechniques* **11**: 110-113.
- Maunder M.J. 1993. Polynucleotide kinase. *Methods Mol. Biol.* **16**: 343-356.
- Maxwell I.H., Maxwell F., and Hahn W.E. 1977. Removal of RNase activity from DNase by affinity chromatography on agarose coupled aminophenylphosphoryl-uridine-2' (3')-phosphate. *Nucleic Acids Res.* **4**: 241-246.
- McCabe P.C. 1990. Production of single-stranded DNA by asymmetric PCR. In *PCR protocols: A guide to methods and applications* (ed. M.A. Innis et al.), pp. 76-83. Academic Press, New York.
- McGadey J. 1970. A tetrazolium method for non-specific alkaline phosphatase. *Histochemie* **23**: 180-184.
- McGraw N.J., Bailey J.N., Cleaves G.R., Dembinski D.R., Gocke C.R., Joliffe L.K., MacWright R.S., and McAllister W.T. 1985. Sequence and analysis of the gene for bacteriophage T3 RNA polymerase. *Nucleic Acids Res.* **13**: 6753-6766.
- Meinkoth J. and Wahl G. 1984. Hybridization of nucleic acids immobilized on solid supports. *Anal. Biochem.* **138**: 267-284.
- Melli M., Whitfield C., Rao K.V., Richardson M., and Bishop J.O. 1971. DNA-RNA hybridization in vast DNA excess. *Nat. New Biol.* **231**: 8-12.
- Melton D.A., Krieg P.A., Rebagliati M.R., Maniatis T., Zinn K., and Green M.R. 1984. Efficient in vitro synthesis of biologically active RNA and RNA hybridization probes from plasmids containing a bacteriophage SP6 promoter. *Nucleic Acids Res.* **12**: 7035-7056.
- Milligan J.F. and Uhlenbeck O.C. 1989. Synthesis of small RNAs using T7 RNA polymerase. *Methods Enzymol.* **180**: 51-62.
- Milligan J.F., Groebe D.R., Witherell G.W., and Uhlenbeck O.C. 1987. Oligoribonucleotide synthesis using T7 RNA polymerase and synthetic DNA templates. *Nucleic Acids Res.* **15**: 8783-8798.
- Moffatt B.A. and Studier F.W. 1987. T7 lysozyme inhibits transcription by T7 RNA polymerase. *Cell* **49**: 221-227.
- Moffatt B.A., Dunn J.J., and Studier F.W. 1984. Nucleotide sequence of the gene for bacteriophage T7 RNA polymerase. *J. Mol. Biol.* **173**: 265-269.
- Morris C.E., Klement J.F., and McAllister W.T. 1986. Cloning and expression of the bacteriophage T3 RNA polymerase gene. *Gene* **41**: 193-200.
- Murray N.E. and Kelley W.S. 1979. Characterization of  $\lambda$ polA transducing phages; effective expression of the *E. coli* polA gene. *Mol. Gen. Genet.* **175**: 77-87.
- Nelson N.C., Reynolds M.A., and Arnold Jr., L.J. 1992. Detection of acridinium esters by chemiluminescence. In *Nonisotopic DNA probe techniques* (ed. L.J. Kricka), pp. 276-311. Academic Press, New York.
- Nossal N.G. 1974. DNA synthesis on a double-stranded DNA template by the T4 bacteriophage DNA polymerase and the T4 gene 32 DNA unwinding protein. *J. Biol. Chem.* **249**: 5668-5676.
- Nygaard A.P. and Hall B.D. 1963. A method for the detection of RNA-DNA complexes. *Biochem. Biophys. Res. Commun.* **12**: 98-104.
- . 1964. Formation and properties of RNA-DNA complexes. *J. Mol. Biol.* **9**: 125-142.
- Oakley J.L., Strothkamp R.E., Sarris A.H., and Coleman J.E. 1979. T7 RNA polymerase: promoter structure and polymerase binding. *Biochemistry* **18**: 528-537.
- O'Farrell P.H., Kutter E., and Nakanishi M. 1980. A restriction

- map of the bacteriophage T4 genome. *Mol. Gen. Genet.* **179**: 421–435.
- Ollis D.L., Brick P., Hamlin R., Xuong N.G., and Steitz T.A. 1985. Structure of the large fragment of *Escherichia coli* DNA polymerase complexed with dTMP. *Nature* **313**: 762–766.
- Oommen A., Ferrandis I., and Wang M.J. 1990. Single-step labeling of DNA using restriction endonucleases and T4 polynucleotide kinase. *BioTechniques* **8**: 482–486.
- Orr S.L., Hughes T.P., Sawyers C.L., Kato R.M., Quan S.G., Williams S.P., Witte O.N., and Hood L. 1994. Isolation of unknown genes from human bone marrow by differential screening and single-pass cDNA sequence determination. *Proc. Natl. Acad. Sci.* **91**: 11869–11873.
- Pandey V.N., Kaushok N., Sanzgiri R.P., Patil M., Modak M., and Barik S. 1993. Site-directed mutagenesis of DNA polymerase I (Klenow) from *Escherichia coli*. *Eur. J. Biochem.* **214**: 59–65.
- Party E. and Gershey E.L. 1995. A review of some available radioactive and non-radioactive substitutes for use in biomedical research. *Health Phys.* **69**: 1–5.
- Pataki S., Meyer K., and Reichstein T. 1953. Die Konfiguration des Digoxigenins Glykoside und Algycone I16, Mitteling. *Helv. Chim. Acta* **36**: 1295–1308.
- Patanjali S.R., Parimoo S., and Weissman S.M. 1991. Construction of a uniform-abundance (normalized) cDNA library (erratum *Proc. Natl. Acad. Sci.* [1991] **88**: 5066). *Proc. Natl. Acad. Sci.* **88**: 1943–1947.
- Perret E., Ferrán E.A., Marin O., Liauzun P., Dumont X., Fournier J., Kaghad M., Ferrara P., and Caput D. 1998. Improved differential screening approach to analyse transcriptional variations in organized cDNA libraries. *Gene* **208**: 103–115.
- Polesky A.H., Steitz T.A., Grindley N.D.F., and Joyce C.M. 1990. Identification of residues critical for the polymerase activity of the Klenow fragment of DNA polymerase I from *Escherichia coli*. *J. Biol. Chem.* **265**: 14579–14591.
- Polesky A.H., Dahlberg M.E., Benkovic S.J., Grindley N.D.F., and Joyce C.M. 1992. Side chains involved in catalysis of the polymerase reaction of DNA polymerase I from *Escherichia coli*. *J. Biol. Chem.* **267**: 8417–8428.
- Pollard-Knight D., Read C.A., Downes M.J., Howard L.A., Leadbetter M.R., Pheby S.A., McNaughton E., Syms A., and Brady M.A. 1990. Nonradioactive nucleic acid detection by enhanced chemiluminescence using probes directly labeled with horseradish peroxidase. *Anal. Biochem.* **185**: 84–89.
- Prober J.M., Trainor G.L., Dam R.J., Hobbs F.W., Robertson C.W., Zagursky R.J., Cocuzza A.J., Jensen M.A., and Baumeister K. 1987. A system for rapid DNA sequencing with fluorescent chain-terminating dideoxynucleotides. *Science* **238**: 336–341.
- Que B.G., Downey K.M., and So A. 1978. Mechanisms of selective inhibition of 3' to 5' exonuclease activity of *Escherichia coli* DNA polymerase I by nucleoside 5'-monophosphates. *Biochemistry* **17**: 1603–1606.
- Rajeevan M.S., Dimulescu I.M., Unger E.R., and Vernon S.D. 1999. Chemiluminescent analysis of gene expression on high-density filter arrays. *J. Histochem. Cytochem.* **47**: 337–342.
- Reid T.W. and Wilson I.B. 1971. *E. coli* alkaline phosphatase. In *The enzymes*, 3rd edition (ed. P.D. Boyer), vol. 4, pp. 373–415. Academic Press, New York.
- Reischl U., Rürger R., and Kessler C. 1994. Nonradioactive labeling and high-sensitive detection of PCR products. *Mol. Biotechnol.* **1**: 229–240.
- Reisfeld A., Rothenberg J.M., Bayer E.A., and Wilchek M. 1987. Nonradioactive hybridization probes prepared by the reaction of biotin hydrazide with DNA. *Biochem. Biophys. Res. Commun.* **142**: 519–526.
- Renz M. and Kurz C. 1984. A colorimetric method for DNA hybridization. *Nucleic Acids Res.* **12**: 3435–3444.
- Reyes R.A. and Cockerell G.L. 1993. Preparation of pure oligonucleotide-alkaline phosphatase conjugates. *Nucleic Acids Res.* **21**: 5532–5533.
- Rhyner T.A., Biguet N.F., Berrard S., Borbély A.A., and Mallet J. 1986. An efficient approach for the selective isolation of specific transcripts from complex brain mRNA populations. *J. Neurosci. Res.* **16**: 167–181.
- Richardson C.C. 1971. Polynucleotide kinase from *Escherichia coli* infected with bacteriophage T4. In *Procedures in nucleic acid research* (ed. G.L. Cantoni and D.R. Davies), vol. 2, pp. 815–828. Harper and Row, New York.
- Richardson C.C., Inman R.B., and Kornberg A. 1964a. Enzymic synthesis of deoxyribonucleic acid. XVIII. The repair of partially single-stranded DNA templates by DNA polymerase. *J. Mol. Biol.* **9**: 46–69.
- Richardson C.C., Schildkraut C.L., Aposhian H.V., and Kornberg A. 1964b. Enzymatic synthesis of deoxyribonucleic acid. XIV. Further purification and properties of deoxyribonucleic acid polymerase of *Escherichia coli*. *J. Biol. Chem.* **239**: 222–232.
- Rigby P.W., Dieckmann M., Rhodes C., and Berg P. 1977. Labeling deoxyribonucleic acid to high specific activity in vitro by nick translation with DNA polymerase I. *J. Mol. Biol.* **113**: 237–251.
- Rihn B., Bottin M.C., Coulais C., and Martinet N. 1995. Evaluation of non-radioactive labelling and detection of deoxyribonucleic acids. II. Colorigenic methods and comparison with chemiluminescent methods. *J. Biochem. Biophys. Methods* **30**: 103–112.
- Rodriguez I.R. and Chader G.J. 1992. A novel method for the isolation of tissue-specific genes. *Nucleic Acids Res.* **20**: 3528.
- Rothstein J.L., Johnson D., Jessee J., Skowronski J., DeLoia J.A., Solter D., and Knowles B.B. 1993. Construction of primary and subtracted cDNA libraries from early embryos. *Methods Enzymol.* **225**: 587–610.
- Roy S., Delling U., Chen C.H., Rosen C.A., and Sonenberg N. 1990. A bulge structure in HIV-1 TAR RNA is required for Tat binding and Tat-mediated trans-activation. *Genes Dev.* **4**: 1365–1373.
- Roychoudhury R., Jay E., and Wu R. 1976. Terminal labeling and addition of homopolymer tracts to duplex DNA fragments by terminal deoxynucleotidyl transferase. *Nucleic Acids Res.* **3**: 101–116.
- Roychoudhury R., Tu C.P., and Wu R. 1979. Influence of nucleotide sequence adjacent to duplex DNA termini on 3' terminal labeling by terminal transferase. *Nucleic Acids Res.* **6**: 1323–1333.
- Rubenstein J.L.R., Brice A.E.J., Ciaranello R.D., Denney D., Porteus M.H., and Usdin T.B. 1990. Subtractive hybridization system using single-stranded phagemids with directional inserts. *Nucleic Acids Res.* **18**: 4833–4842.
- Ryffel G.U. and McCarthy B.J. 1975. Complexity of cytoplasmic RNA in different mouse tissues measured by hybridization of polyadenylated RNA to complementary DNA. *Biochemistry* **14**: 1379–1385.
- Sagerström C.G., Sun B.I., and Sive H.L. 1997. Subtractive cloning: Past, present, and future. *Annu. Rev. Biochem.* **66**: 751–783.
- Saiki R.K., Scharf S., Faloona F., Mullis K.B., Horn G.T., Erlich



- H.A., and Arnheim N. 1985. Enzymatic amplification of  $\beta$ -globin genomic sequences and restriction site analysis for diagnosis of sickle cell anemia. *Science* **230**: 1350–1354.
- Salvo R.A., Chakraborty P.R., and Maitra U. 1973. Studies on T3-induced ribonucleic acid polymerase. IV. Transcription of denatured deoxyribonucleic acid preparations by T3 ribonucleic acid polymerase. *J. Biol. Chem.* **248**: 6647–6654.
- Sargent T.D. 1987. Isolation of differentially expressed genes. *Methods Enzymol.* **152**: 423–432.
- Sargent T.D. and Dawid I.B. 1983. Differential gene expression in the gastrula of *Xenopus laevis*. *Science* **222**: 135–139.
- Sayavedra-Soto L.A. and Gresshoff P.M. 1992. Taq DNA polymerase for labeling DNA using random primers. *BioTechniques* **13**: 568, 570, 572.
- Schaap A.P., Akhavan H., and Romano L.J. 1989. Chemiluminescent substrates for alkaline phosphatase: Application to ultrasensitive enzyme-linked immunoassays and DNA probes. *Clin. Chem.* **35**: 1863–1864.
- Schena M. 1989. High efficiency oligonucleotide mutagenesis using Sequenase. *Comments (U.S. Biochemical Corp.)* **15**: 23.
- Schena M., Heller R.A., Theriault T.P., Konrad K., Lachenmeier E., and Davis R.W. 1998. Microarrays: Biotechnology's discovery platform for functional genomics. *Trends Biotechnol.* **16**: 301–306.
- Schena M., Shalon D., Heller R., Chai A., Brown P.O., and Davis R.W. 1996. Parallel human genome analysis: Microarray-based expression monitoring of 1000 genes. *Proc. Natl. Acad. Sci.* **93**: 10614–10619.
- Schenborn E.T. and Mierendorf Jr., R.C. 1985. A novel transcription property of SP6 and T7 RNA polymerases: Dependence on template structure. *Nucleic Acids Res.* **13**: 6223–6236.
- Schneider G.S., Martin C.S., and Bronstein I. 1994. Chemiluminescent detection of RNA labeled with biotinylated dideoxynucleotides and terminal transferase. *J. NIH Res.* **6**: 90.
- Schwalter D.B. and Sommer S.S. 1989. The generation of radio-labeled DNA and RNA probes with polymerase chain reaction. *Anal. Biochem.* **177**: 90–94.
- Scott M.R.D., Westphal K.-H., and Rigby P.W.J. 1983. Activation of mouse genes in transformed cells. *Cell* **34**: 557–567.
- Scully S.P., Joyce M.E., Abidi N., and Bolander M.E. 1990. The use of polymerase chain reaction generated nucleotide sequences as probes for hybridization. *Mol. Cell. Probes* **4**: 485–495.
- Seibl R., Höltke H.J., Rügger R., Meindl A., Zachau H.G., Rasshofer R., Roggendorf M., Wolf H., Arnold N., Wienberg J., et al. 1990. Non-radioactive labeling and detection of nucleic acids. III. Applications of the digoxigenin system. *Biol. Chem. Hoppe-Seyler* **371**: 939–951.
- Setlow P. 1974. DNA polymerase I from *Escherichia coli*. *Methods Enzymol.* **29**: 3–12.
- Sharma P., Lönneborg A., and Stougaard P. 1993. PCR-based construction of subtractive cDNA library using magnetic beads. *BioTechniques* **15**: 610, 612.
- Shyamala V. and Ames G.F. 1989. Genome walking by single-specific-primer polymerase chain reaction: SSP-PCR. *Gene* **84**: 1–8.
- , 1993. Genome walking by single specific primer-polymerase chain reaction. *Methods Enzymol.* **217**: 436–446.
- Sirotkin K., Cooley W., Runnels J., and Snyder L.R. 1978. A role in true-late gene expression for the T4 bacteriophage 5' polynucleotide kinase 3' phosphatase. *J. Mol. Biol.* **123**: 221–233.
- Sive H.L. and St. John T. 1988. A simple subtractive hybridization technique employing photoactivatable biotin and phenol extraction. *Nucleic Acids Res.* **16**: 10937.
- Smith L.M., Sanders J.Z., Kaiser R.J., Hughes P., Dodd C., Connell C.R., Heiner C., Kent S.B., and Hood L.E. 1986. Fluorescence detection in automated DNA sequence analysis. *Nature* **321**: 674–679.
- Soares M.B. 1997. Identification and cloning of differentially expressed genes. *Curr. Opin. Biotechnol.* **8**: 542–546.
- Soares M.B., Bonaldo M.F., Jelene P., Su L., Lawton L., and Efstratiadis A. 1994. Construction and characterization of a normalized cDNA library. *Proc. Natl. Acad. Sci.* **91**: 9228–9232.
- Southern E.M. 1975. Detection of specific sequences among DNA fragments separated by gel electrophoresis. *J. Mol. Biol.* **98**: 503–517.
- Spangrude G.J., Heimfeld S., and Weissman I.L. 1988. Purification and characterization of mouse hematopoietic stem cells (erratum *Science* [1989] **244**: 1030). *Science* **241**: 58–62.
- St. John T.P. and Davis R.W. 1979. Isolation of galactose-inducible DNA sequences from *Saccharomyces cerevisiae* by differential plaque filter hybridization. *Cell* **16**: 443–452.
- Stent G.S. and Fuerst C.R. 1960. Genetic and physiological effects of the decay of incorporated radioactive phosphorus in bacterial viruses and bacteria. *Adv. Biol. Med. Phys.* **7**: 2–71.
- Studencki A.B. and Wallace R.B. 1984. Allele-specific hybridization using oligonucleotide probes of very high specific activity: Discrimination of the human beta A- and beta S-globin genes. *DNA* **3**: 7–15.
- Studier F.W. and Moffatt B.A. 1986. Use of bacteriophage T7 RNA polymerase to direct selective high-level expression of cloned genes. *J. Mol. Biol.* **189**: 113–130.
- Studier F.W. and Rosenberg A.H. 1981. Genetic and physical mapping of the late region of bacteriophage T7 DNA by use of cloned fragments of T7 DNA. *J. Mol. Biol.* **153**: 503–525.
- Studier F.W., Rosenberg A.H., Dunn J.J., and Dubendorff J.W. 1990. Use of T7 RNA polymerase to direct expression of cloned genes. *Methods Enzymol.* **185**: 60–89.
- Stürzl M. and Roth W.K. 1990. Run-off synthesis and application of defined single-stranded DNA hybridization probes. *Anal. Biochem.* **185**: 164–169.
- Suganuma A. and Gupta K.C. 1995. An evaluation of primer length on random-primed DNA synthesis for nucleic acid hybridization: Longer is not better. *Anal. Biochem.* **224**: 605–608.
- Swaminathan N., George D., McMaster K., Szablewski J., Van Etten J.L., and Mead D.A. 1994. Restriction generated oligonucleotides utilizing the two base recognition endonuclease CviJI\*. *Nucleic Acids Res.* **22**: 1470–1475.
- Swaminathan N., Mead D.A., McMaster K., George D., Van Etten J.L., and Skowron P.M. 1996. Molecular cloning of the three base restriction endonuclease R.CviJI from eukaryotic *Chlorella* virus IL-3A. *Nucleic Acids Res.* **24**: 2463–2469.
- Swaroop A., Xu J.Z., Agarwal N., and Weissman S.M. 1991. A simple and efficient cDNA library subtraction procedure: Isolation of human retina-specific cDNA clones. *Nucleic Acids Res.* **19**: 1954.
- Syvänen A.C., Laaksonen M., and Söderlund H. 1986. Fast quantification of nucleic acid hybrids by affinity-based hybrid collection. *Nucleic Acids Res.* **14**: 5037–5048.
- Syvänen A.C., Bengtström M., Tenhunen J., and Söderlund H. 1988. Quantification of polymerase chain reaction products by affinity-based hybrid collection. *Nucleic Acids Res.* **16**: 11327–11338.

- Tabor S. and Richardson C.C. 1985. A bacteriophage T7 RNA polymerase/promoter system for controlled exclusive expression of specific genes. *Proc. Natl. Acad. Sci.* **82**: 1074–1078.
- Takahashi N., Hashida H., Zhao N., Misumi Y., and Sakaki Y. 1995. High-density cDNA filter analysis of the expression profiles of the genes preferentially expressed in human brain. *Gene* **164**: 219–227.
- Taylor J.M., Illmensee R., and Summers J. 1976. Efficient transcription of RNA into DNA by avian sarcoma virus polymerase. *Biochim. Biophys. Acta* **442**: 324–330.
- Telford J.L., Kressmann A., Koski R.A., Grosschedl R., Müller F., Clarkson S.G., and Birnstiel M.L. 1979. Delimitation of a promoter for RNA polymerase III by means of a functional test. *Proc. Natl. Acad. Sci.* **76**: 2590–2594.
- Templeton E.E., Wong H.E., Evangelista R.A., Granger T., and Pollak A. 1991. Time-resolved fluorescence detection of enzyme-amplified lanthanide luminescence for nucleic acid hybridization assays. *Clin. Chem.* **37**: 1506–1512.
- Thorpe G.H. and Kricka L.J. 1986. Enhanced chemiluminescent reactions catalyzed by horseradish peroxidase. *Methods Enzymol.* **133**: 331–353.
- Timberlake W.E. 1980. Developmental gene regulation in *Aspergillus nidulans*. *Dev. Biol.* **78**: 497–510.
- Tizard R., Cate R.L., Ramachandran K.L., Wusk M., Voyta J.C., Murphy O.J., and Bronstein I. 1990. Imaging of DNA sequences with chemiluminescence. *Proc. Natl. Acad. Sci.* **87**: 4514–4518.
- Traincard E., TERNYNCK T., DANCHIN A., and AVRAMEAS S. 1983. An immunoenzyme technique for demonstrating the molecular hybridization of nucleic acids (translation). *Ann. Immunol.* **134D**: 399–404.
- Travaglini E.C., Mildvan A.S., and Loeb L.A. 1975. Kinetic analysis of *Escherichia coli* deoxyribonucleic acid polymerase I. *J. Biol. Chem.* **250**: 8647–8656.
- Tu C.P. and Cohen S.N. 1980. 3'-End labeling of DNA with [ $\alpha$ -<sup>32</sup>P]cordycepin-5'-triphosphate. *Gene* **10**: 177–183.
- Tyc K. and Steitz J.A. 1989. U3, U8 and U13 comprise a new class of mammalian snRNPs localized in the cell nucleolus. *EMBO J.* **8**: 3113–3119.
- Uhlenbeck O. and Gumpert R.I. 1982. T4 RNA ligase. In *The enzymes*, 3rd edition (ed. P.D. Boyer), vol. 15, pp. 31–58. Academic Press, New York.
- Ullrich A., Shine J., Chirgwin J., Pictet R., Tischer E., Rutter W.J., and Goodman H.M. 1977. Rat insulin genes: Construction of plasmids containing the coding sequences. *Science* **196**: 1313–1319.
- Urdea M.S., Warner B.D., Running J.A., Stempien M., Clyne J., and Horn T. 1988. A comparison of non-radioisotopic hybridization assay methods using fluorescent, chemiluminescent and enzyme labeled synthetic oligodeoxyribonucleotide probes. *Nucleic Acids Res.* **16**: 4937–4956.
- Urrutia R., McNiven M.A., and Kachar B. 1993. Synthesis of RNA probes by the direct in vitro transcription of PCR-generated DNA templates. *J. Biochem. Biophys. Methods* **26**: 113–120.
- van de Sande J.H., Kleppe K., and Khorana H.G. 1973. Reversal of bacteriophage T4 induced polynucleotide kinase action. *Biochemistry* **12**: 5050–5055.
- van Houten V., Denkers F., van Dijk M., van den Brekel M., and Brakenhoff R. 1998. Labeling efficiency of oligonucleotides by T4 polynucleotide kinase depends on 5'-nucleotide. *Anal. Biochem.* **265**: 386–389.
- Viale G. and Dell'Orto P. 1992. Non-radioactive nucleic acid probes: Labelling and detection procedures. *Liver* **12**: 243–251.
- Vincent C., Tchen P., Cohen-Solal M., and Kourilsky P. 1982. Synthesis of 8-(2-4 dinitrophenyl 2-6 aminoethyl) amino-adenosine 5' triphosphate: Biological properties and potential uses. *Nucleic Acids Res.* **10**: 6787–6796.
- Volkaert G., de Vleeschouwer E., Blöcker H., and Frank R. 1984. A novel type of cloning vector for ultrarapid chemical degradation sequencing of DNA. *Gene Anal. Tech.* **1**: 52–59.
- Wang Z. and Brown D.D. 1991. A gene expression screen. *Proc. Natl. Acad. Sci.* **88**: 11505–11509.
- Weissig H., Schildge A., Hoylaerts M.F., Iqbal M., and Millán J.L. 1993. Cloning and expression of the bovine intestinal alkaline phosphatase gene: Biochemical characterization of the recombinant enzyme. *Biochem. J.* **290**: 503–508.
- Whitehead T.P., Thorpe G.H.G., Carter T.J.N., Groucutt C., and Kricka L.J. 1983. Enhanced luminescence procedure for sensitive determination of peroxidase-labelled conjugates in immunoassay. *Nature* **305**: 158–159.
- Wieland I., Bolger G., Asouline G., and Wigler M. 1990. A method for difference cloning: Gene amplification following subtractive hybridization. *Proc. Natl. Acad. Sci.* **87**: 2720–2724.
- Wu G., Su S., and Bird R.C. 1994. Optimization of subtractive hybridization in construction of subtractive cDNA libraries. *Genet. Anal. Tech. Appl.* **11**: 29–33.
- Wu R., Jay E., and Roychoudhury R. 1976. Nucleotide sequence analysis of DNA. *Methods Cancer Res.* **12**: 87–176.
- Yanisch-Perron C., Vieira J., and Messing J. 1985. Improved M13 phage cloning vectors and host strains: Nucleotide sequences of the M13mp18 and pUC19 vectors. *Gene* **33**: 103–119.
- Yisraeli J.K. and Melton D.A. 1989. Synthesis of long, capped transcripts in vitro by SP6 and T7 RNA polymerases. *Methods Enzymol.* **180**: 42–50.
- Young M.C., Reddy M.K., and von Hippel P.H. 1992. Structure and function of the bacteriophage T4 DNA polymerase holoenzyme. *Biochemistry* **31**: 8675–8690.
- Yousaf S.I., Carroll A.R., and Clarke B.E. 1984. A new and improved method for 3'-end labelling DNA using [ $\alpha$ -<sup>32</sup>P]ddATP. *Gene* **27**: 309–313.
- Zhao N., Hashida H., Takahashi N., Misumi Y., and Sakaki Y. 1995. High-density cDNA filter analysis: A novel approach for large-scale, quantitative analysis of gene expression. *Gene* **156**: 207–213.
- Zimmerman S.B. and Minton A.P. 1993. Macromolecular crowding: Biochemical, biophysical, and physiological consequences. *Annu. Rev. Biophys. Biomol. Struct.* **22**: 27–65.
- Zinn K., DiMaio D., and Maniatis T. 1983. Identification of two distinct regulatory regions adjacent to the human beta-interferon gene. *Cell* **34**: 865–879.
- Zittle C.A. and Della Monica E.S. 1950. Effects of borate and other ions on the alkaline phosphatase of bovine milk and intestinal mucosa. *Arch. Biochem. Biophys.* **26**: 112–122.

# Chapter 10

---

## Working with Synthetic Oligonucleotide Probes

### INTRODUCTION

#### PROTOCOLS

- |   |   |       |
|---|---|-------|
| 1 | Purification of Synthetic Oligonucleotides by Polyacrylamide Gel Electrophoresis                                      | 10.11 |
| 2 | Phosphorylating the 5' Termini of Oligonucleotides  | 10.17 |
| 3 | Purification of Radiolabeled Oligonucleotides by Precipitation with Ethanol   | 10.20 |
| 4 | Purification of Radiolabeled Oligonucleotides by Precipitation with Cetylpyridinium Bromide                           | 10.22 |
| 5 | Purification of Radiolabeled Oligonucleotides by Size-exclusion Chromatography  | 10.25 |
| 6 | Purification of Radiolabeled Oligonucleotides by Chromatography on a Sep-Pak C <sub>18</sub> Column                   | 10.28 |
| 7 | Labeling of Synthetic Oligonucleotides Using the Klenow Fragment of <i>E. coli</i> DNA Polymerase I                   | 10.30 |
| 8 | Hybridization of Oligonucleotide Probes in Aqueous Solutions: Washing in Buffers Containing Quaternary Ammonium Salts | 10.35 |
| 9 | Empirical Measurement of Melting Temperature  | 10.38 |

#### INFORMATION PANELS

- |   |       |
|---|-------|
| Oligonucleotide Synthesis                         | 10.42 |
| Melting Temperatures                              | 10.47 |
| Methods Used to Purify Synthetic Oligonucleotides | 10.48 |

**M**ETHODS TO SYNTHESIZE SHORT TRACTS OF SINGLE-STRANDED DNA, first developed more than 30 years ago, are now refined to a point where almost all chemical syntheses of oligonucleotides are carried out by automated machines (for further details on the chemistry of automated oligonucleotide synthesis, please see the information panel on **OLIGONUCLEOTIDE SYNTHESIS**). In the 1980s, the cost of these machines decreased to a point that many individual laboratories and core facilities could synthesize oligonucleotides at reasonable rates. The current trend in oligonucleotide synthesis is to order individual oligonucleotides from commercial suppliers, who by virtue of bulk purchases and centralized facilities can take advantage of economies of scale.

The ready availability of oligonucleotides of defined sequence, coupled with the development of appropriate hybridization techniques, revolutionized molecular cloning. It led to the primary isolation of cloned copies of genes that were previously inaccessible. Knowledge of the sequence of a few amino acids in a protein was sufficient to allow the rapid isolation of cloned copies of the corresponding gene. Facile and cheap synthesized oligonucleotides also brought site-directed mutagenesis within the range of large numbers of laboratories.

## USES OF OLIGONUCLEOTIDE PROBES

---

Although the use of oligonucleotides as hybridization probes for the initial isolation of a cDNA or a gene has been partly displaced by the polymerase chain reaction (PCR) and cloning strategies such as MOPAC (please see Chapter 8, Protocol 11), oligonucleotides are used widely in a variety of molecular cloning procedures:

- **Screening cDNA or genomic DNA libraries**, or subclones derived from them, for additional clones containing segments of DNA that have been isolated previously and whose sequences are known.
- **Identifying or detecting specific genes** or their transcripts in Southern, northern, or dot-blot hybridizations.
- **Examining genomic DNA and PCR-amplified DNA**, using Southern or dot-blot hybridization, to detect specific mutations in genes of known sequence.
- **Screening expression libraries for clones** that encode transcription factors and other proteins that bind to specific sequences of DNA.
- **Identifying clones that carry specific base changes** introduced into specific segments of DNA by site-directed mutagenesis.

Success with these techniques begins with the design of an oligonucleotide (1) that hybridizes specifically to its target and (2) whose physical properties (e.g., length and GC content) do not impose unnecessary constraints on the experimental protocol. In a few cases, the investigator has little latitude in the design of the oligonucleotide. For example, when oligonucleotides are used as allele-specific probes for the presence or absence of defined mutations, the salient properties of the oligonucleotides are defined to a very large extent by the particular sequences in which the mutation is embedded. In most other circumstances, however, the chance of success can be increased by careful adjustment of parameters defined by the investigator, such as the length, sequence, and base composition of the oligonucleotide. The rules outlined below were developed to optimize the design of oligonucleotide hybridization probes. However, most of them also apply to the design of primers for PCR or oligonucleotide-primed DNA sequencing.

## MELTING TEMPERATURE AND HYBRIDIZATION TEMPERATURE

---

An ideally designed oligonucleotide probe should form a perfect duplex only with its target sequence. These duplexes should be sufficiently stable to withstand the posthybridization washing steps used to remove probes nonspecifically bound to nontarget sequences. For oligonucleotides of 200 nucleotides or less, the reciprocal of the melting temperature of a perfect hybrid ( $T_m^{-1}$ , measured in degrees Kelvin) is approximately proportional to  $n^{-1}$ , where  $n$  is the number of bases in the oligonucleotide (please see Gait 1984).

Several equations are available to calculate the melting temperature of hybrids formed between an oligonucleotide primer and its complementary target sequence. Since none of these are perfect, the choice among them is largely a matter of personal preference (for additional information on calculating melting temperatures, please see the information panel on **MELTING TEMPERATURES**). The melting temperatures of each member of a primer:target duplex should obviously be calculated using the same equation.

- An empirical and convenient equation known as “The Wallace Rule” (Suggs et al. 1981b; Thein and Wallace 1986) can be used to calculate the  $T_m$  to perfect duplexes, 15–20 nucleotides in length, in solvents of high ionic strength (e.g., 1 M NaCl or 6x SSC)

$$T_m \text{ (in } ^\circ\text{C)} = 2(A+T) + 4(G+C)$$

where  $(A+T)$  is the sum of the A and T residues in the oligonucleotide and  $(G+C)$  is the sum of G and C residues in the oligonucleotide.

- The equation derived originally by Bolton and McCarthy (1962) and later modified by Baldino et al. (1989) predicts reasonably well the  $T_m$  of oligonucleotides, <100 nucleotides long, in cation concentrations of 0.5 M or less, and with a  $(G+C)$  content between 30% and 70%. It also compensates for the presence of base-pair mismatches between the oligonucleotide and the target sequence

$$T_m \text{ (in } ^\circ\text{C)} = 81.5^\circ\text{C} + 16.6 (\log_{10}[\text{Na}^+]) + 0.41(\%[\text{G+C}]) - 675/n - 1.0 m$$

where  $n$  is the number of bases in the oligonucleotide and  $m$  is the percentage of base-pair mismatches. This equation can also be used to calculate the melting temperature of an amplified product whose sequence and size are both known. When PCR amplification is carried out under standard conditions, the calculated  $T_m$  of the amplified product should not exceed  $\sim 85^\circ\text{C}$ , thus ensuring complete separation of its strands during the denaturation step. Note that the denaturation temperature in PCR is more accurately defined as the temperature of irreversible strand separation of a homogeneous population of molecules. The temperature of irreversible strand separation is several degrees higher than the  $T_m$  (typically,  $92^\circ\text{C}$  for DNA whose content of G+C is 50%) (Wetmur 1991).

- Neither of the above equations takes into account the effect of base sequence (as opposed to base composition) on the  $T_m$  of oligonucleotides. A more accurate estimate of the  $T_m$  can be obtained by incorporating nearest-neighbor thermodynamic data into the equations (Breslauer et al. 1986; Freier et al. 1986; Kierzek et al. 1986; Rychlik et al. 1990; Wetmur 1991; Rychlik 1994). A relatively straightforward equation, described by Wetmur (1991), is

$$T_m \text{ (in } ^\circ\text{C)} = (T^\circ \Delta H^\circ) / (\Delta H^\circ - \Delta G^\circ + RT^\circ \ln[c]) + 16.6 \log_{10}([\text{Na}^+] / \{1.0 + 0.7[\text{Na}^+]\}) - 269.3$$

where

$$\begin{aligned} \Delta H^\circ &= \sum_{nn} (N_{nn} \Delta H_{nn}^\circ) + \Delta H_p^\circ + \Delta H_e^\circ \\ \Delta G^\circ &= \sum_{nn} (N_{nn} \Delta G_{nn}^\circ) + \Delta G_i^\circ + \Delta G_e^\circ \\ N_{nn} &= \text{the number of nearest neighbors (e.g., 13 for a 14-mer)} \\ R &= 1.99 \text{ cal/mole-}^\circ\text{K} \\ T^\circ &= 298.2^\circ\text{K} \\ c &= \text{the total molar strand concentration} \\ [\text{Na}^+] &\leq 1 \text{ M} \end{aligned}$$

A number of the thermodynamic terms can be approximated:

$$\begin{aligned} \text{average nearest-neighbor enthalpies, } \Delta H_{nn}^\circ &= -8.0 \text{ kcal/mole} \\ \text{average nearest-neighbor free energies, } \Delta G_{nn}^\circ &= -1.6 \text{ kcal/mole} \end{aligned}$$

initiation term,  $\Delta G_i^0 = +2.2$  kcal/mole  
 average dangling end enthalpy,  $\Delta H_e^0 = -8.0$  kcal/mole/end  
 average dangling end free energy,  $\Delta G_e^0 = -1$  kcal/mole/end  
 average mismatch/loop enthalpy,  $\Delta H_p^0 = -8.0$  kcal/mole/mismatch

Note that for each mismatch or loop,  $N_{mn}$  is reduced by 2.

When the oligonucleotide is used as a probe, hybridization is usually carried out at  $\sim 5$ – $12^\circ\text{C}$  below the calculated  $T_m$ , and stringent posthybridization washing is carried out at  $\sim 5^\circ\text{C}$  below the  $T_m$ . Working so close to the calculated  $T_m$  has two consequences: (1) It reduces the number of mismatched hybrids and (2) less desirably, it reduces the rate at which perfect hybrids form.

For all practical purposes, hybrid formation between complementary DNA molecules  $>200$  nucleotides in length is an irreversible reaction when annealing is carried out at  $\sim 10^\circ\text{C}$  below the calculated  $T_m$ . The chance that such a long stretch of perfect double helix will unwind under the conditions conventionally used for hybridization ( $68^\circ\text{C}$  and  $\sim 1$  M  $[\text{Na}^+]$ ) is small. However, hybrids (even perfect hybrids) formed between short oligonucleotides and their target sequences at  $5$ – $10^\circ\text{C}$  below the  $T_m$  are far easier to unwind; thus, hybridization reactions of this type can be considered reversible. This behavior has important practical consequences. The concentration of oligonucleotide in the hybridization reaction should be high ( $0.1$ – $1.0$  pmole/ml) so that the annealing reaction rapidly reaches equilibrium within 3–8 hours. Posthybridization washing, however, should be brief (1–2 minutes) and should be carried out initially under conditions of low stringency, and then under conditions of stringency that at least equal those used for hybridization (Miyada and Wallace 1987).

## LENGTH OF OLIGONUCLEOTIDE PROBES

The longer an oligonucleotide, the higher its specificity for the target sequence. The following equations can be used to calculate the probability that a specific sequence string of nucleotides will occur within a sequence space (Nei and Li 1979).

$$K = \frac{[g/2]^{G+C} \times [(1-g)/2]^{A+T}}{N}$$

where  $K$  is the expected frequency of occurrence within the sequence space,  $g$  is the relative G+C content of the sequence space, and  $G$ ,  $C$ ,  $A$ , and  $T$  are the number of specific nucleotides in the oligonucleotide. For a double-stranded genome of size  $N$  (in nucleotides), the expected number ( $n$ ) of sites complementary to the oligonucleotide is  $n = 2NK$ .

These equations predict that an oligonucleotide of 14–15 nucleotides would be represented only once in a mammalian genome where  $N$  is  $\sim 3.0 \times 10^9$ . In the case of a 16-mer, there is only one chance in ten that a typical mammalian cDNA library (complexity  $\sim 10^7$  nucleotides) will fortuitously contain a sequence that exactly matches that of the oligonucleotide. However, these estimates are based on the assumption that the distribution of nucleotides in mammalian genomes is random. Unfortunately, this is not the case, due to bias in codon usage (Lathe 1985) and because a significant fraction of the genome is composed of repetitive DNA sequences and gene families. Because of the presence of these elements, no more than 85% of the mammalian genome can be targeted precisely, even by probes and primers that are 20 nucleotides in length (Bains 1994).

To minimize problems of nonspecific hybridization, it is advisable to use oligonucleotides longer than the statistically indicated minimum. Any clones that then hybridize to the probe are likely to be derived from the gene of interest. Bear in mind that when a cDNA library is screened

with an oligonucleotide probe, no relationship exists between the observed number of positive clones and their frequency predicted by statistics. For example, if by chance the oligonucleotide should match an expressed sequence that is abundantly represented in mRNA, the number of clones that hybridize to the probe will be much larger than theory predicts. Before synthesizing an oligonucleotide probe or primer, it is advisable to scan DNA databases to ensure that the proposed sequence occurs only in the desired gene and not in vectors, undesired genes, or repetitive elements (e.g., please see Mitsuhashi et al. 1994).

The effect of hybridization between imperfectly matched sequences cannot be easily quantified, since different types of mismatching (mispairing between single bases, loopouts on either strand, multiple mismatches, whether closely or distantly spaced) have different effects on the stability of double-stranded DNA. For example, a single mismatch in the center of a short oligonucleotide (of ~16 nucleotides in length) will destabilize the hybrid by ~7°C (Wetmur 1991) and, consequently, may attenuate the hybridization signal to a very considerable degree. On the other hand, a mismatch at the 3' end of a probe will have little effect on hybridization signal (Ikuta et al. 1987) but will greatly diminish the ability of an oligonucleotide to prime DNA synthesis.

## DEGENERATE POOLS OF OLIGONUCLEOTIDES

---

In molecular cloning, the situation frequently arises where a short sequence of amino acids has been obtained by sequencing a purified protein. Because of the degeneracy of the genetic code, many different oligonucleotides can potentially code for a given tract of amino acids. For example, 64 possible 18-mers can code for the sequence Asn Phe Tyr Ala Trp Lys. However, only one of these oligonucleotides will exactly match the coding sequence used in the gene of interest. Because there is no way to know a priori which of these oligonucleotides has its true counterpart in the gene, pools of oligonucleotides containing all potential coding combinations are synthesized and used as probes. Depending on the length of the amino acid sequence and the amount of degeneracy at each position, pools can contain up to several hundred oligonucleotides. If hybridization conditions can be found under which only perfectly matched sequences form stable duplexes, cloned copies of the gene of interest can be readily isolated from genomic or cDNA libraries (e.g., please see Goeddel et al. 1980; Agarwal et al. 1981; Sood et al. 1981; Suggs et al. 1981b; Wallace et al. 1981; Toole et al. 1984; Jacobs et al. 1985; Lin et al. 1985).

Pools of degenerate oligonucleotides are generally used to select a series of candidate clones that can then be analyzed further to identify the true target. To ensure that the target clone is represented in the initial group of candidates, screening conditions are usually chosen that allow detection of perfect hybrids formed between the most A/T-rich oligonucleotide in the pool and its potential target. Other hybrids, both perfect and imperfect, that are stable under such conditions will identify additional candidate clones.

It is easy to calculate accurately the  $T_m$  of a perfectly matched hybrid formed between a single oligonucleotide and its target sequence. However, when using pools of oligonucleotides whose members have greatly different contents of G+C, it is not feasible to estimate a consensus  $T_m$ . Because it is impossible to know which member of the pool will match the target sequence perfectly, conditions must be used that allow the oligonucleotide with the lowest content of G+C to hybridize efficiently. Usually, conditions are chosen to be 2°C below the calculated  $T_m$  of the most A/T-rich member of the pool (Suggs et al. 1981a). However, the use of such "lowest common denominator" conditions can generate false positives: Mismatched hybrids formed by oligonucleotides of higher G+C may be more stable than a perfectly matched hybrid formed by the correct oligonucleotide. In most cases, this problem is not serious, since the number of positive clones obtained by screening cDNA libraries with pools of nucleotides is quite manageable. It is

therefore easy to distinguish false positives from true positives by another test (e.g., DNA sequencing or hybridization with a second pool of oligonucleotides corresponding to another segment of amino acid sequence).

## QUARternary ALKYLAMMONIUM SALTS

---

When the number of apparent positives is unacceptably high, it is worthwhile using hybridization solvents that contain quaternary alkylammonium salts such as tetraethylammonium chloride (TEACl) or tetramethylammonium chloride (TMACl) (Melchior and von Hippel 1973; Jacobs et al. 1985, 1988; Wood et al. 1985; Gitschier et al. 1986; DiLella and Woo 1987). By binding to A/T-rich polymers (Shapiro et al. 1969), quaternary alkylammonium salts reduce the preferential melting of A:T versus G:C base pairs (Melchior and von Hippel 1973; Riccelli and Benight 1993). In TEACl or TMACl, the  $T_m$  of an oligonucleotide-DNA hybrid becomes less dependent on its base composition and more dependent on its length. By choosing a hybridization temperature appropriate for the lengths of the oligonucleotides in a pool, the effects of potential mismatches can be minimized.

It is important to obtain an accurate estimate of the  $T_m$  in TMACl or TEACl before using pools of oligonucleotides to screen cDNA or genomic libraries. Jacobs et al. (1988) measured the  $T_i$  (the irreversible melting temperature) of the hybrid formed between the probe and its target as a function of chain length for a number of oligonucleotides of different (G+C) content in solvents containing either sodium ions or tetraalkylammonium ions. Hybrids involving oligonucleotides 16 and 19 nucleotides in length melt over a smaller range of temperatures in solvents containing TMACl than in solvents containing sodium salts. For example, 16-mers melt over a 3°C temperature range in solvents containing TMACl, compared with 17°C in SSC.

The optimal temperature for hybridization is usually chosen to be 5°C below the  $T_i$  for the given chain length. The recommended temperature for 17-mers in 3 M TMACl is 48–50°C; for 19-mers, it is 55–57°C; and for 20-mers, it is 58–66°C. Two points are worth emphasizing. First, the  $T_i$  of hybrids is uniformly 15–20°C higher in solvents containing TMACl than in solvents containing TEACl. The higher  $T_i$  in solvents containing TMACl allows hybridization to be performed at temperatures that suppress nonspecific adsorption of the probe to solid supports (such as nylon membranes). Second, hybridization solvents containing TMACl do not have significant advantages over those containing sodium ions until the length of the oligonucleotide exceeds 16 nucleotides.

## GUESSMERS

---

A guessmer is a long synthetic oligonucleotide (usually 30–75 nucleotides in length), whose sequence corresponds to an amino acid sequence of 15–25 residues. Because of the degeneracy of the genetic code, many thousands of possible nucleotide sequences could code for such a sizeable tract of amino acids. Unless the designer is incredibly lucky and chooses the correct codon in every single position, the guessmer will not form a perfect hybrid with the target gene. However, because most amino acids are specified by codons that differ only in the third position, at least two of the three nucleotides of each codon are likely to be perfectly matched. In addition, the number of mismatches in the third position can be minimized by selecting codons that are used preferentially by a particular organism, organelle, or cell type. In this way, it is possible to make guessmers of sufficient length so that the detrimental effects of mismatches are outweighed by the stability of extensive tracts of perfectly matched bases.



There are no rules that guarantee selection of the correct codon at a position of ambiguity; neither is it possible to predict how many correct choices must be made to achieve success. On the basis of mathematical calculations (Lathe 1985), a probe would be expected to have at least 76% identity with the authentic gene even if all codon choices were made on a random basis. If substitutions are chosen on the statistical basis of known codon usage in the species of interest, the expected homology increases to 82%; it rises still further (to 86%) if regions lacking leucine, arginine, and serine are chosen (each of these three amino acids is specified by six codons). Clearly, as the degree of homology increases, the guessmer becomes a more specific probe for the gene of interest and forms hybrids that are stable under a wider range of hybridization conditions. If the sequences of selected genes, successfully isolated by probing with guessmers, are compared with their corresponding guessmer sequences, the (respective) homologies range from a low of 71% to a high of 97%. Unless the choice of codons is extremely unfortunate, guessmers can be designed whose homology with their target genes lies near the upper end of this range. However, in addition to overall homology, the presence of a perfectly matching sequence of contiguous nucleotides within the guessmer may also be important for success. Almost all guessmers that have been used successfully contain regions that exactly match sequences in their target genes. Although it is not possible to guarantee that a guessmer will contain an exactly matching sequence, the chances increase dramatically as the degree of overall homology rises.

#### DESIGNING A GUESSMER

- Eliminate codon choices that generate the sequence CpG between codons. This dinucleotide is significantly underrepresented in mammalian DNA (Bird 1980), and CpG occurs at the junction between codons at about one half of the expected frequency (Lathe 1985).
- Choose the codon that most commonly codes for a particular amino acid in the species under study. Comprehensive lists of relative codon frequencies in genes have been published by Wada et al. (1992) or may be found at [www.kasuzo.or.jp/codon](http://www.kasuzo.or.jp/codon) (please see Appendix 7).
- Remember that specific gene families occasionally display a marked bias for or against certain codons. For example, histone genes show a marked preference for codons enriched in A and T residues, whereas proteins expressed abundantly in yeast are biased toward a set of highly preferred codons (Bennetzen and Hall 1982) and, for example, hardly ever use the codons UCG and UAU for serine and isoleucine (Ogden et al. 1984).
- Different mammalian tissues display different patterns of codon usage (e.g., please see Newgard et al. 1986). It would therefore be worthwhile to determine the codon usage in any genes that have already been cloned and are known to be expressed in the same tissue as the gene of interest.
- At positions where the choice is between C and T and there is no strong codon preference, choose T. This rule is still somewhat controversial. There is good evidence indicating that rG:rU base pairs are more stable than rA:rC base pairs (Uhlenbeck et al. 1971). However, the extension to dG:dT base pairs (Wu 1972) has been both challenged (Smith 1983) and upheld (Martin et al. 1985).
- Examine the sequence of the proposed nucleotide for regions of internal complementarity that might reduce hybridization efficiency. Wherever possible, avoid sequences that could form stable duplexes under the conditions used for hybridization.
- Ensure that the 5'-terminal position of the oligonucleotide is not occupied by a cytosine residue. For reasons that are unknown, the efficiency of radiolabeling of oligonucleotides depends on the sequence of the oligonucleotide (van Houten et al. 1998). Oligonucleotides with a cytosine residue at their 5' termini are labeled fourfold less efficiently than oligonucleotides beginning with A or T, and sixfold less efficiently than oligonucleotides beginning with G.

It is sometimes possible to synthesize a small pool containing two to eight guessmers that includes all possible codon choices at certain amino acid positions. This kind of limited substitution is most useful when an amino acid, whose codon is highly degenerate, separates two tracts

containing only a few potential mismatches. In this way, it may be possible to generate a continuous sequence within the guessmer that is a perfect match for the target gene. However, when using a mixture of guessmers as probes, the strength of the hybridization signal generated by the "correct" probe is usually reduced. For guessmers labeled by phosphorylation or by filling of recessed ends, an eightfold reduction in signal strength typically does not compromise the identification of clones of interest.

Perhaps the most critical step in the use of guessmers is the choice of conditions for hybridization. The temperature should be high enough to suppress hybridization of the probe to incorrect sequences but must not be so high as to prevent hybridization to the correct sequence, even though it may be mismatched. Before using an oligonucleotide to screen a library, perform a series of trial experiments in which a series of northern or genomic Southern hybridizations are carried out under different degrees of stringency (Anderson and Kingston 1983; Wood et al. 1985). Lathe (1985) presents a set of theoretical curves relating the temperature of the washing solution to the length and homology of the probe. Using these curves as a guide, determine the optimal conditions for detection of sequences complementary to the probe by hybridizing the oligonucleotide to a series of nitrocellulose or nylon membranes at different temperatures. The membranes are washed extensively in 6x SSC at room temperature and then briefly (5–10 minutes in 6x SSC) at the temperature used for hybridization. This method, in which both hybridization and washing are carried out under the same conditions of temperature and ionic strength, appears to be more discriminating than the more commonly used procedure of hybridizing under conditions of lower stringency and washing under conditions of higher stringency. If trial experiments are not possible, estimate the melting temperature ( $T_m$ ) as follows:

1. Calculate the minimum G+C content of the oligonucleotide, assuming that A or T is present at all positions of ambiguity.
2. Use the following formula to calculate the  $T_m$  of a double-stranded DNA with the calculated G+C content:

$$T_m = 81.5^\circ\text{C} + 16.6 (\log_{10}[\text{Na}^+]) + 0.41(\%[\text{G+C}]) - (500/n)$$

where  $n$  is the number of nucleotides. The term  $500/n$  is derived from a compilation (Hall et al. 1980) of measurements, from several laboratories, of the effect of duplex length on melting temperature. This formula only works for  $\text{Na}^+$  concentrations of 1.0 M or less.

3. Calculate the maximum amount of possible mismatches assuming that all choices of degenerate codons are incorrect. Subtract  $1^\circ\text{C}$  from the calculated  $T_m$  for each 1% of mismatch. The resulting number should be the  $T_m$  of a maximally mismatched hybrid formed between the probe and its target DNA sequence.

Almost certainly, the actual  $T_m$  will be higher than that predicted by this worst-case calculation. If the bases used at positions of ambiguity were chosen at random, one out of four should be correct, and approximately half of these would be expected to be G or C. The observed  $T_m$  should therefore be significantly higher than that estimated. However, to minimize the risk of missing the clone of interest, it is best to hybridize and wash at 5–10°C below the  $T_m$  estimated as described above. If, under these conditions, the probe hybridizes indiscriminately, repeat the hybridization at a higher temperature or wash under conditions of higher stringency.

Guessmers reached their height of popularity in the mid 1980s, a time when the fledgling recombinant DNA companies were desperately trying to clone genes of commercial value. cDNA and genomic clones of many useful genes were obtained during this period. In recent years, how-

ever, guessmers have been eclipsed by probes generated in PCRs using sets of redundant primers. This is chiefly because PCR-based methods require far shorter tracts of unambiguous amino acid sequence. Nevertheless, when an amino acid sequence of sufficient length is available, guessmers remain the probes of choice. They have a strong track record of success and are free of the artifacts that PCR can visit upon even the best of investigators.

## UNIVERSAL BASES

Universal bases have reduced hydrogen-bonding specificity and can therefore "pair" with natural bases at positions of ambiguity without disrupting the DNA duplex. For several years, the "universal" base of choice has been the purine nucleoside inosine, whose neutral base, hypoxanthine, forms stable base pairs with cytosine, thymine, and adenine. Because of the absence of a 2-amino group, base pairing between inosine and cytosine involves two hydrogen bonds (as in A:T base pairs) instead of the three that occur in C:G base pairs (Corfield et al. 1987; Xuan and Weber 1992). In most other respects, however, inosine behaves like guanosine:

- Inosine occurs naturally in the first (wobble) position of some tRNAs, where it pairs with adenosine in addition to cytidine and uridine, the nucleosides that normally pair with guanosine in that position (Crick 1966).
- Inosine is able to occupy the middle position of the anticodon where it again pairs with adenosine (Davis et al. 1973). However, in inosine:adenosine pairs in B-DNA duplexes, inosine adopts a *trans* (anti) orientation with respect to the furanose moiety, whereas adenosine is in the *syn* configuration (Corfield et al. 1987). This is similar to the arrangement that is formed when guanosine mispairs with adenosine (Brown et al. 1986).
- Poly(rI) and poly(dI) form helices with poly(rC) and poly(dC) that are stable enough to serve as templates utilized by various RNA and DNA polymerases. The enzymes can incorporate cytosine into the polymerization products (for review, please see Felsenfeld and Miles 1967; Hall et al. 1985).

Pools of synthetic oligonucleotides and guessmers containing inosine have been used extensively as hybridization probes to screen cDNA or genomic libraries for genes encoding proteins whose amino acid sequence is only partly known. However, although inosine is able to form hydrogen bonds with the three other nucleotides, the resulting base pairs are less stable than the equivalent guanosine-containing base pairs (Martin et al. 1985). The melting temperatures of duplexes containing inosine vary widely depending on the base to which the analog is paired and on the surrounding sequence. In the worst case, the melting temperature of synthetic oligonucleotide duplexes containing inosine opposite any base may be depressed by 15°C, which corresponds to a difference in base pair stability of 2–3 kcal mole<sup>-1</sup> (Martin et al. 1985; Kawase et al. 1986). Although this situation is less than ideal, it has surprisingly few practical consequences: Inosine-containing oligonucleotides have been used successfully to clone many genes from genomic and cDNA libraries of high complexity (e.g., please see Jaye et al. 1983; Ohtsuka et al. 1985; Takahashi et al. 1985; Bray et al. 1986; Nagata et al. 1986).

Table 10-1 contains a list of codons that are recommended when designing oligonucleotides that are to be used to screen primate or mammalian cDNA libraries and that contain inosine at positions of ambiguity. The recommendations take into account the natural usage of codons in human genes and the fact that the sequence CpG is underrepresented in human DNA.

**TABLE 10-1** Inosine-containing Codons Recommended for Use in Oligonucleotide Probes

AMINO ACID	CODON	AMINO ACID	CODON
A (Ala)	GCI	M (Met)	ATG
C (Cys)	TGC <sup>a</sup>	N (Asn)	AAC <sup>a</sup>
D (Asp)	GAT	P (Pro)	CCI
E (Glu)	GAI	Q (Gln)	CAI
F (Phe)	TTC <sup>a</sup>	R (Arg)	CGI <sup>c</sup>
G (Gly)	GGI	S (Ser)	TCC <sup>b,c</sup>
H (His)	CAC <sup>a</sup>	T (Thr)	ACI
I (Ile)	ATI	V (Val)	GTI
K (Lys)	AAI	W (Trp)	TGG
L (Leu)	CTI <sup>c</sup>	Y (Tyr)	TAC <sup>a</sup>

<sup>a</sup>If the first nucleotide of the succeeding codon is G, use T in the third position.

<sup>b</sup>If the first nucleotide of the succeeding codon is G, use I in the third position.

<sup>c</sup>Try to avoid amino acids with six codons if at all possible.

## HYBRIDIZATION OF OLIGONUCLEOTIDES THAT CONTAIN A NEUTRAL BASE AT POSITIONS OF DEGENERACY

Although the conditions for hybridization of probes that contain the neutral base inosine have not been extensively explored, it is possible to make a conservative estimate of the  $T_m$  as follows:

- Subtract the number of inosine residues from the total number of nucleotides in the probe to give a value  $S$ .
- Calculate the G+C content of  $S$ .
- Estimate the  $T_m$  of a perfect hybrid involving  $S$  using either the Wallace rule, the Baldino algorithm, or the Wetmur equation.
- Use conditions for hybridization that are 15–20°C below the estimated  $T_m$ .

The  $T_m$  of hybrids involving oligonucleotides that contain neutral bases can also be estimated empirically as described in Protocol 9. Oligonucleotides containing inosine can be used with washing buffers containing TMAcI or TEAcI (e.g., please see Andersson et al. 1989).

## WORKING WITH OLIGONUCLEOTIDES

In the following protocols, we describe several methods to purify synthetic oligonucleotides, to radiolabel oligonucleotides, their use as hybridization probes, and how to determine empirically the melting temperature of an oligonucleotide-target duplex. The chapter concludes with information panels on oligonucleotide synthesis, melting temperatures, and methods of oligonucleotide purification.

*Science and technology multiply around us. To an increasing extent they dictate the languages in which we speak and think. Either we use those languages, or we remain mute.*

J.G. Ballard

# Protocol 1

---

## Purification of Synthetic Oligonucleotides by Polyacrylamide Gel Electrophoresis

**S**O EFFICIENT ARE PRESENT-DAY AUTOMATED DNA SYNTHESIZERS that oligonucleotides up to ~25 nucleotides in length generally do not contain significant quantities of truncated DNA fragments and hence do not require purification by gel electrophoresis. Purification is also unnecessary when oligonucleotides >25 nucleotides in length are used as hybridization probes or in other circumstances where an oligonucleotide of exact length is not required (please see Chapters 3, 6, and 14).

The longer the oligonucleotide, the greater the chance that it will be contaminated to a significant degree with the by-products of incomplete synthesis. As a rule of thumb, oligonucleotides >25 nucleotides long should be purified by polyacrylamide gel electrophoresis, as should oligonucleotides of any length that yield anomalous results in experiments where the exact length of the oligonucleotide is important, for example, in primer extension experiments to map the 5' termini of mRNAs (please see Chapter 7, Protocol 12), as a sequencing primer (Chapter 12, Protocols 3–6), to amplify microsatellite markers in mammalian genomes (please see Chapter 8), and as a probe in gel retardation assays (Chapter 17, Protocol 2).

After electrophoresis, the oligonucleotide is eluted from the gel and concentrated by:

- **Ethanol precipitation.** This procedure works efficiently provided the volume of the filtered eluate (please see Step 17 of this protocol) is reduced by repeated extractions with *n*-butanol and the oligonucleotide is longer than 18 nucleotides (please see Appendix 8).
- **Reversed-phase chromatography** on Sep-Pak C<sub>18</sub> columns (detailed in this protocol). These columns are available in prepacked form and are easy to use when fitted to the end of a syringe barrel. Isolation on Sep-Pak C<sub>18</sub> columns takes longer than ethanol precipitation, but it works efficiently with oligonucleotides of all lengths and yields preparations of higher purity.

The method detailed in this protocol is used to purify crude synthetic oligonucleotides by electrophoresis through denaturing polyacrylamide gels; it is a modification of a procedure developed in Michael Smith's laboratory (University of British Columbia, Vancouver, British Columbia) that has been in use for more than 20 years. The method for recovery of oligonucleotides from polyacrylamide gels was provided by Jeffrey Cormier (University of Texas Southwestern Medical Center, Dallas). For additional ways of purifying oligonucleotides, please see the information panel on **METHODS USED TO PURIFY SYNTHETIC OLIGONUCLEOTIDES**.

## MATERIALS

**CAUTION:** Please see Appendix 12 for appropriate handling of materials marked <!>.

### Buffers and Solutions

**Please see Appendix 1 for components of stock solutions, buffers, and reagents.**

**Dilute stock solutions to the appropriate concentrations.**

**The use of sterile, filtered H<sub>2</sub>O (Milli-Q or equivalent) is recommended.**

#### *Acetonitrile <!>*

Use 10 ml of high-performance liquid chromatography (HPLC)-grade acetonitrile for each Sep-Pak column.

#### *Ammonium acetate (10 M)*

Use 2 ml of 10 mM ammonium acetate solution for each Sep-Pak column.

#### *n-Butanol <!>*

#### *Formamide gel-loading buffer without tracking dyes <!>*

Gel-loading buffer consists of undiluted formamide without the usual tracking dyes (bromophenol blue and/or xylene cyanol FF). Do not add tracking dyes to the gel-loading buffer; the dyes or contaminants in them may migrate at the same rate as the oligonucleotide and interfere with its detection by absorption of UV light (please see Step 14 of protocol). If desired, 0.2% orange G can be included in the gel-loading buffer. This dye migrates with the buffer front and does not interfere with detection of the oligonucleotide.

#### *Formamide-tracking dye mixture*

This solution is a 50:50 mixture of formamide and an aqueous solution of tracking dyes (0.05% xylene cyanol FF and 0.05% bromophenol blue). It is used as a size standard in wells adjacent to those containing the oligonucleotide preparation.

#### *Methanol:H<sub>2</sub>O solution <!>*

Combine 6 ml of methanol with 4 ml of filter-sterilized Milli-Q H<sub>2</sub>O. Use 3 ml of methanol:H<sub>2</sub>O solution for each Sep-Pak column.

#### *Oligonucleotide elution buffer*

0.5 M ammonium acetate

10 mM magnesium acetate

Some investigators include 0.1% (w/v) SDS in the oligonucleotide elution buffer. This is not advisable if the eluted oligonucleotide is to be purified by Sep-Pak C<sub>18</sub> chromatography (please see the note at Step 16).

*TE (pH 8.0)*

### Nucleic Acids and Oligonucleotides

#### *Crude preparation of synthetic oligonucleotide*

Synthetic oligonucleotides are usually supplied by the manufacturer as a lyophilized powder after removal of protecting groups used in the synthetic reactions (please see the information panel on **OLIGONUCLEOTIDE SYNTHESIS**). Deprotection usually involves heating the preparation at 55°C for ~5 hours in concentrated solutions of NH<sub>4</sub>OH <!>. (Some more recent DNA synthesis protocols use a different protecting group on one or more nucleosides [e.g., acetyl-protected dC] that can be removed in <10 minutes.)

Before purifying an oligonucleotide, confirm that the deprotection reaction has been carried out. If the oligonucleotide is supplied in NH<sub>4</sub>OH, transfer 0.5–1.0-ml aliquots to 1.5-ml microfuge tubes and evaporate the NH<sub>4</sub>OH to dryness on a centrifugal evaporator (Savant SpeedVac or its equivalent) at room temperature.

When opening a tube of crude oligonucleotide for the first time, vent the tube by opening it *slowly* to allow ammonia gas to escape (preferably into a chemical fume hood). This reduces the chance of spraying the oligonucleotide around the room.

### Special Equipment

*Millex HV filter (Millipore, 0.45-μm pore size)*

*Parafilm or Fluorescent thin-layer chromatographic plate*

Plates may be purchased from Brinkmann in the United States or from E. Merck in Europe as Merck Silica gel F<sub>254</sub>, 20 × 20-cm plates.

*Sep-Pak classic columns, short body*

Sep-Pak classic columns (available from the Waters Division of Millipore) contain 360 mg/column of a hydrophobic (C<sub>18</sub>) reversed-phase chromatography resin. The separation principle makes use of the fact that the oligonucleotide adsorbs to the column when the polarity of the solvent is high (e.g., aqueous buffers) and elutes from the resin when the polarity of the solvent is reduced (e.g., a mixture of methanol and H<sub>2</sub>O). One column is required per 10 OD<sub>260</sub> units of oligonucleotide loaded onto the polyacrylamide gel.

*Syringes (5-cc and 10-cc polypropylene)*

One 5-cc and one 10-cc syringe are required for each oligonucleotide to be purified.

*Ultraviolet lamp (260 nm, hand-held) <!>*

*Water bath or heating block preset to 55°C*

**Additional Reagents**

*Steps 7–9 of this protocol require the reagents listed in Chapter 12, Protocols 8 and 11.*

**METHOD****Preparation of Crude Synthetic Oligonucleotides for Gel Electrophoresis**

1. In a sterile microfuge tube, prepare a 10 μM solution of the crude oligonucleotide in sterile, filtered H<sub>2</sub>O (Milli-Q or equivalent). Vortex the solution thoroughly.

The solution is often slightly cloudy because of the presence of insoluble benzamides generated during the synthesis of the oligonucleotide.

2. Centrifuge the tube at maximum speed for 5 minutes at room temperature in a microfuge. Transfer the supernatant to a fresh, sterile microfuge tube.
3. Extract the solution three times in succession with 400 μl of *n*-butanol (please see Appendix 8). Discard the upper (organic) phase after each extraction.

If time is short, the extraction with *n*-butanol can be omitted without necessarily causing problems. In this case, centrifuge the solution at maximum speed for 5 minutes at room temperature in a microfuge, and transfer the supernatant to a fresh, sterile microfuge tube. Load 10–30 μl of this solution onto each of six slots (1-cm) of a denaturing polyacrylamide gel as described later in this protocol.

4. Evaporate the solution to dryness in a centrifugal evaporator (Savant SpeedVac or its equivalent). The tube should contain a yellowish pellet and a creamy-white powder.
5. Dissolve the pellet and powder in 200 μl of sterile filtered H<sub>2</sub>O (Milli-Q or equivalent).
6. Estimate the amount of oligonucleotide in the preparation as follows: Add 1 μl of the solution to 1 ml of H<sub>2</sub>O. Mix the solution well and read the OD<sub>260</sub>. Calculate the oligonucleotide concentration.

Amounts of oligonucleotides are often described in OD units. One OD corresponds to the amount of oligonucleotide in a 1-ml volume that results in an optical density of 1 in a 1-cm path-length cuvette.

Calculate the millimolar extinction coefficient of the oligonucleotide ( $\epsilon$ ) from the following equation:

$$\epsilon = A(15.2) + G(12.01) + C(7.05) + T(8.4)$$

where *A*, *G*, *C*, and *T* are the number of times each nucleotide is represented in the sequence of the oligonucleotide. The numbers in parentheses are the molar extinction coefficients for each deoxynucleotide at pH 8.0.

For example, a 19-mer containing 5 dA residues, 4 dG residues, 4 dC residues, and 6 dT residues would have a millimolar extinction coefficient of

$$(5 \times 15.2) + (4 \times 12.01) + (4 \times 7.05) + (6 \times 8.4) = 202.64 \text{ mM}^{-1} \text{ cm}^{-1}$$

Calculate the concentration ( $c$ ) of the undiluted solution of oligonucleotide from the following equation:

$$c = (\text{OD}_{260})(1000)/\epsilon$$

## Purification of Synthetic Oligonucleotides Using Gel Electrophoresis

7. Pour a denaturing polyacrylamide gel (as described in Chapter 12, Protocol 8) of the appropriate concentration (Table 10-2). The loading slots in the gel should be ~1 cm in length.
8. Run the gel at constant wattage (50–70 W) for ~45 minutes or until the temperature of the gel reaches 45–50°C. Turn off the power supply and disconnect the electrodes.
 

Prerunning the gel in this way causes ammonium persulfate to migrate from the wells and, more importantly, warms the gel to a temperature optimal for electrophoresis of DNA.
9. Without delay, load ~2 OD<sub>260</sub> units of oligonucleotide (in a volume of 10 µl or less for maximum resolution) onto one or more slots of the gel as follows:
  - a. Add an equal volume of formamide gel-loading buffer lacking dyes to the oligonucleotide solution. Mix the reagents well by vortexing, and then heat the mixture to 55°C for 5 minutes to disrupt secondary structure.
  - b. Flush out the urea from the wells with 1× TBE.
  - c. Load the heated oligomer into the slots. Load 5 µl of formamide-tracking dye mixture into an unused slot.
 

For further details on loading polyacrylamide gels, please see Chapter 12, Protocol 11.
10. Run the gel at 1500 V until the oligonucleotide has migrated approximately two thirds of the length of the gel.
 

The position of the oligonucleotide may be estimated from the positions of the tracking dyes as detailed in Table 10-3. Note that a synthetic oligonucleotide carrying a hydroxyl residue at its 5' terminus migrates more slowly through a denaturing polyacrylamide gel than does a phosphorylated oligonucleotide of equivalent length. Furthermore, for reasons that are not fully understood, the electrophoretic mobility of an oligonucleotide is dependent on its base composition and sequence. Thus, there may not be an exact correspondence between the predicted and observed positions of the oligonucleotide in the polyacrylamide gel.
11. Lay the gel mold flat on plastic-backed protective bench paper with the smaller (notched) plate uppermost. Allow the gel to cool to <37°C before proceeding.
12. Remove any remaining pieces of electrical tape. Use a spacer or a plate-separating tool to slowly and gently pry apart the plates of the mold. The gel should remain attached to the longer (nonsiliconized) glass plate.
 

▲ **WARNING** Wear safety glasses. Glass plates may chip during this procedure.

**TABLE 10-2** Range of Resolution of Gels Containing Different Concentrations of Acrylamide

ACRYLAMIDE (%)	SIZE OF OLIGONUCLEOTIDES (IN BASES)
20–30	2–8
15–20	8–25
13–15	15–35
10–13	35–45
8–10	45–70
6–8	70–300



**TABLE 10-3** Approximate Lengths of Oligonucleotides Comigrating with Tracking Dyes

POLYACRYLAMIDE (%)	XYLENE CYANOL FF	BROMOPHENOL BLUE
20	22	6
15	30	9-10
12	40	~15

If the gel adheres to both plates, replace the partially dislodged, smaller or notched plate back on the gel, invert the plates, and try again.

13. Place a piece of Saran Wrap on the gel, turn the glass plate over, and transfer the gel to the Saran Wrap. Place a piece of Parafilm or a fluorescent thin-layer chromatographic plate under the gel where the oligonucleotide is predicted to be.
14. Use a hand-held UV lamp to examine the gel by illumination from above at 260 nm.  
The DNA in the gel absorbs the UV radiation and appears as dark blue bands against a uniform fluorescent background contributed by the Parafilm or chromatographic plate. If the DNA is difficult to visualize, take the gel into a darkened room and illuminate it with the hand-held UV lamp.
15. Recover the desired oligonucleotide, which should be the slowest-migrating band (i.e., closest to the top of the gel), by excising each DNA band with a sharp, clean scalpel or razor blade. Avoid taking UV-absorbing material smaller in length than the desired oligonucleotide.  
For additional information on excising the desired band of DNA, please see the panel on **VISUALIZING OLIGONUCLEOTIDES IN POLYACRYLAMIDE GELS** at the end of this protocol.
16. Transfer the gel slices to three or four microfuge tubes. Add 1 ml of oligonucleotide elution buffer to each tube. Crush the slices with a disposable pipette tip, using a circular motion and pressing the fragments of gel against the sides of the tubes. Seal the tubes well. Incubate the tubes for 12 hours at 37°C in a shaker incubator.  
Inclusion of SDS in the elution buffer can sometimes lead to the appearance of a whitish precipitate after drying down fractions 2 and 3 from the Sep-Pak column used in the final stage of this protocol. This precipitate is most likely SDS, which binds to the column and elutes slightly after the oligonucleotide during washing with methanol:H<sub>2</sub>O. As long as no SDS is present with the oligonucleotide (fraction 1), the detergent will not cause problems and may improve yields. However, if even a small amount of SDS ends up in the oligonucleotide fraction, then it can inhibit subsequent enzymatic reactions (e.g., phosphorylation and primer extension). It is for this reason that SDS *should not be included* in the elution buffer.
17. Centrifuge the tubes at maximum speed for 5 minutes at room temperature in a microfuge. Pool the supernatants, transfer them to a 5-cc disposable syringe and pass them through a Millex HV filter. Collect the effluent in a 15-ml polypropylene tube.

### Isolation of Synthetic Oligonucleotides by Sep-Pak C<sub>18</sub> Chromatography

18. Prepare a Sep-Pak C<sub>18</sub> reversed-phase column as follows:
  - a. Attach the barrel of a disposable 10-cc polypropylene syringe to the longer end of a Sep-Pak C<sub>18</sub> classic column.
  - b. Add 10 ml of acetonitrile to the barrel and slowly push it through the column with the plunger of the syringe.
  - c. *Remove the syringe from the Sep-Pak column and then take the plunger out of the barrel.* This prevents air being pulled back into the column. Reattach the barrel to the column.
  - d. Add 10 ml of sterile filtered H<sub>2</sub>O (Milli-Q or equivalent) to the barrel and slowly push it through the column with the plunger. Repeat Step c.

- e. Add 2 ml of 10 mM ammonium acetate to the barrel and push it slowly through the column. Again remove the syringe, remove the barrel, and reattach the barrel to the column. The column is now ready for use.
19. Add the solution containing the gel-purified oligonucleotide (from Step 17) to the barrel and slowly push it through the column with the plunger. Collect the effluent in a sterile 50-ml polypropylene tube. Repeat Step 18c.
20. Add 10 ml of H<sub>2</sub>O to the barrel and push it slowly through the column with the plunger. Repeat this wash step twice more.
21. Elute the bound oligonucleotide from the Sep-Pak column with three aliquots of 1 ml of methanol:H<sub>2</sub>O solution. Repeat Step 18c after each elution. Collect each effluent in a separate microfuge tube. Read the OD<sub>260</sub> of the solution in each of the three microfuge tubes, using the methanol:H<sub>2</sub>O solution as a blank. More than 90% of the oligonucleotide applied to the column should elute in the first fraction.
22. Evaporate the solution containing the oligonucleotide to dryness in a centrifugal evaporator.
23. Dissolve the oligonucleotide in a total volume of 200 µl of H<sub>2</sub>O or TE (pH 8.0).
24. Transfer 5 µl of the solution to a cuvette containing 995 µl of H<sub>2</sub>O. Mix the contents of the cuvette, and read the OD<sub>260</sub> of the diluted sample. Calculate the amount of oligonucleotide present in the total solution (Step 23) as described in Step 6 of this protocol.

#### VISUALIZING OLIGONUCLEOTIDES IN POLYACRYLAMIDE GELS

Preparations of oligonucleotides that are <25 bases in length generally contain only one band that is strong enough to be detected by illuminating the gel with UV light. This is because the efficiency of each coupling step in the synthesis is remarkably high (usually  $\geq 95\%$ ) in present-day automated DNA synthesizers. Truncated oligonucleotides may be visible if the efficiency of coupling decreases below 80% at one or more steps during the synthesis, because of reagent contamination, a block in one of the delivery lines, exhaustion of a particular nucleotide phosphoramidite, or an unusual secondary structure in the oligonucleotide. Products of incomplete synthesis are detected as faster-migrating species, whose lengths correspond to the synthetic step at which difficulty was encountered. Occasionally, a small number of faster-migrating products are detected whose absorbance is equal to or greater than the full-length synthetic product. Provided enough full-length product is detected, the shorter products can be ignored. If not, then larger amounts of the DNA preparation must be used to purify the oligonucleotide of interest.

Preparations of very long oligonucleotides may contain a ladder of prematurely truncated species extending upward from  $\sim 30$  nucleotides in size. The slowest-migrating species is usually the desired product. Very occasionally, however, an oligonucleotide may migrate anomalously, traveling further through the gel than its shorter siblings. Keep in mind that sequence differences between the members of pools of redundant oligonucleotides can cause individual DNAs to migrate at slightly different rates, giving rise to a single broad band or to a cluster of closely spaced bands. In these situations, when the spacing of bands is anomalous, or the bands are smeared, it is best to take a conservative approach by extracting all closely spaced bands from the relevant region of the gel.

If a broad smear of bands of approximately equal intensity is produced when purifying an oligonucleotide of unique sequence, it is best to resynthesize the oligonucleotide. In this case, the efficiency of coupling can sometimes be checked by reading the concentration of trityl groups at different stages of the synthetic reaction. However, because of the large numbers of oligonucleotides produced, most core facilities do not keep records of the trityl concentrations even though the synthesizer may be equipped with an in-line measuring device.

Finally, keep in mind that the detection limit for UV light shadowing is  $\sim 0.5$  OD<sub>260</sub> unit. If amounts of oligonucleotide less than this quantity are to be purified (e.g., when purifying oligonucleotides >70 bases), consider radiolabeling the preparation by phosphorylation as described in Protocol 2.

# Protocol 2

---

## Phosphorylating the 5' Termini of Oligonucleotides

**S**YNTHETIC OLIGONUCLEOTIDES LACK PHOSPHATE GROUPS at their 5' termini and therefore are easily radiolabeled by transferring the  $\gamma$ - $^{32}\text{P}$  from  $[\gamma\text{-}^{32}\text{P}]\text{ATP}$  in a reaction catalyzed by bacteriophage T4 polynucleotide kinase. Oligonucleotides radiolabeled in this way are used as hybridization probes, primers for DNA sequencing and 5'-end mapping of mRNAs, and primers for analysis of polymorphic microsatellite markers in mammalian DNA.

When the reaction is carried out under standard conditions, >50% of the oligonucleotide molecules become radiolabeled. However, for reasons that are unknown, the efficiency of radiolabeling of oligonucleotides depends on the sequence of the oligonucleotide (van Houten et al. 1998). Oligonucleotides with a cytosine residue at their 5' termini are labeled fourfold less efficiently than oligonucleotides beginning with A or T, and sixfold less efficiently than oligonucleotides beginning with G. When designing oligonucleotide probes, it clearly pays to ensure that the 5'-terminal position is not occupied by a cytosine residue.

The reaction described here is designed to label 10 pmoles of an oligonucleotide to high specific activity. Labeling of different amounts of oligonucleotide can easily be achieved by increasing or decreasing the size of the reaction, while keeping the concentrations of all components constant. Similar reaction conditions can be used to add a nonradiolabeled phosphate to the 5' end of a synthetic oligonucleotide before its use in site-directed mutagenesis (please see Chapter 13, Protocols 2–6).

### MATERIALS

---

**CAUTION:** Please see Appendix 12 for appropriate handling of materials marked with <!>.

#### Buffers and Solutions

Please see Appendix 1 for components of stock solutions, buffers, and reagents. Dilute stock solutions to the appropriate concentrations.

10x Bacteriophage T4 polynucleotide kinase buffer  
Tris-Cl (1 M, pH 8.0)

#### Enzymes and Buffers

*Bacteriophage T4 polynucleotide kinase*

Wild-type polynucleotide kinase is a 5'-phosphotransferase and a 3'-phosphatase (Depew and Cozzarelli 1974; Sirotkin et al. 1978). However, mutant forms of the enzyme (e.g., please see Cameron et al. 1978)

are commercially available (e.g., Boehringer Mannheim) that lack the phosphatase activity but retain a fully functional phosphotransferase. We recommend that the mutant form of the enzyme be used for 5' labeling whenever possible; 10–20 units of the enzyme are required to catalyze the phosphorylation of 10–50 pmoles of dephosphorylated 5'-protruding termini.

▲ **IMPORTANT** Be aware that preparations of polynucleotide kinase sold by different manufacturers have been reported to vary widely in their ability to catalyze the phosphorylation of the 5' termini of single-stranded synthetic oligonucleotides (van Houten et al. 1998).

## Nucleic Acids and Oligonucleotides

### Oligonucleotide

To achieve maximum efficiency of labeling, purify the oligonucleotide by reversed-phase chromatography as described in Protocol 1. Crude preparations of oligonucleotides are labeled with lower efficiency in reactions catalyzed by polynucleotide kinase (van Houten et al. 1998). When using unpurified preparations of oligonucleotide, make sure that the last cycle of synthesis was programmed to be "trityl-off," i.e., that the dimethoxytrityl blocking group at the 5' end of the oligonucleotide primer was removed before release of the DNA from the solid synthesis support. The dimethoxytrityl group efficiently protects the 5'-hydroxyl group of the oligonucleotide from 5' modification.

## Radioactive Compounds

$[\gamma\text{-}^{32}\text{P}]\text{ATP}$  (10 mCi/ml, sp. act. >5000 Ci/mmole) in aqueous solution <math>\langle ! \rangle</math>

10 pmoles of  $[\gamma\text{-}^{32}\text{P}]\text{ATP}$  is required to label 10 pmoles of dephosphorylated 5' termini to high specific activity. To minimize problems caused by radiolysis of the precursor and the probe, it is best, whenever possible, to prepare radiolabeled probes on the day the  $[\text{}^{32}\text{P}]\text{ATP}$  arrives in the laboratory.

## Special Equipment

Microfuge tubes (0.5 ml)

Water bath preset to 68°C

## Additional Reagents

Step 4 of this protocol requires the reagents listed in Chapter 13, Protocol 7 or the reagents listed in Protocol 5 of this chapter.

## METHOD

### 1. Set up a reaction mixture in a 0.5-ml microfuge tube containing:

synthetic oligonucleotide (10 pmoles/ $\mu\text{l}$ )	1 $\mu\text{l}$
10x bacteriophage T4 polynucleotide kinase buffer	2 $\mu\text{l}$
$[\gamma\text{-}^{32}\text{P}]\text{ATP}$ (10 pmoles, sp. act. >5000 Ci/mmole)	5 $\mu\text{l}$
$\text{H}_2\text{O}$	11.4 $\mu\text{l}$

Mix the reagents well by gentle but persistent tapping on the outside of the tube. Place 0.5  $\mu\text{l}$  of the reaction mixture in a tube containing 10  $\mu\text{l}$  of 10 mM Tris-Cl (pH 8.0). Set aside the tube for use in Step 4.

The reaction contains equal concentrations of  $[\gamma\text{-}^{32}\text{P}]\text{ATP}$  and oligonucleotide. Generally, only 50% of the radiolabel is transferred to the oligonucleotide. The *efficiency of transfer* can be improved by increasing the concentration of oligonucleotide in the reaction by a factor of 10. This increase results in transfer of ~90% of the radiolabel to the oligonucleotide. However, the *specific activity* of the radiolabeled DNA is reduced by a factor of ~5. To label an oligonucleotide to the highest specific activity:

- Increase the concentration of  $[\gamma\text{-}^{32}\text{P}]\text{ATP}$  in the reaction by a factor of 3 (i.e., use 15  $\mu\text{l}$  of radiolabel and decrease the volume of  $\text{H}_2\text{O}$  to 1.4  $\mu\text{l}$ ).
- Decrease the amount of oligonucleotide to 3 pmoles.

Under these circumstances, only ~10% of the radiolabel is transferred, but a high proportion of the oligonucleotide becomes radiolabeled.

Ideally, ATP should be in a fivefold molar excess over DNA 5' ends, and the concentration of DNA termini should be  $\geq 0.4 \mu\text{M}$ . The concentration of ATP in the reaction should therefore be  $> 2 \mu\text{M}$ , but this is rarely achievable in practice.

2. Add 10 units (~1  $\mu\text{l}$ ) of bacteriophage T4 polynucleotide kinase to the remaining reaction mixture. Mix the reagents well, and incubate the reaction mixture for 1 hour at 37°C.
3. At the end of the incubation period, place 0.5  $\mu\text{l}$  of the reaction in a second tube containing 10  $\mu\text{l}$  of 10 mM Tris-Cl (pH 8.0). Heat the remainder of the reaction for 10 minutes at 68°C to inactivate the polynucleotide kinase. Store the tube containing the heated reaction mixture on ice.
4. Before proceeding, determine whether the labeling reaction has worked well by measuring the fraction of the radiolabel that has been transferred to the oligonucleotide substrate in a small sample of the reaction mixture. Transfer a sample of the reaction (exactly 0.5  $\mu\text{l}$ ) to a fresh tube containing 10  $\mu\text{l}$  of 10 mM Tris-Cl (pH 8.0). Use this sample (along with the two aliquots set aside in Steps 1 and 3) to measure the efficiency of transfer of the  $\gamma\text{-}^{32}\text{P}$  from ATP by one of the following methods:
  - Measure the proportion of the radiolabel that binds to DE-81 filters. Oligonucleotides bind tightly to the positively charged filters, whereas  $[\gamma\text{-}^{32}\text{P}]\text{ATP}$  does not. For details of this method, please see Chapter 13, Protocol 7.

*or*

  - Measure the efficiency of the labeling reaction by estimating the fraction of label that migrates with the oligonucleotide during size-exclusion chromatography through Sephadex G-15 or Bio-Rad P-60 columns. For details of this method, please see Protocol 5 of this chapter. In some ways, this is the easier of the two methods because the relative amounts of incorporated and unincorporated radioactivity can be estimated during chromatography on a hand-held minimonitor.
5. If the specific activity of the oligonucleotide is acceptable, purify the radiolabeled oligonucleotide as described in Protocol 3, 4, 5, or 6.

If the specific activity is too low, add an additional 8 units of polynucleotide kinase, continue incubation for a further 30 minutes at 37°C (i.e., a total of 90 minutes), heat the reaction for 10 minutes at 68°C to inactivate the enzyme, and analyze the products of the reaction again, as described in Step 4.

If an additional round of phosphorylation fails to yield an oligonucleotide of sufficiently high specific activity for the tasks at hand, check whether the oligonucleotide contains a cytosine residue at its 5' terminus. If so, consider redesigning the oligonucleotide so that it contains a G, A, or T residue at its 5' end (please see the introduction to this protocol). Alternatively, try purifying the original preparation of oligonucleotide by Sep-Pak chromatography (Protocol 1), and then repeat this protocol.

# Protocol 3

---

## Purification of Radiolabeled Oligonucleotides by Precipitation with Ethanol

**I**F RADIOLABELED OLIGONUCLEOTIDES ARE TO BE USED ONLY AS PROBES in hybridization experiments, then complete removal of unincorporated radiolabel is generally not necessary. However, to reduce background to a minimum, the bulk of the unincorporated radioactivity should be separated from the radiolabeled oligonucleotide. Most of the residual radioactive precursors can be removed from the preparation by differential precipitation with ethanol if the oligonucleotide is more than 18 nucleotides in length (this protocol) or with cetylpyridinium bromide, regardless of the length of the oligonucleotide (Protocol 4). If complete removal of the unincorporated radiolabel is required (e.g., when the radiolabeled oligonucleotide will be used in primer extension reactions), then chromatographic methods (Protocols 5 and 6) or gel electrophoresis (essentially as described in Protocol 1) should be used.

### MATERIALS

---

**CAUTION:** Please see Appendix 12 for appropriate handling of materials marked with <!>.

#### Buffers and Solutions

Please see Appendix 1 for components of stock solutions, buffers, and reagents.  
Dilute stock solutions to the appropriate concentrations.

*Ammonium acetate (10 M)*

*Ethanol*

*TE (pH 7.6)*

#### Nucleic Acids and Oligonucleotides

*Radiolabeled oligonucleotide <!>*

The starting material for purification is the reaction mixture from Protocol 2 (either Step 3 or Step 5), after it has been heated to 68°C to inactivate bacteriophage T4 polynucleotide kinase.

## METHOD

---

1. Add 40  $\mu\text{l}$  of  $\text{H}_2\text{O}$  to the tube containing the radiolabeled oligonucleotide. After mixing, add 240  $\mu\text{l}$  of a 5 M solution of ammonium acetate. Mix the reagents again and then add 750  $\mu\text{l}$  of ice-cold ethanol. Mix the reagents once more and store the ethanolic solution for 30 minutes at  $0^\circ\text{C}$ .

Ammonium acetate is used in place of sodium acetate to ensure more effective removal of unincorporated ribonucleotides. The solubility constant of ribonucleotides (and deoxyribonucleotides) is higher in ethanolic ammonium acetate solutions than in ethanolic sodium acetate solutions. Unincorporated ribonucleotides remain in the ethanolic phase of the precipitation reaction.

2. Recover the radiolabeled oligonucleotide by centrifugation at maximum speed for 20 minutes at  $4^\circ\text{C}$  in a microfuge.
3. Use a micropipettor equipped with a disposable tip to remove all of the supernatant carefully from the tube.

▲ **WARNING** The supernatant contains most of the unincorporated  $[\gamma\text{-}^{32}\text{P}]\text{ATP}$ . Phosphorylation reactions are often carried out with  $>100 \mu\text{Ci}$  of radiolabeled ATP, so the amount of radioactivity in the supernatant may be considerable. Exercise care and be diligent about disposal of unincorporated radioactivity, pipette tips, and microfuge tubes.

4. Add 500  $\mu\text{l}$  of 80% ethanol to the tube, tap the side of the tube to rinse the nucleic acid pellet, and centrifuge the tube again at maximum speed for 5 minutes at  $4^\circ\text{C}$  in a microfuge.
5. Use a micropipettor equipped with a disposable tip to remove the supernatant (which will contain appreciable amounts of radioactivity) carefully from the tube. Stand the open tube behind a Plexiglas screen until the residual ethanol has evaporated.
6. Dissolve the radiolabeled oligonucleotide in 100  $\mu\text{l}$  of TE (pH 7.6).

The radiolabeled oligonucleotide may be stored for a few days at  $-20^\circ\text{C}$ . However, during prolonged storage, decay of  $^{32}\text{P}$  causes radiochemical damage that can impair the ability of the oligonucleotide to hybridize to its target sequence.

# Protocol 4

---

## Purification of Radiolabeled Oligonucleotides by Precipitation with Cetylpyridinium Bromide

**T**HIS PROTOCOL DESCRIBES THE SEPARATION OF RADIOLABELED OLIGONUCLEOTIDES from unincorporated radiolabel by quantitative differential precipitation of the oligonucleotides with the cationic detergent cetylpyridinium bromide (CPB). The method, which was originally devised to recover DNA eluted from hydroxyapatite columns in phosphate buffers (Geck and Nász 1983), can also be used to precipitate radiolabeled nucleic acids, including oligonucleotides, from labeling reactions. The nucleic acids are first precipitated from aqueous solution with CPB. The detergent is then removed from the precipitate with ethanol (in which the nucleic acids are insoluble), and the nucleic acids are finally dissolved in the buffer of choice. The method is extremely rapid, efficient, and works well in a variety of circumstances, for example, RNA generated by *in vitro* transcription reactions with bacteriophage polymerases and oligonucleotides from phosphorylation reactions. However, the technique suffers from one possible disadvantage — the need to use carrier DNA to increase the efficiency with which the labeled oligonucleotides are precipitated by CPB. For most purposes, the presence of the unlabeled carrier DNA in the final preparation of radiolabeled oligonucleotide is either irrelevant or an advantage (e.g., if the radiolabeled oligonucleotide is to be used as a probe). However, in certain specialized cases (e.g., when a radiolabeled oligonucleotide is to be used in primer-extension reactions or DNA sequencing reactions), the presence of carrier DNA may cause complications. In these cases, we recommend that the oligonucleotide be purified by electrophoresis through a 20% polyacrylamide gel (essentially as described in Protocol 1), by chromatography through Bio-Gel P-60 (Protocol 5), or by Sep-Pak column chromatography (Protocol 6). The following protocol, provided by Ray MacDonald and Galvin Swift (University of Texas Southwestern Medical Center, Dallas), is a modification of the original method of Geck and Nász (1983).



## MATERIALS

---

**CAUTION:** Please see Appendix 12 for appropriate handling of materials marked with <!.>.

### Buffers and Solutions

**Please see Appendix 1 for components of stock solutions, buffers, and reagents. Dilute stock solutions to the appropriate concentrations.**

#### *Cetylpyridinium bromide (CPB) (1%, w/v)*

Dissolve 1 g of CPB (Sigma) in 100 ml of H<sub>2</sub>O. To speed dissolution, heat the solution on a hot plate while agitating it with a magnetic stirrer. After all of the detergent has dissolved, cool the solution to room temperature and filter it through a nitrocellulose filter (0.45- $\mu$ m pore size).

#### *EDTA-Tris (0.5 M, pH 6.0)*

Add 0.1 mole of EDTA to 60 ml of H<sub>2</sub>O. While stirring the solution, slowly add Tris base (powder) until the pH of the solution reaches 6.0. By this stage, the concentration of Tris will be ~1.2 M. Adjust the volume of the solution to 200 ml with H<sub>2</sub>O. This unconventional method of preparing this solution may be essential for efficient precipitation of nucleic acids with cationic detergents (Sibatani 1970).

#### *EDTA-Tris-DNA solution*

Dissolve carrier DNA (e.g., salmon sperm DNA) at a concentration of 50  $\mu$ g/ml in 50 mM EDTA-Tris (pH 6.0) (i.e., a 1:10 dilution of the 0.5 M EDTA-Tris solution). The DNA used as carrier should be of fairly uniform size and not interfere with the hybridization of the radiolabeled nucleic acid to its target DNA. For most purposes, sonicated or fractionated salmon sperm DNA works well (sonicated salmon sperm DNA 600–5000 bp in length is available from Pharmacia or may be prepared as described in Chapter 6, Protocol 10).

#### *Ethanol-sodium acetate solution*

80% (v/v) ethanol

20% (v/v) sodium acetate (0.1 M, pH 5.2)

#### *TE (pH 7.6) or an appropriate prehybridization solution*

Please see Step 8.

### Nucleic Acids and Oligonucleotides

#### *Radiolabeled oligonucleotide <!.>*

The starting material for purification is the reaction mixture from Protocol 2 (either Step 3 or Step 5), after it has been heated to 68°C to inactivate bacteriophage T4 polynucleotide kinase.

### Special Equipment

#### *Dry-ice/ethanol bath <!.>*

## METHOD

---

1. Add 5–10 volumes of the EDTA-Tris-DNA solution to a microfuge tube containing the solution of radiolabeled oligonucleotide. Mix the reagents well.

For precipitation to be efficient, it is important that the ionic composition of the final mixture be predominantly that of the EDTA-Tris-DNA solution. The final volume of the mixture and the concentration of the radiolabeled oligonucleotide do not appreciably affect the efficiency of the procedure.

2. Add sufficient 1% CPB to the tube to bring the concentration of the detergent in the mixture to 0.1%. Mix well.
3. Place the tube in a dry-ice/ethanol bath until the mixture is frozen. Remove the tube from the bath, and allow the mixture to thaw at room temperature.

4. Centrifuge the solution at maximum speed for 5 minutes at 4°C in a microfuge. Use a Pasteur pipette or a micropipettor equipped with a blue disposable tip to remove all of the supernatant carefully from the tube.  
**▲ WARNING** The supernatant contains most of the unincorporated [ $\gamma$ - $^{32}\text{P}$ ]ATP. Phosphorylation reactions are often carried out with  $>100\ \mu\text{Ci}$  of radiolabeled ATP, so the concentration of radioactivity in the supernatant may be considerable. Exercise care and be diligent about disposal of unincorporated radioactivity, pipette tips, and microfuge tubes.
5. Add 500  $\mu\text{l}$  of distilled  $\text{H}_2\text{O}$  to the tube, vortex the mixture for 20 seconds, and again centrifuge the solution as in Step 4.
6. Remove the supernatant from the tube and add 500  $\mu\text{l}$  of the ethanol–sodium acetate solution to the pellet. Vortex the mixture for 15 seconds and then centrifuge the solution at maximum speed for 2 minutes at room temperature in a microfuge.
7. Repeat Step 6.
8. Carefully remove the supernatant and stand the open tube on the bench behind a Plexiglas screen until the last visible traces of ethanol have evaporated. Dissolve the precipitated oligonucleotide in 20–50  $\mu\text{l}$  of TE (pH 7.6) or in a small volume of prehybridization solution if the radiolabeled oligonucleotide is to be used as a probe.

# Protocol 5

---

## Purification of Radiolabeled Oligonucleotides by Size-exclusion Chromatography

**W**HEN RADIOLABELED OLIGONUCLEOTIDES ARE TO BE USED in enzymatic reactions such as primer extension, virtually all of the unincorporated radiolabel must be removed from the oligonucleotide. For this purpose, chromatographic methods (this protocol and Protocol 6) or gel electrophoresis (essentially as described in Protocol 1) are superior to differential precipitation of the oligonucleotide with ethanol or CPB. This protocol describes a method to separate radiolabeled oligonucleotides from unincorporated radiolabel that takes advantage of differences in mobility between oligonucleotides and mononucleotides during size-exclusion chromatography.

### MATERIALS

---

**CAUTION:** Please see Appendix 12 for appropriate handling of materials marked with <!.>.

#### Buffers and Solutions

Please see Appendix 1 for components of stock solutions, buffers, and reagents. Dilute stock solutions to the appropriate concentrations.

*Chloroform* <!.>

Optional, please see Step 7.

*EDTA (0.5 M, pH 8.0)*

*Ethanol*

*Phenol:chloroform* <!.>

Optional, please see Step 7.

*Sodium acetate (3 M, pH 5.2)*

Optional, please see Step 7.

*TE (pH 7.6)*

*Tris-Cl (1 M, pH 8.0)*

Optional, please see Step 7.

*Tris-SDS chromatography buffer*

10 mM Tris-Cl (pH 8.0)

0.1% (w/v) SDS

#### Nucleic Acids and Oligonucleotides

*Radiolabeled oligonucleotide* <!.>

The starting material for purification is the reaction mixture from Protocol 2 (either Step 3 or Step 5), after it has been heated to 68°C to inactivate bacteriophage T4 polynucleotide kinase.

## Special Equipment

### *Gel filtration resin (e.g., Bio-Gel P-60 fine-grade or Sephadex G-15)*

Bio-Gel P-60 (fine grade) may be purchased from Bio-Rad. Sephadex G-15 is available from most suppliers of laboratory chemicals (e.g., Sigma). Bio-Gel P-60 is supplied as a pre-swollen gel; Sephadex G-15 must be swollen and equilibrated before use.

### *Glass wool*

Wrap a small amount of glass wool in aluminum foil and autoclave the package at 15 psi (1.05 kg/cm<sup>2</sup>) for 15 minutes on wrapped item cycle.

### *Microfuge tubes (1.5 ml) in a rack or fraction collector*

Used for the collection of radiolabeled oligonucleotides eluting from the column.

### *Pasteur pipette*

## Additional Reagents

*Step 6 of this protocol may require the reagents listed in Chapter 13, Protocol 7.*

## METHOD

---

1. Add 30  $\mu$ l of 20 mM EDTA (pH 8.0) to the tube containing the radiolabeled oligonucleotide. Store the solution at 0°C while preparing a column of size-exclusion chromatography resin.  
For convenience, Bio-Gel P-60 is used throughout this protocol as an example of a suitable resin. However, the method works equally well with Sephadex G-15.
2. Prepare a Bio-Gel P-60 column in a sterile Pasteur pipette.
  - a. Equilibrate the slurry of Bio-Gel P-60 supplied by the manufacturer in 10 volumes of Tris-SDS chromatography buffer.  
If a centrifugal evaporator (Savant SpeedVac or its equivalent) is available, the Bio-Gel P-60 column may be poured and run in a solution of 0.1% ammonium bicarbonate. The pooled fractions containing the radiolabeled oligonucleotide (please see Step 6) can then be evaporated to dryness in a centrifugal evaporator, thereby eliminating the need for extraction of the oligonucleotide preparation with organic solvents and precipitation with ethanol.
  - b. Tamp a sterile glass wool plug into the bottom of a sterile Pasteur pipette.  
A glass capillary tube works well as a tamping device.
  - c. With the plug in place, pour a small amount of Tris-SDS chromatography buffer into the column and check that the buffer flows at a reasonable rate (one drop every few seconds).
  - d. Fill the pipette with the Bio-Gel P-60 slurry. The column forms rapidly as the gel matrix settles under gravity and the buffer drips from the pipette. Add additional slurry until the packed column fills the pipette from the plug of glass wool to the constriction near the top of the pipette.
  - e. Wash the column with 3 ml of Tris-SDS chromatography buffer.  
**▲ IMPORTANT** Do not allow the column to run dry. If necessary, seal the column by wrapping a piece of Parafilm around the bottom of the pipette.
3. Use a pipette to remove excess buffer from the top of the column, and then rapidly load the radiolabeled oligonucleotide (in a volume of 100  $\mu$ l or less) onto the column.
4. Immediately after the sample has entered the column, add 100  $\mu$ l of buffer to the top of the column. As soon as the buffer has entered the column, fill the pipette with buffer. Replenish

the buffer as necessary so that it continuously drips from the column. Do not allow the column to run dry.

5. Use a hand-held minimonitor to follow the progress of the radiolabeled oligonucleotide. When the radioactivity first starts to elute from the column, begin collecting two-drop fractions into microfuge tubes.

**▲ WARNING** Because phosphorylation reactions are often carried out with  $>100 \mu\text{Ci}$  of radiolabeled ATP, the amount of radioactivity in these column fractions may be considerable. Exercise care and be diligent about disposal of unincorporated radioactivity, pipette tips, and microfuge tubes.

6. When nearly all of the radioactivity has eluted from the column, use a liquid scintillation counter to measure the radioactivity in each fraction by Cerenkov counting (please see Appendix 8). If there is a clean separation of the faster-migrating peak (the radiolabeled oligonucleotide) from the slower peak of unincorporated  $[\gamma\text{-}^{32}\text{P}]\text{ATP}$ , pool the samples containing the radiolabeled oligonucleotide. If the peaks are not well separated, analyze  $\sim 0.5 \mu\text{l}$  of every other fraction either by adsorption to DE-81 filters (please see Chapter 13, Protocol 7, Step 3) or by thin-layer chromatography. Pool those fractions containing radiolabeled oligonucleotide that do not contain appreciable amounts of unincorporated  $[\gamma\text{-}^{32}\text{P}]\text{ATP}$ .
7. If the radiolabeled oligonucleotide is to be used in enzymatic reactions, then proceed as follows. Otherwise, proceed to Step 8.
  - a. Extract the pooled fractions with an equal volume of phenol:chloroform.
  - b. Back-extract the organic phase with  $50 \mu\text{l}$  of  $10 \text{ mM}$  Tris-Cl (pH 8.0), and combine the two aqueous phases.
  - c. Extract the combined aqueous phases with an equal volume of chloroform.
  - d. Add 0.1 volume of  $3 \text{ M}$  sodium acetate (pH 5.2), mix well, and add 3 volumes of ethanol. Incubate the sample for 30 minutes at  $0^\circ\text{C}$ , and then centrifuge it at maximum speed for 20 minutes at  $4^\circ\text{C}$  in a microfuge. Use a micropipettor equipped with a disposable tip to remove the ethanol (which should contain very little radioactivity) from the tube.
8. Add  $500 \mu\text{l}$  of 80% ethanol to the tube, vortex it briefly, and centrifuge the tube again at maximum speed for 5 minutes in a microfuge.
9. Use a micropipettor equipped with a disposable tip to remove the ethanol from the tube. Stand the open tube behind a Plexiglas screen until the residual ethanol has evaporated.
10. Dissolve the precipitated oligonucleotide in  $20 \mu\text{l}$  of TE (pH 7.6) and store it at  $-20^\circ\text{C}$ .

# Protocol 6

---

## Purification of Radiolabeled Oligonucleotides by Chromatography on a Sep-Pak C<sub>18</sub> Column

**T**HIS PROTOCOL, WHICH IS A MODIFICATION OF PROCEDURES described by Lo et al. (1984), Sanchez-Pescador and Urdea (1984), and Zoller and Smith (1984), describes a method for the separation of radiolabeled oligonucleotides from unincorporated radiolabel that takes advantage of the reversible affinity of oligonucleotides for silica gel.

This protocol can be used only to purify oligonucleotides carrying a 5'-phosphate group, radiolabeled or unlabeled. The method described in Protocol 1 should be used to purify oligonucleotides with free 5'-hydroxyl groups.

### MATERIALS

---

**CAUTION:** Please see Appendix 12 for appropriate handling of materials marked with <!.>.

#### Buffers and Solutions

Please see Appendix 1 for components of stock solutions, buffers, and reagents. Dilute stock solutions to the appropriate concentrations.

*Acetonitrile (5%, 30%, and 100%) <!.>*

Use 10 ml HPLC-grade acetonitrile (100%) for each Sep-Pak column. Prepare the diluted solutions of acetonitrile in H<sub>2</sub>O just before use.

*Ammonium bicarbonate (25 mM, pH 8.0)*

*Ammonium bicarbonate (25 mM, pH 8.0) containing 5% (v/v) acetonitrile*

Mix 5 ml of acetonitrile with 95 ml of 25 mM ammonium bicarbonate.

*TE (pH 7.6)*

#### Nucleic Acids and Oligonucleotides

*Radiolabeled oligonucleotide <!.>*

The starting material for purification is the reaction mixture from Protocol 2 (either Step 3 or Step 5), after it has been heated to 68°C to inactivate bacteriophage T4 polynucleotide kinase.

#### Special Equipment

*Centrifugal evaporator (Savant SpeedVac or equivalent)*

*Microfuge tubes (1.5 ml) in a rack or fraction collector*

Used for the collection of radiolabeled oligonucleotides eluting from the column.

*Sep-Pak classic columns, short body*

Sep-Pak classic columns (available from the Waters Division of Millipore) contain 360 mg/column of a hydrophobic (C<sub>18</sub>) reversed-phase chromatography resin. The separation principle makes use of the fact that the oligonucleotide adsorbs to the column when the polarity of the solvent is high (e.g., aqueous buffers) and elutes from the column when the polarity of the solvent is reduced (e.g., a mixture of methanol and H<sub>2</sub>O). A separate column is required for each phosphorylation reaction.

*Syringe (10-cc polypropylene)*

## METHOD

---

1. Prepare a Sep-Pak C<sub>18</sub> reversed-phase column as follows:
  - a. Attach a polypropylene syringe containing 10 ml of acetonitrile to a Sep-Pak C<sub>18</sub> column.
  - b. Slowly push the acetonitrile through the Sep-Pak column.
  - c. *Remove the syringe from the Sep-Pak column and then take the plunger out of the barrel.* This prevents air being pulled back into the column. Reattach the barrel to the column.
  - d. Flush out the organic solvent with two 10-ml aliquots of sterile H<sub>2</sub>O. Repeat Step c after each wash.
2. Dilute the radiolabeled oligonucleotide preparation to 1.5 ml with sterile H<sub>2</sub>O, and apply the entire sample to the column through the syringe.
3. Wash the Sep-Pak column with the following four solutions. Repeat Step 1c after each wash.
  - 10 ml of 25 mM ammonium bicarbonate (pH 8.0)
  - 10 ml of 25 mM ammonium bicarbonate/5% acetonitrile
  - 10 ml of 5% acetonitrile
  - 10 ml of 5% acetonitrile
4. Elute the radiolabeled oligonucleotide with three 1-ml aliquots of 30% acetonitrile. Collect each fraction in a separate 1.5-ml microfuge tube. Repeat Step 1c after each elution.

▲ **WARNING** Because phosphorylation reactions are often carried out with >100 μCi of radiolabeled ATP, the amount of radioactivity in these column fractions may be considerable. Exercise care and be diligent about disposal of unincorporated radioactivity, pipette tips, and microfuge tubes.
5. Recover the oligonucleotide by evaporating the eluate to dryness in a centrifugal evaporator (Savant SpeedVac or its equivalent).
6. Dissolve the radiolabeled oligonucleotide in a small volume (10 μl) of TE (pH 7.6).

# Protocol 7

---

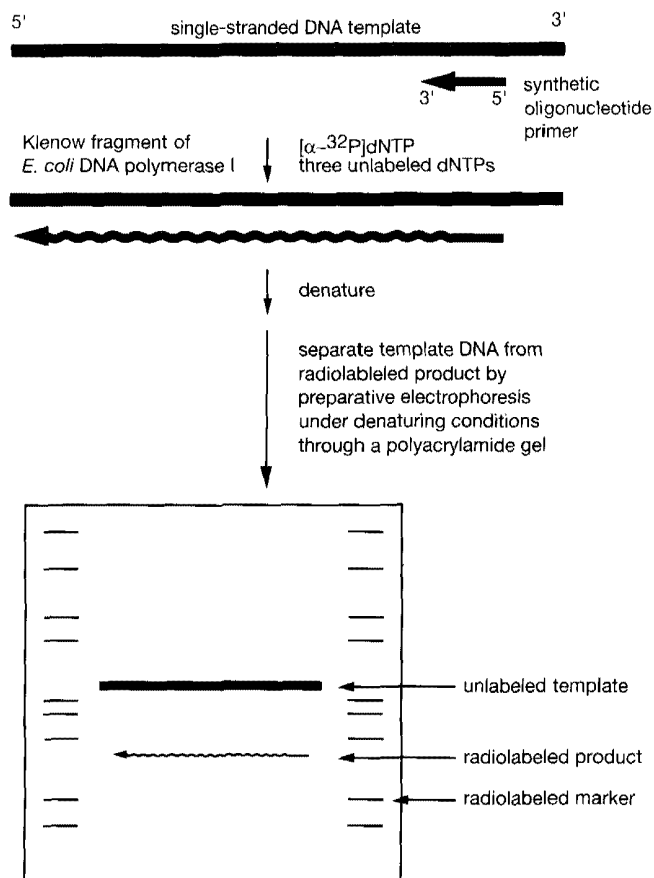
## Labeling of Synthetic Oligonucleotides Using the Klenow Fragment of *E. coli* DNA Polymerase I

**O**LIGONUCLEOTIDES ARE USUALLY LABELED IN PHOSPHORYLATION REACTIONS catalyzed by bacteriophage T4 polynucleotide kinase (please see Protocol 2). For some purposes, however (e.g., when using oligonucleotides as probes in Southern hybridizations), it is important to radiolabel to a higher specific activity. At best, phosphorylation results in the incorporation of one atom of  $^{32}\text{P}$  per molecule of oligonucleotide. Probes of higher specific activities can be obtained using the Klenow fragment of *E. coli* DNA polymerase I to synthesize a strand of DNA complementary to the synthetic oligonucleotide (Studnicki and Wallace 1984; Ullrich et al. 1984b; for review, please see Wetmur 1991). A short primer is hybridized to an oligonucleotide template whose sequence is the complement of the desired radiolabeled probe. The primer is then extended using the Klenow fragment to incorporate  $[\alpha\text{-}^{32}\text{P}]\text{dNTPs}$  in a template-directed manner. After the reaction, the template and product are separated by denaturation followed by electrophoresis through a polyacrylamide gel under denaturing conditions (please see Figure 10-1). With this method, it is possible to generate oligonucleotide probes that contain several radioactive atoms per molecule of oligonucleotide and to achieve specific activities as high as  $2 \times 10^{10}$  cpm/ $\mu\text{g}$  of probe.

In a modification of this radiolabeling procedure, longer probes can be synthesized from two oligonucleotides that contain complementary sequences at their 3' termini (Ullrich et al. 1984a). Here, the two oligonucleotides are annealed via their complementary 3' sequences and then extended with the Klenow fragment. Both strands are extended (and radiolabeled), resulting in a duplex that may be considerably longer than either of the two original oligonucleotides. Although this method requires two oligonucleotides, it has the advantage that both strands of the product are radiolabeled. Strand separation and purification by polyacrylamide gel electrophoresis are therefore no longer mandatory. Instead, the radiolabeled probes can be purified by chromatography through Sephadex G-15 or Bio-Gel P-60, essentially as described in Protocol 5 of this chapter. When planning an experiment of this type, please consider the following points:

- **The specific activity of the  $[\alpha\text{-}^{32}\text{P}]\text{dNTPs}$  in the reaction.** The specific activity of a dNTP whose  $\alpha$ -phosphate has been completely substituted by  $^{32}\text{P}$  is  $\sim 9000$  Ci/mmmole. Preparations with lower specific activities contain a mixture of both  $^{32}\text{P}$ -labeled and unlabeled molecules. Thus, if a single radiolabeled dNTP with a specific activity of 3000 Ci/mmmole is included in the synthetic reaction and there are only three positions at which that nucleotide can be incorporated into the final product, an average of only one atom of  $^{32}\text{P}$  will be present in each molecule of probe (i.e., the specific activity will be approximately equal to that of a probe labeled





**FIGURE 10-1** Labeling of Synthetic Oligonucleotide Using the Klenow Fragment of *E. coli* DNA Polymerase I

Please see text for details.

by bacteriophage T4 polynucleotide kinase). If the sequence of the desired probe and the specific activity of the available precursors are known, it is possible to predict the probe's specific activity when one, two, three, or all four  $[\alpha\text{-}^{32}\text{P}]\text{dNTPs}$  are included in the reaction.

- **The concentration of dNTPs in the reaction.** Polymerization of nucleotides will not proceed efficiently unless the concentration of each dNTP in the reaction remains at  $1\ \mu\text{M}$  or greater ( $1\ \mu\text{M} = \sim 0.66\ \text{ng}/\mu\text{l}$ ) throughout the course of the reaction. Calculate the total quantity of each dNTP that would be incorporated into the probe, assuming that all of the single-stranded sequences in the reaction are used as templates. The total amount of each dNTP in the reaction should be the sum of the amount that could be incorporated into the probe plus  $0.66\ \text{ng}/\mu\text{l}$ .
- **The primer must be of sufficient length and specificity to bind to the template and promote synthesis at the appropriate position.** Primers used for this purpose are usually 7–9 nucleotides long and are complementary to sequences at or close to the 3' terminus of the template oligonucleotide. Because the stability of such short hybrids is difficult to predict, the ratio of primer to template that gives the maximum yield of full-length probe should be determined empirically before embarking on large-scale labeling reactions.

- **The final product is a double-stranded fragment of DNA whose length is equal to or slightly less than that of the template (depending on the location of the sequences complementary to the primer).** To be maximally effective as a probe, the unlabeled template strand must be efficiently separated from the complementary radiolabeled product; otherwise, the two complementary strands anneal to each other and the efficiency of hybridization to the desired target sequence is reduced. For oligonucleotides <30 nucleotides in length, electrophoresis through a 20% polyacrylamide gel is the most effective method to separate the complementary strands. The efficiency of the separation is improved if the lengths of the two strands are not exactly the same. Whenever possible, the primer should therefore be designed so that it is complementary to the *subterminal* nucleotides of the template. If the primer cannot hybridize to the two to three nucleotides at the 3' terminus of the template, the radiolabeled product will be shorter than the unlabeled template and separate from it more effectively during electrophoresis. However, even when their lengths are identical, there is a good chance that the template and product strands will separate to some extent during electrophoresis since the rate of migration of single-stranded nucleic acids through gels is dependent not only on their length, but also on their base composition and sequence.

The extent of separation can often be increased either by phosphorylating one of the two strands (template or primer) with nonradioactive ATP before synthesis of the probe (please see Protocol 2) or by leaving the dimethoxytrityl group attached to the 5' terminus of the primer (Studnicki and Wallace 1984). Because it is impossible to predict which method will be most effective for a given oligonucleotide, it is usually necessary to carry out a series of trial experiments to determine in each case the efficiency with which an extended product can be separated from the template.

## MATERIALS

---

**CAUTION:** Please see Appendix 12 for appropriate handling of materials marked with <!>.

### Buffers and Solutions

Please see Appendix 1 for components of stock solutions, buffers, and reagents. Dilute stock solutions to the appropriate concentrations.

Formamide loading buffer <!>  
10x Klenow buffer

### Enzymes and Buffers

Klenow fragment of *E. coli* DNA polymerase I

### Gels

Denaturing polyacrylamide gel <!>

The percentage of polyacrylamide in the solution used to form the gel and the conditions under which electrophoresis is carried out vary according to the size of the oligonucleotides in the reaction mixture. Table 10-4 provides useful guidelines.

Polyacrylamide gels are usually cast in 1x TBE (89 mM Tris-borate, 2 mM EDTA), and electrophoresis is carried out in the same buffer. For further details of the methods used to cast and handle polyacrylamide gels, please see Protocol 1 and Chapter 12, Protocol 8.

**TABLE 10-4 Percent Polyacrylamide Required to Resolve Oligonucleotides**

LENGTH OF OLIGONUCLEOTIDE	POLYACRYLAMIDE (%)
12–15 nucleotides	20
25–35 nucleotides	15
35–45 nucleotides	12
45–70 nucleotides	10

## Nucleic Acids and Oligonucleotides

### *Oligonucleotide primer*

Purify the primer as described in Protocol 1. To ensure efficient radiolabeling, the primer should be in three- to tenfold molar excess over the template DNA in the reaction mixture.

### *Template oligonucleotide*

Purify the template as described in Protocol 1. The sequence of the oligonucleotide template *should be the complement* of the desired radiolabeled probe.

## Radioactive Compounds

### $[\alpha\text{-}^{32}\text{P}]\text{dNTPs}$ <1>

To keep the substrate concentration high, perform the extension reaction in as small a volume as possible. Thus, it is best to use radiolabeled dNTPs supplied in ethanol/ $\text{H}_2\text{O}$  rather than those supplied in buffered aqueous solvents. Appropriate volumes of the ethanolic  $[\alpha\text{-}^{32}\text{P}]\text{dNTPs}$  can be mixed and evaporated to dryness in the microfuge tube that will be used to carry out the reaction. To minimize problems caused by radiolysis of the precursor and the probe, it is best, whenever possible, to prepare radiolabeled probes on the day the  $[\text{P}^{32}]\text{dNTP}$  arrives in the laboratory.

## Special Equipment

### *Phosphorescent adhesive labels (available from commercial sources) or adhesive labels marked with very hot radioactive ink* <1>

Radioactive ink is made by mixing a small amount of  $^{32}\text{P}$  with waterproof black drawing ink. For this protocol, the ink should be “very hot” (>2000 cps on a hand-held minimonitor). Use a fiber-tip pen to apply the ink to adhesive labels. Attach radioactive-warning tape to the pen, and store it in an appropriate place. Reusable alternatives to radioactive ink are chemiluminescent markers available from Stratagene (Glogos). The markers can be re-used many times but must be exposed to fluorescent light just before a new round of autoradiography.

*Water bath or heating block preset to 80°C*

## Additional Reagents

*Step 9 of this protocol requires reagents listed in Chapter 5, Protocol 12.*

## METHOD

1. Transfer to a microfuge tube the calculated amounts of  $[\alpha\text{-}^{32}\text{P}]\text{dNTPs}$  necessary to achieve the desired specific activity and sufficient to allow complete synthesis of all template strands (please see the introduction to this protocol).

The concentration of dNTPs should not drop below  $1\ \mu\text{M}$  at any stage during the reaction. To keep the substrate concentration high, the extension reaction should be carried out in as small a volume as possible.

2. Add to the tube the appropriate amounts of oligonucleotide primer and template oligonucleotide.

To ensure efficient radiolabeling, the primer should be in three- to tenfold molar excess over the template DNA in the reaction mixture.

3. Add 0.1 volume of 10x Klenow buffer to the tube. Mix the reagents well.
4. Add 2–4 units of the Klenow fragment per 5  $\mu$ l of reaction volume. Mix well. Incubate the reaction for 2–3 hours at 14°C.  
If desired, the progress of the reaction may be monitored by removing small (0.1  $\mu$ l) aliquots and measuring the proportion of radioactivity that has become precipitable with 10% trichloroacetic acid (TCA) (please see Appendix 8).
5. Dilute the reaction mixture with an equal volume of formamide-loading buffer, heat the mixture to 80°C for 3 minutes, and load the entire sample on a denaturing polyacrylamide gel.
6. Following electrophoresis, disassemble the electrophoresis apparatus, leaving the polyacrylamide gel attached to one of the glass plates (for details, please see Chapter 12, Protocol 11).  
**▲ WARNING** Unincorporated [ $\alpha$ -<sup>32</sup>P]dNTPs may have migrated into the lower buffer reservoir, making it radioactive. Treat the gel, glass plates, buffers, and electrophoresis apparatus as potential sites of radioactivity. Handle them appropriately, behind a Plexiglas shield.
7. Wrap the gel and its backing plate in Saran Wrap. Note the position of the tracking dyes and use a hand-held minimonitor to check the amount of radioactivity in the region of the gel that should contain the oligonucleotide. Attach a set of adhesive dot labels, marked with either very hot radioactive ink or phosphorescent spots, around the edge of the sample on the Saran Wrap. Cover the radioactive dots with Scotch Tape to prevent contaminating the film holder or intensifying screen with the radioactive ink.
8. Expose the gel to autoradiographic film (please see Appendix 9).  
Usually, the amount of radioactivity incorporated into the probe is so great that the time needed to obtain an image on film is no more than a few seconds.
9. After developing the film, align the images of the radioactive ink with the radioactive marks on the labels, and locate the position of the probe in the gel. Excise the band and recover the radioactive oligonucleotide as described in Chapter 5, Protocol 12.

# Protocol 8

---

## Hybridization of Oligonucleotide Probes in Aqueous Solutions: Washing in Buffers Containing Quaternary Ammonium Salts

**J**ACOBS ET AL. (1988) DESCRIBE METHODS AND THEORETICAL REASONS to use hybridization buffers containing quaternary alkylammonium salts. The following protocol is a simple variation of these methods. Hybridization is first carried out in conventional aqueous solvents at a temperature well below the melting temperature, and the hybrids are then washed at higher stringency in buffers containing quaternary alkylammonium salts. TMACl is used with probes that are 14–50 nucleotides in length, whereas TEACl is used with oligonucleotides that are 50–200 nucleotides in length.

The graph in Figure 10-2 can be used to estimate a washing temperature when using oligonucleotide probes of a given length in TMACl buffers. To estimate a washing temperature when using TEACl buffers, calculate the value from the TMACl curve in the figure and then subtract 33°C.

### MATERIALS

---

**CAUTION:** Please see Appendix 12 for appropriate handling of materials marked with <!>.

### Buffers and Solutions

Please see Appendix 1 for components of stock solutions, buffers, and reagents. Dilute stock solutions to the appropriate concentrations.

#### *Oligonucleotide hybridization solution*

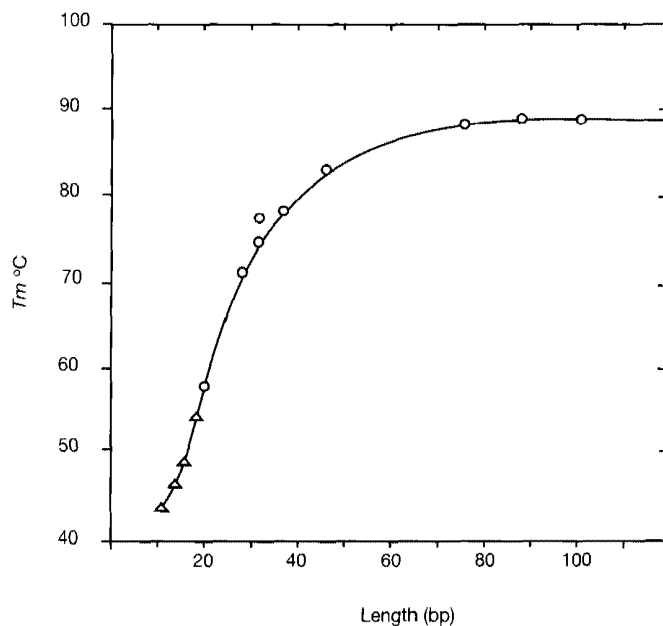
- 6x SSC (or 6x SSPE)
- 0.05 M sodium phosphate (pH 6.8)
- 1 mM EDTA (pH 8.0)
- 5x Denhardt's solution (Appendix 1)
- 100 µg/ml denatured, fragmented salmon sperm DNA (Pharmacia or prepare as described in Chapter 6, Protocol 10)
- 100 mg/ml dextran sulfate (please see the information panel on **DEAE-DEXTRAN** in Chapter 16)

#### *Oligonucleotide prehybridization solution*

- 6x SSC (or 6x SSPE)
- 0.05 M sodium phosphate (pH 6.8)
- 1 mM EDTA (pH 8.0)
- 5x Denhardt's solution (Appendix 1)
- 100 µg/ml denatured, fragmented salmon sperm DNA (Pharmacia or prepare as described in Chapter 6, Protocol 10)

#### *6x SSC or SSPE*

Place these solutions on ice before using in Steps 4 and 5 of the protocol.



**FIGURE 10-2** Estimating  $T_m$  in Buffers Containing 3.0 M TMACI

The graph depicts the increase in the  $T_m$  as a function of probe length. A series of aliquots of pBR322 DNA was delivered (spotted) onto nitrocellulose membranes, hybridized against pBR322-derived probes of various lengths, and washed in 3 M TMACI. Washes of the duplicate spots were carried out at 3°C intervals. The probes were made by digesting pBR322 DNA with *Sau3A*, treating with alkaline phosphatase, and labeling in a reaction containing T4 polynucleotide kinase and [ $\gamma$ - $^{32}\text{P}$ ]ATP. The labeled fragments were purified by electrophoresis through a polyacrylamide gel, recovered from the gel, and boiled before hybridization. Data obtained from an autoradiogram of the hybridized membranes were used to determine the  $T_m$  for each fragment (open circles). The melting data are shown for hybridization of oligonucleotides in  $\text{Me}_4\text{NCl}$  (open triangles). (Adapted, with permission, from Wood et al. 1985.)

#### TEACI wash solution

2.4 M TEACI  
50 mM Tris-Cl (pH 8.0)  
0.2 mM EDTA (pH 7.6)  
1 mg/ml SDS

Use this wash solution for probes 50–200 nucleotides in length. It is essential to warm an aliquot of the solution to the desired temperature before use (please see Steps 6 and 7).

#### TMACI (5 M) or TEACI (3 M)

Prepare a 5 M solution of TMACI or a 3 M solution of TEACI in  $\text{H}_2\text{O}$ . TMACI is used with probes that are 14–50 nucleotides in length, whereas TEACI is used with oligonucleotides that are 50–200 nucleotides in length. Both chemicals are available from Aldrich. To the solution of TMACI or TEACI, add activated charcoal to a final concentration of ~10% and stir for 20–30 minutes. Allow the charcoal to settle, and then filter the solution of quaternary alkylammonium salts through a Whatman No. 1 paper. Sterilize the solution by passage through a nitrocellulose filter (0.45- $\mu\text{m}$  pore size). Measure the refractive index of the solution, and calculate the precise concentration of the quaternary alkylammonium salts from the equation:  $C = (n - 1.331)/0.018$ , where  $C$  is the molar concentration of quaternary alkylammonium salts and  $n$  is the refractive index.

Store the filtered solution in dark bottles at room temperature.

#### TMACI wash solution

3.0 M TMACI  
50 mM Tris-Cl (pH 8.0)  
0.2 mM EDTA (pH 7.6)  
1 mg/ml SDS

Use this wash solution for probes 14–50 nucleotides in length. It is essential to warm an aliquot of the solution to the desired temperature before use (please see Steps 6 and 7).

## Nucleic Acids and Oligonucleotides

*Nitrocellulose or nylon filters or membranes containing the immobilized target nucleic acids of interest (e.g., Southern or northern blots, lysed bacterial colonies filters, or bacteriophage plaques)*

## Probes

### *Radiolabeled oligonucleotide probe <math>\langle ! \rangle</math>*

Prepared as described in Protocol 2 or 7. We recommend that phosphorylated probes be purified by precipitation with CPB as described in Protocol 4 before use in hybridization. This method of purification removes unincorporated [ $^{32}\text{P}$ ]ATP and cuts down on the number of intense radioactive spots (pepper spots) on the autoradiographs that can be mistaken for positive hybridization signals.

## Special Equipment

### *Hybridization device*

Please see Step 1.

*Shaking incubator, water bath, or hybridization apparatus preset to 37°C (Steps 1 and 3) and later to a temperature appropriate for washing (Step 7)*

## METHOD

---

1. Prehybridize the filters or membranes for 4–16 hours in oligonucleotide prehybridization solution at 37°C.
 

Prehybridization, hybridization, and washing of circular filters are best carried out in Sears Seal-A-Meal bags or plastic boxes with tight-fitting lids. For Southern and northern blots, a hybridization device equipped with sealable glass tubes could be used.
2. Discard the prehybridization solution and replace it with oligonucleotide hybridization solution containing a radiolabeled oligonucleotide probe at a concentration of 180 pM.
 

When hybridizing with several oligonucleotides simultaneously, each probe should be present at a concentration of 180 pM and the specific activity of the radiolabeled probe should be  $5 \times 10^5$  to  $1.5 \times 10^6$  cpm/pmole.
3. Incubate the filters for 12–16 hours at 37°C.
4. Discard the radiolabeled hybridization solution into an appropriate disposable container. Rinse the filters three times at 4°C with ice-cold 6x SSC or 6x SSPE to remove most of the dextran sulfate.
5. Wash the filters twice for 30 minutes at 4°C in ice-cold 6x SSC or 6x SSPE.
6. Rinse the filters at 37°C in two changes of the TMAcI or TEAcI wash solution.
 

The aim of this step is to replace the SSPE and SSC with the solution of quaternary alkylammonium salts. Unless this step is carried out diligently, the full benefits of using TEAcI or TMAcI will not be realized.
7. Wash the filters twice for 20 minutes each in TMAcI or TEAcI wash solution at a temperature that is 2–4°C below the  $T_m$  indicated in Figure 10-2.
 

Note that the  $T_m$  of a hybrid is 33°C lower in a buffer containing TEAcI than in a buffer containing TMAcI. Make sure that the buffers are prewarmed to the desired temperature and that fluctuations in temperature are less than  $\pm 1^\circ\text{C}$ .
8. Remove the filters from the washing solution. Blot them dry at room temperature and autoradiograph them as described in Appendix 9.

# Protocol 9

---

## Empirical Measurement of Melting Temperature

**T**HE  $T_M$  OF AN OLIGONUCLEOTIDE HYBRIDIZED TO A TARGET SEQUENCE can be calculated as described in the introduction to this chapter (please see Melting Temperature and Hybridization Temperature in the introduction of this chapter), or the  $T_m$  may be determined empirically by measuring the temperature ( $T_i$ ) at which dissociation of the double-stranded DNA becomes irreversible. The experiment is carried out under nonequilibrium conditions that do not favor rehybridization of the released probe to the target. The optimal temperature for hybridization of the oligonucleotide is then derived from  $T_i$ .

The procedure requires a cloned target sequence that is complementary (perfectly or imperfectly, depending on the experiment) to the oligonucleotide probe. If a target sequence is not available from "natural" sources, it can be synthesized chemically or, in some cases, derived by PCR.

### MATERIALS

---

**CAUTION:** Please see Appendix 12 for appropriate handling of materials marked with <!.>.

### Buffers and Solutions

**Please see Appendix 1 for components of stock solutions, buffers, and reagents. Dilute stock solutions to the appropriate concentrations.**

*Denaturation solution (for double-stranded target DNA only)*

1.5 M NaCl  
0.5 N NaOH <!.>

*Neutralization buffer (for double-stranded target DNA only)*

0.5 M Tris-Cl (pH 7.4)  
1.5 M NaCl

*Oligonucleotide prehybridization solution*

6x SSC (or 6x SSPE)  
0.01 M sodium phosphate (pH 6.8)  
1 mM EDTA (pH 8.0)  
5x Denhardt's solution (please see Appendix 1)  
0.5% (w/v) SDS

100 µg/ml denatured, fragmented salmon sperm DNA (please see Chapter 6, Protocol 10)

*Phenol:chloroform (1:1, v/v) (for double-stranded target DNA only) <!.>*

*Sodium acetate (3 M, pH 5.2) (for double-stranded target DNA only)*

2x SSC



## Enzymes and Buffers

*Appropriate restriction enzyme for double-stranded target DNA*

Please see Step 3.

## Nucleic Acids and Oligonucleotides

*Control DNA*

Single-stranded or double-stranded DNA vector or sequence unrelated to the target DNA. Please see Step 3.

*Target DNA*

Ideally, this sequence should be cloned into a bacteriophage M13 vector and isolated as a single-stranded DNA (please see Chapter 3). Double-stranded plasmids or PCR products can also be used after denaturation as described in Step 3 of the protocol.

## Probes

*Oligonucleotide probe*

Crude oligonucleotides are acceptable for this procedure provided the preparation can be labeled by phosphorylation to a specific activity  $>10^6$  cpm/ $\mu$ g.

Before synthesizing the probe, check for potential homology and/or complementarity between its sequence and that of the vector used to propagate the target. Most of the commercially available programs to analyze DNA can be used to search common vector sequences for matches that might cause problems during hybridization.

## Special Equipment

*Boiling water bath*

*Cross-linking device (e.g., Stratalinker, Stratagene; GS Gene Linker, Bio-Rad), or Microwave oven, or Vacuum oven*

*Forceps, blunt-ended*

*Glass test tubes (17 x 100 mm)*

*Nitrocellulose or nylon membrane*

*Paper-hole punch*

*Scintillation vials each containing 10 ml of aqueous-based scintillant*

*Thermometer*

*Thick blotting paper (e.g., Whatman 3MM, Schleicher & Schuell GB004, or Sigma QuickDraw)*

*Water bath, circulating, with precise temperature control*

Please see Steps 7, 10, and 12.

## Additional Reagents

*Step 1 of this protocol requires the reagents listed in Protocols 2 and 4 of this chapter.*

## METHOD

---

1. Radiolabel 1–10 pmoles of the oligonucleotide to be used as a probe by phosphorylation (Protocol 2), and remove excess unincorporated  $[\gamma\text{-}^{32}\text{P}]\text{ATP}$  by precipitation with CPB (Protocol 4).
2. Use a paper-hole punch to cut four small circles (diameter 3–4 mm) out of a nitrocellulose or nylon membrane for hybridization. Arrange the circles on a piece of Parafilm. Mark two of the membranes with a soft-lead pencil.
3. Apply target and control DNAs to the membrane circles as follows.

#### SINGLE-STRANDED TARGET DNA

- a. Apply ~100 ng of target DNA in a volume of 1–3  $\mu\text{l}$  of 2x SSC to each of the marked membranes.
- b. Apply an equal amount of vector DNA (e.g., single-stranded bacteriophage M13 DNA without insert) to the unmarked membranes.
- c. After the fluid has dried, use blunt-ended forceps (e.g., Millipore forceps) to remove the two sets of membranes from the Parafilm, and place them between sheets of thick blotting paper.
- d. Fix the DNAs to the membranes by baking for 1–2 hours at 80°C in a vacuum oven.  
Alternatively, place the membranes on a sheet of blotting paper and fix the DNA by cross-linking using UV light.

#### DOUBLE-STRANDED TARGET DNA

- a. If the target DNA has been cloned into a plasmid, linearize both the recombinant plasmid and the vector by digestion with a restriction enzyme that does not cleave within the target sequence.
  - b. Purify the resulting double-stranded DNA or the PCR product by extraction with phenol:chloroform and standard precipitation with ethanol. Dissolve the DNA in 2x SSC at a concentration of 50–100 ng/ $\mu\text{l}$ .
  - c. Apply the solution of target DNA, as well as a control DNA, to the membranes prepared as described above. Use blunt-ended forceps to transfer the membranes to a sheet of thick blotting paper saturated with denaturation solution. Incubate the membranes for 5–10 minutes at room temperature.
  - d. Transfer the membranes to a fresh sheet of thick blotting paper saturated with neutralization buffer. Incubate the membranes for 10 minutes at room temperature.
  - e. Transfer the membranes to a dry sheet of thick blotting paper, and leave them at room temperature until all of the fluid has evaporated. Immobilize the DNA to the membranes either by baking for 1–2 hours at 80°C in a vacuum oven or by cross-linking using UV light.
4. Use blunt-ended forceps to transfer all of the membranes to a polyethylene tube containing 2 ml of oligonucleotide prehybridization solution. Seal the tube and incubate, with occasional shaking, at a temperature estimated to be 25°C below the  $T_m$  for the solvent being used.  
Although the above protocol uses sodium salts in the hybridization solution, other solutes such as TMACl or TEACl can be substituted if desired to determine the  $T_i$  in these solvents.
  5. After 2 hours, add the radiolabeled oligonucleotide to the prehybridization solution. The final concentration of oligonucleotide should be ~1 pmole/ml. Continue incubating at 25°C below the  $T_m$  for a further 2–4 hours, with occasional shaking.
  6. Remove the membranes from the hybridization solution, and immediately immerse them in 2x SSC at room temperature. Agitate the fluid continuously. Replace the fluid every 5 minutes until the amount of radioactivity on the membranes remains constant (as measured with a hand-held minimonitor).
  7. Adjust the temperature of a circulating water bath to 25°C below the  $T_m$ . Dispense 5 ml of 2x SSC into each of 20 glass test tubes (17 x 100 mm). Monitor the temperature of the fluid in

one of the tubes with a thermometer. Incubate the tubes in the water bath until the temperature of the 2x SSC is 25°C below the  $T_m$ .

8. Transfer the membranes individually to four empty glass tubes, and add 1 ml of 2x SSC (from one of the tubes prepared in Step 7 and prewarmed to 25°C below the  $T_m$ ) to each membrane. Place the tubes in the water bath for 5 minutes.
9. Remove the tubes containing membranes from the bath, transfer the liquid to scintillation vials, and wash the tubes and membranes with 1 ml of 2x SSC at room temperature. Add the wash solutions to the appropriate scintillation vials.
10. Increase the temperature of the water bath by 3°C, and wait for the temperature of the 2x SSC in the tubes prepared in Step 7 to equilibrate.
11. Add 1 ml of 2x SSC at the higher temperature to each of the four tubes containing the membranes. Place the tubes in the water bath for 5 minutes.
12. Repeat Steps 9, 10, and 11 at successively higher temperatures until a temperature of 30°C above the  $T_m$  is achieved.
13. Place the membranes in separate glass tubes (17 x 100 mm) containing 1 ml of 2x SSC, and heat them to boiling for 5 minutes to remove any remaining radioactivity. Cool the solutions in ice, and transfer them to scintillation vials. Wash the membranes and tubes used for boiling with 1 ml of 2x SSC, and add the washing solutions to the appropriate scintillation vials.
14. Use a liquid scintillation counter to measure the radioactivity (by Cerenkov counting, please see Appendix 8) in all of the vials. Calculate the proportion of the total radioactivity that has eluted at each temperature, using the following equation:

$$x_j = \frac{\sum_{i=T_m-25^\circ\text{C}}^{T_j} n_i}{\sum_{i=T_m-25^\circ\text{C}}^{100^\circ\text{C}} n_i}$$

where  $x_j$  is the fraction of total radioactivity eluted at  $T_j$ ,  $n_i$  is the amount of radioactivity eluted at  $i = T_j$ , and  $T_j$  is the temperature under consideration from 25°C below the  $T_m$  to 30°C above the  $T_m$ .

If the experiment has worked well, very little radioactivity should be associated with the membranes containing vector DNA alone. Furthermore, this radioactivity should be completely released from the membranes at temperatures much lower than the estimated  $T_m$ . On the other hand, considerable radioactivity should be associated with the membranes containing the target DNA; the elution of this radioactivity should show a sharp temperature dependence. Very little radioactivity should be released from the membranes until a critical temperature is reached, and then ~90% of the radioactivity should be released during the succeeding 6–9°C rise in temperature.

The temperature at which 50% of the radioactivity has eluted from the membranes containing the target sequences is defined as the  $T_i$  of the hybrid between the probe and its target sequence.

## OLIGONUCLEOTIDE SYNTHESIS

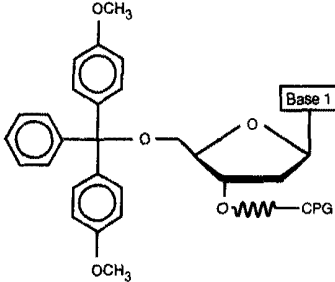
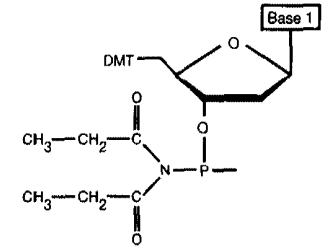
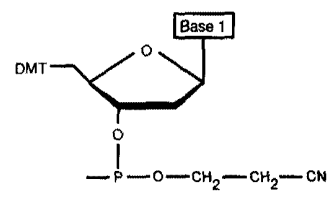
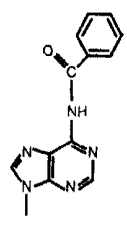
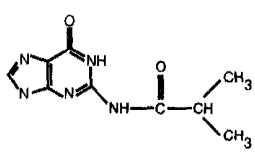
Until the early 1980s, the chemical synthesis of defined sequences of DNA was undertaken in smelly laboratories by large teams of investigators. And it was a frustratingly slow and wearisome business. The work for which H. Ghobind Khorana was awarded the Nobel prize in 1968 — synthesis of a functional tRNA gene — took several years and was published in serial form in more than 50 papers. As late as 1977, the state of the art was summarized by Amarnath and Broom: “Chemical methods for the synthesis of oligonucleotides have undergone dramatic improvement in the last two decades, but such goals as the synthesis of a tRNA molecule or the facile preparative synthesis of DNA genes still shimmer in the distance... We have a long way to go.” Elegant prose, but shortsighted, since just 1 year later, a synthetic cDNA encoding the insulin A and B chains was assembled from small synthetic oligonucleotides, cloned, and expressed in *E. coli* (Goeddel et al. 1979).

The key step in the chemical synthesis of DNA is the forging of phosphodiester bonds between specific nucleotides. Because the sugar moiety of deoxynucleotides contains two hydroxyl groups (at the 3' and 5' positions of the deoxyribose ring), one must be protected while the other is linked to the next deoxyribonucleoside unit. The transient protecting group must then be removed from the sugar to allow further extension of the oligonucleotide chain. The bases of deoxynucleosides also contain reactive groups (e.g., the exocyclic amino groups of adenine, cytosine, and guanine) that require protection throughout the entire synthetic process (please see Figure 10-3). These “persistent” protective groups must also be removed at the end of chain assembly. Khorana's work was carried out without the full benefit of phosphate-protecting groups, and extension of the growing chain was possible only because phosphodiester bonds became temporarily converted to substituted pyrophosphates during the coupling reaction, thereby allowing the sugar hydroxyl to participate in the reaction. However, this phosphodiester method was strangled by the inefficiency of each polymerization reaction and the progressive loss of selectivity during extension of the chain. Since the mid 1980s, virtually all oligonucleotide synthesis has used a combination of protective groups and solid-phase synthesis based on phosphoramidite chemistry (Beaucage and Caruthers 1981; McBride and Caruthers 1983; Sinha et al. 1984; for reviews, please see Atkinson and Smith 1984; Gait 1984; Beattie et al. 1988; Caruthers 1991; Caruthers et al. 1992; Sonveaux 1994; Pon et al. 1996).

A conventional synthetic cycle involves use of a solid-phase support (usually controlled-pore glass, less frequently polystyrene). The oligonucleotide is created one base at a time by esterifying the 3'-phosphate group of an appropriately protected phosphoramidite nucleoside to the 5'-hydroxyl of the terminal residue, which is attached to the solid phase support by a linker. The oligonucleotide therefore grows in a 3'→5' direction, the opposite of enzymatically catalyzed reactions. A round of coupling involves four types of reactions: mild alkaline hydrolysis, mild acid hydrolysis, nucleophilic displacements, and redox alterations. Unreacted chemicals are simply washed away after each stage of the coupling reaction. The trityl groups, which are released during each round of synthesis, are chromophores that absorb at 498 nm, and they can be used to monitor the efficiency of synthesis after every round of coupling.

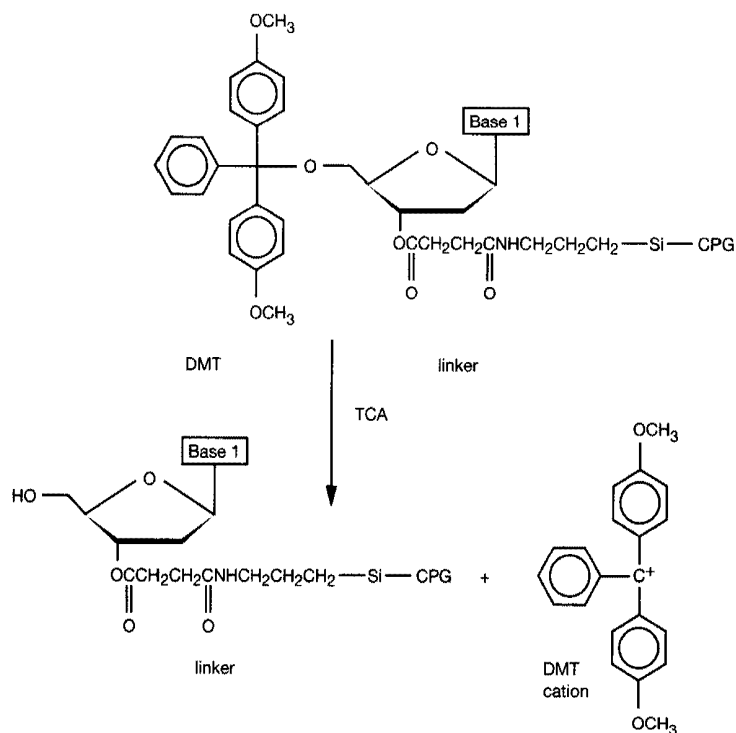
The terminal dimethoxytrityl group, being acid-labile, is then removed in trichloroacetic acid (TCA) to generate a compound with a free hydroxyl group, which is the only reactive nucleophile in the growing oligonucleotide (please see Figure 10-4). After the deblocking solution has been completely removed from the column and replaced with acetonitrile, the column is purged with an inert gas (argon or helium) to remove the acetonitrile and any traces of water. A molar excess of the appropriate phosphoramidite monomer is then reacted with the detritylated compound in the presence of an excess of activator (H-tetrazole) to give the phosphite triester intermediate (Figure 10-5). In this reaction, the nitrogen of the phosphoramidite becomes protonated, generating a good leaving group that is susceptible to attack by the free 5'-hydroxyl group of the growing oligonucleotide chain. The new bond between nucleotides is unstable in both acidic and basic solutions but can be reinforced by oxidation of the trivalent phosphorus to pentavalent phosphorus by a partially aqueous solution of iodine (Figure 10-6).

At each cycle in the synthesis, a small fraction (~1–2%) of the column-bound nucleosides do not condense with the incoming activated phosphoramidite. These nonproductive 5' ends must be capped to prevent them reacting with the next phosphoramidite and hence generating an oligonucleotide that lacks a base. Capping is achieved by acetylating the 5'-hydroxyl group with acetic anhydride in the presence of the catalyst *N*-methylimidazole (NMI) (Figure 10-7). When synthesis is completed, the oligonucleotide remains attached to the solid-phase support via a succinate ester, and the exocyclic groups of the bases still carry

Site of Protecting Group	Nature of Protecting Group	Comments	Structure of Protecting Group
The 5'-hydroxyl residue of the deoxyribose residue of the amidite	Dimethoxytrityl (4,4'-dimethoxytriphenylmethyl-) or monomethoxytrityl	The ether moiety protects the 5'-hydroxyl residue from reaction with the incoming phosphoramidite nucleoside	
The trivalent phosphate attached to the deoxyribose group on the incoming phosphoramidite nucleoside	Diisopropylamino-	Activated by tetrazole during coupling	
The trivalent phosphate attached to the deoxyribose group on the incoming phosphoramidite nucleoside	Cyanoethyl or Methoxy	Suppresses side reactions	
N <sup>6</sup> of the adenine and N <sup>4</sup> of the cytosine	Benzoyl	Protects nucleophilic functions of exocyclic amino groups	
N <sup>2</sup> of guanine	Isobutyryl	Protects nucleophilic functions of exocyclic amino groups	

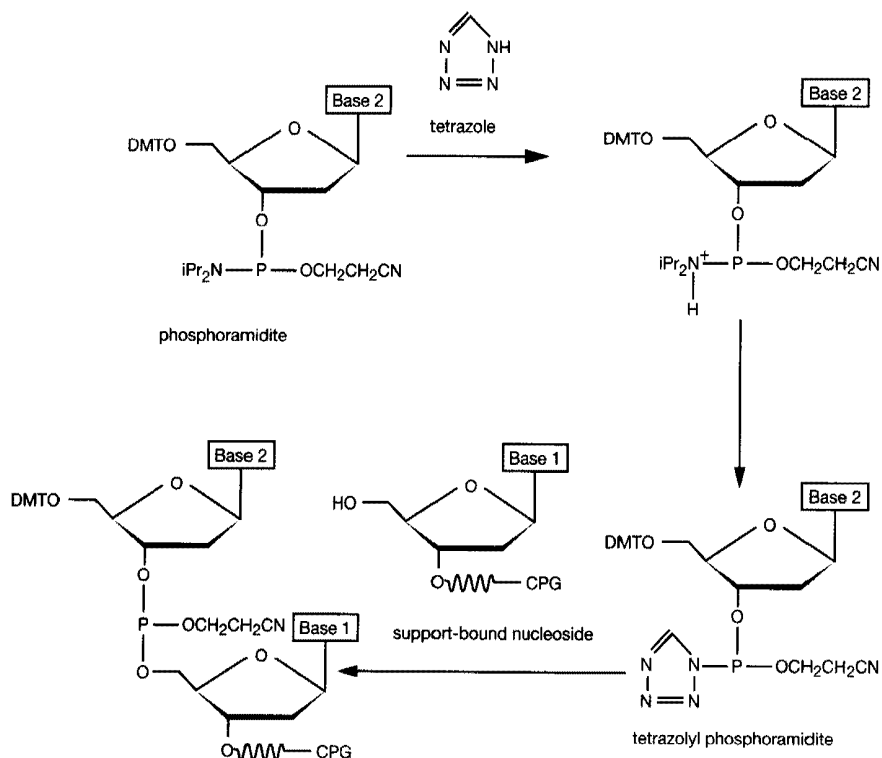
**FIGURE 10-3** Protecting Groups Used during Automated Synthesis of Oligonucleotides

(Structures redrawn, with permission, from PE Applied Biosystems.)



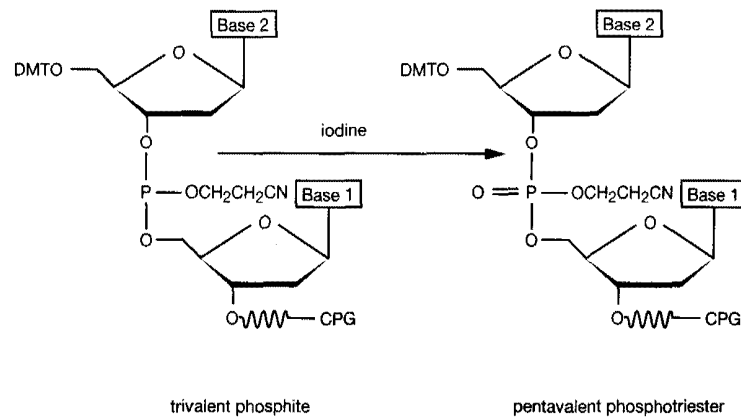
**FIGURE 10-4 Step 1: Detritylation of the Reactive Nucleoside Attached to the Support**

Please see the text for details of this reaction. (Redrawn, with permission, from PE Applied Biosystems.)



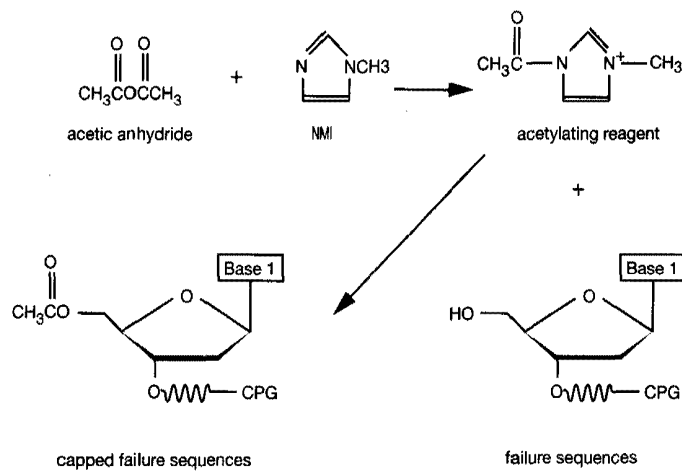
**FIGURE 10-5 Step 2: Coupling Reaction between the Phosphoramidite Monomer and the Detritylated Reactive Nucleoside**

Please see the text for details of this reaction. (Redrawn, with permission, from PE Applied Biosystems.)



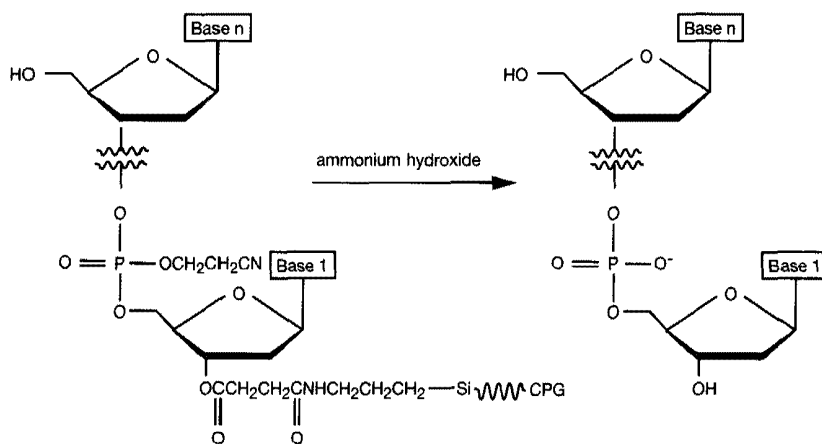
**FIGURE 10-6 Step 3: Oxidation of Phosphorus by Iodine**

Please see the text for details of this reaction. (Redrawn, with permission, from PE Applied Biosystems.)



**FIGURE 10-7 Step 4: Capping Reaction: Acetylation of the 5' OH Group with Acetic Anhydride**

Please see the text for details of this reaction. (Redrawn, with permission, from PE Applied Biosystems.)



**FIGURE 10-8 Step 5: Release of the Oligonucleotide Chain from the Column by Ammonium Hydroxide**

Please see the text for details of this reaction. (Redrawn, with permission, from PE Applied Biosystems.)

**TABLE 10-5** Expected Yield of Oligonucleotide Synthesis

SCALE OF SYNTHESIS	OD <sub>260</sub> UNITS X NUMBER OF BASES
40 nmoles	0.25–0.5
0.2 $\mu$ mole	1–1.5
1 $\mu$ mole	5
10 $\mu$ moles	40

their protective groups. Ammonium hydroxide is used both to release the oligonucleotide from the column and to cleave off the cyanoethyl groups protecting the phosphates (Figure 10-8).

Finally, hot ammonia is used to hydrolyze the amides protecting the exocyclic amino groups of deoxyadenosine, deoxycytosine, and deoxyguanosine. An additional (optional) detritylation step is required to remove the protective group from the 5'-hydroxyl group of the final nucleotide added to the oligonucleotide. The solution containing the released oligonucleotide is then evaporated to dryness in a lyophilizer. The completed oligonucleotide is generally supplied to the user in the form of a powder.

Almost all synthetic oligonucleotides are now prepared either individually or in pools by automated instruments sold by a variety of manufacturers. These instruments are capable of synthesizing nanomole, or even micromole, amounts of oligonucleotides as long as 70–100 nucleotides. In addition, many companies will custom-synthesize oligonucleotides of defined sequence at very reasonable prices. The minimum amount of an oligonucleotide synthesized by automatic machines (5–50 nmoles) is far in excess of the quantities usually required for labeling, DNA sequencing, PCR, or site-directed mutagenesis. Table 10-5 (obtained from PE Applied Biosystems) can be used to estimate the amount of oligonucleotide present in a given synthesis.



## MELTING TEMPERATURES

Heating a solution of double-stranded DNA unravels the duplexes by disrupting the hydrogen bonds that pin together complementary base pairs. Individual hydrogen bonds are relatively weak (~5 kcal/mole/bond) and thus are easily disrupted by heat. However, the greater the number of hydrogen bonds holding any two complementary strands of DNA together, the higher the temperature necessary to cause all of those bonds to break, separating the nucleic acid into two strands. This transition from double-stranded (helix) to single-stranded (coil) conformations as a function of temperature can be monitored as an increase in absorbance and is marked by a sharp increase in the extinction coefficient at the temperature where the conformational transition takes place. The temperature corresponding to the midpoint of the absorbance rise is called the melting temperature ( $T_m$ ). In structural terms, the  $T_m$  is the temperature at which 50% of the base pairs in a duplex have been denatured. This relationship between nucleic acid structure and thermal stability has been experimentally exploited for four decades.

Marmur and Doty (1959, 1962) used this relationship to establish that for a wide range of DNA samples, the  $T_m$  is a linear function of the sample's base composition. The slope of the line is 0.41°C per 1% increase in the (G+C) content. For thermal denaturation profiles of DNA samples (with a G+C content between 30% and 75%) run in 0.15 M NaCl and 15 mM Na citrate, the melting temperature is:

$$T_m = 69.3^\circ\text{C} + 0.41(\%[\text{G+C}]) \quad (1)$$

This equation makes it possible to estimate accurately the base composition of a DNA sample simply by measuring the  $T_m$  of the sample. To determine the  $T_m$  of DNA samples run under other salt conditions, use the more general equation:

$$T_m = 81.5^\circ\text{C} + 16.6 \log_{10} [M^+] + 0.41(\%[\text{G+C}]) \quad (2)$$

where  $[M^+]$  is the monovalent cation concentration for  $M^+ \leq 0.5$  M.

## Molecular Hybridization

The molecular hybridization techniques developed in the 1960s continue to be some of the most useful tools of the molecular biologist. Their simplicity and sensitivity have helped to drive a revolution in our understanding of gene structure, gene expression, and genome organization. These techniques have also been adapted as diagnostic tools in clinical laboratories and pharmaceutical companies.

Establishing optimal conditions for hybridization of a nucleic acid probe and its target sequence requires knowledge of the  $T_m$  of the target:probe duplex. Although under some circumstances, the  $T_m$  can be experimentally determined (please see Protocol 9 of this chapter), it is more common to calculate the  $T_m$ . A variety of equations have been derived that can be used to estimate the  $T_m$  of a target:probe duplex under a range of conditions.

At the  $T_m$ , when the probe and target are both polynucleotides, the molecules contain stretches of native duplex separated by denatured regions. The transition then from helix to coil is intramolecular and thus is independent of polynucleotide concentration (Wetmur 1991). The  $T_m$  is a function of base composition, solvent composition, duplex length, and extent of base pair mismatches (Hall et al. 1980; Wahl et al. 1987; Baldino et al. 1989). For DNA duplexes, Equation 2 has been modified by Wetmur (1991) to permit hybridization in salt up to 1 M NaCl:

$$T_m = 81.5 + 16.6 \log_{10} ([\text{Na}^+]/\{1.0 + 0.7[\text{Na}^+]\}) + 0.41(\%[\text{G+C}]) - 500/n - P - F \quad (3)$$

where  $n$  is the length of the duplex,  $P$  is the temperature correction for the percent mismatch of base pairs, which is typically 1°C per 1% mismatch, and  $F$  is 0.63°C per 1% formamide. For RNA duplexes:

$$T_m = 78 + 16.6 \log_{10} ([\text{Na}^+]/\{1.0 + 0.7[\text{Na}^+]\}) + 0.7(\%[\text{G+C}]) - 500/n - P - F \quad (4)$$

where  $F$  is 0.35°C per 1% formamide. For hybrids of RNA and DNA:

$$T_m = 67 + 16.6 \log_{10} ([\text{Na}^+]/\{1.0 + 0.7[\text{Na}^+]\}) + 0.8(\%[\text{G+C}]) - 500/n - P - F \quad (5)$$

where  $F$  is 0.5°C per 1% formamide. Variations on Equations 4 and 5 have been derived by Bodkin and Knudson (1985) and Casey and Davidson (1977), respectively.

When the probe is an oligonucleotide, at the  $T_m$ , half of the duplexes have separated. The transition from helix to coil is intermolecular, and thus the  $T_m$  is dependent on the oligonucleotide concentration (Wetmur 1991), as well as the oligonucleotide sequence and the composition of the solvent. Although various permutations of Equations 3 through 5 are frequently used, the use of %(G+C) is not sufficient to predict the  $T_m$ . A more accurate estimate of  $T_m$  can be obtained from a nearest-neighbor model that permits the incorporation of sequence-related thermodynamic data (Breslauer et al. 1986; Freier et al. 1986; Kierzek et al. 1986; Rychlik et al. 1990; Wetmur 1991; Rychlik 1994). One equation derived from such a model is:

$$T_m \text{ (in } ^\circ\text{C)} = (T^\circ \Delta H^\circ) / (\Delta H^\circ - \Delta G^\circ + RT^\circ \ln[c]) + 16.6 \log_{10} ([\text{Na}^+] / \{1.0 + 0.7[\text{Na}^+]\}) - 269.3 \quad (6)$$

where

$$\begin{aligned} \Delta H^\circ &= \sum_{nn} (N_{nn} \Delta H_{nn}^\circ) + \Delta H_p^\circ + \Delta H_e^\circ \\ \Delta G^\circ &= \sum_{nn} (N_{nn} \Delta G_{nn}^\circ) + \Delta G_i^\circ + \Delta G_e^\circ \\ N_{nn} &= \text{the number of nearest neighbors (e.g., 13 for a 14-mer)} \\ R &= 1.99 \text{ cal/mole-}^\circ\text{K} \\ T^\circ &= 298.2^\circ\text{K} \\ c &= \text{the total molar strand concentration} \\ [\text{Na}^+] &\leq 1 \text{ M} \end{aligned}$$

A number of the thermodynamic terms can be approximated:

$$\begin{aligned} \text{average nearest-neighbor enthalpies, } \Delta H_{nn}^\circ &= -8.0 \text{ kcal/mole} \\ \text{average nearest-neighbor free energies, } \Delta G_{nn}^\circ &= -1.6 \text{ kcal/mole} \\ \text{initiation term, } \Delta G_i^\circ &= +2.2 \text{ kcal/mole} \\ \text{average dangling end enthalpy, } \Delta H_e^\circ &= -8.0 \text{ kcal/mole/end} \\ \text{average dangling end free energy, } \Delta G_e^\circ &= -1 \text{ kcal/mole/end} \\ \text{average mismatch/loop enthalpy, } \Delta H_p^\circ &= -8.0 \text{ kcal/mole/mismatch} \end{aligned}$$

Note that for each mismatch or loop,  $N_{nn}$  is reduced by 2. At the opposite end of the complexity spectrum is the equation:

$$T_m = 2(A+T) + 4(G+C) \quad (7)$$

where  $(A+T)$  is the number of adenines and thymines in the oligonucleotide and  $(G+C)$  is the number of guanines and cytosines in the oligonucleotide, which works for short oligonucleotides that perfectly match their target sequence (Suggs et al. 1981b). More precisely, this equation predicts the dissociation temperature ( $T_d$ ) of an oligonucleotide hybridized to a target sequence that is bound to a solid support. For a detailed discussion of  $T_d$ , please see Wetmur (1991).

The differences in calculated  $T_m$  can be significant. For example, the predicted  $T_m$  for hybridization, in 0.5 M NaCl, of a 14-bp oligonucleotide probe that perfectly matches a sequence (with a %(G+C) = 50) in the target DNA will be 59°C using Equation 3, 55°C using Equation 6, and 42°C using equation 7.

## METHODS USED TO PURIFY SYNTHETIC OLIGONUCLEOTIDES

Purification of synthetic oligonucleotides may be required following synthesis or after enzymatic modification of the oligonucleotide, such as radiolabeling. Although purification is not always necessary (please see Protocol 1), it can, if required, be achieved by one of several methods.

### Oligonucleotides Lacking Trityl Groups

- **Denaturing polyacrylamide gel electrophoresis:** Denaturing polyacrylamide gel electrophoresis (PAGE) has a major advantage over other methods of purification: It resolves oligonucleotides according to their size and thereby allows full-length products to be separated from shorter incomplete molecules (Atkinson and Smith 1984). Table 10-6 presents the concentrations of acrylamide required for optimum resolution of synthetic oligonucleotides of different sizes. After electrophoresis, which is usually carried out with at least 1 mg/lane of synthetic oligonucleotide, the bands are located by UV-shadowing, and the oligonu-

**TABLE 10-6** Range of Resolution of Gels Containing Different Concentrations of Acrylamide

ACRYLAMIDE (%)	SIZE OF OLIGONUCLEOTIDES (IN BASES)
20–30	2–8
15–20	8–25
13–15	15–35
10–13	35–45
8–10	45–70
6–8	70–300

cleotide of the correct size is cut from the gel. The oligonucleotide is then recovered from the gel as described in Protocol 1 of this chapter (Atkinson and Smith 1984). Poor recovery of oligonucleotide is the sole disadvantage of denaturing PAGE as a method of purification. Typically, yields are less than 50%.

- **Reversed-phase cartridges:** Reversed-phase chromatography may be used to purify detritylated oligonucleotides after extraction from preparative polyacrylamide gels (please see Protocol 1).
- **Resins:** Oligonucleotides lacking trityl groups can be purified by chromatography on commercially available resins (e.g., NENSORB [NEN Life Science Products] and MERMAID [Q•BIOgene]). The properties of these solid-phase matrices differ significantly from one another, and it is therefore important to follow the instructions supplied with the resin. These resins do not remove shorter, incomplete oligonucleotides from the preparation but are nevertheless useful for removing low-molecular-weight compounds, for example, residual ammonium ions that may interfere with 5' phosphorylation of the oligonucleotide by bacteriophage T4 polynucleotide kinase.
- **High-performance liquid chromatography:** Oligonucleotides lacking a trityl group are fractionated according to charge. HPLC is not commonly used because it has a lower capacity (50–200 µg) and lower resolving power than PAGE, particularly for oligonucleotides <50 bases in length.

### Oligonucleotides Containing Trityl Groups

- **High-performance liquid chromatography:** Oligonucleotides carrying a trityl group may be fractionated by HPLC according to their hydrophobicity. PE Applied Biosystems supplies low-pressure, reversed-phase cartridges that specifically retain tritylated oligonucleotides. The retained oligonucleotides are released from their trityl groups, eluted with acetonitrile, and then dried to a powder. Unlike denaturing PAGE, these cartridges do not remove shorter, incomplete oligonucleotides from the preparation.
- **Oligonucleotide purification cartridges:** PE Applied Biosystems also manufactures a kit that can be used to desalt oligonucleotides and/or to purify rapidly oligonucleotides synthesized using the dimethoxytrityl blocking group. This group, which is attached to the 5'-hydroxyl group of nucleosides added to the growing oligonucleotide chain, is normally removed by TCA during routine syntheses (please see the information panel on **OLIGONUCLEOTIDE SYNTHESIS**). However, if the TCA cycle on the last step of a synthesis is omitted, the resulting oligonucleotide retains a dimethoxytrityl group at its 5' end. Oligonucleotide purification cartridges (OPCs) contain a resin with a high affinity for this bulky hydrophobic group and can be used to separate the complete oligonucleotide chain from incompletely synthesized oligonucleotides that do not contain the dimethoxytrityl group. The kit contains detailed instructions for the use of OPCs.

There are two reactions in which oligonucleotides purified by this method are less useful or contraindicated: as primers in DNA sequencing reactions and as probes (after annealing) in gel-retention assays. Use of OPC-purified oligonucleotides as primers in DNA-sequencing reactions results in a background smear at the bottom of the gel that can obscure the reading of 10–25 nucleotides immediately adjacent to the primer. Similarly, in gel-retention assays, annealed OPC-purified oligonucleotides produce smears at the bottom of the gel. If an oligonucleotide is to be used for either of these applications, then we recommend that the DNA be purified by gel electrophoresis and reversed-phase chromatography as described in Protocol 1.

## REFERENCES

- Agarwal K.L., Brunstedt J., and Noyes B.E. 1981. A general method for detection and characterization of an mRNA using an oligonucleotide probe. *J. Biol. Chem.* **256**: 1023–1028.
- Amarnath V. and Broom A.D. 1977. Chemical synthesis of oligonucleotides. *Chem. Rev.* **77**: 183–217.
- Anderson S. and Kingston I.B. 1983. Isolation of a genomic clone for bovine pancreatic trypsin inhibitor by using a unique-sequence synthetic DNA probe. *Proc. Natl. Acad. Sci.* **80**: 6838–6842.
- Andersson S., Davis D.L., Dahlbäck H., Jörnvall H., and Russell D.W. 1989. Cloning, structure, and expression of the mitochondrial cytochrome P-450 sterol 26-hydroxylase, a bile acid synthetic enzyme. *J. Biol. Chem.* **264**: 8222–8229.
- Atkinson T. and Smith M. 1984. Solid-phase synthesis of oligodeoxyribonucleotides by the phosphite-triester method. In *Oligonucleotide synthesis: A practical approach* (ed. M.J. Gait), pp. 35–82. IRL Press, Oxford, United Kingdom.
- Bains W. 1994. Selection of oligonucleotide probes and experimental conditions for multiplex hybridization experiments. *Genet. Anal. Tech. Appl.* **11**: 49–62.
- Baldino F.J., Chesselet M.F., and Lewis M.E. 1989. High resolution in situ hybridization. *Methods Enzymol.* **168**: 761–777.
- Beattie K.L., Logsdon N.J., Anderson R.S., Espinosa-Lara J.M., Maldonado-Rodriguez R., and Frost III, J.D. 1988. Gene synthesis technology: Recent developments and future prospects. *Biotechnol. Appl. Biochem.* **10**: 510–521.
- Beaucage S.L. and Caruthers M.H. 1981. Deoxynucleoside phosphoroamidates: A new class of key intermediates for deoxy-polynucleotide synthesis. *Tetrahedron Lett.* **22**: 1859–1862.
- Bennetzen J.L. and Hall B.D. 1982. The primary structure of the *Saccharomyces cerevisiae* gene for alcohol dehydrogenase. *J. Biol. Chem.* **257**: 3018–3025.
- Bird A.P. 1980. DNA methylation and the frequency of CpG in animal DNA. *Nucleic Acids Res.* **8**: 1499–1504.
- Bodkin D.K. and Knudson D.L. 1985. Assessment of sequence relatedness of double-stranded RNA genes by RNA-RNA blot hybridization. *J. Virol. Methods* **10**: 45–52.
- Bolton E.T. and McCarthy B.J. 1962. A general method for the isolation of RNA complementary to DNA. *Proc. Natl. Acad. Sci.* **48**: 1390.
- Bray P., Carter A., Simons C., Guo V., Puckett C., Kamholz J., Spiegel A., and Nirenberg M. 1986. Human cDNA clones for four species of  $\alpha_5$  signal transduction protein. *Proc. Natl. Acad. Sci.* **83**: 8893–8897.
- Breslauer K.J., Frank R., Blöcker H., and Marky L.A. 1986. Predicting DNA duplex stability from the base sequence. *Proc. Natl. Acad. Sci.* **83**: 8893–8897.
- Brown T., Hunter W.N., Kneale G., and Kennard O. 1986. Molecular structure of the G-A base pair in DNA and its implications for the mechanism of transversion mutations. *Proc. Natl. Acad. Sci.* **83**: 2402–2406.
- Cameron V., Soltis D., and Uhlenbeck O.C. 1978. Polynucleotide kinase from a T4 mutant which lacks the 3' phosphatase activity. *Nucleic Acids Res.* **5**: 825–833.
- Caruthers M.H. 1991. Chemical synthesis of DNA and DNA analogues. *Accts. Chem. Res.* **24**: 278–284.
- Caruthers M.H., Beaton G., Wu J.V., and Wiesler W. 1992. Chemical synthesis of deoxyoligonucleotides and deoxyoligonucleotide analogs. *Methods Enzymol.* **211**: 3–20.
- Casey J. and Davidson N. 1977. Rates of formation and thermal stabilities of RNA:DNA and DNA:DNA duplexes at high concentrations of formamide. *Nucleic Acids Res.* **4**: 1539–1552.
- Corfield P.W., Hunter W.N., Brown T., Robinson P., and Kennard O. 1987. Inosine-adenine base pairs in a B-DNA duplex. *Nucleic Acids Res.* **15**: 7935–7949.
- Crick F.H. 1966. Codon-anticodon pairing: The wobble hypothesis. *J. Mol. Biol.* **19**: 548–555.
- Davis B.D., Anderson P., and Sparling P.F. 1973. Pairing of inosine with adenosine in codon position two in the translation of polyinosinic acid. *J. Mol. Biol.* **76**: 223–232.
- Depew R.E. and Cozzarelli N.R. 1974. Genetics and physiology of bacteriophage T4 3'-phosphatase: Evidence for involvement of the enzyme in T4 DNA metabolism. *J. Virol.* **13**: 888–897.
- DiLella A.G. and Woo S.L. 1987. Hybridization of genomic DNA to oligonucleotide probes in the presence of tetramethylammonium chloride. *Methods Enzymol.* **152**: 447–451.
- Felsenfeld G. and Miles H.T. 1967. The physical and chemical properties of nucleic acids. *Annu. Rev. Biochem.* **31**: 407–448.
- Freier S.M., Kierzek R., Jaeger J.A., Sugimoto N., Caruthers M.H., Neilson T., and Turner D.H. 1986. Improved free-energy parameters for predictions of RNA duplex stability. *Proc. Natl. Acad. Sci.* **83**: 9373–9377.
- Gait M.J., ed. 1984. An introduction to modern methods of DNA synthesis. In *Oligonucleotide synthesis: A practical approach*, pp. 1–22. IRL Press, Oxford, United Kingdom.
- Geck P. and Nász I. 1983. Concentrated, digestible DNA after hydroxylapatite chromatography with cetylpyridinium bromide precipitation. *Anal. Biochem.* **135**: 264–268.
- Gitschier J., Wood W.I., Shuman M.A., and Lawn R.M. 1986. Identification of a missense mutation in the factor VIII gene of a mild hemophiliac. *Science* **232**: 1415–1416.
- Goeddel D.V., Kleid D.G., Bolivar F., Heyneker H.L., Yansura D.G., Crea R., Hirose T., Kraszewski A., Itakura K., and Riggs A.D. 1979. Expression in *Escherichia coli* of chemically synthesized genes for human insulin. *Proc. Natl. Acad. Sci.* **76**: 106–110.
- Goeddel D.V., Yelverton E., Ullrich A., Heyneker H.L., Miozzari G., Holmes W., Seeburg P.H., Dull T., May L., Stebbing N., Crea R., Maeda S., McCandliss R., Sloma A., Tabor J.M., Gross M., Familletti P.C., and Pestka S. 1980. Human leukocyte interferon produced by *E. coli* is biologically active. *Nature* **287**: 411–416.
- Hall K., Cruz P., and Chamberlin M.J. 1985. Extensive synthesis of poly[r(G-C)] using *Escherichia coli* RNA polymerase. *Arch. Biochem. Biophys.* **236**: 47–51.
- Hall T.J., Grula J.W., Davidson E.H., and Britten R.J. 1980. Evolution of sea urchin non-repetitive DNA. *J. Mol. Evol.* **16**: 95–110.
- Ikuta S., Takagi K., Wallace R.B., and Itakura K. 1987. Dissociation kinetics of 19 base paired oligonucleotide-DNA duplexes containing different single mismatched base pairs. *Nucleic Acids Res.* **15**: 797–811.
- Jacobs K.A., Rudersdorf R., Neill S.D., Dougherty J.P., Brown E.L., and Fritsch E.F. 1988. The thermal stability of oligonucleotide duplexes is sequence independent in tetraalkylammonium salt solutions: Application to identifying recombinant DNA clones. *Nucleic Acids Res.* **16**: 4637–4650.
- Jacobs K., Shoemaker C., Rudersdorf R., Neill S.D., Kaufman R.J.,

- Mufson A., Seehra J., Jones S.S., Hewick R., Fritsch E.F., et al. 1985. Isolation and characterization of genomic and cDNA clones of human erythropoietin. *Nature* **313**: 806–810.
- Jaye M., de la Salle H., Schamber F., Balland A., Kohli V., Findeli A., Tolstoshev P., and Lecocq J.P. 1983. Isolation of a human anti-haemophilic factor IX cDNA clone using a unique 52-base synthetic oligonucleotide probe deduced from the amino acid sequence of bovine factor IX. *Nucleic Acids Res.* **11**: 2325–2335.
- Kawase Y., Iwai S., Inoue H., Miura K., and Ohtsuka E. 1986. Studies on nucleic acid interactions. I. Stabilities of mini-duplexes (dG2A4XA4G2-dC2T4YT4C2) and self-complementary d(GGGAAAXYTTC) containing deoxyinosine and other mismatched bases. *Nucleic Acids Res.* **14**: 7727–7736.
- Kierzek R., Caruthers M.H., Longfellow C.E., Swinton D., Turner D.H., and Freier S.M. 1986. Polymer-supported RNA synthesis and its application to test the nearest-neighbor model for duplex stability. *Biochemistry* **25**: 7840–7846.
- Lathe R. 1985. Synthetic oligonucleotide probes deduced from amino acid sequence data. Theoretical and practical considerations. *J. Mol. Biol.* **183**: 1–12.
- Lin F.K., Suggs S., Lin C.H., Browne J.K., Smalling R., Egrie J.C., Chen K.K., Fox G.M., Martin F., Stabinsky Z., et al. 1985. Cloning and expression of the human erythropoietin gene. *Proc. Natl. Acad. Sci.* **82**: 7580–7584.
- Lo K.-M., Jones S.S., Hackett N.R., and Khorana H.G. 1984. Specific amino acid substitutions in bacteriopsin: Replacement of a restriction fragment in the structural gene by synthetic DNA fragments containing altered codons. *Proc. Natl. Acad. Sci.* **81**: 2285–2289.
- Marmur J. and Doty P. 1959. Heterogeneity in deoxyribonucleic acids. I. Dependence on composition of the configurational stability of deoxyribonucleic acids. *Nature* **183**: 1427–1429.
- 1962. Determination of the base composition of deoxyribonucleic acid from its thermal denaturation temperature. *J. Mol. Biol.* **5**: 109–118.
- Martin F.H., Castro M.M., Aboul-ela F., and Tinoco Jr., I. 1985. Base pairing involving deoxyinosine: Implications for probe design. *Nucleic Acids Res.* **13**: 8927–8938.
- McBride L.J. and Caruthers M.H. 1983. Nucleotide chemistry. 10. An investigation of several deoxynucleoside phosphoramidites useful for synthesizing deoxyoligonucleotides. *Tetrahedron Lett.* **24**: 245–248.
- Melchior Jr., W.B. and von Hippel P.H. 1973. Alteration of the relative stability of dA-dT and dG-dC base pairs in DNA. *Proc. Natl. Acad. Sci.* **70**: 298–302.
- Mitsuhashi M., Cooper A., Ogura M., Shinagawa T., Yano K., and Hosokawa T. 1994. Oligonucleotide probe design --- A new approach. *Nature* **367**: 759–761.
- Miyada C.G. and Wallace R.B. 1987. Oligonucleotide hybridization techniques. *Methods Enzymol.* **154**: 94–107.
- Nagata S., Tsuchiya M., Asano S., Kaziro Y., Yamazaki T., Yamamoto O., Hirata Y., Kubota N., Oheda M., Nomura H., et al. 1986. Molecular cloning and expression of cDNA for human granulocyte colony-stimulating factor. *Nature* **319**: 415–418.
- Nei M. and Li W.H. 1979. Mathematical model for studying genetic variation in terms of restriction endonucleases. *Proc. Natl. Acad. Sci.* **76**: 5269–5273.
- Newgard C.B., Nakano K., Hwang P.K., and Fletterick R.J. 1986. Sequence analysis of the cDNA encoding human liver glycogen phosphorylase reveals tissue-specific codon usage. *Proc. Natl. Acad. Sci.* **83**: 8132–8136.
- Ogden R.C., Lee M.C., and Knapp G. 1984. Transfer RNA splicing in *Saccharomyces cerevisiae*: Defining the substrates. *Nucleic Acids Res.* **12**: 9367–9382.
- Ohtsuka E., Matsuki S., Ikehara M., Takahashi Y., and Matsubara K. 1985. An alternative approach to deoxyoligonucleotides as hybridization probes by insertion of deoxyinosine at ambiguous codon positions. *J. Biol. Chem.* **260**: 2605–2608.
- Pon, R.T., Buck G.A., Hager K.M., Naeve C.W., Niece R.L., Robertson M., and Smith A.J. 1996. Multi-facility survey of oligonucleotide synthesis and an examination of the performance of unpurified primers in automated DNA sequencing. *BioTechniques* **21**: 680–685.
- Riccelli P.V. and Benight A.S. 1993. Tetramethylammonium does not universally neutralize sequence dependent DNA stability. *Nucleic Acids Res.* **21**: 3785–3788.
- Rychlik R. 1994. New algorithm for determining primer efficiency in PCR and sequencing. *J. NIH Res.* **6**: 78.
- Rychlik W., Spencer W.J., and Rhoads R.E. 1990. Optimization of the annealing temperature for DNA amplification in vitro (erratum *Nucleic Acids Res.* [1991] **19**: 698). *Nucleic Acids Res.* **18**: 6409–6412.
- Sanchez-Pescador R. and Urdea M.S. 1984. Use of unpurified synthetic deoxynucleotide primers for rapid dideoxynucleotide chain termination sequencing. *DNA* **3**: 339–343.
- Shapiro J.T., Stannard B.S., and Felsenfeld G. 1969. The binding of small cations to deoxyribonucleic acid. Nucleotide specificity. *Biochemistry* **8**: 3233–3241.
- Sibatani A. 1970. Precipitation and counting of minute quantities of labeled nucleic acids as cetyltrimethylammonium salt. *Anal. Biochem.* **33**: 279–285.
- Sinha N.D., Biernat J., McManus J., and Köster H. 1984. Polymer support oligonucleotide synthesis XVIII: Use of  $\beta$ -cyanoethyl-N,N-dialkylamino-/N-morpholino phosphoramidite of deoxynucleosides for the synthesis of DNA fragments simplifying deprotection and isolation of the final product. *Nucleic Acids Res.* **12**: 4539–4557.
- Sirotkin K., Cooley W., Runnels J., and Snyder L.R. 1978. A role in true-late gene expression for the T4 bacteriophage 5' polynucleotide kinase 3' phosphatase. *J. Mol. Biol.* **123**: 221–233.
- Smith M. 1983. Synthetic oligodeoxyribonucleotides as probes for nucleic acids and as primers in sequence determination. In *Methods of DNA and RNA sequencing* (ed. S.M. Weissman), pp. 23–68. Praeger Publishers, New York.
- Sonveaux E. 1994. Protecting groups in oligonucleotide synthesis. *Methods Mol. Biol.* **26**: 1–71.
- Sood A.K., Pereira D., and Weissman S.M. 1981. Isolation and partial nucleotide sequence of a cDNA clone for human histocompatibility antigen HLA-B by use of an oligodeoxynucleotide primer. *Proc. Natl. Acad. Sci.* **78**: 616–620.
- Studencki A.B. and Wallace R.B. 1984. Allele-specific hybridization using oligonucleotide probes of very high specific activity: Discrimination of the human  $\beta^A$ - and  $\beta^S$ -globin genes. *DNA* **3**: 7–15.
- Suggs S.V., Wallace R.B., Hirose T., Kawashima E.H., and Itakura K. 1981a. Use of synthetic oligonucleotides as hybridization probes: Isolation of cloned cDNA sequences for human beta 2-microglobulin. *Proc. Natl. Acad. Sci.* **78**: 6613–6617.
- Suggs S.V., Hirose T., Miyake T., Kawashima E.H., Johnson M.J., Itakura K., and Wallace R.B. 1981b. Use of synthetic oligodeoxyribonucleotides for the isolation of specific cloned DNA sequences. In *Developmental biology using puri-*

- fied genes* (ed. D.B. Brown et al.), pp. 683–693. Academic Press, New York.
- Takahashi Y., Kato K., Hayashizaki Y., Wakabayashi T., Ohtsuka E., Matsuki S., Ikehara M., and Matsubara K. 1985. Molecular cloning of the human cholecystokinin gene by use of a synthetic probe containing deoxyinosine. *Proc. Natl. Acad. Sci.* **82**: 1931–1935.
- Thein S.L. and Wallace R.B. 1986. The use of synthetic oligonucleotides as specific hybridization probes in the diagnosis of genetic disorders. In *Human genetic diseases: A practical approach* (ed. K.E. Davies), pp. 33–50. IRL Press, Oxford, United Kingdom.
- Toole J.J., Knopf J.L., Wozney J.M., Sultzman L.A., Buecker J.L., Pittman D.D., Kaufman R.J., Brown E., Shoemaker C., Orr E.C., et al. 1984. Molecular cloning of a cDNA encoding human antihaemophilic factor. *Nature* **312**: 342–347.
- Uhlenbeck O.C., Martin F.H., and Doty P. 1971. Self-complementary oligoribonucleotides: Effects of helix defects and guanylic acid-cytidylic acid base pairs. *J. Mol. Biol.* **57**: 217–229.
- Ullrich A., Berman C.H., Dull T.J., Gray A., and Lee J.M. 1984a. Isolation of the human insulin-like growth factor I gene using a single synthetic DNA probe. *EMBO J.* **3**: 361–364.
- Ullrich A., Gray A., Wood W.I., Hayflick J., and Seeburg P.H. 1984b. Isolation of a cDNA clone coding for the  $\gamma$ -subunit of mouse nerve growth factor using a high-stringency selection procedure. *DNA* **3**: 387–392.
- van Houten V., Denkers E., van Dijk M., van den Brekel M., and Brakenhoff R. 1998. Labeling efficiency of oligonucleotides by T4 polynucleotide kinase depends on 5'-nucleotide. *Anal. Biochem.* **265**: 386–389.
- Wada K., Wada Y., Ishibashi F., Gojobori T., and Ikemura T. 1992. Codon usage tabulated from the GenBank genetic sequence data. *Nucleic Acids Res. (suppl.)* **20**: 2111–2118.
- Wahl G.M., Berger S.L., and Kimmel A.R. 1987. Molecular hybridization of immobilized nucleic acids: Theoretical concepts and practical considerations. *Methods Enzymol.* **152**: 399–407.
- Wallace R.B., Johnson M.J., Hirose T., Miyake T., Kawashima E.H., and Itakura K. 1981. The use of synthetic oligonucleotides as hybridization probes. II. Hybridization of oligonucleotides of mixed sequence to rabbit  $\beta$ -globin DNA. *Nucleic Acids Res.* **9**: 879–894.
- Wetmur J.G. 1991. DNA probes: Applications of the principles of nucleic acid hybridization. *Crit. Rev. Biochem. Mol. Biol.* **26**: 227–259.
- Wood W.I., Gitschier J., Lasky L.A., and Lawn R.M. 1985. Base composition-independent hybridization in tetramethylammonium chloride: A method for oligonucleotide screening of highly complex gene libraries. *Proc. Natl. Acad. Sci.* **82**: 1585–1588.
- Wu R. 1972. Nucleotide sequence analysis of DNA. *Nat. New Biol.* **236**: 198–200.
- Xuan J.C. and Weber I.T. 1992. Crystal structure of a B-DNA dodecamer containing inosine, d(CGCI AATTCGCG), at 2.4 Å resolution and its comparison with other B-DNA dodecamers. *Nucleic Acids Res.* **20**: 5457–5464.
- Zoller M.J. and Smith M. 1984. Oligonucleotide-directed mutagenesis: A simple method using two oligonucleotide primers and a single-stranded DNA template. *DNA* **3**: 479–488.

# Chapter 11

---

## Preparation of cDNA Libraries and Gene Identification

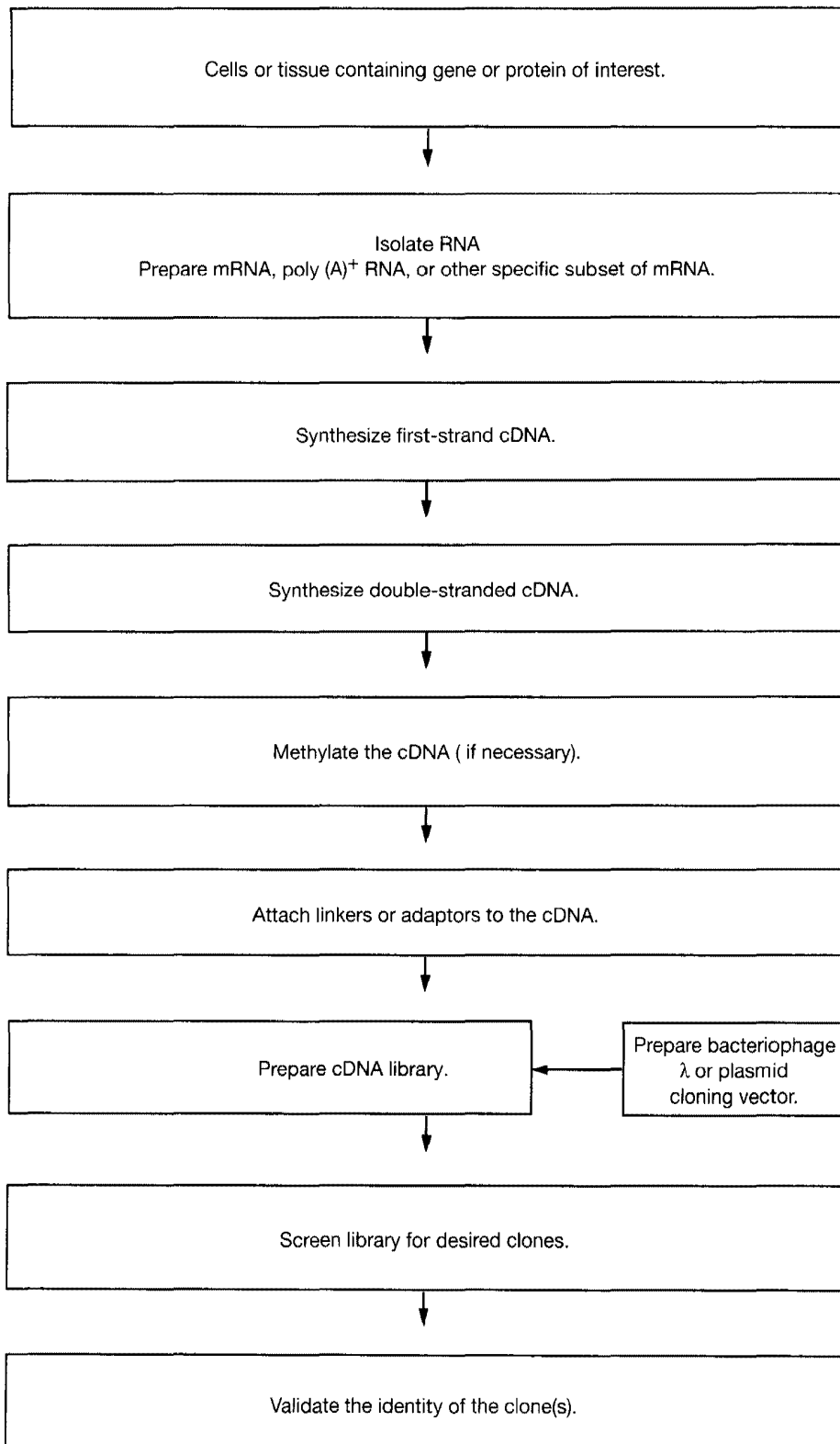
### INTRODUCTION

### PROTOCOLS

1	Construction of cDNA Libraries	11.37
	Stage 1: Synthesis of First-strand cDNA Catalyzed by Reverse Transcriptase	11.38
	Stage 2: Second-strand Synthesis	11.43
	Stage 3: Methylation of cDNA	11.48
	Stage 4: Attachment of Linkers or Adaptors	11.51
	Stage 5: Fractionation of cDNA by Gel Filtration through Sepharose CL-4B	11.56
	Stage 6: Ligation of cDNA to Bacteriophage $\lambda$ Arms	11.59
	• Alternative Protocol: Ligation of cDNA into a Plasmid Vector	11.63
	• Additional Protocol: Amplification of cDNA Libraries	11.64
2	Construction and Screening of Eukaryotic Expression Libraries	11.67
	Stage 1: Construction of cDNA Libraries in Eukaryotic Expression Vectors	11.68
	Stage 2: Screening cDNA Libraries Constructed in Eukaryotic Expression Vectors	11.74
3	Exon Trapping and Amplification	11.79
	Stage 1: Construction of the Library	11.81
	Stage 2: Electroporation of the Library into COS-7 Cells	11.85
	Stage 3: Harvesting the mRNA	11.87
	Stage 4: Reverse Transcriptase-PCR	11.89
	Stage 5: Analysis of Clones	11.95
4	Direct Selection of cDNAs with Large Genomic DNA Clones	11.98

### INFORMATION PANELS

Commercial Kits for cDNA Synthesis and Library Construction	11.107
Mo-MLV Reverse Transcriptase	11.109
Homopolymeric Tailing	11.110
$\lambda$ gt10 and $\lambda$ gt11	11.111
Constructing cDNA Libraries from Small Numbers of Cells	11.112
In Vitro Packaging	11.113
COS Cells	11.114
Biotin	11.115
Magnetic Beads	11.118
Ligation-independent Cloning	11.121



**FIGURE 11-1** Flowchart: Preparing and Screening a cDNA Library



**T**HE ENZYMATIC CONVERSION OF POLY(A)<sup>+</sup> MRNA TO DOUBLE-STRANDED DNA and the insertion of this DNA into prokaryotic and eukaryotic vectors have become fundamental tools of molecular biology. Since the first clones of complementary DNA (cDNA) were obtained in the mid 1970s, many different methods have been developed to increase the efficiency of synthesis of double-stranded cDNA and many improvements have been made to the vector systems. The first part of this introduction describes how these methods were developed and points out their advantages and disadvantages. The section on strategies for cDNA cloning outlines the major pathways by which cDNA libraries can be established from preparations of RNA. The strengths and limitations of each method are discussed, as are the options available at various stages of each pathway. Finally, we discuss the following in detail:

- preparation of mRNA for cDNA cloning
- procedures commonly used to synthesize cDNA
- vector-host systems used to construct and propagate cDNA libraries
- methods to screen cDNA libraries
- tests to validate cDNA clones
- exon amplification and trapping
- selection of cDNAs with large genomic DNA clones

The overall sequence of steps for preparing and screening a cDNA library as presented in this chapter is given in Figure 11-1. It is worth noting that the quality and number of premade cDNA libraries available from commercial sources have increased greatly in the past few years. In addition, custom-made cDNA libraries can be synthesized to order, sometimes at a reasonable price. As a consequence, fewer academic laboratories need to generate their own cDNA libraries. In most other chapters in this manual, we have been reluctant to recommend the use of kits. Here, however, we endorse them enthusiastically. For a discussion of the virtues and shortcomings of commercially available kits for cDNA synthesis and for construction of cDNA libraries, please see the information panel on **COMMERCIAL KITS FOR cDNA SYNTHESIS AND LIBRARY CONSTRUCTION** at the end of this chapter.

## DEVELOPMENT OF METHODS TO SYNTHESIZE AND CLONE cDNAs

---

Following the discovery of reverse transcriptase by Howard Temin and David Baltimore in 1970 (Baltimore 1970; Temin and Mizutani 1970), three different groups showed that the enzyme could be used *in vitro* with an oligo(dT) primer to synthesize single-stranded cDNA from mRNA templates (Bank et al. 1972; Ross et al. 1972; Verma et al. 1972). However, the size of the majority of the cDNA transcripts was considerably smaller than that of the template mRNAs, and techniques for synthesis of second-strand cDNA were not yet developed. After the methods of cloning fragments of DNA in plasmid vectors had been established by Cohen and Boyer (Cohen et al. 1973), a number of groups independently attempted to establish methods for cDNA cloning, and their results were reported within a 6-month span between late 1975 and mid 1976 (Rougeon et al. 1975; Maniatis et al. 1976; Rabbitts 1976; Rougeon and Mach 1976).

All of the early cDNA cloning methods used variations of the poly(dA)–poly(dT) tailing method developed by Lobban and Kaiser (1973) and employed by other investigators to insert SV40 DNA (Jackson et al. 1972) or *Drosophila* genomic DNA (Wensink et al. 1974) into plasmid

vectors. Rougeon et al. (1975) used oligo(dT) to prime synthesis of the first strand of cDNA, added a string of dT residues to the 3' end of the cDNA with terminal transferase, and then synthesized the second cDNA strand with *Escherichia coli* DNA polymerase I using oligo(dA) as a primer. The duplex cDNA was then tailed with oligo(dG) and joined to a plasmid that had been tailed with oligo(dC). As the authors pointed out, this approach generated only partial cDNA inserts, the transformation frequency was very low, and only one of the five clones obtained contained a short cDNA insert (Rougeon et al. 1975). Although this work demonstrated the feasibility of cloning fragments of cDNA, it did not provide a generally useful method for creating cDNA libraries.

A novel approach developed at about the same time involved the addition of homopolymeric dT tails to the ends of a plasmid vector and the use of these tails to prime the first cDNA strand synthesis from mRNA (Rabbitts 1976). The resulting molecules, which contained one cDNA at each terminus, were again treated with terminal transferase to generate dT tails and then annealed to a plasmid containing dA tails. The resulting double plasmid containing two single-stranded cDNAs was then used to transform bacteria. In this case, the second cDNA strand was synthesized in bacteria. Although cDNA recombinants were obtained by this approach, neither the size of the cDNA nor the fidelity of synthesis and propagation of the cDNA was evaluated (Rabbitts 1976).

The method of cDNA cloning most widely used from 1976 to 1985 was designed specifically to synthesize and clone full-length double-stranded cDNAs (Maniatis et al. 1976). The first step in establishing this approach was to optimize conditions for the synthesis of full-length single-stranded cDNA (Efstratiadis et al. 1975, 1976). This advance could not have been achieved without the development of high-resolution denaturing polyacrylamide gel electrophoresis and the availability of well-characterized synthetic single-stranded DNA size markers (Maniatis et al. 1975). Once this system became available, the efficiency of full-length cDNA synthesis could be monitored accurately under a variety of conditions. Routine synthesis of full-length cDNA copies of mRNA was quickly achieved by simple adjustments to the temperature and pH of the reaction and by using high concentrations of deoxynucleoside triphosphates (dNTPs) (Efstratiadis et al. 1975).

The strategy taken to synthesize the second cDNA strand was based in part on earlier observations that the reaction products of cDNA synthesis contain double-stranded regions (Leis and Hurwitz 1972). A significant portion of this double-stranded DNA rapidly regained resistance to single-strand-specific nucleases after denaturation, indicating the presence of intrastrand base-paired regions. Leis and Hurwitz (1972) speculated that this duplex DNA was produced by the generation of a hairpin structure at the 3' terminus of the first cDNA strand that could serve as a primer for second-strand synthesis by reverse transcriptase. Their hypothesis of self-primed synthesis was confirmed by showing that the products synthesized during the second-strand reaction consisted largely of single-stranded cDNAs twice the length of the original template mRNA (Efstratiadis et al. 1976). A key advance was the finding that the hairpin loop joining the first and second cDNA strands could be specifically digested with nuclease S1 (Efstratiadis et al. 1976). The double-length cDNA could thus be converted to duplex cDNA. Detailed characterization of the duplex cDNA with restriction enzymes demonstrated convincingly that full-length double-stranded DNA copies of mRNA could be produced in vitro (Efstratiadis et al. 1976). Cloning of the duplex cDNA was soon accomplished using the poly(dA)-poly(dT) tailing method (Maniatis et al. 1976). The utility of this approach to cDNA cloning was confirmed shortly thereafter by Higuchi et al. (1976).

At the time, there was concern about the fidelity of in vitro cDNA synthesis and the faithful propagation of cloned cDNAs in *E. coli*. Almost nothing was known about the fidelity of in vitro synthesis of the first cDNA strand by reverse transcriptase, nor of the second cDNA strand by *E. coli* DNA polymerase I. Whether cDNA sequences could be faithfully replicated in bacteria seemed to be a potentially significant problem considering that all of the early cDNA cloning

methods involved transformation with constructs that required gap filling and the generation of closed circular DNA *in vivo*. Obviously, almost any level of base substitution during synthesis and propagation of duplex cDNA would have severely hampered the use of this cloning method. It was therefore significant that the DNA sequence of the first full-length globin cDNA clone was identical to the sequence predicted from the amino acid sequence of the protein and the sequence of RNase T1 oligonucleotides of the mRNA (Efstratiadis et al. 1977). Subsequent DNA sequence analyses of hundreds of cDNA clones since that time have revealed that mistakes in synthesis and propagation of cDNAs are exceedingly rare.

The problem of fidelity of cDNA clones has arisen again recently as a consequence of the introduction of polymerase chain reaction (PCR)-based methods to clone cDNAs from minute amounts of mRNA (e.g., please see Ennis et al. 1990). There is no doubt that cDNA clones generated by standard PCR amplification of double-stranded cDNA contain a higher number of mutations than those generated by more traditional techniques. Ennis et al. (1990) estimate that an average of 1 nucleotide in ~1500 is mutated in cDNAs that have been cloned by PCR amplification. When error rates are this high, it would be foolish to rely on the nucleotide sequence of any single clone. To obtain a workable consensus sequence of the target cDNA, it is usually necessary to sequence between three and six independent cDNA clones. Better alternatives are (1) to reduce the number of errors during PCR by using a cocktail of thermostable polymerases (please see the section on thermostable DNA polymerases in the introduction to Chapter 8) or (2) to use the PCR-generated cDNAs as probes to screen a separate cDNA library constructed without the aid of amplification. However, this option is not always available when the quantities of mRNA are limiting.

## STRATEGIES FOR cDNA CLONING

---

As a consequence of a wide range of technical and theoretical advances, cDNA cloning is now well within the range of any competent laboratory. Comprehensive cDNA libraries can be routinely established from small quantities of mRNA, and a variety of reliable methods are available to identify cDNA clones corresponding to extremely rare species of mRNA. As the enzymatic reactions used to synthesize cDNA have improved, the sizes of cloned cDNAs have increased, and it is now possible to isolate full-length cDNAs corresponding to all but the largest mRNAs.

Before embarking on the synthesis and cloning of cDNA, it is essential to consider carefully which source material, methods, vectors, and screening procedures offer the best chance of success. The item of foremost concern is the method that will be used to screen the library. The process of screening is dictated chiefly by the information and reagents that are available — for example, whether the sequence of the protein is known or can be obtained, whether suitable antibodies are available, or whether a robust and sensitive biological assay exists to detect the target protein expressed from a cloned cDNA. The choice of vector, the steps involved in library construction, and the method by which the cDNA molecules are inserted into the vector are all factors that will be heavily influenced by the method that will be used to screen the library. Table 11-1 presents a guide to the options that are frequently used to construct and screen cDNA libraries.

## PREPARATION OF mRNA FOR cDNA CLONING

---

Discussed below are several considerations to be taken into account for the preparation of high-quality mRNA for use in cDNA cloning and selection.

**TABLE 11-1 Strategies for cDNA Cloning**

INFORMATION AND/OR REAGENTS AVAILABLE ABOUT THE TARGET PROTEIN	RECOMMENDED METHOD OF LIBRARY CONSTRUCTION	RECOMMENDED VECTOR <sup>a</sup>	RECOMMENDED METHOD OF SCREENING
Nucleic acid sequence of a cDNA encoding a homologous protein	Gubler-Hoffman procedure (Gubler and Hoffman 1983; Gubler 1988)	any standard plasmid, phagemid, or bacteriophage $\lambda$ vector	hybridization to synthetic oligonucleotides or to segment of DNA
Protein sequence of at least 15 contiguous amino acid residues	Gubler-Hoffman procedure (Gubler and Hoffman 1983; Gubler 1988)	any standard plasmid, phagemid, or bacteriophage $\lambda$ vector	hybridization to a synthetic guessmer or MOPAC probe
Protein sequence of < 15 contiguous amino acid residues	Gubler-Hoffman procedure (Gubler and Hoffman 1983; Gubler 1988)	any standard plasmid, phagemid, or bacteriophage $\lambda$ vector	hybridization to synthetic oligonucleotides
Antibody to target protein	directional cloning using the primer-linker modification of the Gubler-Hoffman procedure (Gubler and Hoffman 1983; Gubler 1988)	any bacteriophage $\lambda$ expression vector or plasmid expression vector	antibody-antigen recognition and complexing
Assay for expression of target protein	directional cloning using the primer-linker modification of the Gubler-Hoffman procedure (Gubler and Hoffman 1983; Gubler 1988); or plasmid priming of first-strand cDNA	expression vector tailored to the particular assay; e.g., assays for biological activity of proteins synthesized after transfection of cDNA clones into mammalian cells require that the library be constructed in an appropriate mammalian expression vector	analysis of pools of clones by biological assay

<sup>a</sup>For a list of vectors, please see Appendix 3.

## Source of the mRNA

Clearly, the higher the concentration of the sequences of interest in the starting mRNA, the easier the task of isolating relevant cDNA clones. It is therefore worthwhile investing some effort to ensure that the richest source of mRNA available is being used. This can be achieved, for example, by preparing mRNA from different cell lines or tissues for use in cell-free translation systems. Immunoprecipitation is then used to measure the amount of protein of interest synthesized for each set of mRNAs. In addition, some investigators have found ways to increase the concentration of the relevant mRNA by using drugs to select cell lines that overexpress particular proteins. For example, Luskey et al. (1983) describe the use of the drug compactin to develop a line of Chinese hamster ovary cells that have undergone a 15-fold increase in the number of gene copies and a much greater increase in the amount of mRNA coding for 3-hydroxy-3-methylglutaryl coenzyme A reductase (HMG CoA reductase). Others have taken advantage of the observation that treatment of infected cells with inhibitors of protein synthesis causes extended transcription of the early genes of mammalian DNA viruses (e.g., please see Persson et al. 1981). In these and a number of similar cases, increased abundance of specific classes of rare mRNAs greatly facilitated their subsequent cloning.

Ideally, estimates should be obtained of the frequency with which the mRNA of interest occurs in the starting preparation. This frequency not only determines the size of the cDNA library needed, but may also influence the method used to screen it. The first cDNA clones to be isolated were derived from abundant mRNAs such as those encoding globin, immunoglobulins, and ovalbumin. In these cases, the RNA species of interest constitutes as much as 50–90% of the

total poly(A)<sup>+</sup> RNA isolated from specific types of differentiated cells. Consequently, no further purification of the particular mRNA is required before double-stranded cDNA is synthesized and cloned. The desired cDNA clones can easily be identified by nucleic acid hybridization. The probes consist either of <sup>32</sup>P-labeled single-stranded cDNA synthesized in vitro from mRNA preparations rich in the sequences of interest or of mRNA that has been partially fragmented by limited alkaline hydrolysis and end-labeled by phosphorylation. As a good approximation, the mRNA sequences of interest will be represented in both the probe and the cloned double-stranded cDNAs in proportion to their abundance in the original preparation of mRNA. In cases such as globin, immunoglobulins, and ovalbumin, the chances are high that any colony hybridizing strongly to the probe will contain the desired DNA sequences. Although used extensively in the early days of cDNA cloning, this method no longer finds wide application, since few systems remain in which interesting uncloned mRNAs represent a sufficiently high proportion of the starting population.

RNAs that represent <0.5% of the total mRNA population of the cell are classified as "low-abundance" or "rare" mRNAs. The isolation of cDNA clones for mRNAs of this type presents two major problems: (1) construction of a cDNA library whose size is sufficient to ensure that the clone of interest has a good chance of being represented and (2) identification and isolation of the clone(s) of interest.

### Integrity of the mRNA

Since the cDNA library cannot be better than the mRNA from which it is derived, it is important to check the integrity of the preparation of mRNA before it is used as the template for synthesis of the first strand of cDNA. The following tests are commonly used:

- ***The ability of the mRNA to direct the synthesis of high-molecular-weight proteins in cell-free translation systems derived from reticulocytes.*** Bulk mRNA purified from mammalian cells should encode a large number of polypeptides with molecular weights ranging from <10,000 to >100,000.
- ***The ability of the mRNA to direct the synthesis of the polypeptide of interest in a cell-free system derived from reticulocytes.*** An aliquot of the translation products of the bulk mRNA is analyzed by immunoprecipitation and SDS-polyacrylamide gel electrophoresis. After autoradiography, the radioactive band can be excised from the gel and counted in a scintillation counter. The proportion of the total radioactivity contained in the band is an estimate of the relative concentration of the mRNA of interest.
- ***The size of the mRNA.*** If a sufficient quantity of mRNA is available, the mRNA should be fractionated by gel electrophoresis and stained with ethidium bromide (please see Chapter 7, Protocol 6). The mRNA should appear as a smear between ~500 bases and 8 kb. The bulk of the mRNA should lie between 1.5 kb and 2 kb. Transfer of the mRNA to a nitrocellulose or nylon membrane followed by hybridization with control cDNA probes is an additional check on the integrity of the mRNA preparation.
- ***The ability of the bulk mRNA preparation to direct the synthesis of long molecules of first-strand cDNA.*** cDNA synthesized from mammalian mRNA should run on an alkaline agarose gel as a continuous smear from ~500 bases to >5 kb. The bulk of the radioactivity should lie between 1.5 kb and 2 kb, and no specific bands of cDNA should be visible unless the mRNA was prepared from cells that express large quantities of specific mRNAs. In addition, the amount of radioactivity incorporated into the first strand of cDNA should be stimulated at least 20-fold by oligo(dT)<sub>12-18</sub> primers. Efficient cDNA synthesis in the absence of added

primer is a sign that the mRNA preparation may be contaminated with fragments of DNA or RNA that can bind to mRNA at random sites and serve as primers. If necessary, these fragments can be removed by denaturing the mRNA (100°C for 30 seconds in H<sub>2</sub>O), cooling quickly in ice water, and immediately selecting poly(A)<sup>+</sup> RNA by chromatography on oligo(dT)-cellulose.

### Methods of Enrichment

A typical mammalian cell contains between 10,000 and 30,000 different transcribed *sequences* (Davidson 1976; Welsh et al. 1990). However, the number of mRNA *species* per cell may be much greater because of differential splicing. Not all of these transcribed sequences are represented equally in the steady-state population of mRNA molecules. Instead, the proportional representation of each sequence depends on its rate of synthesis, half-life, and pattern of splicing: Genes that are actively transcribed into stable mRNAs make a greater contribution to the pool of mRNA molecules than genes that are transcribed sluggishly into less stable mRNAs. Some years ago, Williams (1981) determined the number of clones necessary to construct a complete cDNA library from a human fibroblast cell that contains ~12,000 different transcribed sequences. Rare mRNAs (<14 copies/cell) constitute ~30% of the mRNA, and ~11,000 different mRNAs belong to this class. The minimum number of cDNA clones required to obtain a complete representation of mRNAs of this class is therefore 11,000/0.30 or 37,000.

Of course, because of sampling variation and/or preferential cloning of certain sequences, a much larger number of recombinants must be obtained to increase the chance that any given clone will be represented in the library. The number of clones required to achieve a given probability that a low-abundance mRNA will be present in a cDNA library is:

$$N = \frac{\ln(1 - P)}{\ln(1 - [1/n])}$$

where  $N$  is the number of clones required,  $P$  is the probability desired (usually 0.99), and  $1/n$  is the fraction of the total mRNA that is represented by a single type of rare mRNA. Therefore, to achieve a 99% probability of obtaining a cDNA clone of an mRNA present in human fibroblasts at a frequency of ~14 molecules/cell:

$$\begin{aligned} P &= 0.99 \\ 1/n &= 1/37,000 \\ N &= 170,000 \end{aligned}$$

Unfortunately, many mRNAs of interest are present at even lower levels (1 molecule/cell is not unusual [Toole et al. 1984; Wood et al. 1984]). Furthermore, it is often necessary to clone cDNAs from populations of mRNAs isolated from tissues that consist of several cell types. In such cases, the frequency at which the sequences of interest are represented in the initial preparation of mRNA may be reduced still further, and it then becomes necessary to construct and screen libraries that contain several million independent cDNA clones. Since 1985, the efficiency with which cDNA can be synthesized and cloned has increased steadily to the point where cDNA libraries of this size can be generated routinely from 1–5 µg or less of poly(A)<sup>+</sup> mRNA. In principle, there is no a priori reason why even the most difficult cDNA clones — those corresponding to a very rare mRNA of large size — cannot be identified in such comprehensive libraries. However, screening large numbers of cDNA clones is both tedious and expensive. Methods have therefore been devised to enrich either the starting population of mRNA molecules or double-stranded cDNA synthesized from it for sequences of interest. Enrichment allows the size of the cDNA library to be reduced and decreases the cost and labor involved in screening for the desired cDNA clones.

It is difficult to offer specific guidelines regarding the circumstances that require enrichment procedures. As a rule of thumb, fractionation of mRNA is probably unnecessary if the cDNA of interest is expected to be present at a frequency  $\geq 1$  in  $10^6$  in a library of cDNA clones synthesized from unfractionated mRNA. Enrichment becomes more attractive as the number of clones to be screened increases above 1 million. Consequently, when designing a scheme to clone a specific cDNA, it is important to know the approximate frequency with which the mRNA of interest occurs in the bulk, unfractionated population of mRNA molecules using one or more of the methods described previously (please see the discussion on Integrity of the mRNA, above).

### ***Fractionation of mRNA by Size***

The simplest method to enrich preparations of mRNA for sequences of interest is to fractionate them according to size. Clearly, this method works best for mRNAs that are much larger or smaller in size than the bulk mRNA of the cell. The modal size of the mRNA population extracted from most types of mammalian cells is  $\sim 1.8$  kb, and mRNAs smaller in size than 700 bases or larger than 4 kb can be enriched at least tenfold by a single round of density gradient centrifugation carried out under denaturing conditions. However, it is important to remember that it is not possible to predict with certainty the size of an mRNA from the size of a protein for which it codes. There is considerable variation in the sizes of the untranslated regions of mRNAs (particularly the 3'-untranslated regions); many proteins purified from cells are cleavage products of larger precursors and many undergo extensive posttranslational modification. However, the size of the unmodified polypeptide chain provides a minimal estimate of the size of the mRNA: 10,000 daltons of an average polypeptide is encoded by  $\sim 280$  bases of mRNA.

Electrophoresis through agarose gels gives the best separation of molecules of mRNA of different sizes, but the recovery of RNA from gel slices is generally poor. Sedimentation through sucrose gradients formed in nondenaturing solvents results in good recovery, but the presence of secondary structure in the RNA often confounds effective fractionation. An alternative is sucrose gradient centrifugation in the presence of an agent, such as methylmercuric hydroxide, which denatures secondary structure in RNA (Schweinfest et al. 1982). Each fraction is then assayed for the presence of the mRNA that encodes the relevant polypeptide. Typically, an aliquot of the RNA in each fraction is translated in a cell-free system, and the resulting polypeptides are analyzed by immunoprecipitation and electrophoresis through polyacrylamide gels. Alternatively, aliquots are injected into *Xenopus* oocytes (for review, please see Melton 1987) and the resulting products are assayed either for biological activity or by immunoprecipitation and gel electrophoresis. The fraction that directs the synthesis of the greatest amount of the polypeptide product is then used as the starting material for construction of a cDNA library. A major drawback of this method of mRNA fractionation is the need to work with methylmercuric hydroxide, a poisonous compound of insidious toxicity.

### ***Fractionation of cDNA***

Until the mid 1980s, fractionation of mRNA was the method of choice for cloning mRNAs that encode large proteins. However, as methods for the synthesis of cDNA have improved, fractionation of double-stranded cDNA has become a more practical alternative, and there are now many examples of extremely large cDNAs that have been cloned by fractionating cDNA, rather than the mRNA from which it was copied; for example, human factor VIII:C (Toole et al. 1984; Wood et al. 1984), human sucrase-isomaltase (Hunziker et al. 1986), and human LDL-receptor-related protein (Herz et al. 1988). Fractionation of cDNA has major advantages: DNA is less susceptible than mRNA to degradation by contaminating nucleases; it can be fractionated more accurately by electrophoresis through agarose gels or neutral sucrose gradients (Kieffer 1991); and since the

fractionation can be carried out at a late stage during the cDNA cloning protocol, the chance of subsequent mishaps is reduced and the probability of obtaining a full-length clone of cDNA is increased. Fractionation is usually carried out after all of the enzymatic reactions involved in cDNA synthesis have been completed and just before the cDNA is inserted into a vector.

### ***Immunological Purification of Polysomes***

An alternative method of enrichment, now rarely employed, uses antibodies to purify polysomes that are trapped in the act of synthesizing the polypeptide of interest. The technique described originally (Palacios et al. 1972; Schechter 1973), which involved the immunoprecipitation of polysomes, worked well for mRNAs encoding abundantly synthesized proteins such as albumin and immunoglobulin, but attempts to apply the method to mRNAs of lesser abundance were generally disappointing. However, the introduction of immunoaffinity columns (Schutz et al. 1977) and protein A-Sepharose columns (Shapiro and Young 1981) led to a brief resurgence of the technique in the mid 1980s. For example, Korman et al. (1982) used a monoclonal antibody directed against the heavy chain of the human HLA-DR histocompatibility antigen to bind polysomes synthesizing the nascent protein to protein A-Sepharose columns. The polysomes were then dissociated with EDTA (ethylenediaminetetraacetic acid) and the mRNA was isolated by oligo(dT) chromatography. The immunoaffinity-purified mRNA, which represented only 0.01–0.05% of the total mRNA, was used both to prepare cDNA probes and to construct cDNA clones. Using similar methods with polyclonal antisera, Kraus and Rosenberg (1982) obtained a 6300-fold purification of the mRNA that encodes rat liver cystathionine  $\beta$ -synthase, and Russell et al. (1983) isolated cDNA clones for the bovine low-density lipoprotein receptor, whose mRNA is present at ~80 copies/cell in bovine adrenal cells.

Although a powerful technique, immunoaffinity purification of polysomes cannot be applied universally. First, it clearly will not work unless a reliable source of material is available from which to isolate functional polysomes. This is not always possible, especially when the starting material is a tissue or organ that is not commonly available. Second, it has not yet been shown to work for mRNAs that are extremely rare (1 molecule/cell or less). Furthermore, the success of the method depends entirely on the specificity, avidity, and type of the particular immunoglobulin, and the results obtained with one antibody cannot always be translated directly to another. Finally, the method requires the use of relatively large quantities of antibody. Partly because of these difficulties, immunoaffinity purification of polysomes has been superseded by development of cDNA expression vectors (e.g.,  $\lambda$ gt11 and  $\lambda$ ZAPII) that allow the direct isolation of cDNA clones encoding specific antigens.

### ***Subtractive Cloning***

It is never easy to identify cDNAs corresponding to mRNAs that are expressed in low abundance. However, the problem has been ameliorated by improvements in methods used to construct subtracted cDNA libraries.

The aim of subtractive cloning is to remove sequences that are of no interest from the cDNA preparation before constructing a library. If everything works well, this results in an enrichment of the target sequences. Removal of unwanted sequences is achieved by hybridizing single-stranded cDNA prepared from mRNA extracted from the tissue of interest to a 10–20-fold excess of DNA or RNA (driver) prepared from another source that does not express the genes of interest. After hybrids containing the cDNA have been removed, the residual cDNA molecules are cloned. Until recently, subtractive cloning involved using very large amounts of poly(A)<sup>+</sup> RNA to drive small amounts of cDNA into hybrids. The DNA-RNA hybrids were then separated from unhybridized cDNA by hydroxyapatite chromatography (e.g., please see Sargent and Dawid 1983;



Hedrick et al. 1984; Sargent 1987; Travis et al. 1987; Travis and Sutcliffe 1988). Nowadays, bacteriophage promoters can be used to generate RNA drivers from populations of cloned cDNAs, PCR can be used to generate DNA drivers (Timblin et al. 1990) from cDNAs cloned in single-stranded vectors (Duguid et al. 1988; Rubenstein et al. 1990), and hybrids can be captured by biotin:avidin affinity chromatography (Duguid et al. 1988; Rubenstein et al. 1990) or on latex beads (Hara et al. 1991). For a good general review, please see Sagerstrom et al. (1997).

## CURRENT METHODS OF SYNTHESIZING cDNA

---

The basic strategy for enzymatic conversion of mRNA to cDNA has changed little since the mid 1970s, but there have been great improvements to the efficiency of the entire process. In addition, there is now a choice among several enzymes at many steps.

### Synthesis of First-strand cDNA

The first strand of cDNA is synthesized by an RNA-dependent DNA polymerase reverse transcriptase using poly(A)<sup>+</sup> RNA (or mRNA) as a template and primed by either oligo(dT) or random oligonucleotide primers.

#### **Reverse Transcriptase**

Several different forms of reverse transcriptase are available commercially:

- **Avian reverse transcriptase**, which is purified from particles of an avian leukemia virus (ALV).
- **Murine reverse transcriptase**, which is isolated from a strain of *E. coli* that expresses a cloned copy of the reverse transcriptase gene of the Moloney strain of murine leukemia virus (Mo-MLV).

Commercial preparations of both ALV and Mo-MLV are now reasonably free of contaminating RNase, which, in the past, was a major impediment to the synthesis of large cDNA. However, some preparations of the avian enzyme are contaminated by an endonuclease that cleaves DNA, although this is less of a problem today than it was in the early 1980s. The avian enzyme consists of two nonidentical polypeptide subunits that carry several enzymatic activities: RNA-dependent synthesis of DNA (reverse transcriptase), endonucleolytic cleavage of DNA (integrase), and endonucleolytic attack on the RNA moiety of DNA-RNA hybrids followed by processive exonucleolytic removal of rNTPs (RNase H) (for reviews, please see Champoux 1993; Prasad 1993; Skalka 1993). The murine enzyme consists of a single polypeptide subunit that carries out both RNA- and DNA-dependent synthesis of DNA but has a reduced capacity to degrade RNA in DNA-RNA hybrids. Murine reverse transcriptase also lacks a contaminating endonuclease activity (Gerard 1983; Kotewicz et al. 1988).

The avian enzyme available from many manufacturers is adequate for routine construction of cDNA libraries. However, the high level of RNase H activity of the avian enzyme tends both to suppress the yield of cDNA and to restrict its length. At the beginning of the reaction, the hybrids formed between the template mRNA and the primer are a substrate for RNase H. Thus, at the beginning of cDNA synthesis, there is a competition between degradation of the mRNA and initiation of DNA synthesis (for review, please see Champoux 1993). In addition, the RNase H activity can cleave the RNA template near the 3'-hydroxyl terminus of the growing DNA strand if the polymerase pauses during synthesis (Kotewicz et al. 1988). Thus, the murine enzyme, with its weaker complement of endogenous degradative activities, is a safer choice when attempting to obtain full-length cDNA copies of mRNAs larger than 2–3 kb in length. The murine and avian enzymes display different salt and temperature optima for the synthesis of cDNA from RNA tem-

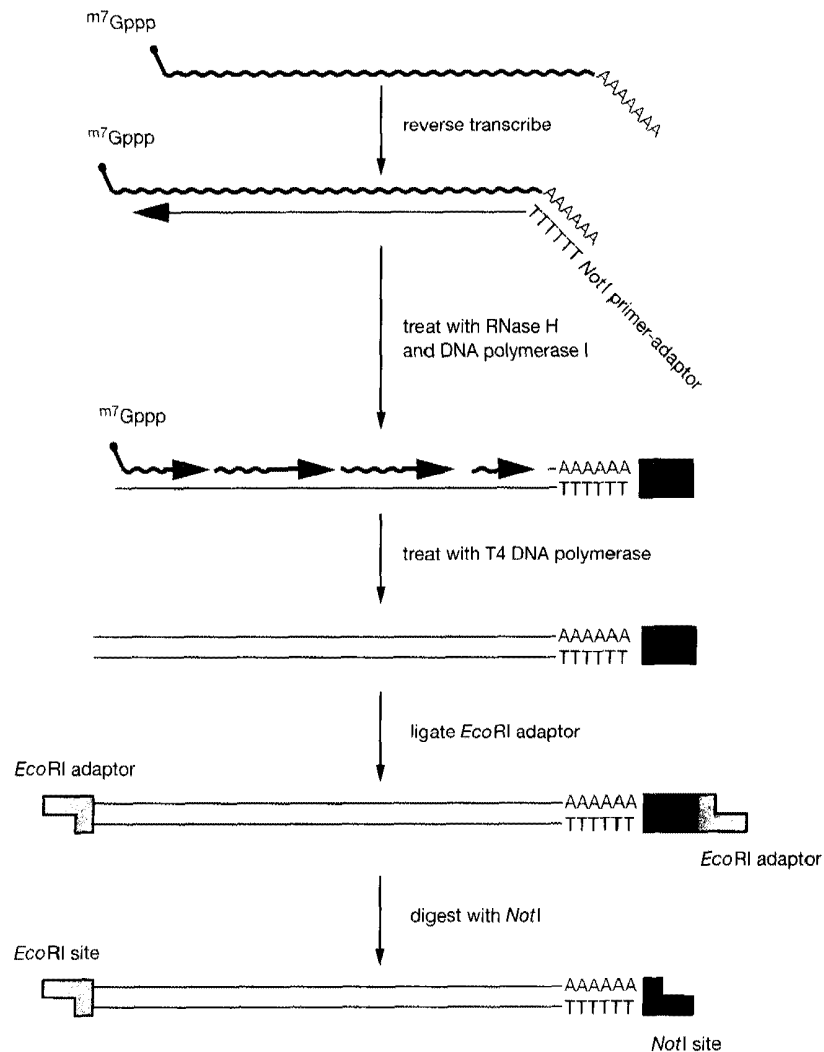
plates, and it is therefore important to modify the conditions for first-strand synthesis accordingly.

Reverse transcriptases lacking RNase H activity (e.g., SuperScript from Life Technologies) are genetically engineered versions of the murine enzyme that carry mutations that drastically reduce RNase H activity without any diminution in DNA polymerase activity (Gerard et al. 1992; Gerard and D'Alessio 1993). The total yield of first-strand cDNA is substantially higher with these enzymes than with nonengineered reverse transcriptases, and the proportion of full-length cDNAs is significantly greater (Kotewicz et al. 1988; Gerard et al. 1989, 1992; Gerard and D'Alessio 1993; Telesnitsky and Goff 1993). In addition, because the polymerizing activity of the enzyme is not inhibited by high temperatures, synthesis of first-strand cDNA can be carried out at temperatures as high as 50°C. This is an advantage when the template RNA is tightly crimped into secondary structures. For further information on these enzymes, please see the information panel on **Mo-MLV REVERSE TRANSCRIPTASE**.

### **Primers for Synthesis of First-strand cDNA**

Listed below are four types of primers used to synthesize first-strand cDNA.

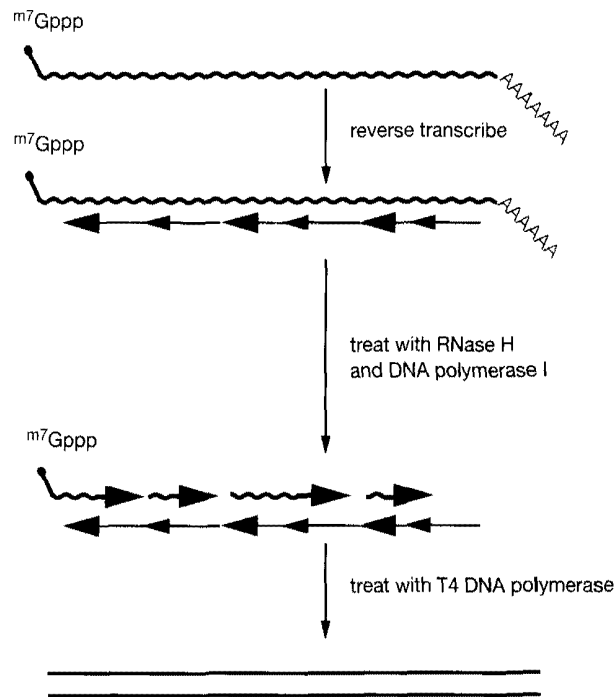
- **Oligo(dT) 12–18 nucleotides in length that binds to the poly(A) tract at the 3' terminus of eukaryotic cellular mRNA molecules.** The primer is added to the reaction mixture in large molar excess so that each molecule of mRNA binds several molecules of oligo(dT)<sub>12-18</sub>. Sequencing of cloned cDNAs shows that priming of first-strand synthesis probably begins from the most proximal of these bound primers and is very efficient.
- **Primer-adaptors that contain a homopolymeric oligo(dT) tract at the 3' terminus and a restriction site at the 5' terminus** (Coleclough and Erlitz 1985; Krawinkel and Zobelein 1986; Han et al. 1987). The oligo(dT) sequences are used to prime synthesis of the first strand, which can then be tailed with dC residues. This procedure allows the DNA to be ligated to a vector before synthesis of the second strand (Coleclough and Erlitz 1985), or it enables a second primer-adaptor to be used to prime the synthesis of second-strand cDNA (please see Figure 11-2).
- **Primers linked to a plasmid.** Priming of first-strand synthesis is carried out by a tract of oligo(dT) that is covalently attached to a plasmid (Okayama and Berg 1982, 1983; Okayama et al. 1987). Because it is often not possible to incorporate enough oligomerically tailed plasmid in the reaction mixture to achieve a high ratio of primer to template, priming is usually the rate-limiting step during this kind of reaction. This limitation results in less efficient utilization of mRNA templates during synthesis of the first strand of cDNA. However, the reduction in yield of the first strand of cDNA is offset, at least in part, by the increased efficiency of cloning that results from the direct covalent attachment of the cDNA to the vector. Libraries made according to the original Okayama-Berg protocol (1982, 1983) are generally moderate in complexity and have a high proportion of full-length cDNAs. The chief disadvantage of the original protocol is that it is lengthy, demanding, and involved. Newer procedures that also use asymmetrically tailed plasmid to prime synthesis of first-strand cDNA are much simpler and yield libraries of higher complexity (e.g., please see Bellemare et al. 1991; Spickofsky and Margolskee 1991).
- **Random primers.** Even the best cDNA libraries contain only a small proportion of full-length clones. If the synthesis of first-strand cDNA was incomplete, the clones will lack sequences from the 5' end of the mRNA. If synthesis of second-strand cDNA was arrested or blocked, the 3' end of the mRNA will be underrepresented in the library. These problems can be amelio-



**FIGURE 11-2 Priming cDNAs with an Oligo(dT) Adaptor for Directional Cloning**

The first-strand reaction of cDNA synthesis is primed by oligo(dT) sequences linked to a primer-adaptor encoding a restriction endonuclease recognition site (in this case, *NotI*). The sequence of mRNA is represented by the colored (wiggly) strand, whereas the oligo(dT)-adaptor is shown in black. Treatment of the RNA-DNA hybrid with RNase H and DNA polymerase I nicks the RNA moiety, creating 3'-hydroxyl termini that are used by T4 DNA polymerase to complete the second-strand synthesis. Ligation of *EcoRI* adaptors to the double-stranded cDNA product and cleavage with *NotI* allow the product to be inserted in a directed manner into an appropriate vector.

rated by using random oligonucleotides (usually hexamers) as primers (please see Figure 11-3). However, although this strategy may solve one problem, it also creates others. cDNA clones derived from random priming of first-strand cDNA tend to be smaller than clones derived from oligo(dT) priming. In addition, the efficiency of priming varies from one RNA to another, depending on the size of the mRNA and the complexity and composition of the random oligonucleotide pool. If the use of random primers creates problems, there are alternative ways to generate cDNA clones containing 5'- and 3'-terminal regions of mRNAs, for example, 5' RACE and 3' RACE (please see Chapter 8, Protocols 9 and 10). For a summary of methods to synthesize first-strand cDNA, please see Table 11-2.



**FIGURE 11-3 Random Priming of cDNAs**

Synthesis of first-strand cDNA is initiated by random oligonucleotides, usually hexamers (represented as black arrows) that are extended by reverse transcriptase (extension products are shown as colored arrows). Treatment with RNase H and DNA polymerase I nicks the RNA and repairs gaps in the cDNA. Second-strand synthesis is carried out by T4 DNA polymerase.

### Synthesis of Second-strand cDNA

For many years, there was no effective way other than self-priming to synthesize the second strand of cDNA, and almost all clones of cDNA made before 1982 were obtained using this enzymatic reaction (e.g., please see Efstratiadis et al. 1976; Higuchi et al. 1976; Maniatis et al. 1976; Rougeon and Mach 1976). The self-primed synthesis of the second strand of cDNA was at best a poorly controlled reaction, and the subsequent cleavage of the hairpin structure with nuclease S1 almost invariably led to the loss or rearrangement of sequences corresponding to the 5' terminus of the mRNA (Land et al. 1981). Consequently, this scheme for synthesizing double-stranded cDNA molecules has now been largely replaced by more efficient and less destructive methods (please see below) that yield 10–100 times more cDNA clones than self-priming (Okayama and Berg 1982; Gubler and Hoffman 1983).

Today, second-strand synthesis is usually catalyzed by *E. coli* DNA polymerase I and *E. coli* RNase H. However, other enzymes including thermostable DNA polymerases such as *Tth* and *Taq* are also used, albeit rarely. The conditions used to achieve synthesis of full-length second-strand cDNA depend on the particular DNA polymerase. Reactions that use *E. coli* DNA polymerase I are usually carried out at pH 6.9 to minimize the 5'→3' exonuclease activity of the enzyme and at 15°C to minimize the possibility of synthesizing “snapback” DNA. These problems can be completely avoided by using either reverse transcriptase or the Klenow fragment, both of which lack 5'→3' exonuclease activity and are available in pure form from commercial sources. *E. coli* DNA ligase is sometimes included in the reaction because evidence indicates that the efficiency of

**TABLE 11-2 Methods to Synthesize First-strand cDNA****Priming with Oligo(dT)**

**Advantages:** Efficient and simple.

Allows use of the Gubler and Hoffman (1983) procedure for synthesis of the second strand of cDNA.

Because different linkers or adaptors can be added at each end of the cDNA, directional cloning is possible and there is great flexibility in choice of vectors.

**Disadvantages:** Linkers, tails, or adaptors must be added before the cDNA is inserted into the vector.

Many procedures require that the double-stranded cDNA be digested with a restriction enzyme(s) before cloning. This step can be risky because the cDNA of interest itself may be cleaved. Potential restriction sites can be protected by methylation of double-stranded cDNA or incorporation of methylcytosine residues during synthesis of first-strand cDNA. In either case, a strain of *E. coli* defective in the *mcr* restriction system should be used as a host. *mcr*<sup>+</sup> strains restrict DNA carrying methylcytosine residues (Raleigh et al. 1988; Woodcock et al. 1989).

The background of empty clones is generally much higher than that in plasmid-primed methods.

Most cDNA libraries constructed by oligo(dT) priming are enriched for sequences that lie at the 3' end of the mRNAs.

**Priming with Primer-Adaptors**

**Advantages:** Synthesis of the second strand can be carried out after the homopolymerically tailed cDNA has been ligated to a vector.

Alternatively, second-strand synthesis can be carried out using the Gubler-Hoffman method (Gubler and Hoffman 1983; Gubler 1988). In this case, directional cloning of the cDNA can be achieved by the use of a linker-primer and an adaptor for the restriction enzyme *Sfi*I (Miki et al. 1989).

The background of empty clones is generally lower with primer-adaptors than with oligo(dT)-primed synthesis of the first strand. Both plasmids and bacteriophage  $\lambda$  vectors can be used.

**Disadvantages:** Many protocols require the elimination of small oligonucleotides and unused primers from the first strand of cDNA by electrophoresis through alkaline agarose gels. The recovery of DNA at this stage is often poor.

**Plasmid-primed Methods**

**Advantages:** Selects for full-length or nearly full-length clones, perhaps because long cDNAs are preferred substrates for terminal transferase.

Whereas the original protocol (Okayama and Berg 1982) generated libraries of modest complexity, more recent versions are claimed to be extremely efficient and to generate almost  $10^7$  to  $10^9$  clones/ $\mu$ g of linker-primer DNA (Bellemare et al. 1991; Spickofsky and Margolskee 1991).

**Disadvantages:** The original protocol (Okayama and Berg 1982) was difficult and lengthy. More modern versions (e.g., please see Bellemare et al. 1991; Spickofsky and Margolskee 1991) are slightly easier but remain demanding.

Restricted to plasmid vectors.

**Priming with Random Populations of Oligonucleotides**

**Advantages:** Priming of first-strand cDNA by random primers (Golet et al. 1982; Binns et al. 1985) can sometimes improve the efficiency of cloning 5' sequences of a particular mRNA.

**Disadvantages:** cDNAs generated by random priming tend to be small and must be carefully fractionated according to size to eliminate the useless population of tiny molecules. Random hexamers are usually removed between synthesis of first and second cDNA strands.

**RT-PCR Methods**

**Advantages:** "Universal primers" may be used for amplification of all mRNAs, regardless of their sequence (please see the information panel on **UNIVERSAL PRIMERS** in Chapter 8). These are used to generate cDNA libraries when only small amounts of poly(A)<sup>+</sup> RNA (<200 ng) are available. Other PCR protocols rely on gene-specific primers that are unique to or selective for particular target cDNAs (Frohman et al. 1988). For example, the 5' RACE method allows amplification of the 5' end of mRNAs for which some sequence near the 5' end is known (please see Chapter 8, Protocol 9).

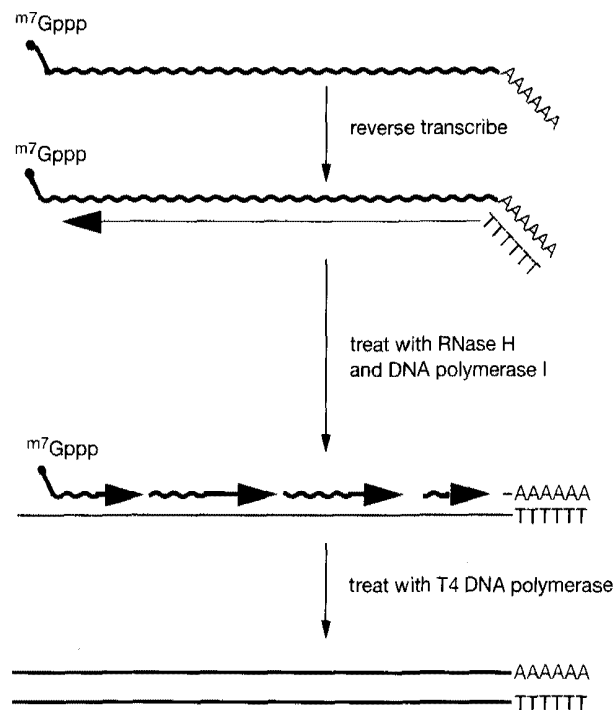
**Disadvantages:** Clones generated by standard PCR amplification are likely to contain a higher number of mutations than those produced by other means. Methods that require unique primer sequences can be used only if the partial sequence of a cDNA or its cognate protein is already available.

cloning longer cDNAs may be improved (Okayama and Berg 1982; Gubler and Hoffman 1983; D'Alessio and Gerard 1988). Frequently, T4 DNA polymerase or a thermostable polymerase such as *Pfu* is added at the end of the second-strand reaction to polish the termini of the completed double-stranded DNAs. However, generating blunt ends in this fashion sometimes results in loss of 5'-terminal sequences so that the resulting cDNA clones are 5–30 nucleotides shorter than the original mRNA (Gerard and D'Alessio 1993).

### Replacement Synthesis of the Second Strand of cDNA

In this method, which was introduced by Okayama and Berg (1982) and modified by Gubler and Hoffman (1983; Gubler 1988), the product of first-strand synthesis — a cDNA-mRNA hybrid — is used as a template for a nick-translation reaction (please see Figure 11-4). RNase H produces nicks and gaps in the mRNA strand of the hybrid, creating a series of RNA primers that are used by *E. coli* DNA polymerase I during the synthesis of the second strand of cDNA. The reaction has three main virtues:

- It is very efficient.
- It can be carried out directly using the products of the first-strand reaction, which need no further treatment or purification.
- It eliminates the need to use nuclease S1 to cleave the single-stranded hairpin loop in the double-stranded cDNA, a reaction that is difficult to control and frequently results in a great loss of cDNA.



**FIGURE 11-4 Schematic for Basic Gubler-Hoffman Strategy**

A series of three enzymatic reactions is used to generate double-stranded cDNA. First-strand synthesis is initiated using poly(dT), the mRNA template is removed by treatment with RNase H, and second-strand synthesis is carried out using DNA polymerase I and T4 DNA polymerase. The resulting double-stranded cDNA product is left in a blunt-ended state, convenient for subsequent attachment of linkers or adaptors to facilitate cloning.

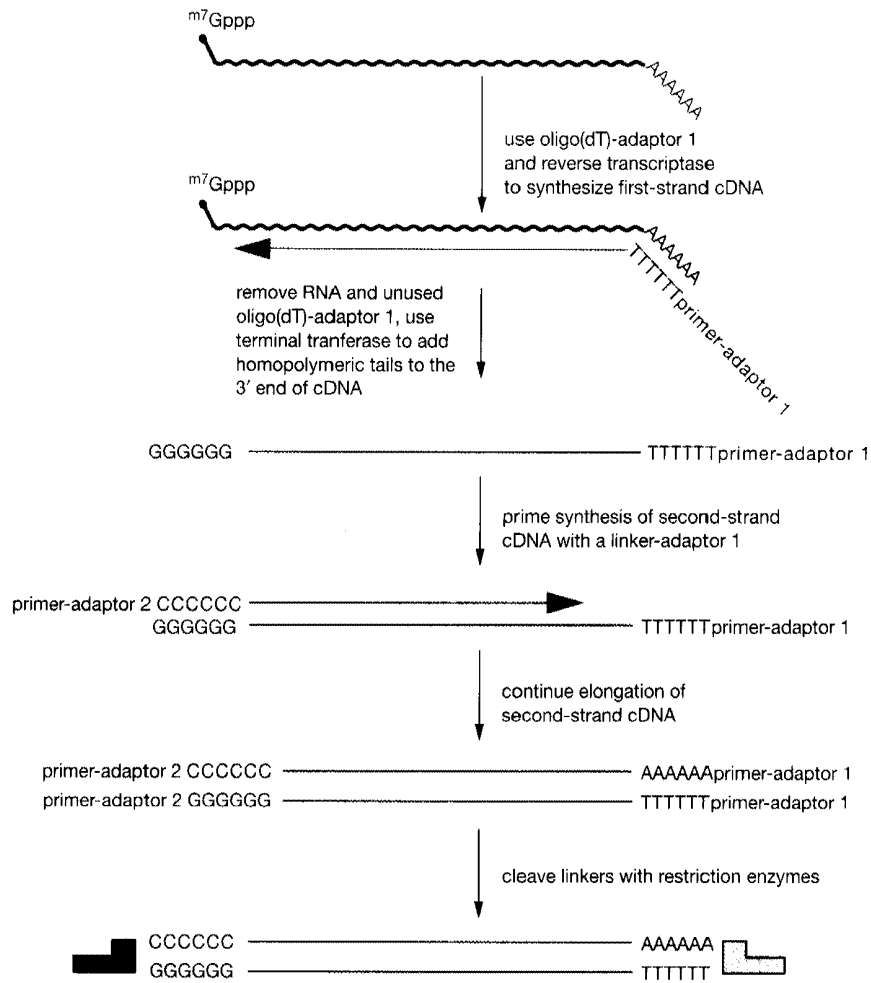
Although most cDNA libraries are now constructed using a replacement reaction to synthesize the second strand of cDNA, the reaction described by Gubler and Hoffman (1983) presents three potential problems: (1) Eukaryotic mRNAs carry "cap" structures at their 5' termini, and it is not clear how these caps are removed so that the double-stranded cDNA can be inserted into a prokaryotic vector; (2) the replacement reaction is incapable of synthesizing the second strand of cDNA corresponding to the 5'-terminal region of the mRNA; and (3) hairpin priming of second-strand synthesis may still occur during the replacement reaction if RNase H efficiently removes the mRNA sequences immediately adjacent to the cap structure. In practice, however, these disadvantages turn out not to be serious: The products of the replacement reaction can be efficiently inserted into prokaryotic vectors without taking any special steps to remove the cap structure; the resulting cDNAs are often very nearly full-length, lacking only a few nucleotides corresponding to the 5' terminus of the mRNA; and self-priming usually accounts for <10% of the second-strand synthesis.

### ***Oligonucleotide-primed Synthesis of the Second Strand of cDNA***

For routine construction of cDNA libraries, the simple replacement reaction described by Gubler and Hoffman (1983) is perfectly adequate. However, if the goal is to establish expression libraries (which require full-length cDNAs) or to clone the 5'-terminal sequences of eukaryotic mRNA with high efficiency, the methods outlined below offer some advantages.

- After completion of first-strand synthesis, terminal transferase can be used to add homopolymeric tails of dC residues to free 3'-hydroxyl groups (Rougeon et al. 1975; Land et al. 1981). This tail is then hybridized to oligo(dG), which serves as a primer for synthesis of the second strand of cDNA (please see Figure 11-5). The efficiency of this method seems to depend on the particular mRNA under study. In the best cases (e.g., chicken lysozyme mRNA [Land et al. 1981]), full-length clones of cDNA can be obtained with high efficiency; other mRNAs, however, have provided more variable results (Rougeon et al. 1975; Cooke et al. 1980), perhaps reflecting the relative efficiencies with which terminal transferase uses the 3' termini of different first-strand cDNAs as substrates for homopolymeric tailing. The presence of oligomeric tails at each end of the first-strand cDNA provides an opportunity to amplify the cDNA *in vitro* by PCR (Belyavsky et al. 1989; Tam et al. 1989; Welsh et al. 1990). This is useful when the amount of available mRNA is too small for producing cDNA by standard procedures. However, because PCR amplification of long cDNAs is inefficient, there is a strong selection against large cDNAs.
- Okayama and Berg (1982) used a fragment of plasmid DNA carrying a short tail of dG residues as a primer for second-strand synthesis (Figure 11-6). The dG residues are annealed to a homopolymeric tract of dC residues that has been added to the 3' terminus of the first strand of cDNA by terminal transferase. Although the protocol generally works well, it is laborious, requiring restriction endonuclease digestion of the mRNA:cDNA duplex, followed by the addition of a fragment tailed with dG to prime the second-strand repair reaction. Several modifications have been described that simplify the cloning procedure by omitting the need for the separate upstream linker that is used to prime second-strand synthesis and to join the double-stranded cDNA to the plasmid. These modifications include:

***The use of synthetic primer-adaptors that carry both homopolymeric tails*** for priming the synthesis of the first and second strands of cDNA and restriction sites for cloning into plasmids (Coleclough and Erlitz 1985) and bacteriophage  $\lambda$  vectors (Krawinkel and Zobelein 1986; Han et al. 1987). The use of primer-adaptors has three advantages. First,

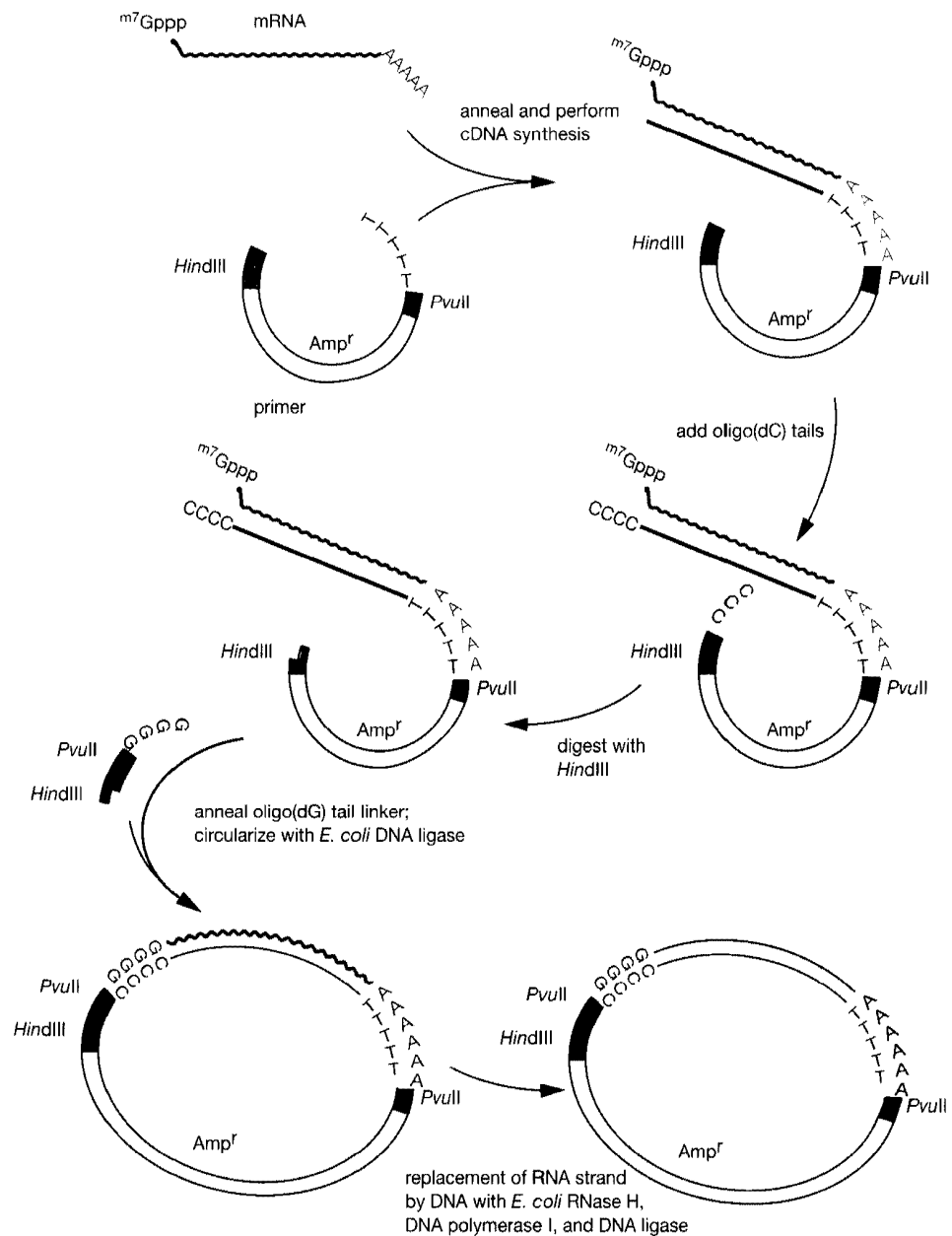


**FIGURE 11-5 Homopolymeric Priming of Second-strand cDNA**

First-strand synthesis is initiated with an oligo(dT) primer-linker (represented in black). After removal of the mRNA template, a homopolymeric tail is added to the single-stranded cDNA product. Second-strand synthesis is primed using an oligomeric sequence complementary to the the homopolymeric tail, and the resulting product is cleaved with restriction endonucleases whose recognition sites have been incorporated at the ends of the double-stranded cDNA molecules.

the number of steps involved in the synthesis and cloning of cDNA is reduced. For example, in the protocol described by Han et al. (1987), the cDNA-mRNA hybrid is attached to a bacteriophage  $\lambda$  vector by synthetic adaptors before synthesis of the second strand of cDNA. This eliminates several steps that are required when double-stranded cDNA is cloned by addition of synthetic linkers. Second, the increased efficiency of priming of second-strand synthesis yields libraries that contain a comparatively high proportion of full-length cDNA molecules. Third, the method can be adapted to allow the amplification of first-strand cDNA by PCR. However, there are also some disadvantages: All of the clones generated by homopolymeric priming of second-strand synthesis carry a tract of dG:dC residues immediately upstream of the sequences corresponding to the mRNA template. The presence of these additional sequences may inhibit transcription of DNA both in vivo and in vitro. Furthermore, they may form a barrier to the Klenow fragment of *E. coli* DNA polymerase I during DNA sequencing by the dideoxy-mediated chain-termination





**FIGURE 11-6 Schematic of the Okayama and Berg Strategy**

Preparation of plasmid primer and linker DNA. The unshaded portion of each vector circle is pBR322 DNA, and the shaded segments represent the restriction endonuclease sites. Please see text for details. (Adapted, with permission, from Okayama and Berg 1982 [©American Society for Microbiology].)

method, requiring that another DNA polymerase (e.g., reverse transcriptase) be used instead and the conditions adjusted accordingly.

**The use of a linearized plasmid that carries a synthetic (dT) tail at one 3' end and a synthetic (dC) tail at the other** (Spickofsky and Margolskee 1991). This construct is made by ligating adaptors bearing the appropriate homopolymeric tails to a plasmid that has been cleaved by two different restriction enzymes (e.g., *Kpn*I and *Sac*I). The dC tail carries a 3'-phosphate group to block further addition of residues at the 3' end. After the dT tail has been used to prime synthesis of first-strand cDNA, dG residues are added to the free 3' end

of the cDNA by terminal transferase. The blocking 3'-phosphate is then removed by alkaline phosphatase, and the second DNA strand is synthesized by the combined actions of RNase H, DNA polymerase I, and DNA ligase.

Careful consideration should be given to the method used to synthesize the second strand of cDNA, because it can determine the choice of vector and dictate the means used to link the cDNA to the vector.

## MOLECULAR CLONING OF DOUBLE-STRANDED cDNA

The cloning of double-stranded cDNA into a vector is facilitated by the addition of various tails, linkers, or adaptor sequences to the ends of cDNAs.

### Synthetic DNA Linkers and Adaptors

Synthetic linkers containing one or more restriction sites provide an effective method for joining double-stranded cDNA to both plasmid and bacteriophage  $\lambda$  vectors and have supplanted other methods for cloning cDNA populations (please see the information panel on **HOMOPOLYMERIC TAILING**). Double-stranded cDNA is treated with bacteriophage T4 DNA polymerase or *E. coli* DNA polymerase I, enzymes that remove protruding single-stranded 3' termini with their 3'  $\rightarrow$  5' exonucleolytic activities and fill in recessed 3'-hydroxyl termini with their polymerizing activities. The combination of these activities generates blunt-ended cDNA molecules, which are then incubated with a very large molar excess of linker molecules in the presence of bacteriophage T4 DNA ligase, an enzyme capable of catalyzing the ligation of blunt-ended DNA molecules. The products of the reaction are cDNA molecules carrying polymeric linker sequences at their termini. These molecules are cleaved at a restriction site in the linker, purified, and ligated to a vector that has been cleaved with a restriction enzyme that generates cohesive termini compatible with those of the linker.

Double-stranded cDNA molecules containing the synthetic cohesive termini will of course ligate to each other, as well as to the vector DNA. It is therefore important to arrange the ligation conditions to minimize the formation of chimeric molecules, since it is extremely laborious subsequently to test whether cDNA clones that contain the particular restriction site at an internal location have been formed by end-to-end ligation of two unrelated cDNAs. The ligation mixture should therefore always contain a high molar excess of vector DNA to cDNA. However, these conditions strongly favor reformation of the vector by self-ligation, leading to unacceptably high backgrounds of nonrecombinant clones. This problem may be minimized by treating the cleaved vector with a phosphatase before ligation to cDNA.

If the double-stranded cDNA contains one or more recognition sites for the restriction enzyme, it will be cleaved and subsequently cloned as two or more DNA fragments, preventing the isolation and analysis of full-length cDNAs. Attempts to alleviate this problem have included the following:

- **The use of restriction enzymes that cleave mammalian DNA very rarely** (e.g., *NotI* and *SalI*). There is no guarantee that even a small cDNA does not contain a recognition site for a particular restriction enzyme. However, if the size of the cDNA clone of interest is considerably smaller than the size of the average fragment of genomic DNA obtained by digestion with the chosen enzyme, there is a good chance that it will not contain a recognition sequence for that enzyme. For example, the odds of finding the G/C-rich octanucleotide sequence recognized by *NotI* in a 5-kb clone of cDNA are less than 1 in 200. For *SalI*, whose sites occur, on average, once every 100 kb in mammalian DNA, the odds rise to 1 in 20, still perhaps an acceptable risk.

By contrast, the average distance between *EcoRI* sites is ~4 kb, and so there is a reasonably good probability that a cDNA of average size will be cleaved into two or more pieces. If it is essential to clone into a restriction site that occurs as frequently as *EcoRI*, it is advisable to take one of the additional precautions outlined below to avoid potential problems.

- **The introduction of methyl groups that will modify and protect naturally occurring restriction sites in cDNAs.** This modification can be done either by methylation of double-stranded cDNA with a methylase (e.g., *M-EcoRI* methylase) before addition of synthetic linkers, or by incorporating 5-methyl dCTP during synthesis of the first cDNA strand (Han and Rutter 1988; Huse and Hansen 1988). If the cDNA is methylated, then a strain of *E. coli* must be used that is deficient in the *mcr* restriction system, which cleaves DNA at methylcytosine residues (Raleigh et al. 1988; Woodcock et al. 1989). When constructing cDNA libraries from small amounts of RNA, many investigators simply omit the methylation step in an effort to streamline the procedure and to generate the maximum number of cDNA clones (e.g., please see McDonnell et al. 1987; Don et al. 1993).
- **The use of synthetic adaptors rather than linkers.** Adaptors are short, double-stranded oligonucleotides that carry one blunt end (which can be ligated to the double-stranded cDNA) and one cohesive terminus (which can be ligated to a compatible terminus in the vector). Adaptors are essentially precut linkers that do not require digestion with restriction enzymes after they have been ligated to double-stranded cDNA. However, cDNA molecules carrying phosphorylated adaptors can form covalently closed circular molecules (which cannot be cloned) or chimeric linear molecules (which are highly undesirable) during the subsequent ligation reaction in the presence of dephosphorylated vector DNA. To avoid this problem, only the shorter strand of the adaptor is phosphorylated before ligation to cDNA. The products of the ligation (cDNA molecules carrying a single adaptor at each end and dimer adaptor molecules) are separated by column chromatography. The termini of the cDNA molecules carrying adaptors are phosphorylated with bacteriophage T4 polynucleotide kinase and then ligated to a large molar excess of the appropriate dephosphorylated vector.

In addition to equipping the termini of cDNA for cloning, linkers can also be used as binding sites for primers in PCRs. By including a PCR step, large cDNA libraries can be established from very small amounts of cDNA (for methods and reviews, please see Tam et al. 1989; Hu et al. 1992; Brady and Iscove 1993; Lambert and Williamson 1993, 1997; Rothstein et al. 1993; McCarrey and Williams 1994; Revel et al. 1995).

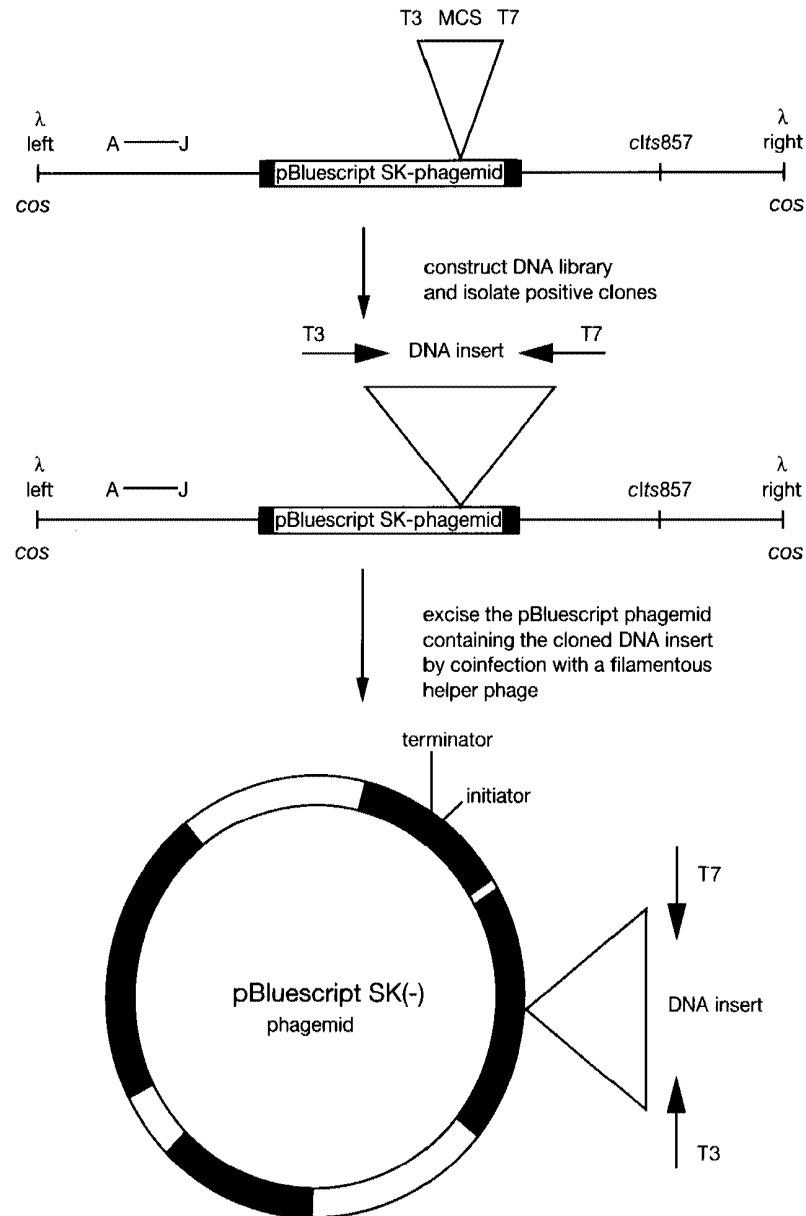
## Vectors Used for Cloning of cDNA

Until 1983, almost all cDNA cloning was carried out using plasmid vectors, and cDNA libraries were usually maintained as a collection of  $>10^5$  independently transformed bacterial colonies. These colonies were sometimes pooled, amplified in liquid culture, and stored at  $-70^\circ\text{C}$ ; more frequently, they were maintained on the surfaces of nitrocellulose filters (please see Chapter 1, Protocol 31). In either case, the results were unsatisfactory. The libraries were difficult to preserve without loss of viability, and screening by hybridization with multiple radioactive probes often required painstaking replication of colonies from one nitrocellulose filter to another. This is a laborious process that can be repeated only a few times before the colonies on the master filter become smeared beyond recognition. With the advent of more efficient ways to synthesize cDNA (Gubler and Hoffman 1983) and with the growing availability of linkers, adaptors, methylases, and packaging mixtures, it became possible to use bacteriophage  $\lambda$  as a vector and to take advantage of the high efficiency and reproducibility of in vitro packaging of bacteriophage  $\lambda$  DNA into

infectious virus particles. The resulting libraries are often large enough to be screened directly without amplification. Alternatively, they can be amplified, stored indefinitely without loss of viability, and, depending on the particular vector, screened with either nucleic acid probes, antibodies, or other ligands.

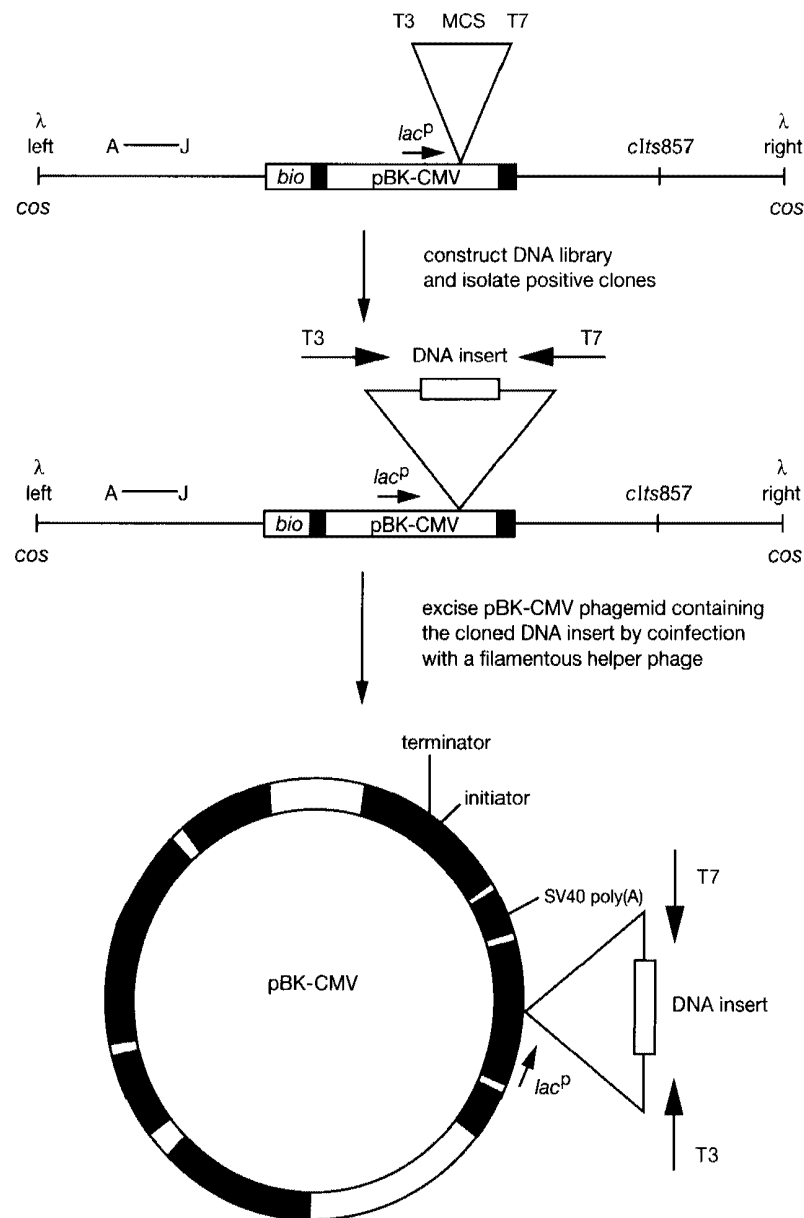
The features of the most popular bacteriophage  $\lambda$  vectors and plasmid vectors used to construct cDNA libraries are outlined below. We recommend  $\lambda$ ZAP and its derivatives (Stratagene) or  $\lambda$ ZipLox (Life Technologies) for standard cDNA library construction. These vectors have been engineered to allow recovery of cDNA inserts as plasmids, and they thus obviate the need for tedious preparation of bacteriophage  $\lambda$  DNA and conventional subcloning into plasmids.

- **$\lambda$ ZAP** (Short et al. 1988) carries a polycloning site embedded in the region of the *lacZ* gene coding for the  $\alpha$ -complementation fragment of  $\beta$ -galactosidase. cDNAs up to 10 kb in length may be inserted into the polycloning site downstream from the *lacZ* promoter and expressed either in infected bacteria or in induced lysogens, essentially as described for  $\lambda$ gt11. In addition,  $\lambda$ ZAP fusion proteins may be expressed from high-copy-number plasmids following excision of the DNA insert and flanking plasmid sequences from the bacteriophage  $\lambda$  vector. Among the advantages of  $\lambda$ ZAP are (1) the presence of six unique restriction sites within the polycloning region that may be used for directional cloning of cDNA molecules; (2) the presence of promoters from bacteriophages T3 and T7 that flank the polycloning regions; these promoters can be used to synthesize strand-specific RNA probes complementary to the cloned cDNA; and (3) the presence of bacteriophage-f1-derived sequences for *in vivo* conversion of the DNA insert from the bacteriophage  $\lambda$  vector to the Bluescript plasmid, whose sequences are contained within  $\lambda$ ZAP. Excision is facilitated by positioning bacteriophage f1 sequences that encode signals for initiation and for termination of single-stranded DNA synthesis on either side of the polycloning site (Dotto et al. 1984). When F' cells infected with  $\lambda$ ZAP are superinfected with a filamentous helper bacteriophage (e.g., f1 R408 [Russel et al. 1986]), the gene II product synthesized by the superinfecting phage nicks one of the two strands of  $\lambda$ ZAP DNA at the initiation site. Synthesis of single-stranded DNA proceeds through the polycloning site (and any cDNA sequences inserted into it) and terminates at the downstream termination site. Some of the single-stranded progeny DNA molecules circularize and become packaged into filamentous virus particles that are secreted from the cell. When F' bacteria are infected with these particles, the incoming single-stranded DNA is converted into a double-stranded molecule that carries a colicin E1 (*colE1*) origin, expresses  $\beta$ -lactamase, and replicates as a conventional plasmid, which can be amplified and purified by conventional methods (please see Chapter 1). Because the plasmid carries a functional origin of bacteriophage f1 replication, cells superinfected with a suitable helper bacteriophage yield progeny particles that carry single-stranded copies of the DNA lying between the initiation and termination sites in the bacteriophage  $\lambda$  genome.
- **$\lambda$ ZAPII** is equivalent to  $\lambda$ ZAP except that a Sam100 mutation has been removed. Removal of the Sam100 mutation allows better growth of bacteriophage  $\lambda$ , which, in turn, causes the plaques to turn blue much sooner in the presence of IPTG (isopropyl- $\beta$ -D-thiogalactopyranoside) and X-gal (5-bromo-4-chloro-3-indole- $\beta$ -D-galactoside). A map of  $\lambda$ ZAPII is presented in Figure 11-7.
- **$\lambda$ ZAP Express** is similar to other members of this series of vectors except that the excised plasmid carries control elements for expression of the cloned cDNA in eukaryotic cells (please see Figure 11-8). These elements include the powerful immediate early region promoter of the human cytomegalovirus positioned upstream of the multiple cloning site and an SV40 termination sequence located downstream from the cDNA insert. Excision of the expression plasmid from  $\lambda$ ZAP Express is mediated by superinfection with a filamentous helper bacteriophage. The excised plasmid carries sequences needed (1) for transcription of the cDNA in *E.*



**FIGURE 11-7**  $\lambda$ ZAPII

$\lambda$ ZAPII is constructed from a fragment derived from the left arm of bacteriophage  $\lambda$  carrying  $\lambda$  genes A–J; a fragment derived from the right arm of  $\lambda$  carrying *cIts857*; the gene encoding the temperature-sensitive repressor; and pBluescript SK phagemid. The multiple cloning site (MCS) carried within the phagemid sequence is flanked by transcription initiation sites for bacteriophages T3 and T7. The vector carries the origins of replication from *f1* and *colE1* and the gene conferring ampicillin resistance. Individual bacteriophage  $\lambda$  clones or an amplified library can be used to infect *E. coli* that are coinfecting with filamentous helper phages. Inside the cell, *trans*-acting proteins encoded by the helper phage recognize initiator (I) and terminator (T) domains within the  $\lambda$ ZAPII vector arms. Both signals are recognized by the helper phage gene II protein and a new DNA strand is synthesized, displacing the existing strand. The displaced strand is circularized and packaged as a filamentous phage by helper phage proteins and secreted from the cell. Circular double-stranded pBluescript phagemids are generated by infecting an  $F'$  strain of *E. coli* with the population of recovered filamentous bacteriophages and growing small-scale cultures of infected cells in media containing ampicillin. The closed circular phagemid DNA is then isolated by standard methods (please see Chapter 1). (Adapted with permission, ©1999 Stratagene.)



**FIGURE 11-8** lambdaZAP Express

lambdaZAP Express is constructed from a fragment derived from the left arm of bacteriophage lambda which carries lambda genes A-J; a fragment derived from the right arm of lambda carrying cIts857; the gene encoding the temperature-sensitive repressor; and pBK-CMV plasmid. The multiple cloning site (MCS) carried within the plasmid sequence is flanked by transcription initiation sites for bacteriophages T3 and T7. The vector carries the origins of replication from f1, colE1, and SV40; the CMV and lacP promoters; and the gene for neomycin resistance. Individual bacteriophage lambda clones or an amplified library can be used to infect *E. coli* cells that are coinfecting with filamentous helper phage. Inside the cell, *trans*-acting proteins encoded by helper phage recognize initiator (I) and terminator (T) domains within the lambdaZAP Express vector arms. Both signals are recognized by the helper phage gene II protein and a new DNA strand is synthesized, displacing the existing strand. The displaced strand is circularized and packaged as a filamentous phage by the helper phage proteins and secreted from the cell. Circular double-stranded pBK phagemids are generated by infecting an F' strain of *E. coli* with the population of recovered filamentous bacteriophages and growing small-scale cultures of the infected cells in media containing kanamycin. The circular phagemid DNA is then isolated by standard methods (please see Chapter 1). (Adapted with permission, ©1999 Stratagene.)

*coli*, (2) for in vitro transcription of RNA by bacteriophage DNA-dependent RNA polymerases, and (3) for an expression cassette containing a neomycin resistance gene.

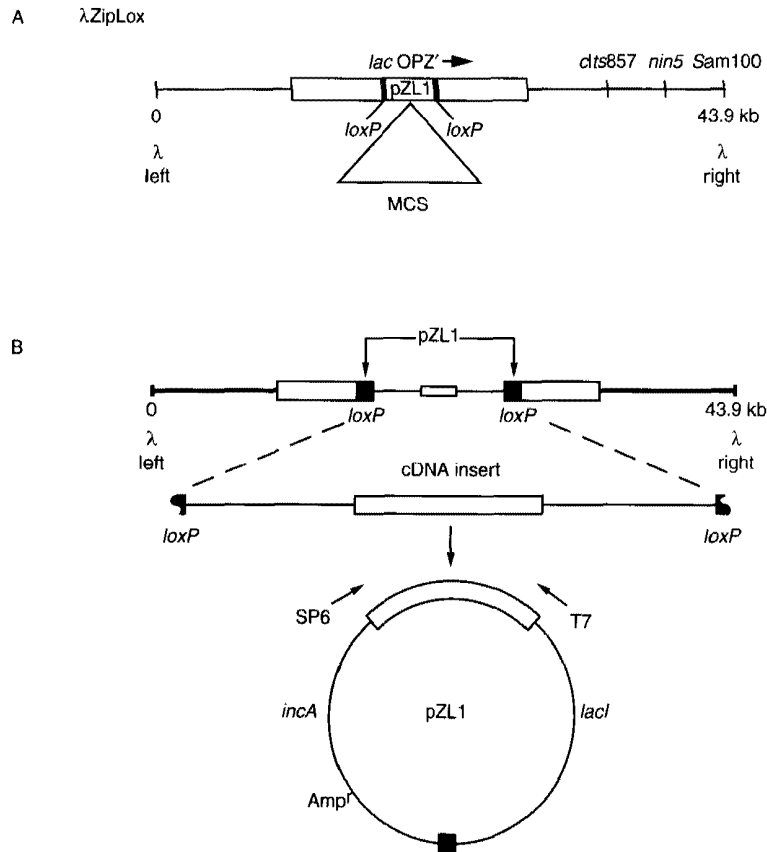
Two strains of *E. coli* are supplied by the manufacturer of  $\lambda$ ZAP (Stratagene): BB4 and XL1-Blue. The relevant genotype of *E. coli* strain BB4 is *supE supF hsdR* [*F' proAB<sup>+</sup> lacI<sup>q</sup> lacZ $\Delta$ M15*]. This strain supports growth of  $\lambda$ ZAP,  $\lambda$ ZAPII, and  $\lambda$ ZAP Express. The relevant genotype of *E. coli* strain XL1-Blue is *recA1 supE hsdR lac<sup>-</sup>* [*F' proAB<sup>+</sup> lacI<sup>q</sup> lacZ $\Delta$ M15*]. This strain supports vigorous growth of  $\lambda$ ZAPII, but not  $\lambda$ ZAP, since it does not contain the *supF* tRNA suppressor required for  $\lambda$ ZAP (Sam100) growth. The Rec<sup>-</sup> phenotype of this strain has advantages if the bacteriophage  $\lambda$  clone is carrying rare cDNAs with repetitive sequences that can be deleted or rearranged by recombination between homologous sequences. XL1-Blue also has the added benefit of allowing improved color discrimination between recombinant and nonrecombinant clones. A more recent derivative of strain XL1-Blue, XL1-Blue MRF' (available from Stratagene), carries assorted mutations that should further improve the stability of repetitive sequences and other recombination-prone DNAs (please see Chapter 2).

BB4, XL1-Blue, and XL1-Blue MRF' carry a tetracycline resistance marker on the F' episome. It is therefore a simple matter to ensure that the bacteria are expressing F pili by growing liquid cultures from colonies grown on an agar plate containing tetracycline.

- **$\lambda$ ZipLox** (D'Alessio et al. 1992) is a hybrid of  $\lambda$ gt10 and  $\lambda$ gt11 that contains unique *EcoRI*, *NotI*, and *Sall* sites in the amino-terminal coding portion of a *lacZ'* gene, encoding the  $\alpha$ -complementation fragment of  $\beta$ -galactosidase (please see Figure 11-9). cDNA inserts up to 7 kb in length can be identified by nucleic acid or immunochemical screening. Cloned cDNAs can be excised on a replication-competent plasmid that is integrated into the vector DNA. Excision is accomplished by a Cre/LoxP mechanism in *E. coli* strains DH10B(ZIP) or DH12S(ZIP), followed by plating on media containing ampicillin. The DH10B(ZIP) strain is used for the production of double-stranded plasmid DNA, whereas the DH12S(ZIP) strain is used to produce single-stranded plasmid DNA after superinfection with a filamentous helper bacteriophage such as M13K07 (please see Chapter 3). The excised plasmid, called pZL1, contains 19 different 6-base recognition sites for restriction enzymes, as well as promoters from bacteriophages T7 and SP6 that flank the polylinker sequence.

The major differences between  $\lambda$ ZipLox (available from Life Technologies) and the  $\lambda$ ZAP series of vectors (available from Stratagene) relate to cDNA insert sizes and excision mechanisms.  $\lambda$ ZAP vectors can harbor cDNA inserts up to 10–12 kb in length, whereas  $\lambda$ ZipLox can accommodate cDNAs up to 7 kb in size.  $\lambda$ ZAP relies on an excision system based on the DNA replication systems of filamentous bacteriophages (please see above), whereas  $\lambda$ ZipLox relies on the Cre/LoxP recombination system of bacteriophage P1, which, in our hands, is more reproducible.

- **$\lambda$ gt10 and  $\lambda$ gt11** (Young and Davis 1983a,b; Huynh et al. 1985). For much of the 1980s, the standard vectors for construction of cDNA libraries were  $\lambda$ gt10 and  $\lambda$ gt11 (please see Figure 11-10).  $\lambda$ gt10 was used to construct libraries that were to be screened only by nucleic acid probes; cDNA libraries constructed in  $\lambda$ gt11 could be screened with antibodies or other ligands to isolate DNA sequences encoding specific proteins. Although few investigators today would choose  $\lambda$ gt10 or  $\lambda$ gt11 to construct new libraries, libraries generated during the 1980s remain important resources that continue to yield valuable cDNA clones. For additional details on  $\lambda$ gt10 and  $\lambda$ gt11, please see the information panel on  **$\lambda$ gt10 AND  $\lambda$ gt11**.
- **Plasmid vectors.** Although the plasmids used in the 1970s to construct the first cDNA libraries are not longer in use, their derivatives are still employed to construct and propagate cDNA libraries that may be used for functional screening, expressed sequence-tagged (EST) sequencing, and the generation of subtracted libraries and probes. As the bacteriophage  $\lambda$  vectors have evolved, becoming more plasmid-like, the plasmid vectors, for example, pSPORT1 (Figure 11-



**FIGURE 11-9**  $\lambda$ ZipLox

(A)  $\lambda$ ZipLox is constructed from an *EcoRI* fragment derived from the left arm of bacteriophage  $\lambda$ , an 18.3-kb *SstI* fragment derived from the arm of a deletion mutant of  $\lambda$ gt11, and the pZL1 plasmid, flanked by *loxP* sites to facilitate Cre-mediated recombination and excision. The multiple cloning site (MCS) carried within the pZL1 sequence contains six unique restriction sites for insertion of foreign DNA and is flanked by the promoters from bacteriophages SP6 and T7. (B) cDNA sequences cloned into  $\lambda$ ZipLox can be recovered in the form of a plasmid by infecting a recombinant  $\lambda$ ZipLox into a strain of *E. coli* such as DH10B(ZIP) that is lysogenic for bacteriophage  $\lambda$  and expresses *cre* recombinase. (Adapted with permission, from Life Technologies, Inc.)

11), pCMV-Script (Figure 11-12), and pcDNA3.1 (Figure 11-13) have also extended their utility by incorporating a variety of sequence elements, including versatile multiple cloning regions, promoters for bacteriophage T3, T7, and/or SP6 polymerase, and a filamentous f1 phage intergenic region that permits DNA to be rescued in single-stranded form.

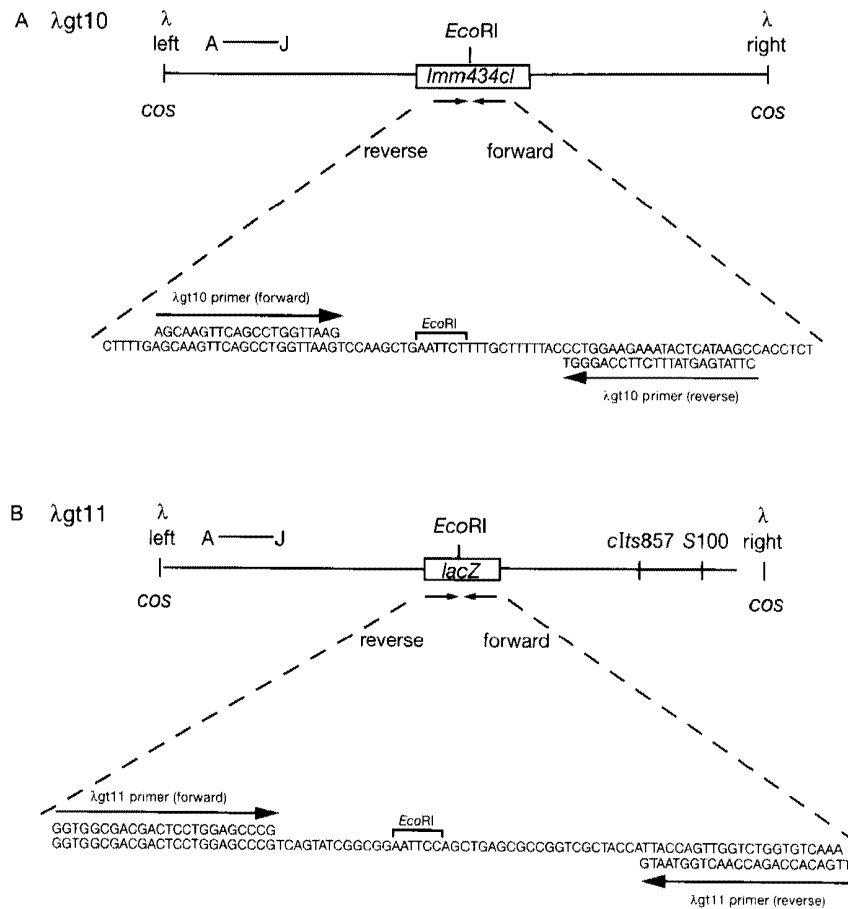
## IDENTIFICATION OF cDNA CLONES OF INTEREST

### Methods of Screening

Four methods are commonly used to screen cDNA libraries for clones of interest:

- conventional nucleic acid hybridization
- using PCR to identify pools of clones containing the desired nucleic acid sequences
- binding of specific ligands (e.g., antibodies or DNA) to proteins expressed by recombinant cDNA clones
- assaying for production of biologically active molecules



**FIGURE 11-10  $\lambda$ gt10 and  $\lambda$ gt11**

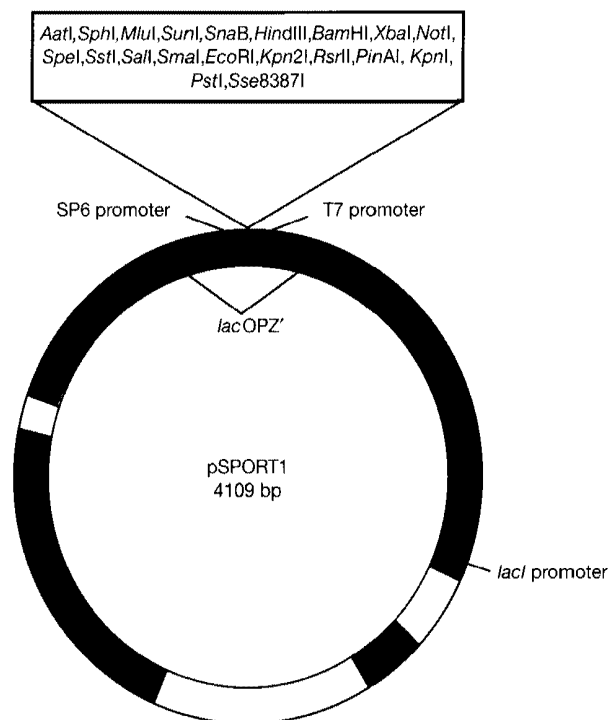
(Adapted with permission, ©1999 Stratagene.)

### Nucleic Acid Hybridization

This is the most commonly used and reliable method of screening cDNA libraries for clones of interest. None of the other methods display such an abundance of attractive features. Screening by nucleic acid hybridization allows extremely large numbers of clones to be analyzed simultaneously and rapidly, does not require that the cDNA clones be full-length (note, however, that full-length clones are required if the probe hybridizes to a region near the 5' end of the cDNA), and does not require that an antigenically or biologically active product be synthesized in the host cell. Furthermore, as a result of more than 30 years of work, the theoretical basis of nucleic acid hybridization is well understood. This has led to the development of a large number of different techniques that can accommodate nucleic acid probes of very different lengths and specificities.

### HOMOLOGOUS PROBES

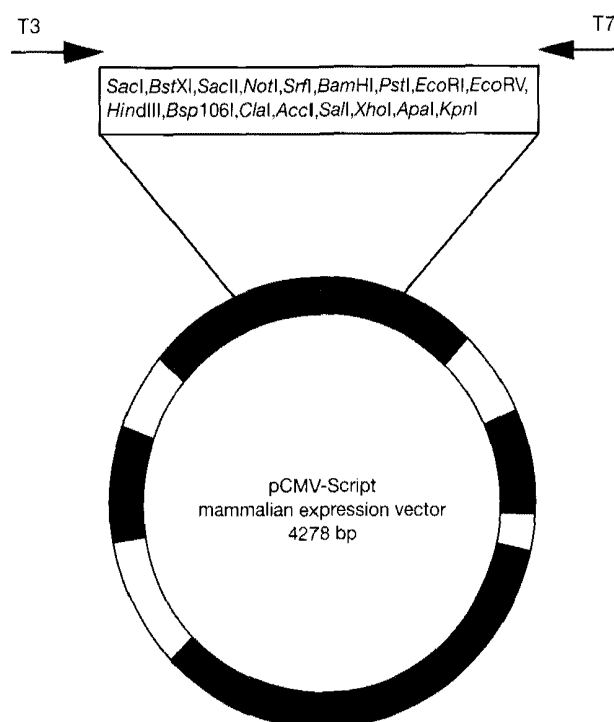
These probes contain at least part of the exact nucleic acid sequence of the desired cDNA clone. They are used in a variety of circumstances, for example, when a partial clone of an existing cDNA is used to isolate a full-length clone from a cDNA library. Usually, a fragment derived from one end or the other of the existing clone is isolated, radiolabeled *in vitro*, and used to probe a library. Hybridization with homologous probes is always carried out under stringent conditions.

**FIGURE 11-11 pSPORT1**

The plasmid pSPORT1 is a multifunctional expression vector that is used for cDNA cloning, in vitro transcription, and construction of subtractive library procedures. It contains the origin of replication from the pUC series of vectors (ori), the  $\beta$ -lactamase gene conferring ampicillin resistance ( $Amp^r$ ), and the bacteriophage f1 intergenic region for synthesis of single-stranded DNA in *E. coli*. The multiple cloning site (MCS) within the the  $\alpha$ -peptide region of the *lacZ* gene is flanked by bacteriophage SP6 and T7 promoters to allow in vitro transcription of either strand of the inserted foreign DNA. (Adapted with permission, from Life Technologies, Inc.)

### PROBES FOR SIMILAR BUT NOT IDENTICAL SEQUENCES

Probes of this type are used to detect cDNA clones that are related, but not identical, to the probe sequences, for example, the same gene cloned from another species or a related gene cloned from the same species. In such cases, it is worthwhile to carry out a series of trial experiments to determine whether there is sufficient conservation of nucleic acid sequence to allow the screening of an appropriate cDNA library by hybridization. This task is most easily accomplished by performing a series of Southern and northern hybridizations at different stringencies. The aim is to establish conditions that will allow the previously cloned gene to be used as a probe for the cDNA of interest, without undue interference from background hybridization. If the nucleic acid in hand is not sufficiently conserved to produce reliable signals on Southern and northern blots of DNAs and RNAs from the target species, two alternative strategies can be explored. First, the nucleic acid can be used to probe “zoo” blots, which contain genomic DNAs from a wide variety of species. It is often the case that a gene isolated from yeast, for example, will not cross-hybridize with the homologous gene from, say, humans. However, the yeast gene may well cross-hybridize with the homologous gene from *Drosophila* or *Xenopus*. In turn, the gene from these “intermediate” species may be close enough in sequence to the mammalian gene to be used as a probe in screens of genomic or cDNA libraries. Second, probes can sometimes be generated in PCRs primed by sets of degenerate oligonucleotides (please see Chapter 8, Protocol 11). In this case, the template for the PCR is



**FIGURE 11-12 pCMV-Script**

pCMV-Script is a vector designed to facilitate high-level expression of cloned cDNAs in mammalian cells. It contains the origin of replication of bacteriophage f1 for synthesis of single-stranded DNA in *E. coli*, the colE1 origin for replication in *E. coli*, and the SV40 origin for replication in mammalian cells and the promoters from CMV and SV40. The multiple cloning site (MCS) is flanked by bacteriophage SP6 and T7 promoters to allow in vitro transcription of either strand of the inserted foreign DNA. Expression is driven by the CMV immediate early promoter. The presence of G418, the gene conferring resistance to neomycin and kanamycin, provides for selection of stable clones in mammalian cells with expression driven by the SV40 promoter ( $P_{SV40}$ ), and selection of clones in *E. coli* with expression driven by the  $\beta$ -lactamase promoter ( $P_{bla}$ ). (Adapted with permission, ©1999 Stratagene.)

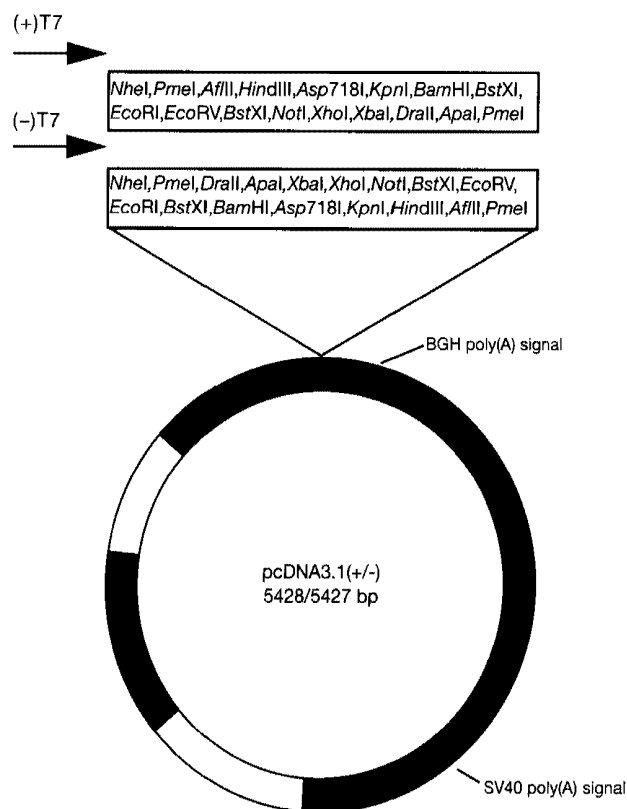
the DNA or RNA of the target or an intermediate species, and the primers are derived from regions of the amino acid sequence whose codons are nondegenerate. Wherever possible, the oligonucleotide primers should correspond to regions of the gene that are likely to be conserved between species (e.g., active sites of enzymes and highly conserved structural motifs).

#### TOTAL cDNA PROBES

Total cDNA probes are prepared by uniform incorporation of radiolabeled nucleotides in in vitro reactions catalyzed by reverse transcriptase and containing mRNA as templates; or by end-labeling of total or fractionated poly(A)<sup>+</sup> mRNA. The resulting probes can be used to screen cDNA libraries if the cDNA clones of interest correspond to mRNA species present in the initial population at a frequency of at least 1 in 200 (please see Gergen et al. 1979; Dworkin and Dawid 1980; Travis et al. 1987). Using total cDNA probes, it is not possible to detect cDNA clones homologous to species that are represented rarely in the mRNA preparation.

#### SUBTRACTED cDNA PROBES

Subtracted cDNA probes are often used to screen cDNA libraries for clones corresponding to mRNAs that are differentially regulated (please see both the information panel on **ISOLATING**



**FIGURE 11-13 pcDNA3.1**

pcDNA3.1 is a vector designed to facilitate high-level expression of cloned cDNAs in mammalian cells. It contains the origin of replication of bacteriophage f1 for synthesis of single-stranded DNA in *E. coli*, the pMB1 (pUC) origin for replication in *E. coli*, the SV40 origin for replication in mammalian cells, and the signals for poly(A) addition from SV40 and bovine growth hormone (BGH). The multiple cloning site (MCS) is flanked by bacteriophage T7 promoters to allow in vitro transcription of either strand of the inserted foreign DNA. Expression is driven by the CMV promoter. The G418 resistance gene is used to select clones of mammalian cells that have been stably transformed by pcDNA3.1. (Adapted with permission, ©1996–1998 Invitrogen.)

**DIFFERENTIALLY EXPRESSED cDNAs BY DIFFERENTIAL SCREENING AND CLONING** and Protocol 9 in Chapter 9). A labeled cDNA probe prepared from one type of mRNA is depleted of sequences that are present in a second type of mRNA (Timberlake 1980; Zimmermann et al. 1980; Wang and Brown 1991). Removal of unwanted sequences is achieved by hybridizing single-stranded cDNA prepared from mRNA extracted from the tissue of interest to a 10–20-fold excess of DNA or RNA (driver) prepared from another source that does not express the genes of interest. After hybrids containing the cDNA have been removed, the residual cDNA molecules are used to probe a cDNA library for clones containing homologous sequences. Using subtracted cDNA probes, it is possible to detect rare mRNAs that constitute as little as 0.01% of the total population of mRNAs as long as the subtraction step removes at least 95% of the original labeled cDNA (Sargent 1987).

Subtracted cDNA probes are particularly valuable when very few differences exist between the two starting mRNA preparations, i.e., when most species of mRNA are represented equally in the two preparations and a small proportion (<2%) of the mRNAs are not present at all in one preparation. cDNAs that have been cloned using subtracted cDNA probes include the murine J

immunoglobulin chain (Mather et al. 1981), the murine T-cell receptor (Hedrick et al. 1984), MyoD (Davis et al. 1987), and a porcine glucose transporter (Weiler-Guttler et al. 1989).

A slightly different approach is used when two preparations of mRNA contain different concentrations of certain sequences. Examples of such sib pairs might be mRNAs extracted from control cells and cells that have been exposed to heat shock, drugs, or hormones. cDNAs corresponding to mRNAs whose expression is altered by such treatments can sometimes be detected by differential hybridization. Labeled first-strand cDNAs are synthesized in vitro using both mRNAs as templates. Most of the cDNA sequences correspond to mRNAs whose concentrations are not appreciably changed by the treatment to which the cells were exposed. However, a minority of the cDNAs will be copied from mRNAs whose concentrations are significantly increased or decreased. The two cDNA probes are then used to screen replicas of a cDNA library constructed from mRNA extracted from control cells (when searching for mRNAs that are repressed) or treated cells (when searching for mRNAs that are induced). The clones that hybridize preferentially to one of the cDNA probes are chosen for further analysis. Among the many examples of genes cloned in this way are the galactose-inducible genes of yeast (St. John and Davis 1979), human fibroblast interferon (Taniguchi et al. 1980), the glucose-regulated proteins of mammalian cells (Lee et al. 1981), hormonally induced proteins (Buckbinder and Brown 1992; Kolm and Sive 1995), growth-related proteins (Foster et al. 1982; Cochran et al. 1983; Linzer and Nathans 1983), differentiation-specific proteins (Spiegelman et al. 1983), and a variety of heat shock proteins and stress proteins (e.g., please see Mason et al. 1986). The procedure has also been used to identify cDNA clones of developmentally regulated mRNAs from organisms of many different species, including *Xenopus* (Williams and Lloyd 1979; Weeks et al. 1985; Sive et al. 1989; Le Guellec et al. 1991; Kolm et al. 1997), *Dictyostelium* (Rowekamp and Firtel 1980; Mehdy et al. 1983), sea urchins (Lasky et al. 1980), mice (Gorman et al. 1985), and zebrafish (Sagerstrom et al. 1996; Grinblat et al. 1998).

### SYNTHETIC OLIGONUCLEOTIDE PROBES

Synthetic deoxyoligonucleotide probes are tracts of defined sequence that have been synthesized in vitro. The sequences of these probes are deduced, using the genetic code, from short regions of the known amino acid sequence of the protein of interest. In the vast majority of cases, because of the degeneracy of the genetic code, the same sequence of amino acids can be specified by many different oligonucleotides. There is no way to know with certainty which of these oligonucleotides is actually used in the gene of interest. Three solutions to this problem have been found:

- A family of oligonucleotides can be synthesized which contains all possible sequences that can encode a given sequence of amino acids. The number of members in this family depends on the degree of degeneracy of the codons for the particular amino acids. However, since all possible oligonucleotide sequences are represented, at least one of the members will match perfectly with the cDNA clone of interest. To keep the size of each family within manageable proportions, short oligonucleotides (14–17 nucleotides) are generally used, the minimum size practical for hybridization. Often, more than one family of oligonucleotides is synthesized based on separate sequences of amino acids. For more details, please see the section on Degenerate Pools of Oligonucleotides in the introduction to Chapter 10.
- A longer (40–60-nucleotide) oligonucleotide of unique sequence can be synthesized using the most commonly used codon for each amino acid. Almost certainly, this oligonucleotide will not match exactly the sequence in the cDNA, but it will fit well enough to be detected by hybridization under nonstringent conditions. For more details, please see the section on Guessmers in Chapter 10.

- An oligonucleotide can be synthesized that contains a base such as inosine at positions of high potential degeneracy. Inosine can pair with all four conventional bases without seriously compromising the stability of the resulting hybrid. Families of oligonucleotides can therefore be generated that are reduced in number and yet are capable of hybridizing to virtually all cDNA clones that could encode the protein of interest. For more details, please see the section on Universal Bases in Chapter 10.

Finally, if the available protein sequence is from the amino terminus of the protein, the cDNA library that is to be screened must be of high quality to ensure that most of the 5' terminus of the mRNA is represented.

### **Screening cDNA Libraries by PCR**

PCR may be used in several ways to identify clones of interest in a cDNA library. For example, pools of phagemids or plasmids growing in the individual wells of 96-well plates can be screened by PCR using two oligonucleotide primers specific for the desired gene. Pools that generate a product of the appropriate size are then plated at lower concentration and rescreened. This process is repeated until individual clones containing the desired sequence are identified (Alfandari and Darribère 1994; Takumi and Lodish 1994).

PCR is also used to facilitate isolation of a full-length cDNA once a primary cDNA clone has been identified by, for example, screening by hybridization. The DNA of the primary clone is used to design two specific oligonucleotide primers, which are used in conjunction with vector-specific primers corresponding to sequences that flank the insertion site (Rosenberg et al. 1991). The products of the PCR can be cloned and used to reconstruct a full-length copy of the cDNA or they can be radiolabeled and used as probes to rescreen the library (Hamilton et al. 1991; Sang and Thompson 1994). An alternative method may be used to amplify a sequence extending from a pool if the library was not constructed by using directional cloning. In this approach, pairs of oligonucleotide primers corresponding to the flanking vector sequences or the linker-adaptors used to establish the cDNA library can be used in combination with pools of degenerate oligonucleotides to amplify and recover cDNA clones containing sequences that potentially code for the desired protein (e.g., please see Libert et al. 1989; Rasmussen et al. 1989; Cooper and Isola 1990).

### **Screening by Binding to Specific Ligands**

#### **DETECTION OF SPECIFIC ANTIGENS WITH IMMUNOGLOBULIN PROBES**

cDNA libraries constructed in expression vectors such as  $\lambda$ gt11,  $\lambda$ gt18-23,  $\lambda$ ZAP, and  $\lambda$ ORF8 can be screened with antibody directed against the protein of interest. Usually, nitrocellulose filters imprinted with the detritus of bacterial lysis are soaked in a solution containing the antibody. The filter is washed and then incubated with *Staphylococcus aureus* protein A or with a second antibody directed against the species-specific epitopes of the first antibody. In the original descriptions of the method, the secondary ligand was radiolabeled with  $^{125}\text{I}$  (Young and Davis 1983b; Huynh et al. 1985; Snyder et al. 1987). Today, the secondary ligand is covalently linked to an enzyme whose activity can be detected (e.g., alkaline phosphatase).

The key to success with this method lies in the quality of the antibody. It is essential that the antibody efficiently recognize the denatured protein (i.e., it should produce strong signals on western blots). Screening is made easier and more sensitive if, in addition, the antibody is derived from a polyclonal antiserum of high titer. Because such antisera normally react with many differ-

ent epitopes, the chance of detecting a cDNA clone that expresses a fragment of the protein of interest is increased. Polyclonal antisera often contain cross-reacting antibodies that recognize nonrecombinant components of the bacterial lysate; these must be removed before screening is undertaken.

The background of nonspecific binding is much lower when a monoclonal antibody is used as a probe. However, the number of recombinants that can be detected is also reduced, because each individual monoclonal antibody can react with only a single epitope. The ideal immunological probe might therefore consist of a cocktail of several different monoclonal antibodies, each of which reacts strongly with the denatured target protein.

### DOUBLE-STRANDED DNAs AS PROBES

cDNA clones encoding proteins that bind to specific sequences of DNA (e.g., transcription factors) can be identified by screening expression libraries with double-stranded DNA probes comprising the binding site for the factor. This technique is similar in principle to screening expression libraries with immunoglobulins: cDNA libraries are constructed in expression vectors such as  $\lambda$ gt11 and  $\lambda$ ZAP that express cloned cDNA sequences as fusion proteins with  $\beta$ -galactosidase after induction with IPTG. The proteins are then transferred in situ to nitrocellulose and probed with synthetic radiolabeled double-stranded oligonucleotides containing the binding site of interest. Plaques expressing protein that reacts well with the oligonucleotide probe are picked, replated, and tested again for the ability to bind to both specific and nonspecific oligonucleotide probes. The functional characteristics of a putative transcription factor expressed in a positive plaque must eventually be confirmed in biochemical assays that detect protein binding to DNA regulatory sequences and, ultimately, in a transcription assay. This approach has been used successfully to clone cDNAs encoding different transcription factors of various types (for review, please see Singh 1993). Curiously, it seems to be particularly powerful in the cloning of factors belonging to the leucine zipper family. For detailed descriptions of the technique, please see Harline et al. (1992), Cowell and Hurst (1993), and Singh (1993). For further details on screening by binding to ligands, please see the introduction to Chapter 14.

### *Cloning cDNAs by Expression*

Several methods of screening are based on detection of the biological activity of the protein encoded by the target cDNA. In some cases, transfection with cDNA expression libraries can be used to screen for clones that express proteins capable of complementing a particular genetic defect in yeast, mammalian cells, or *E. coli* (for more information, please see Protocol 2). A very large suite of housekeeping and regulatory genes is potentially accessible by this method. However, in cases where target protein is so specialized that no genetic screen is available, it may nevertheless be possible to isolate the target cDNA by screening libraries for the production of protein molecules that display biological activity. For example, in vitro assays have been used to identify cDNA clones that express the human lymphokine colony-stimulating factor and interleukin-3 in cultures of mammalian cells (Wong et al. 1985; Yang et al. 1986); transfection of cDNAs has been used to isolate cDNA encoding cell-surface receptors (Munro and Maniatis 1989; Kluxen et al. 1992); and microinjection of synthetic RNAs transcribed from cDNA clones has been used to isolate cDNAs encoding *Xenopus* noggin (Smith and Harland 1992). This approach is usually undertaken when no other methods of screening are available and when the protein product is small enough to give reasonable assurance that the cDNA library will contain full-length clones. To increase the sensitivity of the assay, the cDNA is usually divided into a number

of pools, each consisting of between 10 and 100,000 clones. These pools are then tested for expression of the sequence of interest. The lower complexity of each pool allows methods that are relatively insensitive to be applied to a complete cDNA library. After a pool is identified that scores positively, it is subdivided into successively smaller and smaller pools, each of which is retested until the cDNA clone of interest is isolated. The process of sib selection and analysis can sometimes be performed more rapidly if during subdivision of the initial pool, the individual clones are assigned to their subpools in a matrix format (Wong et al. 1985). This expands the number of subpools by a factor of 2 or 3, but it often leads directly to the identification of the clone of interest.

## Methods to Validate Clones of cDNA

cDNA libraries are usually plated at high density for screening with antibody or nucleic acid probes, and any clones that react positively in the first round require several additional cycles of plating and screening before they can be considered pure. However, the ability to react consistently with a particular probe, although an encouraging and necessary property, is not sufficient to prove that a given cDNA clone is derived from the mRNA of interest. The only absolute proof of identity is to show that the cDNA clone contains an open reading frame that encodes the entire amino acid sequence of the protein. Since this is clearly impractical for most proteins of current interest, other, less elemental, tests must be used. These include in decreasing order of rigor:

- **Expression from the full-length cDNA in prokaryotic or eukaryotic cells** of a protein that displays the correct biological or enzymatic activity.
- **Correspondence between portions of the nucleotide sequence of the cDNA** and the amino acid sequences of peptides derived from the purified protein.
- **Correspondence between the peptide maps of the polypeptide** synthesized in vitro by transcripts of the cDNA clone and peptide maps of the authentic protein.
- **Immunoprecipitation of the polypeptide synthesized in vitro or in vivo** from transcripts of the cDNA clone by antibodies raised against the protein of interest. The stringency of this test increases when it is carried out with a series of monoclonal antibodies that recognize different epitopes on the protein.
- **Immunoprecipitation of the authentic protein with antibodies** raised against synthetic peptides whose sequences are determined by the nucleic acid sequence of the cloned cDNA.

It is essential that the tests used to validate a cDNA clone do not use the same reagents that were used to identify the clone in the first place. If, for example, a clone is selected by screening a library with antibody, it cannot be validated in tests that rely on the same antibody (such as immunoprecipitation of polypeptides synthesized in vitro from transcripts of the clone). In addition, the cloned cDNA should hybridize to mRNA whose size, tissue, and species distribution are consistent with the structure and function of the protein. Finally, the properties of the polypeptide predicted by the nucleotide sequence of the cDNA should be in accord with those of the authentic protein. For example, the vast majority of secreted or plasma membrane proteins are derived from polypeptide precursors that carry a hydrophobic signal sequence at their amino termini. The absence of such a signal from the predicted polypeptide would therefore be cause for concern. Similarly, the predicted size of the polypeptide, its overall charge and amino acid composition, the number of potential glycosylation sites, and the presence of hydrophobic regions that could serve as transmembrane anchors should be consistent with the known properties of the authentic protein.



## GENE IDENTIFICATION: EXON TRAPPING AND cDNA SELECTION

---

The construction of a comprehensive gene map is a key component in building the biological map of an organism and is the primary goal of most genome projects. The identification of biologically significant coding sequences is a complex task in many organisms. The identification of coding sequences is particularly difficult in mammalian genomes for two reasons: (1) It is likely that only 5% of the genome encodes genes, whereas the rest of the genome harbors structural sequences, regulatory sequences, and junk, and (2) the majority of mammalian genes are not contiguous within the genome but are interrupted by noncoding regions termed introns (Watson et al. 1987). Exon amplification exploits this latter characteristic by selecting for the ability of a piece of genomic DNA cloned into a reporter construct to splice within a heterologous system (Buckler et al. 1991) (please see Protocol 3). In addition to exon amplification, a variety of other strategies have been developed to facilitate gene identification in complex mammalian genomes. Some of the more commonly utilized methods are cDNA selection (Lovett et al. 1991; Parimoo et al. 1991; Simmons and Lovett 1999), large-scale sequence analysis of cDNA libraries (Adams et al. 1992; Deloukas et al. 1998), and computational analysis of finished genomic sequences (Uberbacher et al. 1996; Burge and Karlin 1997, 1998). Experimental evidence suggests that the most effective means for identifying all of the potential transcription units within a given region involves utilizing a combination of these methods (Yaspo et al. 1995; Pribill et al. 1997; Ruddy et al. 1997).

Direct cDNA selection can be used for targeted gene(s) identification within a large genomic interval. The technique is based on the hybridization "capture" of cDNAs using biotinylated genomic templates (Morgan et al. 1992; Simmons and Lovett 1999). The specifically selected cDNA species are subsequently enriched by amplification with PCR.

Completing a collection of expressed sequences (ESTs) over a broad genomic region is technically difficult for two reasons. First, current methods for isolating cDNAs typically favor representation of more abundant transcripts, and second, conventionally constructed cDNA libraries do not adequately represent mRNA populations present in complex tissues or organs. These difficulties can be circumvented by using direct cDNA selection which relies upon the use of high-complexity cDNA pools rather than libraries as the starting source and can be designed to yield "quasi-normalized" cDNA populations.

Protocol 4 presents a method for direct selection of cDNAs using as an example a bacterial artificial chromosome contig of 500 kb as the genomic target. The cDNA source for the example is randomly primed first-strand cDNA, ligated to an amplification cassette.

## PROTOCOLS FOR THE PREPARATION AND ANALYSIS OF cDNA

---

The collection of protocols in this chapter is presented in four parts:

- Protocol 1 is a traditional protocol for the construction of cDNA libraries in bacteriophage  $\lambda$  vectors (for the investigator who does not have access to kits). This protocol, which is based on the Gubler-Hoffman method (Gubler and Hoffman 1983), is divided into six stages:

Stage 1: Synthesis of First-strand cDNA Catalyzed by Reverse Transcriptase

Stage 2: Second-strand cDNA Synthesis

Stage 3: Methylation of cDNA

Stage 4: Attachment of Linkers or Adaptors

Stage 5: Fractionation of cDNA by Gel Filtration through Sepharose CL-4B

Stage 6: Ligation of cDNA to Bacteriophage  $\lambda$  Arms

- Protocol 2 (similar to Protocol 1) is for the construction and screening of a cDNA library in eukaryotic expression vectors.

Stage 1: Construction of cDNA Libraries in Eukaryotic Expression Vectors

Stage 2: Screening cDNA Libraries Constructed in Eukaryotic Expression Vectors

- Protocol 3 is a method for gene identification using exon amplification.

Stage 1: Construction of the Library

Stage 2: Electroporation of the Library into COS-7 Cells

Stage 3: Harvesting of the mRNA

Stage 4: RT-PCR Analysis

Stage 5: Clone Analysis

- Protocol 4 is used for gene identification by direct selection of cDNA.

*I cannot understand what makes scientists tick. They are always wrong and always go on.*

Sir Fred Hoyle

# Protocol 1

---

## Construction of cDNA Libraries

**T**HIS TRADITIONAL PROTOCOL IS BASED ON THE GUBLER-HOFFMAN method (Gubler and Hoffman 1983) and is divided into six stages:

- Stage 1: Synthesis of First-strand cDNA Catalyzed by Reverse Transcriptase
- Stage 2: Second-strand Synthesis
- Stage 3: Methylation of cDNA
- Stage 4: Attachment of Linkers or Adaptors
- Stage 5: Fractionation of cDNA by Gel Filtration through Sepharose CL-4B
- Stage 6: Ligation of cDNA to Bacteriophage  $\lambda$  Arms

## STAGE 1: Synthesis of First-strand cDNA Catalyzed by Reverse Transcriptase

Three different RNA-dependent DNA polymerases are currently used to catalyze synthesis of first-strand cDNA. The optimal reaction conditions for synthesis of first-strand cDNA of maximum average length differ slightly from one enzyme to the next and are summarized in Table 11-3.

For this protocol, we recommend the use of Mo-MLV reverse transcriptase (RT) that lacks RNase H activity, for example, StrataScript RT from Stratagene, SuperScript and SuperScript II from Life Technologies, and Mo-MLV RT RNase H<sup>-</sup> from Promega. Please note that many commercially marketed cDNA synthesis and cloning kits are supplied with versions of the wild-type enzyme that carry RNase H activity (please see the information panel on **COMMERCIAL KITS FOR cDNA SYNTHESIS AND LIBRARY CONSTRUCTION** and the information panel on **HOW TO WIN THE BATTLE WITH RNASE** in Chapter 7).

### MATERIALS

**CAUTION:** Please see Appendix 12 for appropriate handling of materials marked with <!>.

### Buffers and Solutions

Please see Appendix 1 for components of stock solutions, buffers, and reagents. Dilute stock solutions to the appropriate concentrations.

#### *Actinomycin D*

Actinomycin D is needed only when a wild-type version of Mo-MLV RT is used that possesses RNase H activity. Please see the information panel on **ACTINOMYCIN D** in Chapter 7.

#### *Dithiothreitol (1 M)*

#### *EDTA (0.5 M, pH 8.0)*

#### *KCl (1 M)*

**TABLE 11-3 Optimal Reaction Conditions for First-strand Synthesis**

PARAMETER	ENZYME		
	MO-MLV RT	MO-MLV H <sup>-</sup> RT	AMV RT
pH <sup>a</sup>	8.0 at 37°C	8.0 at 37°C	8.0 at 42°C
KCl	75 mM	75 mM	50–100 mM
MgCl <sub>2</sub>	3 mM	3 mM	10 mM
Temperature <sup>b</sup>	37°C	37–42°C	42°C
Dithiothreitol	10 mM	10 mM	1 mM
dNTPs	500 μM	500 μM	1 mM
Actinomycin D <sup>c</sup>	50 μg/ml	None	50 μg/ml
Other components	RNase inhibitor (optional)	RNase inhibitor (optional)	sodium pyrophosphate (4 mM) spermidine (0.5 mM) RNase inhibitor (optional)

Modified, with permission, from Gerard and D'Allesio (1993, Humana Press).

<sup>a</sup>*Buffer:* The reaction is buffered by Tris-Cl at pH 8.0 (at 37°C). Because Tris buffers have a large temperature coefficient, the pH of the buffer at room temperature should be 8.3.

<sup>b</sup>*Temperature:* cDNA of maximum average length is synthesized by both Mo-MLV and Mo-MLV H<sup>-</sup> at 37°C. Both enzymes catalyze the synthesis of larger quantities of cDNA of smaller average size at higher temperatures (Mo-MLV RT at 45°C; Mo-MLV H<sup>-</sup> RT at 50°C).

<sup>c</sup>*Actinomycin D:* This drug is often used to suppress self-primed synthesis of second-strand cDNA in reactions catalyzed by Mo-MLV RT (please see the information panel on **ACTINOMYCIN D** in Chapter 7). Actinomycin D is not required in reactions catalyzed by Mo-MLV RNase H<sup>-</sup>.

MgCl<sub>2</sub> (1 M)  
Tris-Cl (1 M, pH 8.3 at room temperature)

## Enzymes and Buffers

### Reverse transcriptase

Recombinant murine reverse transcriptase is available from several manufacturers. We strongly recommend the use of a mutated form of the enzyme that lacks RNase H activity (e.g., Superscript II reverse transcriptase from Life Technologies). As discussed in the information panel on the **Mo-MLV REVERSE TRANSCRIPTASE**, the specific activity of preparations of reverse transcriptase depends on the particular cDNA clone used to express the enzyme in *E. coli*. Follow the individual manufacturer's directions (i.e., units/μg input poly(A)<sup>+</sup> RNA and incubation temperature) for the enzyme at hand. For additional information, please see the panel on **TROUBLESHOOTING: OPTIMIZING FIRST-STRAND cDNA SYNTHESIS** at the end of this protocol.

Mo-MLV RT is temperature-sensitive and should be stored at -20°C until needed at the end of Step 1.

### RNase inhibitor (optional)

Protein inhibitors of RNase bind to and inhibit the activity of most RNases but do not affect the RNase H activity of Mo-MLV RT. These inhibitors are sold by several manufacturers under various trade names (e.g., RNasin, Promega and Prime Inhibitor, 5 Prime→3 Prime). For more details, please see the information panel on **INHIBITORS OF RNASES** in Chapter 7.

## Nucleic Acids and Oligonucleotides

dNTP solution containing all four dNTPs, each at 5 mM

Oligonucleotide primers for cDNA synthesis (1 mg/ml)

Synthesis of first-strand cDNA is generally primed by random hexamers, oligo(dT)<sub>12-18</sub>, or a mixture of the two. For directional cloning, primer-adaptors of the general structure <sup>5</sup>p(dX)-(dR)-(dT)<sub>x</sub>-OH<sup>3</sup> are used, where X = a clamp composed of four nucleotides (usually GAGA), R = a recognition site for a restriction enzyme, and (dT)<sub>x</sub> = a homopolymeric run of 15 dT residues used for directional cloning.

Oligo(dT)<sub>12-18</sub> primers are present in the first-strand reaction mixture at a 10-fold (Mo-MLV H<sup>-</sup>) to 40-fold (Mo-MLV) molar excess. Unlike random hexamers and primer-adaptors (please see below), the concentration of oligo(dT)<sub>12-18</sub> primers generally does not need to be optimized in the reaction mixture.

The concentration of random hexamers in the reaction mixture is critical. As the ratio of hexamers to mRNA increases, the average length of the cDNA decreases. It is therefore essential to optimize the ratio of random primers and mRNA template in a series of pilot reactions containing radiolabeled dCTP. The average size of the first-strand cDNA generated in each of the pilot reactions should be measured by alkaline agarose gel electrophoresis and autoradiography using DNA markers of known size. When setting up a large-scale reaction to synthesize first-strand cDNA, use the highest ratio of random primer to mRNA that generates cDNA of the maximum average length.

Primer-adaptors are generally less troublesome than random primers. However, it is nevertheless prudent to optimize the ratio of primer-adaptors and mRNA template in a series of pilot reactions containing radiolabeled dCTP. Measure the amount of cDNA synthesized in each reaction as outlined in Steps 5 and 6 of this protocol. When setting up a large-scale reaction to synthesize first-strand cDNA, use the lowest ratio of primer-adaptor to mRNA that generates the maximum yield of cDNA.

Prepare stock solutions of primers (1 mg/ml in 10 mM Tris-Cl [pH 7.4]). Store aliquots of the solutions at -70°C.

Poly(A)<sup>+</sup> RNA (1 mg/ml)

Approximately 5–10 μg of poly(A)<sup>+</sup> RNA is required to synthesize enough double-stranded cDNA to construct a large library. (One confluent 90-mm plate of cultured mammalian cells yields 1–2 μg of poly(A)<sup>+</sup> RNA.) The synthetic reactions will still work if less template is available, but the losses of cDNA at each stage in the protocol will be proportionately greater. For assistance when preparing a cDNA library from a limited number of cells, please see the information panel on **CONSTRUCTING cDNA LIBRARIES FROM SMALL NUMBERS OF CELLS** at the end of this chapter.

Before beginning construction of the cDNA library, the integrity of the poly(A)<sup>+</sup> RNA to be used should ideally be checked by (1) agarose gel electrophoresis and northern hybridization with a control probe (please see Chapter 7, Protocols 5 and 8), (2) translation in a cell-free system followed by SDS-polyacrylamide gel electrophoresis of the resulting polypeptides, and (3) analysis of the size of the first strand of cDNA synthesized in a pilot reaction (please see the panel on **TROUBLESHOOTING: OPTIMIZING FIRST-STRAND cDNA SYNTHESIS** at the end of this protocol).

## Radioactive Compounds

$[\alpha\text{-}^{32}\text{P}]\text{dCTP}$  (10 mCi/ml, 400 Ci/mmol) <!<sup>></sup>

$[\alpha\text{-}^{32}\text{P}]\text{dATP}$  and  $[\alpha\text{-}^{32}\text{P}]\text{dTTP}$  should not be used as radioactive tracers to monitor synthesis of the first and second strands of cDNA, since they may be incorporated preferentially into cDNA derived from the poly(A)<sup>+</sup> tract at the 3' terminus of the mRNA. Batches of  $[\alpha\text{-}^{32}\text{P}]\text{dCTP}$  >2 weeks old should not be used in this protocol.

Thaw the  $[\alpha\text{-}^{32}\text{P}]\text{dCTP}$  just before starting the protocol. Store the thawed radiolabeled dCTP on ice until needed in Step 2. Return the radiolabeled dCTP to the freezer immediately after use.

**▲ IMPORTANT** The Stratagene cDNA Synthesis Kit recommends the use of any label other than dCTP with its protocol. This kit includes 5-methyl dCTP in the dNTP mixes to protect the cDNA against cleavage at internal sites by *Xho*I, which is used to release *Xho*I ends for ligation. The use of radiolabeled dCTP with the Stratagene protocol could create unprotected *Xho*I sites within the cDNA sequence.

## Special Equipment

Microfuge tubes, RNase-free

Water baths preset to 16°C and 70°C

## Additional Reagents

Step 5 of this protocol requires the reagents listed in Chapter 5, Protocol 8.

## METHOD

---

- To synthesize first-strand cDNA, mix the following in a sterile microfuge tube on ice:

1 µg/µl poly(A) <sup>+</sup> RNA	10 µl
1 µg/µl oligonucleotide primer(s)	1 µl
1 M Tris-Cl (pH 8.0 at 37°C)	2.5 µl
1 M KCl	3.5 µl
250 mM MgCl <sub>2</sub>	2 µl
solution of all four dNTPs, each at 5 mM	10 µl
0.1 M dithiothreitol	2 µl
RNase inhibitor (optional)	25 units
H <sub>2</sub> O	to 48 µl

Add the manufacturer's recommended amount of Mo-MLV H<sup>-</sup> RT to the reaction. Mix the reagents well by gentle vortexing.

Try to avoid producing bubbles, although this is sometimes difficult because RT is supplied in buffers containing Triton X-100 or Nonidet P-40 and 50% glycerol. If necessary, remove bubbles by brief centrifugation in a microfuge.

Mo-MLV RT is temperature-sensitive and should be stored at -20°C until needed.

**▲ IMPORTANT** If a preparation of AMV RT is used, please see Table 11-3 for reaction conditions.

- After all of the components of the reaction have been mixed at 0°C, transfer 2.5 µl of the reaction to a fresh 0.5-ml microfuge tube. Add 0.1 µl of  $[\alpha\text{-}^{32}\text{P}]\text{dCTP}$  (400 Ci/mmol, 10 mCi/ml) to the small-scale reaction.

3. Incubate the large- and small-scale reactions for 1 hour at 37°C.  
Higher temperatures (up to 55°C) can be used with some mutant forms of Mo-MLV RT. Synthesis at higher temperatures can increase the yield of cDNA from mRNA templates that contain extensive secondary structure. However, the population of cDNAs synthesized at 55°C will be shorter on average than cDNA synthesized at 37°C.
4. At the end of the incubation period, add 1 µl of 0.25 M EDTA to the small-scale reaction containing the radioisotope. Transfer the small-scale reaction to ice. Heat the large-scale reaction to 70°C for 10 minutes and then transfer it to ice.

The cDNA synthesized in the large-scale reaction can be used directly as a template in PCRs.

If the first-strand cDNA is to be used as a template for synthesis of the second DNA strand, assemble the materials and prepare a water bath at 16°C while carrying out Steps 5 and 6.

5. Measure both the total amount of radioactivity and the amount of trichloroacetic acid (TCA)-precipitable radioactivity in 0.5 µl of the small-scale reaction, as described in Appendix 8. In addition, it is worthwhile analyzing the products of the small-scale reaction through an alkaline agarose gel using appropriate DNA markers (please see Chapter 5, Protocol 8).

The first-strand cDNA should appear as a smear with sizes ranging from ~0.7 kb to >6 kb and a modal value of ~2 kb.

The remainder of the small-scale reaction can be stored at -20°C.

6. Calculate the amount of first-strand cDNA synthesized as follows:
  - a. Since 10 µl of a solution containing all four dNTPs at a concentration of 5 mM each was used (i.e., 10 µl of 20 nmoles/liter of total dNTP), the large-scale reaction must contain
 
$$20 \text{ nmoles}/\mu\text{l dNTP} \times 10 \mu\text{l} = 200 \text{ nmoles of dNTP}$$
  - b. Because the molecular weight of each dNMP incorporated into DNA is ~330 g/mole, the reaction is capable of generating a total of
 
$$200 \text{ nmoles} \times 330 \text{ ng/nmole} = 66 \mu\text{g of DNA}$$
  - c. Therefore, from the results of the small-scale reaction,

$$\frac{\text{cpm incorporated}}{\text{total cpm}} \times 66 \mu\text{g} = \mu\text{g of first strand of cDNA synthesized}$$

If the reaction has worked well, the yield of first-strand cDNA should be 30–40% of the weight of the poly(A)<sup>+</sup> RNA in the reaction mixture.

An alternative procedure to monitor synthesis of the first strand of cDNA is to use a small amount of [ $\alpha$ -<sup>32</sup>P]dCTP (10 µCi total) in the large-scale reaction described above and a much greater amount (100 µCi total) of radiolabeled dNTP in the subsequent reaction to synthesize the second strand of cDNA. This procedure is less desirable because it is then necessary to expose the alkaline agarose gel to X-ray film for long periods of time to obtain a suitable image of the first-strand products.

7. Proceed as soon as it is feasible to the next stage in the synthesis of the cDNA.

**TROUBLESHOOTING: OPTIMIZING FIRST-STRAND cDNA SYNTHESIS**

Two problems are commonly encountered during first-strand cDNA synthesis: The cDNA is short in length and/or low in yield. These problems can result from inadequacy in any of the components used for synthesis of the first strand of cDNA. However, in most cases, the culprit is the mRNA template.

- Check the integrity of the mRNA preparation by northern blotting using an antisense probe complementary to the transcript of a common housekeeping gene. If a radiolabeled band of the correct size is detected and if the band is crisp and sharp, then degradation of the RNA preparation is not the cause of the problem. These days, most protocols for synthesis of first-strand cDNA do not use a denaturation step designed to reduce secondary structure in mRNA. Although there is little effect of denaturation on the total yield or average length of cDNA, individual mRNAs differ in their amount of secondary structure and will thus be transcribed into full-length cDNA with varying efficiencies. As a precaution, some investigators heat their preparations of mRNA in H<sub>2</sub>O or TE (pH 7.6) for 5 minutes at 68°C, followed by rapid cooling in ice water immediately before use in first-strand synthesis.
- If the yield of cDNA is low (<30% of the weight of the mRNA in the reaction), treat the mRNA preparation with proteinase K as described below. This procedure can sometimes release tightly bound proteins from RNA and remove inhibitors of first-strand cDNA synthesis. As much as 100 µg of poly(A)<sup>+</sup> RNA can be treated in a volume of 300 µl containing the following:

5 µg/ml proteinase K  
 100 mM Tris-Cl (pH 7.5)  
 50 mM NaCl  
 10 mM EDTA (pH 8.0)  
 0.1% (w/v) SDS

Incubate the reaction for 1–2 hours at 37°C. Remove the proteinase K by extraction with phenol:chloroform at 65°C (please see Chapter 7) and then recover the nucleic acid by precipitation with ethanol in the presence of 0.3 M sodium acetate.

- Increasing the temperature of the RT reaction to between 45°C and 55°C can sometimes improve yield of first-strand cDNA. However, this improvement is often coupled to a reduction in the average size of the cDNA population.
- If enough poly(A)<sup>+</sup> RNA is available, optimize the amount of each of the other major components in the reaction (primers and RT) to concentrations that result in the highest yields and longest cDNAs. Set up a series of small-scale reactions (each containing 0.5–1.0 µg of poly(A)<sup>+</sup> RNA) as described below using different amounts of reverse transcriptase (10–200 units/µg of RNA) and primers (10–100-fold molar excess over the amount of mRNA). For convenience, assume that the average size of the mRNA is 2 kb. Measure the yield of cDNA by precipitation with ice-cold trichloroacetic acid (please see Appendix 8) and determine its size by electrophoresis through alkaline agarose gels (please see Chapter 5, Protocol 8). For large-scale synthesis of cDNA, use the concentration of enzyme that gives the greatest yield of long cDNA.



## STAGE 2: Second-strand Synthesis

If the entire Stage 1 procedure has worked according to plan, the products of that stage should be a population of perfect hybrids between the original mRNAs and full-length, first-strand cDNAs. The aim of Stage 2 is to convert these hybrids into full-length double-stranded cDNAs. The primers for synthesis of second-strand cDNA are created by RNase H, which introduces nicks into the RNA moiety of the cDNA-mRNA hybrids. *E. coli* DNA polymerase I extends the 3'-hydroxyl termini of these RNA primers, using the first-strand cDNA as a template and replacing the remaining segments of mRNA in the cDNA-mRNA hybrid with the newly synthesized second strand of DNA. Residual nicks in the DNA-DNA hybrid are then repaired by *E. coli* DNA ligase, and the frayed termini of the double-stranded cDNA are polished by a DNA polymerase such as bacteriophage T4 DNA polymerase or *Pfu*. Finally, bacteriophage T4 polynucleotide kinase is used to catalyze the phosphorylation of 5'-hydroxyl groups on the ends of the cDNAs in preparation for ligation of linkers or adaptors (Stage 4 of this protocol). After completion of these enzymatic steps, the double-stranded cDNA is precipitated with ethanol to remove  $Mg^{2+}$ , which would otherwise interfere with the methylation reaction described in Stage 3 of this protocol.

### MATERIALS

**CAUTION:** Please see Appendix 12 for appropriate handling of materials marked with <!>.

#### Buffers and Solutions

Please see Appendix 1 for components of stock solutions, buffers, and reagents. Dilute stock solutions to the appropriate concentrations.

*Chloroform* <!>

*EDTA* (0.5 M, pH 8.0)

*Ethanol*

*MgCl<sub>2</sub>* (1 M)

*(NH<sub>4</sub>)<sub>2</sub>SO<sub>4</sub>* (1 M)

Dissolve 1.3 g of solid  $(NH_4)_2SO_4$  in a final volume of 10 ml of  $H_2O$ . Filter-sterilize the solution and store the solution at room temperature.

*β-Nicotinamide adenine dinucleotide* (50 mM)

Make a 50 mM stock solution by dissolving 33.2 mg of  $\beta$ -nicotinamide adenine dinucleotide ( $\beta$ -NAD) in 1 ml of  $H_2O$ . Store the solution in small aliquots at  $-70^\circ C$ .  $\beta$ -NAD is a cofactor for *E. coli* DNA ligase, as well as the electron acceptor; do not confuse it with  $\alpha$ -NAD.

*Phenol:chloroform* (1:1, v/v) <!>

*RNase H buffer* (optional)

20 mM Tris-Cl (pH 7.6)

20 mM KCl

0.1 mM EDTA (pH 8.0)

0.1 mM dithiothreitol

Use this buffer only if carrying out the alternative to Step 1.

*Sodium acetate* (3 M, pH 5.2)

*10x T4 polynucleotide kinase buffer*

*TE* (pH 7.6)

*Tris-Cl* (2 M, pH 7.4)

## Enzymes and Buffers

*Bacteriophage T4 DNA polymerase (2.5 units/μl)*  
*Bacteriophage T4 polynucleotide kinase (30 units/μl)*  
*E. coli DNA ligase*  
*E. coli DNA polymerase I*  
*RNase H*

The RNase H purified from *E. coli* is sold by several manufacturers and is required at a specific activity of ~1000 units/ml.

## Nucleic Acids and Oligonucleotides

*dNTP solution containing all four dNTPs, each at 10 mM*

*First-strand cDNA*

Use the large-scale, first-strand reaction mixture prepared in Stage 1 of this protocol.

*Markers*

Please see the panel on **TROUBLESHOOTING: OPTIMIZING SECOND-STRAND cDNA SYNTHESIS** at the end of this protocol.

## Radioactive Compounds

*[α-<sup>32</sup>P]dCTP (10 mCi/ml, 400 Ci/mmol) <!>*

Do not use [α-<sup>32</sup>P]dTTP as a radioactive tracer to monitor synthesis of the second strands of cDNA; it may be incorporated preferentially into the region of the second strand corresponding to the poly(A)<sup>+</sup> tract at the 3' terminus of the mRNA.

Thaw the [α-<sup>32</sup>P]dCTP just before starting the protocol. Store the thawed radiolabeled dCTP on ice until needed in Step 1. Return the radiolabeled dCTP to the freezer immediately after use.

## Special Equipment

*Sephadex G-50 spun column*

Add Sephadex G-50 (medium pore) to sterile H<sub>2</sub>O (10 g of dry powder yields 160 ml of slurry). Wash the swollen resin with sterile H<sub>2</sub>O several times to remove soluble dextran, which can create problems by precipitating during ethanol precipitation. Finally, equilibrate the resin in TE (pH 7.6) containing 10 mM NaCl, autoclave (10 psi [0.70 kg/cm<sup>3</sup>] for 15 minutes), and store at room temperature. Prepacked columns of Sephadex and other gel filtration resins are commercially available.

*Water bath preset to 16°C*

## METHOD

---

Second-strand synthesis catalyzed by RNase H and DNA polymerase I results in loss of sequences (~20 nucleotides) from the extreme 5' end of the mRNA template. This is because the RNase H degrades the 5' sequences of the mRNA-DNA hybrid before DNA polymerase I can initiate synthesis of the second strand (D'Alessio and Gerard 1988). Most mammalian mRNAs carry an extensive tract of 5'-untranslated sequences, and the absence from cDNA clones of sequences corresponding to the 5'-terminal 20 nucleotides is therefore of little consequence to most investigators. However, for those who place a premium on these sequences, we have included an alternative to Step 1 that reduces the risk of losing 5'-terminal regions of cDNA clones. Unfortunately, the alternative method results in a reduced yield of double-stranded cDNA, and most investigators will therefore opt for the standard Step 1 method.

1. Add the following reagents directly to the large-scale first-strand reaction mixture (Stage 1, Step 4):

10 mM MgCl <sub>2</sub>	70 µl
2 M Tris-Cl (pH 7.4)	5 µl
10 mCi/ml [ $\alpha$ - <sup>32</sup> P]dCTP (400 Ci/mmol)	10 µl
1 M (NH <sub>4</sub> ) <sub>2</sub> SO <sub>4</sub>	1.5 µl
RNase H (1000 units/ml)	1 µl
<i>E. coli</i> DNA polymerase I (10,000 units/ml)	4.5 µl

Mix the reagents by gently vortexing, and centrifuge the reaction mixture briefly in a microfuge to eliminate any bubbles. Incubate the reaction for 2–4 hours at 16°C.

**ALTERNATIVE TO STEP 1 (D'ALESSIO AND GERARD 1988)**

Incubate the second-strand synthetic reaction (above) for 2 hours at 16°C *in the absence of RNase H*. Purify the resulting double-stranded cDNA by extraction with phenol:chloroform and precipitation with ethanol in the presence of 0.3 M sodium acetate (pH 5.2). Dissolve the precipitated DNA in 20 µl of 20 mM Tris-Cl (pH 7.6), 20 mM KCl, 0.1 mM EDTA (pH 8.0), 0.1 mM dithiothreitol. Digest the DNA for 20 minutes at 37°C with RNase H (0.5 units). Proceed to Step 2.

2. At the end of the incubation, add the following reagents to the reaction mixture:

β-NAD (50 mM)	1 µl
<i>E. coli</i> DNA ligase (1000–4000 units/ml)	1 µl

Incubate the reaction for 15 minutes at room temperature.

3. At the end of the incubation, add 1 µl of a mixture containing all four dNTPs each at a concentration of 10 mM and 2 µl (5 units) of bacteriophage T4 DNA polymerase. Incubate the reaction mixture for 15 minutes at room temperature.
4. Remove a small aliquot (3 µl) of the reaction. Measure the mass of second-strand DNA in the aliquot as described in Steps 7 and 8.
5. To the remainder of the reaction, add 5 µl of 0.5 M EDTA (pH 8.0). Extract the mixture once with phenol:chloroform and once with chloroform. Recover the DNA by precipitation with ethanol in the presence of 0.3 M sodium acetate (pH 5.2). Dissolve the DNA in 90 µl of TE (pH 7.6).
6. To the DNA, add:
- |  |       |
|--|-------|
| 10x T4 polynucleotide kinase buffer      | 10 µl |
| T4 polynucleotide kinase (3000 units/ml) | 1 µl  |

Incubate the reaction at room temperature for 15 minutes.

7. Use the small aliquot from Step 4 to determine the total amount of radioactivity and the TCA-precipitable counts in 1 µl of the second-strand synthesis reaction as described in Appendix 8.
8. Use the following equation to calculate the weight of the cDNA synthesized in the second-strand reaction, taking into account the amount of dNTPs already incorporated into the first strand of cDNA:

$$\frac{\text{cpm incorporated in the second-strand reaction}}{\text{total cpm}} \times (66 \mu\text{g} - x \mu\text{g})$$

$$= \mu\text{g of second-strand cDNA synthesized}$$

where  $x$  is the weight of the first strand of cDNA (from Step 6 of Stage 1). The amount of second-strand cDNA synthesized is usually 70–80% of the weight of the first strand.

9. Extract the reaction containing phosphorylated cDNA (from Step 6) with an equal volume of phenol:chloroform.
10. Separate the unincorporated dNTPs from the cDNA by spun-column chromatography through Sephadex G-50 equilibrated in TE (pH 7.6) containing 10 mM NaCl (please see Appendix 8).
11. Precipitate the eluted cDNA by adding 0.1 volume of 3 M sodium acetate (pH 5.2) and 2 volumes of ethanol. Store the sample on ice for at least 15 minutes. Recover the precipitated DNA by centrifugation at maximum speed for 15 minutes at 4°C in a microfuge. Use a hand-held minimonitor to check that all of the radioactivity has been precipitated.
12. Wash the pellet with 70% ethanol and centrifuge again.
13. Gently aspirate all of the fluid (check to see that none of the radioactivity is in the aspirated fluid), and allow the pellet to dry in the air.
14. Dissolve the cDNA in 80 µl of TE (pH 7.6) if it is to be methylated by *EcoRI* methylase (please see Stage 3 of this protocol). Alternatively, if the cDNA is to be ligated directly to *NotI* or *Sall* linkers, or an adaptor oligonucleotide (please see Stage 4 of this protocol), resuspend the cDNA in 29 µl of TE (pH 7.6).

After the precipitated DNA has been redissolved, proceed as soon as it is feasible to the next stage in the synthesis of the cDNA.

Precipitation of cDNA with ethanol is used many times in the construction of a cDNA library. Because the amounts of cDNA are usually very small (and often very precious!), special care is required to achieve maximum recovery of cDNA. For advice, please see Appendix 8.

**TROUBLESHOOTING: OPTIMIZING SECOND-STRAND cDNA SYNTHESIS**

The sizes of the radiolabeled first- and second-strand products should be analyzed by electrophoresis through an alkaline 1% agarose gel (please see Chapter 5, Protocol 8), using as markers end-labeled fragments of a *Hind*III digest of wild-type bacteriophage  $\lambda$  DNA (please see Chapter 9, Protocol 10). If the reactions have worked well, the population of first-strand cDNA molecules should range in size from 300 bases to >5 kb, with a modal size of ~2 kb.

The size of the products of second-strand synthesis should be similar to that of the population of first-strand molecules. The presence of large amounts of small products (<500 nucleotides) is a sure sign that synthesis of the second-strand cDNA has not worked well. Truncation of second-strand cDNA molecules is the result of gaps that are not filled by DNA polymerase and nicks that are not ligated by *E. coli* DNA ligase. If the modal distribution of the products of second-strand synthesis is significantly skewed toward molecules of lower molecular weight, it is best to abandon the preparation and reoptimize the conditions of second-strand synthesis. In most cases, efficient synthesis of long molecules of second-strand cDNA can be achieved by altering the ratio of template cDNA to RNase H and DNA polymerase in the reaction.

If the size of the first-strand cDNA is smaller than that of the second-strand cDNA, then a significant proportion of the second-strand molecules may have been generated by self-priming rather than by replacement synthesis. Self-priming generates a double-stranded or "long hairpin" cDNA molecule that contains a loop of cDNA at the 5' end of the molecule. The covalently closed loop will prevent addition of linker-adaptor in subsequent steps. If the alkaline-agarose gel indicates that the second-strand cDNA is noticeably larger than the first, carry out the following troubleshooting experiment to diagnose the proportion of self-priming in the reaction:

- a. Treat two aliquots of radiolabeled first strand and two aliquots of radiolabeled second strand with 1 mM EDTA (pH 8.0), 300 mM NaOH for 30 minutes at 60°C. This treatment hydrolyzes the RNA and denatures the DNA in the samples. Each aliquot should contain at least  $10^4$  cpm of TCA-precipitable material.
- b. Add 0.1 volume of 3 N HCl, 0.1 M Tris-Cl (pH 7.4) to each aliquot.
- c. Purify the DNAs by extraction with phenol:chloroform and standard precipitation with ethanol.
- d. Dissolve the DNAs in 10  $\mu$ l of H<sub>2</sub>O. Add 1  $\mu$ l of 3 M NaCl. Incubate the DNAs for 5 minutes at 68°C to allow "hairpins" to form.
- e. Add 20  $\mu$ l of H<sub>2</sub>O and 3  $\mu$ l of 10x nuclease S1 buffer (2 M NaCl/0.5 M sodium acetate [pH 4.5]/10 mM ZnSO<sub>4</sub>/5% glycerol).
- f. Add 5 units of nuclease S1 to one of the two tubes containing the first strand of cDNA and to one containing the second strand of cDNA. Incubate all four tubes for 30 minutes at 37°C.
- g. Analyze the size of first- and second-strand products by electrophoresis through an alkaline 1% agarose gel (please see Chapter 5, Protocol 8), using end-labeled fragments of a *Hind*III digest of wild-type bacteriophage  $\lambda$  DNA as markers (please see Chapter 9, Protocol 10).

The first-strand molecules should be completely hydrolyzed by nuclease S1, and no more than 10–15% of the second-strand molecules should be resistant to digestion with the enzyme. If the proportion of self-primed molecules is unacceptably high, it is often helpful to adjust the amount of RNase H used during the synthesis of the second strand. In addition, self-priming may be suppressed by including actinomycin D (50  $\mu$ g/ml) or 4 mM sodium pyrophosphate (Rhyner et al. 1986) in first-strand reactions catalyzed by avian reverse transcriptase. Note that sodium pyrophosphate should not be used with murine reverse transcriptase because it inhibits the polymerizing activity of the enzyme (Roth et al. 1985).

## STAGE 3: Methylation of cDNA

The products of Stage 2 are phosphorylated, blunt-ended double-stranded cDNAs that are full-length, or close to it. Attaching these molecules to a vector requires the addition of adaptors or linkers to the termini of the cDNAs. If adaptors are used, omit Stage 3 and proceed directly to Stage 4. If linkers are used, Stage 3 must be carried out with great diligence.

Methylated bases protect internal restriction sites in the double-stranded cDNA against cleavage by *EcoRI*, a step required to generate cohesive termini after addition of double-stranded *EcoRI* linkers to the cDNA. There are two ways to produce methylated cDNA:

- Use 5′ methyldeoxycytosine triphosphate as a precursor in place of dCTP during first-strand cDNA synthesis (Han and Rutter 1988; Huse and Hansen 1988). Second-strand synthesis is completed using the four conventional nonmethylated bases. The resulting hemimethylated double-stranded cDNA is partially resistant to cleavage by *EcoRI*. This strategy is used in cDNA synthesis kits sold by Stratagene. If the cDNA is methylated by incorporation of 5′ methyldeoxycytosine, it is essential to use a strain of *E. coli* that is deficient in the *mcr* restriction system, which normally cleaves DNA at methylcytosine residues (Raleigh et al. 1988; Woodcock et al. 1989).
- Use *EcoRI* methylase to catalyze the transfer of methyl groups from a donor such as S-adenosylmethionine to the second of the two adenine residues in the recognition sequence of *EcoRI*. The modification of adenine to 6-methylaminopurine protects the DNA from cleavage by *EcoRI* (Greene et al. 1975). *EcoRI* methylase is an efficient enzyme and will usually methylate the vast majority of sites in the cDNA. Specific methylation generally affords the target sequence a high degree of protection against subsequent cleavage by the cognate restriction enzyme. However, because the *EcoRI* methylase is inhibited by  $Mg^{2+}$ , it is essential to precipitate the cDNA with ethanol to cleanse the preparation of  $Mg^{2+}$  before proceeding with methylation (Steps 11–14 of Stage 2).

When establishing cDNA libraries from very small amounts of mRNA, some investigators attempt to maximize the number of cDNA clones by simply omitting the methylation step (e.g., please see McDonnell et al. 1987; Don et al. 1993). This approach suffers from the disadvantage that cDNAs containing “natural” internal *EcoRI* sites are cleaved by *EcoRI* into two or more fragments and cloned separately.

## MATERIALS

**CAUTION:** Please see Appendix 12 for appropriate handling of materials marked with <!>.

### Buffers and Solutions

Please see Appendix 1 for components of stock solutions, buffers, and reagents. Dilute stock solutions to the appropriate concentrations.

*Chloroform* <!>

*10x EcoRI buffer*

*10x EcoRI methylase buffer (Optional)*

If desired, use in place of the Tris-Cl, NaCl, and EDTA in Step 1.

*EDTA (0.5 M, pH 8.0)*

*Ethanol*

*MgCl<sub>2</sub>* (1 M)

*NaCl* (5 M)

*Phenol:chloroform* <1>

*S-Adenosylmethionine*

Use the iodide salt, grade I. Make a stock solution (20 mM) in 5 mM H<sub>2</sub>SO<sub>4</sub> and 10% ethanol. Store the solution in aliquots at -20°C. New England Biolabs provides a solution of *S*-adenosylmethionine when *EcoRI* methylase is purchased.

*Sodium acetate* (3 M, pH 5.2)

*TE* (pH 8.0)

*Tris-Cl* (2 M, pH 8.0)

## Enzymes and Buffers

*EcoRI*

*EcoRI* methylase

New England Biolabs sells an enzyme isolated from a strain of *E. coli* that expresses the methylase gene from a multicopy plasmid.

## Gels

*Agarose gel* (1%)

Please see Step 8.

## Nucleic Acids and Oligonucleotides

*Double-stranded cDNA*

Use the cDNA prepared in Stage 2, Step 14 (p. 11.46) of this protocol.

*Linearized plasmid DNA or Bacteriophage λ DNA*

Either of these is used to check the efficiency of methylation of *EcoRI* sites. The linearized plasmid DNA should contain at least one *EcoRI* site located some distance from the termini. Use a bacteriophage λ DNA such as that used as a size standard for agarose gel electrophoresis (e.g., *HindIII*-digested λ DNA). For plasmid DNA, digest 1 μg to completion with *PstI*. Purify the DNA by extraction with phenol:chloroform and precipitation with ethanol. Dissolve the DNA in 5 μl of TE (pH 7.6) and store it at -20°C.

## Special Equipment

*Water bath* preset to 68°C

## METHOD

---

1. Add to the cDNA (from Stage 2, Step 14, p. 11.46):

2 M Tris-Cl (pH 8.0)	5 μl
5 M NaCl	2 μl
0.5 M EDTA (pH 8.0)	2 μl
20 mM <i>S</i> -adenosylmethionine	1 μl
H <sub>2</sub> O	to 96 μl

2. Remove two 2-μl aliquots and place each in a separate 0.5-ml microfuge tube. Number the tubes 1 and 2, and store the numbered tubes on ice.

3. Add 2  $\mu$ l of *Eco*RI methylase (80,000 units/ml) to the remainder of the reaction mixture and then store the reaction mixture at 0°C until Step 4 is completed.
4. Remove two additional aliquots (2  $\mu$ l each) from the large-scale reaction and place each in a separate 0.5-ml microfuge tube. Number these tubes 3 and 4.
5. To each of the four small aliquots (Steps 2 and 4), add 100 ng of plasmid DNA or 500 ng of bacteriophage  $\lambda$  DNA, prepared as described in Materials. These unmethylated DNAs are used as substrates in pilot reactions to assay the efficiency of methylation.
 

▲ **IMPORTANT** Do not add any DNA to the large-scale reaction!
6. Incubate all four pilot reactions and the large-scale reaction for 1 hour at 37°C.
7. Heat the five reactions to 68°C for 15 minutes. Extract the large-scale reaction once with phenol:chloroform and once with chloroform.
8. To the large-scale reaction add 0.1 volume of 3 M sodium acetate (pH 5.2) and 2 volumes of ethanol. Mix the reagents well and store the ethanolic solution at -20°C until the results of the pilot reactions are available.
9. Analyze the four pilot reactions as follows:
  - a. To each control reaction, add:
 

0.1 M MgCl <sub>2</sub>	2 $\mu$ l
10x <i>Eco</i> RI buffer	2 $\mu$ l
H <sub>2</sub> O	to 20 $\mu$ l
  - b. Add 20 units of *Eco*RI to reactions 2 and 4.
  - c. Incubate all four samples for 1 hour at 37°C, and analyze them by electrophoresis through a 1% agarose gel.
 

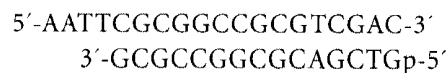
After staining the agarose gel with ethidium bromide, the cDNA can often be seen as a background smear in the gel. The methylated cDNA (and the plasmid or bacteriophage  $\lambda$  DNA in Tubes 3 and 4) should be resistant to cleavage by *Eco*RI and show no change in size. The unmethylated cDNA and the plasmid or bacteriophage DNA in Tubes 1 and 2 should be cleaved by *Eco*RI. If both of these expectations are fulfilled, proceed to Step 10; if they are not, repeat the methylation reaction.
10. Recover the precipitated cDNA (Step 8) by centrifugation at maximum speed for 15 minutes at 4°C in a microfuge. Remove the supernatant, add 200  $\mu$ l of 70% ethanol to the pellet, and centrifuge again.
11. Use a hand-held minimonitor to check that all of the radioactivity is recovered in the pellet. Remove the ethanol by gentle aspiration, dry the pellet in the air, and then dissolve the DNA in 29  $\mu$ l of TE (pH 8.0).
12. Proceed as soon as is feasible to the next stage in the synthesis of the cDNA.



## STAGE 4: Attachment of Linkers or Adaptors

Several different types of oligonucleotide linkers or adaptors may be used to construct cDNA libraries. The simplest of all are unadorned oligonucleotides (typically from 8 to 12 nucleotides in length), whose sequence contains a recognition site for a restriction enzyme such as *EcoRI* (5'-pCGGAATTCGG-3'). These single-stranded oligonucleotides are designed to anneal with one another to form double-stranded linkers that can be ligated to the polished ends of double-stranded cDNAs. During the ligation reaction, the linkers are assembled into progressively longer polymers on each end of the cDNA. The products of the reaction are then cleaved by the appropriate restriction enzyme (in this case *EcoRI*) to remove excess linkers and to expose cohesive termini at the ends of the cDNA (please see Figure 11-14). Clearly, any "natural" *EcoRI* sites in the cDNAs that have not been protected by methylation in Stage 3 are vulnerable to attack by the restriction enzyme. Cleavage at internal sites is undesirable because cDNAs are divided into two or more fragments, which become separated during the cloning process, and because chimeric molecules may be created from fragments of cDNAs derived from independent mRNA templates. These problems will not be bothersome if the methylation reaction (Stage 3) has gone well.

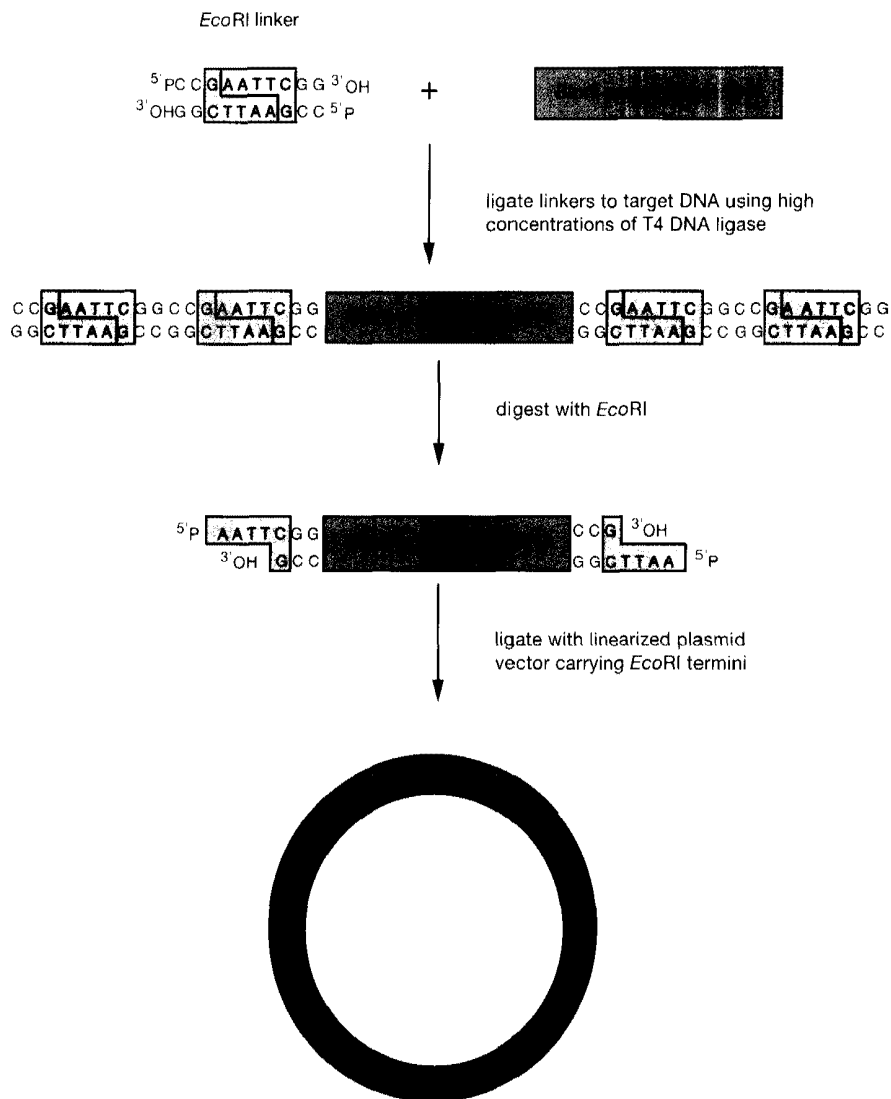
The potential complications of internal cleavage can be suppressed by using adaptors rather than linkers. Adaptors used in cDNA cloning are short double-stranded synthetic oligonucleotides that carry an internal restriction endonuclease recognition site and a protruding terminus at one end, for example:



Note that the double-stranded structure contains an *EcoRI* cohesive terminus, internal *NotI* and *Sall* sites, and only one phosphorylated 5' terminus. One adaptor molecule can be ligated to each end of a blunt-ended double-stranded cDNA molecule. Unlike linkers, adaptors are unable to form multimers because the protruding single-stranded cohesive terminus lacks a 5'-phosphate group. The cDNA molecules therefore become equipped with live *EcoRI* termini without the necessity for digestion by *EcoRI*. However, cDNAs modified by the addition of adaptors at both ends must be phosphorylated before ligation to a dephosphorylated plasmid or bacteriophage  $\lambda$  vector DNA. Because recognition sites for *NotI* and *Sall* occur very rarely in mammalian DNA (please see Appendix 6), they are unlikely to be present within a cDNA sequence. Cleavage of the cloned DNA with one of these enzymes can therefore be used in most cases to release the intact cDNA insert from the vector.

Other types of adaptors permit excellent alternative strategies to be used when ligating cDNA molecules to their vectors. For example, the recessed 3' termini created by digestion of a vector by *XhoI* may be partially filled by addition of a deoxythymidine residue. Phosphorylated adaptors with three-base protruding termini complementary to the partially filled *XhoI* site are attached to the cDNA. Neither the vector nor the cDNA molecules can anneal to themselves, but they can join efficiently to each other. Because the *XhoI* site is regenerated, the cloned cDNA can be recovered by digestion with *XhoI*. This strategy greatly improves the efficiency of the ligation step in cDNA cloning and eliminates the need to methylate the cDNA or to digest it with restriction enzymes before insertion into the vector (Yang et al. 1986; Elledge et al. 1991).

When joining linkers or adaptors to blunt-ended double-stranded cDNA molecules, it is important that the ligation reaction be carried out in as small a volume as possible (to maintain a



**FIGURE 11-14 Addition of Linkers and Adaptors to Double-stranded cDNA Products**

A phosphorylated decameric linker containing a recognition site for *EcoRI* is ligated to blunt-ended target molecules, such as a preparation of double-stranded cDNA. The target molecules are then prepared for cloning by digestion with *EcoRI*.

high concentration of linker-adaptors). The molar concentration of linker-adaptors must be at least 100 times greater than the concentration of termini of cDNA to minimize blunt-end ligation of cDNA molecules. Finally, before the cDNA is inserted into the vector, unreacted adaptors and the low-molecular-weight products created by restriction enzyme digestion of polymerized linkers must be efficiently removed by column chromatography or gel electrophoresis.

## MATERIALS

**CAUTION:** Please see Appendix 12 for appropriate handling of materials marked with <!>.

### Buffers and Solutions

Please see Appendix 1 for components of stock solutions, buffers, and reagents. Dilute stock solutions to the appropriate concentrations.

*ATP (10 mM)*

*5× Bacteriophage T4 DNA polymerase repair buffer*

90 mM (NH<sub>4</sub>)<sub>2</sub>SO<sub>4</sub>

0.33 M Tris-Cl (pH 8.3)

33 mM MgCl<sub>2</sub>

50 mM β-mercaptoethanol <!>

Store the buffer in small aliquots at -20°C.

*Bromophenol blue (0.25% w/v in 50% glycerol)*

*EDTA (0.5 M, pH 8.0)*

*Ethanol*

*Phenol:chloroform <!>*

*Sodium acetate (3 M, pH 5.2)*

*TE (pH 8.0)*

*Tris-Cl (1 M, pH 8.0)*

### Enzymes and Buffers

*Bacteriophage T4 DNA ligase*

*Bacteriophage T4 DNA polymerase*

*Restriction enzymes*

Depending on the type of linkers or adaptors used, *EcoRI*, *NotI*, *Sall*, or other restriction enzymes are required.

### Gels

*Agarose gel (1%)*

Please see Step 12.

### Nucleic Acids and Oligonucleotides

*cDNA, either unmethylated or methylated*

Use the cDNA prepared in either Stage 2, Step 14 or Stage 3, Step 11 of this protocol.

*Control DNA*

Please see note to Step 10.

*dNTP solution containing all four dNTPs, each at 5 mM*

*Linearized plasmid DNA or Bacteriophage λ DNA*

Either of these is used to check the efficiency of digestion following linker addition. A plasmid DNA should contain at least one *EcoRI* site located some distance from the ends of the linear DNA (e.g., Xf3 or pBR322 linearized by digestion with *PstI*). Use a bacteriophage λ DNA such as that used as a size standard for agarose gel electrophoresis (e.g., *HindIII*-digested λ DNA). For plasmid DNA, digest 1 μg to completion with *PstI*. Purify the DNA by extraction with phenol:chloroform and precipitation with ethanol. Dissolve the DNA in 5 μl of TE (pH 7.6). Store at -20°C. Predigested λ DNA can be used as is.

*Synthetic linkers or adaptors*

Phosphorylated linkers and adaptors are sold by several manufacturers. If possible, obtain linkers that are at least 4–8 nucleotides longer than the site recognized by the restriction enzyme. Many restriction enzymes inefficiently cleave recognition sites located very close to the ends of DNA molecules (please see Appendix 6).

## Special Equipment

### *Sephadex G-50 spun column*

Add Sephadex G-50 (medium pore) to sterile H<sub>2</sub>O (10 g of dry powder yields 160 ml of slurry). Wash the swollen resin with sterile H<sub>2</sub>O several times to remove soluble dextran, which can create problems by precipitating during ethanol precipitation. Finally, equilibrate the resin in TE (pH 7.6), autoclave (10 psi [0.70 kg/cm<sup>2</sup>] for 15 minutes), and store at room temperature. Prepacked columns of Sephadex and other gel filtration resins are commercially available.

*Water baths preset to 16°C and 68°C*

## METHOD

---

### Polishing of the cDNA Termini

1. Heat the cDNA (Step 11, p. 11.50) to 68°C for 5 minutes.  
This step denatures any double-stranded structures that may have formed from protruding single-stranded termini of the cDNA molecules.
2. Cool the cDNA to 37°C and add the following to the tube:
 

5x bacteriophage T4 DNA polymerase repair buffer	10 µl
5 mM dNTP solution	5 µl
H <sub>2</sub> O	to 50 µl
3. Add 1–2 units of bacteriophage T4 DNA polymerase (500 units/ml) and incubate the reaction for 15 minutes at 37°C.
4. Stop the reaction by adding 1 µl of 0.5 M EDTA (pH 8.0).
5. Extract the sample with phenol:chloroform, and remove the unincorporated dNTPs by spin-column chromatography through Sephadex G-50 (please see Appendix 8).
6. Add 0.1 volume of 3 M sodium acetate (pH 5.2) and 2 volumes of ethanol to the column flow-through. Store the sample for at least 15 minutes at 4°C.
7. Recover the precipitated cDNA by centrifugation at maximum speed for 15 minutes at 4°C in a microfuge. Dry the pellet in the air, and then dissolve it in 13 µl of 10 mM Tris-Cl (pH 7.6).

### Ligation of Linker-Adaptors to the cDNA

8. Add the following to the repaired DNA:
 

10x T4 DNA ligase buffer	2 µl
800–1000 ng of phosphorylated linkers or adaptors	2 µl
10 <sup>5</sup> Weiss units/ml bacteriophage T4 DNA ligase	1 µl
10 mM ATP	2 µl

Mix and incubate for 8–12 hours at 16°C.  
It is essential to use a vast molar excess of linkers (>100-fold) to ensure that the ends of the cDNA become ligated to a linker and not to each other.
9. Withdraw 0.5 µl from the reaction and store the aliquot at 4°C. Inactivate the ligase in the remainder of the reaction by heating for 15 minutes at 68°C.

## Endonuclease Digestion of the Linker-Adaptors

If endonuclease digestion is necessary to permit ligation of the cDNA to the vector, then proceed with Steps 10–12. However, when using certain adaptor molecules, endonuclease digestion is not required. In these cases, skip to Step 13. For additional details, please see the introduction to this protocol.

When using hemiphosphorylated adaptors (please see the introduction to this protocol), an additional phosphorylation step with bacteriophage T4 polynucleotide kinase must be carried out after ligation. Phosphorylation is easily carried out by adding 30–50 units of bacteriophage T4 polynucleotide kinase directly to the heat-treated ligation products.

a. Add to the heated ligase reaction:

10x bacteriophage T4 polynucleotide kinase buffer	3 $\mu$ l
bacteriophage T4 polynucleotide kinase	30–50 units
H <sub>2</sub> O	to 30 $\mu$ l

b. Incubate the reaction for 1 hour at 37°C.

c. Proceed directly to Step 13.

10. To the heated ligase reaction, add:

10x restriction enzyme buffer	20 $\mu$ l
H <sub>2</sub> O	150 $\mu$ l
restriction enzyme	200 units

Mix the reagents at 0°C.

As a control, transfer 2  $\mu$ l of the reaction to a 0.5-ml microfuge tube. To the 2- $\mu$ l aliquot, add 100 ng (in a volume of no more than 0.5  $\mu$ l) of control DNA, i.e., either a linearized plasmid or a preparation of cleaved bacteriophage  $\lambda$  DNA that contains an internal site for the particular restriction enzyme used.

11. Incubate the large-scale reaction and the control reaction for 2 hours at 37°C.

12. Analyze the DNA in the control sample and the 0.5- $\mu$ l aliquot withdrawn at Step 9 by electrophoresis through a 1% agarose gel. Load one or two lanes of the gel with plasmid or bacteriophage  $\lambda$  marker DNA.

If the ligation has worked well, the ligated linkers should be visible as a smear at the bottom of the gel. If digestion with the restriction enzyme is complete, the smear of linkers should disappear and the plasmid or bacteriophage  $\lambda$  DNA in the control sample should be cleaved appropriately.

The size of the cDNA will not change appreciably after ligation to adaptors. Analysis of the DNA by gel electrophoresis can therefore be omitted when using adaptors.

## Preparation of the cDNA for Size Fractionation

13. Purify the cDNA by extraction with phenol:chloroform and standard precipitation with ethanol. Dissolve the cDNA in 20  $\mu$ l of TE (pH 8.0).

14. Add 2.5  $\mu$ l of a solution of 0.25% bromophenol blue in 50% glycerol. This addition simplifies the next stage in the cDNA library — size-fractionation of the cDNA by chromatography through Sepharose CL-4B (Stage 5).

## STAGE 5: Fractionation of cDNA by Gel Filtration through Sepharose CL-4B

Before insertion into a bacteriophage  $\lambda$  or plasmid vector (Stage 6), the preparation of cDNA is fractionated by gel filtration to remove unused linker-adaptors and low-molecular-weight products created by restriction enzyme digestion of polymerized linkers. Removing flotsam increases the number of recombinants that contain cDNAs and dramatically reduces the number of false recombinants that contain nothing more than annealed linkers. Fractionating the cDNA also creates an opportunity to discard cDNAs that are <500 bp in length. These short fragments are the unwanted products of incomplete synthesis of first- and/or second-strand cDNA synthesis and are of little use to most investigators. Eliminating these fragments from the library certainly reduces the number of recombinants that must be screened and may also increase the chance that entire sequences of the mRNAs of interest will be represented in the library. In some circumstances, there is an advantage in establishing two libraries from the fractionated preparation cDNA — one containing cDNAs whose sizes range is from 0.5 kb to 3.5 kb, and another containing larger cDNAs. Because only a small fraction of the original mRNA population is longer than 3.5 kb, the number of clones in the second library is generally ~10% of the number in the first. However, establishing and screening a library enriched for large cDNAs increases the chance and decreases the labor of isolating full-length cDNAs corresponding to rare mRNAs encoding large proteins.

Electrophoresis through agarose or polyacrylamide gels may also be used to separate unligated linker-adaptors from cDNA and to fractionate the cDNA by size. However, the recovery of cDNA from gels in a form that can be ligated efficiently to the vector can be poor, and chromatography through a long narrow column (27 × 0.3 cm) of Sepharose CL-4B is therefore the best option.

### MATERIALS

---

#### Buffers and Solutions

Please see Appendix 1 for components of stock solutions, buffers, and reagents. Dilute stock solutions to the appropriate concentrations.

*Ethanol*

*Sodium acetate (3 M, pH 5.2)*

*TE (pH 7.6)*

*TE (pH 7.6) containing 0.1 M NaCl*

*Tris-Cl (1 M, pH 8.0)*

#### Gels

*Agarose gel (1%)*

Please see Step 8.

#### Nucleic Acids and Oligonucleotides

*cDNA*

Use the cDNA prepared in Stage 4, Steps 13 and 14.

*Marker DNA*

The marker DNA should be end-labeled fragments ranging in size from 200 bp to 5 kb.

## Special Equipment

*Filtered compressed air*

*Hemostat or equivalent hose clamp*

*Hypodermic needle with a bent tip*

*Pipette, disposable (1 ml)*

*Polyvinyl chloride tubing*

*Scissors*

*Sepharose CL-4B*

Wash the paste supplied by the manufacturer several times in sterile TE (pH 7.6) containing 0.1 M NaCl. This washing removes inhibitors of ligation present in some batches of the gel. Prepacked columns of Sepharose CL-4B (SizeSep 400 Spun Columns) are available from Amersham Pharmacia Biotech.

*Vinyl bubble tubing*

*Whatman 3MM paper*

## METHOD

---

### Preparation of Sepharose CL-4B Column

1. Use a hypodermic needle with a bent end to pull the cotton wool pledget halfway out of the end of a sterile, disposable 1-ml pipette. Cut the pledget in half with sterile scissors. Discard the loose piece of cotton wool. Use filtered compressed air to blow the remainder of the pledget to the narrow end of the pipette.
2. Attach a piece of sterile polyvinyl chloride tubing (of the type normally used in peristaltic pumps) to the narrow end of the pipette. Dip the wide end of the pipette into a solution of TE (pH 7.6) containing 0.1 M NaCl in a beaker. Attach the tubing to an Erlenmeyer flask connected to a vacuum line. Apply gentle suction until the pipette is filled with buffer. Close the tubing with a hemostat.
3. Attach a piece of vinyl bubble tubing to the wide end of the pipette. Fill the bubble tubing with Sepharose CL-4B equilibrated with TE (pH 7.6) containing 0.1 M NaCl. Allow the slurry to settle for a few minutes and then release the hemostat. The column will form as the buffer drips from the pipette. If necessary, add more Sepharose CL-4B until the packed matrix almost fills the pipette.

The dimensions of the packed column should be  $\sim 27 \times 0.3$  cm.
4. Wash the column with several column volumes of TE (pH 7.6) containing 0.1 M NaCl. After washing is completed, use a hemostat to close the tubing at the bottom of the column.

### Separation and Recovery of Size-selected cDNA

5. Use a Pasteur pipette to remove the fluid above the Sepharose CL-4B. Apply the cDNA (in a volume of 50  $\mu$ l or less) to the column. Release the hemostat and allow the cDNA to enter the gel matrix. Wash the microfuge tube used to store the cDNA with 50  $\mu$ l of TE (pH 7.6), and apply this to the column. Fill the bubble tubing with TE (pH 7.6) containing 0.1 M NaCl.

▲ **IMPORTANT** Do not allow the column to run dry at any stage!
6. Monitor the progress of the cDNA through the column using a hand-held minimonitor. Begin collecting 2-drop fractions ( $\sim 60$   $\mu$ l) in microfuge tubes when the radioactive cDNA has

traveled two thirds the length of the column. Continue collecting fractions until all of the radioactivity has eluted from the column.

7. Measure the radioactivity in each fraction by Cerenkov counting (please see Appendix 8).
8. Analyze small aliquots of each fraction (~5 µl) by electrophoresis through a 1% agarose gel, using as markers end-labeled fragments of DNA of known size (200 bp to 5 kb). Store the remainder of the fractions at -20°C until the autoradiograph of the agarose gel is available.
  - Cast the agarose gel as thin as possible to speed up the drying process at the completion of electrophoresis.
  - The amount of radioactivity in the preparation of marker DNAs should be ~0.3 times the amount in the peak fractions of cDNA.
9. After electrophoresis, transfer the gel to a piece of Whatman 3MM paper. Cover the gel with Saran Wrap, and dry it on a commercial gel dryer. Heat the gel to 50°C for the first 20–30 minutes of drying and then turn off the heat. Continue drying the gel under vacuum for a further 1–2 hours.
10. Expose the dried gel to X-ray film at -70°C with an intensifying screen (please see Appendix 9).
  - The autoradiograph should reveal a size-fractionated smear of radioactivity with cDNAs in the 5–7-kb range in early fractions from the column and progressively smaller cDNAs in subsequent fractions.
11. Add 0.1 volume of 3 M sodium acetate (pH 5.2) and 2 volumes of ethanol to fractions containing cDNA molecules that are ≥500 bp in length. Allow the cDNA to precipitate for at least 15 minutes at 4°C. Recover the DNA by centrifugation at maximum speed for 15 minutes at 4°C in a microfuge.
  - Be very conservative in selecting these fractions. Resist all temptation to include fractions that contain any traces of cDNAs smaller than 500 bp; otherwise, the library will contain a preponderance of short clones.
12. Dissolve the DNA in a total volume of 20 µl of 10 mM Tris-Cl (pH 7.6).
13. Determine the amount of radioactivity present in a small aliquot, and calculate the total amount of cpm available in the selected fractions. Calculate the total quantity of cDNA available for ligation to bacteriophage λ arms (for calculation of second-strand cDNA data, please see Stage 2, Step 8):

$$\frac{\text{cpm available}}{\text{cpm incorporated into second strand}} \times 2x \mu\text{g second-strand cDNA synthesized}$$

$$= \mu\text{g of cDNA available for ligation}$$

If everything has gone well, 10 µg of poly(A)<sup>+</sup> RNA should yield at least 250–400 ng, and possibly as much as 3 µg, of cDNA whose size is larger than 500 bp in length.



## STAGE 6: Ligation of cDNA to Bacteriophage $\lambda$ Arms

If everything up to this point has worked perfectly, all of the termini in the preparation of cDNA should be equipped with cohesive termini that can be ligated efficiently to a bacteriophage  $\lambda$  or plasmid vector. In practice, the situation may be far from ideal. If, for example, the frayed termini of double-stranded cDNA were inefficiently polished or phosphorylated during Stage 2, they would not carry a linker or adaptor and would be unable to ligate efficiently to the vector. The best way to estimate the concentration of competent termini in the cDNA is to carry out pilot ligations and either packaging reactions or transformations. In these reactions, a constant amount of bacteriophage  $\lambda$  arms or linearized, dephosphorylated plasmids are ligated to varying amounts of cDNA. The aim is to settle on an amount of cDNA that yields a mammalian cDNA library of reasonable size. Today, a library consisting of  $5 \times 10^5$  recombinants is regarded as barely acceptable; because of the high quality of enzymes currently available, libraries containing  $5 \times 10^6$  to  $5 \times 10^7$  independent clones are now well within the reach of the average investigator.

The pilot ligation reactions are carefully arranged to minimize the chance that a single recombinant bacteriophage or plasmid will contain more than one cDNA molecule. Avoid clones containing compound cDNAs by

- using a molar ratio of phosphorylated  $\lambda$  arms to cDNA such that only 5% of the resulting bacteriophages are recombinant
- or
- if dephosphorylated  $\lambda$  arms or plasmid vectors are used, ascertaining the amount of cDNA that generates tenfold more plaques or colonies, respectively, than vector ligated in the absence of cDNA.

When constructing cDNA libraries in bacteriophage vectors such as  $\lambda$ gt11,  $\lambda$ gt18-23,  $\lambda$ ZipLox, and  $\lambda$ ZAP, which have no system to allow selection against nonrecombinant bacteriophages, it is sensible to use dephosphorylated arms, which reduce by  $\sim 100$ -fold the number of empty bacteriophages in the cDNA library. The same result can be achieved using arms with non-compatible termini produced by partial filling or addition of appropriate linker-adaptors. With some of these vectors, it is possible to estimate the ratio of empty to recombinant bacteriophages in the library by plating on strains of *E. coli* such as Y1090*hsdR*. In the presence of the inducer IPTG and the chromogenic substrate X-gal, nonrecombinant plaques are blue; recombinant plaques are colorless.

Nonrecombinant bacteriophages present less of a problem when bacteriophages such as  $\lambda$ gt10 are used as vectors, since a single round of growth on *E. coli* strains carrying an *hfl<sup>-</sup>* mutation eliminates the vast majority of nonrecombinants from the population. Recombinants form clear plaques on the *E. coli hfl<sup>-</sup>* strain BNN102 (because insertion of the cDNA inactivates the *cl* gene, which codes for repressor). Nonrecombinant bacteriophages establish repression so effectively that their efficiency of plating is greatly reduced. The absolute number of cDNA recombinants constructed in  $\lambda$ gt10 can therefore be obtained by counting the number of plaques formed on BNN102. The proportion of recombinants in the bacteriophage stock can be measured by counting the ratio of clear to turbid plaques on C600, an *hfl<sup>+</sup>* strain. Recombinant bacteriophages form clear plaques on this strain, whereas nonrecombinant bacteriophages, which continue to synthesize active repressor, give rise to turbid plaques. The number of clear plaques on strain C600 should equal the total number of plaques on strain BNN102. For reasons that are unclear,

this powerful genetic selection against nonrecombinant bacteriophages is used only rarely, with most investigators preferring to use dephosphorylated  $\lambda$ gt10 DNA arms.

The main protocol provides instructions for preparing a cDNA library in a bacteriophage  $\lambda$  vector. An alternative protocol follows Step 8 that substitutes a plasmid vector for the bacteriophage  $\lambda$  arms. Plasmid vectors may be preferable when preparing a cDNA expression library that will be screened after it is transfected into cultured mammalian cells. For details on individual vectors, please see the information panel on **COMMERCIAL KITS FOR cDNA SYNTHESIS AND LIBRARY CONSTRUCTION**.

## MATERIALS

---

### Buffers and Solutions

**Please see Appendix 1 for components of stock solutions, buffers, and reagents. Dilute stock solutions to the appropriate concentrations.**

*ATP (10 mM)*

*SM*

### Enzymes and Buffers

*Bacteriophage T4 DNA ligase*

### Gels

*Agarose gel (1%)*

Please see Step 8.

### Nucleic Acids and Oligonucleotides

*cDNA*

Use the cDNA prepared in Stage 5, Step 12 (p. 11.58), of this protocol.

*Control bacteriophage  $\lambda$  DNA*

This DNA is usually provided with the commercial packaging extract and is used to determine the packaging efficiency of the extract.

*Marker DNA*

The marker DNA should be fragments ranging in size from 500 bp to 5 kb.

### Special Equipment

*Water baths preset to 16°C and 42°C*

### Additional Reagents

*Step 4 of this protocol requires the reagents listed in Chapter 2, Protocol 1.*

*Step 7 of this protocol requires the reagents listed in Chapter 2, Protocol 23.*

### Vectors and Bacterial Strains

*Bacteriophage  $\lambda$  arms*

If making a large number of libraries, it is much less expensive to prepare arms by agarose gel electrophoresis or by sucrose density gradients (please see Chapter 2, Protocol 16) than to purchase them. For occasional users, dephosphorylated arms for some vectors (e.g.,  $\lambda$ gt10,  $\lambda$ Fix, and  $\lambda$ ZipLox) are available from Stratagene, Life Technologies, and other commercial suppliers. Whatever the source of arms, it is important to carry out a series of pilot reactions to check that the arms can be ligated to foreign DNA and packaged efficiently into infectious bacteriophage  $\lambda$  particles. DNAs for these controls are usually included with commercial preparations of vector arms.

*E. coli strain, freshly prepared overnight cultures*

Use strains C600 (BNN93) for growth and BNN102 (C600*hflA*) for screening of cDNA libraries constructed in bacteriophage  $\lambda$ gt10. Use strain Y1090*hsdR* for growth and screening of cDNA libraries constructed in bacteriophage  $\lambda$ gt11. Use strain BB4 for growth and screening of cDNA libraries construct-

ed in  $\lambda$ ZAP and  $\lambda$ ZAPII or strain XL1-Blue for  $\lambda$ ZAPII. (Strain XL1-Blue supports vigorous growth of  $\lambda$ ZAPII but not of  $\lambda$ ZAP.) For  $\lambda$ ZipLox, use strain Y1090(ZL). Please see the panel on **PLATING BACTERIOPHAGE  $\lambda$  ON *E. COLI* STRAINS** on the following page.

*Packaging extracts for bacteriophage  $\lambda$*

Packaging extracts are difficult to make and should therefore be purchased commercially. Several commercial suppliers provide packaging kits with unique features. For a description of packaging extracts, please see the information panel on **IN VITRO PACKAGING**.

## METHOD

1. Set up four test ligation/packaging reactions as follows:

Ligation	A	B	C	D
$\lambda$ vector DNA (0.5 $\mu\text{g}/\mu\text{l}$ )	1.0 $\mu\text{l}$	1.0 $\mu\text{l}$	1.0 $\mu\text{l}$	1.0 $\mu\text{l}$
10x T4 DNA ligase buffer	1.0 $\mu\text{l}$	1.0 $\mu\text{l}$	1.0 $\mu\text{l}$	1.0 $\mu\text{l}$
cDNA	0 ng	5 ng	10 ng	50 ng
Bacteriophage T4 DNA ligase (100 Weiss units/ $\mu\text{l}$ )	0.1 $\mu\text{l}$	0.1 $\mu\text{l}$	0.1 $\mu\text{l}$	0.1 $\mu\text{l}$
10 mM ATP	1.0 $\mu\text{l}$	1.0 $\mu\text{l}$	1.0 $\mu\text{l}$	1.0 $\mu\text{l}$
H <sub>2</sub> O to a final volume of	10 $\mu\text{l}$	10 $\mu\text{l}$	10 $\mu\text{l}$	10 $\mu\text{l}$

Adding ATP as a component of the 10x ligation buffer leaves more volume for vector or foreign DNA in the reaction mixture. If using a commercial ligase buffer that contains ATP, the addition of ATP is not required.

Incubate the ligation mixtures for 4–16 hours at 16°C. Store the unused portion of the cDNA at –20°C.

2. Package 5  $\mu\text{l}$  of each ligation into bacteriophage  $\lambda$  particles following the directions provided by the manufacturer of the packaging extract.
 

Because the size of the final cDNA library depends on the efficiency with which recombinant bacteriophage  $\lambda$  genomes are packaged into infectious bacteriophage  $\lambda$  particles, it is essential to use packaging mixtures of high potency that yield  $>5 \times 10^8$  pfu/ $\mu\text{g}$  of bacteriophage  $\lambda$  DNA.

Be sure to include a control  $\lambda$  DNA (usually provided with the packaging reaction kit) to determine the packaging efficiency of the extract on hand.
3. After the packaging reaction is complete, add 0.5 ml of SM to each mixture.
4. Use the fresh overnight cultures of the appropriate strain(s) of *E. coli* to plate 10  $\mu\text{l}$  and 100  $\mu\text{l}$  of a  $10^{-2}$  dilution of each packaging mixture on each strain (please see Chapter 2, Protocol 1, and the panel on **PLATING BACTERIOPHAGE  $\lambda$  ON *E. COLI* STRAINS**). Incubate the plates for 8–12 hours at 37°C or 42°C.
5. Count the number of recombinant and nonrecombinant plaques. Ligation A should yield no recombinant plaques, whereas ligations B, C, and D should yield increasing numbers of recombinant plaques.
6. From the number of recombinant plaques, calculate the efficiency of cloning of cDNA (pfu/ng cDNA). If all has gone well, the efficiency should be at least  $2 \times 10^4$  pfu/ng cDNA. The total yield of recombinants from 5  $\mu\text{g}$  of poly(A)<sup>+</sup> RNA should be in excess of  $5 \times 10^6$ .
7. Pick 12 recombinant bacteriophage  $\lambda$  plaques, grow small-scale lysates, and prepare DNAs for digestion with the appropriate restriction enzyme.
8. Analyze the size of the cDNA inserts by electrophoresis through a 1% agarose gel, using as markers fragments of DNA 500 bp to 5 kb in length.

**PLATING BACTERIOPHAGE  $\lambda$  ON *E. COLI* STRAINS**

Different bacteriophage  $\lambda$  vectors require different strains of *E. coli* for plaque formation. The following are some general notes on preferences:

- **Plaque formation with  $\lambda$ gt10:** Grow *E. coli* strains C600 and BNN102 in NZCYM (please see Chapter 2, Protocol 1) containing 0.2% maltose. (BNN102 grows much more slowly than C600.) Prepare stocks of plating bacteria of both strains as described in Chapter 2, Protocol 1. Note that it may be necessary to suspend the bacteria of strain BNN102 in a smaller volume of 10 mM MgSO<sub>4</sub> than usual to attain a density of  $\sim 1.5 \times 10^9$  cells/ml.  
Measure the number of infectious bacteriophage particles produced in the packaging mixtures as described in Chapter 2, Protocol 1, using LB agar plates and LB top agarose. Clear and turbid plaques are easily distinguished when plated at low density on confluent bacterial lawns. Plaques of recombinant  $\lambda$ gt10 bacteriophages appear on lawns of C600 cells after 6–7 hours of incubation at 37°C; plaques on BNN102 take 1–2 hours longer to appear.
- **Plaque formation with  $\lambda$ gt11 and  $\lambda$ gt18-23:** Grow *E. coli* strain Y1090hsdR in NZCYM medium containing 0.2% maltose. Prepare a stock of plating bacteria in 10 mM MgSO<sub>4</sub> as described in Chapter 2.  
Measure the number of infectious bacteriophage particles produced in the packaging mixtures as described in Chapter 2, Protocol 1, using 3 ml of LB top agarose containing 40  $\mu$ l of a stock solution of X-gal (20 mg/ml in dimethylformamide) and 4  $\mu$ l of a solution of IPTG (200 mg/ml) for each 90-mm Petri dish. Incubate the plates for 8–10 hours at 37°C.
- **Plaque formation with  $\lambda$ ZAP:** Grow *E. coli* strain BB4 in NZCYM medium containing 0.2% maltose. Prepare a stock of plating bacteria in 10 mM MgSO<sub>4</sub> as described in Chapter 2, Protocol 1.  
Measure the number of infectious bacteriophage particles produced in the packaging mixtures as described in Chapter 2, Protocol 1, using 3 ml of LB top agarose containing 40  $\mu$ l of a stock solution of X-gal (20 mg/ml in dimethylformamide) and 4  $\mu$ l of a solution of IPTG (200 mg/ml) for each 90-mm Petri dish. Incubate the plates for 8–10 hours at 42°C to prevent the formation of lysogens. Y1090hsdR should not be used with the  $\lambda$ ZAP vectors, since this strain contains a plasmid (pMC9) that is homologous to the phagemid sequences within the  $\lambda$ ZAP vector. This homology can promote recombination between the bacteriophage  $\lambda$  vector and the plasmid.
- **Plaque formation with  $\lambda$ ZAPII:** Grow *E. coli* strain XL1-Blue in NZCYM medium containing 0.2% maltose. Prepare a stock of plating bacteria in 10 mM MgSO<sub>4</sub> as described in Chapter 2, Protocol 1.  
Measure the number of infectious bacteriophage particles produced in the packaging mixtures as described in Chapter 2, Protocol 1, using 3 ml of LB top agarose containing 40  $\mu$ l of a stock solution of X-gal (20 mg/ml in dimethylformamide) and 4  $\mu$ l of a solution of IPTG (200 mg/ml) for each 90-mm Petri dish. Incubate the plates for 8–10 hours at 42°C to prevent the formation of lysogens.
- **Plaque formation with  $\lambda$ ZipLox:** Grow *E. coli* strain Y1090(ZL) in NZCYM medium containing 0.2% maltose. Prepare a stock of plating bacteria in 10 mM MgSO<sub>4</sub> as described in Chapter 2, Protocol 1.  
Measure the number of infectious bacteriophage particles produced in the packaging mixtures as described in Chapter 2, Protocol 1, using LB agar plates and LB top agarose. Plaques of recombinant  $\lambda$ ZipLox bacteriophages appear on lawns of Y1090(ZL) cells after incubating for 6–7 hours at 37°C. Strain Y1090(ZL) is a derivative of strain Y1090hsdR that has been cured of the resident pMC9 plasmid.
- **Use of 0.2% maltose:** Some investigators add maltose to media used to grow and plate bacteriophage  $\lambda$ . The presence of 0.2% maltose leads to a substantial induction of the maltose operon including the *lamB* gene, which encodes the cell surface receptor to which bacteriophage  $\lambda$  binds (Schwartz 1967). This induction should theoretically increase the efficiency of infection and hence the yield of bacteriophage. The use of maltose is a double-edged sword, however, since florid growth of some strains of *E. coli* in such rich medium may lead to cell lysis and the accumulation of cellular debris laden with the LamB protein. Binding of bacteriophage particles to this debris leads to futile release of the viral DNA and an unproductive infection. In our hands, there is little difference in bacteriophage yield from cultures grown in the presence or absence of maltose.

**ALTERNATIVE PROTOCOL: LIGATION OF cDNA INTO A PLASMID VECTOR**

The decision to use a plasmid vector instead of a bacteriophage  $\lambda$  vector will depend on the method used to screen for the target DNA and on personal preference. A number of highly evolved plasmid vectors are now available, including pCMV-Script (Stratagene), pSPORT (Life Technologies), and pcDNA3.1 (Invitrogen). These versatile molecules are especially useful when preparing cDNA expression libraries.

**Additional Materials**

Plasmid vector

*E. coli* competent for transformation

Step 2 requires the reagents from one of the transformation protocols in Chapter 1.

Step 5 requires the reagents listed in Chapter 1, Protocol 1.

**Method**

1. Set up four test ligation/packaging reactions as follows:

Ligation	A	B	C	D
plasmid vector DNA (50 ng/ $\mu$ l)	1.0 $\mu$ l	1.0 $\mu$ l	1.0 $\mu$ l	1.0 $\mu$ l
10x T4 DNA ligase buffer	1.0 $\mu$ l	1.0 $\mu$ l	1.0 $\mu$ l	1.0 $\mu$ l
cDNA	0 ng	5 ng	10 ng	50 ng
Bacteriophage T4 DNA ligase (100 Weiss units/ $\mu$ l)	0.1 $\mu$ l	0.1 $\mu$ l	0.1 $\mu$ l	0.1 $\mu$ l
10 mM ATP	1.0 $\mu$ l	1.0 $\mu$ l	1.0 $\mu$ l	1.0 $\mu$ l
H <sub>2</sub> O to a final volume of	10 $\mu$ l	10 $\mu$ l	10 $\mu$ l	10 $\mu$ l

Incubate the ligation mixtures for 4–16 hours at 16°C. Store the unused portion of the cDNA at –20°C.

Be sure to include a control ligation reaction using a test insert to determine the ligation and transformation efficiencies.

2. Transform an appropriate strain of competent *E. coli* bacteria using one of the transformation methods described in Chapter 1.
3. After an overnight incubation at 37°C, count the number of antibiotic-resistant colonies. Ligation A should yield few if any colonies, whereas ligations B, C, and D should yield increasing numbers of colonies containing recombinant plasmid molecules.
4. From the number of colonies, calculate the efficiency of cloning of cDNA (colony-forming units [cfu]/ng cDNA). If all has gone well, the efficiency should be at least  $2 \times 10^4$  cfu/ng cDNA. The total yield of recombinants from 5  $\mu$ g of poly(A)<sup>+</sup> RNA should be in excess of  $5 \times 10^6$ .
5. Pick 12 colonies, grow small-scale cultures, and prepare DNA for digestion with the appropriate restriction enzyme as described in Chapter 1, Protocol 1.
6. Analyze the size of the cDNA inserts by electrophoresis through a 1% agarose gel, using as markers fragments of DNA 500 bp to 5 kb in length (whether plasmid or bacteriophage  $\lambda$ ).

If the recombinant vector molecules (whether plasmid or bacteriophage  $\lambda$ ) contain inserts of different sizes and if the average size of the inserts is  $\sim$ 1 kb or greater, it is worthwhile proceeding to the generation of a complete cDNA library. If the average size of the inserts is significantly less than 1 kb, then the quality of the library is not as high as it could be. Go back and reanalyze the quality of the starting mRNA and the cDNA reactions, paying special attention to the precautions noted in Stage 1, Step 6 and the panel on **OPTIMIZING FIRST-STRAND cDNA SYNTHESIS**; Stage 2, Step 8 and the panel on **OPTIMIZING SECOND-STRAND cDNA SYNTHESIS**; and the introduction to Stage 5. For additional assistance on improving the quality of the library, please see the panel on **TROUBLESHOOTING** on the following page.

The trial ligation reactions will often yield sufficient recombinant molecules ( $>10^5$  cfu) to begin screening for the cDNA of interest. To generate a complete library from the size-fractionated cDNA, additional ligation reactions should be set up based on the results of the trial ligations and subsequently packaged or used to transform *E. coli*. The amount of cDNA required depends in part on the estimated abundance of the desired cDNA, how the library will be used in the future, and the laboratory budget. A primary library of  $>10^6$  clones should yield even rare cDNAs. If the library is to be screened several times, then as many as  $10^7$  recombinants may be required. However, vectors and packaging reactions are expensive, and it can cost many thousands of dollars to ligate and package every nanogram of cDNA. Such sums are usually out of the reach of all but the richest laboratories.

**TROUBLESHOOTING**

Several problems related to the addition of linker-adaptors to cDNA ends may become evident following restriction analysis of the recombinant bacteriophage  $\lambda$  or plasmid DNA.

- **The cDNA inserts contain more sites for *NotI*, *SalI*, or *EcoRI* than expected.** In mammalian DNA, *NotI* sites occur, on average, once in 1000 kb; *SalI* sites are separated by an average of 100 kb, and *EcoRI* sites are separated by an average of 4 kb. If these sites occur more frequently than expected (e.g., if every cDNA carries an internal *NotI* site), it is likely that tandem arrays of cDNA molecules have been cloned into the vector. This problem can be avoided by decreasing the ratio of inserts to vector molecules in the ligation mixtures of Step 1.
- **The frequency of *EcoRI* sites within the cDNA inserts is <1 site per 4 kb.** This problem arises when methylation of *EcoRI* sites within the double-stranded cDNA is not complete. In this case, it is usually necessary to check the methylation reaction in a series of pilot reactions and then to repeat the methylation step using a fresh batch of cDNA.
- **No cDNA inserts can be excised from the vector by digestion with the appropriate restriction enzyme.** This problem is almost always caused by inefficiency in adding synthetic linkers or adaptors to the ends of the double-stranded cDNA. Re-treat the ends of the double-stranded cDNA with bacteriophage T4 DNA polymerase (Stage 4, Steps 2 and 3), and repeat the large-scale ligation reaction with a mixture of unlabeled, phosphorylated linkers and  $^{32}\text{P}$ -labeled linkers. Analyze an aliquot of the reaction by polyacrylamide gel electrophoresis to check that the radiolabeled linkers have formed a series of ligation products that exhibit a ladder-like distribution. Finally, cDNA inserts that cannot be excised by digestion with the appropriate restriction enzyme can often be recovered by digesting the recombinant vector DNA with restriction enzymes that cleave the vector sequences near the site at which the cDNA is inserted. For example, *HindIII* and *BglII* cleave on either side of the single *EcoRI* site used for cloning in  $\lambda\text{gt}10$ , generating a DNA fragment  $\sim 1$  kb in length. The size of cDNA inserts in putative  $\lambda\text{gt}10$  recombinants can be estimated from changes in the mobility of this fragment and the appearance of novel DNA fragments. Alternatively, cDNA inserts can be directly amplified via PCR from bacteriophage  $\lambda$  plaques or antibiotic-resistant colonies (please see Chapter 8, Protocol 12).

**ADDITIONAL PROTOCOL: AMPLIFICATION OF cDNA LIBRARIES**

We strongly recommend that primary libraries be used for most cDNA screening purposes. Although amplification of a primary library can provide a near limitless source of cDNA clones to screen, even a single round of amplification distorts the representation of mRNAs in a cDNA library. However, amplification is certainly the best option when the amount of a given library begins to dwindle.

Amplification involves plating the primary library in its entirety on agar plates and then preparing a lysate from the dishes. The lysate is thereafter used as a source of recombinant bacteriophages for screening with nucleic acids, antibodies, or other ligands. Although amplification is a simple procedure, plating and growth invariably reduce the complexity of the library, i.e., the number of independent cDNA clones in the collection. This loss results from plating inefficiency, poor growth of some recombinants, and faster growth of nonrecombinant virus. A good example of this phenomenon is the relative ability of different investigators to isolate a cDNA for their favorite gene from a commercially available library. Often, one investigator can find many clones for one gene in a given library, whereas a colleague detects no isolates for another equally abundant mRNA on the same filters. Commercial libraries are invariably amplified, unless they have been custom-synthesized, and they therefore have a biased representation of the starting mRNA population.

As noted several times in this protocol, use primary libraries whenever possible. However, if the need arises, one of the two following methods can be used to amplify most bacteriophage- $\lambda$ -based cDNA libraries.

**METHOD 1: Amplification of Libraries Constructed in  $\lambda\text{gt}10$** 

To establish a permanent supply of the library, it should be amplified by growth on *E. coli* strain BNN102 on agar plates. The BNN102 strain contains an *hflA* mutation that selects against nonrecombinant bacteriophages (please see the panel on **PLATING BACTERIOPHAGE  $\lambda$  ON *E. COLI* STRAINS** [in the main protocol of Stage 6] and comments in the protocol introduction).

**Additional Materials**

**CAUTION:** Please see Appendix 12 for appropriate handling of materials marked with <!>.

Chloroform <!>

Dimethylsulfoxide <!>

NZCYM agar plates and top agarose

Sorvall SS-34 rotor or equivalent

**Method**

1. For amplification, add  $10^5$  bacteriophages or 200  $\mu$ l of the packaging mixture (whichever is the smaller volume) to 300  $\mu$ l of plating bacteria of strain BNN102 (for methods, please see Chapter 2, Protocol 1). Incubate the infected culture for 20 minutes at 37°C. Then plate the entire culture in top agarose on a 150-mm Petri dish containing NZCYM agar, and incubate the plate for 8–10 hours at 37°C.

In some cases, the use of large volumes of packaging mixture leads to a reduction in plating efficiency. This inhibition can be checked before amplification by a reconstruction experiment in which known numbers of bacteriophage  $\lambda$ gt10 (e.g., 1000 pfu) are mixed with increasing amounts of packaging mixture and plated on *E. coli* strains C600 and BNN102. The cost of such an experiment can quickly become prohibitive if commercial packaging extracts are used.

2. Overlay the plates with 15 ml of SM. Store the plates for 2 hours at room temperature or overnight at 4°C.
3. Harvest the SM carefully, and remove cellular debris by centrifugation at 7000g (7700 rpm in a Sorvall SS-34 rotor) for 30 minutes at 4°C. The cDNA library will be stable for several months when stored at 4°C in small (1-ml) aliquots in tightly closed tubes, each of which contains 20–30  $\mu$ l of chloroform. For longer-term storage, add dimethylsulfoxide to a final concentration of 7% (v/v) and store aliquots at –70°C.
4. Measure the titer of the library on *E. coli* strains C600 and BNN102 (please see Chapter 2, Protocol 1). The titer of clear plaques on strain C600 should be  $10^{10}$  to  $10^{11}$  pfu/ml and the ratio of clear to turbid plaques should be >20:1.

In any amplification, keep in mind that the size or complexity of the library is determined by the number of independent recombinant plaques that are amplified. For example, if ten plates, each containing 100,000 plaques, are used for amplification, the resulting cDNA library can have no more than 1,000,000 members. The titer of the amplified library has nothing to do with its complexity.

**METHOD 2: Amplification of Libraries Constructed in  $\lambda$ gt11,  $\lambda$ ZAP,  $\lambda$ ZipLox, and Their Derivatives**

Table 11-4 lists the strains that should be used to amplify cDNA libraries constructed in various types of bacteriophage  $\lambda$  vectors.

**Additional Materials**

**CAUTION:** Please see Appendix 12 for appropriate handling of materials marked with <!>.

Chloroform <!>

Dimethylsulfoxide <!>

200 mg/ml IPTG (20% w/v)

LB agar plates and top agarose

NZCYM agar plates and top agarose

Sorvall SS-34 rotor or equivalent

20 mg/ml X-gal (2% w/v in dimethylformamide) <!>

**Method**

1. Mix  $10^5$  bacteriophages with 300  $\mu$ l of plating bacteria of the appropriate *E. coli* strain. After incubating for 20 minutes at 37°C, plate the infected culture in top agarose on a 150-mm Petri dish containing NZCYM agar. Incubate for 12 hours at 37–42°C (The latter temperature is used with  $\lambda$ gt11 libraries and libraries prepared in derivatives of  $\lambda$ gt11 to prevent the formation of lysogens. All other viral vectors are grown at 37°C.)
2. Prepare and store the library as described above in Steps 2 and 3 of Method 1.
3. Titer the amplified library on the appropriate *E. coli* strain using LB agar plates and 3 ml of top agarose containing 40  $\mu$ l of a stock solution of X-gal and 4  $\mu$ l of a solution of IPTG (200 mg/ml). The ratio of blue to colorless plaques is a measure of the proportion of the library that consists of nonrecombinant bacteriophages.

TABLE 11-4 *E. coli* Strains for the Amplification of cDNA Libraries in Bacteriophage  $\lambda$  Vectors

STRAIN OF BACTERIOPHAGE $\lambda$ USED FOR CONSTRUCTION OF cDNA LIBRARY	STRAIN OF <i>E. COLI</i> RECOMMENDED FOR AMPLIFICATION (GENOTYPE)	COMMENTS
$\lambda$ gt11 $\lambda$ gt18 $\lambda$ gt20 $\lambda$ gt22	Y1090 <i>hsdR</i> ( <i>supF hsdR araD139</i> $\Delta$ <i>lon</i> $\Delta$ <i>lacU169</i> <i>rpsL</i> <i>trpC22::Tn10(tet<sup>r</sup>)pMC9</i> )	Strain Y1090 <i>hsdR</i> : <ul style="list-style-type: none"> <li>• Carries a plasmid (pMC9: pBR322 <i>lacI<sup>q</sup></i>) that expresses the <i>lac</i> repressor and prevents synthesis of fusion proteins controlled by the <i>lacZ</i> promoter.</li> <li>• Is deficient in the <i>lon</i> protease; in <i>lon<sup>-</sup></i> cells, <math>\beta</math>-galactosidase fusion proteins often accumulate to much higher levels than in wild-type cells.</li> <li>• Is <i>supF</i>, suppressing the normally defective lysis of <math>\lambda</math>gt11 and leading to a high frequency of lytic plaque.</li> <li>• Is defective for host-controlled restriction (<i>hsdR<sup>-</sup></i>) but carries an active methylation system (<i>hsdM<sup>+</sup></i>).</li> </ul> <p>Potential sites for restriction by the <i>EcoK</i> system become methylated during amplification so that, if necessary, the recombinants can be used to infect a restriction-competent strain of <i>E. coli</i>.</p>
$\lambda$ ZAP	BB4 ( <i>supF58 supE44 hsdR514</i> <i>galK2 galT22 trpR55</i> <i>metB1 tonA</i> $\Delta$ <i>lacU169</i> <i>F<sup>+</sup>[proAB<sup>+</sup> lacI<sup>q</sup></i> <i>lacZ</i> $\Delta$ M15Tn10( <i>tet<sup>r</sup></i> )]	$\lambda$ ZAP cannot be grown on strain Y1090 <i>hsdR</i> due to the homology between the plasmid pMC9 and phagemid sequences within the $\lambda$ ZAP vector; this homology interferes with excision of cDNA-containing plasmids from the vector; expression of toxic fusion proteins in strain BB4 strain is prevented by a <i>lacI<sup>q</sup></i> gene on an F episome. <p>Strain BB4 is defective for host-controlled restriction (<i>hsdR<sup>-</sup></i>) but carries an active methylation system (<i>hsdM<sup>+</sup></i>); potential sites for restriction by the <i>EcoK</i> system become methylated during amplification so that, if necessary, the recombinants can be used to infect a restriction-competent strain of <i>E. coli</i>.</p>
$\lambda$ ZAPII $\lambda$ ZAP Express	XL1-Blue ( <i>supE44 hsdR17 recA1</i> <i>endA1 gyrA96 thi-1 relA1</i> <i>lac F<sup>+</sup>[proAB<sup>+</sup> lacI<sup>q</sup></i> <i>lacZ</i> $\Delta$ M15Tn10( <i>tet<sup>r</sup></i> )]	XL1-Blue is defective for host-controlled restriction ( <i>hsdR<sup>-</sup></i> ) but carries an active methylation system ( <i>hsdM<sup>+</sup></i> ). Potential sites for restriction by the <i>EcoK</i> system become methylated during amplification so that, if necessary, the recombinants can be used to infect a restriction-competent strain of <i>E. coli</i> .
$\lambda$ ZipLox	Y1090(ZL) ( $\Delta$ <i>lacU169 proA<sup>+</sup></i> <i>hsdR hsdM<sup>+</sup></i>  <i><math>\Delta</math>lon araD139 strA supF</i> ( <i>trpC22::Tn10</i> ))	Strain Y1090(ZL): <ul style="list-style-type: none"> <li>• Is deficient in the <i>lon</i> protease; in <i>lon<sup>-</sup></i> cells, <math>\beta</math>-galactosidase fusion proteins often accumulate to much higher levels than in <i>lon<sup>+</sup></i> cells.</li> <li>• Is <i>supF</i>, suppressing the normally defective lysis of <math>\lambda</math>ZipLox and leading to a high frequency of lytic plaques.</li> <li>• Is defective for host-controlled restriction (<i>hsdR<sup>-</sup></i>) but carries an active methylation system (<i>hsdM<sup>+</sup></i>); potential sites for restriction by the <i>EcoK</i> system become methylated during amplification so that, if necessary, the recombinants can be used to infect a restriction-competent strain of <i>E. coli</i>.</li> <li>• Is a derivative of Y1090<i>hsdR</i> that has been cured of the resident plasmid pMC9; removal of pMC9 allows the use of ampicillin selection when cDNA-containing pSPORT1 plasmids are excised from <math>\lambda</math>ZipLox.</li> </ul>



# Protocol 2

---

## Construction and Screening of Eukaryotic Expression Libraries

Protocol 2, like Protocol 1, is a method for the construction and screening of a cDNA library in eukaryotic expression vectors and is divided into two stages as listed below.

- Stage 1: Construction of cDNA Libraries in Eukaryotic Expression Vectors
- Stage 2: Screening cDNA Libraries Constructed in Eukaryotic Expression Vectors

## STAGE 1: Construction of cDNA Libraries in Eukaryotic Expression Vectors

Expression cloning in eukaryotic cells is a brute-force method to isolate cDNA clones that encode functional proteins for which no amino acid sequences exist. Three broad options are available, depending on the general characteristics of the target protein (for reviews, please see Aruffo 1991; Frech and Joho 1992; Simonsen and Lodish 1994; Seed 1995).

- **For proteins such as mammalian receptors and channel and transporter proteins, whose expression on the plasma membrane can be detected by electrophysiological methods:** A cDNA library is prepared in a plasmid or bacteriophage  $\lambda$  vector equipped with promoters for bacteriophage-encoded DNA-dependent RNA polymerases. Pools of cDNA clones, chosen at random from the library, are transcribed in vitro, and the resulting mRNA is injected into *Xenopus* oocytes. The individual oocytes are then scored for expression of the functional protein. Pools of cDNAs that generate a positive signal are divided into subpools and retested until a single clone encoding the target protein is identified and isolated. This type of sib-selection has been used to isolate cDNAs encoding voltage-gated and ion-gated channels for sodium, potassium, calcium, and chloride ions; G-coupled receptors for peptide hormones; and transporters for urea, peptides, and antibiotics.
- **For cell-surface and secreted proteins:** A cDNA library is prepared in a bacteriophage  $\lambda$  or plasmid vector equipped with signals for expression in mammalian cells. These signals include a promoter/enhancer, splice donor and acceptor, and addition of poly(A). Pools of cDNA clones are then transfected into a line of cultured mammalian cells. In the case of secreted proteins, the supernatant medium from the cells is assayed for the appropriate biological activity. Transfected cells expressing a target surface protein are identified by binding of a specific ligand or antibody. Individual cDNAs encoding the target proteins may be identified by sib-selection, as described above. Alternatively, cells expressing the target protein at the cell surface may be isolated by panning, the use of radiolabeled ligands, or fluorescence-activated cell sorting. The plasmid DNA is then recovered from the selected population of transfected cells and amplified in *E. coli*, yielding a population of cDNA clones that is enriched for the target gene (Aruffo and Seed 1987; Seed and Aruffo 1987; Horst et al. 1991; please see below). This method has been used to identify cDNAs encoding a variety of glycotransferases (for review, please see Fukuda et al. 1996), as well as a large number of cytokines and their receptors (for review, please see Nakayama et al. 1992).
- **For intracellular proteins:** Pools of cDNA clones are transfected into cultured mammalian cells. Extracts of the transiently transfected cells are then screened for an activity characteristic of the target protein. For example, Tsai et al. (1989) used a gel-retardation assay to isolate a cDNA encoding a DNA-binding protein highly expressed in the erythroid lineage, and Andersson et al. (1989), screening intact transfected cells for steroid 5 $\alpha$ -reductase activity, were able to isolate a cDNA encoding the enzyme.

Because successful expression screening requires production of biological activity, the probability of isolating full-length cDNAs by expression screening is increased, whereas the risk of isolating truncated clones or related cDNAs is decreased.

## MAMMALIAN HOST/VECTOR SYSTEMS THAT AMPLIFY TRANSFECTED cDNA CLONES

---

To eliminate some of the considerable labor involved in traditional sib-selection schemes, many investigators in recent years have used host/vector systems in which transfected cDNA clones replicate as episomes in mammalian cells. cDNA libraries are constructed in plasmids that carry a wild-type origin of DNA replication derived from SV40, polyomavirus, or, more rarely, Epstein-Barr virus or bovine papillomavirus (Kern and Basilico 1986; Muller et al. 1994; Shen et al. 1995). Pools of cDNA clones are then transfected into lines of mammalian cells that express all of the *trans*-acting factors required to drive replication of the transfected cDNA clones. Cells that express the target protein may be identified, for example, by immunological staining (e.g., please see Horst et al. 1991) and, in some cases, isolated by "panning" on a Petri dish coated with an appropriate ligand or antibody (for reviews, please see Aruffo 1991; Nakayama et al. 1992; Seed 1995). The cells expressing the target protein are lysed, and the episomal DNAs are isolated (Hirt 1967) and reestablished in *E. coli*. Depending on (1) the efficiency of panning, (2) the amount of amplification of the transfected cDNA clones in the mammalian host, and (3) the frequency with which the target clone is represented in the cDNA library, the gene of interest may be isolated after three to four rounds of transient expression and selection.

By far the most popular host cells for this type of cloning are permanent lines of African green monkey kidney cells that express SV40 T antigen from chromosomally integrated copies of an origin-minus mutant of SV40 (Gluzman 1981). These lines are known as COS cells (CV-1, origin-minus, SV40). Because the integrated copies of the viral DNA lack viable origins of replication, they are unable to be activated by the endogenously expressed T antigen (please see the information panel on **COS CELLS**). The yield of episomal DNA therefore consists predominantly of amplified transfected plasmids. Expression of the cloned cDNA is generally driven by a strong promoter such as an immediate early cytomegalovirus (CMV) promoter (Aruffo and Seed 1987).

The SV40 origin of replication is maximally active only in cells of simian origin and is completely inactive in murine cells, even in the presence of T antigen. A number of other mammalian host-vector systems have been constructed in an effort to extend the host range of cells that can be used for expression cloning (please see Table 11-5). For example, cDNA libraries constructed in plasmid shuttle vectors carrying the origin of replication from polyomavirus can be screened by expression in murine cell lines that express polyomavirus T antigen. However, few of these systems match the efficiency of replication routinely achieved in COS cells using shuttle vectors carrying an SV40 origin of replication.

## VARIABLES THAT DETERMINE SUCCESS OR FAILURE OF EXPRESSION CLONING

---

Prominent among the many factors that determine the success or failure of expression cloning are the following:

- **The assay used to detect the target protein**, which must be robust, sensitive, and specific.
- **The abundance and length of the target mRNA**. The longer the mRNA and the lower its abundance, the smaller the chances of isolating clones capable of expressing an active protein.
- **The depth of the library**. Because most cDNAs isolated by expression cloning encode relatively rare proteins, it is usually necessary to generate a library consisting of  $10^6$  or more independent cDNA clones.

- **The efficiency with which the cloned cDNAs (or mRNAs transcribed from them) can be introduced into eukaryotic cells.** It is essential to optimize the efficiency of transfection of the host cells, using plasmids carrying reporter genes (e.g.,  $\beta$ -galactosidase or green fluorescent protein) before embarking on expression cloning.

There is little hope of success with expression cloning if the cDNA library is not of the highest quality. The starting mRNA must be intact, the populations of first-strand cDNAs and mRNAs should match each other for size, the yields of the first- and second-strand cDNAs must be acceptable, cDNA of the required size should be recovered in sufficient quantity, and all steps in the ligation and transformation/packaging reactions must be accomplished with high efficiency. Unless success at each phase of library construction can be documented, it is best to abandon the preparation and start over again with fresh mRNA. Less work is involved in repeating the synthesis and cloning of cDNA than in screening inadequate expression libraries with a wish and a prayer.

## CONTROLS

---

When constructing an expression cDNA library, it is essential to have internal controls that can provide evidence that the overall process — from synthesis of first-strand cDNA to the final step of identifying individual cDNA clones of interest — has worked with acceptable efficiency. The best internal control is a synthetic, polyadenylated mRNA encoding a protein with a biological activity that can be readily assayed. If possible, the control mRNA and the target mRNA should be similar in size and should encode proteins with similar but distinct characteristics. An mRNA encoding a cytoplasmic protein, for example, is not an appropriate control for an experiment whose aim is to isolate a cDNA encoding a cell surface protein. The control mRNA is seeded at an appropriate density into the mRNA preparation used to construct the cDNA expression library. The library may then be screened for the ability to express two biological activities: one encoded by the control mRNA and the other encoded by the desired target mRNA. Success in recovering appropriate numbers of cDNA clones expressing the control protein provides comforting reassurance that all has gone well in every phase of the experiment.

A less than perfect but adequate internal control is an already-cloned cDNA encoding a distinctive, biologically active protein. The cDNA can then be excised from its vector and seeded into the preparation of second-strand cDNA used to construct the library. A control of this type provides assurance that construction and screening of the expression library have gone according to plan.

Some investigators prefer to use as an internal control a cDNA that has already been cloned into an expression vector. This vector should have the same features as the expression vector used to construct the cDNA library, but it need not be identical in all respects. For example, the cDNA used as a positive control may be cloned into an expression plasmid that carries a kanamycin resistance gene, rather than an ampicillin resistance gene. Using a different antibiotic resistance gene provides an unambiguous method to distinguish between cDNA clones derived from the library and the cDNA used as a control.

In the screening phase of the experiment, it is essential to include a negative control, for example, an empty copy of the expression vector, which should be included in all experiments involving transfection of cultured mammalian cells. When using *Xenopus* oocytes as a vehicle to screen the expression library, the best negative controls are (1) an aliquot of the *in vitro* transcription reaction from which template DNA has been omitted and (2) an aliquot of an *in vitro* transcription reaction that contains empty plasmid DNA as template.

## MATERIALS

---

### Buffers and Solutions

Please see Appendix 1 for components of stock solutions, buffers, and reagents. Dilute stock solutions to the appropriate concentrations.

10x Restriction endonuclease buffer(s)

### Enzymes and Buffers

Restriction enzymes

Please see Step 3.

### Nucleic Acids and Oligonucleotides

*Poly(A)<sup>+</sup>-enriched mRNA*

This mRNA should be isolated from a cell line or tissue that expresses the activity of interest and purified by two-pass chromatography on oligo(dT) cellulose (please see Chapter 7, Protocol 3). Identification of the highest expressing tissue or cell line must be accomplished empirically using the biological assay that will be employed in the expression cloning screen.

Knowledge of the size of the target mRNA is very useful in expression cloning. This variable can sometimes be determined by translation of size-fractionated mRNA followed by biological assay of the translation products, by injecting size-fractionated mRNAs into oocytes and then assaying the eggs for the target protein, or possibly by transfecting size-fractionated mRNAs into cultured mammalian cells (please see Chapter 16).

### Special Equipment

*cDNA synthesis kit*

These kits are available from several manufacturers and generally include all of the reagents required to synthesize a population of cDNAs ready for ligation into a bacteriophage or plasmid expression vector (please see the information panel on **COMMERCIAL KITS FOR cDNA SYNTHESIS AND LIBRARY CONSTRUCTION**).

Choose a kit that allows the construction of an oriented cDNA library, i.e., one in which the synthesized cDNAs have different restriction enzyme sites at their 5' and 3' ends. For example, by using the appropriate adaptor-linker combination, cDNAs can be synthesized with a *SalI* site at the 5' end and a *NotI* site at the 3' end. Ligation of the cDNAs into a *SalI/NotI*-cleaved vector in which the *SalI* site is located closest to the promoter and the *NotI* site is located closest to the transcriptional terminator sequence of the vector will produce an oriented cDNA library. By constructing and screening an oriented cDNA library, the absolute number of clones that must be screened is reduced by a factor of 2, and problems with antisense inhibition of expression of the target protein activity are eliminated.

A possible disadvantage of this type of kit is that the positioning of a *NotI* site at the 3' end of the cDNA is usually accomplished by use of an oligo(dT) primer to which a *NotI* sequence has been attached (e.g., 5'-pCCGCGGCCGCT<sub>15</sub>-3'). Synthesis of cDNA by reverse transcriptase with this type of primer begins at the poly(A) tail of most mRNAs and proceeds toward the 5' end of the mRNA template. If the target mRNA is long, the chance of obtaining a full-length cDNA and hence a positive signal in the injected or transfected cells is reduced. Options to overcoming this potential problem include (1) the use of random hexanucleotide-*NotI* primers in the reverse transcriptase reaction (e.g., 5'-pCCGCGGCCGCGNNNNN-3'), which can lead to biased priming due to the GC-rich nature of the primer or (2) the construction of size-fractionated libraries containing a preponderance of long cDNAs.

In some instances, an antisense approach to screening is taken by design (e.g., please see Lübbert et al. 1987). In this situation, orient the 3' end of the cDNA next to the promoter and the 5' end of the cDNA next to the transcription terminator.

TABLE 11-5 Vector Systems for Expression Cloning

VECTOR	SOURCE	PROMOTER(S)	EXPRESSION IN	
			XENOPUS OOCYTES	CULTURED MAMMALIAN CELLS
pcDNA 3.1	Invitrogen	CMV, T7		√
pcDNA 4	Invitrogen	CMV with enhancer QBI SP163		√
pSPORT plasmid vectors	Life Technologies	<i>lac</i> , SP6, T7	√	
pCMV-Script plasmid vector	Stratagene	CMV	√	√
λZipLox	Life Technologies	<i>lac</i> , SP6, T7	√	
λZAP-CMV	Stratagene	CMV, T3, T7		√
λZAP Express	Stratagene	<i>lacZ</i> , T3, T7, CMV	√	√
λExCell	Amersham Pharmacia	SP6, T7	√	

## Additional Reagents

Step 1 of this protocol requires the reagents listed in Protocol 1, Stages 1–4.

Step 2 of this protocol requires the reagents listed in Protocol 1, Stage 5.

Steps 4 and 5 of this protocol require the reagents listed in Protocol 1, Stage 6.

Step 8 of this protocol may require the reagents listed in Chapter 1, Protocol 26.

## Vectors and Bacterial Strains

### Electrocompetent *E. coli* cells

If a plasmid expression vector is chosen, prepare (please see Chapter 1, Protocol 26) or purchase electrocompetent *E. coli* as hosts for the cDNA library. The titer of the electrocompetent cells should be at least  $5 \times 10^8$  colonies/ $\mu$ g plasmid DNA. Ideally, use a single lot or preparation of cells throughout the expression cloning and screening procedure.

### Packaging extracts

If a bacteriophage  $\lambda$  vector is chosen, then purchase (or prepare) a very high titer packaging extract with which to insert the recombinant cDNAs into the virus (please see the information panel on **IN VITRO PACKAGING**). The titer of the extract should be at least  $10^9$  pfu/ $\mu$ g viral DNA.

### Plasmid or bacteriophage $\lambda$ expression vector

The choice of vector is dictated by the host system used for expression. If *Xenopus* oocytes are used, the expression vector should be a bacteriophage  $\lambda$  DNA or a plasmid vector DNA carrying promoters for the bacteriophage SP6, T3, or T7 DNA-dependent RNA polymerases flanking the polylinker (e.g.,  $\lambda$ ZAP Express,  $\lambda$ ExCell, and pSPORT). If cultured mammalian cells are used, then choose a plasmid-based expression vector that contains a powerful promoter (e.g., the immediate early region promoter of human cytomegalovirus) and a strong transcription terminator sequence (e.g., the 3' sequences of the human growth hormone gene or the SV40 late terminator region). Examples include the pCMV series of plasmids and pcDNA 4 (please see Table 11-5 and Appendix 3).

## METHOD

1. Use a commercial kit or follow the instructions in Protocol 1 (Stages 1–4) to synthesize blunt-ended, double-stranded cDNA and equip the termini with the appropriate linkers or adaptors.

2. Fractionate the double-stranded cDNA according to size, using gel-filtration chromatography. For details, please see Protocol 1, Stage 5.

If the size of the target mRNA is known, pool the column fractions that contain double-stranded cDNAs ranging in size from 1 kb smaller than the target mRNA to 1 kb larger than the target mRNA. If the size of the target mRNA is unknown, fractionate the preparation of double-stranded cDNA into three pools containing molecules of different sizes: 500–1500 bp, 1500–3000 bp, and >3000 bp.

3. Digest 10–25 µg of the plasmid or bacteriophage λ expression vector with two restriction enzymes whose recognition sequences occur in the linker-adaptors placed at the 5' and 3' ends of the cDNA.

▲ **IMPORTANT** Take care to ensure that both restriction enzymes digest the vector DNA to completion. Carry out the digestions in sequence rather than simultaneously; purify the DNA by extraction with phenol:chloroform and precipitation with ethanol between digests, and where possible, use gel electrophoresis to check that both of the digests have gone to completion.

To ensure complete cleavage of the expression vector before the cloning of cDNA, some investigators insert a short “stuffer” fragment of 200–300 bp between the *Sall* and *NotI* (or other enzyme combination) sites of the polylinker. The presence of a stuffer fragment allows the efficiency of digestion to be monitored more readily and, in some cases, enhances double digestion of the vector since the two restriction sites are usually located close to each other in the polylinker sequence, and separating them by 200–300 bp removes end inhibition.

4. Set up trial ligations using different ratios of cDNA to bacteriophage λ arms or plasmid DNA. For details on optimizing ligations, please see the introduction to Stage 6 (as well as Step 1 of Stage 6) of Protocol 1 of this chapter.

If the cDNA has been separated into fractions of different sizes (please see the note to Step 2), aliquots of each fraction must be assayed separately.

5. Package an aliquot of the products of each of the ligation reactions into bacteriophage λ particles. Determine the titer of infectious particles generated in each packaging reaction. For details, please see both the panel on **PLATING BACTERIOPHAGE λ ON *E. COLI* STRAINS** and Steps 2–6 in Protocol 1, Stage 6.

or

Use electroporation to transform *E. coli* with aliquots of each ligation reaction (please see Chapter 1, Protocol 26).

6. Test six bacteriophage λ or plasmid recombinants for the presence of cDNA inserts of the appropriate size and determine the ratio of cDNA to vector DNA that generates the largest number of recombinant clones. Calculate the size of the library that can be generated from the ligation reactions containing the optimum ratio of cDNA to vector.
7. Using the optimum ratio of cDNA insert to vector, ligate as much of the cDNA as possible to the bacteriophage λ or plasmid DNA.

It is usually better to set up many small ligation reactions, rather than one large reaction.

8. Prepare and analyze the recombinants using one of the methods below:

*If a bacteriophage λ vector is used:* Package the ligated cDNA into bacteriophage λ particles following the directions provided by the manufacturer of the packaging extract, measure the titer of the virus stock, and store the stock at 4°C.

*If a plasmid vector is used:* Measure the number of potential recombinants in the ligation reaction by electroporating small aliquots of the ligation mixture into *E. coli* cells (please see Chapter 1, Protocol 26).

9. Proceed as soon as is feasible to the screening of the eukaryotic expression library.

## STAGE 2: Screening cDNA Libraries Constructed in Eukaryotic Expression Vectors

To minimize the amount of work involved in screening expression libraries, the cDNA library is divided into a series of screening pools that contain the maximum number of cDNA clones compatible with efficient detection of the target biological activity. The complexity of the pools therefore depends almost exclusively on the sensitivity of the screening assay used to detect the target activity. For ion channel and other proteins whose activity can be detected by sensitive patch-clamping or electrophysiological assays, complex pools containing up to 300,000 cDNA clones have been used (e.g., please see Masu et al. 1987). For a steroid-metabolizing enzyme in which the assay involved adding [ $^{14}\text{C}$ ]testosterone to the medium of cultured cells, followed by a thin-layer chromatography separation of substrate and product, pools of 10,000 clones were successfully screened (Andersson et al. 1989, 1991). A protein that transports mevalonate was isolated after screening pools of 1000 cDNAs (Kim et al. 1992), whereas the isolation of one of the endothelin receptors was accomplished by screening pools of 500 cDNAs (Sakurai et al. 1990). Clearly, the larger the pool size, the greater the capacity to screen large numbers of clones from the library.

In general, the sensitivity required to detect a single target cDNA in a screening increases as a linear function of the size of the pool. If there is reason to believe that the biological assay is insensitive, a large number of screening pools should be constructed, each containing no more than 1000 or 2000 clones. Whatever the number of clones in the screening pool, the aim should be to screen at least three times more recombinants than the number of individual cDNA clones in the expression library. For example, an expression library of  $10^6$  individual clones can be divided into  $\sim 30$  screening pools, each containing 100,000 clones, or into 1000 screening pools each containing 3000 clones, or into any intermediate number of pools of proportional size. Always include a positive and negative control in each screening experiment.

### MATERIALS

---

#### Buffers and Solutions

Please see Appendix 1 for components of stock solutions, buffers, and reagents. Dilute stock solutions to the appropriate concentrations.

*SM*

#### Enzymes and Buffers

*Restriction endonucleases*

Restriction endonucleases will be required for certain procedures. Please see Steps 1 and 3.

#### Nucleic Acids and Oligonucleotides

*cDNA library, prepared as described in Stage 1 of this protocol*

*Transfection/Injection controls*

A cDNA that can be used as a positive control is a priceless commodity when setting up expression cloning. Whenever possible, choose a cDNA that encodes a biological activity similar to that of the



desired target cDNA. For example, if a novel potassium channel is the target cDNA, use a cDNA encoding a previously isolated K<sup>+</sup> channel as a positive control. The control cDNA is used to establish the optimum pool size and to check that a given transfection/injection experiment worked. The positive control cDNA should be transferred into the appropriate strain of *E. coli* (if using a plasmid expression vector) or packaged into bacteriophage  $\lambda$  before carrying out Step 1.

Two types of negative controls should be included in screening experiments using *Xenopus* oocytes: The plasmid vector alone and the transcription reaction without added template DNA.

In addition, Step 1 requires either an empty bacteriophage  $\lambda$  expression vector packaged into bacteriophage  $\lambda$  particles or *E. coli* transformed with the empty plasmid expression vector.

## Media

*Terrific agar plates containing the appropriate antibiotic*

*Terrific broth (or other rich medium) containing the appropriate antibiotic*

## Additional Reagents

*Steps 1 and 2 of this protocol may require a commercial plasmid purification kit (see Chapter 1, Protocol 9).*

*Steps 1 and 3 of this protocol may require the reagents from one of the transfection protocols in Chapter 16.*

*Steps 1 and 3 of this protocol may require the reagents listed in Chapter 9, Protocol 6.*

*Steps 1 and 3 of this protocol may require the reagents necessary to inject mRNA molecules into *Xenopus* oocytes, as described by Spector et al. (1998a).*

*Step 1 of this protocol may require the reagents listed in Chapter 2, Protocol 1 or 5 and Protocol 23 or 24.*

*Step 1 of this protocol requires the reagents necessary to assay for the biological activity encoded by the positive control cDNA.*

*Step 2 of this protocol may require the reagents listed in Chapter 1, Protocol 26, and Chapter 2, Protocol 1 and Protocol 23 or 24.*

*Step 4 of this protocol requires the reagents necessary to assay for the biological activity encoded by the target cDNA.*

*Step 6 of this protocol requires the reagents listed in Chapters 7, 12, 15, and 16.*

## Cells and Tissues

### *Host cells*

*Xenopus* oocytes are taken from female South African clawed frogs, which are available from several biological supply houses (such as Carolina Biological Supply or Kons Scientific). The ability of oocyte clutches to express injected mRNAs varies seasonally and is affected by the age and physiological state of the donor animals. Difficulties in expressing mRNAs can sometimes be overcome by switching suppliers. For methods to isolate oocytes, please see Colman (1984), Spector et al. (1998a), and Julius et al. (1988).

Simian COS cells or derivatives of the 293 line of human embryonic kidney cells are the mammalian hosts of choice for transient expression of cloned cDNAs because of their superior efficiencies of transfection (Gluzman 1981; Gorman 1990). However, many other cell lines have been used successfully (e.g., Chinese hamster ovary and NIH-3T3) (Naglich et al. 1992; Bates et al. 1993; Young et al. 1993).

Before embarking on expression cloning, test lysates of mock-injected oocytes or lysates of mock-transfected cells for the activity of target protein. It is essential to start with an expression host that has low to undetectable levels of the activity to be cloned.

**METHOD**

---

1. Set up a series of trial experiments to optimize the transfection and expression systems used to screen the library for cDNA clones of interest. This is best done by using a previously cloned cDNA encoding a biological activity for which reliable assays are available.

**IF A EUKARYOTIC PLASMID EXPRESSION VECTOR AND CULTURED CELL HOST ARE USED**

- a. Inoculate a single colony of *E. coli* harboring a plasmid carrying the cDNA used as a positive control into 10 ml of rich medium (e.g., Terrific Broth containing a selective antibiotic) together with 10, 100, 1000, 10,000, or 100,000 colonies derived from electroporation of *E. coli* with an empty vector. Grow the cells to saturation in an overnight culture incubated with agitation at 37°C.
- b. Use a commercial kit to prepare plasmid DNA of a purity sufficient for efficient transfection of cultured mammalian cells (please see Table 1-6 in Chapter 1, Protocol 9).
- c. Use one or more of the methods described in Chapter 16 to transfect the various plasmid preparations into cultures of eukaryotic cells and assay for the biological activity encoded by the positive control cDNA.

When screening the cDNA library, use the transfection method that generates the maximum signal and an acceptably low level of background.

**IF A BACTERIOPHAGE RNA POLYMERASE (E.G., T3, T7, OR SP6) IS USED TO TRANSCRIBE CDNAS FROM A PLASMID EXPRESSION VECTOR FOLLOWED BY XENOPUS OOCYTE INJECTION**

- a. Follow Steps a and b above.
- b. Linearize the pooled, purified plasmid DNAs at the rare restriction site placed at the 3' end of the cDNAs during library construction, and transcribe the templates in vitro into mRNA (please see Chapter 9, Protocol 6).
- c. Inject the mRNA prepared from the pooled cDNAs into *Xenopus* oocytes and assay the appropriate biological activity or transfect the mRNA into the appropriate cell line.

**IF A BACTERIOPHAGE  $\lambda$  VECTOR CONTAINING BACTERIOPHAGE-ENCODED RNA POLYMERASE PROMOTERS WAS CHOSEN AS AN EXPRESSION VECTOR**

- a. Generate a set of bacteriophage suspensions containing different ratios (10:1, 100:1, 1000:1, etc.) of an empty bacteriophage  $\lambda$  vector to a recombinant bacteriophage  $\lambda$  harboring the control cDNA. Infect an appropriate strain of *E. coli* with a multiplicity of bacteriophage particles that yields near-confluent lysis of bacterial lawns or complete lysis of infected cells grown in liquid culture (please see Chapter 2, Protocol 1 or 5).
- b. Prepare bacteriophage  $\lambda$  DNA from the plates (please see Chapter 2, Protocol 23) or from the liquid cultures (please see Chapter 2, Protocol 24).
- c. Linearize the bacteriophage  $\lambda$  DNA at the rare restriction site placed at the 3' end of the cDNAs during library construction, and transcribe the cDNAs into mRNA as described in Chapter 9, Protocol 6.
- d. Inject the prepared mRNA into *Xenopus* oocytes, and assay the mRNAs for their ability to encode the biological activity of the cDNA used as a positive control.

2. Using the results obtained in Step 1 as a rough guide, divide the cDNA library into pools of a suitable size for screening, and transform or transfect *E. coli* with the expression library pools. Prepare plasmid or bacteriophage  $\lambda$  DNA that will be used to screen the pools for the presence of the target cDNA.

**IF THE EXPRESSION LIBRARY IS CONSTRUCTED IN A PLASMID VECTOR AND POOLS ARE GROWN ON SOLID MEDIUM**

- a. Withdraw a sufficient number of aliquots (e.g., 50–100 aliquots, each capable of generating ~1000 recombinants) from the ligation mixture (Stage 1, Step 8), and introduce each aliquot individually into *E. coli* by electroporation. Plate the entire contents of each electroporation cuvette onto a single dish of Terrific agar medium containing the appropriate antibiotic. Incubate the plates overnight at 37°C.

The goal is for the number of colonies on each plate to equal the desired pool size. For example, if the pool size to be screened is 50,000 colonies, then enough ligation mix should be electroporated to produce 1000 colonies on each of the 50 plates. Culture may be grown before plating as described in Step b for growth in liquid medium.

- b. Estimate the number of colonies on each plate. Scrape the colonies from each plate into 5 ml of rich medium (e.g., Terrific broth containing a selectable antibiotic). Grow the bacterial suspensions to saturation, and then prepare purified plasmid DNA for screening.

**IF THE EXPRESSION LIBRARY IS CONSTRUCTED IN A PLASMID VECTOR AND POOLS ARE GROWN IN LIQUID MEDIUM**

The advantages of this procedure are that the plating step is omitted, thus saving time and effort, and there is less chance that any individual cDNA will be lost because of poor growth on agar, or because of mechanical damage.

- a. Withdraw a sufficient number of aliquots (e.g., 50–100 aliquots, each capable of generating ~1000 recombinants) from the ligation mixture (Stage 1, Step 8), and introduce them individually into separate cultures of *E. coli* by electroporation. The number of transformants should equal the desired pool size in each culture.
- b. Add 1 ml of rich medium (e.g., SOC or Terrific broth) without antibiotics to each bacterial culture immediately after electroporation. Incubate the culture for 1 hour at 37°C with very gentle agitation.

The short period of incubation allows the plasmid-encoded antibiotic resistance gene to be expressed to a level that will protect the transformed bacteria.

- c. Use an aliquot of each bacterial culture to inoculate separate 5-ml cultures. After growing the bacterial cultures to saturation, prepare purified plasmid DNA for screening.

**IF THE EXPRESSION LIBRARY IS CONSTRUCTED IN A BACTERIOPHAGE  $\lambda$  VECTOR AND POOLS ARE TO CONTAIN 10,000 TO 100,000 CDNAS**

- a. Plate an appropriate volume of packaging mixture to produce a semiconfluent lawn of recombinant bacteriophage plaques. Alternatively, use a sufficient amount of packaging mixture to obtain complete lysis of *E. coli* cells grown in liquid culture.
- b. Isolate bacteriophage  $\lambda$  DNA by a plate lysis procedure or a liquid culture procedure (please see Chapter 2, Protocol 23 or 24).

**IF THE EXPRESSION LIBRARY IS CONSTRUCTED IN A BACTERIOPHAGE  $\lambda$  VECTOR AND POOLS ARE TO CONTAIN 10,000 OR FEWER CDNAS**

- a. Plate recombinant bacteriophages, equal in number to the pool size, at a density of 1000 pfu per 100-mm dish.
  - b. When plaque formation is complete, overlay each dish with 2–3 ml of SM to produce a low-titer plate lysate. Calculate the titer of the lysate.
  - c. From the low-titer plate lysate, produce a high-titer stock in liquid culture.
  - d. Purify bacteriophage  $\lambda$  DNA by a liquid culture procedure (please see Chapter 2, Protocol 24).
3. Transfer the purified clone into the appropriate background to analyze for expression:

*If the clone is purified plasmid DNA:* Either transfect into cultured mammalian cells or use as a template for *in vitro* synthesis of RNA by a bacteriophage-encoded RNA polymerase, followed by injection into *Xenopus* oocytes.

*If the clone is purified bacteriophage  $\lambda$  DNA:* Linearize the DNA and use as a template for *in vitro* synthesis of RNA, followed by injection into *Xenopus* oocytes.

A typical transfection experiment using 50–100 dishes of cultured mammalian cells permits 50,000–100,000 cDNA clones (from pools containing 1000 clones each) to be screened for their ability to express the desired biological activity. A typical *Xenopus* experiment involves injection of mRNAs transcribed from each pool of plasmid DNA into five *Xenopus* oocytes. For pools containing 1000 clones each, 250–500 oocytes are therefore required to screen 50,000–100,000 cDNAs for biological activity.

4. Assay for the biological activity encoded by the target cDNA.
5. After a positive pool(s) of cDNAs has been identified, subdivide and rescreen it in an iterative fashion until a single cDNA encoding the target activity has been identified. Carry out this goal, which is most easily accomplished using the preparation of purified plasmid or bacteriophage  $\lambda$  DNA corresponding to the positive pool(s) of recombinants, as follows:
  - a. Divide the positive (primary) pool of plasmid or bacteriophage  $\lambda$  DNA into aliquots that generate approximately one tenth of the original number of transformed colonies or plaques.
 

A primary pool containing a total of 10,000 individual recombinant DNAs should be divided into ~30 aliquots, each of which generates ~1000 colonies or plaques.
  - b. Repeat Steps 3 and 4 above. Include the original positive pool as a positive control in the rescreening assay.
  - c. Repeat the process of subdivision until a single recombinant is obtained that encodes the desired activity. Make sure that only single well-isolated plaques or bacterial colonies are used to prepare bacteriophage or plasmid DNA for the ultimate screen.
6. Characterize the single isolate that encodes the target activity by DNA sequencing (Chapter 12), expression (Chapter 15 or Chapter 16), and RNA blotting (Chapter 7).

If the recombinant does not encompass the entire coding region of the cDNA, additional recombinants should be isolated by screening the cDNA library by hybridization at high stringency, using cDNA isolated from the first isolate as a probe.

# Protocol 3

---

## Exon Trapping and Amplification

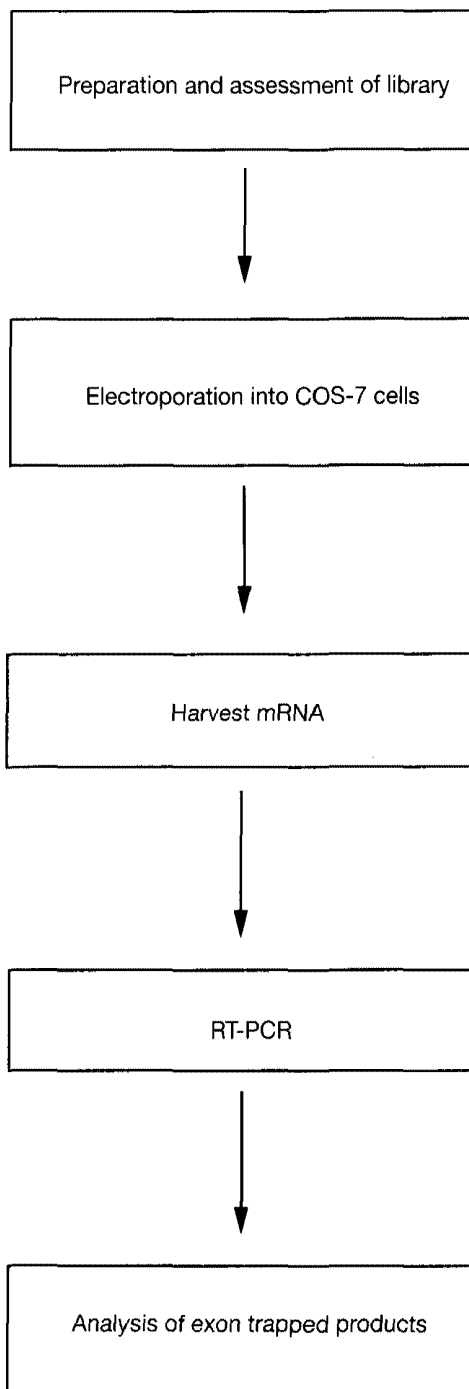
Deanna M. Church

National Institutes of Health, Bethesda, Maryland

**E**XON AMPLIFICATION SELECTS FOR THE PRESENCE OF FUNCTIONAL splice donor and acceptor sites within a fragment of genomic DNA. This process has been used successfully with genomic DNA from a variety of sources, including cosmids, bacterial artificial chromosomes, yeast artificial chromosomes, and total genomic DNA (North et al. 1993; Church et al. 1994). An unforeseen difficulty with the original vector (pSPL1) used for exon amplification is the production of an unacceptable level of a particular mRNA artifact that occurs due to the presence of a cryptic splice site within the intron of the vector. Three additional problems arise as a result of the use of pSPL1 and the current experimental design. First, the majority of genomic fragments cloned into the vector do not contain an exon; thus, the major splice product will be an empty vector. Second, restriction enzymes used for library production can interrupt the sequence of an exon, thus preventing or interfering with splicing. Third, transcription units consisting of less than three exons will not be identified in this scheme. The use of an improved vector, pSPL3, ameliorates or eliminates the first three of these problems. However, transcription units consisting of less than three exons must still be identified using alternative methods (Church et al. 1993; Church and Buckler 1999). The inclusion of *Bst*XI sites within the multiple cloning site of the vector (Figure 11-16) allows for the elimination of most of the cryptic splice products. The presence of a multiple cloning site expands the choices of different enzymes that may be used for library design, thus reducing the likelihood of cutting within an exon. Finally, to eliminate the vector-only splice product, *Bst*XI half-sites now flank the vector splice sites. Vector-only splicing will reconstitute this restriction site, and subsequent digestion with *Bst*XI will virtually eliminate this product (Figure 11-16). However, because the protocol involves PCR amplification of spliced gene products, any molecules that result from aberrant splicing will be amplified and contribute to the background.

This protocol presents a method to amplify exons, using the mammalian shuttle vector pSPL3, and is divided into five stages as listed below (please see Figure 11-15).

- Stage 1: Construction of the Library
- Stage 2: Electroporation of the Library into COS-7 Cells
- Stage 3: Harvesting the mRNA
- Stage 4: Reverse Transcriptase-PCR
- Stage 5: Analysis of Clones



**FIGURE 11-15** Flowchart of the Experimental Steps in Exon Amplification

(Adapted, with permission, from D.M. Church.)

## STAGE 1: Construction of the Library

An important aspect of exon amplification is the construction of a highly representative library of genomic DNA. In this protocol, the library is constructed in the vector pSPL3 (Figure 11-16), which contains features that improve the efficiency of library construction and exon trapping. For additional details on these features, please see the discussion on Amplification and Trapping of Exons in the introduction to this chapter. Great care should be taken in preparing the DNA, because any contaminating material from the host used to propagate recombinants can contribute to the background. Although splicing is unknown in bacteria, and is a rare event in yeast, both types of genomes contain sequences capable of undergoing splicing in this heterologous system (D.M. Church and A. Buckler, unpubl.).

### MATERIALS

---

**CAUTION:** Please see Appendix 12 for appropriate handling of materials marked with <!>.

#### Buffers and Solutions

Please see Appendix 1 for components of stock solutions, buffers, and reagents. Dilute stock solutions to the appropriate concentrations.

ATP (10 mM)

Phenol:chloroform (1:1, v/v) <!>

TE (pH 8.0)

#### Enzymes and Buffers

PvuII

Restriction endonucleases

For a map of the pSPL3 multiple cloning site, please see Figure 11-16.

T4 DNA ligase

#### Gels

Agarose gel (0.9% w/v) in TAE buffer

Please see Step 3.

Agarose gel, preparative

Please see Step 1.

#### Nucleic Acids and Oligonucleotides

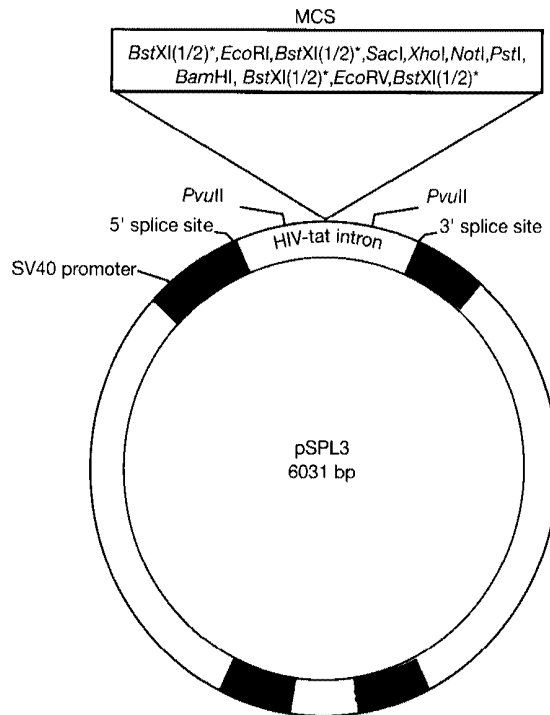
Cosmid, BAC, or PAC recombinant DNA, encompassing the target genomic region

Purify the recombinant to be analyzed as described in Chapter 4.

or

Genomic DNA

Prepare the DNA as described in one of the methods presented in Chapter 6.



**FIGURE 11-16 pSPL3**

The SV40 promoter drives the transcription of a heterologous minigene. Two exons are interrupted by an intron derived from the HIV *tat* gene. A multiple cloning site (MCS) has been inserted into the intron. The vector carries the SV40 promoter and the origins of replication from pUC (pUC ori) and from SV40 (SV40 ori). An enlarged view of the MCS reveals possible cloning sites for library construction. The presence of half sites of *BstXI* (*BstXI* [1/2]) decreases the background from cloned sequences that do not contain exons. An expanded view of the minigene within pSPL3 is shown in Figure 11-18. (Adapted, with permission, from D.M. Church.)

## Media

*LB agar plates containing 50 µg/ml ampicillin*

Please see Step 8 to determine the appropriate size plates to use.

*LB broth containing 50 µg/ml ampicillin*

*SOC medium*

## Special Equipment

*Water baths preset to 15°C and 65°C*

## Additional Reagents

*Step 1 of this protocol requires the reagents listed in Chapter 1, Protocol 20.*

*Step 6 of this protocol requires the reagents required for transformation listed in Chapter 1, Protocol 23, 24, or 25.*

*Steps 10 and 12 of this protocol require the reagents listed in Chapter 1, Protocol 1 or 9.*

## Vectors and Bacterial Strains

*E. coli strain HB101, competent for transformation*

Prepare as described in Chapter 1, Protocols 23, 24, or 25.

*pSPL3*

The vector pSPL3 is available separately or as part of a kit from Life Technologies.



## METHOD

1. Digest pSPL3 with a restriction enzyme(s) that will permit insertion of the genomic DNA (for the map of the pSPL3 multiple cloning site, please see Figure 11-16). Dephosphorylate the ends of the linearized vector, and purify the vector by gel electrophoresis.

It is important that the vector DNA be completely digested into a single fragment of ~6 kb.

2. Digest 1–2 µg of genomic DNA or recombinant vector carrying genomic target DNA with a restriction enzyme(s) that is compatible with the enzyme used to prepare pSPL3 in Step 1.

3. Analyze 10% of the digested genomic DNA on a 0.9% agarose gel cast and run in TAE.

The genomic DNA should be completely digested and undegraded. When examining the genomic DNA in the agarose gel, also look for the presence of contaminating bacterial (or yeast) DNA, which will appear as a generalized haze in the background.

4. Inactivate the restriction enzyme from the digested genomic DNA by heating the reaction mixture to 65°C for 15 minutes. Extract the reaction mixture with phenol:chloroform and recover the DNA by standard ethanol precipitation. Resuspend the DNA at a concentration of 100 µg/ml in TE (pH 8.0).

5. Ligate the genomic DNA to the vector by combining the following:

digested genomic DNA	150 ng
digested, dephosphorylated pSPL3 vector	50 ng
10x ligation buffer	1 µl
bacteriophage T4 DNA ligase	10 Weiss units
H <sub>2</sub> O	to 10 µl

Incubate the reaction mixture for 2–3 hours at room temperature or overnight at 15°C.

Adding ATP as a component of the 10x ligation buffer leaves more volume for vector or foreign DNA in the reaction mixture. If using a commercial ligation buffer that contains ATP, the addition of ATP is no longer required.

Be sure to include a control containing only the vector DNA. This control is important for assessing the quality of the library.

6. Transform 40 µl of competent HB101 cells with the ligation reaction.

Be sure to include positive (vector alone DNA) and negative (no DNA) transformation controls to assess efficiency.

▲ **IMPORTANT** It is imperative that HB101 be used to propagate the library and the vector, because pSPL3 is unstable in other bacterial strains (Church and Buckler 1999).

7. After transformation, add 800 µl of SOC medium to the cells and incubate the culture for 30–45 minutes at 37°C to allow expression of the antibiotic resistance marker encoded on the plasmid.

8. Amplify the library by growing the bacteria overnight at 37°C in the presence of ampicillin.

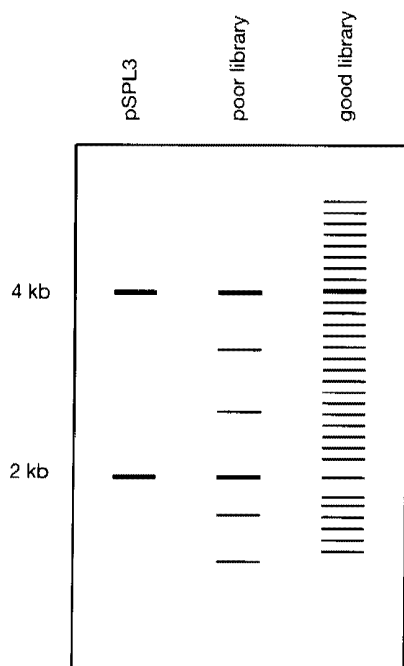
*If using a single cosmid:* Plate 100 µl of the transformation mixture onto an LB agar plate containing 50 µg/ml ampicillin. Grow the remainder of the transformation in a 2-ml liquid culture of LB broth containing 50 µg/ml ampicillin.

Growth on the small LB plate allows the transformation efficiency to be assessed.

*If using a BAC, PAC, or pools of cosmids:* Plate the entire contents of the transformation onto separate 150-mm LB agar plates containing 50 µg/ml ampicillin.

Plating these complex libraries on 150-mm plates helps eliminate the preferential growth of certain clones by reducing competition for nutrients, thus allowing for the construction of a more representative library.

9. Estimate the efficiency of ligation by comparing the number of recombinant and nonrecombinant clones (i.e., colonies arising from the transformation of HB101 with the ligation mixture containing only pSPL3).  
The recombinant clones should be anywhere from 500-fold to 1000-fold in excess of the nonrecombinant clones.
10. If the library was amplified on a 150-mm LB agar plate, proceed to Step 11. If the genomic library was amplified in liquid culture, purify plasmid DNA from the bacteria using a standard alkaline lysis procedure (please see Chapter 1, Protocol 1) or use a commercial plasmid purification kit. Proceed to Step 13.
11. If the entire library was plated onto a large LB agar plate, flood the plate with 10 ml of LB broth, and gently scrape the colonies from the surface of the agar. Minimize the amount of agar that is scraped into the LB broth.
12. Purify the plasmid DNA using a modification of the standard alkaline lysis miniprep: triple the amounts of Alkaline lysis solutions I (300  $\mu$ l), II (600  $\mu$ l), and III (450  $\mu$ l) added to the bacterial pellet. To simplify the procedure, after addition of Alkaline lysis solution I, transfer the bacterial slush to a 2-ml microfuge tube. The rest of the procedure can be carried out in 2-ml tubes. After adding Alkaline lysis solution III and centrifuging, divide the recovered, crude nucleic acid supernatant into two 1.5-ml tubes. Extract the resulting supernatant with phenol:chloroform and with chloroform. Precipitate the supernatant with isopropanol and combine the two dissolved DNA pellets. Alternatively, use a commercial plasmid purification kit (Chapter 1, Protocol 9).
13. Digest an aliquot of the purified DNA with *Pvu*II to determine the quality of the library.  
*Pvu*II sites flank the multiple cloning site in the vector. The digestion of empty vector with *Pvu*II produces 4-kb and 2-kb bands. Recombinant clones should still produce a prominent 4-kb band, but little or no 2-kb band. A clearly visible 2-kb band suggests that the library is of poor quality or, less probably, that a 2-kb *Pvu*II fragment is highly represented in the genomic DNA (Figure 11-17). If the library is of acceptable quality, it can be used for the next stage.



**FIGURE 11-17 Representation of a Gel Demonstrating Good Library Construction**

*Pvu*II digestion of the library constructed in pSPL3 is a good indicator of the quality of the library. (Lane 1) *Pvu*II digest of pSPL3; note the 2-kb and 4-kb bands. (Lane 2) Example of a poor library; note the strong 2-kb band, indicating a substantial vector religation. (Lane 3) Example of a good library; note the reduction in the amount of the 2-kb band, and the large number of fragments released by the *Pvu*II digestion. (Adapted, with permission, from D.M. Church.)

## STAGE 2: Electroporation of the Library into COS-7 Cells

In this stage of the exon amplification protocol, COS-7 cells are transfected with recombinant pSPL3 plasmids containing the genomic DNA of interest. COS-7 cells were originally derived from the African green monkey kidney cell line CV-1 by transformation with a replication-deficient SV40 that encodes wild-type large T antigen (Gluzman 1981; please see the information panel on COS CELLS). The large T antigen drives replication of the transfected plasmid by activating the SV40 origin of replication. The resulting high-copy number of the transfected plasmid allows for vigorous transcription, initiating at the SV40 promoter of pSPL3, of the heterologous minigene (please see Figure 11-16).

Other transfection techniques, such as lipofection, have been used with success in exon amplification (e.g., please see Nisson et al. 1994).

### MATERIALS

---

#### Buffers and Solutions

Please see Appendix 1 for components of stock solutions, buffers, and reagents. Dilute stock solutions to the appropriate concentrations.

*Phosphate-buffered saline (PBS) without divalent cations*

#### Enzymes and Buffers

*Trypsin-EDTA solution*

#### Nucleic Acids and Oligonucleotides

*DNA*

The plasmid DNA to be transfected was prepared in Stage 1 of this protocol, Steps 10–12.

*Plasmid vector for use as control (Step 3)*

#### Media

*Dulbecco's modified Eagle's medium (DMEM) containing 10% heat-inactivated fetal calf serum*

#### Centrifuges and Rotors

*Sorvall H1000B rotor or equivalent*

#### Special Equipment

*Electroporation device and cuvettes fitted with electrodes spaced 0.4-cm apart*

*Tissue culture dishes (100 mm)*

*Wide-bore pipettes*

#### Cells and Tissues

*COS-7 cells*

COS-7 cells are grown to a confluency of 75–85% in DMEM containing 10% heat-inactivated fetal calf serum. For details of dealing with cells in culture, including trypsinizing, please see Spector et al. (1998b).

## METHOD

---

1. Wash the monolayer of COS-7 cells with phosphate-buffered saline lacking divalent cations. Remove the cells from the surface of the dishes by treatment with trypsin-EDTA. Collect the cells by centrifugation at 250g (1100 rpm in a Sorvall H1000B rotor) for 10 minutes at 4°C.  
**▲ IMPORTANT** Keep the COS-7 cells cold throughout the procedure.  
For details on trypsinizing cells, please see Spector et al. (1998b).
2. Adjust the volume of the DNA sample to be used for transfection to a total volume of 100  $\mu$ l in PBS without divalent cations.  
The amount of DNA required for transfection must be optimized as described in Chapter 16, Protocol 5.
3. Resuspend  $4 \times 10^6$  COS-7 cells in a volume of 700  $\mu$ l of PBS without divalent cations. Mix the cells with the DNA in a cooled electroporation cuvette (0.4-cm chamber). Incubate the mixture for 10 minutes on ice.  
Use of PBS with divalent cations can lead to arcing during electroporation, which can ruin the electroporator.  
Be sure to perform a transfection with vector-only DNA as a control.
4. Gently resuspend the cells and introduce the DNA into the cells by electroporation at 1.2 kV (3 kV/cm) and 25  $\mu$ F. Immediately return the cuvettes to ice, and store them for 10 minutes.  
The conditions for electroporation may need to be optimized as described in Chapter 16, Protocol 5.
5. Use a wide-bore pipette to transfer  $1 \times 10^6$  of the electroporated cells into a series of 100-mm tissue culture dishes that contain 10 ml of DMEM containing 10% heat-inactivated fetal calf serum that has been warmed to 37°C. Incubate the cultures for 48–72 hours at 37°C in a humidified incubator with an atmosphere of 5–7% CO<sub>2</sub>.

## STAGE 3: Harvesting the mRNA

RNA is isolated from the transfected COS-7 cells by differential centrifugation, followed by precipitation of nucleic acids from the cytoplasmic component. A 100-mm tissue culture dish, nearly confluent with transfected COS-7 cells, will provide RNA for several experiments.

### MATERIALS

---

▲ **IMPORTANT** Prepare all reagents used in this protocol with DEPC-treated H<sub>2</sub>O (please see the information panel on **HOW TO WIN THE BATTLE WITH RNASES** in Chapter 7).

**CAUTION:** Please see Appendix 12 for appropriate handling of materials marked with <!.>.

### Buffers and Solutions

Please see Appendix 1 for components of stock solutions, buffers, and reagents. Dilute stock solutions to the appropriate concentrations.

DEPC-treated H<sub>2</sub>O <!.>

Ethanol

NaCl (5 M)

Phenol <!.>

Phenol:chloroform <!.>

Phosphate-buffered saline (PBS) without divalent cations

SDS (5% w/v)

TKM buffer

10 mM Tris-Cl (pH 7.5)

10 mM KCl

1 mM MgCl<sub>2</sub>

Triton X-100 (10% v/v) or Nonidet P-40 (4% v/v)

### Centrifuges and Rotors

Sorvall H1000B rotor or equivalent

### Special Equipment

Cell scrapers or Rubber policemen

Polystyrene tubes (15 ml), chilled to 0°C in ice

### Cells and Tissues

COS-7 cells transfected with the recombinant and nonrecombinant forms of pSPL3

## METHOD

---

1. Rinse the tissue culture plates of transfected COS-7 cells three times with ice-cold PBS lacking calcium and magnesium ions. Keep plates on a bed of ice between rinses.
2. Add 10 ml of ice-cold PBS to each plate. Place the plate on the bed of ice, and gently scrape the cells off the plate.
3. Transfer the cell suspensions to chilled 15-ml polystyrene tubes.

The use of polystyrene tubes, which are transparent, will facilitate recovery of cytoplasm free of nuclei in Steps 8 and 9.
4. Recover the cells by centrifugation at 300g (1200 rpm in a Sorvall H1000B rotor) for 8 minutes at 4°C.
5. Decant as much of the supernatant as possible. Remove the residual supernatant with a pipette.
6. Resuspend the cell pellet from  $1 \times 10^6$  to  $2 \times 10^6$  COS cells in 300  $\mu$ l of TKM buffer and store the suspension on ice for 5 minutes.
7. Add 15  $\mu$ l of 10% Triton X-100 or 4% Nonidet P-40 and store the cell suspension on ice for a further 5 minutes.

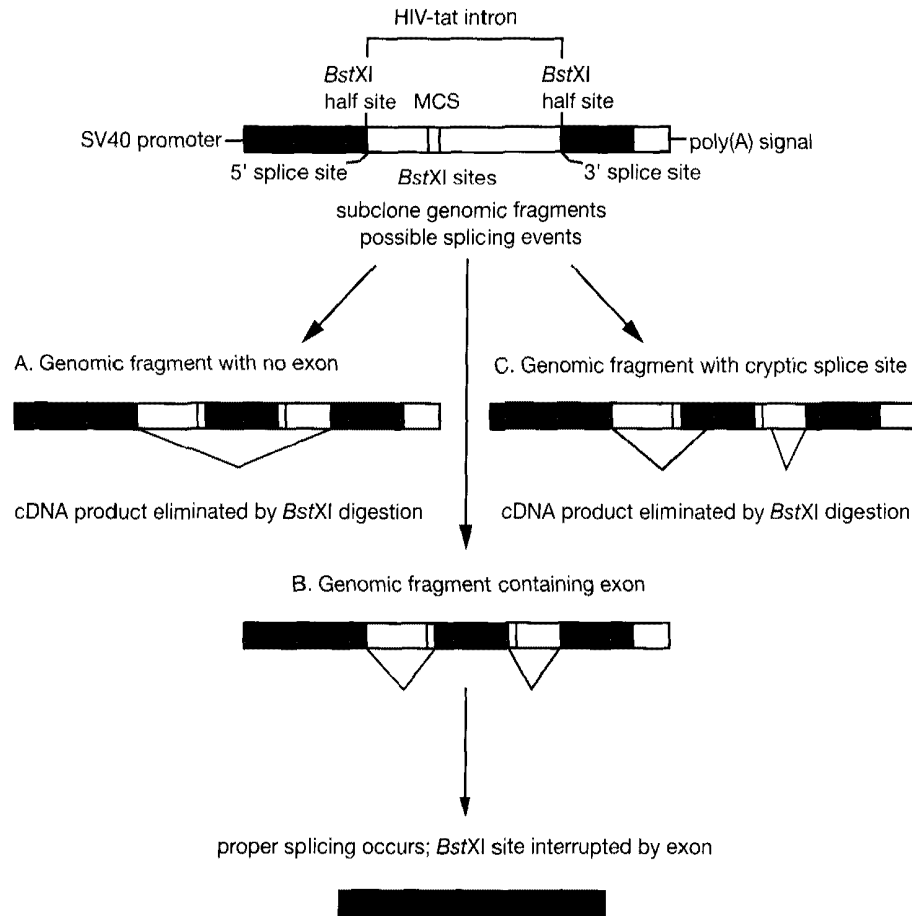
Addition of nonionic detergent gently lyses the plasma membrane while leaving the nuclear membrane intact.
8. Recover the nuclei by centrifugation at 500g (1500 rpm in a Sorvall H1000B rotor) for 5 minutes at 4°C.
9. Transfer the supernatant to a chilled 1.5-ml microfuge tube.

**▲ IMPORTANT** Use extreme care when removing the supernatant. Do not touch the nuclear pellet. If the nuclear membranes burst, the sample will become too viscous to pipette due to the contamination with genomic DNA.
10. Add 20  $\mu$ l of 5% SDS and 300  $\mu$ l of phenol. Vortex the mixture vigorously and separate the organic and aqueous phases by centrifugation at maximum speed for 5 minutes at 4°C in a microfuge.
11. Transfer the aqueous layer to a 1.5-ml microfuge tube containing 300  $\mu$ l of phenol:chloroform. Vortex the suspension vigorously and then separate the organic and aqueous phases by centrifugation at maximum speed for 3 minutes at room temperature in a microfuge.
12. Transfer the aqueous (upper) layer to a chilled 1.5-ml microfuge tube containing 12  $\mu$ l of 5 M NaCl and 750  $\mu$ l of ethanol. Allow the RNA to precipitate for 2–3 hours at –20°C or for 30 minutes at –80°C.

Nucleic acids are more stable in ethanol than in H<sub>2</sub>O. For long-term storage, store the RNA in ethanol at –80°C (please see the panel on **STORAGE OF RNA** at the end of Protocol 1 in Chapter 7).
13. Recover the RNA by centrifugation at maximum speed for 10 minutes at 4°C in a microfuge.
14. Discard the supernatant and wash the pellet with 70% ethanol. Dry the pellet in air and redissolve it in 20  $\mu$ l of DEPC-treated H<sub>2</sub>O.

## Stage 4: Reverse Transcriptase-PCR

In this stage of the protocol, cDNA molecules are generated from the RNA isolated in Stage 3. Molecules of pSPL3-derived cDNA lacking genomic DNA sequences and those containing genomic DNA sequences harboring cryptic splice sites are eliminated by digestion with *Bst*XI (please see Figure 11-18). The digestion products are cloned into a Bluescript vector (Stratagene) to facilitate identification of the exon-trapped products.



**FIGURE 11-18 Linear View of the Minigene of pSPL3**

The SV40 promoter sequence (shaded box) and poly(A) addition signal (open box) are shown at either ends of the linear scheme. (Shaded pattern) Vector-derived exons; (open box) intronic sequences; (narrow open box) multiple cloning site (MCS). Note the inclusion of *Bst*XI half-sites at the vector splice donor and splice acceptor sites. Three possible splicing classes can be derived from this experiment: (A) The genomic fragment does not contain an intact exon or the fragment is cloned in the wrong orientation; vector-only splicing occurs. This product is virtually eliminated by *Bst*XI digestion prior to cloning of the products. (B) The genomic fragment contains an intact exon, cloned in the proper orientation; proper splicing occurs between the vector sequences and the exon sequences found in the genomic DNA. The *Bst*XI half-sites are not reconstituted. (C) The genomic sequence contains a cryptic splice site that activates a cryptic splice site found in the intron of pSPL3. In this case, improper splicing occurs between the vector sequences and the genomic fragment. However, this product will retain a portion of the MCS. The MCS is flanked by *Bst*XI sites, allowing this product to be eliminated by *Bst*XI digestion before cloning. (Adapted, with permission, from D.M. Church.)

## MATERIALS

---

**CAUTION:** Please see Appendix 12 for appropriate handling of materials marked with <!>.

### Buffers and Solutions

Please see Appendix 1 for components of stock solutions, buffers, and reagents. Dilute stock solutions to the appropriate concentrations.

*10x Amplification buffer*

*Chloroform <!>*

*DEPC-treated H<sub>2</sub>O <!>*

*Dithiothreitol (1 M)*

*dNTP solution containing all four dNTPs, each at a concentration of 1.25 mM*

*Phenol <!>*

*RNase inhibitor*

### Enzymes and Buffers

*BstXI*

*EcoRV*

*Mo-MLV reverse transcriptase*

*Taq DNA polymerase*

*Uracil DNA glycosylase (1 unit/μl)*

### Gels

*Agarose gel (1.5% w/v) in TBE buffer*

### Nucleic Acids and Oligonucleotides

*Oligonucleotides primers (20 mM in TE [pH 8.0]):*

SA2 5' ATC TCA GTG GTA TTT GTG AGC 3'

SD6 5' TCT GAG TCA CCT GGA CCA CC 3'

SDDU 5' AUA AGC UUG AUC UCA CAA GCT GCA CGC TCT AG 3'

SADU 5' UUC GAG UAG UAC UTT CTA TTC CTT CGG GCC TGT 3'

BSD-U 5' GAU CAA GCU UAU CGA TAC CGT CGA CCT 3'

BSA-U 5' AGU ACU ACU CGA AUT CCT GCA GCC 3'

Please note that the 5' ends of oligonucleotides SDDU, SADU, BSD-U, and BSA-U contain uracil residues to facilitate ligation-independent cloning (please see the information panel on **LIGATION-INDEPENDENT CLONING**; Rashtchian 1995). SADU and SDDU are nested primers.

*RNA isolated from COS-7 cells transfected with control and recombinant vectors (Stage 3)*

### Media

*LB agar plates containing 50 μg/ml ampicillin*

### Special Equipment

*Barrier tips for automatic micropipettes*

*Microfuge tubes (0.5-ml thin-walled for amplification reactions, RNase-free)*

*Positive-displacement pipette*

*Thermal cycler programmed with desired amplification protocol*

If the thermal cycler is not equipped with a heated lid, use either mineral oil or paraffin wax to prevent evaporation of liquid from the reaction mixture during PCR. Paraffin wax may be used not only to prevent evaporation, but also to maintain separation between components (e.g., primer and template) until the reaction mixture is heated. This prevents nonspecific binding of primers during the initial phase of the reaction (please see the information panel on **HOT START PCR** in Chapter 8).

*Water baths preset to 42°C, 55°C, and 65°C*



## Additional Reagents

Step 14 of this protocol requires the reagents listed in Chapter 1, Protocol 25.

## Vectors and Bacterial Strains

*E. coli* strain DH5 $\alpha$  (or another strain that permits  $\alpha$ -complementation)  
*pBluescript II (KS or SK)* (Stratagene)

## METHOD

---

### Synthesis of the cDNA

1. Generate the first-strand cDNA from the cytoplasmic RNAs isolated in the previous stage (Stage 3), using the SA2 oligonucleotide as a primer. In an RNase-free 0.5-ml tube combine:

RNA	3 $\mu$ l
10x amplification buffer	2.5 $\mu$ l
dNTP solution at 1.25 mM	4 $\mu$ l
0.1 M dithiothreitol	1 $\mu$ l
3' oligo (SA2, 20 $\mu$ M)	1.25 $\mu$ l
DEPC-treated H <sub>2</sub> O	11.25 $\mu$ l

Heat the reaction mixture to 65°C for 5 minutes.

**▲ IMPORTANT** To reduce formation of secondary structures in the RNAs, do not place the reaction mixture on ice!

Then add:

RNase inhibitor	1 $\mu$ l
Mo-MLV reverse transcriptase (200 units)	1 $\mu$ l

Incubate the reactions for 90 minutes at 42°C.

2. Use both the SA2 oligonucleotide primer and the SD6 oligonucleotide primer to carry out a limited second-strand synthesis. Combine the following in a sterile thin-walled amplification tube:

reverse transcriptase reaction (Step 1)	12.5 $\mu$ l
10x amplification buffer	4 $\mu$ l
dNTP solution at 1.25 mM	6 $\mu$ l
SA2 oligonucleotide primer (20 $\mu$ M)	2 $\mu$ l
SD6 oligonucleotide primer (20 $\mu$ M)	2.5 $\mu$ l
<i>Taq</i> DNA polymerase	1–2 units
DEPC-treated H <sub>2</sub> O	to 40 $\mu$ l

Process the vector-only control in the same way. This will serve as an important control during the PCR analysis.

3. If the thermal cycler is not fitted with a heated lid, overlay the reaction mixtures with 1 drop (~50  $\mu$ l) of light mineral oil. Alternatively, place a bead of paraffin wax into the tube if using a hot start PCR. Place the tubes in the thermal cycler.
4. Amplify the nucleic acids using the denaturation, annealing, and polymerization times and temperatures listed in the table.

Cycle Number	Denaturation	Annealing	Polymerization
1	5 min at 94°C		
5–6	30 sec at 94°C	30 sec at 62°C	3 min at 72°C
Last cycle			5 min at 72°C

These times are suitable for 40- $\mu$ l reactions assembled in thin-walled 0.5-ml tubes and incubated in thermal cyclers such as the Perkin-Elmer 9600 or 9700, Master Cycler (Eppendorf), and PTC 100 (MJ Research). Times and temperatures may need to be adapted to suit other types of equipment and reaction volumes.

The purpose of this PCR is to generate double-stranded material for *Bst*XI digestion.

Three-minute extensions are used in this initial PCR to increase the efficiency of capture of longer cDNA products. Limited cycling time is used to minimize the possibility of generating PCR artifacts.

Continue to process the material amplified from COS cells transfected with vector DNA alone (Stage 2).

## Preparation of the cDNA and Vector for Cloning

5. Add 30 units of *Bst*XI to the PCRs. Overlay the reaction mixtures with light mineral oil (if not already on the reaction) and incubate the mixtures overnight at 55°C.

*Bst*XI digestion greatly reduces vector-only splice products and false positives generated by a cryptic splice site within the vector intron.

The vector pSPL3 contains several cryptic splice sites. The molecules generated by aberrant splicing at these sites are generally a minor component of the amplified products, and generally appear only (i) in the reaction tube containing empty vector, (ii) in a reaction in which the pSPL3 library is of poor quality, or (iii) when the genomic DNA contains no transcripts that can be identified with this method.

6. Add an additional 20 units of *Bst*XI to the PCR and incubate the reaction for an additional 2–3 hours at 55°C.
7. Meanwhile, digest 1  $\mu$ g of pBSII(KS or SK) to completion with *Eco*RV. Purify the DNA by extraction with phenol and precipitation with ethanol. Dissolve the digested DNA in H<sub>2</sub>O at a concentration of 2 ng/ $\mu$ l.

8. In a 0.5-ml amplification tube, mix the following:

<i>Bst</i> XI-digested RT-PCR (Step 6)	5–10 $\mu$ l
10x amplification buffer	4.5 $\mu$ l
dNTP solution at 1.25 mM	7.5 $\mu$ l
SADU oligonucleotide primer (20 $\mu$ M)	2.5 $\mu$ l
SDDU oligonucleotide primer (20 $\mu$ M)	2.5 $\mu$ l
<i>Taq</i> DNA polymerase	10–20 units
H <sub>2</sub> O	to 45 $\mu$ l

9. In another 0.5-ml amplification tube, mix the following:

pBSII(KS or SK) digested with <i>Eco</i> RV (2 ng/ $\mu$ l)	10 $\mu$ l
10x amplification buffer	10 $\mu$ l
dNTP solution at 1.25 mM	16 $\mu$ l
BSD-U oligonucleotide primer (20 $\mu$ M)	5 $\mu$ l
BSA-U oligonucleotide primer (20 $\mu$ M)	5 $\mu$ l
<i>Taq</i> DNA polymerase	2–4 units
H <sub>2</sub> O	to 100 $\mu$ l

10. If the thermal cycler is not fitted with a heated lid, overlay the reaction mixtures (Steps 8 and 9) with 1 drop (~50 µl) of light mineral oil. Alternatively, place a bead of paraffin wax into the tubes if using a hot start PCR. Place the tubes in the thermal cycler.
11. Amplify the nucleic acids using the denaturation, annealing, and polymerization times and temperatures listed in the table.

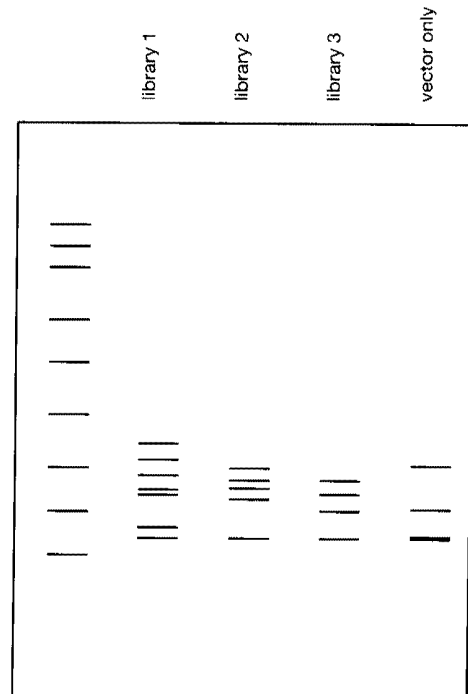
Cycle Number	Denaturation	Annealing	Polymerization
1	5 min at 94°C		
25-30	30 sec at 94°C	30 sec at 62°C	3 min at 72°C
Last cycle			5 min at 72°C

These times are suitable for reactions assembled in thin-walled 0.5-ml tubes and incubated in thermal cyclers such as the Perkin-Elmer 9600 or 9700, Master Cycler (Eppendorf), and PTC 100 (MJ Research). Times and temperatures may need to be adapted to suit other types of equipment.

The 5' ends of the primers used in the second round of PCR amplification contain dUTP rather than dTTP. This facilitates ligation-independent cloning (Rashtchian 1995). The 5' ends of BSD-U and BSA-U are complementary to the 5' ends of SADU and SDDU.

It is best to perform the uracil DNA glycosylase reaction (Step 13) the same day as the amplification. If this is not possible, purify the amplification reactions by extraction with phenol:chloroform, followed by ethanol precipitation, and store them at -20°C until ready for use. The dU-amplified vector (Step 9) can be stored for several weeks at -20°C.

12. Run an aliquot of the PCR on a 1.5% agarose gel in TBE to assess the quality of the reaction. There should be a smear representing several amplification products (Figure 11-19).



**FIGURE 11-19 Representation of a Gel Demonstrating Possible Products Seen after Amplification of the Exon-trapped Products with SADU and SDDU, before Cloning**

Amplification of nonrecombinant pSPL3 is shown in the right-hand lane (vector only). The lowest band represents the vector-only splice product, whereas the other two bands are derived from additional cryptic splice sites in the vector. The other three lanes (library 1, 2, 3) show representations of three typical amplification reactions. The vector-only band is present in all other lanes, but it is reduced in intensity. (Adapted, with permission, from D.M. Church.)

### Cloning the Exon-trapped Products

13. In a 0.5-ml microfuge tube, mix the following:
- |   |               |
|---|---------------|
| <i>Bst</i> XI-digested cDNA (Step 8)<br>amplified in Step 11      | 3 $\mu$ l     |
| <i>Eco</i> RV-digested pBSII DNA (Step 9)<br>amplified in Step 11 | 1 $\mu$ l     |
| 10 $\times$ amplification buffer                                  | 1 $\mu$ l     |
| uracil DNA glycosylase (UDG; 1 unit/ $\mu$ l)                     | 1 $\mu$ l     |
| H <sub>2</sub> O  | to 10 $\mu$ l |

Incubate the reaction mixture for at least 30 minutes at 37°C.

▲ **IMPORTANT** During this reaction, DNA containing dU residues is digested by uracil DNA glycosylase. In addition, the complementary termini of the plasmid and the amplified cDNA anneal to form recombinant molecules. To prevent nonspecific annealing of the vector and PCR product, do not place the reaction on ice after the 37°C incubation. If Steps 14 and 15 cannot be carried out immediately, leave the reaction at 37°C or store it at -20°C.

14. Use the entire UDG reaction mixture to transform 30–50  $\mu$ l of DH5 $\alpha$  *E. coli* cells using a CaCl<sub>2</sub> transformation procedure (please see Chapter 1, Protocol 25).
15. Plate 100–500  $\mu$ l of the transformation reaction onto LB agar plates containing 50  $\mu$ g/ml ampicillin, and incubate them overnight at 37°C.

## STAGE 5: Analysis of Clones

The final stage of this protocol outlines a strategy for the initial analysis of amplified and exon-trapped products (ETPs). By amplifying the ETPs with the -20 and REV primers of pBSII, promoters for bacteriophages T3 and T7 remain intact. The amplicons can therefore be sequenced using oligonucleotide primers complementary to the promoter sequences. Direct sequencing of the amplicons using these internal primers can then be easily performed.

Sequence analysis and comparison to public databases will allow quick elimination of clones derived from splicing artifacts that escaped *Bst*XI digestion. Sequences other than authentic exons that can be captured in this system, such as the *Alu*, *Line*, and *HERV* repetitive elements, can be identified by comparing the ETP sequences with those in public databases. In addition, contamination of the genomic DNA with DNA from *E. coli* or yeast can be readily identified by sequence analysis, as the genomes of both organisms have been sequenced completely.

Once false positives have been eliminated, further analysis is required of the reduced ETP set. A critical goal is to determine the map locations of the ETPs. If an ETP fails to map to a region of interest, it may be because the original DNA was chimeric or because chimeras formed during amplification.

After the initial analysis has been performed and a minimal set of ETPs has been validated, these reagents become ideal starting materials for other analyses, including northern hybridization, RNase protection, and in situ hybridization (Church et al. 1993; D.M. Church et al., unpubl.). ETPs are also the starting point for the identification of full-length RNAs. They can be used to probe cDNA libraries (Church et al. 1993), or oligonucleotide primers can be synthesized from their sequences and used in other protocols, such as rapid amplification of cDNA ends (RACE; please see Chapter 8, Protocols 9 and 10), or PCR-based cDNA screening (Frohman 1993; Munroe et al. 1995).

---

### MATERIALS

#### Buffers and Solutions

Please see Appendix 1 for components of stock solutions, buffers, and reagents.  
Dilute stock solutions to the appropriate concentrations.

*10x Amplification buffer*

#### Enzymes and Buffers

*Taq DNA polymerase*

#### Gels

*Agarose gel (1.5%) cast in TAE buffer*  
Please see Step 7.

#### Nucleic Acids and Oligonucleotides

*dNTP solution containing all four dNTPs, each at 1.25 mM*  
*Exon-trapped products cloned into a pBSII vector*

Clones are in the form of recombinant DH5 $\alpha$  colonies prepared in Stage 4.

*Oligonucleotide primers (20 mM in TE [pH 8.0])*

T3 5' AAT TAA CCC TCA CTA AAG GG 3'  
 T7 5' GTA ATA CGA CTC ACT ATA GGG C 3'  
 -20 5' GTA AAA CGA CGG CCA GT 3'  
 REV 5' AGC GGA TAA CAA TTT CAC ACA GG 3'

**Media***LB broth containing 50 µg/ml ampicillin**LB broth containing 30% (v/v) glycerol***Special Equipment***Microtiter plates (96 well) for PCR**Multichannel pipettor or insulating manifold/frogger (e.g., Dank or Scientific)**Thermal cycler capable of accepting 96-well microtiter dishes***Additional Reagents***Step 8 of this protocol requires the reagents listed in Chapter 12, Protocol 3, 4 or 5.***METHOD**

1. Dispense 100 µl of LB broth containing 50 µg/ml ampicillin into each well of a 96-well microtiter plate. Transfer one transformed bacterial colony (from Step 15 of Stage 4) at a time into individual wells. Cover the plate with Parafilm, and grow the colonies for 3–4 hours at 37°C. It is not necessary to agitate the plate.
2. Prepare a master mix (sufficient for 100 wells) of PCRs by combining the following components together:
 

10x amplification buffer	250 µl
dNTP solution at 1.25 mM	400 µl
-20 oligonucleotide primer (20 µM)	125 µl
REV oligonucleotide primer (20 µM)	125 µl
H <sub>2</sub> O	1475 µl
<i>Taq</i> DNA polymerase	75 units

Aliquot 24 µl of the master mix into each well of fresh 96-well PCR plates.
3. Use a 96-prong replicating device to transfer bacterial cultures from the plate in Step 1 to the plate containing the PCR master mix.
4. If the thermal cycler is not fitted with a heated lid, overlay the reaction mixtures with 1 drop (~50 µl) of light mineral oil. Alternatively, place a bead of paraffin wax into the wells if using a hot start PCR. Place the 96-well plates in the thermal cycler.
5. Amplify the nucleic acids using the denaturation, annealing, and polymerization times and temperatures listed in the table.

Cycle Number	Denaturation	Annealing	Polymerization
1	5 min at 94°C		
25–30	30 sec at 94°C	30 sec at 62°C	30 sec at 72°C
Last cycle	30 sec at 94°C	30 sec at 62°C	5 min 72°C

6. Use a multichannel pipettor to make a replica of the 96-well plate (from Step 1) containing the bacterial colonies and allow them to grow overnight at 37°C. The next day, add to each well 100 µl of LB broth containing 30% glycerol. Seal the plate with Parafilm, and store it at -80°C.
7. Analyze the amplification products from Step 5 by gel electrophoresis on a 1.5% agarose gel. There should be a variety of different size bands on the gel. It is not productive to determine ETP redundancy based on size, because the PCR products typically cluster around 120 bp.
8. Determine the sequence of each of the ETPs (please see Chapter 12, Protocol 3, 4, or 5). If pBSIISK<sup>-</sup> was used for cloning, sequencing with T7 will produce sequence from the 5' end of the ETP. The ETP will be flanked by the following pSPL3-derived sequence:  
5' GTCGACCCAGCA ETP sequence ACCTGGAGATCC 3'

# Protocol 4

---

## Direct Selection of cDNAs with Large Genomic DNA Clones

Michael Lovett

*Washington University, St. Louis, Missouri*

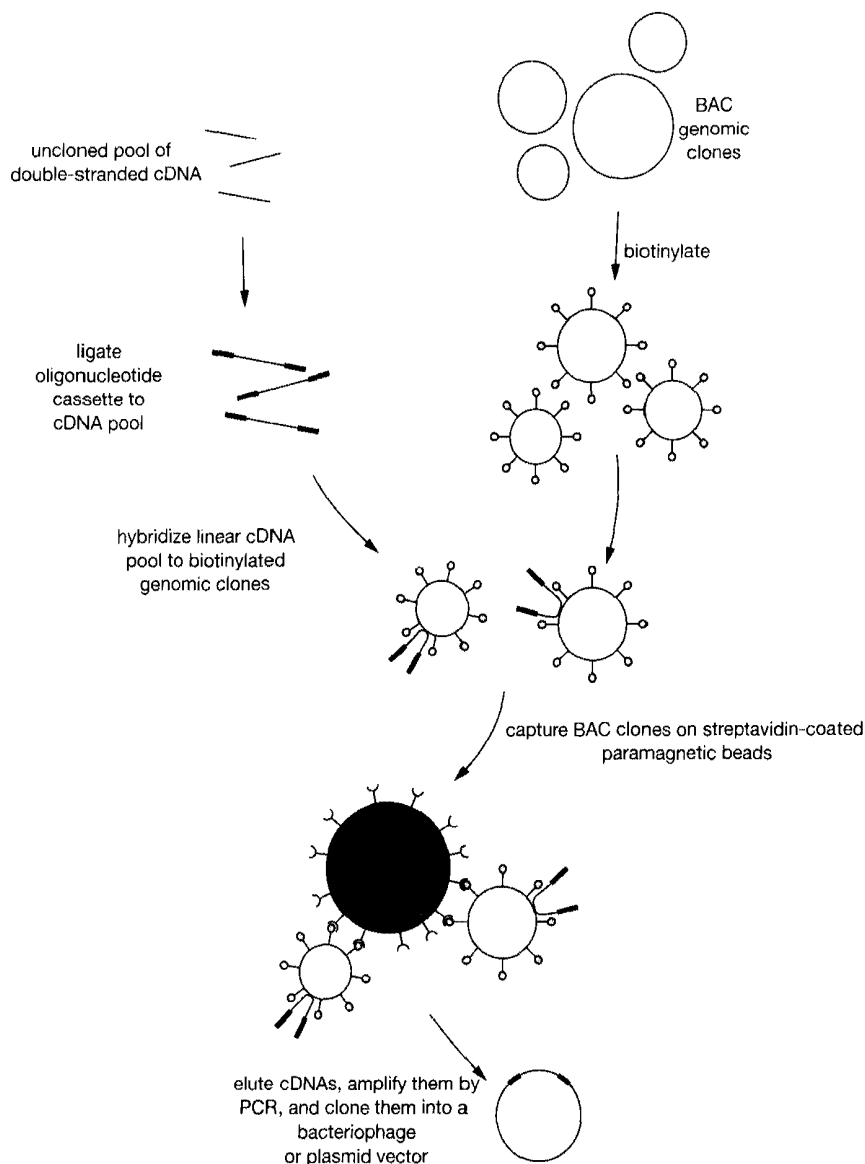
**T**HIS TECHNIQUE IS USED TO DERIVE PARTS OF CANDIDATE GENES from large genomic regions. It is based on the hybridization capture of cDNAs using biotinylated genomic templates (Morgan et al. 1992; Simmons and Lovett 1999). The starting template is a genomic contiguous sequence (contig) carried in bacterial (cosmid, P1, PAC, or BAC) and/or yeast (YAC) vectors. These genomic DNA clones, which can cover a region as short as a few kilobases or as large as 100 Mb (Del Mastro et al. 1995) are labeled with biotin and then hybridized in solution to PCR-amplifiable cDNA pools. After washing, the genomic DNAs and hybridizing cDNAs are captured using streptavidin beads. The cDNAs are eluted, amplified by PCR, and recycled through a second round of direct selection, after which they are again amplified and then cloned (please see Figure 11-20).

Whereas in the first cycle of selection, the genomic DNA is in molar excess relative to the concentration of rare cDNA species, in the second round of selection, the concentration of genomic DNA is limiting. This sequence results in large increases in the relative abundance of the more prevalent cDNA species in the first round of selection. During the second round, insufficient genomic target is present to capture all of the abundant cDNAs, which become reduced in abundance. However, the genomic target is still in excess relative to the low-abundance species of cDNAs, whose relative abundance is increased, leading to a quasi-normalized final library of selected cDNAs.

The efficiency of each round of the selection procedure is monitored using reporter genes. This is accomplished by hybridizing gene-specific DNA probes to a Southern blot containing the amplified starting cDNA, cDNAs from the first round of selection, and cDNAs from the second round of selection. Enrichments of  $10^3$ -fold to  $10^4$ -fold are routinely achieved when genomic targets of ~1 Mb are used.

Efficient labeling of the genomic template with biotin is a critical step in this procedure and is indirectly monitored using trace amounts of [ $\alpha$ - $^{32}$ P]dCTP in the labeling reaction in addition to the biotin-labeled nucleoside triphosphate. Part of the labeling reaction is then tested for its ability to bind to streptavidin-coated beads. The ratio of bound to unbound counts on the beads provides an estimate of the biotin incorporation. The labeling reactions are also performed using a 1:10 molar ratio of biotin-16-dUTP to dTTP to reduce steric hindrance during the hybridization reactions. For further details on labeling with biotin and subsequent detection using streptavidin-coated beads, please see the information panels on **BIOTIN** and **MAGNETIC BEADS**.





**FIGURE 11-20** Scheme for Direct Selection of cDNAs

For details of the reaction, please see text. (Adapted, with permission, from Simmons and Lovett 1999 [©Academic Press].)

The best source of cDNA for direct selections is an uncloned pool of PCR-amplifiable cDNA (Reyes and Kim 1991; Reyes et al. 1992). Conventional cDNA libraries contain only a subset of the transcripts expressed in a complex tissue source, and their average insert lengths are usually not optimal for en masse PCR amplification of all the inserts. By contrast, uncloned cDNA pools represent the entire mRNA complexity of the source tissue, and they can be constructed by random priming to have a mean length of ~500 bp, which is optimal for all the PCR steps. For the cleanest results, it is advisable to use cytoplasmic RNA purified from mammalian cells or tissues to reduce the possibility of selecting heterogeneous nuclear RNA and/or genomic DNA (Clemens 1984). Polyadenylated RNA is purified by two rounds of oligo(dT)-cellulose chromatography (please see Chapter 7, Protocol 3). Synthesis of double-stranded cDNA can be performed using a combination of oligo(dT) and random hexamer primers (please see Protocol 1,

Stage 2). It is advisable to select cDNA products that are at least 500 bp in length by either column chromatography or gel electrophoresis, before adding linkers. The linker cassettes contain a 2-bp overhang at the 3' end, which forces the cassette to be ligated in only one orientation and also prevents the formation of large oligomers of the cassette. Direct selections are often performed with multiplexed cDNA pools from several different tissues. These can be amplified separately by PCR and cloned after the two rounds of selection are completed (Simmons et al. 1995).

This protocol describes direct selection of cDNAs complementary to a 500-kb human genomic DNA contig cloned in a BAC vector, but it can be adapted to any size of genomic target. The cDNA source for the example is random-primed cDNA, which is ligated to an amplification cassette. If a cDNA library is used instead of primary cDNA, then vector primers for PCR must be substituted in these steps. It is important to change the relative ratios of cloned genomic DNA to cDNA as the total length of the contig changes and to recalculate the  $C_{0.1/2}$  of the reaction using all of the nucleic acid components that are added to the mixture.

## MATERIALS

---

**CAUTION:** Please see Appendix 12 for appropriate handling of materials marked with <!.>.

### Buffers and Solutions

Please see Appendix 1 for components of stock solutions, buffers, and reagents. Dilute stock solutions to the appropriate concentrations.

#### 10x Amplification buffer

Include 0.01% (w/v) gelatin in the buffer.

#### ATP (10 mM)

#### 2x Hybridization solution

1.5 M NaCl  
40 mM Na phosphate buffer (pH 7.2)  
10 mM EDTA (pH 8.0)  
10X Denhardt's solution  
0.2% SDS

#### NaOH (0.1 M) <!.>

#### 10x Nick translation buffer

500 mM Tris-HCl (pH 7.5)  
100 mM MgCl<sub>2</sub>  
50 mM dithiothreitol

#### SDS (10%)

#### 20x SSC

#### Streptavidin bead-binding buffer

10 mM Tris-HCl (pH 7.5)  
1 mM EDTA (pH 8.0)  
1 M NaCl

#### Tris-HCl (1 M, pH 7.5)

### Enzymes and Buffers

DNA polymerase/DNase I (5 units/μl; Boehringer Mannheim)

Restriction endonucleases

T4 DNA ligase

Thermostable DNA polymerase

### Gels

Agarose gels (1%) cast in 0.5x TBE

Please see Steps 18, 19, 24, and 25.

## Nucleic Acids and Oligonucleotides

*BAC DNA encompassing the target genomic region*

Purify as described in Chapter 4, Protocol 8 or 9.

*Blunt-ended, random-primed cDNAs*

Please see Protocol 1, Stage 1.

*C<sub>0</sub>t1 genomic DNA*

Purchased from Life Technologies.

*Cytoplasmic poly(A)<sup>+</sup> RNA, purified from tissue or cell line of interest*

Please see Protocol 1, Stage 1.

Please see the introduction to this protocol for recommendations of purifying RNA to be used in this protocol.

*DNA size markers*

*dNTP solution for nick translation containing all four dNTPs, each at 0.4 mM (pH 8.0)*

*dNTP solution for PCR containing all four dNTPs, each at 2.5 mM (pH 8.0)*

*Oligonucleotides (10 mM in TE [pH 8.0]):*

Oligo3 5'-CTCGAGAATTCTGGATCCTC-3'

Oligo4 5'-GAGGATCCAGAATTCTCGAGTT-3'

*Positive-control DNA*

The positive-control DNA should be a part of a gene or expressed sequence tag (EST) known to be present in the starting segment of DNA. If no genes are known, then a single-copy control DNA can be seeded into the genomic target before labeling (at a 1:1 molar ratio) and diluted into the cDNA (at a 1:10<sup>6</sup> molar ratio). Label the DNA sample using one of the protocols given in Chapter 9; the choice of labeling protocol is determined by the experimental goal (for a discussion of options, please see the introduction to Chapter 9).

## Labeled Compounds

*[ $\alpha$ -<sup>32</sup>P]dCTP (3000Ci/mmole) <!>*

*Biotin-16-dUTP (0.4 mmole)*

## Special Equipment

*Barrier tips for automatic pipettes*

*Geiger counter or Cerenkov counter*

*Heating blocks preset to 14°C and 100°C*

*Hybridization oven with rotating spindle, or shaking water bath*

*Magnetic separator for removing streptavidin beads (Dyna)*

*Microfuge tubes (0.5-ml thin-walled for amplification)*

*Positive displacement pipettes*

*Sephadex G-50 spun column, equilibrated in TE (pH 7.6)*

Prepacked columns of Sephadex and other gel filtration resins are commercially available.

*Streptavidin-coated paramagnetic beads*

*Thermal cycler programmed with desired amplification protocol*

If the thermal cycler is not equipped with a heated lid, use either mineral oil or paraffin wax to prevent evaporation of liquid from the reaction mixture during PCR. Paraffin wax may be used not only to prevent evaporation, but also to maintain separation between components (e.g., primer and template) until the reaction mixture is heated. This prevents nonspecific binding of primers during the initial phase of the reaction (please see the information panel on **HOT START PCR** in Chapter 8).

*Water bath preset to 65°C*

## Additional Reagents

*Step 1 of this protocol requires reagents listed in Chapter 10, Protocol 2.*

*Step 2 of this protocol requires reagents for the synthesis of random primed double-stranded cDNAs or PCR-amplified inserts from a cDNA library listed in Protocol 1, Stages 1 and 2.*

*Step 2 of this protocol requires reagents for labeling listed in Chapter 9, Protocols 3, 5, and 6.*

*Steps 19 and 20 require reagents listed in Chapter 6, Protocols 8 and 10.*

**METHOD****Preparation of the Linkered cDNA Pools**

1. Label oligonucleotides 3 and 4 separately by phosphorylation at their 5' termini using polynucleotide kinase, as described in Chapter 10, Protocol 2. Mix the labeled complementary oligos in equal molar ratios (~2 µg of each), denature them for 10 minutes at 100°C, and slowly cool them to room temperature. During this process, the oligonucleotides anneal to form an adaptor. Adjust the concentration of the adaptor to 1 µg/ml.
2. Prepare at least 2 µg of double-stranded cDNA from cytoplasmic polyadenylated RNA by random priming (please see Protocol 1).
3. Prepare the following ligation reaction in a sterile 0.5-ml microfuge tube:

double-stranded blunt-ended cDNA (Step 2)	2 µg
oligonucleotide amplification cassette mixture at 1 µg/µl, from Step 1	3 µl
10x T4 DNA ligase buffer	3 µl
10 mM ATP	3 µl
T4 DNA ligase at 1 unit/µl	3 µl
H <sub>2</sub> O	to 30 µl

Incubate the ligation for 16 hours at 14°C. Inactivate the T4 DNA ligase by a 10-minute incubation at 65°C.

Adding ATP as a component of the 10x ligation buffer leaves more volume for vector or foreign DNA in the reaction mixture. If using a commercial ligase buffer that contains ATP, the addition of ATP is no longer required.

4. Purify the products of the ligation reaction by phenol:chloroform extraction, by spun-column chromatography through Sephadex G-50 (please see Appendix 8), and by standard ethanol precipitation. Dry the pellet and resuspend it in 10 µl TE (pH 7.6).

**Biotin Labeling of the Genomic Clones**

5. Incorporate biotinylated residues into the BAC genomic DNA clone using nick translation. Prepare the following nick translation reaction in a sterile 0.5-ml microfuge tube (label each BAC DNA separately):

purified BAC DNA (0.1 mg/ml)	1 µl
biotin-16-dUTP (0.04 mM)	1 µl
10x nick translation buffer	2 µl
dNTP mix for nick translation (0.4 mM)	1 µl
[α- <sup>32</sup> P]dCTP (3000 Ci/mmol)	1 µl
DNA polymerase/DNase I (5 units/µl)	1 µl
H <sub>2</sub> O	to 20 µl

Incubate the reaction for 2 hours at 4°C.

6. Purify the radiolabeled and biotinylated products of the nick translation reaction by spun-column chromatography through Sephadex G-50 (please see Appendix 8) and standard ethanol precipitation. Resuspend the pellet in 10 µl of TE and store it at -20°C.

**Prepare Streptavidin-coated Paramagnetic Beads**

7. In a 1.5-ml sterile microfuge tube, wash 3 mg (300  $\mu$ l) of beads with 500  $\mu$ l of streptavidin bead-binding buffer three times. Following each wash, remove the beads from the binding buffer using a magnetic separator. Resuspend the beads at a concentration of 10 mg/ml in streptavidin bead-binding buffer.
8. Test an aliquot of each labeling reaction (from Step 6) for the ability to bind to streptavidin beads. Prepare the following binding reaction in a sterile 0.5-ml microfuge tube:
 

washed streptavidin-coated beads (Step 7)	20 $\mu$ l
labeled genomic DNA contig* (Step 6)	1 $\mu$ l
streptavidin bead-binding buffer	29 $\mu$ l

\*Mix equimolar amounts of each separately labeled BAC in the contig to yield a mixture at a concentration of 10 ng/ $\mu$ l.

Incubate the reaction for 15 minutes at room temperature with occasional gentle mixing. Remove the beads from the binding buffer using a magnetic separator, and transfer the supernatant to a fresh sterile 0.5-ml microfuge tube. Use a Geiger counter or Cerenkov counter to measure the radioactivity present on the beads and in the supernatant. If the ratio of bound to free cpm is  $>8:1$ , then proceed with the selection.

If the ratio of bound to free cpm is  $<8:1$ , it is likely that the DNA was resistant to proper labeling in Step 5. Before labeling, try purifying the BAC DNA further by several rounds of extraction with phenol:chloroform and passing it through a Sephadex G-50 spun column.

**Direct cDNA Selection (Primary Selection)**

9. Block or "repeat suppress" repetitive sequences in the pool of cDNA (from Step 4) using  $C_0t1$  DNA as follows:
  - a. Prepare the following annealing reaction in a sterile 0.5-ml microfuge tube:
 

cDNA carrying linkers (Step 4)	5 $\mu$ l (1 $\mu$ g)
human genomic $C_0t1$ DNA	5 $\mu$ l (1 $\mu$ g)
  - b. Overlay the reaction mixture with light mineral oil (~50  $\mu$ l) to prevent evaporation, and denature the DNA by heating for 10 minutes at 100°C. Cool the reaction mixture to 65°C, deliver 10  $\mu$ l of 2x hybridization solution under the oil. Mix the components gently. Incubate the reaction mixture for 4 hours at 65°C.
 

If YAC DNAs are used as the genomic target, the DNA may be contaminated with host (yeast) ribosomal sequences. Block these sequences by using at least 100 ng of cDNA derived from rRNA (please see the panel on **TROUBLESHOOTING** at the end of this protocol).
10. After hybridization of the cDNA pools to the  $C_0t1$  DNA is complete, set up the primary direct selection. Deliver 5  $\mu$ l (50 ng) of biotinylated BAC DNAs from Step 6 into a fresh microfuge tube, and overlay the solution with light mineral oil (~50  $\mu$ l) to prevent evaporation. Denature the BAC DNA by heating to 100°C for 10 minutes. Cool the reaction to 65°C.
11. Prepare the following annealing reaction in a sterile 0.5-ml microfuge tube:
 

biotinylated BAC DNA from Step 10	5 $\mu$ l (50 ng)
blocked cDNA from Step 9 (1 $\mu$ g cDNA plus 1 $\mu$ g $C_0t1$ DNA)	20 $\mu$ l
2x hybridization solution	5 $\mu$ l

Mix the reagents gently, and incubate the reaction for  $>54$  hours at 65°C in a rotating hybridization oven or shaking water bath.

12. To capture and wash the genomic DNA and hybridized cDNAs, prepare the following in a sterile 1.5-ml microfuge tube:

washed streptavidin-coated beads	100 $\mu$ l
annealing reaction from Step 11	30 $\mu$ l
streptavidin bead-binding buffer	100 $\mu$ l

Incubate the mixture for 15 minutes at room temperature with occasional gentle mixing. Remove the beads from the binding buffer using a magnetic separator, and then remove and discard the supernatant. Wash the beads twice, for 15 minutes each time, in 1 ml of 1x SSC/0.1% SDS at room temperature followed by three washes, 15 minutes each, in 1 ml of 0.1x SSC/0.1% SDS at 65°C. After the final wash, transfer the beads to a fresh microfuge tube.

13. To elute the hybridizing cDNAs from the beads in Step 12:
- Add 100  $\mu$ l of 0.1 M NaOH, and incubate the reaction mixture for 10 minutes at room temperature.
  - Add 100  $\mu$ l of 1 M Tris-Cl (pH 7.5).
  - Desalt the mixture by spun-column chromatography through Sephadex G-50 (please see Appendix 8).

### Amplification of the Primary Selected cDNAs

14. Transfer three aliquots (1  $\mu$ l, 5  $\mu$ l, and 10  $\mu$ l, respectively) from the 200  $\mu$ l of eluted cDNA (Step 13) to 0.5-ml sterile amplification tubes.

15. To each tube, add the following:

primer oligo3 (10 mM)	5 $\mu$ l
10x amplification buffer	2.5 $\mu$ l
dNTP mixture for PCR (2.5 mM)	2.5 $\mu$ l
<i>Taq</i> DNA polymerase (Perkin Elmer 5 units/ $\mu$ l)	0.2 $\mu$ l
H <sub>2</sub> O	to 25 $\mu$ l

Set up two control reactions at the same time as the above test reactions. For the negative control, include all of the components listed above, but omit the template cDNA. For the second control, include 10 ng of the starting cDNA (Step 4).

16. If the thermal cycler is not fitted with a heated lid, overlay the reaction mixtures with 1 drop (~50  $\mu$ l) of light mineral oil to prevent evaporation. Alternatively, place a bead of wax into the tube if using a hot start PCR. Place the tubes in the thermocycler.
17. Amplify the nucleic acids using the denaturation, annealing, and polymerization times and temperatures listed below.

Cycle Number	Denaturation	Annealing	Polymerization
30 cycles	30 sec at 94°C	30 sec at 55°C	1 min at 72°C

These times are suitable for 25- $\mu$ l or 50- $\mu$ l reactions assembled in thin-walled 0.5-ml tubes and incubated in thermal cyclers such as the Perkin-Elmer 9600 or 9700, Master Cycler (Eppendorf), and PTC 100 (MJ Research). Times and temperatures may need to be adapted to suit other types of equipment and reaction volumes.

18. Analyze 10% of each amplification reaction on a 1% agarose gel cast and run in 0.5x TBE, including DNA markers of an appropriate size. Stain the gel with ethidium bromide or SYBR Gold to visualize the DNAs, estimate the concentration of the amplified cDNA, and determine which input cDNA concentration produces the highest yield of cDNA.  
A successful reaction should yield a visible smear of amplified cDNA fragments and may contain some distinct bands.
19. Onto a second 1% agarose gel, load the same amounts (~0.5 µg per lane) of the amplified products of each PCR, as well as the appropriate size markers. Also load 0.5 µg of randomly primed cDNA from Step 4.
20. Transfer the separated DNA species to a membrane by Southern blotting (Chapter 6, Protocol 8) and hybridize with the radiolabeled, positive control cDNA.  
The intensity of hybridization to the selected cDNA should be ~1000-fold greater than to the randomly primed cDNA (Step 4).
21. Once the positive control enrichment is confirmed, scale up the optimal amplification reaction to yield at least 1.5 µg of selected cDNAs. Extract the pooled reactions with phenol:chloroform and recover the DNA by standard ethanol precipitation. Resuspend the dried cDNA pellet in 7.5 µl of TE (200 µg/ml).

### Direct cDNA Selection (Secondary Selection)

- Carry out the secondary selection under the same conditions as the primary selection, using 1 µg of the primary selected cDNA and 50 ng of the target DNA (total length 500 kb in this example).
22. Block repetitive sequences in the primary selected cDNA as described in Step 9 (with 1 µg of cDNA being used and 0.5 µg of cDNA being held in reserve for later analysis).
  23. Set up the secondary selection as described in Steps 9 through 13.
  24. Analyze the products of the second amplification by electrophoresis through a 1% agarose gel as in Step 18, including a lane with 0.5 µg of primary cDNA (held in reserve) and a lane with 0.5 µg of the starting cDNA.
  25. Analyze the gel by Southern blotting and hybridization with the radiolabeled reporter probe as described in Step 20.  
In general, the result of this analysis should reveal a large increase in abundance of the reporter probe between the starting and primary cDNAs and a more modest (~10-fold) increase between the primary and secondary cDNAs.
  26. Once enrichment of the control is confirmed, clone the selected cDNAs into the appropriate vector(s). The restriction enzyme sites in the amplification cassette facilitate the cloning of the secondary selected cDNAs into bacteriophage or plasmid vectors.  
A useful alternative is to use one of several ligation-independent cloning systems now commercially available (e.g., the UDG system from Life Technologies or the CLONEAMP pAMP vector system from Life Technologies). If one of these alternatives is used, then use the oligo3 primer with a modified 5' extension (see manufacturers for details). For further discussion of this strategy, please see the information panel on **LIGATION-INDEPENDENT CLONING**.

#### TROUBLESHOOTING

- **Poor labeling of the genomic target with biotin** is the most common cause of failure in direct selection. It is very important not to proceed with the selection if the test binding (Step 8) fails to yield the correct ratio of bound to unbound genomic DNAs. If the DNA is resistant to labeling, it may be purified by several extractions with phenol:chloroform and passage over a Sephadex G-50 spun column.

- **High frequency of background sequences in the final cloned selected cDNAs.** These sequences usually fall into four classes.

Plasmid vector sequences can be a problem when using commercial cDNA libraries that are frequently contaminated with these "inserts." The best way to eliminate these inserts is to block the cDNA with linearized vector DNA during the selection. Blocking by the vector should be used whenever a cDNA library, rather than primary cDNA, is used in the selection.

Mitochondrial cDNA is sometimes present because the yeast mitochondrial genome is contaminating a YAC DNA preparation. This contaminant can easily be identified and discarded by screening colonies by hybridization to a mitochondrial DNA probe.

Whether or not ribosomal sequences are blocked in YAC direct selection, they tend to sneak through to the final set of clones. This contaminant can be counterscreened with an rDNA probe. A ribosomal probe can be generated by first-strand cDNA synthesis from the poly(A)<sup>-</sup> fraction of total RNA.

The final common "contaminants" are cDNAs containing repetitive sequences. Approximately 10% of mRNAs contain repetitive elements within their untranslated regions. Although repeat-containing cDNAs are usually not analyzed due to the technical problems in manipulating these clones, these clones may in fact be bone fide parts of a transcript that is encoded by the target region. Fortunately, if cDNAs synthesized by random priming are used in the selection, then another nonrepetitive part of the same transcription unit is likely to be identified. The clones containing repetitive sequences can then be identified by colony screening with labeled C<sub>0</sub>t1 DNA and then discarded.



---

**COMMERCIAL KITS FOR cDNA SYNTHESIS AND LIBRARY CONSTRUCTION**

---

Between 1975, when the first cDNA clones were isolated, and the late 1980s, when methods to generate large cDNA libraries became routine, virtually all of the advances in cDNA cloning flowed from academic laboratories. Since then, however, most of the progress in both synthesis of cDNA and establishment of cDNA libraries has come from commercial companies. Very few of these improvements have been described in the formal scientific literature. Some have been published in the house journals of commercial companies, whereas others appear in advertising and technical literature and on Web pages. However, many of the significant improvements are simply incorporated into kits marketed by commercial suppliers.

The quality and number of premade cDNA libraries available from commercial sources have increased greatly in the past few years. In addition, custom-made cDNA libraries can be synthesized to order, sometimes at a reasonable price. Consequently, fewer academic laboratories now need to generate their own cDNA libraries. Establishing such a library is a lengthy process, requiring many specialized enzymes and reagents, most of which need to be tested and optimized. Laboratories that need to generate their own cDNA libraries should therefore consider the advantages of using a commercial kit. Enzymes, buffers, reagents, and in many cases vectors and host cells are provided; each of the steps in the protocol has been optimized, a task that might otherwise require several weeks' work by an academic scientist; control mRNAs and DNAs are often provided; some of the improvements in cDNA cloning are available only in kit form; and finally, although kits are expensive, the true cost of generating a cDNA library the old-fashioned way may be far greater.

Commercial kits are now available in such number and variety (for a sampling, please see Table 11-6) that at least one of them is likely to fit the needs of a particular project. Wherever possible, choose a kit containing a versatile vector, for example, one that contains control elements for both prokaryotic and eukaryotic expression and, in the case of bacteriophage  $\lambda$ , allows the cDNA to be rescued as a plasmid or phagemid. When faced with a choice of kits produced by different companies, look on the Web to see which company provides better support if something should go wrong and try to obtain a copy of the protocol that accompanies the kit (many of these are available on the Web). Read the protocol thoroughly to ensure that the individual steps make sense and are described and explained in sufficient detail. Pay particular attention to the troubleshooting section of the technical literature because it often gives clues to places in the protocol that might prove difficult. See if individual components of the kit can be replaced as they are used up. Check carefully to determine which items are provided in the kit and which are the responsibility of the investigator to provide. Do not order the kit until all of the necessary solutions and materials have been prepared locally and, if possible, tested.

TABLE 11-6 Commercial Kits for cDNA Synthesis and Library Construction

MANUFACTURER	WEB SITE ADDRESS	KITS	3' PRIMER	COMMENTS (REVERSE TRANSCRIPTASE, VECTORS)
Amersham-Pharmacia Biotech	www.apbiotech.com	cDNA Synthesis Kit	Oligo(dT)	Mo-MLV λExCell
		TimeSaver cDNA Synthesis Kit	Oligo(dT) <sub>12-18</sub> Random Primer (pd[N]6)	Mo-MLV λgt11
		cDNA Synthesis Module	Anchored dT <sub>25</sub> Primer Random primer	AMV λgt10, λgt11 (classical method of Gubler-Hoffman)
CLONTECH	www.clontech.com	SMART cDNA Synthesis Kit	CDS II Primer 5' PCR Primer	RT not specified
		SMART cDNA Library Construction Kit	CDS III Primer	RT not specified λTriplEx2
		SMART RACE cDNA Amplification Kit	5', 3' RACE cDNA Synthesis Primers	RT not specified
Invitrogen	www.invitrogen.com	Copy Kit (cDNA synthesis)	Oligo(dT)/(NotI) Primer Random Primer	AMV
Life Technologies	www.lifetech.com	cDNA Synthesis System	Oligo(dT) <sub>12-18</sub>	Cloned Mo-MLV (classical method of Gubler-Hoffman)
		SuperScript Choice System for cDNA synthesis	Oligo(dT) <sub>12-18</sub> and/or Random hexamers (R6)	SuperScript II (RNase H <sup>-</sup> )
		SuperScript Plasmid or Lambda System for cDNA Synthesis		SuperScript II (RNase H <sup>-</sup> ) pCMV-SPORT or λZipLox Expression libraries pSPORT1
Novagen	www.novagen.com	Premade SuperScript Libraries		
Novagen	www.novagen.com	SuperScript Lambda-System for cDNA Synthesis	NotI Primer-Adaptor	Mo-MLV (classical method of Gubler-Hoffman)
Promega	www.promega.com	OrientExpress cDNA Synthesis Kit	Oligo(dT) or HindIII Random Primer	AMV (classical method of Gubler-Hoffman)
Roche Diagnostics		Universal RiboClone cDNA Synthesis System	Oligo(dT) Primer Random(dN) <sub>6</sub> Primer	AMV (classical method of Gubler-Hoffman)
		cDNA Synthesis Kit	Oligo(dT) <sub>15</sub> -Primer Random(dN) <sub>6</sub> -Primer	AMV
Stratagene	www.stratagene.com	cDNA Synthesis Kit	Oligo(dT)-Linker-Primer	Mo-MLV
		λZAP-CMV Library Construction Kits	Oligo(dT)-Linker-Primer and/or Random Primer	Mo-MLV λZAP-CMV High-level eukaryotic expression
		ZAP Express cDNA Synthesis Kits	Random or Oligo(dT) Primers	Mo-MLV Eukaryotic and prokaryotic expression
		ZAP cDNA Synthesis Kits	Random or Oligo(dT) Primers	Mo-MLV Prokaryotic expression
		Plasmid Library Construction Kits	Random or Oligo(dT) Primers	Mo-MLV pCMV-script pBluescript II PAD-GAL4-2.1
		Premade cDNA libraries	Oligo(dT) and/or Random Primer	λ vectors (ZAP, ZAPII, Uni-ZAP)
Takara/BioWhittaker		cDNA Synthesis Kit	Oligo(dT) <sub>18</sub> Random(dN) <sub>9</sub>	RAV-2 (classical method of Gubler-Hoffman)

## Mo-MLV REVERSE TRANSCRIPTASE

Early work on copying mammalian mRNA into DNA (Kacian et al. 1972; Ross et al. 1972; Verma et al. 1972), which predated cDNA cloning by several years, used reverse transcriptase extracted from particles of avian myeloblastosis virus (AMV). Throughout the 1970s, Dr. J.W. Beard of the University of Florida was contracted by the National Cancer Institute to supply AMV particles harvested from the blood of leukemic chickens, and later, reverse transcriptase prepared from the virus particles, to the research community in the United States. This work was beyond the reach of most laboratories since it involved infecting day-old male chicks with AMV and processing large volumes of chick blood. Beard's skill and hard work provided the foundation for synthesis and cloning of cDNAs as well as the means to purify the enzyme to homogeneity and to define its chief biochemical features. However, it was not until 1988 that the cDNAs encoding the two chains of avian reverse transcriptase were cloned, independently expressed in *E. coli* (Soltis and Skalka 1988; Terry et al. 1988), and marketed commercially. Perhaps because the active enzyme consisted of several monomeric and heterodimeric forms (for review, please see Skalka 1993), the quality of these early recombinant preparations varied quite dramatically from one manufacturer to another. In addition, the powerful RNase H activity associated with both subunits of the enzyme was a liability when using avian reverse transcriptase to copy populations of mRNA into full-length double-stranded cDNAs. Yields of cDNA rarely exceeded 50%, probably because the hybrid formed between the oligo(dT) primer and the 3'-terminal poly(A) tract of the mRNA template was efficiently degraded by the endogenous RNase H activity of the avian enzyme. In addition, the endonucleolytic and exonucleolytic degradation of the RNA moiety of the hybrid between the first-strand cDNA and the mRNA increased the difficulty of synthesizing and cloning double-stranded cDNA copies of long mRNAs.

In 1985, cDNA encoding the reverse transcriptase of the Moloney strain of murine leukemia virus (Mo-MLV) was cloned and expressed in an enzymatically active form in *E. coli* (Kotewicz et al. 1985; Roth et al. 1985). The enzyme has been expressed both as a fusion protein with the bacterial gene *trpE* product (Tanese et al. 1985) and the bacteriophage  $\lambda$ cII (Hu et al. 1986) and in a form where the amino terminus of the protein more closely resembles that of the authentic enzyme (Hizi and Hughes 1988; Kotewicz et al. 1988). Most, if not all, of the commercially available enzyme preparations are from genes encoded by plasmid pB6B15.23 (Roth et al. 1985) or pRT601 (Kotewicz et al. 1985; Gerard et al. 1986). The specific activities of the enzymes encoded by these plasmids differ by a factor of  $\sim 10$ , with the reverse transcriptase encoded by pRT601 being the greater. On the face of it, this may seem to be an advantage. However, maximum yields of cDNA are obtained with both enzymes when the molar ratio of reverse transcriptase to mRNA is  $\sim 5$ . Since all manufacturers of the enzyme use the same units of activity,  $\sim 10$  times as many units of the enzyme encoded by pRT601 are required to obtain equal efficiency of copying of mRNA into cDNA (Gerard and D'Alessio 1993).

Mo-MLV reverse transcriptase contains two independently functional, nonoverlapping domains (Tanese et al. 1985; Tanese and Goff 1988; for review, please see Prasad 1993). The larger amino-terminal domain ( $\sim 450$  residues) contains the DNA polymerase activity, whereas the RNase H activity is encompassed within the carboxy-terminal domain ( $\sim 220$  residues). The DNA polymerase is rather sluggish and prone to pausing at regions of the RNA template rich in secondary structure (Matson et al. 1980; Gerard et al. 1989). In addition, the RNase H activity has the capacity to hydrolyze the RNA template near the point of chain growth, which can result in dissociation of the DNA-RNA hybrid and termination of the first-strand cDNA. Up to 50% of the first-strand cDNA molecules initiated by Mo-MLV reverse transcriptase may be prematurely terminated by one or the other of these mechanisms (Berger et al. 1983).

Solving the three-dimensional structure of Mo-MLV reverse transcriptase in the early 1990s (Arnold et al. 1992; Kohlstaedt et al. 1992; Georgiadis et al. 1995) was an important step forward since it opened the way to rational genetic engineering of the enzyme. However, by then, one of the chief problems had already been solved by the creation of a mutant of Mo-MLV that retained DNA polymerase activity but lacked RNase H activity (Kotewicz et al. 1988). Surprisingly, inactivation of the RNase H domain by deletion or point mutation led to a dramatic increase in the ability of the enzyme to catalyze the synthesis of cDNA at elevated temperature (Gerard et al. 1989, 1992). Until this serendipitous discovery, Mo-MLV had been used at temperatures no greater than 42°C. However, certain mutants of Mo-MLV deficient in RNase H can efficiently catalyze the synthesis of cDNA at temperatures as high as 50°C (Gerard et al. 1989, 1992), whereas RNase H<sup>-</sup> forms of the avian enzyme can be safely used at 60°C (for review, please see Gerard 1998).

The elimination of the RNase H activity from reverse transcriptase increases the ability of the enzyme to generate full-length cDNA molecules at standard temperatures. Various commercially marketed forms of this variant include a mutant of Mo-MLV reverse transcriptase that lacks RNase H activity expressed from a modified version of pRT601 encoding 497 residues of Mo-MLV reverse transcriptase plus five additional residues at the carboxyl terminus. Other commercial forms of Mo-MLV reverse transcriptase lacking RNase H activity include StrataScript RT from Stratagene, SuperScript and SuperScript II from Life Technologies, and two versions from Promega. SuperScript carries a deletion that eliminates RNase H activity, and the Stratagene enzyme SuperScript II and an enzyme from Promega are point mutants.

---

## HOMOPOLYMERIC TAILING

---

Until 1981, most cDNAs were cloned by adding complementary homopolymeric tracts to the double-stranded cDNA and to a plasmid vector. The vector and the double-stranded cDNA were then joined by hydrogen bonding between the complementary homopolymers to form open circular hybrid molecules capable of transforming *E. coli*. Although it was used with success for many years, cloning of homopolymerically tailed cDNAs into homopolymerically tailed vectors suffers from several of the following drawbacks and is no longer used with any regularity.

- The method can be used effectively only with plasmid vectors, which yield cDNA libraries that are much more difficult to store and replicate than those constructed in bacteriophage  $\lambda$  vectors.
- For optimal efficiency of cloning, the number of homopolymeric residues on the plasmid and the cDNA should be approximately equal, with ~100 dA:dT residues or 20 dC:dG residues being added to each end of the DNAs (Peacock et al. 1981). However, the addition of dNTPs often proceeds asynchronously, so that different termini of DNA molecules carry homopolymeric tails of very different lengths. This problem can be alleviated, but not completely solved, by using plasmids carrying homopolymeric tails of defined size, which are available from a number of commercial suppliers.
- Different strains of *E. coli* are transformed at different efficiencies with plasmid:cDNA molecules that are held together by complementary homopolymeric tails. For example, *E. coli* strain RR1, which is *recA*<sup>+</sup>, yields ten times as many recombinant cDNA clones made by the dA:dT tailing procedure than the *recA*<sup>-</sup> strain HB101 (Peacock et al. 1981). Untreated plasmid DNA transforms the two strains at equal efficiency. These results indicate that the bacterial RecA system may be involved in repairing open circular hybrid DNA molecules that contain homopolymeric tails. Whether other bacterial genes are involved is unknown. However, the fact that the genetic background of the recipient strain of *E. coli* can markedly influence the efficiency of transformation by DNA molecules containing unligated homopolymeric tails raises the possibility of systematic selection for or against specific classes of plasmid-cDNA hybrids.

Homopolymeric tailing capitalized on the ability of calf thymus terminal transferase to catalyze the addition of dNTPs to the 3'-hydroxyl termini of single- or double-stranded DNA. It was first used by Wensink et al. (1974) to introduce recombinant DNA into *E. coli* by pairing between dA:dT homopolymers (Jackson et al. 1972; Lobban and Kaiser 1973). In the original procedure, a small number of nucleotides were removed from the 5' termini of the double-stranded DNAs to leave protruding single-stranded 3'-hydroxyl termini, which served as efficient templates for terminal transferase. The need for this step was obviated when it was shown that terminal transferase could utilize recessed 3' termini in the presence of cobalt ions (Roychoudhury et al. 1976). Usually, between 50 and 150 dA residues were added to the linearized vector DNA, and a corresponding number of dT residues were added to the double-stranded cDNA. However, homopolymeric dA:dT tailing was used only rarely for cDNA cloning, chiefly because there was no satisfactory way to excise cDNA inserted into plasmids by dA:dT tailing. The methods described in the literature (Hofstetter et al. 1976; Goff and Berg 1978) are inefficient and not routinely reproducible. For many years, therefore, almost all cloning of cDNA was carried out by homopolymeric dC:dG tailing: dC residues were added to the double-stranded cDNA, and complementary dG residues were added to a plasmid vector that had been digested with *Pst*I (Villa-Komaroff et al. 1978; Rowekamp and Firtel 1980). This enzyme creates protruding 3' termini that are ideal substrates for addition of homopolymeric tails. cDNA

clones carrying dC:dG tails can easily be removed from the plasmid vector because the addition of a short stretch of dG residues to the linearized plasmid DNA results in regeneration of a *Pst*I site at each end of the dC-tailed insert. In practice, the efficiency of regeneration of the *Pst*I site depends on the quality of the restriction enzyme used to linearize the plasmid and on the quality of the terminal transferase. Contamination of either enzyme preparation with exonuclease or single-strand-specific nuclease prevents regeneration of the site.

A variation of this strategy is to insert the double-stranded cDNA into a site that is closely flanked by two hexanucleotide restriction sites. In pUC18, for example, the *Pst*I site is flanked by *Sa*II and *Sph*I sites, which occur only rarely in mammalian DNA. In most cases, cDNAs inserted into the *Pst*I site by homopolymeric tailing can be recovered intact by cleavage with *Sa*II and *Sph*I.

---

## **$\lambda$ gt10 AND $\lambda$ gt11**

---

Bacteriophage  $\lambda$ gt10 (Young and Davis 1983a) is a member of a family of immunity insertion vectors (Murray et al. 1977) designed to accept foreign segments of DNA in the region of the bacteriophage genome that encodes the repressor (*cI*) gene (please see map of  $\lambda$ gt10 in Appendix 3). These vectors carry a functional *cI* gene and, like wild-type bacteriophage  $\lambda$ , form turbid plaques on most strains of *E. coli*.  $\lambda$ gt10 DNA contains a single *Eco*RI cleavage site located within the coding region of the *cI* gene into which DNA fragments can be inserted. Insertion causes the *cI* gene to be inactivated, generating recombinant *cI*<sup>-</sup> bacteriophages that give rise to clear plaques which are readily distinguishable from the turbid plaques formed by the parental (i.e., nonrecombinant)  $\lambda$ gt10.

Parental  $\lambda$ gt10 DNA is ~43 kb in length and thus can accept inserts of foreign DNA up to 7.6 kb in length. However, the vector does not require a fragment of foreign DNA to be inserted to generate a genome of packageable size. Thus, cDNA libraries constructed in  $\lambda$ gt10 always consist of a mixture of nonrecombinant and recombinant bacteriophages. These two types of bacteriophages can be distinguished phenotypically by their ability to form clear (recombinant) or turbid (nonrecombinant) plaques. More importantly, however, the proportion of recombinants in these libraries can be greatly increased by plating on a strain of *E. coli* that carries an *hfl* mutation. The *cII* gene of bacteriophage  $\lambda$  is a positive activator of synthesis of *cI*. The stability of the *cII* gene product is controlled by the products of the host *hflA* gene and the *cIII* gene of the bacteriophage. Mutation of the *hflA* gene enhances the stability of the *cII* gene product, resulting in an increased production of the *cI* gene product and a high frequency of lysogenization. The growth of parental bacteriophages that carry an intact *cI* gene is therefore suppressed on strains of *E. coli* that carry an *hfl*<sup>-</sup> mutation. By contrast, the growth of recombinant bacteriophages that cannot synthesize an active *cI* gene product is not inhibited (for a discussion of the interactions of the *cI*, *cII*, *cIII*, and *hflA* gene products, please see Hoyt et al. [1982] and for a method to plate bacteriophage  $\lambda$ gt10, please see Chapter 2).

$\lambda$ gt11 (Young and Davis 1983a,b, 1991) is an expression vector that carries a copy of the *E. coli lacZ* gene, with a single *Eco*RI cleavage site located 53 bp upstream of the translational termination codon of the *lacZ* gene (please see the map of  $\lambda$ gt11 in Appendix 3). Approximately 7.2 kb of foreign DNA can be accommodated at this site. Coding sequences inserted in the correct reading frame and orientation will be expressed to yield fusion proteins whose amino termini consist of  $\beta$ -galactosidase sequences and whose carboxyl termini consist of a foreign polypeptide. Some of these fusion proteins will display antigenic or ligand-binding epitopes that can be detected by their ability to react with specific antibodies or other ligands.

Libraries constructed in  $\lambda$ gt11, like those constructed in  $\lambda$ gt10, can be screened with nucleic acid probes. However, libraries constructed in  $\lambda$ gt10 are far better suited for this purpose. An efficient method is available to select against nonrecombinant  $\lambda$ gt10 bacteriophages (please see above), and both the parental and recombinant  $\lambda$ gt10 bacteriophages grow to higher titer than  $\lambda$ gt11 and its derivatives. Furthermore, during amplification of libraries constructed in  $\lambda$ gt11, some recombinants may express low levels of fusion proteins that either are toxic to the host cell or suppress growth of the infecting bacteriophage. Passage of cDNA libraries constructed in  $\lambda$ gt11 can therefore result in loss of some classes of recombinants and selective amplification of others. For these reasons,  $\lambda$ gt11 should be used to construct cDNA libraries that will be screened only with immunological or double-stranded DNA-binding site probes.

---

**CONSTRUCTING cDNA LIBRARIES FROM SMALL NUMBERS OF CELLS**


---

Mammalian tissues contain different cell types, none of which express exactly the same sets of genes. cDNA libraries established from tissues therefore consist of a melange of sequences, some common to all cells, others unique to a particular population. mRNAs can sometimes be extracted from homogeneous populations of cells obtained by microdissection of fixed tissues, harvesting of oocytes, sorting of cells with specific surface properties, or individual colonies of specific types of differentiated cells. A somatic diploid mammalian cell contains  $\sim 10^6$  mRNA molecules (1 pg), whereas a mammalian oocyte contains 7–35-fold more. The scarcity of the starting material therefore demands that special techniques and precautions be required to establish cDNA libraries of useful size. The chance of establishing a fruitful library is increased by the following:

- **Use freshly harvested material and extract the RNA immediately.** A less desirable alternative involves storing the cells or tissue at  $-70^\circ\text{C}$  in lysis buffer containing an inhibitor of RNase until sufficient material has been harvested.
- **Use a scaled-down version of standard protocols to isolate the RNA** (e.g., please see Belyavsky et al. 1989; Weng et al. 1989; Brady et al. 1990; Hahnel et al. 1990; Revel et al. 1995).
- **Use carriers to reduce loss of material onto surfaces and to improve the efficiency and speed of precipitation of the mRNA with ethanol.** Recommended carriers (McCarrey and Williams 1994) include tRNA, poly(I), and poly(I:C). Be aware, however, that using a carrier may decrease the fraction of DNA clones in the library that correspond to the target mRNA population.
- **Use total RNA rather than poly(A)<sup>+</sup> mRNA as a template for first-strand cDNA synthesis.** Most methods used to purify small amounts of poly(A)<sup>+</sup> RNA result in significant loss of material on surfaces and yield preparations that are too dilute to allow the mRNA to be recovered efficiently. The use of total mRNA as template means that synthesis of first-strand cDNA must be primed by oligo(dT) rather than random primers (Domecq et al. 1990; Urven et al. 1993). Oligo(dT) priming can be carried out in solution or by using oligo(dT) tethered to paramagnetic beads (Lambert and Williamson 1993).
- **Use a single buffer for synthesis of first-strand cDNA, second-strand cDNA, and addition of linkers or homopolymeric tails** (Brady et al. 1990; Don et al. 1993; Aatsinki et al. 1994).
- **Use PCR to amplify either first-strand or double-stranded cDNA** (e.g., please see Belyavsky et al. 1989; Brady et al. 1990; Ennis et al. 1990; McCarrey and Williams 1994; Revel et al. 1995). To provide binding sites for oligonucleotide primers, the 3' terminus of first-strand cDNA is modified by addition of a homopolymer tail (Belyavsky et al. 1989). Alternatively, both termini of blunt-ended double-stranded cDNA can be modified by addition of linkers, 18–20 bp in length (Tam et al. 1989; Don et al. 1993). First-strand cDNA can then be amplified using primers complementary to the poly(dT) tract at the 3' end and the homopolymer tail (usually oligo[dG]) at the 5' end. Double-stranded cDNA can be amplified using primers complementary to the linkers. In each case, long extension times improve the yield of clones containing cDNAs >2 kb in length (Domecq et al. 1990; Seeber et al. 1993; Aatsinki 1997). cDNA libraries have been established by PCR methods from as few as ten oocytes and by modified versions of conventional cloning from  $10^5$  somatic mammalian cells.
- **Omit the methylation step in the interest of streamlining the procedure and maximizing the size of the cDNA library** (McDonnell et al. 1987; Don et al. 1993). The double-stranded cDNA can be prepared for ligation to the vector by addition of adaptors or by using linkers containing recognition sites (such as NotI) that are rarely found in cDNAs.
- **Use column chromatography rather than gel electrophoresis to fractionate the cDNAs according to size** (Weng et al. 1989; Urven et al. 1993).
- **Use pilot reactions to ascertain the optimum ratio of cDNA to vector in the ligation reactions.**

When potent packaging mixtures became commercially available, bacteriophage  $\lambda$  vectors were preferred to plasmids for establishment and propagation of cDNA libraries constructed from limiting amounts of material. However, since the development of strains of *E. coli* that can be efficiently transformed by electroporation, construction of cDNA libraries in plasmid vectors is once again a viable option (Gruber 1995). Libraries constructed in bacteriophage  $\lambda$  are easier to maintain, amplify, and screen; on the other hand, plasmids are available in greater variety and may be the vectors of choice when the library, or individual cDNA clones, are to be used for transfection of mammalian cells.

---

**IN VITRO PACKAGING**

---

Packaging of bacteriophage  $\lambda$  DNA in vitro was initially developed by Becker and Gold (1975) using mixtures of extracts prepared from bacteria infected with strains of bacteriophage  $\lambda$  carrying mutations in genes required for the assembly of bacteriophage particles. The procedure has been modified and improved to the point where  $2 \times 10^9$  pfu can be generated routinely in packaging reactions containing 1.0  $\mu$ g of intact bacteriophage  $\lambda$  DNA. This high efficiency of packaging, coupled with the development of a large stable of bacteriophage  $\lambda$  vectors and the ability to screen libraries by hybridization or immunochemical methods, led to the dominance of these vectors in cDNA library construction in the 1980s. The increased use of bacteriophage  $\lambda$  as a cloning vector also led to the development of commercial packaging reactions. Today, the preparation of packaging reactions as described in the Second Edition of this manual is almost a lost art, even in the laboratories of experienced bacteriophage investigators. Commercial packaging reactions work exceedingly well and are so reasonably priced that they have replaced home-made extracts in most routine cloning tasks. However, for specialized applications such as the construction of linking and jumping genomic DNA libraries (which use huge numbers of packaging reactions), it is worth taking the time to prepare home-brewed packaging extracts (Poustka 1993). Packaging extracts are prepared by one of two general strategies:

- Expression of bacteriophage  $\lambda$  genes is induced in two separate lysogens that provide complementing components of the packaging reaction (e.g., please see Scalenghe et al. 1981). As a consequence of mutations in the prophage genomes, neither lysogen alone is capable of packaging exogenously added bacteriophage DNA. Extracts of each culture are prepared separately and blended at the bench into a mixture that contains all of the components necessary for packaging. The resulting packaging mixtures are efficient, typically yielding in excess of  $10^9$  pfu/ $\mu$ g of bacteriophage  $\lambda$  DNA and essentially free from background (when assayed on appropriate host strains). Examples of commercially available, two-component systems are Gigapack II Gold (Stratagene), and the  $\lambda$  packaging system available from Life Technologies.
- A single *E. coli* C bacteriophage  $\lambda$  lysogen is used to prepare an extract that contains all of the components necessary to package exogenously added viral DNA (Rosenberg 1987). One lysogen can be used to prepare packaging extracts for two reasons. First, the prophage carried in the lysogenic strain encodes all of the proteins needed for packaging. Second, the *cos* site of the prophage has been deleted. These features work together in the following manner. Induction of the lysogen results in the intracellular accumulation of all protein components needed for packaging, and complete preheads are formed. However, the next steps in the packaging process are the recognition of the *cos* sites on concatenated bacteriophage  $\lambda$  DNA by the bacteriophage A protein and the insertion of the bacteriophage  $\lambda$  genome into the prehead. The lack of the *cos* site in the prophage DNA prevents this step from occurring, and packaging is thus effectively halted at the prehead stage, even though all necessary components that are used later in the process are present. However, exogenous DNA with an active *cos* site can be inserted into the prehead, and the packaging process then leads to the production of an infectious bacteriophage particle. Extracts made in this way usually have a lower background of plaques than the classical binary mixtures, because the deletion of the *cos* site blocks packaging of endogenous bacteriophage  $\lambda$  DNA more completely than do the mutations present in the binary strains. *E. coli* C was chosen as the lysogenic host to lessen the probability of recombination between cryptic bacteriophage  $\lambda$  prophages, which are known to be present in the genome of *E. coli* K, and the *cos*-deleted prophage. Furthermore, *E. coli* C lacks the *EcoK* restriction system (Rosenberg 1985). This system, like other restriction systems, cuts unmodified DNA in a sequence-specific manner and is also functional in packaging reactions in vitro. Thus, extracts prepared from cells of *E. coli* K have the potential to select against DNA that contains an unmodified *EcoK* recognition site. Because eukaryotic DNA used to construct libraries will not be protected from cleavage, clones that by chance contain an *EcoK* recognition site may be lost from the population during packaging. Reconstruction experiments show that bacteriophage  $\lambda$  DNA carrying an *EcoK* recognition site is packaged two- to sevenfold less efficiently in extracts derived from *E. coli* K than in extracts prepared from *E. coli* C (Rosenberg 1985).

*E. coli* C encodes restriction-modification systems that contain components (*mcrA/mcrB* and *mrr*) that digest DNA carrying methyl groups on cytosine and adenine residues (e.g., please see Kretz et al. 1989;

Kohler et al. 1990). Because most eukaryotic DNAs are methylated on these residues, packaging extracts from strains of *E. coli* carrying intact *mcr* and *mrr* systems select against methylated eukaryotic DNA sequences. However, the use of packaging extracts prepared from bacterial cells deficient in the *EcoK*, *mcr*, and *mrr* genes (genotype  $\Delta[mrr\text{-}hsdRMS\text{-}mcrB]$ ) effectively eliminates this problem (Kretz et al. 1989). For good measure, the *mcrF*- and *mrr*-encoded restriction systems have also been eliminated from the *E. coli* strains used to prepare some commercially available in vitro packaging extracts. Examples of single component bacteriophage  $\lambda$  packaging extracts that are commercially available are the Gigapack III Gold (Stratagene), the MaxPlax packaging extract from Epicentre Technologies, and the Packagene extract from Promega.

---

## COS CELLS

---

COS cells are a stable line of African green monkey kidney cells that carry integrated copies of the SV40 genome and constitutively express biochemically active, SV40-encoded large T antigen. Because large T antigen is the only virally encoded product required to activate the SV40 origin of DNA replication, COS cells are able to support the replication of any plasmid that contains an intact SV40 origin. Transfection of COS cells with recombinant plasmids containing an SV40 origin and a functional transcription unit leads to efficient amplification of the transfecting DNA and an enhanced level of transient expression of the cloned DNA segment. Since their construction in 1980, COS cells have proven to be invaluable for studying different aspects of eukaryotic gene regulation, for expressing cloned genes in sufficient quantity for biochemical analysis, for analyzing the intracellular transport and properties of wild-type and mutant proteins, and for cloning cDNAs for which no protein sequences are available.

COS cells did not arise by accident but were the result of several years of steady effort by Yasha Gluzman to develop a line of SV40-transformed cells that were permissive to superinfection by SV40. In the mid 1970s, when he was a graduate student at the Weizmann Institute, Gluzman exposed simian cells to UV-irradiated SV40 and isolated three lines of morphological transformants that were fully permissive to superinfection by wild-type SV40 (Gluzman et al. 1977). Unfortunately, none of the cell lines could support the replication of SV40 mutants that expressed defective T antigen. Several years later, Gluzman showed that the cells that had been transformed by SV40 had acquired a mutation affecting a function required for viral DNA synthesis (Manos and Gluzman 1985).

When he went to Cold Spring Harbor Laboratory as a postdoctoral fellow, Gluzman decided to try again — this time using mutants of SV40 (Gluzman et al. 1980a,b) that carried a defective origin of replication but expressed wild-type T antigen. He isolated three lines of transformed simian (CV-1) cells that were completely permissive for lytic growth of SV40 and could support the replication of both temperature-sensitive and deletion mutants of T antigen (Gluzman 1981). These cells were called COS-1, COS-3, and COS-7, COS being an acronym for CV-1 origin, SV40. Gluzman thought of seeking a patent but was advised that COS cells were unlikely to be of use to commercial companies. He immediately began to distribute the cells to investigators who wanted to express cloned genes from plasmids carrying an SV40 origin of replication. The first of the many papers using COS cells for this purpose was published a few months later (Mellon et al. 1981).

Two of the original three lines of COS cells (COS-1 and COS-7) are still used extensively in both commercial and academic laboratories. However, many people are confused about which line they carry. This is because Gluzman, who was born in Russia, used a flamboyant writing style in which the numeral 1 is easily confused with numeral 7. Many of the people who received COS-1 cells from him interpreted the label as COS-7 and vice versa. However, the two cell lines can easily be distinguished on the basis of their pattern of integration of SV40 DNA: authentic COS-7 cells contain SV40 DNA sequences integrated at several sites (Rio et al. 1985), whereas COS-1 cells contain only two integrated copies of the viral DNA (Gluzman 1981). Despite these differences, both cell lines amplify plasmids containing an SV40 origin to approximately the same extent and express genes carried on the plasmids with approximately equal efficiency.



## BIOTIN

Biotin (vitamin H, coenzyme R [FW = 244.31]) (please see Figure 11-21 for the chemical structure) is a water-soluble vitamin that binds with high affinity to avidin, a tetrameric basic glycoprotein, abundant in raw egg white (for review, please see Green 1975). Because each subunit of avidin can bind one biotin molecule, 1 mg of avidin can bind ~14.8  $\mu$ g of biotin. The dissociation constant of the complex is  $\sim 1.0 \times 10^{-15}$  M, which corresponds to a free energy of association of 21 kcal/mole. With such a tight association, the off-rate is extremely slow and the half-life of the complex is 200 days at pH 7.0 (Green and Toms 1973). For all practical purposes, therefore, the interaction between avidin and biotin is essentially irreversible. In addition, the avidin-biotin complex is resistant to chaotropic agents (3 M guanidine hydrochloride) and to extremes of pH and ionic strength (Green and Toms 1972).

Biotin can be attached to a variety of proteins and nucleic acids, often without altering their properties. Similarly, avidin (or streptavidin, its nonglycosylated prokaryotic equivalent) can be joined to reporter enzymes whose activity can be used to locate and/or quantitate avidin-biotin-target complexes. For example, in enzyme immunoassays, a biotinylated antibody bound to an immobilized antigen or primary antibody is often assayed by an enzyme, such as horseradish peroxidase or alkaline phosphatase, that has been coupled to avidin (Young et al. 1985; French et al. 1986). In addition, in nucleic acid hybridization, biotinylated probes can be detected by avidin-conjugated enzymes or fluorochromes. Derivatives of biotin are used to biotinylate proteins, peptides, and other molecules (for review and references, please see Wilchek and Bayer 1990). These derivatives include:

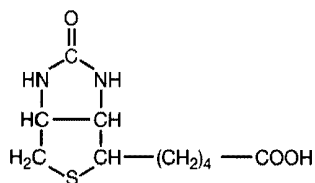
- **Various N-hydroxysuccinimide esters of biotin**, which react with free amino groups of proteins or peptides to form amides. N-hydroxysuccinimide is released as a by-product (please see Figure 11-22).
- **Photoreactivable biotin (photobiotin)**, which upon activation with a mercury vapor lamp (350 nm) reacts via an aryl nitrene intermediate and binds indiscriminantly to proteins, oligosaccharides, lipids, and nucleic acids.
- **Iodoacetyl biotin**, which reacts specifically with thiol groups, generating a stable thioether bond.
- **Biotin hydrazide**, which reacts with aldehydes generated by mild oxidation of carbohydrates.
- **Derivatives of biotin equipped with extended spacer arms** (e.g., biotinyl- $\epsilon$ -aminocaproyl-N-hydroxysuccinimide ester). These arms improve the interaction between avidin and biotinylated macromolecules.

The strength of the interaction between biotin and avidin provides a bridging system to bring molecules with no natural affinity for one another into close contact (please see Figure 11-23).

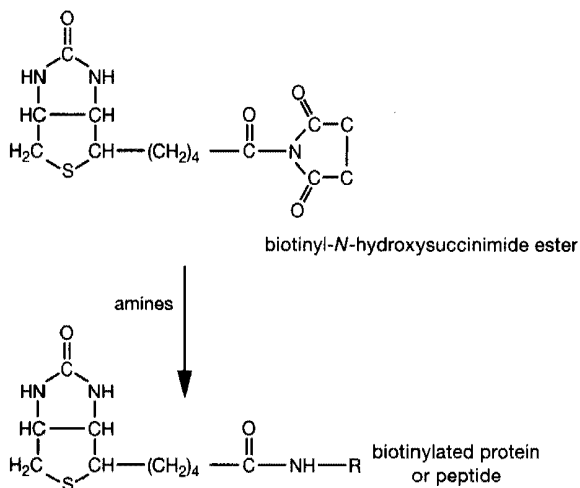
### Biotinylation of Proteins

Biotinyl-N-succinimide ester, the most commonly used agent for biotinylation of proteins, reacts with primary amine groups, which are located at the amino terminus of the protein and in lysyl side chains. Being highly charged, lysine residues are usually located on the solvent-accessible surfaces of the protein. Most of the attached biotin residues therefore decorate the outer surface of the protein, where they generally cause little disturbance to structure and function. Nevertheless, it is essential to use appropriate biological and enzymatic tests to confirm that the biotinylated protein has (1) retained its activity and (2) can bind to avidin-reporter molecules.

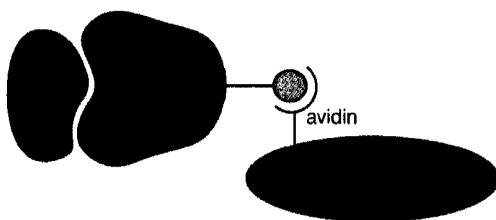
Protein biotinylation kits are available from many manufacturers, including Pierce and Life Technologies. Using the manufacturer's instructions as a guideline, optimal conditions for biotinylation can be established by setting up a series of reactions containing different ratios of biotinylating reagent and target protein. The biotin content of the resulting conjugates are assayed in an avidin/HABA assay. HABA (2-[4'-hydroxyazobenzene]) benzoic acid is a yellow dye that adsorbs strongly at 350 nm. When avidin is added to saturating concentrations of HABA, a spectral change occurs and the absorbance at 500 nm increases (Green 1975). The absorbance at 500 nm decreases with addition of biotin, which competes with HABA for binding sites on avidin. The change in absorbance at 500 nm is directly proportional to the amount of biotin in the system. The amount of biotin attached to the target protein can therefore be calculated from a standard curve constructed with known quantities of biotin (Wilchek and Bayer 1990). (The HABA system is accurate but not very sensitive. Each assay requires between 50 and 100  $\mu$ g of biotinylated conjugate at a concentration of ~1 mg/ml.)



**FIGURE 11-21 Structure of Biotin**



**FIGURE 11-22 Biotinylation of Proteins or Peptides**



**FIGURE 11-23 Avidin-Biotin Reporter Complex**

**TABLE 11-7 Biotinylation of Nucleic Acids**

METHOD	REFERENCES
Nick translation with biotinylated nucleotides	Leary et al. (1983); Shimkus et al. (1986)
Replacement synthesis using bacteriophage T4 DNA polymerase	BRL/Life Technologies (1985)
Filling of recessed 3' ends with biotinylated nucleotides	Murasugi and Wallace (1984)
3'-hydroxyl terminal addition using terminal deoxynucleotidyl transferase	Brakel and Engelhardt (1985)
In vitro transcription with biotinylated nucleotides	Weier and Rosette (1988)
PCR with biotinylated primers	Hultman et al. (1989); Uhlén (1989)
PCR with biotinylated nucleotides	Carter et al. (1992); Mertz et al. (1994)
Chemical reaction of NHS-biotin with 5'-aminoalkyl phosphoramidite DNA	Chollet and Kawashima (1985)
Photobiotinylation of DNA and RNA	Forster et al. (1985); McInnes et al. (1987)

The biotinylated protein produced in each reaction can then be checked for activity and for its ability to bind to avidin-Sepharose columns. The specificity of biotinylated antibodies and their level of nonspecific binding can be checked by dot-blots and western blots that have been "spiked" with varying quantities of the antigen.

### Biotinylation of Nucleic Acids

Biotinylated nucleotides, which are available commercially, are effective substrates for a variety of polymerases including the DNA polymerases of *E. coli*, *Thermus aquaticus*, bacteriophage T4, and the RNA polymerases of bacteriophages T3 and T7. Biotinylated nucleic acids can therefore be generated in vitro by almost all of the procedures (nick translation, end-filling PCR, random priming, and transcription) that are used to generate radiolabeled probes (please see Table 11-7). In addition, biotin adducts can be introduced into nucleic acids and oligonucleotides by a number of chemical methods, including attachment to a 5' amine group. This group is added during the final step of conventional cyanoethyl phosphoroamidite synthesis of oligonucleotides. The amino-oligonucleotide can then be labeled with commercially available biotinyl-*N*-succinimide ester.

As long as their content of biotinylated nucleotide does not exceed a few percent, the resulting probes hybridize to target sequences at approximately the same rate as unsubstituted probes. Incorporation of additional biotin residues is unlikely to increase the sensitivity of detection given that a typical avidin-linked reporter molecule (e.g., avidin-alkaline phosphatase) bound to a single biotin residue will cover between 50 and 100 nucleotides of nucleic acid.

The efficiency of detection of biotinylated probes by avidin-linked reporter systems is greatly improved if the length of the linker between the biotin moiety and the nucleotide is sufficient to overcome steric hindrance and to allow the biotinyl group to penetrate effectively into the binding sites of avidin. A number of companies sell biotinylated nucleotides with linkers containing six or more carbon atoms.

Biotin can also be introduced into nucleic acids simply by mixing photoactivatable biotin with double- or single-stranded DNA or RNA and then irradiating the mixture with visible light (350 nm) (Forster et al. 1985). The usual protocol yields a nucleic acid that contains an average of one biotin residue per 200 or so residues. Modification at this modest level certainly does not interfere with the ability of the probe to hybridize to its target and yet is sufficient to allow detection of single-copy sequences in Southern hybridization of mammalian DNA (McInnes and Symons 1989). The following are advantages of biotinylated probes.

- They can be stored for long periods of time without loss of activity.
- They need no special method of disposal.
- Signals from a biotinylated probe can be detected with a variety of avidin-reporter molecules, including those that can be detected by chemiluminescence and fluorescence. This means that a single probe can be used for a variety of different purposes (e.g., Southern blotting and in situ hybridization).
- The biotinylated nucleic acid can be recovered by affinity purification on avidin columns or on avidin-coated magnetic beads.

Note that the incorporation of bulky biotin groups reduces the electrophoretic mobility of nucleic acids. For example, each addition of biotin-14-dCTP is equivalent to increasing the mass of the nucleic acid by 1.75 cytosine residues (Mertz et al. 1994).

Despite these advantages, biotinylated probes have not displaced conventional radiolabeled probes from their preeminent position in molecular cloning. In part, this may be because the first-generation biotinylated probes were not as sensitive as claimed to be and sometimes failed the litmus test of detecting single-copy sequences in Southern hybridizations of mammalian DNA. In addition, one set of circumstances in which biotinylated probes are at a particular disadvantage is when screening for partially homologous sequences by cross-species hybridization. Here, there is a possibility that the presence of bulky biotinyl groups may lower the stability of mismatched hybrids to the point where no signal can be observed. Biotinylated probes are nevertheless likely to grow greatly in importance during the next few years as the difficulties and cost of disposal of radioactive waste increase dramatically.

Useful information about avidin-biotin chemistry and avidin-biotin techniques is available in *Methods in Enzymology* (volume 184 [ed. M. Wilchek and E.A. Bayer] 1990). In addition, Pierce Chemical Company sells a handbook (*Avidin-Biotin Chemistry: A Handbook*) that contains much practical advice.

---

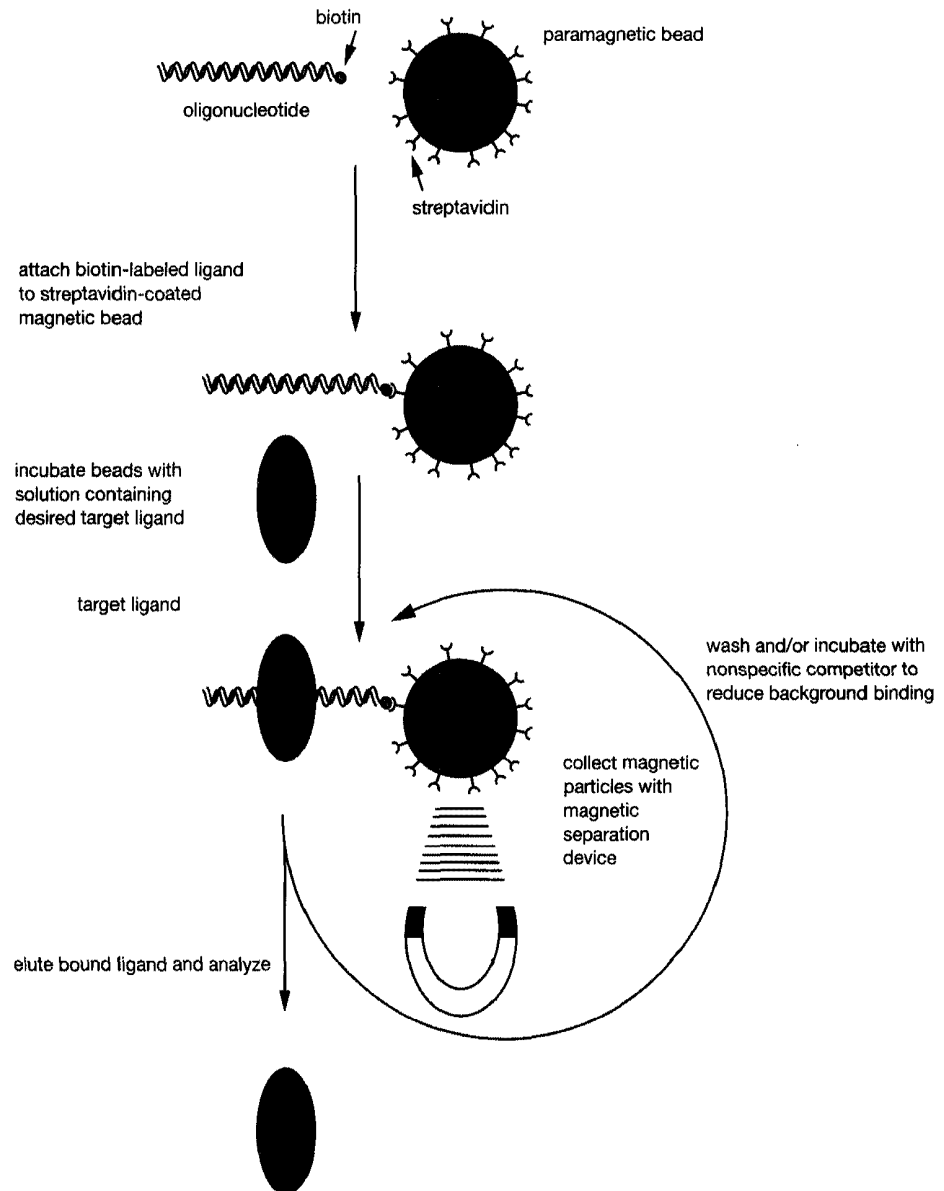
**MAGNETIC BEADS**

---

Since their introduction to molecular cloning in 1989 (Hultman et al. 1989), magnetic beads (also known as microspheres) have been used for a variety of purposes, including purification and sequencing of PCR products, construction of subtractive probes and cDNA libraries, affinity purification of DNA-binding proteins, rescue of shuttle vectors from transfected cells, and hybridization of covalently attached oligonucleotides. Although such tasks can be accomplished by more traditional techniques, these older methods are almost invariably more tedious and less efficient. Among the advantages offered by magnetic beads are speed of operation and the possibility of working at kinetic rates close to those occurring in free solution. Binding of ligand takes only a few minutes, magnetic separation takes seconds, and washing or elution can be completed in <15 minutes in most cases.

Magnetic beads are nonporous, monodisperse, superparamagnetic particles of polystyrene and divinyl benzene with a magnetite core ( $8 \pm 2 \times 10^{-3}$  cgs units) and a diameter of  $\sim 2.8 \mu\text{m}$ . Different types of beads carry different active groups on their surfaces (OH,  $\text{NH}_2$ ,  $\text{OH}[\text{NH}_2]$ , COOH, etc.), which can be used for covalent attachment of protein and nucleic acid ligands (e.g., please see Lund et al. 1988). However, most investigators prefer to purchase magnetic beads that are preloaded with covalently bound streptavidin (Lea et al. 1988), which can then be used to tether any biotin-labeled nucleic acid or protein to the surface of the bead (for review, please see Haukanes and Kvam 1993). *Note that the binding capacity varies with bead size, bead composition, and the size of the binding ligand. Different brands of beads carry different amounts of covalently attached streptavidin so that the binding capacities of beads supplied by different manufacturers are not necessarily equivalent. In addition, some brands of beads can be reused, whereas others must be discarded after a single use.* Once attached, the tethered ligand can be used for affinity capture and purification of target molecules from solution. Because the surface area of the particles is very large ( $5\text{--}8 \text{ m}^2/\text{g}$ ), streptavidin-coated beads have a very high biotin-binding capacity ( $>200 \text{ pmoles/mg}$ ). Furthermore, because of the high affinity of streptavidin for biotin ( $K_{\text{ass}} = 10^{15} \text{ M}^{-1}$ ; Wilcheck and Bayer 1988), complexes between biotin and streptavidin form very rapidly and once formed are resistant to extremes of pH, organic solvents, and many denaturing agents (Green 1975). Stringent washing does not cause leaching of tethered ligand from the surface of the bead, and enrichment factors of 100,000 can be attained during a single round of affinity capture. Perhaps the major disadvantages of magnetic beads are (1) their high cost and (2) the need for an efficient magnetic particle separator. The best of these devices contain one or more neodymium-iron-boron permanent magnets and are available in a number of formats from several commercial suppliers.

Figure 11-24 illustrates a generic procedure for affinity capture of a specific DNA-binding protein by a biotin-labeled oligonucleotide ligand tethered to magnetic beads. However, many other applications have been described, some of which are listed in Table 11-8. Further information may be found in the review by Jakobsen et al. (1994) and in the literature published by manufacturers of magnetic beads (e.g., Dynal [http://www.dynal.net/DynalWeb/DynalWeb.nsf/htmlmedia/molecular\\_biology.html](http://www.dynal.net/DynalWeb/DynalWeb.nsf/htmlmedia/molecular_biology.html)).



**FIGURE 11-24 Affinity Purification Using Magnetic Beads**

A generic approach is illustrated here for the capture of a specific target ligand, using as an example a DNA-binding protein. The biotin-labeled ligand, in this case, an oligonucleotide encoding the putative binding site for the target protein, is attached to streptavidin-coated magnetic beads and incubated in a solution containing the desired target protein. The bound particles are collected with a magnetic separation device and washed repeatedly with a solution containing a nonspecific competitor. Finally, the bound target ligand is eluted from the oligonucleotide and analyzed.

**TABLE 11-8 Affinity Capture and Purification Using Magnetic Beads**

TASK	REFERENCE
Solid-phase DNA sequencing and preparation of templates	Hultman et al. (1989, 1991); Uhlén (1989); Wahlberg et al. (1990, 1992); Bergh et al. (1991); Sylvanén et al. (1991); Théin and Hinton (1991); Hopgood et al. (1992); Kasai et al. (1992); Tong and Smith (1992); Uhlén et al. (1992); Bowman and Palumbi (1993); Debuire et al. (1993); Leren et al. (1993); Hultman and Uhlén (1994); Ohara and Ohara (1995); Wang et al. (1995)
Purification of poly(A) <sup>+</sup> RNA	Albretsen et al. (1990); Hornes and Korsnes (1990); Jakobsen et al. (1990); Karrer et al. (1995)
PCR-directed cDNA synthesis and capture	Raineri et al. (1991); Lee and Vacquier (1992); Lambert and Williamson (1993); Morgan and Kalsheker (1994); Karrer et al. (1995)
Subtractive hybridization and subtractive libraries	Rodríguez and Chader (1992); Aasheim et al. (1994); Coche et al. (1994); Sharma et al. (1994); Sagerstrom et al. (1997)
In vitro mutagenesis	Hultman et al. (1990)
Purification of transcription factors	Gabrielsen et al. (1989); Gabrielsen and Huet (1993); Ren et al. (1994); Roth and Messer (1995)
Detection of mutations by SSCP	Weidner et al. (1994)
Sequencing by hybridization	Broude et al. (1994)
Restriction mapping of cosmids	Takahashi-Fujii et al. (1994)
Quantitation of PCR products	Rhoer-Moja et al. (1993)
Plasmid rescue from transformed mammalian cells	Gossen et al. (1993)
Capture of RNAs encoded by specific genomic sequences	Morgan et al. (1992); Sedlacek et al. (1993); Tagle et al. (1993); Schoen et al. (1995); Del Mastro and Lovett (1997); Simmons and Lovett (1999)
Enrichment for specific sequences of genomic DNA by affinity capture	Abe (1992); Ito et al. (1992); Ji and Smith (1993); Sena and Zarling (1993); Ji et al. (1994); Korn et al. (1994)

## LIGATION-INDEPENDENT CLONING

Ligation-independent cloning (LIC-PCR) (also known as enzyme-free cloning) increases both the efficiency and speed of cloning of PCR products. LIC-PCR eliminates the need to ligate PCR products to a vector, does not rely on restriction sites, and avoids problems caused by extra bases that are added by the extendase activity of thermostable DNA polymerases at the 3' termini of PCR products (Clark 1988; Hu 1993). By allowing direct cloning of a PCR product into a particular site of a plasmid vector, LIC-PCR eliminates complex constructions that arise when a vector lacks suitable cloning sites, or a genetic basis for screening for recombinants (Aslandis and de Jong 1990; Haun et al. 1992; Hsiao 1993; Yang et al. 1993; Kaluz and Flint 1994). Several variants of LIC-PCR have been described:

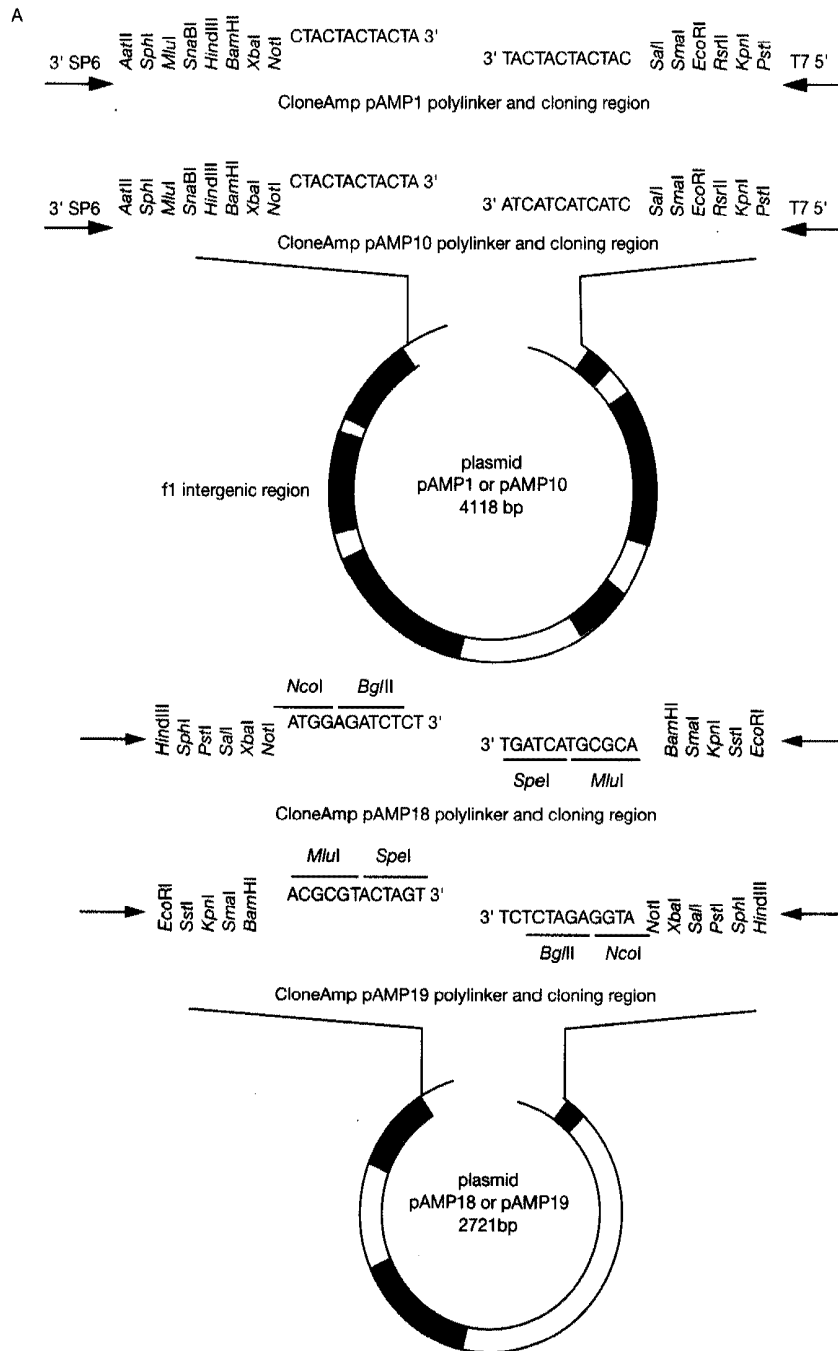
- **Amplification of the target with primers that carry at least 24 extra bases at their 5' end.** These bases correspond to sequences at the end of a linearized plasmid vector. Amplification with these primers therefore generates PCR products whose 5' ends are complementary to the 3' ends of the recipient linearized plasmid. The PCR product and the linearized plasmid are then spliced together in a second PCR which extends the overlapping complementary 3' ends (Shuldiner et al. 1990).
- **Generation of PCR products that carry 3'-protruding termini, 12 or more bases in length,** that are annealed to complementary single-stranded sequences at the 3' termini of a linearized vector. Base pairing between the two sets of protruding tails creates a chimeric molecule that can be introduced into *E. coli* by transformation (Aslandis and de Jong 1990).

Methods to generate complementary single-stranded tails at the 3' termini of the vector and the PCR product include:

- **Exonuclease resection of 3' termini.** The sequences of the vector and the PCR product are designed so that one of the four bases does not occur within the first 12 nucleotides of the end of the 3' strand. Complementary tails of defined length can therefore be produced by the 3'-5' exonuclease activity of T4 DNA polymerase in the presence of a single dNTP. The enzyme removes nucleotides in the 3'-5' direction until it reaches the first nucleotide that corresponds to the dNTP included in the reaction mix. Further exonucleolytic digestion by T4 DNA polymerase is neutralized by incorporation of the dNTP at the 3'-hydroxyl terminus of the recessed strand. After the enzyme has been inactivated by heat, the PCR product is annealed to a vector that has been prepared in a similar way (Aslandis and de Jong 1990; Haun et al. 1992). When the chimeric molecule is used to transform *E. coli*, the ligase of the bacterial cells seals the single-stranded nicks and generates a covalently closed circular molecule.

In a variation of this method, overlapping sequences are designed into the PCR primers used to amplify the target DNA and the vector. Controlled digestion of the PCR product and the vector with either exonuclease III (Hsiao 1993; Li and Evans 1997) or  $\lambda$  exonuclease is used to generate complementary protruding 3' termini (Tseng 1999). Because the overhangs created by the action of the exonucleases are slightly longer than the complementary sequence, after hybrid formation, a stretch of single-strand gap remains, which can be repaired in vivo (in the case of exonuclease III) or in vitro by the Klenow fragment of *E. coli* DNA polymerase I (in the case of  $\lambda$  exonuclease).

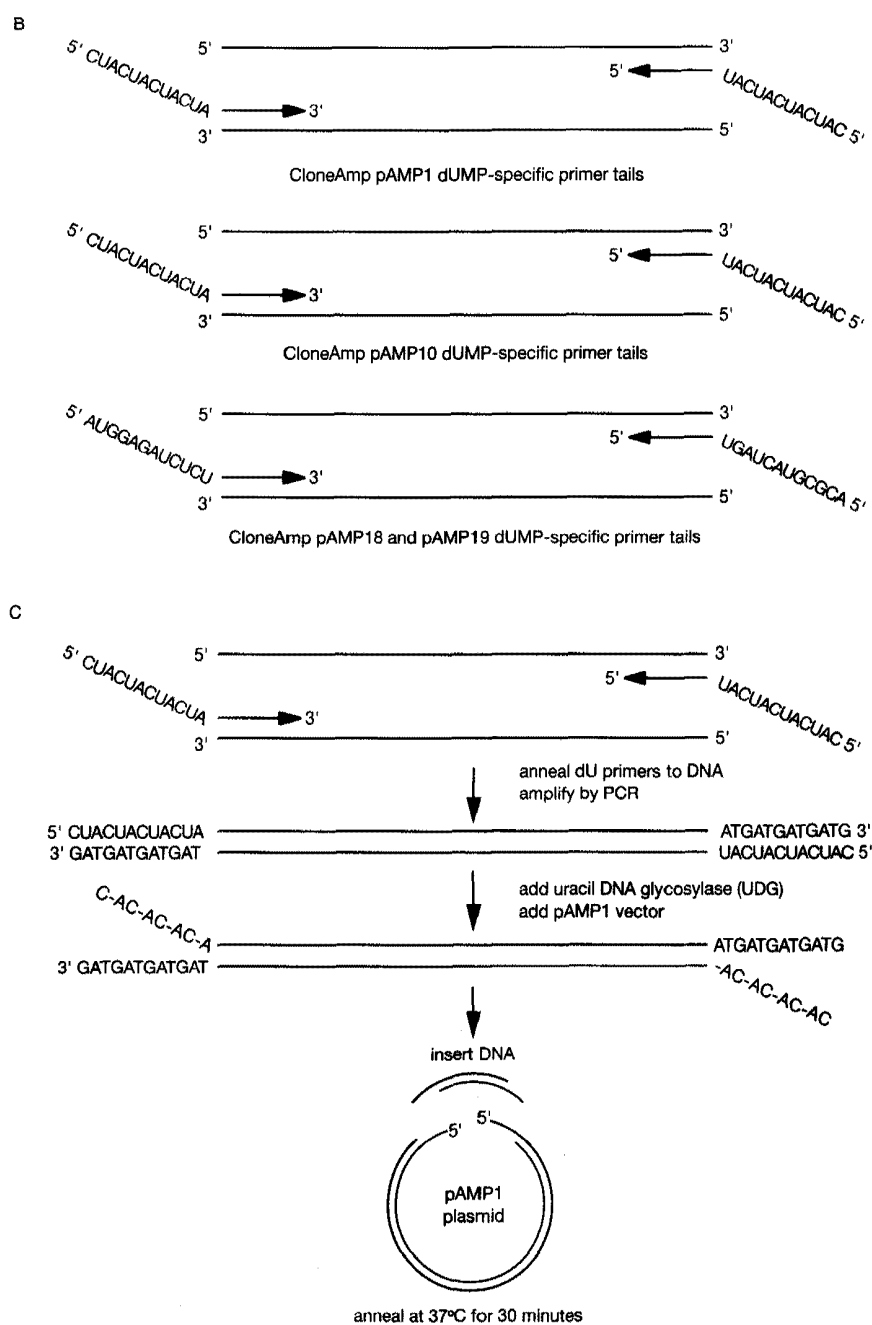
- **Uracil DNA glycosylase (UDG) cloning.** In this method, the primers used in PCR contain dUMP in their 5'-terminal regions. Digestion of the PCR products with UDG results in cleavage of the *N*-glycosidic bond between the deoxyribose residue and uracil. This cleavage generates abasic residues and destroys the base-pairing ability of the 5'-terminal sequences of the PCR products (Duncan 1981; Friedberg et al. 1981). In this method, both the vector and the insert are amplified in reactions primed by uracil-containing primers and then treated with UDG. Thus, when the insert and vector are mixed, only one strand of insert is available for annealing with the complementary strand of the vector (please see Figure 11-25) (Nisson et al. 1991; Rashtchian 1995). Several linearized vectors are commercially available (Life Technologies) that carry defined 3'-protruding termini, 12 nucleotides in length.
- **Primers containing nonbase residues** (Kaluz and Flint 1994). In this method, a nonbase residue (1,3-propanediol) is incorporated at defined positions in the oligonucleotide primers used to amplify the insert DNA. This modification does not affect the priming ability of oligonucleotides. However, during the amplification reaction, the DNA polymerase stops when it encounters the abasic site, resulting in products that carry 3'-protruding termini, 12 bp in length (please see Figure 11-26), which in this case



**FIGURE 11-25 CloneAmp pAMP Vectors and the UDG Cloning Strategy**

(A) Schematic maps of pAMP vectors. pAMP1 and pAMP10 are identical vectors except for the sequence of the single-stranded region (shown here, and described in the text) required for annealing with insert DNA. pAMP1 is for unidirectional cloning of insert DNA and pAMP10 is for bidirectional cloning. pAMP1 and pAMP10 contain a bacterial origin of replication, the ampicillin resistance gene for the selection of transformed bacteria, and the f1 intergenic region from M13 bacteriophage for the production of single-stranded DNAs. The polylinker is within the *lacZ* gene, permitting color selection of positive colonies. Vectors pAMP18 and pAMP19 are modified pUC18 and pUC19 vectors. They have a single-stranded region added in the polylinker of the original vectors for annealing to complementary PCR product inserts. The single-stranded cloning region contains the restriction endonuclease sites *NcoI* and *BglII* on one strand, and *MluI* and *SpeI* on the other strand. The two plasmids are identical except for the orientation of the polylinker region (shown here), which is inverted. The single-stranded tails are the same for both





**FIGURE 11-25 (continued)**

clones and can be used for directional cloning of an insert. The vectors contain a bacterial origin of replication and the ampicillin resistance gene for the selection of transformed bacteria. The polylinker, with in the *lacZ* gene, permits color selection of positive colonies. (B) dUMP PCR primer tails for pAMP1, pAMP10, pAMP18, and pAMP19. The sequences shown for each clone are required at the 5' end of oligonucleotide primers to be used for PCR amplification. (C) pAMP cloning protocol. PCR primers with pAMP-specific sequences at the 5' end are used to amplify DNA. PCR products are treated with UDG in the presence of a compatible pAMP vector (supplied as a linear molecule). The vector and the insert are then annealed, and the recombinant plasmid is transformed into competent bacteria. Primer-specific sequences for pAMP1 are shown in this diagram. The protocol is identical for all of the pAMP clones. (Adapted, with permission, from Life Technologies, Inc.)



**FIGURE 11-26** Generation of PCR Products Carrying Protruding 3' Termini in PCRs with Primers Containing the Nonbase 1,3-Propanediol

The location and use of primers containing the nonbase 1,3-propanediol are indicated with an X. (Modified, with permission, from Kaluz and Flint (1994 [Oxford University Press].)

are complementary to the 12-nucleotide regions flanking the *NotI* site of the Bluescript vector. The insert is annealed to a *NotI* linearized and exonuclease-III-treated vector, and the resulting chimera is used to transform *E. coli*. Abasic residues are removed and gaps are repaired by the repair machinery of bacterial cells, which results in restoration of the *NotI* site.

- **Use of multiple primers to create complementary staggered overhangs on both insert and vector by a post-PCR denaturation-hybridization reaction** (Liu 1996; Tillett and Neilan 1999). Eight sets of primers and four separate PCRs are required to generate two PCR products (target DNA and vector) that can be denatured and annealed to yield nicked circular recombinants that can be used, without further manipulation, to transform *E. coli*.

## REFERENCES

- Aasheim H.C., Deggerdal A., Smeland E.B., and Hornes E. 1994. A simple subtraction method for the isolation of cell-specific genes using magnetic monodisperse polymer particles. *BioTechniques* **16**: 716–721.
- Aatsinki J.T. 1997. Coupled one-step reverse transcription and polymerase chain reaction procedure for cloning large cDNA fragments. *Methods Mol. Biol.* **67**: 55–60.
- Aatsinki J.T., Lakkakorpi J.T., Pietila E.M., and Rajaniemi H.J. 1994. A coupled one-step reverse transcription PCR procedure for generation of full-length open reading frames. *BioTechniques* **16**: 282–288.
- Abe K. 1992. Rapid isolation of desired sequences from lone linker PCR amplified cDNA mixtures: Application to identification and recovery of expressed sequences in cloned genomic DNA. *Mamm. Genome* **2**: 252–259.
- Adams M.D., Dubnick M., Kerlavage A.R., Moreno R., Kelley J.M., Utterback T.R., Nagle J.W., Fields C., and Venter J.C. 1992. Sequence identification of 2,375 human brain genes. *Nature* **13**: 632–634.
- Albretsen C., Kalland K.H., Haukanes B.L., Havarstein L.S., and Kleppe K. 1990. Applications of magnetic beads with covalently attached oligonucleotides in hybridization: Isolation and detection of specific measles virus mRNA from a crude cell lysate. *Anal. Biochem.* **189**: 40–50.
- Alfandari D. and Darribère T. 1994. A simple PCR method for screening cDNA libraries. *PCR Methods Appl.* **4**: 46–49.
- Andersson S., Bishop R.W., and Russell D.W. 1989. Expression cloning and regulation of steroid 5 $\alpha$ -reductase, an enzyme essential for male sexual differentiation. *J. Biol. Chem.* **264**: 16249–16255.
- Andersson S., Berman D.M., Jenkins E.P., and Russell D.W. 1991. Deletion of steroid 5  $\alpha$ -reductase 2 gene in male pseudohermaphroditism. *Nature* **354**: 159–161.
- Arnold E., Jacobo-Molina A., Nanni R.G., Williams R.L., Lu X., Ding J., Clark Jr., A.D., Zhang A., Ferris A.L., Clark P., et al. 1992. Structure of HIV-1 reverse transcriptase/DNA complex at 7 Å resolution showing active site locations. *Nature* **357**: 85–89.
- Aruffo A. 1991. Expression cloning systems. *Curr. Opin. Biotechnol.* **2**: 735–741.
- Aruffo A. and Seed B. 1987. Molecular cloning of a CD28 cDNA by a high efficiency COS cell expression system. *Proc. Natl. Acad. Sci.* **84**: 8573–8577.
- Aslandis C. and de Jong J.J. 1990. Ligation-independent cloning of PCR products (LIC-PCR). *Nucleic Acids Res.* **18**: 6069–6074.
- Baltimore D. 1970. RNA-dependent DNA polymerase in virions of RNA tumour viruses. *Nature* **226**: 1209–1211.
- Bank A., Terada M., Metafora S., Dow L., and Marks P.A. 1972. In vitro synthesis of DNA components of human genes for globins. *Nat. New Biol.* **235**: 167–169.
- Bates P., Young J.A., and Varmus H.E. 1993. A receptor for subgroup A Rous sarcoma virus is related to the low density lipoprotein receptor. *Cell* **74**: 1043–1051.
- Becker A. and Gold M. 1975. Isolation of the bacteriophage lambda A-gene protein. *Proc. Natl. Acad. Sci.* **72**: 581–585.
- Bellemare G., Potvin C., and Bergeron D. 1991. High-yield method for directional cDNA library construction. *Gene* **98**: 231–235.
- Belyavsky A., Vinogradova T., and Rajewsky K. 1989. PCR-based cDNA library construction: General cDNA libraries at the level of a few cells (erratum *Nucleic Acids Res.* [1989] **17**: 5883). *Nucleic Acids Res.* **17**: 2919–2932.
- Berger S.L., Wallace D.M., Puskas R.S., and Eschenfeldt W.H. 1983. Reverse transcriptase and its associated ribonuclease H: Interplay of two enzyme activities controls the yield of single-stranded complementary deoxyribonucleic acid. *Biochemistry* **22**: 2365–2372.
- Bergh S., Hultman T., and Uhlén M. 1991. Colorimetric quantification of in vitro-amplified template DNA to be used for solid phase sequencing. *DNA Seq.* **2**: 81–87.
- Binns M.M., Boursnell M.E., Foulds I.J., and Brown T.D. 1985. The use of a random priming procedure to generate cDNA libraries of infectious bronchitis virus, a large RNA virus. *J. Virol. Methods* **11**: 265–269.
- Bowman B.H. and Palumbi S.R. 1993. Rapid production of single-stranded sequencing template from amplified DNA using magnetic beads. *Methods Enzymol.* **224**: 399–406.
- Brady G. and Iscove N.N. 1993. Construction of cDNA libraries from single cells. *Methods Enzymol.* **225**: 611–623.
- Brady G., Barbara M., and Iscove N. 1990. Representative in vitro cDNA amplification from individual hematopoietic cells and colonies. *Methods Mol. Cell. Biol.* **2**: 17–25.
- Brakel C.L. and Engelhardt D.L. 1985. Synthesis and detection of 3'-OH terminal biotin-labeled DNA probes. In *Rapid detection and identification of infectious agents* (ed. D.T. Kingsbury and S. Falkow), pp. 235–243. Academic Press, New York.
- BRL/Life Technologies, Inc. 1985. Incorporation of biotin-11-dUTP by T4 DNA polymerase. *Focus (Life Technologies)* **7**: 13.
- Broude N.E., Sano T., Smith C.L., and Cantor C.R. 1994. Enhanced sequencing by hybridization. *Proc. Natl. Acad. Sci.* **91**: 3072–3076.
- Buckbinder L. and Brown D.D. 1992. Thyroid hormone-induced gene expression changes in the developing frog limb. *J. Biol. Chem.* **267**: 25786–25791.
- Buckler A.J., Chang D.D., Graw S.L., Brook J.D., Haber D.A., Sharp P.A., and Housman D.E. 1991. Exon amplification: A strategy to isolate mammalian genes based on RNA splicing. *Proc. Natl. Acad. Sci.* **88**: 4005–4009.
- Burge C.B. and Karlin S. 1997. Prediction of complete gene structures in human genomic DNA. *J. Mol. Biol.* **268**: 78–94.
- . 1998. Finding the genes in genomic DNA. *Curr. Opin. Struct. Biol.* **8**: 346–354.
- Carter N.P., Ferguson-Smith M.A., Perryman M.T., Telenius H., Pelmeur A.H., Leversha M.A., Glancy M.T., Wood S.L., Cook K., Dyson H.M., Ferguson-Smith M.E., and Willatt L.R. 1992. Reverse chromosome painting: A method for the rapid analysis of aberrant chromosomes in clinical cytogenetics. *J. Med. Genet.* **29**: 299–307.
- Champoux J.J. 1993. Roles of ribonuclease H in reverse transcription. In *Reverse transcriptase* (ed. A.M. Skalka and S.P. Goff), pp. 103–117. Cold Spring Harbor Laboratory Press, Cold Spring Harbor, New York.
- Chollet A. and Kawashima E.H. 1985. Biotin-labeled synthetic oligodeoxyribonucleotides: Chemical synthesis and uses as hybridization probes. *Nucleic Acids Res.* **13**: 1529–1541.
- Church D.M. and Buckler A.J. 1999. Gene identification by exon amplification. *Methods Enzymol.* **303**: 83–99.
- Church D.M., Stotler C.J., Rutter J.L., Murrell J.R., Trofatter J.A., and Buckler A.J. 1994. Isolation of genes from complex sources of mammalian genomic DNA using exon amplifica-

- tion. *Nat. Genet.* **6**: 98–105.
- Church D.M., Banks L.T., Rogers A.C., Graw S.L., Housman D.E., Gusella J.F., and Buckler A.J. 1993. Identification of human chromosome 9 specific genes using exon amplification. *Hum. Mol. Genet.* **2**: 1915–1920.
- Clark J.M. 1988. Novel non-templated nucleotide addition reactions catalyzed by procaryotic and eukaryotic polymerases. *Nucleic Acids Res.* **16**: 9677–9686.
- Clemens M.J. 1984. Purification of eukaryotic messenger RNA. In *Transcription and translation: A practical approach* (ed. B.M. Hames and S.J. Higgins), pp. 211–230. IRL Press, Oxford, United Kingdom.
- Coche T., Dewez M., and Beckers M.-C. 1994. Generation of an unlimited supply of a subtracted probe using magnetic beads and PCR. *Nucleic Acids Res.* **22**: 1322–1333.
- Cochran B.H., Reffel A.C., and Stiles C.D. 1983. Molecular cloning of gene sequences regulated by platelet-derived growth factor. *Cell* **33**: 939–947.
- Cohen S.N., Chang A.C., Boyer H.W., and Helling R.B. 1973. Construction of biologically functional bacterial plasmids in vitro. *Proc. Natl. Acad. Sci.* **70**: 3240–3244.
- Coleclough C. and Erlitz F.L. 1985. Use of primer-restriction-end adapters in a novel cDNA cloning strategy. *Gene* **34**: 305–314.
- Colman A. 1984. Translation of eukaryotic messenger RNA in *Xenopus* oocytes. In *Transcription and translation: A practical approach* (ed. B.D. Hames and S.J. Higgins), pp. 271–302. IRL Press, Oxford, United Kingdom.
- Cooke N.E., Coit D., Weiner R.L., Baxter J.D., and Martial J.A. 1980. Structure of cloned DNA complementary to rat prolactin messenger RNA. *J. Biol. Chem.* **255**: 6502–6510.
- Cooper D.L. and Isola N. 1990. Full-length cDNA cloning utilizing the polymerase chain reaction, a degenerate oligonucleotide sequence and a universal mRNA primer. *BioTechniques* **9**: 60–65.
- Cowell I.G. and Hurst H.C. 1993. Cloning transcription factors from a cDNA expression library. In *Transcription factors: A practical approach* (ed. D.S. Latchman), pp. 103–123. IRL Press, Oxford, United Kingdom.
- D'Alessio J.M. and Gerard G.F. 1988. Second-strand cDNA synthesis with *E. coli* DNA polymerase I and RNase H: The fate of information at the mRNA 5' terminus and the effect of *E. coli* DNA ligase. *Nucleic Acids Res.* **16**: 1999–2014.
- D'Alessio J.M., Bebee R., Hartley J.L., Noon M.C., and Polayes D. 1992.  $\lambda$ ZipLox: Automatic subcloning of cDNA. *Focus* (Life Technologies) **14**: 76–79.
- Davidson E.H. 1976. *Gene activity in early development*, 2nd edition. Academic Press, New York.
- Davis R.L., Weintraub H., and Lassar A.B. 1987. Expression of a single transfected cDNA converts fibroblasts to myoblasts. *Cell* **51**: 987–1000.
- Debuire B., Chabli A., and Frenoy N. 1993. Fast, manual non-radioactive method for DNA sequencing. *Clin. Chem.* **39**: 1682–1685.
- Del Mastro R.G. and Lovett M. 1997. Isolation of coding sequences from genomic regions using direct selection. *Methods Mol. Biol.* **68**: 183–199.
- Del Mastro R.G., Wang L., Simmons A.D., Clines G.A., Ashley J.A., Gallardo T.D., Hilliard C.J., Wasmuth J.J., McPherson J.D., and M. Lovett. 1995. Human chromosome-specific cDNA libraries: New tools for gene identification and genome annotation. *Genome Res.* **5**: 185–194.
- Deloukas P., Schuler G.D., Gyapay G., Beasley E.M., Soderlund C., Rodriguez-Tome P., Hui L., Matise T.C., McKusick K.B., Beckmann J.S., Bentolila S., Bihoreau M., Birren B.B., Browne J., Butler A., Castle A.B., Chianniikulchai N., Clee C., Day P.J., Dehejia A., Dibling T., Drouot N., Duprat S., Fizames C., Bentley D.R. et al. 1998. A physical map of 30,000 human genes. *Science* **23**: 744–746.
- Domec C., Garbay B., Fournier M., and Bonnet J. 1990. cDNA library construction from small amounts of unfractionated RNA: Association of cDNA synthesis with polymerase chain reaction amplification. *Anal. Biochem.* **188**: 422–426.
- Don R.H., Cox P.T., and Mattick J.S. 1993. A “one tube reaction” for synthesis and amplification of total cDNA from small numbers of cells. *Nucleic Acids Res.* **21**: 783.
- Dotto G.P., Horiuchi K., and Zinder N.D. 1984. The functional origin of bacteriophage  $\phi$ 1 DNA replication. Its signals and domains. *J. Mol. Biol.* **172**: 507–521.
- Duguid J.R., Rohwer R.G., and Seed B. 1988. Isolation of cDNAs of scrapie-modulated RNAs by subtractive hybridization of a cDNA library. *Proc. Natl. Acad. Sci.* **85**: 5738–5742.
- Duncan B.K. 1981. DNA glycosylases. In *The enzymes*, 3rd edition (ed. P.D. Boyer), pp. 565–586. Academic Press, New York.
- Dworkin M.B. and Dawid I.B. 1980. Use of a cloned library for the study of abundant poly(A)<sup>+</sup> RNA during *Xenopus laevis* development. *Dev. Biol.* **76**: 449–464.
- Efstratiadis A., Kafatos F.C., and Maniatis T. 1977. The primary structure of rabbit  $\beta$ -globin mRNA as determined from cloned DNA. *Cell* **10**: 571–585.
- Efstratiadis A., Kafatos F.C., Maxam A.M., and Maniatis T. 1976. Enzymatic in vitro synthesis of globin genes. *Cell* **7**: 279–288.
- Efstratiadis A., Maniatis T., Kafatos F.C., Jeffrey A., and Vournakis J.N. 1975. Full length and discrete partial reverse transcripts of globin and chorion mRNAs. *Cell* **4**: 367–378.
- Elledge S.J., Mulligan J.T., Ramer S.W., Spottswood M., and Davis R.W. 1991.  $\lambda$  YES: A multifunctional cDNA expression vector for the isolation of genes by complementation of yeast and *Escherichia coli* mutations. *Proc. Natl. Acad. Sci.* **88**: 1731–1735.
- Ennis P.D., Zemmour J., Salter R.D., and Parham P. 1990. Rapid cloning of HLA-A,B cDNA by using the polymerase chain reaction: Frequency and nature of errors produced in amplification. *Proc. Natl. Acad. Sci.* **87**: 2833–2837.
- Forster A.C., McInnes J.L., Skingle D.C., and Symons R.H. 1985. Non-radioactive hybridization probes prepared by the chemical labelling of DNA and RNA with a novel reagent, photobiotin. *Nucleic Acids Res.* **13**: 745–761.
- Foster D.N., Schmidt L.J., Hodgson C.P., Moses H.L., and Getz M.J. 1982. Polyadenylated RNA complementary to a mouse retrovirus-like multigene family is rapidly and specifically induced by epidermal growth factor stimulation of quiescent cells. *Proc. Natl. Acad. Sci.* **79**: 7317–7321.
- Frech G.C. and Joho R.H. 1992. Isolation of ion channel genes by expression cloning in *Xenopus* oocytes. *Methods Enzymol.* **207**: 592–604.
- French B.T., Maul H.M., and Maul G.G. 1986. Screening cDNA expression libraries with monoclonal and polyclonal antibodies using an amplified biotin-avidin-peroxidase technique. *Anal. Biochem.* **156**: 417–423.
- Friedberg E.C., Bonura T., Radany E.H., and Love J.D. 1981. Enzymes that incise damaged DNA. In *The enzymes*, 3rd edition (ed. P.D. Boyer), pp. 251–279. Academic Press, New York.
- Frohman M.A. 1993. Rapid amplification of complementary DNA ends for generation of full-length complementary DNAs: Thermal RACE. *Methods Enzymol.* **218**: 340–356.
- Frohman M.A., Dush M.K., and Martin G.R. 1988. Rapid pro-

- duction of full-length cDNAs from rare transcripts: Amplification using a single gene-specific oligonucleotide primer. *Proc. Natl. Acad. Sci.* **85**: 8998–9002.
- Fukuda M., Bierhuizen M.F., and Nakayama J. 1996. Expression cloning of glycosyltransferases. *Glycobiology* **6**: 683–689.
- Gabrielsen O.S. and Huet J. 1993. Magnetic DNA affinity purification of yeast transcription factor. *Methods Enzymol.* **218**: 508–525.
- Gabrielsen O.S., Hornes E., Korsnes L., Ruet A., and Oyen T.B. 1989. Magnetic DNA affinity purification of a yeast transcription factor  $\tau$  — A new purification principle for the ultrarapid isolation of near homogeneous factor. *Nucleic Acids Res.* **17**: 6253–6267.
- Georgiadis M.M., Jessen S.M., Ogata C.M., Telesnitsky A., Goff S.P., and Hendrickson W.A. 1995. Mechanistic implications from the structure of a catalytic fragment of Moloney murine leukemia virus reverse transcriptase. *Structure* **3**: 879–892.
- Gerard G.F. 1983. Reverse transcriptase. In *Enzymes of nucleic acid synthesis and modification: DNA enzymes* (ed. S.T. Jacob), vol. 1, p. 1. CRC Press, Boca Raton, Florida.
- . 1998. Reverse transcriptase: A historical perspective. *Focus (Life Technologies)* **20**: 65–67.
- Gerard G.F. and D'Alessio J.M. 1993. Reverse transcriptase (EC2.7.7.49): The use of cloned Moloney murine leukemia virus reverse transcriptase to synthesize DNA from RNA. *Methods Mol. Biol.* **16**: 73–94.
- Gerard G.F., D'Alessio J.M., and Kotewicz M.L. 1989. cDNA synthesis by cloned Moloney murine leukemia virus reverse transcriptase lacking RNase H activity. *Focus (Life Technologies)* **11**: 66–69.
- Gerard G.F., D'Alessio J.M., Kotewicz M.L., and Noon M.C. 1986. Influence on stability in *Escherichia coli* of the carboxy-terminal structure of cloned Moloney murine leukemia virus reverse transcriptase. *DNA* **5**: 271–279.
- Gerard G.F., Schmidt B.J., Kotewicz M.L., and Campbell J.H. 1992. cDNA synthesis by Moloney murine leukemia virus RNase H-minus reverse transcriptase possessing full DNA polymerase activity. *Focus (Life Technologies)* **14**: 91–93.
- Gergen J.P., Stern R.H., and Wensink P.C. 1979. Filter replicas and permanent collections of recombinant DNA plasmids. *Nucleic Acids Res.* **7**: 2115–2136.
- Gluzman Y. 1981. SV40-transformed simian cells support the replication of early SV40 mutants. *Cell* **23**: 175–182.
- Gluzman Y., Frisque R.J., and Sambrook J. 1980a. Origin-defective mutants of SV40. *Cold Spring Harbor Symp. Quant. Biol.* **44**: 293–300.
- Gluzman Y., Sambrook J.F., and Frisque R.J. 1980b. Expression of early genes of origin-defective mutants of simian virus 40. *Proc. Natl. Acad. Sci.* **77**: 3898–3902.
- Gluzman Y., Davison J., Oren M., and Winocour E. 1977. Properties of permissive monkey cells transformed by UV-irradiated simian virus 40. *J. Virol.* **22**: 256–266.
- Goelet P., Lomonosoff G.P., Butler P.J., Akam M.E., Gait M.J., and Karn J. 1982. Nucleotide sequence of tobacco mosaic virus RNA. *Proc. Natl. Acad. Sci.* **79**: 5818–5822.
- Goff S.P. and Berg P. 1978. Excision of DNA segments introduced into cloning vectors by the poly(dA-dT) joining method. *Proc. Natl. Acad. Sci.* **75**: 1763–1767.
- Gorman C.M. 1990. Mammalian cell expression. *Curr. Opin. Biotechnol.* **1**: 36–47.
- Gorman C.M., Lane D.P., Watson C.J., and Rigby P.W.J. 1985. The regulation of gene expression in murine teratocarcinoma cells. *Cold Spring Harbor Symp. Quant. Biol.* **50**: 701–706.
- Gossen J.A., de Leeuw W.J., Molijn A.C., and Vijg J. 1993. Plasmid rescue from transgenic mouse DNA using LacI repressor protein conjugated to magnetic beads. *BioTechniques* **14**: 624–629.
- Green N.M. 1975. Avidin. *Adv. Protein Chem.* **29**: 85–133.
- Green N.M. and Toms E.J. 1972. The dissociation of avidin-biotin complexes by guanidinium chloride. *Biochem. J.* **130**: 707–711.
- . 1973. The properties of subunits of avidin coupled to sepharose. *Biochem. J.* **133**: 687–700.
- Greene P.H., Poonian M.S., Nussbaum A.L., Tobias L., Garfin D.E., Boyer H.W., and Goodman H.M. 1975. Restriction and modification of a self-complementary octanucleotide containing the EcoRI substrate. *J. Mol. Biol.* **99**: 237–261.
- Grinblat Y., Gamse J., Patel M., and Sive H. 1998. Determination of the zebrafish forebrain: Induction and patterning. *Development* **125**: 4403–4416.
- Gruber C.E. 1995. Production of cDNA libraries by electroporation. *Methods Mol. Biol.* **47**: 67–79.
- Gubler U. 1988. A one tube reaction for the synthesis of blunt-ended double-stranded cDNA. *Nucleic Acids Res.* **16**: 2726.
- Gubler U. and Hoffman B.J. 1983. A simple and very efficient method for generating cDNA libraries. *Gene* **25**: 263–269.
- Hahnel A.C., Rappolee D.A., Millan J.L., Manes T., Ziomek C.A., Theodosiou N.G., Werb Z., Pedersen R.A., and Schultz G.A. 1990. Two alkaline phosphatase genes are expressed during early development in the mouse embryo. *Development* **110**: 555–564.
- Hamilton B.A., Palazzolo M.J., and Meyerowitz E.M. 1991. Rapid isolation of long cDNA clones from existing libraries. *Nucleic Acids Res.* **19**: 1951–1952.
- Han J.H. and Rutter W.J. 1988.  $\lambda$ gt22S, a phage expression vector for the directional cloning of cDNA by the use of a single restriction enzyme SfiI. *Nucleic Acids Res.* **16**: 11837.
- Han J.H., Stratowa C., and Rutter W.J. 1987. Isolation of full-length putative rat lysophospholipase cDNA using improved methods for mRNA isolation and cDNA cloning. *Biochemistry* **26**: 1617–1625.
- Hara E., Kato T., Nakada S., Sekiya S., and Oda K. 1991. Subtractive cDNA cloning using oligo(dT)30-latex and PCR: Isolation of cDNA clones specific to undifferentiated human embryonal carcinoma cells. *Nucleic Acids Res.* **19**: 7097–7104.
- Harline M.C., Kandala J.C., Sage R.D., Guntaka R.V., and DeAngelo A. 1992. Improved method for screening cDNA expression libraries for DNA-binding proteins. *BioTechniques* **13**: 388–391.
- Haukanes B.-I. and Kvam C. 1993. Application of magnetic beads in biosassays. *Bio/Technology* **11**: 60–63.
- Haun R.S., Serventi I.M., and Moss J. 1992. Rapid reliable ligation-independent cloning of PCR products using modified plasmid vectors. *BioTechniques* **13**: 515–518.
- Hedrick S.M., Cohen D.I., Nielsen E.A., and Davis M.M. 1984. Isolation of cDNA clones encoding T cell-specific membrane-associated proteins. *Nature* **308**: 149–153.
- Herz J., Hamann U., Rogne S., Myklebost O., Gausepohl H., and Stanley K.K. 1988. Surface location and high affinity for calcium of a 500-kd liver membrane protein closely related to the LDL-receptor suggest a physiological role as lipoprotein receptor. *EMBO J.* **7**: 4119–4127.
- Higuchi R., Paddock G.V., Wall R., and Salser W. 1976. A general method for cloning eukaryotic structural gene sequences. *Proc. Natl. Acad. Sci.* **73**: 3146–3150.
- Hirt B. 1967. Selective extraction of polyoma DNA from infected mouse cell cultures. *J. Mol. Biol.* **26**: 365–369.

- Hizi A. and Hughes S.H. 1988. Expression of the Moloney murine leukemia virus and human immunodeficiency virus integration proteins in *Escherichia coli*. *Virology* **167**: 634–638.
- Hofstetter H., Schambock A., Van Den Berg J., and Weissmann C. 1976. Specific excision of the inserted DNA segment from hybrid plasmids constructed by the poly(dA)-poly(dT) method. *Biochim. Biophys. Acta* **454**: 587–591.
- Hopgood R., Sullivan K.M., and Gill P. 1992. Strategies for automated sequencing of human mitochondrial DNA directly from PCR products. *BioTechniques* **13**: 82–92.
- Hornes E. and Korsnes L. 1990. Magnetic DNA hybridization properties of oligonucleotide probes attached to superparamagnetic beads and their use in the isolation of poly(A) mRNA from eukaryotic cells. *Genet. Anal. Tech. Appl.* **7**: 145–150.
- Horst E., Wijngaard P.L.J., Metzelaar M., Bast E.J.E.G., and Clevers H.C. 1991. A method for cDNA cloning in COS cells irrespective of the subcellular site of expression. *Nucleic Acids Res.* **19**: 4556.
- Hoyt M.A., Knight D.M., Das A., Miller H.L., and Echols H. 1982. Control of phage  $\lambda$  development by stability and synthesis of cII protein: Role of the viral *cIII* and host *hflA*, *himA* and *himD* genes. *Cell* **31**: 565–573.
- Hsiao K.C. 1993. Exonuclease III induced ligase-free directional subcloning of PCR products. *Nucleic Acids Res.* **21**: 5528–5529.
- Hu G. 1993. DNA polymerase-catalyzed addition of nontemplated extra nucleotides to the 3' end of a DNA fragment. *DNA Cell Biol.* **12**: 763–770.
- Hu S.C., Court D.L., Zweig M., and Levin J.G. 1986. Murine leukemia virus pol gene products: Analysis with antisera generated against reverse transcriptase and endonuclease fusion proteins expressed in *Escherichia coli*. *J. Virol.* **60**: 267–274.
- Hu W.N., Kopachik W., and Band R.N. 1992. A simple, efficient method to create a cDNA library. *BioTechniques* **13**: 862–864.
- Hultman T. and Uhlén M. 1994. Solid-phase cloning to create sublibraries suitable for DNA sequencing. *J. Biotechnol.* **35**: 229–238.
- Hultman T., Bergh T., Moks T., and Uhlén M. 1991. Bidirectional solid-phase sequencing of *in vitro*-amplified plasmid DNA. *BioTechniques* **10**: 84–93.
- Hultman T., Stahl S., Hornes E., and Uhlén M. 1989. Direct solid phase sequencing of genomic and plasmid DNA using magnetic beads as solid support. *Nucleic Acids Res.* **17**: 4937–4946.
- Hultman T., Murby M., Stahl S., Hornes E., and Uhlén M. 1990. Solid phase *in vitro* mutagenesis using plasmid DNA template. *Nucleic Acids Res.* **18**: 5107–5112.
- Hunziker W., Spiess M., Semenza G., and Lodish H.F. 1986. The sucrase-isomaltase complex: Primary structure, membrane-orientation, and evolution of a stalked, intrinsic brush border protein. *Cell* **46**: 227–234.
- Huse W.D. and Hansen C. 1988. cDNA cloning redefined: A rapid, efficient, directional method. *Strat. Mol. Biol.* **1**: 1–3.
- Huynh T.V., Young R.A., and Davis R.W. 1985. Constructing and screening cDNA libraries in  $\lambda$ gt10 and  $\lambda$ gt11. In *DNA cloning: A practical approach* (ed. D.M. Glover), vol. 1, pp. 49–78. IRL Press, Oxford, United Kingdom.
- Ito T., Smith S.L., and Cantor C.R. 1992. Sequence-specific DNA purification by triplex affinity capture. *Proc. Natl. Acad. Sci.* **89**: 495–498.
- Jackson D.A., Symons R.H., and Berg P. 1972. Biochemical method for inserting new genetic information into DNA of simian virus 40: Circular SV40 DNA molecules containing lambda phage genes and the galactose operon of *Escherichia coli*. *Proc. Natl. Acad. Sci.* **69**: 2904–2909.
- Jakobsen K.S., Breivold E., and Horsnes E. 1990. Purification of mRNA directly from crude plant tissues in 15 minutes using magnetic oligo dT microspheres. *Nucleic Acids Res.* **18**: 3669.
- Jakobsen K.S., Haugen M., Saebøe-Larssen S., Hollung K., Espelund, M., and Hornes E. 1994. Direct mRNA isolation using magnetic oligo (dT) beads: A protocol for all types of cell cultures, animal and plant tissues. In *Advances in biomagnetic separation* (ed. M. Uhlén et al.), pp. 61–71. Eaton Publishing, Natick, Massachusetts.
- Ji H. and Smith L.M. 1993. Rapid purification of double-stranded DNA by triple-helix-mediated affinity capture. *Anal. Chem.* **65**: 1323–1328.
- Ji H., Smith L.M., and Guilfoyle R.A. 1994. Rapid isolation of cosmid insert DNA by triple-helix-mediated affinity capture. *Genet. Anal. Tech. Appl.* **11**: 43–47.
- Julius D., MacDermott A.B., Axel R., and Jessell T.M. 1988. Molecular characterization of a functional cDNA encoding the serotonin 1c receptor. *Science* **241**: 558–564.
- Kacian D.L., Mills D.R., Kramer F.R., and Spiegelman S. 1972. A replicating RNA molecule suitable for a detailed analysis of extracellular evolution and replication. *Proc. Natl. Acad. Sci.* **69**: 3038–3042.
- Kaluz S. and Flint A.P.F. 1994. Ligation-independent cloning of PCR products with primers containing nonbase residues. *Nucleic Acids Res.* **22**: 4845.
- Karrer E.K., Lincoln J.E., Hogenhout S., Bennett A.B., Bostock R.M., Martineau B., Lucas W.J., Gilchrist D.G., and Alexander D. 1995. *In situ* isolation of mRNA from individual plant cells: Creation of cell-specific cDNA libraries. *Proc. Natl. Acad. Sci.* **92**: 3814–3818.
- Kasai H., Isono S., Kitakawa M., Mineno J., Akiyama H., Kurnit D.M., Berg D.E., and Isono K. 1992. Efficient large-scale sequencing of the *Escherichia coli* genome: Implementation of a transposon- and PCR-based strategy for the analysis of ordered  $\lambda$  phage clones. *Nucleic Acids Res.* **20**: 6509–6515.
- Kern F.G. and Basilico C. 1986. An inducible eukaryotic host-vector expression system: Amplification of genes under the control of the polyoma late promoter in a cell line producing a thermolabile large T antigen. *Gene* **43**: 237–245.
- Kieffer B.L. 1991. Optimised cDNA size selection and cloning procedure for the construction of representative plasmid cDNA libraries (erratum *Gene* [1992] **116**: 117). *Gene* **109**: 115–119.
- Kim C.M., Goldstein J.L., and Brown M.S. 1992. cDNA cloning of MEV, a mutant protein that facilitates cellular uptake of mevalonate, and identification of the point mutation responsible for its gain of function. *J. Biol. Chem.* **267**: 23113–23121.
- Kluxen F.W., Bruns C., and Lubbert H. 1992. Expression cloning of a rat brain somatostatin receptor cDNA. *Proc. Natl. Acad. Sci.* **89**: 4618–4622.
- Kohler S.W., Provost G.S., Kretz P.L., Dyaico M.J., Sorge J.A., and Short J.M. 1990. Development of a short-term, *in vivo* mutagenesis assay: The effects of methylation on the recovery of a lambda phage shuttle vector from transgenic mice. *Nucleic Acids Res.* **18**: 3007–3013.
- Kohlstaedt L.A., Wang J., Friedman J.M., Rice P.A., and Steitz T.A. 1992. Crystal structure at 3.5 Å resolution of HIV-1 reverse transcriptase complexed with an inhibitor. *Science* **256**: 1783–1790.
- Kolm P.J. and Sive H.L. 1995. Efficient hormone inducible protein function in *Xenopus laevis*. *Dev. Biol.* **171**: 267–272.
- Kolm P.J., Apekin V., and Sive H. 1997. *Xenopus* hindbrain patterning requires retinoid signaling. *Dev. Biol.* **192**: 1–16.

- Korman A.J., Knudsen P.J., Kaufman J.F., and Strominger J.L. 1982. cDNA clones for the heavy chain of HLA-DR antigens obtained after immunopurification of polysomes by monoclonal antibody. *Proc. Natl. Acad. Sci.* **79**: 1844-1848.
- Korn B., Sedlacek Z., and Poustka A. 1994. Isolation of transcribed and conserved sequences from large genomic regions by magnetic capture. In *Advances in biomagnetic separation* (ed. M. Uhlén et al.), pp. 79-89. Eaton Publishing, Natick, Massachusetts.
- Kotewicz M.L., Sampson C.M., D'Alessio J.M., and Gerard G.F. 1988. Isolation of cloned Moloney murine leukemia virus reverse transcriptase lacking ribonuclease H activity. *Nucleic Acids Res.* **16**: 265-277.
- Kotewicz M.L., D'Alessio J.M., Driftmier K.M., Blodgett K.P., and Gerard G.F. 1985. Cloning and overexpression of Moloney murine leukemia virus reverse transcriptase in *Escherichia coli*. *Gene* **35**: 249-258.
- Kraus J.P. and Rosenberg L.E. 1982. Purification of low-abundance messenger RNAs from rat liver by polysome immunoadsorption. *Proc. Natl. Acad. Sci.* **79**: 4015-4019.
- Krawinkel U. and Zobelein R. 1986. Rapid synthesis of cDNA for cloning into lambda vectors. *Nucleic Acids Res.* **14**: 1913.
- Kretz P.L., Reid C.H., Greener A., and Short J.M. 1989. Effect of lambda packaging extract *mcr* restriction activity on DNA cloning. *Nucleic Acids Res.* **17**: 5409.
- Lambert K.N. and Williamson V.M. 1993. cDNA library construction from small amounts of RNA using paramagnetic beads and PCR. *Nucleic Acids Res* **21**: 775-776.
- . 1997. cDNA library construction from small amounts of RNA using paramagnetic beads and PCR. *Methods Mol. Biol.* **69**: 1-12.
- Land H., Grez M., Hauser H., Lindenmaier W., and Schutz G. 1981. 5'-Terminal sequences of eucaryotic mRNA can be cloned with high efficiency. *Nucleic Acids Res.* **9**: 2251-2266.
- Lasky L.A., Lev Z., Xin J.H., Britten R.J., and Davidson E.H. 1980. Messenger RNA prevalence in sea urchin embryos measured with cloned cDNAs. *Proc. Natl. Acad. Sci.* **77**: 5317-5321.
- Lea T., Vartdal F., Nustad K., Funderud S., Berge A., Ellingsen T., Schmid R., Senstad P., and Ugelstad J. 1988. Monosized, magnetic polymer particles: Their use in separation of cells and subcellular components, and in the study of lymphocyte function in vitro. *J. Mol. Recognit.* **1**: 9-18.
- Leary J.J., Brigati D.J., and Ward D.C. 1983. Rapid and sensitive colorimetric method for visualizing biotin-labeled DNA probes hybridized to DNA or RNA immobilized on nitrocellulose: Bio-blots. *Proc. Natl. Acad. Sci.* **80**: 4045-4049.
- Lee A.S., Delegeane A., and Scharff D. 1981. Highly conserved glucose-regulated protein in hamster and chicken cells: Preliminary characterization of its cDNA clone. *Proc. Natl. Acad. Sci.* **78**: 4922-4925.
- Lee Y.-H. and Vacquier V.D. 1992. Reusable cDNA libraries coupled to magnetic beads. *Anal. Biochem.* **206**: 206-207.
- Le Guellec R., Paris J., Couturier A., Roghi C., and Philippe M. 1991. Cloning by differential screening of a *Xenopus* cDNA that encodes a kinesin-related protein. *Mol. Cell. Biol.* **11**: 3395-3398.
- Leis J.P. and Hurwitz J. 1972. Isolation and characterization of a protein that stimulates DNA synthesis from avian myeloblastosis virus. *Proc. Natl. Acad. Sci.* **69**: 2331-2335.
- Leren T.P., Rodningen O.K., Rosby O., Sollberg K., and Berg K. 1993. Sequencing for point mutations by semi-automated DNA sequencing using Sequenase and magnetic beads. *BioTechniques* **14**: 618-623.
- Li C. and Evans R.M. 1997. Ligation independent cloning irrespective of restriction site compatibility. *Nucleic Acids Res.* **25**: 4165-4166.
- Libert F., Parmentier M., Lefort A., Dinsart C., Van Sande J., Maenhaut C., Simons M.J., Dumont J.E., and Vassart G. 1989. Selective amplification and cloning of four new members of the G protein-coupled receptor family. *Science* **244**: 569-572.
- Linzer D.I. and Nathans D. 1983. Growth-related changes in specific mRNAs of cultured mouse cells. *Proc. Natl. Acad. Sci.* **80**: 4271-4275.
- Liu Z. 1996. Hetero-stagger cloning: Efficient and rapid cloning of PCR products. *Nucleic Acids Res.* **24**: 2458-2459.
- Lobban P.E. and Kaiser A.D. 1973. Enzymatic end-to-end joining of DNA molecules. *J. Mol. Biol.* **78**: 453-471.
- Lovett M., Kere J., and Hinton L.M. 1991. Direct selection: A method for the isolation of cDNAs encoded by large genomic regions. *Proc. Natl. Acad. Sci.* **88**: 9628-9632.
- Lübbert H., Snutch T.P., Dascal N., Lester H.A., and Davidson N. 1987. Rat brain 5-HT<sub>1C</sub> receptors are encoded by a 5-6 kbase mRNA size class and are functionally expressed in injected *Xenopus* oocytes. *J. Neurosci.* **7**: 1159-1165.
- Lund V., Schmid R., Rickwood D., and Hornes E. 1988. Assessment of methods for covalent binding of nucleic acids to magnetic beads, Dynabeads, and the characteristics of the bound nucleic acids in hybridization reactions. *Nucleic Acids Res.* **16**: 10861-10880.
- Luskey K.L., Faust J.R., Chin D.J., Brown M.S., and Goldstein J.L. 1983. Amplification of the gene for 3-hydroxy-3-methylglutaryl coenzyme A reductase, but not for the 53-kDa protein, in UT-1 cells. *J. Biol. Chem.* **258**: 8462-8469.
- Maniatis T., Jeffrey A., and van deSande H. 1975. Chain length determination of small double- and single-stranded DNA molecules by polyacrylamide gel electrophoresis. *Biochemistry* **14**: 3787-3794.
- Maniatis T., Kee S.G., Efstratiadis A., and Kafatos F.C. 1976. Amplification and characterization of a  $\beta$ -globin gene synthesized in vitro. *Cell* **8**: 163-182.
- Manos M.M. and Gluzman Y. 1985. Genetic and biochemical analysis of transformation-competent, replication-defective simian virus 40 large T antigen mutants. *J. Virol.* **53**: 120-127.
- Mason I.J., Taylor A., Williams J.G., Sage H., and Hogan B.L. 1986. Evidence from molecular cloning that SPARC, a major product of mouse embryo parietal endoderm, is related to an endothelial cell "culture shock" glycoprotein of  $M_r$  43,000. *EMBO J.* **5**: 1465-1472.
- Masu Y., Nakayama K., Tamaki H., Harada Y., Kuno M., and Nakanishi S. 1987. cDNA cloning of bovine substance-K receptor through oocyte expression system. *Nature* **329**: 836-838.
- Mather E.L., Alt F.W., Bothwell A.L., Baltimore D., and Koshland M.E. 1981. Expression of J chain RNA in cell lines representing different stages of B lymphocyte differentiation. *Cell* **23**: 369-378.
- Matson S.W., Fay P.J., and Bambara R.A. 1980. Mechanism of inhibition of the avian myeloblastosis virus deoxyribonucleic acid polymerase by adriamycin. *Biochemistry* **19**: 2089-2096.
- McCarrey J.R. and Williams S.A. 1994. Construction of cDNA libraries from limiting amounts of material. *Curr. Opin. Biotechnol.* **5**: 34-39.
- McDonnell D.P., Mangelsdorf D.J., Pike J.W., Haussler M.R., and O'Malley B.W. 1987. Molecular cloning of complementary DNA encoding the avian receptor for vitamin D. *Science* **235**: 1214-1217.

- McInnes J.L. and Symons R.H. 1989. Preparation and detection of nonradioactive nucleic acid and oligonucleotide probes. In *Nucleic acid probes* (ed. R.H. Symons), pp. 33–80. CRC Press, Boca Raton, Florida.
- McInnes J.L., Forster A.C., and Symons R.L. 1987. Non-radioactive photobiotin-labeled probes detect single copy genes and low abundance mRNA. *Bio/Technology* **5**: 269–272.
- Mehdy M.C., Ratner D., and Firtel R.A. 1983. Induction and modulation of cell-type-specific gene expression in *Dictyostelium*. *Cell* **32**: 763–771.
- Mellon P., Parker V., Gluzman Y., and Maniatis T. 1981. Identification of DNA sequences required for transcription of the human  $\alpha$  1-globin gene in a new SV40 host-vector system. *Cell* **27**: 279–288.
- Melton D.A. 1987. Translation of messenger RNA in injected frog oocytes. *Methods Enzymol.* **152**: 288–296.
- Mertz L.M., Westfall B., and Rashtian A. 1994. PCR nonradioactive labeling system for synthesis of biotinylated probes. *Focus* (Life Technologies) **16**: 49–51.
- Miki T., Matsui T., Heidaran M.A., and Aaronson S.A. 1989. An efficient directional cloning system to construct cDNA libraries containing full-length inserts at high frequency. *Gene* **83**: 137–146.
- Morgan J.G., Dolganov M., Robins S.E., Hinton L.M., and Lovett M. 1992. The selective isolation of novel cDNAs encoded by the regions surrounding the human interleukin 4 and 5 gene. *Nucleic Acids Res.* **20**: 5173–5179.
- Morgan K. and Kalsheker N. 1994. Simple and efficient cDNA capture utilizing a short gene-specific probe attached to magnetic beads. *Biochem. Soc. Trans.* **22**: 453S.
- Muller W.J., Naujokas M.A., and Hassell J.A. 1984. Isolation of large T antigen-producing mouse cell lines capable of supporting replication of polyomavirus-plasmid recombinants. *Mol. Cell. Biol.* **4**: 2406–2412.
- Munro S. and Maniatis T. 1989. Expression cloning of the murine interferon  $\gamma$  receptor cDNA. *Proc. Natl. Acad. Sci.* **86**: 9248–9252.
- Munroe D.J., Loebbert R., Bric E., Whitton T., Prawitt D., Vu D., Buckler A., Winterpacht A., Zabel B., and Housman D.E. 1995. Systematic screening of an arrayed cDNA library by PCR. *Proc. Natl. Acad. Sci. U.S.A.* **14**: 2209–2213.
- Murasugi A. and Wallace R.B. 1984. Biotin-labeled oligonucleotides: Enzymatic synthesis and use as hybridization probes. *DNA* **3**: 269–277.
- Murray N.E., Brammar W.J., and Murray K. 1977. Lambdaoid phages that simplify the recovery of in vitro recombinants. *Mol. Gen. Genet.* **150**: 53–61.
- Naglich J.G., Metherall J.E., Russell D.W., and Eidels L. 1992. Expression cloning of a diphtheria toxin receptor: Identity with a heparin-binding EGF-like growth factor precursor. *Cell* **69**: 1051–1061.
- Nakayama N., Yokota T., and Arai K.-I. 1992. Use of mammalian cell expression cloning systems to identify genes for cytokines, receptors and regulatory proteins. *Curr. Opin. Biotechnol.* **3**: 497–505.
- Nisson P.E., Ally A., and Watkins P.C. 1994. Protocols for trapping internal and 3'-terminal exons. *PCR Methods Appl.* **4**: S24–S39.
- Nisson P.E., Rashtchian A., and Watkins P.C. 1991. Rapid and efficient cloning of Alu-PCR products using uracil DNA glycosylase. *PCR Methods Appl.* **1**: 120–123.
- North M.A., Sanseau P., Buckler A.J., Church D.M., Jackson A., Patel K., Trowsdale J., and Lehrach H. 1993. Efficiency and specificity of gene isolation by exon amplification. *Mamm. Genome* **4**: 466–474.
- Ohara R. and Ohara O. 1995. A new solid-phase chemical DNA sequencing method which uses streptavidin-coated magnetic beads. *DNA Res.* **2**: 123–128.
- Okayama H. and Berg P. 1982. High-efficiency cloning of full-length cDNA. *Mol. Cell. Biol.* **2**: 161–170.
- . 1983. A cDNA cloning vector that permits expression of cDNA inserts in mammalian cells. *Mol. Cell. Biol.* **3**: 280–289.
- Okayama H., Kawaichi M., Brownstein M., Lee F., Yokota T., and Arai K. 1987. High-efficiency cloning of full-length cDNA; construction and screening of cDNA expression libraries for mammalian cells. *Methods Enzymol.* **154**: 3–28.
- Palacios R., Palmiter R.D., and Schimke R.T. 1972. Identification and isolation of ovalbumin-synthesizing polysomes. I. Specific binding of  $^{125}$ I-anti-ovalbumin to polysomes. *J. Biol. Chem.* **247**: 2316–2321.
- Parimoo S., Patanjali S.R., Shukla H., Chaplin D.D., and Weissman S.M. 1991. cDNA selection: Efficient PCR approach for the selection of cDNAs encoded in large chromosomal DNA fragments. *Proc. Natl. Acad. Sci.* **88**: 9623–9627.
- Peacock S.L., McIver C.M., and Monahan J.J. 1981. Transformation of *E. coli* using homopolymer-linked plasmid chimeras. *Biochim. Biophys. Acta* **655**: 243–250.
- Persson H., Monstein H.J., Akusjarvi G., and Philipson L. 1981. Adenovirus early gene products may control viral mRNA accumulation and translation in vivo. *Cell* **23**: 485–496.
- Poustka A. 1993. Construction and use of chromosome jumping libraries. *Methods Enzymol.* **217**: 358–378.
- Prasad V.R. 1993. Genetic analysis of retroviral reverse transcriptase structure and function. In *Reverse transcriptase* (ed. A.M. Skalka and S.P. Goff), pp. 135–162. Cold Spring Harbor Laboratory Press, Cold Spring Harbor, New York.
- Pribill I., Barnes G.T., Chen J., Church D., Buckler A., Baxendale S., Bates G.P., Lehrach H., Gusella M.J., Duyao M.P., Ambrose C.M., Gusella J.F., and MacDonald M.E. 1997. Exon trapping and sequence-based methods of gene finding in transcript mapping of human 4p16.3. *Somatic Cell Genet.* **23**: 413–427.
- Rabbitts T.H. 1976. Bacterial cloning of plasmids carrying copies of rabbit globin messenger RNA. *Nature* **260**: 221–225.
- Raineri I., Moroni C., and Senn H.P. 1991. Improved efficiency for single-sided PCR by creating a usable pool of first-strand cDNA coupled to a solid phase. *Nucleic Acids Res.* **19**: 4010.
- Raleigh E.A., Murray N.E., Revel H., Blumenthal R.M., Westaway D., Reith A.D., Rigby P.W., Elhai J., and Hanahan D. 1988. McrA and McrB restriction phenotypes of some *E. coli* strains and implications for gene cloning (erratum *Nucleic Acids Res.* [1995] **23**: 3612). *Nucleic Acids Res.* **16**: 1563–1575.
- Rasmussen U.B., Basset P., and Daniel J.Y. 1989. Direct amplification of cDNA inserts from  $\lambda$  libraries using the cloning-adaptor as primer for PCR. *Nucleic Acids Res.* **17**: 3308.
- Rashtchian A. 1995. Novel methods for cloning and engineering genes using the polymerase chain reaction. *Curr. Opin. Biotechnol.* **6**: 30–36.
- Ren L., Chen H., and Sternberg E.A. 1994. Tethered bandshift assay and affinity purification of a new DNA-binding protein. *BioTechniques* **16**: 852–855.
- Revel F., Renard J.P., and Duranthon V. 1995. PCR-generated cDNA libraries from reduced numbers of mouse oocytes. *Zygote* **3**: 241–250.
- Reyes G.R. and Kim J.P. 1991. Sequence-independent, single-primer amplification (SISPA) of complex DNA populations. *Mol. Cell. Probes* **5**: 473–481.



- Reyes G.R., Bradley D.W., and Lovett M. 1992. New strategies for isolation of low abundance viral and host cDNAs: Application to cloning of the hepatitis E virus and analysis of tissue-specific transcription. *Semin. Liver Dis.* **12**: 289-300.
- Rhoer-Moja S., Cohen-Haguenuer O., Jouve C., Healy J.-C., and Vindimian M. 1993. Detection of quantitative polymerase chain reaction products by hybridization on magnetic support with <sup>125</sup>I-radiolabeled probes: Quantification of *c-myc* copy numbers. *Anal. Biochem.* **213**: 12-18.
- Rhyner T.A., Biguet N.F., Berrard S., Borbely A.A., and Mallet J. 1986. An efficient approach for the selective isolation of specific transcripts from complex brain mRNA populations. *J. Neurosci. Res.* **16**: 167-181.
- Rio D.C., Clark S.G., and Tjian R. 1985. A mammalian host-vector system that regulates expression and amplification of transfected genes by temperature induction. *Science* **227**: 23-28.
- Rodriguez I.R. and Chader G.J. 1992. A novel method for the isolation of tissue-specific genes. *Nucleic Acids Res.* **20**: 3528.
- Rosenberg H.F., Corrette S.E., Tenen D.G., and Ackerman S.J. 1991. Rapid cDNA library screening using the polymerase chain reaction. *BioTechniques* **10**: 53-54.
- Rosenberg S.M. 1985. *EcoK* restriction during in vitro packaging of coliphage lambda DNA. *Gene* **39**: 313-315.
- 1987. Improved in vitro packaging of lambda DNA. *Methods Enzymol.* **153**: 95-103.
- Ross J., Aviv H., Scolnick E., and Leder P. 1972. In vitro synthesis of DNA complementary to purified rabbit globin mRNA (RNA-dependent DNA polymerase-reticulocyte-hemoglobin-density gradient centrifugation-oligo(dT) primer). *Proc. Natl. Acad. Sci.* **69**: 264-268.
- Roth A. and Messer W. 1995. The DNA binding domain of the initiator protein DNA. *EMBO J.* **14**: 2106-2111.
- Roth M.J., Tanese N., and Goff S.P. 1985. Purification and characterization of murine retroviral reverse transcriptase expressed in *Escherichia coli*. *J. Biol. Chem.* **260**: 9326-9335.
- Rothstein J.L., Johnson D., Jessee J., Skowronski J., DeLoia J.A., Solter D., and Knowles B.B. 1993. Construction of primary and subtracted cDNA libraries from early embryos. *Methods Enzymol.* **225**: 587-610.
- Rougeon F. and Mach B. 1976. Stepwise biosynthesis in vitro of globin genes from globin mRNA by DNA polymerase of avian myeloblastosis virus. *Proc. Natl. Acad. Sci.* **73**: 3418-3422.
- Rougeon F., Kourilsky P., and Mach B. 1975. Insertion of a rabbit beta-globin gene sequence into an *E. coli* plasmid. *Nucleic Acids Res.* **2**: 2365-2378.
- Rowekamp W. and Firtel R.A. 1980. Isolation of developmentally regulated genes from *Dictyostelium*. *Dev. Biol.* **79**: 409-418.
- Roychoudhury R., Jay E., and Wu R. 1976. Terminal labeling and addition of homopolymer tracts to duplex DNA fragments by terminal deoxynucleotidyl transferase. *Nucleic Acids Res.* **3**: 101-116.
- Rubenstein J.L., Brice A.E., Ciaranello R.D., Denney D., Porteus M.H., and Usdin T.B. 1990. Subtractive hybridization system using single-stranded phagemids with directional inserts. *Nucleic Acids Res.* **18**: 4833-4842.
- Ruddy D.A., Kronmal G.S., Lee V.K., Mintier G.A., Quintana L., Domingo R., Meyer N.C., Irrinki A., McClelland E.E., Fullan A., Mapa F.A., Moore T., Thomas W., Loeb D.B., Harmon C., Tsuchihashi Z., Wolff R.K., Schatzman R.C., and Feder J.N. 1997. A 1.1-Mb transcript map of the hereditary hemochromatosis locus. *Genome Res.* **7**: 441-456.
- Russel M., Kidd S., and Kelley M.R. 1986. An improved filamentous helper phage for generating single-stranded plasmid DNA. *Gene* **45**: 333-338.
- Russell D.W., Yamamoto T., Schneider W.J., Slaughter C.J., Brown M.S., and Goldstein J.L. 1983. cDNA cloning of the bovine low density lipoprotein receptor: Feedback regulation of a receptor mRNA. *Proc. Natl. Acad. Sci.* **80**: 7501-7505.
- Sagerstrom C.G., Grinblat Y. and Sive H. 1996. Anteroposterior patterning in the zebrafish, *Danio rerio*: An explant assay reveals inductive and suppressive cell interactions. *Development* **122**: 1873-1883.
- Sagerstrom C.G., Sun B.I., and Sive H.L. 1997. Subtractive cloning: Past, present and future. *Annu. Rev. Biochem.* **66**: 751-783.
- Sakurai T., Yanagisawa M., Takuya Y., Miyazaki H., Kimura S., Goto K., and Masaki T. 1990. Cloning of a cDNA encoding a non-isopeptide-selective subtype of the endothelin receptor. *Nature* **348**: 732-735.
- Sang J. and Thompson N.L. 1994. An efficient procedure for obtaining long cDNA clones from phage library screening. *BioTechniques* **17**: 446-451.
- Sargent T.D. 1987. Isolation of differentially expressed genes. *Methods Enzymol.* **152**: 423-432.
- Sargent T.D. and Dawid I.B. 1983. Differential gene expression in the gastrula of *Xenopus laevis*. *Science* **222**: 135-139.
- Scalenghe F., Turco E., Edstrom J.E., Pirotta V., and Melli M. 1981. Microdissection and cloning of DNA from a specific region of *Drosophila melanogaster* polytene chromosomes. *Chromosoma* **82**: 205-216.
- Schechter I. 1973. Biologically and chemically pure mRNA coding for a mouse immunoglobulin L-chain prepared with the aid of antibodies and immobilized oligothymidine. *Proc. Natl. Acad. Sci.* **70**: 2256-2260.
- Schoen T.J., Mazuruk K., Chader G.J., and Rodriguez I.R. 1995. Isolation of candidate genes for macular degeneration using an improved solid-phase subtractive cloning technique. *Biochem. Biophys. Res. Commun.* **213**: 181-188.
- Schutz G., Kieval S., Groner B., Sippel A.E., Kurtz D., and Feigelson P. 1977. Isolation of specific messenger RNA by adsorption of polysomes to matrix-bound antibody. *Nucleic Acids Res.* **4**: 71-84.
- Schwartz M. 1967. Sur l'existence chez *Escherichia coli* K12 d'une régulation commune à la biosynthèse des récepteurs des bacteriophage lambda et au métabolisme du maltose. *Ann. Inst. Pasteur* **113**: 685-704.
- Schweinfest C.W., Kwiatkowski R.W., and Dottin R.P. 1982. Molecular cloning of a DNA sequence complementary to creatine kinase M mRNA from chickens. *Proc. Natl. Acad. Sci.* **79**: 4997-5000.
- Sedlacek Z., Korn B., Konecki D.S., Siebenhaar R., Coy J.F., Kioschis P., and Poutska A. 1993. Construction of a transcription map of a 300kb region around the human G6PD locus by direct cDNA selection. *Hum. Mol. Genet.* **2**: 1865-1869.
- Seeber F., Pogonka T., and Lucius R. 1993. PCR mediated cDNA synthesis from minute amounts of filarial L3 RNA. *Trop. Med. Parasitol.* **44**: 57-59.
- Seed B. 1995. Developments in expression cloning. *Curr. Opin. Biotechnol.* **5**: 567-573.
- Seed B. and Aruffo A. 1987. Molecular cloning of the CD2 antigen, the T-cell erythrocyte receptor by rapid immunoselection. *Proc. Natl. Acad. Sci.* **84**: 3365-3369.
- Sena E.P. and Zarleng D.A. 1993. Targeting in linear DNA duplex-

- es with two complementary probe strands for hybrid stability. *Nat. Genet.* **3**: 365–371.
- Shapiro S.Z. and Young J.R. 1981. An immunochemical method for mRNA purification. Application to messenger RNA encoding trypanosome variable surface antigen. *J. Biol. Chem.* **256**: 1495–1498.
- Sharma P., Lonneborg A., and Stougaard P. 1994. PCR-based construction of subtractive cDNA library using magnetic beads. *BioTechniques* **15**: 610–611.
- Shen E.S., Cooke G.M., and Horlick R.A. 1995. Improved expression cloning using reporter genes and Epstein-Barr virus ori-containing vectors. *Gene* **156**: 235–239.
- Shimkus M.L., Guaglianone P., and Herman T.M. 1986. Synthesis and characterization of biotin-labeled nucleotide analogs. *DNA* **5**: 247–255.
- Short J.M., Fernandez J.M., Sorge J.A., and Huse W.D. 1988.  $\lambda$  ZAP: A bacteriophage  $\lambda$  expression vector with in vivo excision properties. *Nucleic Acids Res.* **16**: 7583–7600.
- Shuldiner A.R., Scott L.A., and Roth J. 1990. PCR-induced (ligase-free) subcloning: A reliable method to subclone polymerase chain reaction (PCR) products. *Nucleic Acids Res.* **18**: 1920.
- Simmons A.D. and Lovett M. 1999. Direct cDNA selection using large genomic DNA targets. *Methods Enzymol.* **303**: 111–126.
- Simmons A.D., Goodart S.A., Gallardo T.D., Overhauser J., and Lovett M. 1995. Five novel genes from the cri-du-chat critical region isolated by direct selection. *Hum. Mol. Genet.* **4**: 295–302.
- Simonsen H. and Lodish H.F. 1994. Cloning by function: Expression cloning in mammalian cells. *Trends Pharmacol. Sci.* **15**: 437–441.
- Singh H. 1993. Specific recognition site probes for isolating genes encoding DNA-binding proteins. *Methods Enzymol.* **218**: 551–567.
- Sive H.L., Hattori K., and Weintraub H. 1989. Progressive determination during formation of anteroposterior axis in *Xenopus laevis*. *Cell* **58**: 171–180.
- Skalka A.M. 1993. Endonuclease activity associated with reverse transcriptase of avian sarcoma-leukosis viruses. In *Reverse transcriptase* (ed. A.M. Skalka and S.P. Goff), pp. 193–204. Cold Spring Harbor Laboratory Press, Cold Spring Harbor, New York.
- Smith W.C. and Harland R.M. 1992. Expression cloning of noggin, a new dorsalizing factor localized to the Spemann organizer in *Xenopus* embryos. *Cell* **70**: 829–840.
- Snyder M., Elledge S., Sweetser D., Young R.A., and Davis R.W. 1987.  $\lambda$ gt 11: Gene isolation with antibody probes and other applications. *Methods Enzymol.* **154**: 107–128.
- Soltis D.A. and Skalka A.M. 1988. The  $\alpha$  and  $\beta$  chains of avian retrovirus reverse transcriptase independently expressed in *Escherichia coli*: Characterization of enzymatic activities. *Proc. Natl. Acad. Sci.* **85**: 3372–3376.
- Spector D.L., Goldman R.D., and Leinwand L.A. 1998a. *Cells: A laboratory manual*, vol. 2: *Light microscopy and cell structure*, pp. 84.1–84.17. Cold Spring Harbor Laboratory Press, Cold Spring Harbor, New York.
- \_\_\_\_\_. 1998b. *Cells: A laboratory manual*, vol. 1: *Culture and biochemical analysis of cells*, pp. 1.1–2.16. Cold Spring Harbor Laboratory Press, Cold Spring Harbor, New York.
- Spickofsky N. and Margolske R.F. 1991. A highly efficient directional cDNA cloning method utilizing an asymmetrically tailed linker-primer plasmid. *Nucleic Acids Res.* **19**: 7105–7111.
- Spiegelman B.M., Frank M., and Green H. 1983. Molecular cloning of mRNA from 3T3 adipocytes. Regulation of mRNA content for glycerophosphate dehydrogenase and other differentiation-dependent proteins during adipocyte development. *J. Biol. Chem.* **258**: 10083–10089.
- St. John T.P. and Davis R.W. 1979. Isolation of galactose-inducible DNA sequences from *Saccharomyces cerevisiae* by differential plaque filter hybridization. *Cell* **16**: 443–452.
- Sylvanen A.-C., Hultman T., Soderlund H., and Uhlén M. 1991. Genetic analysis of the polymorphism of the human apolipoprotein E using automated solid-phase sequencing. *Gene Anal. Tech.* **8**: 117–123.
- Tagle D.A., Swaroop M., Lovett M., and Collins F.S. 1993. Magnetic bead capture of expressed sequences encoded with large genomic segments. *Nature* **361**: 751–753.
- Takahashi-Fujii A., Maeda N., Ishino Y., Kotani H., and Kato I. 1994. Non-isotopic restriction mapping of cosmid DNA. *BioTechniques* **16**: 910–914.
- Takumi T. and Lodish H.F. 1994. Rapid cDNA cloning by PCR screening. *BioTechniques* **17**: 443–444.
- Tam A.W., Smith M.M., Fry K.E., and Larrick J.W. 1989. Construction of cDNA libraries from small numbers of cells using sequence independent primers. *Nucleic Acids Res.* **17**: 1269.
- Tanese N. and Goff S.P. 1988. Domain structure of the Moloney murine leukemia virus reverse transcriptase: Mutational analysis and separate expression of the DNA polymerase and RNase H activities. *Proc. Natl. Acad. Sci.* **85**: 1777–1781.
- Tanese N., Roth M., and Goff S.P. 1985. Expression of enzymatically active reverse transcriptase in *Escherichia coli*. *Proc. Natl. Acad. Sci.* **82**: 4944–4948.
- Taniguchi T., Guarente L., Roberts T.M., Kimelman D., Douhan III, J., and Ptashne M. 1980. Expression of the human fibroblast interferon gene in *Escherichia coli*. *Proc. Natl. Acad. Sci.* **77**: 5230–5233.
- Telesnitsky A. and Goff S.P. 1993. Strong-stop strand transfer during reverse transcription. In *Reverse transcriptase* (ed. A.M. Skalka and S.P. Goff), pp. 49–83. Cold Spring Harbor Laboratory Press, Cold Spring Harbor, New York.
- Temin H.M. and Mizutani S. 1970. RNA-dependent DNA polymerase in virions of Rous sarcoma virus. *Nature* **226**: 1211–1213.
- Terry R., Soltis D.A., Katzman M., Cobrinik D., Leis J., and Skalka A.M. 1988. Properties of avian sarcoma-leukosis virus pp32-related pol-endonucleases produced in *Escherichia coli*. *J. Virol.* **62**: 2358–2365.
- Thein S.L. and Hinton J. 1991. A simple and rapid method of direct sequencing using Dynabeads. *Br. J. Haematol.* **79**: 113–115.
- Tillett D. and Neilan B.A. 1999. Enzyme-free cloning: A rapid method to clone PCR products independent of vector restriction enzyme sites. *Nucleic Acids Res.* **19**: e26.
- Timberlake W.E. 1980. Developmental gene regulation in *Aspergillus nidulans*. *Dev. Biol.* **78**: 497–510.
- Timblin C., Battey J., and Kuehl W.M. 1990. Application for PCR technology to subtractive cDNA cloning: Identification of genes expressed specifically in murine plasmacytoma cells. *Nucleic Acids Res.* **18**: 1587–1593.
- Tong X. and Smith L.M. 1992. Solid-phase method for the purification of DNA sequencing reactions. *Anal. Chem.* **64**: 2672–2677.
- Toole J.J., Knopf J.L., Wozney J.M., Sultzman L.A., Buecker J.L., Pittman D.D., Kaufman R.J., Brown E., Shoemaker C., Orr E.C., et al. 1984. Molecular cloning of a cDNA encoding

- human antihemophilic factor. *Nature* **312**: 342-347.
- Travis G.H. and Sutcliffe J.G. 1988. Phenol emulsion-enhanced DNA-driven subtractive cDNA cloning: Isolation of low-abundance monkey cortex-specific mRNAs. *Proc. Natl. Acad. Sci.* **85**: 1696-1700.
- Travis G.H., Naus C.G., Morrison J.H., Bloom F.E., and Sutcliffe J.G. 1987. Subtractive cloning of complementary DNAs and analysis of messenger RNAs with regional heterogeneous distributions in primate cortex. *Neuropharmacology* **26**: 845-854.
- Tsai S.F., Martin D.L., Zon L.I., D'Andrea A.D., Wong G.G., and Orkin S.H. 1989. Cloning of cDNA for the major DNA-binding protein of the erythroid lineage through expression in mammalian cells. *Nature* **339**: 446-451.
- Tseng H. 1999. DNA cloning without restriction enzyme and ligase. *BioTechniques* **27**: 1240-1244.
- U'erbacher E.C., Xu Y., and Mural R.J. 1996. Discovering and understanding genes in human DNA sequence using GRAIL. *Methods Enzymol.* **266**: 259-281.
- Uhlén M. 1989. Magnetic separation of DNA. *Nature* **340**: 733-734.
- Uhlén M., Hultman T., Wahlberg J., Lundberg J., Bergh S., Pettersson B., Holmberg A., Stahl S., and Moks T. 1992. Semi-automated solid-phase DNA sequencing. *Trends Biotechnol.* **10**: 52-55.
- Urven L.E., Weng D.E., Schumaker A.L., Gearhart J.D., and McCarrey J.R. 1993. Differential gene expression in fetal mouse germ cells. *Biol. Reprod.* **48**: 564-574.
- Verma I.M., Temple G.F., Fan H., and Baltimore D. 1972. In vitro synthesis of DNA complementary to rabbit reticulocyte 10S RNA. *Nat. New Biol.* **235**: 163-167.
- Villa-Komaroff L., Efstratiadis A., Broome S., Lomedico P., Tizard R., Naber S.P., Chick W.L., and Gilbert W. 1978. A bacterial clone synthesizing proinsulin. *Proc. Natl. Acad. Sci.* **75**: 3727-3731.
- Wahlberg J., Lundberg J., Hultman T., and Uhlén M. 1990. General colorimetric method for DNA diagnostics allowing direct solid-phase genomic sequencing of the positive samples. *Proc. Natl. Acad. Sci.* **87**: 6569-6973.
- Wahlberg J., Holmberg A., Bergh S., Hultman T., and Uhlén M. 1992. Automated magnetic preparation of DNA templates for solid phase sequencing. *Electrophoresis* **13**: 547-551.
- Wang Z. and Brown D.D. 1991. A gene expression screen. *Proc. Natl. Acad. Sci.* **88**: 11505-11509.
- Wang S., Krinks M., and Moos Jr., M. 1995. DNA sequencing from single phage plaques using solid-phase magnetic capture. *BioTechniques* **18**: 130-135.
- Watson J.D., Hopkins N.H., Roberts J.W., Steitz J.A., and Weiner A.M. 1987. *Molecular biology of the gene*. Benjamin/Cummings, Menlo Park, California.
- Weeks D.L., Rebagliati M.R., Harvey R.P., and Melton D.A. 1985. Localized maternal mRNAs in *Xenopus laevis* eggs. *Cold Spring Harbor Symp. Quant. Biol.* **50**: 21-30.
- Weidner J., Eigel A., Horst J., and Kohnlein W. 1994. Nonisotopic detection of mutations using a modified single-strand conformation polymorphism analysis. *Hum. Mutat.* **4**: 55-56.
- Weier H.U. and Rosette C. 1988. Generation of labeled RNA probes from enzymatically amplified DNA templates. *Nucleic Acids Res.* **16**: 11836.
- Weiler-Guttler H., Zinke H., Mockel B., Frey A., and Gassen H.G. 1989. cDNA cloning and sequence analysis of the glucose transporter from porcine blood-brain barrier. *Biol. Chem. Hoppe-Seyler* **370**: 467-473.
- Welsh J., Liu J.P., and Efstratiadis A. 1990. Cloning of PCR-amplified total cDNA: Construction of a mouse oocyte cDNA library. *Genet. Anal. Tech. Appl.* **7**: 5-17.
- Weng D.E., Morgan R.A., and Gearhart J.D. 1989. Estimates of mRNA abundance in the mouse blastocyst based on cDNA library analysis. *Mol. Reprod. Dev.* **1**: 233-241.
- Wensink P.C., Finnegan D.J., Donelson J.E., and Hogness D.S. 1974. A system for mapping DNA sequences in the chromosomes of *Drosophila melanogaster*. *Cell* **3**: 315-325.
- Wilchek M. and Bayer A.E. 1988. The avidin-biotin complex in bioanalytical applications. *Anal. Biochem.* **171**: 1-32.
- . 1990. Biotin-containing reagents. *Methods Enzymol.* **184**: 123-138.
- Williams J.G. 1981. The preparation and screening of a cDNA clone bank. In *Genetic engineering* (ed. R. Williamson), vol. 1, pp. 1-59. Academic Press, London, United Kingdom.
- Williams J.G. and Lloyd M.M. 1979. Changes in the abundance of polyadenylated RNA during slime mould development measured using cloned molecular hybridization probes. *J. Mol. Biol.* **129**: 19-35.
- Wong G.G., Witek J.S., Temple P.A., Wilkens K.M., Leary A.C., Luxenberg D.P., Jones S.S., Brown E.L., Kay R.M., Orr E.C., et al. 1985. Human GM-CSF: Molecular cloning of the complementary DNA and purification of the natural and recombinant proteins. *Science* **228**: 810-815.
- Wood W.I., Capon D.J., Simonsen C.C., Eaton D.L., Gitschier J., Keyt B., Seeburg P.H., Smith D.H., Hollingshead P., Wion K.L., et al. 1984. Expression of active human factor VIII from recombinant DNA clones. *Nature* **312**: 330-337.
- Woodcock D.M., Crowther P.J., Doherty J., Jefferson S., DeCruz E., Noyer-Weidner M., Smith S.S., Michael M.Z., and Graham M.W. 1989. Quantitative evaluation of *Escherichia coli* host strains for tolerance to cytosine methylation in plasmid and phage recombinants. *Nucleic Acids Res.* **17**: 3469-3478.
- Yang Y.C., Ciarletta A.B., Temple P.A., Chung M.P., Kovacic S., Witek-Giannotti J.S., Leary A.C., Kriz R., Donahue R.E., Wong G.G., et al. 1986. Human IL-3 (multi-CSF): Identification by expression cloning of a novel hematopoietic growth factor related to murine IL-3. *Cell* **47**: 3-10.
- Yang Y.-S., Watson W.J., Tucker P.W., and Capra J.D. 1993. Construction of recombinant DNA by exonuclease resection. *Nucleic Acids Res.* **21**: 1889-1893.
- Yaspo M.L., Gellen L., Mott R., Korn B., Nizetic D., Poustka A.M., and Lehrach H. 1995. Model for a transcription map of human chromosome 21: Isolation of new coding sequences from exon and enriched cDNA libraries. *Hum. Mol. Genet.* **4**: 1291-1304.
- Young J.A., Bates P., and Varmus H.E. 1993. Isolation of a chicken gene that confers susceptibility to infection by subgroup A avian leukosis and sarcoma viruses. *J. Virol.* **67**: 1811-1816.
- Young R.A. and Davis R.W. 1983a. Efficient isolation of genes by using antibody probes. *Proc. Natl. Acad. Sci.* **80**: 1194-1198.
- . 1983b. Yeast RNA polymerase II genes: Isolation with antibody probes. *Science* **222**: 778-782.
- . 1991. Gene isolation with  $\lambda$ gt11 system. *Methods Enzymol.* **194**: 230-238.
- Young R.A., Bloom B.R., Grosskinsky C.M., Ivanyi J., Thomas D., and Davis R.W. 1985. Dissection of *Mycobacterium tuberculosis* antigens using recombinant DNA. *Proc. Natl. Acad. Sci.* **82**: 2583-2587.
- Zimmermann C.R., Orr W.C., Leclerc R.F., Barnard E.C., and Timberlake W.E. 1980. Molecular cloning and selection of genes regulated in *Aspergillus* development. *Cell* **21**: 709-715.



# Chapter 12

---

## DNA Sequencing

### INTRODUCTION

### PROTOCOLS

- |    |  |       |
|----|--|-------|
| 1  | Generation of a Library of Randomly Overlapping DNA Inserts  | 12.10 |
|    | • Alternative Protocol: Preparation of Small Numbers of Single-stranded DNA Templates from Bacteriophage M13                         | 12.23 |
|    | • Additional Protocol: Preparation of Dephosphorylated Blunt-ended Bacteriophage M13 Vector DNA for Shotgun Cloning                  | 12.24 |
| 2  | Preparing Denatured Templates for Sequencing by Dideoxy-mediated Chain Termination   | 12.26 |
|    | • Additional Protocol: Rapid Denaturation of Double-stranded DNA   | 12.30 |
|    | • Additional Protocol: Purification of Plasmid DNA from Small-scale Cultures by Precipitation with PEG                               | 12.31 |
| 3  | Dideoxy-mediated Sequencing Reactions Using Bacteriophage T7 DNA Polymerase (Sequenase)  | 12.32 |
| 4  | Dideoxy-mediated Sequencing Reactions Using the Klenow Fragment of <i>E. coli</i> DNA Polymerase I and Single-stranded DNA Templates | 12.40 |
| 5  | Dideoxy-mediated Sequencing of DNA Using <i>Taq</i> DNA Polymerase   | 12.45 |
| 6  | Cycle Sequencing: Dideoxy-mediated Sequencing Reactions Using PCR and End-labeled Primers  | 12.51 |
|    | • Additional Protocol: Cycle Sequencing Reactions Using PCR and Internal Labeling with [ $\alpha$ - <sup>32</sup> P]dNTPs            | 12.60 |
| 7  | Chemical Sequencing  | 12.61 |
|    | • Alternative Protocol: Rapid Maxam-Gilbert Sequencing   | 12.70 |
|    | • Additional Protocol: Preparation of End-labeled DNA for Chemical Sequencing  | 12.73 |
| 8  | Preparation of Denaturing Polyacrylamide Gels  | 12.74 |
| 9  | Preparation of Denaturing Polyacrylamide Gels Containing Formamide   | 12.81 |
| 10 | Preparation of Electrolyte Gradient Gels   | 12.83 |
| 11 | Loading and Running DNA-sequencing Gels  | 12.85 |
| 12 | Autoradiography and Reading of Sequencing Gels   | 12.90 |

### INFORMATION PANELS

- |                          |        |
|--------------------------|--------|
| Automated DNA Sequencing | 12.94  |
| Microtiter Plates        | 12.100 |

**12.1**

The Klenow Fragment of <i>E. coli</i> DNA Polymerase I	12.101
Preparation of Stock Solutions of Oligonucleotide Primers for DNA Sequencing	12.103
Sequenase	12.104
Conventional Chain-termination Sequencing of PCR-amplified DNA	12.106
Preparation of Stock Solutions of dNTPs and ddNTPs for DNA Sequencing	12.107
Glycerol in DNA Sequencing Reactions	12.108
Compressions in DNA Sequencing Gels	12.109
7-deaza-dGTP	12.111
Dichlorodimethylsilane	12.112
Reading an Autoradiograph	12.113
Electrical Mobility of DNA	12.114

*When the war finally came to an end, I was at a loss as to what to do... . I took stock of my qualifications. A not-very-good degree, redeemed somewhat by my achievements at the Admiralty. A knowledge of certain restricted parts of magnetism and hydrodynamics, neither of them subjects for which I felt the least bit of enthusiasm. No published papers at all... . Only gradually did I realize that this lack of qualification could be an advantage. By the time most scientists have reached age thirty they are trapped by their own expertise. They have invested so much effort in one particular field that it is often extremely difficult, at that time in their careers, to make a radical change. I, on the other hand, knew nothing, except for a basic training in somewhat old-fashioned physics and mathematics and an ability to turn my hand to new things... . Since I essentially knew nothing, I had an almost completely free choice... .*

Francis Crick, *What Mad Pursuit*.

**T**HE POWER OF DNA SEQUENCING IS ITS ABILITY to reduce genes and genomes to chemical entities of defined structure. Few other techniques provide biologists with such certainty and comfort. All molecular cloners must therefore be fluent DNA sequencers — not necessarily on a grand scale, but at least on a level that dissolves doubts, confirms hopes, and pinpoints problems.

In molecular cloning laboratories, DNA sequencing today is used chiefly to characterize newly cloned cDNAs; to confirm the identity of a clone or mutation; to check the fidelity of a newly created mutation, ligation junction, or product of a polymerase chain reaction (PCR); and, in some cases, as a screening tool to identify polymorphisms and mutations in genes of particular interest. Until a few years ago, these tasks were achieved by manual labor: Virtually all steps in sequencing protocols were carried out locally and with radioactive labels. Nowadays, however, most laboratories have access to sequencing facilities equipped with oligonucleotide synthesizers and automated machines that utilize fluorescent detection systems rather than autoradiography to visualize the products of DNA-sequencing reactions. The sequences are captured automatically and transferred to computers. These machines have taken much of the grunt work out of sequencing and have greatly increased its power and accessibility. Old timers may reminisce about the joy of running a great sequencing gel and of the pleasure in deciphering its sharp bands one by one. Do not believe them, it was not that much fun.

## THE BEGINNING OF DNA SEQUENCING

---

In the mid 1970s, when molecular cloning techniques in general were rapidly improving, simple methods were also developed to determine the nucleotide sequence of DNA. The first attempts mirrored techniques developed 10 years earlier by Robert Holley's group to sequence tRNAs (Holley et al. 1964, 1965). Holley's method involved digesting RNAs with sequence-specific RNases, fractionating the resulting oligoribonucleotides by ion-exchange chromatography or two-dimensional homochromatography (Sanger et al. 1965; Brownlee and Sanger 1967), and establishing the order of bases within each fragment by exonuclease digestion. By using two different methods of fragmentation, Holley was able to establish overlaps between fragments and hence to assemble the entire 77-nucleotide sequence of a yeast alanine tRNA.

Several attempts were made to apply this method to DNA sequencing by cleaving DNA into smaller fragments with endonuclease IV or chemicals (pyrimidine tract analysis; Robertson et al. 1973; Ziff et al. 1973). However, none of these methods proved to be equal to the magnitude of the task. Indeed, the problems were so intractable that in some cases, DNA was transcribed with *Escherichia coli* RNA polymerase and then sequenced as RNA (Gilbert and Maxam 1973). Within 10 years, however, as a consequence of work in the Gilbert laboratory at Harvard University and in the Sanger laboratory at Cambridge, England, DNA sequencing was to become a routine matter, well within the range of any molecular biology laboratory.

The best-known DNA-sequencing techniques are the enzymatic method of Sanger et al. (1977a) and the chemical degradation method of Maxam and Gilbert (1977). Although very different in principle, these two methods both generate populations of oligonucleotides that begin from a fixed point and terminate at a particular type of residue. In the simplest case, four populations are created that terminate at A, G, C, and T residues, respectively. The termination points are nucleotide-specific but occur randomly along the length of the target DNA. Each of the four populations therefore consists of a nested set of fragments whose lengths are determined by the distribution of a particular base along the length of the original DNA. These populations of fragments are resolved by electrophoresis under conditions that discriminate between individual

DNAs differing in length by as little as one nucleotide (Sanger and Coulson 1978). When the four populations are loaded into adjacent lanes of a sequencing gel, the order of nucleotides along the DNA can be read directly from an image of the gel.

### The Dideoxy Method of DNA Sequencing

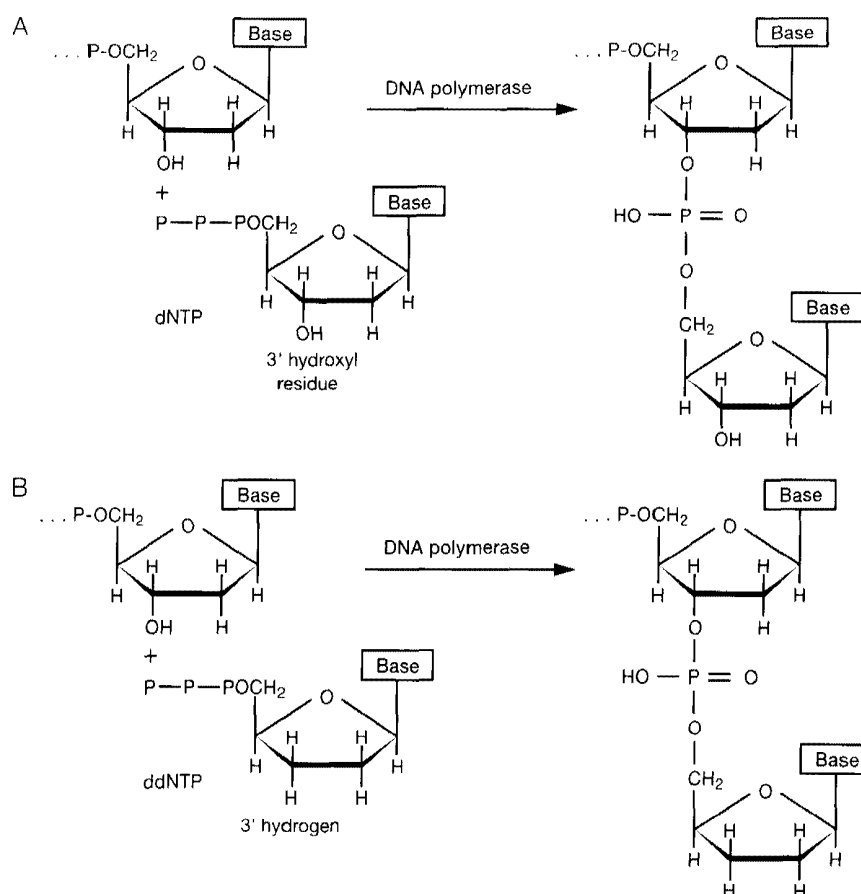
The Sanger technique uses controlled synthesis of DNA to generate fragments that terminate at specific points along the target sequence. This idea originated with Ray Wu of Cornell University, who used partial repair in the presence of one, two, or three deoxynucleoside triphosphates (dNTPs) to sequence the 12-nucleotide cohesive termini of bacteriophage  $\lambda$  DNA (Wu and Taylor 1971; Tu and Wu 1980). Wu's idea of partial repair is formally equivalent to the "minus" arm of a short-lived technique known as the "plus and minus" sequencing technique (Sanger et al. 1973; Sanger and Coulson 1975), which was the immediate forerunner of the current dideoxy-mediated chain-termination method. In the course of *in vitro* experiments to prepare DNA copies of high specific radioactivity, Sanger and his colleagues noticed that the size of newly synthesized DNA chains was frequently less than unit length. Premature termination generally occurred at the residue immediately upstream of the site at which a radioactive nucleotide should have been incorporated. This anomaly occurred because the concentration of the radiolabeled nucleotide in the reaction was far lower than that of the other three unlabeled nucleotides. The 3' ends of the resulting mixture of products therefore corresponded to the position of the nucleotide whose concentration was limiting. By carrying out four separate reactions in which each of the nucleotides was limiting in turn and separating the four sets of truncated fragments according to their size, Sanger and his colleagues were able to generate a readable DNA sequence (Sanger et al. 1977a). Although the plus and minus technique was slow and inaccurate, it was used successfully to determine almost all of the 5386-nucleotide sequence of bacteriophage  $\phi$ X174 DNA (Sanger et al. 1977b). The plus and minus system was an important advance because it first described (1) the use of a specific primer for extension by DNA polymerase, (2) base-specific chain termination, and (3) the use of polyacrylamide gels to discriminate between single-stranded DNA chains differing in length by a single nucleotide. However, the plus and the minus reactions were notoriously unreliable, and it was always difficult to get all four of them to work simultaneously, as the method required. Clearly, a further advance was required if nucleotide sequencing by controlled synthesis of DNA was to become practical.

The breakthrough came with the introduction of dideoxynucleoside triphosphates (ddNTPs) — nucleoside analogs that (1) could be substituted for deoxynucleotides at random positions during template-directed copying of a DNA strand by a DNA polymerase and (2) could efficiently terminate DNA synthesis in a base-specific manner (please see Figure 12-1) (Sanger et al. 1977a). By using ddNTPs corresponding to the conventional nucleotide bases in separate synthetic reactions, four populations of oligonucleotides could be generated that terminate at every position in the template strand. The DNA bands in the reactions could be displayed by gel electrophoresis and the DNA sequence deduced from the order of bands in the four lanes. So well did these chain terminators work that by the beginning of the 1980s, the Sanger method had become the method of choice for DNA sequencing — a position it still occupies.

### The Chemical Method of DNA Sequencing

Whereas the dideoxy-mediated chain-termination method grew logically from Sanger's earlier work on protein and RNA sequencing, the chemical method of DNA sequencing was discovered accidentally in Walter Gilbert's laboratory (please see Gilbert 1981). In the late 1960s, and early 1970s, Gilbert's work focused on the interaction between the *lac* repressor and the *lac* operator in





**FIGURE 12-1 Termination of DNA Synthesis by Incorporation of ddNTPs**

(A) DNA polymerase-catalyzed esterification of the normal dNTP with the 3'-terminal nucleotide of DNA. The reaction, which extends the length of the primer by a single nucleotide, can be recapitulated until all of the bases in the template strand (not shown) are paired with the newly synthesized strand. (B) Corresponding reaction with a ddNTP, which lacks a 3'-hydroxyl residue. The ddNTP can be incorporated into the growing chain by DNA polymerase, where it acts as a terminator because it lacks the 3'-hydroxyl group required for formation of further 5'→3' phosphodiester bonds.

in vitro. He isolated the fragment of DNA protected by the repressor and worked out its sequence by copying the DNA into RNA and then applying the techniques of RNA sequencing developed in Sanger's laboratory (Gilbert and Maxam 1973). This approach was transformed when Andre Mirzabekov, a Russian scientist, visited Harvard in 1975. Working at the Institute of Molecular Biology, Academy of Science of the U.S.S.R. in Moscow, Mirzabekov had shown that binding of histones and antibiotics to DNA could inhibit methylation of purines by dimethylsulfate. He urged Gilbert to find out whether binding of the repressor could block methylation of the operator DNA and to identify which bases in the sequence were protected. During discussion of this problem with Mirzabekov, Alan Maxam, and Jay Gralla over a lunch, Gilbert had the idea that ultimately became the basis of the chemical sequencing technique. If a DNA fragment could be labeled at one end with a radioactive phosphate group and then subjected to partial degradation with base-specific chemical reactions, the position of each base in the chain could be determined by measuring the distance between the labeled end and the point of breakage. By 1976, it was clear that the method could be used to locate adenine and guanine residues in short fragments (~40 nucleotides) of DNA. Knowing the locations of the two purine bases on each of the two comple-

mentary strands of DNA, one could, in principle, deduce a complete DNA sequence. The next year was spent in developing differential methods to cleave cytosine and thymine residues and thus to position two pyrimidine bases in a DNA sequence. By 1977, Maxam and Gilbert were able to publish a description of the complete sequencing technique (Maxam and Gilbert 1977).

From the date of this first publication until today, the chemical method of sequencing has undergone a continuous series of refinement and improvements. The number of base-specific cleavage reactions has increased, and their efficiency and discrimination have gradually improved to the point where 200–400 bases may be routinely read from the point of labeling. However, none of these improvements have been sufficient to save chemical sequencing from decline. Toxic chemicals, large amounts of radioactivity, sequencing gels that were sometimes ambiguous and all too often ugly, and most recently, the lack of automated methods to prepare end-labeled templates have all contributed significantly to the eclipse of the method by the chain-termination technique.

## THE SANGER METHOD OF DNA SEQUENCING BY DIDEOXY-MEDIATED CHAIN TERMINATION

---

The first group of protocols in this chapter deals with the practical aspects of the chain-termination method of DNA sequencing. This introduction describes the general principles of the method and the strategies commonly used to bring sequencing projects to fruition.

### General Principles

A synthetic oligonucleotide primer is annealed to a single-stranded DNA template. Four different sequencing reactions are set up each containing a DNA polymerase and the four normal dNTPs. One of the precursors or, in some cases, the primer is labeled radioactively with  $^{32}\text{P}$ ,  $^{33}\text{P}$ , or  $^{35}\text{S}$  or with a nonradioactive fluorescent tag. The four reactions also contain a small proportion of a 2',3'-ddNTP that carries a 3'-H atom on the deoxyribose moiety, rather than the conventional 3'-OH group. If a ddNTP molecule is incorporated into a growing DNA chain, the absence of a 3'-OH group prevents formation of a phosphodiester bond with the succeeding dNTP: Further extension of the growing chain is impossible. Thus, when a small amount of one of the ddNTPs is included with the four conventional dNTPs in a reaction mixture for DNA synthesis, there is competition between extension of the chain and infrequent, but base-specific, termination (please see Figure 12-1). The products of the reaction are a population of oligonucleotide chains whose lengths are determined by the distance between the 5' terminus of the primer used to initiate DNA synthesis and the sites of chain termination. In a sequencing reaction containing ddA, for example, the termination points correspond to all positions normally occupied by a deoxyadenosyl residue. By using the four different ddNTPs in four separate enzymatic reactions, populations of oligonucleotides are generated that terminate at positions occupied by every A, C, G, or T in the template strand. These populations of oligonucleotides can be separated by electrophoresis, and the locations of each band can be ascertained by autoradiography or the emission of fluorescence. When the four populations are loaded into adjacent lanes of a sequencing gel, the sequence of the newly synthesized strand can be read in a 5'-3' orientation by calling the order of bands from the bottom to the top of the gel.

### Primers

In enzymatic sequencing reactions, priming of DNA synthesis is achieved by the use of a synthetic oligonucleotide complementary to a specific sequence on the template strand. In many cases, this

template is obtained as a single-stranded DNA molecule by cloning the target DNA fragment into a bacteriophage M13 or phagemid vector (please see Chapter 3). However, it is also possible to use the Sanger method, albeit with some loss of efficiency, to sequence denatured, double-stranded DNA molecules (e.g., denatured plasmid DNA). In either case, the problem of obtaining primers that are complementary to an unknown sequence of DNA is then solved by using a “universal” primer that anneals to vector sequences flanking the target DNA. Universal primers are typically 15–30 nucleotides in length and are available from a large number of commercial companies. In addition, many companies sell primers that have been designed to allow sequencing of target DNAs cloned into a variety of restriction sites in different vectors. For details of primers that are commercially available, please see Appendix 6.

## Templates and Strategies

One of the virtues of the Sanger method of sequencing is its ability to accommodate many different types of DNA templates and many types of sequencing strategies. For example, templates can be:

- **Single-stranded DNA isolated from recombinant M13 bacteriophages** (please see Chapter 3 and Protocol 1). Alternatively, single-stranded templates can be generated synthetically in asymmetric PCRs (Innis et al. 1988; Wilson et al. 1990) (please see Chapter 8).
- **Double-stranded plasmid DNA that has been denatured by heat or alkali** (Chen and Seeburg 1985) (please see Protocol 2).
- **Double-stranded PCR-amplified DNA denatured by heat or alkali** (Gyllensten and Allen 1993; Rao 1994) (please see Protocol 2).
- **Double-stranded DNA digested with an exonuclease to expose a single-stranded template** (Higuchi and Ochman 1989; E. Lee et al. 1992).
- **Double-stranded DNA denatured by heat during cycle sequencing** (Murray 1989) (please see Protocol 6).

Faced with these possibilities, it is important to develop an overall strategy that takes into account the size of the region to be sequenced, the accuracy required of the sequence, the nature and amount of the template required, and the resources available. PCR-based methods have the advantage of by-passing time-consuming steps of cloning and purification of template DNA and allowing nucleotide sequences to be determined from crude templates, for example, lysates of cultured cells, viruses, bacteriophages, and bacteria. These methods are therefore ideal to determine the sequence of a specific region of genomic DNA (e.g., an individual exon of a mammalian gene). On the other hand, shotgun libraries constructed in bacteriophage M13 are preferred for large-scale projects where the goal is to accumulate long tracts of virgin sequence. Virtually all of these large-scale projects are carried out in sequencing factories equipped with assembly lines of robotic devices and automated machines to perform each stage of the process, from preparation of single-stranded templates to harvesting of the nucleotide sequence. By contrast, confirmatory sequencing (e.g., of mutants generated by oligonucleotide-mediated mutagenesis) often requires no more than one set of sequencing reactions to verify the order of nucleotides in a local region of one of the two strands of DNA. Although sequencing on this small scale can be simple and enjoyable, most laboratories today buy DNA-sequencing kits and use automated machines maintained in institutional core facilities to carry out their DNA sequencing. As a consequence, the laboratory often has little more to do than settle a monthly account in order to establish a nucleotide sequence.

## Choosing a Sequencing System

The majority of double- and single-stranded DNA templates can be sequenced without great difficulty at moderate temperatures (37°C) by enzymes specially tailored to the task (e.g., Sequenase). About 10% of templates, however, present problems that result for the most part from:

- **The base composition of the template.** The higher the GC content of the template, the higher its potential to form knotty secondary structures that obstruct the passage of DNA polymerases. Because secondary structures are less stable at high temperature, cycle sequencing or high-temperature isothermal sequencing is the preferred technique for GC-rich templates.
- **The base sequence of the template.** Cycle-sequencing reactions should not be used to sequence template DNAs suspected of containing a repeating sequence, for example, a dinucleotide repeat. Such regions often produce bands that are highly variable in intensity in all four channels of sequencing gels. This problem can sometimes be alleviated by using 5' <sup>32</sup>P-labeled oligonucleotides to prime high-temperature isothermal or cycle-sequencing reactions. Frequently, repetitive tracts yield cleaner sequences in reactions catalyzed at low temperature by enzymes such as Sequenase or the Klenow fragment of *E. coli* DNA polymerase I.
- **The amount of template.** Cycle sequencing with its in-built amplification of signal is the method of choice when the template DNA is in short supply.

## End Labeling or Internal Radiolabeling?

End-labeled oligonucleotide primers reduce the frequency and intensity of sequencing artifacts, most of which are caused by nonspecific priming by fragments of contaminating DNA or RNA. These terminally labeled primers are preferred when sequencing DNA templates that tend to generate messy sequencing ladders, for example, sequencing impure DNA preparations from bacterial colonies or bacteriophage M13 plaques, or large DNAs, such as bacteriophage  $\lambda$  and cosmids. When using end-labeled primers, all DNA chains become labeled to an equal extent regardless of their length. The intensity of the bands is therefore equal throughout the whole length of the gel. Sequencing ladders obtained from reactions primed by labeled oligonucleotides are therefore far easier to read than ladders produced in conventional sequencing reactions containing unlabeled primers and radiolabeled dNTPs.

Primers can be labeled at their 5' ends by transfer of the  $\gamma$ -phosphate from [ $\gamma$ -<sup>32</sup>P]ATP or [ $\gamma$ -<sup>33</sup>P]ATP in a reaction catalyzed by bacteriophage T4 polynucleotide kinase. Labeling with <sup>32</sup>P results in shorter exposure times and costs less per reaction than <sup>33</sup>P. However, the weaker  $\beta$  particles emitted from <sup>33</sup>P generate sharper bands during autoradiography, which is an advantage when longer reads are required. In addition, primers and sequencing products labeled with <sup>33</sup>P suffer less radiolytic damage and can be stored for several weeks at -20°C.

[ $\alpha$ -<sup>35</sup>S]dATP is an analog of dATP in which a sulfur atom replaces a nonbridge oxygen atom on the  $\alpha$ -phosphate. The lower energy of the  $\beta$  particles emitted by <sup>35</sup>S sharpens the image of bands on sequencing gels (Biggin et al. 1983). As with <sup>33</sup>P, the longer half-life of <sup>35</sup>S allows the radioisotope and the completed sequencing reactions to be stored for several weeks without damage. ([ $\gamma$ -<sup>35</sup>S]ATP is not a good substrate for polynucleotide kinase and is transferred inefficiently to 5'-hydroxyl groups.)

## Which Enzyme? Which Protocol? Which Kit?

A first-time sequencer who wants to use low-temperature isothermal DNA sequencing with radioactive dNTPs or radiolabeled primers should probably look no further than the kits sold by U.S. Biochemicals containing Sequenase, version 2.0. Like kits supplied by manufacturers of other enzymes, Sequenase kits contain almost everything required for isothermal sequencing, from a template DNA for use as a positive control to sets of comprehensive didactic instructions. A method to sequence using Sequenase is described in Protocol 3.

Kits provide a fast and easy way to gain some experience and confidence, but they are too expensive for routine use. Therefore, the casual sequencer who generates small numbers of templates from time to time should consider replacing the various components of the kit with homemade reagents and buying in bulk the enzyme(s) used to catalyze sequencing reactions.

At some point, when preparation of templates becomes a chore, the sequencer may want to switch to cycle sequencing (Protocol 6), again beginning with a kit. Here the choices are many and varied, but the decision among them depends on the available detection facilities. If a traditional radioactive detection system is used, a kit containing a thermostable enzyme engineered to remove 5'-3' exonuclease activity should be adequate. Obviously, it would be better to use an enzyme carrying a mutation that abolishes the preference for incorporation of dNTPs over ddNTPs (for examples of these modified enzymes, please see Table 12-9 in Protocol 5). However, these enzymes are at present significantly more expensive. All of the enzymes listed in Table 12-9 can be obtained in kit form. Some also contain a thermostable pyrophosphatase to suppress pyrophosphorolysis and thereby reduce variation in band intensity.

Finally, the more serious sequencer will need to use some form of automated DNA-sequencing facility using fluorescent detection methods. The services offered by these facilities vary widely. In some, the users bring (or mail) their completed sequencing reactions to the facility for separation by electrophoresis and capture of data on automated machines. In others, the facility carries out all steps of the sequencing process from template preparation to analysis of results. Whatever the arrangement, the sequencing protocols will almost certainly be defined by the facility, based on the expertise and the equipment available. Many facilities provide a range of kits (homemade and/or commercial) at reduced prices to their users.

This chapter is a compendium of information about DNA sequencing. The first section of the chapter deals chiefly with the enzymatic method of sequencing and contains protocols describing the production of templates and primers and the assembly of sequencing reactions. The second part focuses on the chemical method of sequencing, whereas the third and final section deals with the pouring and running of DNA sequencing gels. Computational and robotic aspects of sequencing are discussed in the information panels at the end of this chapter.

# Protocol 1

---

## Generation of a Library of Randomly Overlapping DNA Inserts

**A**LMOST ALL MOLECULAR BIOLOGISTS ARE FACED at some time in their career with the challenge of sequencing a large segment of DNA that has been cloned into a high-capacity vector such as a cosmid, bacterial artificial chromosome, or bacteriophage P1 artificial chromosome. Efficient sequencing of a cloned DNA fragment more than a few kilobases in size requires access to a high-throughput, automated DNA sequencing facility. If such a facility is available, sequencing projects of this magnitude, which until a few years ago were beyond the reach of most laboratories, are now within the capacity of any competent group.

Most large-scale sequencing projects rely on a shotgun strategy, which involves random fragmentation of the target region into small segments that can be subcloned into a bacteriophage M13 vector (Anderson 1981; Deininger 1983; Messing 1983; Baer et al. 1984; Bankier et al. 1987). The goal is to create a library of overlapping clones that provide at least fivefold sequence redundancy over the entire target fragment. Each of these clones contains a random segment of target DNA located next to a primer-binding site that can be used repeatedly to derive, on automated DNA sequencers, 600–800 nucleotides of DNA sequence. Clones chosen at random from the library are used as templates until the nucleotide sequence of at least 95% of both strands of the target DNA has been captured. Where gaps and ambiguities remain, directed sequencing is used to complete the sequence (e.g., please see Edwards et al. 1990). The accumulated data are stored, managed and assembled with the aid of computer programs (e.g., please see Dear and Staden 1991; Bonfield et al. 1995; Huang 1996; Dear et al. 1998). Please also see the collection of electronic resources in Appendix 11. Two methods are used to cleave double-stranded DNA into fragments of a suitable size for shotgun sequencing.

- **Hydrodynamic shearing.** Hydrodynamic forces are generated in a number of different ways, a few of which are listed in Table 12-1. In each case, breakage of DNA results from drag forces that first stretch and then break the phosphodiester backbone in the central regions of double-stranded DNA molecules (for discussion, please see Oefner et al. 1996). Because breakage tends to occur in the center of DNA molecules, the ends of the original DNA molecule are under-represented in shotgun libraries generated by hydrodynamic shearing. This problem can be alleviated by ligating the DNA into concatemers before exposing it to hydrodynamic shear.
- **Enzymatic Cleavage.** In the presence of  $Mn^{2+}$ , or when very high concentrations of the enzyme are used in the absence of monovalent cations, DNase I breaks both strands of double-stranded DNA simultaneously at approximately the same site (Melgar and Goldthwait 1968; Campbell

and Jackson 1980). Under these conditions, the enzyme displays very little sequence specificity and cleaves all regions of the molecule (except for the terminal nucleotides) at an equal rate. As a consequence, the fragments generated by DNase I digestion have a relatively broad size distribution. Only a small fraction of the fragments are useful for cloning and sequencing.

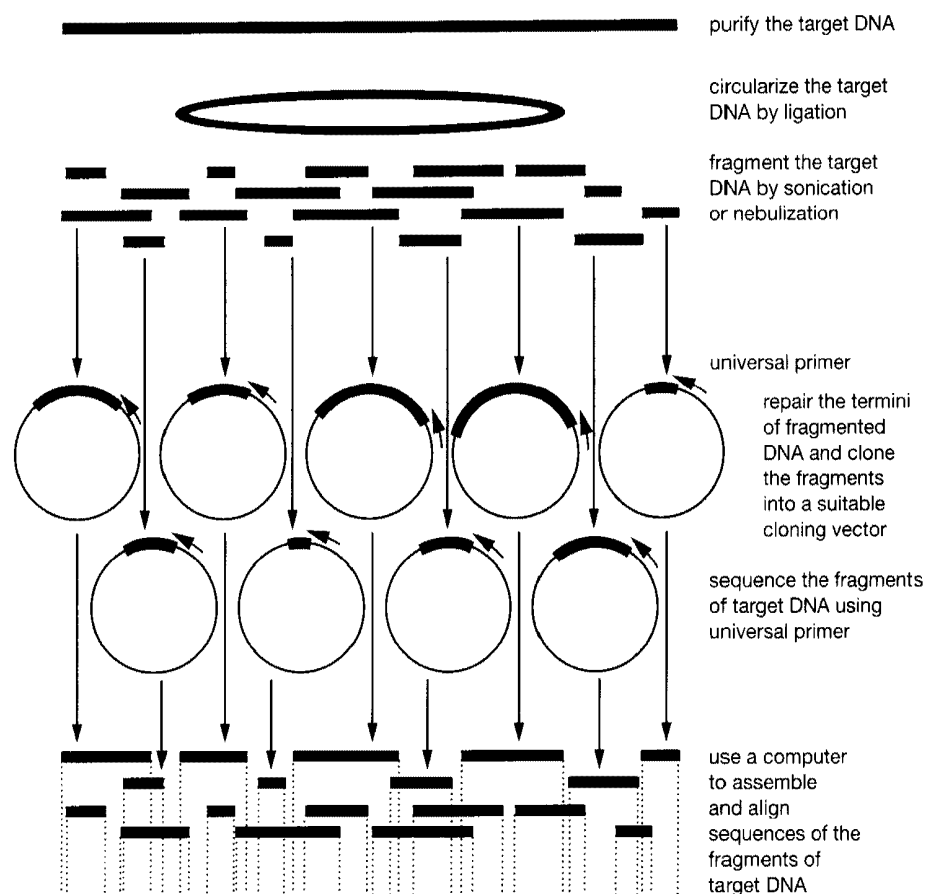
Until recently, restriction enzymes were seldom used to generate fragments for shotgun sequencing. Because complete digestion of DNA with a single restriction enzyme results in nonoverlapping fragments, separate libraries constructed from digests generated by several different restriction enzymes would be necessary to provide overlap between fragments. Partial digestion has been an unattractive option because regions of DNA with very few restriction sites would be underrepresented in shotgun libraries. However, this problem has been solved by the discovery of conditions under which the enzyme *Cvi*JI cuts DNA at the sequences PyGCPy and PuGCPu, generating blunt-ended fragments (Xia et al. 1987; Fitzgerald et al. 1992). Under these "relaxed" conditions, the enzyme finds a potential cleavage site every 16–64 bases in DNA. DNA fragments of ~1 kb obtained by partial digestion of cosmid-sized DNAs with *Cvi*JI contain many potential sites and show little representational bias (Gingrich et al. 1996). Table 12-1 summarizes the strengths and weaknesses of the various methods used to generate overlapping fragments for shotgun sequencing.

**TABLE 12-1 Methods Currently Used to Fragment DNA for Shotgun Sequencing**

METHOD	PROS AND CONS	REFERENCES	
<b>Hydrodynamic shear</b>	sonication	Requires relatively large amounts of DNA (10–100 µg); fragments of DNA distributed over a broad range of sizes; only a small fraction of the fragments are of a length suitable for cloning and sequencing. Requires ligation of DNA before sonication and end-repair afterward; DNA may be damaged by hydroxyl radicals generated during cavitation (McKee et al. 1977).	Deininger (1983)
	nebulization	Easy and quick; requires only small amounts of DNA (0.5–5 µg) and large volumes of DNA solution; no preference for AT-rich regions. Size of fragments easily controlled by altering the pressure of the gas blowing through the nebulizer; fragments of DNA distributed over a narrow range of sizes (700–1330 bp); requires ligation of DNA before nebulization and end-repair afterward.	Bodenteich et al. (1994); Hengen (1997)
	circulation through an HPLC pump	Requires expensive apparatus, ligation of DNA before sonication, and 1–100 µg of DNA; fragments of DNA distributed over a narrow range of sizes that can be adjusted by changing the flow rate; end-repair of fragments before cloning not necessary.	Oefner et al. (1996)
	passage through the orifice of a 28-gauge hypodermic needle	Cheap, easy, and requires only small amounts of DNA; however, the fragments are a little larger (1.5–2.0 kb) than required for shotgun sequencing; requires ligation of DNA before cleavage and end-repair afterward.	Davidson (1959, 1960); Schriefer et al. (1990)
<b>Enzymatic cleavage</b>	partial digestion with the restriction enzyme <i>Cvi</i> JI	Cheap, easy, and requires no special equipment; only small amounts of DNA necessary (0.5–5 µg); ligation of DNA before digestion desirable but end-repair of digested DNA unnecessary. Variable rate of digestion from experiment to experiment; each new batch of <i>Cvi</i> JI must be calibrated.	Fitzgerald et al. (1992); Gingrich et al. (1996)
	cleavage by DNase I in the presence of Mn <sup>2+</sup>	Like sonication, generates fragments with a wide distribution of sizes; only a small fraction of the fragments are of a suitable length for cloning and sequencing; requires end-repair after cleavage. Variable rate of digestion from experiment to experiment; each new batch of DNase I must be calibrated.	Anderson (1981)

Many aspects of DNA sequencing have been automated, for example, the use of robotic workstations to assemble dideoxy-mediated sequencing reactions and the automatic reading and transfer of fluorescently tagged sequence to computers. For a review of these advances, please see the information panel on **AUTOMATED DNA SEQUENCING**.

The following protocol describes the initial stages of shotgun sequencing, from shearing of the target DNA to establishment of a library of fragments in a bacteriophage M13 vector, and outlines two methods — sonication and nebulization — to break a double-stranded target DNA into overlapping pieces and to polish the ragged ends with DNA polymerases. The fragments are then fractionated according to size by agarose gel electrophoresis. After recovery from the gel, the fragments are ligated with the DNA of a bacteriophage M13 cloning vector. The products of the ligation reaction are introduced into a suitable strain of *E. coli*, and a library of recombinant bacteriophage M13 clones is established. Single-stranded DNA templates are then prepared from individual clones grown in a 96-well format, essentially as described by Zollo and Chen (1994). Figure 12-2 illustrates the steps involved in random sequencing. Subsequent protocols describe how clones selected at random from this library are used as templates in dideoxy-mediated chain-termination sequencing reactions and how the DNA sequence is completed and assembled.



**FIGURE 12-2** The Strategy for Random Sequencing

Please see text for details.



**MATERIALS**

**CAUTION:** Please see Appendix 12 for appropriate handling of materials marked with <!.>.

**Buffers and Solutions**

Please see Appendix 1 for components of stock solutions, buffers, and reagents. Dilute stock solutions to the appropriate concentrations.

*Ammonium acetate (10 M)*

*ATP*

Optional, please see Step 1.

*Ethanol*

*Glycerol (sterile, 100%)*

*H<sub>2</sub>O (deionized distilled)*

*IPTG*

*MgCl<sub>2</sub>*

*NaCl*

*Phenol (saturated with Tris at pH 7.6) <!.>*

*Phenol:chloroform (1:1, v/v) <!.>*

*Polyethylene glycol (30% w/v PEG 8000) <!.>*

Optional, please see note to Step 1.

*Polyethylene glycol (20% w/v PEG 8000) in 2.5 M NaCl*

*TE (pH 7.6)*

*10x TM buffer*

0.5 M Tris-Cl (pH 8.0)

150 mM MgCl<sub>2</sub>

*TTE buffer*

0.5% Triton X-100 in TE (pH 8.0)

*X-gal*

**Enzymes and Buffers**

*Bacteriophage T4 DNA ligase*

*Bacteriophage T4 DNA polymerase*

*Bacteriophage T4 polynucleotide kinase*

*Klenow fragment of E. coli DNA polymerase I*

**Gels**

*Agarose gels (two 1% and one 0.7%)*

*Polyacrylamide gel (neutral, 5% polyacrylamide) <!.> or Agarose gel (0.8% low-melting-point agarose)*

**Nucleic Acids and Oligonucleotides**

*Bacteriophage λ or φX174 DNA, cleaved to completion with AluI (1 μg in a volume of 20 μl of TE (pH 7.6))*

After digestion, remove the restriction enzyme from the DNA by extraction with phenol:chloroform. Recover the DNA by precipitation with ethanol and dissolve in TE (pH 7.6). The digested DNA will be used to check the efficiency of ligation of the dephosphorylated, linearized vector as described in Step 13. The digested DNA is not required if commercial preparations of vector are used.

*DNA size markers*

Appropriate size markers are, for example, fragments generated by digestion of pUC18 or pUC19 DNA with *Sau3AI*, or the 123-bp ladder sold by Life Technologies, or φX174 DNA digested with *HaeIII* (New England Biolabs).

*dNTP solution containing all four dNTPs, each at 2.0 mM*

*Target DNA*

Target DNA is usually prepared by digesting a recombinant constructed in a high-capacity vector (e.g., cosmid, BAC, PAC, or P1) with a restriction enzyme that does not cleave within the cloned sequences. Wherever possible, use a restriction enzyme that generates cohesive termini. This simplifies ligation of the purified target DNA into concatemers (Step 1). After release from the vector, purify the target DNA by electrophoresis through a gel cast with low-melting-temperature agarose (please see Chapter 5, Protocol 6 or 7). Dissolve the purified DNA in TE (pH 7.6) at a concentration of 1 mg/ml. Check the integrity and recovery of the purified DNA by analyzing an aliquot (50 ng) by agarose gel electrophoresis.

**Media**

*LB or 2x YT medium containing 5 mM MgCl<sub>2</sub>*

*Top agarose*

*YT agar plates*

**Centrifuges and Rotors**

*Centrifuge capable of spinning deep-well microplates and standard microtiter plates at 3000 rpm*

For example, Beckman GPR centrifuge equipped with a "Microplus" carrier or a Jouan Model CR 422 equipped with a swing-out rotor (M4 type) and microplate adaptors.

**Special Equipment**

*Deep-well microplates, lids, and caps*

The wells should have a 1–1.2-ml capacity and be capable of withstanding centrifugation at 3000 rpm. An example is 96-well flat-bottomed Bioblock (DBM Scientific, San Fernando, California) and caps (V3-Verl-Tips-Cover, Ulster Scientific; order through Baxter Inc., McGaw Park, Illinois). An alternative is the Beckman 96-tube box equipped with tubes fitted with a one-piece lid and a cap. Two boxes with lids and one cap are required to prepare 96 M13 templates.

*Microtiter plates (96-well, fitted with lids)*

Please see the information panel on **MICROTITER PLATES**.

*Multichannel pipettor (8 or 12 channels)*

*Multitube vortex mixer*

*Silver tape (3M Corporation) or equivalent*

The tape must be capable of effecting a watertight seal across the 96-tube box. The R.S. Hughes Co. (<http://www.rshughes.com>) distributes this 3M silver tape in the United States and Mexico.

*Sonicator or Nebulizer*

Please see Appendix 8.

For sonication, use either a microtip probe sonicator or a cup-horn sonicator. In this protocol, we recommend a cup horn sonicator (e.g., Heat Systems model XL2015 with a CL4 cup horn probe) for two reasons: (1) The DNA is contained in a small volume (20–25  $\mu$ l) within a microfuge tube and (2) there is no contamination by a metal probe because the probe of the cup horn sonicator does not touch the DNA solution.

For nebulization, modify a disposable therapeutic nebulizer (IPI Medical Products, model 4207) as described in Appendix 8.

*Toothpicks*

*Water baths preset to 16°C, 37°C, 68°C, and 80°C*

**Vectors and Bacterial Strains**

*Bacteriophage M13 vector DNA, equipped for blue-white screening, linearized, blunt-ended, and dephosphorylated*

Vector DNAs of this type may be purchased ready-made from several commercial vendors. Otherwise, prepare the vector DNA as described in the additional protocols at the end of this protocol.

*E. coli competent cells of an appropriate strain (e.g., XL1F'-Blue, DH5 $\alpha$ F')*

To obtain a library that covers the target DNA to the greatest depth, it is important that the efficiency of transfection of *E. coli* be as high as possible ( $>10^9$  transfectants/ $\mu$ g of closed circular vector DNA). Preparations of competent *E. coli* that can be transformed with high efficiency may be purchased ready-made from several commercial vendors or may be prepared as described in Chapter 1, Protocols 23–26. If an electroporation apparatus is available, we recommend using preparations of electrocompetent *E. coli*, because of their higher efficiencies of transformation.

**METHOD****Self-ligation of the Target DNA**

Self-ligation is required to ensure that sequences at the ends of the target DNA are adequately represented in the population of fragments used to construct the library.

1. Transfer 5–10 µg of the purified target DNA (see Materials) to a fresh microfuge tube and add:

10x bacteriophage T4 DNA ligase buffer	2.5 µl
5 mM ATP	2.5 µl
30% w/v PEG 8000 ( <i>optional</i> )	5.0 µl
bacteriophage T4 DNA ligase	0.5–2.0 Weiss units
H <sub>2</sub> O	to 25 µl

Incubate the mixture for 4 hours at 16°C, and then inactivate the ligase by heating the mixture for 15 minutes at 68°C.

If the target DNA is blunt-ended, include PEG in the reaction to increase the efficiency of ligation.

Use 0.5 Weiss unit for cohesive termini, and 2.0 Weiss units for blunt termini.

Some commercial ligase buffers contain ATP. When using such buffers, the addition of ATP is not required.

2. Add 175 µl of TE (pH 7.6), and purify the ligated DNA by extraction with phenol:chloroform. Recover the ligated DNA by precipitation with 3 volumes of ethanol in the presence of 2.0 M ammonium acetate. After centrifugation at maximum speed for 5 minutes in a microfuge, wash the pellet with 0.5 ml of 70% ethanol at room temperature and centrifuge again.
3. Remove as much of the supernatant as possible and allow the last traces of ethanol to evaporate at room temperature. Dissolve the DNA in 25 µl of TE (pH 7.6) in a microfuge tube.

**Fragmentation of the Target DNA**

This step was adapted from Birren et al. (1997, pp. 419–422 with permission).

4. Fragment the target DNA into segments 0.8–1.5 kb in length by sonication or nebulization (please see Table 12-1).

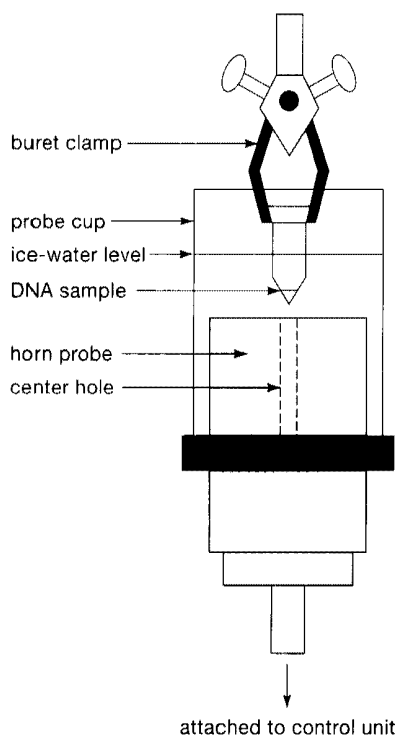
**TO FRAGMENT THE DNA BY SONICATION (PLEASE SEE FIGURE 12-3)**

- a. Place ice water in the cup horn of the sonicator. Set the sonicator power switch to on, the timer to hold, and the power setting to 10. Apply two 40-second pulses, and allow the sonicator to warm up.

The ice water helps prevent denaturation of the DNA. It is advisable to replace the ice water in the cup horn before each sample is sonicated.

- b. Place the tube containing the DNA in the ice water such that the bottom of the tube is 1–2 mm above the hole in the center of the cup horn probe (please see Figure 12-3), and sonicate the DNA.

Establish the appropriate conditions for sonication (the power setting and the number and duration of pulses) by sonicating a test sample of DNA and analyzing the results as described in Step d. For most DNA samples, two 6-second pulses at a power setting of 3 typically produce fragments of 500–2000 bp.



**FIGURE 12-3 Cup Horn Sonicator for Random Fragmentation of DNA**

The cup horn attachment for a Heat Systems sonicator is depicted with a sample tube in place. The cup horn unit, which contains a large horn probe, is attached to the sonicator control unit and filled with ice water before the sample is sonicated. Typically, the sample tube is held in place from above by using a buret clamp and a ring stand. Alternatively, a tube holder can be fabricated from 1/4-inch plastic and used to hold up to eight tubes for simultaneous processing. (Redrawn, with permission, from Birren et al. 1997.)

- c. Centrifuge the tube briefly to collect the sonicated DNA sample at the bottom of the tube and place it on ice.
- d. Analyze 1  $\mu\text{l}$  of the sonicated DNA sample with the appropriate molecular-weight markers by electrophoresis through a 0.7% agarose gel. Keep the remainder of the DNA on ice while the gel is running.

If the desired size range of sheared DNA has not been obtained, sonicate the sample again using altered conditions. If the size range is acceptable, proceed with end-repair of the DNA as described in Step 5.

#### TO FRAGMENT THE DNA BY NEBULIZATION (PLEASE SEE FIGURE 12-4)

- a. Prepare the following DNA solution and place it in the nebulizer cup.

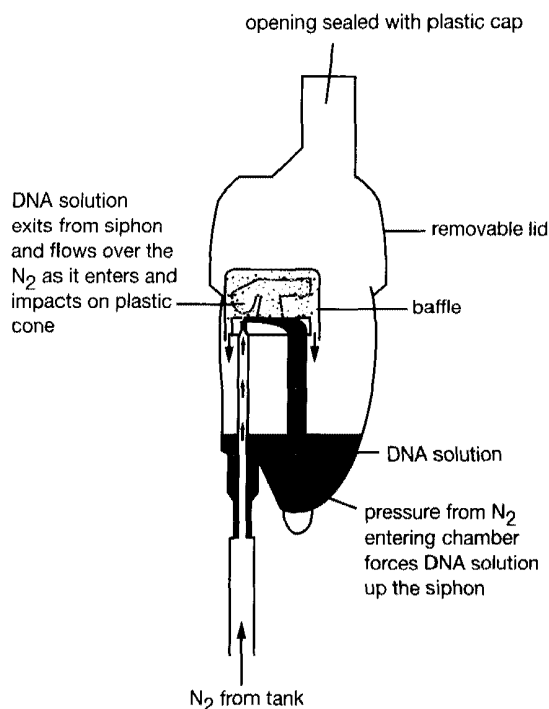
DNA sample (from Step 3)	5–10 $\mu\text{g}$
10x TM buffer (pH 8.0)	200 $\mu\text{l}$
sterile 100% glycerol	1 ml
sterile $\text{H}_2\text{O}$	to a final volume of 2 ml

- b. Place the DNA sample in an ice-water bath and nebulize using the empirically determined optimal conditions.

The size of the DNA fragments is determined primarily by the pressure of the nitrogen gas. For example, a pressure of 8 psi ( $0.56 \text{ kg/cm}^2$ ) typically shears cosmid DNA into fragments of 1000–2500 bp. The optimal pressure and length of time for nebulization should be established empirically for each type of target DNA when this method is first used.

As with sonication, the use of an ice-water bath prevents degradation of the DNA and is therefore important for generating an even distribution of DNA fragment sizes.

- c. Place the nebulizer in a suitable centrifuge rotor and cushion it with pieces of styrofoam. Centrifuge at 2000g (1000 rpm in a centrifuge equipped with a microplate adaptor) briefly at 4°C to collect the DNA sample at the bottom of the nebulizer cup.



**FIGURE 12-4 Nebulizer for DNA Fragmentation**

A viscous DNA solution containing glycerol is placed in the nebulizer. The nebulizer is attached to a nitrogen tank. Pressure from the nitrogen entering the chamber syphons the DNA solution from the bottom of the chamber to the top. The solution exits the siphon and impacts on a small plastic cone suspended near the top of the chamber, thus shearing the DNA.

- d. Divide the DNA sample into four equal aliquots in 1.5-ml microfuge tubes, carry out standard ethanol precipitation of the DNA, and dry the DNA pellets under vacuum.
- e. Dissolve each DNA pellet in 35  $\mu$ l of TE (pH 7.6), and analyze 1  $\mu$ l of the sheared DNA with appropriate molecular-weight markers by electrophoresis through a 0.7% agarose gel. Keep the remainder of the DNA at 4°C while the gel is running.

If the desired size range of sheared DNA has not been obtained, fragment the sample again using altered conditions. If the size range is acceptable, proceed with end-repair of the DNA as described in Step 5.

## Repair, Phosphorylation, and Size Selection of DNA

The termini produced by nebulization and sonication are highly heterogeneous, consisting of blunt-ended and frayed ends, with and without phosphate residues. Because only a fraction of these molecules can be repaired by DNA polymerases, the efficiency with which hydrostatically sheared DNA can be cloned in bacteriophage M13 vectors is generally low. However, 5–10  $\mu$ g of sonicated, repaired, and size-selected target DNA generally yields several thousand recombinant clones.

5. To the fragmented DNA (~25  $\mu$ l) add:

10x bacteriophage T4 DNA polymerase buffer	4.0 $\mu$ l
2.0 mM solution of four dNTPs	4.0 $\mu$ l
bacteriophage T4 DNA polymerase	5 units
H <sub>2</sub> O	to 40 $\mu$ l

Incubate the reaction for 15 minutes at room temperature, and then add ~5 units of the Klenow fragment. Continue incubation for a further 15 minutes at room temperature.

This reaction uses two DNA polymerases to repair the frayed ends of the DNA fragments generated during hydrodynamic shearing. Bacteriophage T4 DNA polymerase catalyzes filling of recessed 3' termini and the exonucleolytic removal of protruding 3' termini. The Klenow fragment provides a second means to fill recessed 3' termini. Please see the information panel on **THE KLENOW FRAGMENT OF *E. COLI* DNA POLYMERASE I**.

6. Purify the DNA by extraction with phenol:chloroform. Transfer the aqueous (upper) phase to a fresh tube, and adjust the solution to 0.1 M NaCl. Recover the DNA by precipitation with 2 volumes of ethanol. Wash the pellet with 70% ethanol.
7. Redissolve the precipitated DNA in 25  $\mu$ l of TE (pH 7.6).
8. Combine the following in a microfuge tube:
 

fragmented DNA	23 $\mu$ l
10x polynucleotide kinase buffer	3 $\mu$ l
20 mM ATP	3 $\mu$ l
bacteriophage T4 polynucleotide kinase	1 unit

Bacteriophage T4 polynucleotide kinase catalyzes the phosphorylation of the 5' termini of the blunt-ended DNA fragments. This step is not mandatory, but, in most cases, leads to more efficient ligation of the fragments to the vector.
9. Incubate the reaction for 30 minutes at 37°C.
10. Purify the fragments of DNA of the desired size (0.8–1.5 kb) by electrophoresis through a low-melting-temperature agarose gel (0.8%) or 5% neutral polyacrylamide gel (see Chapter 5).
 

To minimize the possibility of contamination, leave several lanes empty between the fragmented target DNA and the molecular-weight markers. This is especially important when using blunt-ended DNAs as markers since these are ligated to the vector DNA with much higher efficiency than the sheared target DNA.
11. Recover the target DNA from the gel by one of the methods described in Chapter 5. Dissolve the purified DNA in 25  $\mu$ l of TE (pH 7.6).
12. Check the integrity and recovery of the purified DNA by analyzing an aliquot (1.0  $\mu$ l) by electrophoresis through a 1% agarose gel.

### Ligation to Vector DNA

13. Set up a series of test ligations containing 50 ng (~0.01 pmole) of linearized and dephosphorylated vector DNA and increasing concentrations of fragmented, blunt-ended, phosphorylated target DNA (please see Table 12-2).

**TABLE 12-2 Test Ligation Reactions of Dephosphorylated Vector DNA**

TUBE	TYPE OF DNA <sup>a</sup>			H <sub>2</sub> O ( $\mu$ l)	10X LIGATION BUFFER ( $\mu$ l)	ATP (5 mM) ( $\mu$ l) <sup>b</sup>	T4 DNA LIGASE (WEISS UNITS)	30% PEG (OPTIONAL) <sup>c</sup> ( $\mu$ l)
	A	B	C					
1	+			5.0	1.0	1.0	2.0	1.6
2	+			6.0	1.0	1.0	—	1.6
3	+	+		3.0	1.0	1.0	2.0	1.6
4	+		+	3.0	1.0	1.0	2.0	1.6
5	+		+	3.0	1.0	1.0	2.0	1.6
6	+		+	3.0	1.0	1.0	2.0	1.6
7	+		+	3.0	1.0	1.0	2.0	1.6

<sup>a</sup>A = 50 ng of linearized, dephosphorylated vector (in a volume of 2  $\mu$ l); B = 20 ng of bacteriophage  $\lambda$  DNA or  $\phi$ X174 RF DNA cleaved to completion with *AluI* (in a volume of 2  $\mu$ l); C = fragmented, blunt-ended, phosphorylated target DNA. Tubes 4, 5, 6, and 7 should contain 10, 20, 50, and 100 ng of size-selected, fragmented target DNA, respectively (100 ng of size-selected fragments = ~0.1 pmole).

<sup>b</sup>Some commercial ligase buffers contain ATP. When using such buffers, omit the ATP.

<sup>c</sup>The efficiency of ligation can be increased by adding PEG 8000 (30% w/v) to a concentration of 5% in the final ligation mixture (see Chapter 1, Protocol 19). It is important to warm the stock solution of PEG 8000 to room temperature before adding it as the last component of the ligation reactions. DNA can precipitate at cold temperatures from solutions containing PEG 8000.

14. Introduce aliquots of the test ligations into competent *E. coli* of the appropriate strain by electroporation or transformation (please see Chapter 1, Protocols 23–26). Plate the bacteria on media containing IPTG and X-gal. Incubate the plates overnight at 37°C.

The purpose of this step is to find a concentration of fragmented target DNA that minimizes the number of recombinants containing artificially fused target fragments, which can complicate assembly of the final DNA sequence. When setting up a large-scale ligation reaction (Step 16), avoid using saturating quantities of target DNA; instead, use an amount of target DNA that produces a modest increase (~5-fold) in the number of recombinant clones over background.

15. The following day, count the number of blue and colorless plaques.

The number of recombinants obtained with fragmented, blunt-ended target DNA should be ~10-fold lower than the number obtained with an equivalent amount of blunt-ended DNA prepared by restriction digestion (e.g., the *AluI*-digested  $\lambda$  or  $\phi$ X174 DNA used in the initial test ligations).

If the yield of clones is low, treat the preparation of DNA fragments successively with calf alkaline phosphatase and mung bean nuclease, and then repeat Steps 5–15 of this protocol. For protocols on treating DNA with CIP and mung bean nuclease, please see Chapter 1, Protocol 20.

16. Set up a large-scale ligation reaction using the minimum amount of fragmented, blunt-ended target that will yield sufficient recombinant clones to complete the sequencing project and transform *E. coli* with the ligated DNA. Incubate the plates overnight at 37°C.

The goal is to cover the target fragment with at least a fivefold redundancy of recombinant clones.

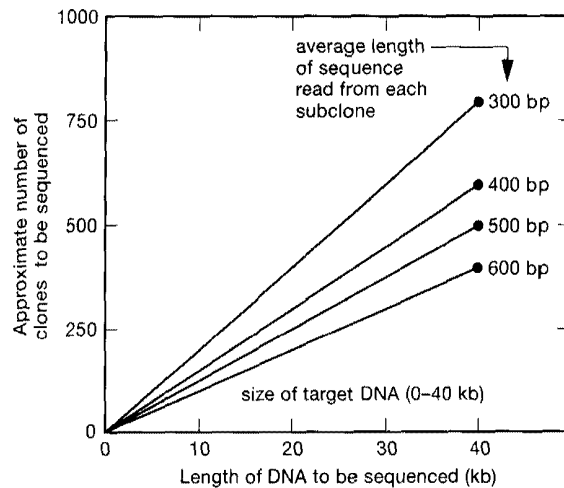
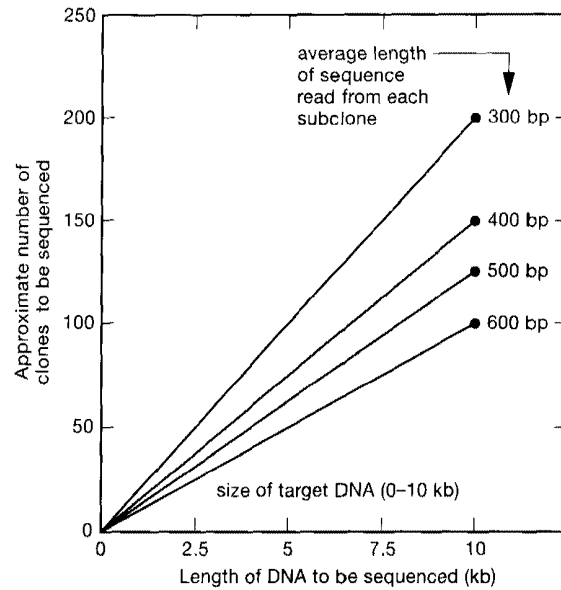
Figure 12-5 shows graphical plots of the approximate number of clones that must be sequenced to achieve 95% coverage of a double-stranded target DNA.

17. The following day, collect the plates and store the resulting transformants under the appropriate conditions until required. Prepare template DNAs from a series of individual colorless plaques as described in Chapter 3, Protocol 4.

Pick and propagate recombinant bacteriophage M13 plaques as soon as possible (please see the panel on **PICKING PLAQUES** in Chapter 3, Protocol 2). Since the bacteriophage particles diffuse considerable distances through the top agar, plaques grown for extended periods of time (>12–16 hours) at 37°C or stored for a few days at 4°C frequently become contaminated. Both the intensity and number of background bands increase when single-stranded DNAs prepared from old plaques are used in sequencing reactions.

### Growth of Recombinant Clones of Bacteriophage M13 in a 96-tube Format

Individual colorless plaques, picked as described in Chapter 3, Protocol 2, may be grown in 2-ml bacterial cultures in 15-ml tubes. The recombinant virus particles can then be recovered and DNA purified from each individual culture (Chapter 3, Protocols 3 and 4). The template purification procedure is slow and unwieldy, since only one or two dozen clones can be processed at a time. Large-scale sequencing projects typically require many thousands of DNA templates. Preparations of single-stranded DNA simply cannot be produced in a timely and economic fashion by methods that require extraction with organic solvents and multiple centrifugation steps. Instead, mass production of bacteriophage M13 templates for large-scale sequencing generally involves purification of bacteriophage particles or single-stranded DNAs using filtration (Eperon 1986), magnetic beads (Alderton et al. 1992; Wahlberg et al. 1992; Hawkins et al. 1994), or paramagnetic particles (Fry et al. 1992; Wilson 1993) in conjunction with robotic devices (e.g., please see Mardis and Roe 1989; Smith et al. 1990). The equipment and personnel required to feed and manage these devices are beyond the reach of most academic laboratories. However, Zollo and Chen (1994) have described a robust and reproducible method for the growth and preparation of single-stranded DNAs from bacteriophage M13 clones grown in a 96-well format. The templates are required in large numbers to satisfy the appetites of fluorescence-based automated DNA sequencing machines.



**FIGURE 12-5** Approximate Number of Sequences That Must Be Read from Randomly Selected Subclones to Achieve 95% Coverage of a Double-stranded Sequence

The theoretical number of sequences that must be read from randomly selected subclones to achieve 95% coverage of both strands of a sequence (i.e., four- to sixfold sequence redundancy) in a shotgun sequencing project is depicted for 0–10-kb targets (top) and 0–40-kb targets (bottom). These rough estimates are shown for reading sequences with various average lengths. Project requirements will vary with the sequence composition and complexity of the target DNA and with the presence of repeated sequences. Note that the number of subclones required is based on obtaining sequencing data from subclones that actually contain segments of the target DNA — not from those containing vector DNA or contaminating DNA. (Adapted, with permission, from Birren et al. 1997.)

For shotgun sequencing projects, it is much more efficient to grow the bacteriophage M13 recombinants, 96 at a time, in small-scale bacterial cultures grown in flat-bottomed wells in disposable trays or in disposable tubes arrayed in boxes. All of the subsequent steps involved in preparation of single-stranded DNA templates can be carried out in the same format. Minimizing the work involved in transfer of clones from one step to the next allows one investigator to prepare 960 or more DNA templates in 1 day (please see Zollo and Chen 1994).



18. For each set of 96 clones, inoculate 100 ml of LB medium or 2× YT medium in a 500-ml flask with a single colony of a suitable F' strain of *E. coli* (e.g. XL1-Blue, XL1-Blue MRF', or DH5αF'). Incubate the culture for 6–8 hours at 37°C with agitation at 300 rpm or until it enters the early log phase of growth.
19. Add MgSO<sub>4</sub> to the culture to a final concentration of 5 mM.
 

To maintain balance and symmetry during centrifugation, it is best to grow bacteriophage M13 clones in even-numbered multiples of 96.

Mg<sup>2+</sup> increases the yield of bacteriophage M13 and eliminates much of the asynchrony between the growth rate of different clones (Reddy and McKenney 1996).

Approximately 80 ml of cells are required to grow each set of 96 bacteriophage M13 clones.
20. Use a multichannel pipettor to transfer 0.8-ml aliquots of the cells to individual tubes in a 96-tube box.
21. Wearing gloves, use sterile toothpicks to transfer individual well-separated, colorless bacteriophage M13 plaques into each tube of the 96-tube arrays. Stab the toothpick into the middle of a plaque and then drop the toothpick into the culture tube.
22. To avoid confusion, leave the toothpicks in the tubes until all 96 tubes in the box have been inoculated.
23. When the last plaque has been picked, remove the toothpicks, and seal the box. Label the box and place it in an orbital shaker set at 250–300 rpm and 37°C. Repeat Steps 20 and 21 as needed. Incubate the infected cultures for 8–12 hours.
 

If the cultures are incubated for >12 hours, the preparations of single-stranded templates may be contaminated to a significant extent by bacteriophage M13 double-stranded replicative form DNA and/or chromosomal DNA. These DNAs, which originate from lysed bacterial cells, increase the opportunity for mispriming during the dideoxy-sequencing reaction. Longer incubation times also provide opportunities for deletion and for rearrangement of cloned segments of DNA. Short incubation periods are therefore the key to success with this method.

### Purification of M13 DNAs

24. Remove the boxes from the incubator and pellet the bacterial cells by centrifugation at 2400g (3000–3250 rpm in a centrifuge equipped with a microplate adaptor) for 20 minutes.
 

A master stock of bacteriophage M13 clones can be made by mixing 25 μl of 80% glycerol with 50 μl of each of the supernatants. Mix the solutions well by pipetting up and down and store the archival plates at –80°C. These plates serve as a source of infectious bacteriophage if additional preparations of template DNAs are required. This is the last point in the protocol at which archival stocks can be safely made. From this point on in the protocol, there is a high probability of cross-contamination between tubes. This does not matter for DNA sequencing but is unacceptable for archival stocks.
25. Use a multichannel pipettor to transfer 120 μl of 20% PEG 8000 in 2.5 M NaCl to individual tubes in a fresh 96-tube box.
26. Carefully remove the tubes from the centrifuge; use the multichannel pipettor to transfer 0.6 ml of each supernatant to a tube containing the PEG/NaCl solution.
 

▲ **IMPORTANT** Do not disturb the pellet of bacterial cells during this step. Inclusion of bacteria will drastically reduce the quality of DNA sequence obtained.
27. Place a 96-tube cap over the tubes containing the bacteriophage suspensions and PEG/NaCl solution. Make sure that a liquid-tight seal has formed, and then mix the solutions by invert-

ing the box several times. Incubate the box for 30 minutes at room temperature, followed by a 30–60-minute incubation on ice.

28. Collect the precipitated bacteriophage by centrifugation of the boxes at 2400g (3000–3250 rpm in a centrifuge equipped with a microplate adaptor) for 30 minutes. Remove a row of tubes and drain the supernatant by inversion over a sink. A small white pellet should be visible on the bottom of each tube. Return the row of tubes to the box.
29. When all of the tubes have been emptied, invert the boxes on a paper towel and allow the last traces of supernatants to drain for a few minutes. Keeping the box in an upside-down position, replace the wet paper towel with a fresh dry towel. Transfer the inverted box-towel combinations to the centrifuge. Remove the last traces of PEG/NaCl solution from the bacteriophage M13 pellets by centrifugation at 300 rpm for 3–5 minutes.
30. Remove the boxes from the centrifuge, check that the pellets have remained in place, and add 20  $\mu$ l of TTE buffer to each tube.
 

If the recombinant bacteriophages have grown well, the pellets should be white and opaque; if grown less well, they should be bluish and opaque. If the pellets have a brownish hue, it is likely that bacterial cells have been accidentally transferred in significant numbers at Step 26. Templates prepared from brown pellets yield poor-quality sequencing data.
31. Seal the tubes with 3M silver foil tape and shake the boxes vigorously on a multitube vortexer for 15–30 minutes.
32. Centrifuge the boxes briefly to bring the solution to the bottom of the tubes. Pry the base from each of the 96-tube boxes and place the tubes in an 80°C water bath for 10 minutes.
 

This step lyses the bacteriophage M13 particles. Removing the base of the box ensures that all tubes are incubated at 80°C for the full 10 minutes.
33. Remove the tubes from the water bath and allow them to cool to room temperature. Replace the bottoms of the boxes and briefly centrifuge each unit to bring the solutions to the bottom of the tubes.
34. Use a multichannel pipettor to transfer 70  $\mu$ l of sterile H<sub>2</sub>O to the individual wells of 96-well microtiter plates. Transfer the bacteriophage lysates from the tubes in Step 33 to the microtiter plate wells. Mix the two solutions by pipetting up and down. Seal the plates with a strip of 3M silver foil tape or with the plate lid if sequencing is to be carried out within the next 24–48 hours. Label each plate and store it at –20°C.
 

The yield of single-stranded bacteriophage M13 DNA should be 2.5–5  $\mu$ g per starting culture.
35. Examine aliquots (5  $\mu$ l) of DNA selected at random from a few wells by electrophoresis through a 1% agarose gel.
 

If everything has worked well, there should be little variation in yield from tube to tube. Between 2  $\mu$ l and 7.5  $\mu$ l of each DNA preparation should be used in cycle sequencing reactions (see Protocol 6).

**ALTERNATIVE PROTOCOL: PREPARATION OF SMALL NUMBERS OF SINGLE-STRANDED DNA TEMPLATES FROM BACTERIOPHAGE M13**

This protocol is an abbreviated version of Protocol 4 in Chapter 3. Please refer to Protocol 4 for required materials.

**Method**

1. Inoculate 5 ml of 2x YT medium in a 17 x 100-mm tube with a single colony of an appropriate F' strain of *E. coli* (e.g., XL Blue-1, DH5 $\alpha$ F'). Incubate the culture overnight at 37°C with agitation at 300 rpm.
2. Transfer 0.1 ml of the culture into 5 ml of 2x YT medium containing 5 mM MgSO<sub>4</sub> in a disposable 30-ml centrifuge tube. Incubate for 2 hours at 37°C with vigorous agitation.
3. Dilute the 5-ml culture into 45 ml of 2x YT medium containing 5 mM MgSO<sub>4</sub> and dispense 1.5-ml aliquots into as many sterile 13 x 100-mm tubes as there are plaques to grow.
4. Use sterile toothpicks or a sterile needle to inoculate each tube with a separate bacteriophage M13 plaque. Incubate the tubes for 8–12 hours at 37°C with vigorous agitation.
5. Transfer ~1.2 ml of each culture to a separate microfuge tube and centrifuge the tubes at maximum speed for 5 minutes at room temperature.  
The remainder of each culture can be stored and used as a master stock.
6. Transfer exactly 1 ml of each supernatant to a fresh microfuge tube containing 200  $\mu$ l of 20% PEG 8000 in 2.5 M NaCl. Mix the suspensions by inverting the tubes several times. *DO NOT VORTEX!* Incubate the tubes for 15–30 minutes at room temperature.
7. Recover the precipitated virus particles by centrifugation at maximum speed for 10 minutes. Remove *every last drop* of the supernatant from each tube by careful aspiration.
8. Resuspend the small white pellets of bacteriophage particles in 100  $\mu$ l of TE (pH 8.0) by vortexing. Do not proceed until the pellets have completely dispersed.
9. Add 100  $\mu$ l of phenol equilibrated in TE (pH 8.0). Mix the phases by vortexing twice for 30 seconds. Separate the phases by centrifugation for 3 minutes at room temperature in a microfuge.
10. Transfer the upper, aqueous phase to a fresh microfuge tube and recover the single-stranded DNA by precipitation (15–30 minutes at room temperature) with 2 volumes of ethanol in the presence of 0.3 M sodium acetate (pH 5.2). Recover the precipitate of DNA by centrifugation at maximum speed for 5 minutes at 4°C.
11. Carefully wash the precipitate of DNA with 70% ethanol and centrifuge again. Remove the supernatant by careful aspiration and allow the pellet of DNA to dry at room temperature.
12. Dissolve the DNA in 40  $\mu$ l of TE (pH 8.0).

The yield of single-stranded DNA is usually 5–10  $\mu$ g/ml of the original infected culture. Usually 2–3  $\mu$ l of the DNA preparation is required for each set of four DNA sequencing reactions using dye primers. The integrity and amount of DNA in each preparation can be estimated by analyzing 2–4- $\mu$ l aliquots by electrophoresis through a 1.0% agarose gel containing ethidium bromide.

**ADDITIONAL PROTOCOL: PREPARATION OF DEPHOSPHORYLATED BLUNT-ENDED BACTERIOPHAGE M13 VECTOR DNA FOR SHOTGUN CLONING****Method**

1. Set up two tubes, A and B, each containing 5 µg of the replicative form of the DNA of the desired bacteriophage M13 vector. Adjust the volume of each tube to 44 µl with H<sub>2</sub>O and then add 5 µl of the appropriate 10x restriction buffer. Digest both aliquots of DNA with a restriction enzyme that cleaves once within the polycloning site and generates blunt termini (e.g., digest M13mp18 and/or M13mp19 with *HincII*).
2. Analyze aliquots of the two digests by agarose gel electrophoresis in parallel with a sample of undigested DNA, to be sure that no circular forms of the DNA remain. Continue incubating the remainder of the digestion mixtures at the appropriate temperature while the gel is running.
3. Meanwhile, digest 1 µg of bacteriophage λ DNA or other high-molecular-weight DNA of defined size to completion with *AluI*. At the end of the digestion, extract the reaction with phenol:chloroform and precipitate the DNA with ethanol. Redissolve the precipitated DNA in 20 µl of TE (pH 7.6). Store the dissolved DNA on ice until needed in Step 9 of this protocol.
4. When the M13 restriction digestions are complete, add 10 µl of 10x CIP buffer to both tubes. Add 5 units of CIP to Tube A, and incubate the reactions for 15 minutes at 37°C.
5. To each tube add 2 µl of 0.5 M EDTA (pH 8.0) and 5 µl of 10% SDS. Add proteinase K to a final concentration of 50 µg/ml. Incubate the reactions for 30 minutes at 56°C.

It is important to treat the vector DNA with proteinase K at this stage to remove all traces of restriction enzyme and CIP. Subsequent ligation reactions will not work efficiently if residual enzymes are active. Although some investigators rely on heat inactivation (65°C for 1 hour, or 75°C for 10 minutes) and a single extraction with phenol:chloroform to accomplish this purification, treatment with proteinase K ensures maximum purity of the vector DNA and efficient ligation.

6. Extract the reaction mixtures once with phenol and once with phenol:chloroform. Transfer the aqueous phase to a fresh microfuge tube, and add 2 µl of 5 M NaCl. Add 2 volumes of ice-cold ethanol, and store the tube on ice for 10 minutes.  
NaCl is used instead of sodium acetate (pH 5.2) to prevent precipitation of EDTA at this step.
7. Recover the DNA by centrifugation at maximum speed for 5 minutes at 4°C in a microfuge. Remove the supernatant by aspiration, and add 1 ml of 70% ethanol at room temperature to the tube. Centrifuge again for a further 5 minutes. Carefully discard the supernatant, and store the open tube on the bench until the last traces of ethanol have evaporated. Dissolve the DNA in 100 µl of TE (pH 7.6).
8. Check the recovery and integrity of the vector DNA by analyzing an aliquot (2 µl) by electrophoresis through a 0.8% agarose gel.
9. Carry out a series of test ligations to determine the effectiveness of the phosphatase treatment. Set up five reactions as detailed in Table 12-3.
10. Incubate the ligation reactions for 12–16 hours at 16°C.
11. Transfect competent *E. coli* of an appropriate strain (see Chapters 1 and 3) using 10<sup>-2</sup>, 10<sup>-1</sup>, and 1 µl of each of the ligation reactions.
12. Plate the bacteria on media containing IPTG and X-gal. Incubate the plates at 37°C.
13. The following day, count the numbers of blue and colorless plaques. If the results of the test ligations are satisfactory, dispense the dephosphorylated vector DNA into aliquots and store them at -20°C.

Dephosphorylation should reduce the number of plaques by a factor of 50–100 (Reaction 3 vs. Reaction 1 in Table 12-3). Ligation of dephosphorylated vector to a standard preparation of blunt-ended fragments should result in a 10–50-fold increase in colorless plaques (Reaction 3 vs. Reaction 5).

TABLE 12-3 Test Ligation Reactions of Dephosphorylated M13 Vector DNA

TUBE	TYPE OF DNA <sup>a</sup>			H <sub>2</sub> O (μl)	10X LIGATION BUFFER (μl)	ATP (5 mM) (μl) <sup>b</sup>	T4 DNA LIGASE (WEISS UNITS)	30% PEG (OPTIONAL) <sup>c</sup> (μl)
	A	B	C					
1	+			5.0	1.0	1.0	2.0	1.6
2	+			6.0	1.0	1.0	–	1.6
3		+		5.0	1.0	1.0	2.0	1.6
4		+		6.0	1.0	1.0	–	1.6
5		+	+	3.0	1.0	1.0	2.0	1.6

<sup>a</sup>A = 50 ng (~0.01 pmole) of linearized, nonphosphatase-treated vector (in a volume of 2 μl); B = 50 ng of linearized, phosphatase-treated vector (in a volume of 2 μl); C = 20 ng of bacteriophage λ DNA or φX174 RF DNA cleaved to completion with *AluI* (in a volume of 2 μl).

<sup>b</sup>Some commercial ligase buffers contain ATP. When using such buffers, the addition of ATP is no longer required.

<sup>c</sup>The efficiency of ligation can be increased by adding PEG 8000 (30% w/v) to a concentration of 5% in the final ligation mixture (see Chapter 1, Protocol 19). It is important to warm the stock solution of PEG 8000 to room temperature before adding it as the last component of the ligation reactions. DNA can precipitate at cold temperatures from solutions containing PEG 8000.

# Protocol 2

---

## Preparing Denatured Templates for Sequencing by Dideoxy-mediated Chain Termination

**I**N THEORY, SEQUENCING OF DENATURED DOUBLE-STRANDED PLASMID DNA templates should work well; in practice, the results have been a little disappointing. The simultaneous isolation and purification of large numbers of plasmids has been difficult to automate, but preparing them in smaller batches by conventional techniques is obviously a deeply inefficient way to attack a DNA sequence longer than a kilobase or two. Furthermore, the results of the sequencing reactions themselves have often been less than ideal: Blank images, weak banding patterns, short read-lengths, premature termination of sequencing products, and strong stops causing bands across all lanes of the gel have all been common complaints. More recently, however, with the availability of improved DNA polymerases and the advent of cycle sequencing, the quality of DNA sequence obtained from denatured double-stranded templates has greatly improved. If care is taken with the preparation of the template, it is now possible to obtain sequences approaching the quality, if not the read-length, routinely obtained from single-stranded DNA templates.

### PREPARATION OF TEMPLATE DNA

---

The key factor that determines success or failure of sequencing of double-stranded plasmid DNAs is the quality of the template. The goal is to use a method of purification that eliminates salt and other small molecules that inhibit DNA polymerases, and to get rid of small fragments of nucleic acid that may serve as unwanted primers. In most cases, the methods used for isolation of sequencing-grade plasmid DNA from transformed bacterial cultures are based on the standard alkaline lysis procedure of Birnboim and Doly (1979). The best results, however, are obtained from large-scale preparations of plasmid DNAs that have been purified extensively by equilibrium centrifugation in CsCl-ethidium bromide gradients or by column chromatography (see Chapter 1, Protocols 9, 10, and 11). The final preparations of plasmid DNA should contain a very high proportion of closed circular molecules. Nicked circular molecules provide a source of 3'-hydroxyl termini that can be extended by DNA polymerases. In sequencing reactions that use internal labeling, the unbidden products of unwanted extension reactions can generate a band at every position of a sequencing ladder.

Plasmid templates suitable for sequencing can also be prepared from small-scale cultures. Several high-throughput methods have been described, (e.g., please see Huang et al. 1994; Mohler and Blau 1997), but, as yet, these have not been widely adopted. Commercial kits such as GENE CLEAN (Q•BIOgene), QIAprep Turbo Miniprep (Qiagen), Wizard (Magic) Minipreps (Promega), PERFECTprep (Eppendorf-5 Prime) are always an option, but they are relatively expensive and/or are limited in throughput. For routine sequencing, we recommend purifying plasmid DNA from small-scale cultures by precipitation with PEG (please see the panel on **ADDITIONAL PROTOCOL: PURIFICATION OF PLASMID DNA FROM SMALL-SCALE CULTURES BY PRECIPITATION WITH PEG** at the end of this protocol). In our hands, this method, although lengthy, consistently yields preparations of plasmid DNA of very high quality.

Dideoxy-mediated sequencing is performed on denatured plasmid DNA using gene-specific primers or universal primers that are complementary to sequences flanking restriction sites commonly used for cloning (e.g., please see Chen and Seeburg 1985; Hattori and Sakaki 1986; Mierendorf and Pfeffer 1987) (please see the information panel on **UNIVERSAL PRIMERS** in Chapter 8). Denaturation is generally achieved by exposing the closed circular plasmid DNA to alkali followed by neutralization (e.g., please see Chen and Seeburg 1985; Hsiao 1991). Alternatively, heat may be used to denature linearized preparations of double-stranded plasmid (e.g., please see Wang and Sodja 1991). However, the details of these procedures vary greatly from one paper to the next as authors seek to find conditions that prevent rapid renaturation of the template. In this protocol, we use a denaturation procedure that is thorough and reproducible, but lengthy. More rapid alternative methods of denaturation are discussed in an additional protocol at the end of this protocol.

In sequencing methods that use thermolabile DNA polymerases such as Sequenase, denaturation of the template DNA is carried out before the sequencing reaction is assembled.

The following protocol to denature plasmid DNA by alkali should be used in conjunction with Protocol 3, in which dideoxy-sequencing reactions are catalyzed by Sequenase. For cycle-sequencing reactions, which are catalyzed by a thermostable DNA polymerase, template DNA is denatured by heating the sequencing reaction to ~94°C for 3–5 minutes before beginning the thermal cycling protocol (please see Protocol 6). Table 12-4 presents the amounts of double-stranded DNA typically required for dideoxy sequencing.

**TABLE 12-4** Amounts of Double-stranded DNA Required for Dideoxy-mediated Sequencing Reactions

AMOUNT OF TEMPLATE REQUIRED (FMOLES)	SIZE OF DOUBLE-STRANDED DNA (VECTOR + INSERT) in kbp				
	1 kb	2.5 kb	5 kb	10 kb	20 kb
10	6.6 ng	16.5 ng	33 ng	66 ng	132 ng
25	16.5 ng	41 ng	82.5 ng	165 ng	330 ng
50	33 ng	82.5 ng	165 ng	330 ng	660 ng
100	66 ng	165 ng	330 ng	660 ng	1.33 µg
150	100 ng	250 ng	475 ng	1.0 µg	2.0 µg
200	133 ng	330 ng	660 ng	1.33 µg	2.66 µg
250	166 ng	410 ng	850 ng	1.66 µg	3.33 µg
500	330 ng	825 ng	1.65 µg	3.33 µg	6.66 µg

## MATERIALS

---

**CAUTION:** Please see Appendix 12 for appropriate handling of materials marked with <!.>.

### Buffers and Solutions

Please see Appendix 1 for components of stock solutions, buffers, and reagents. Dilute stock solutions to the appropriate concentrations.

*Ammonium acetate (5 M, unbuffered, pH ~7.4)*

*Chloroform:isoamyl alcohol (24:1, v/v) <!.>*

*DMSO <!.>*

Optional, please see Step 10.

*Ethanol*

*NaOH (2 N)/EDTA (2 mM) <!.>*

Prepare by appropriate dilution of a 10 N concentrated stock solution of NaOH just before use.

*Phenol, equilibrated with H<sub>2</sub>O or TE (pH 7.6) <!.>*

*Sequenase reaction buffer*

### Gels

*Agarose gel (0.8% w/v)*

### Nucleic Acids and Oligonucleotides

*Oligonucleotide primers*

Oligonucleotide primers used to sequence denatured double-stranded DNA templates are frequently longer (20–30 nucleotides) than primers normally used for sequencing single-stranded templates. Longer primers give rise to fewer artifactual bands when used with denatured double-stranded DNA templates.

For a list of “universal” primers that bind to vector sequences upstream of the target region, please see the information panel on **UNIVERSAL PRIMERS** in Chapter 8. Please also see the information panel on **PREPARATION OF STOCK SOLUTIONS OF OLIGONUCLEOTIDE PRIMERS FOR DNA SEQUENCING** at the end of this chapter.

*Plasmid DNA, closed circular, double-stranded*

Prepare plasmid DNA from small- or large-scale cultures of bacteria (see Chapter 1) or according to the additional protocol at the end of this protocol; 5 µg of DNA is required for each set of four sequencing reactions (ddA, ddG, ddC, and ddT).

### Special Equipment

*Dry ice-ethanol bath <!.>*

*Water bath preset to 65°C*

## METHOD

---

1. Transfer ~5 µg of purified plasmid DNA to a 1.5-ml microfuge tube. Adjust the volume to 50 µl with H<sub>2</sub>O. Add 10 µl of freshly prepared 2 N NaOH/2 mM EDTA solution. Incubate the mixture for 5 minutes at room temperature.
2. Add 30 µl of 5 M ammonium acetate and mix the contents of the tube by vortexing.
3. Add 45 µl of equilibrated phenol and mix the contents of the tube by vortexing.
4. Add 135 µl of chloroform:isoamyl alcohol, mix the contents of the tube by vortexing, and then separate the phases by centrifugation at maximum speed for 15 minutes at room temperature in a microfuge.



5. Carefully remove the upper aqueous phase to a fresh microfuge tube and precipitate the DNA by the addition of 330  $\mu$ l of ice-cold ethanol. Mix the contents of the tube and place it in a dry ice-ethanol bath for 15 minutes.
6. Recover the denatured DNA by centrifugation at maximum speed for 15 minutes at 4°C in a microfuge.
7. Very carefully decant the supernatant without disturbing the DNA pellet, which may or may not be visible on the side of the tube.
8. Recentrifuge the tube for 2 seconds and remove the last traces of ethanol with a drawn-out pipette tip without disturbing the DNA precipitate.
9. Allow the precipitate to dry at room temperature and resuspend the DNA in H<sub>2</sub>O at a concentration of 1  $\mu$ g/ $\mu$ l.
10. Anneal the primer DNA to the denatured template, using 5  $\mu$ g (5  $\mu$ l) of alkali-denatured plasmid DNA for each set of four DNA sequencing reactions (i.e., 1.25  $\mu$ g denatured DNA for the reaction containing the ddA reaction, 1.25  $\mu$ g for the reaction containing ddG, etc.). Set up annealing reactions as follows:

alkali-denatured DNA	5.0 $\mu$ g (in 5 $\mu$ l H <sub>2</sub> O)
DMSO (*optional)	2.0 $\mu$ l
Sequenase reaction buffer	2.0 $\mu$ l
sequencing primer	1.0 $\mu$ l (10 ng)
H <sub>2</sub> O	to 11.0 $\mu$ l

\*Please see the panel on **TROUBLESHOOTING** in Protocol 4.

Heat the mixture to 65°C for 2 minutes and then allow it to cool slowly to room temperature. Store the annealed samples on ice until the elongation/chain termination reactions are set up.

11. Proceed to Step 3 in Protocol 3.

#### TROUBLESHOOTING

A problem commonly encountered in sequencing double-stranded plasmid DNA templates is the appearance of bands at the same position in two or more lanes of the sequencing gel. These bands are frequently more intense than the bands in the authentic sequencing ladder and are usually caused by contamination of the DNA template with short DNA and RNA oligonucleotides that act as nonspecific primers in the DNA-sequencing reactions. This problem can be solved by rigorous purification of the plasmid DNA prior to denaturation. More rarely, these bands, some times called BAFLs (bands in all four lanes), result from problems with denaturation. BAFLs can sometimes be reduced in intensity and frequency by (1) switching to the faster denaturation protocol (please see the panel on **ADDITIONAL PROTOCOL: RAPID DENATURATION OF DOUBLE-STRANDED DNA**) and (2) converting the closed circular superhelical plasmid DNA to linear molecules by digestion with a restriction enzyme (Wang and Sodja 1991). Another solution to this problem is to use a <sup>32</sup>P-labeled primer in the DNA-sequencing reactions in place of a radiolabeled dNTP (see Protocol 3).

#### BACTERIOPHAGE $\lambda$ TEMPLATES FOR DNA SEQUENCING

DNAs cloned in bacteriophage  $\lambda$  can be sequenced essentially as described in this protocol. However, improved results are obtained if the bacteriophage DNA is first cleaved with restriction enzymes that release the target DNA from the vector sequences. The cloned DNA is then purified by gel electrophoresis, extraction with phenol, and precipitation with ethanol (see Chapter 5, Protocol 3). Approximately 3  $\mu$ g of DNA insert is used for each set of sequencing reactions. Alternatively, small (<3–4 kb) inserts can be amplified from a bacteriophage  $\lambda$  vector by PCR using oligonucleotide primers that flank the insertion site. The amplified product can be purified and subjected to DNA sequencing.

**ADDITIONAL PROTOCOL: RAPID DENATURATION OF DOUBLE-STRANDED DNA**

The standard protocol for denaturing double-stranded plasmid DNAs works well almost all of the time, but it is quite lengthy. The following protocol is easier and less demanding. However, the length of DNA sequence that can be read is slightly shorter than the several hundred nucleotides routinely obtained from double-stranded DNA denatured at alkaline pH.

**Additional Materials**

*Ammonium acetate (4 M)*  
*NaOH (2 N) containing 1 mM EDTA*

**Method**

1. Resuspend 5  $\mu\text{g}$  of double-stranded closed circular plasmid DNA in 18  $\mu\text{l}$  of  $\text{H}_2\text{O}$ .
2. Add 2  $\mu\text{l}$  of freshly prepared 2 N NaOH containing 1 mM EDTA.
3. Incubate the alkaline solution for 5 minutes at room temperature.
4. Add 10  $\mu\text{l}$  of 4 M ammonium acetate and 20  $\mu\text{l}$  of  $\text{H}_2\text{O}$ . Mix the contents of the tube by vortexing.
5. Precipitate the denatured DNA with 125  $\mu\text{l}$  of ice-cold ethanol and collect the precipitated DNA by centrifugation at maximum speed for 15 minutes at room temperature in a microfuge.
6. Remove the supernatant by careful aspiration and rinse the pellet with 0.5 ml of ice-cold 70% ethanol. Recover the DNA pellet by centrifugation for 2 minutes and then carefully remove the supernatant. Allow the pellet to dry in the air for a few minutes.
7. Redissolve the denatured DNA in  $\text{H}_2\text{O}$  at a concentration of  $\sim 1 \mu\text{g}/\mu\text{l}$ . Anneal the primer to the template DNA as described in Steps 10 and 11 of the main protocol.

**ADDITIONAL PROTOCOL: PURIFICATION OF PLASMID DNA FROM SMALL-SCALE CULTURES BY PRECIPITATION WITH PEG**

**CAUTION:** Please see Appendix 12 for appropriate handling of materials marked with <!>.

**Additional Materials**

*Alkaline lysis solution I*

*Alkaline lysis solution II*

Alkaline lysis solution II should be freshly prepared and used at room temperature.

*Alkaline lysis solution III, ice cold*

*Ammonium acetate (7.5 M)*

*DNase-free RNase*

*Isopropanol*

*NaCl (4 M)*

*Phenol:chloroform <!>*

*Polyethylene glycol (13% w/v PEG 8000) <!>*

*Proteinase K (10 mg/ml)*

*TE (pH 8.0)*

*Terrific Broth*

**Method**

1. Grow 5-ml cultures of transformed bacteria in Terrific Broth plus the appropriate antibiotic (see Appendix 2) overnight at 37°C with vigorous aeration.  
*E. coli* strains DH5 $\alpha$  and XL1-Blue are the preferred hosts.
2. Transfer 1.5 ml of the overnight culture to a microfuge tube and recover the bacteria by centrifugation at maximum speed for 1 minute. Remove the supernatant and replace it with another 1.5-ml aliquot of the overnight culture. Centrifuge at maximum speed for 1 minute.
3. Remove all of the supernatant by aspiration and resuspend the bacterial pellet in 200  $\mu$ l of Alkaline lysis solution I containing 5 mg/ml lysozyme.
4. Add 300  $\mu$ l of a freshly prepared solution of Alkaline lysis solution II and mix by inverting the tube several times. The solution should clear to transparency. **DO NOT VORTEX.** Store the tube in ice for 5 minutes.
5. Add 300  $\mu$ l of Alkaline lysis solution III and mix by inverting the tube several times.
6. Centrifuge the tube at maximum speed for 10 minutes at room temperature. Taking care not to disturb the pellet of bacterial debris, transfer the supernatant to a fresh microfuge tube.
7. Add DNase-free RNase to a final concentration of 25  $\mu$ g/ml. Incubate the tube for 20 minutes at 37°C.
8. Extract the preparation with 400  $\mu$ l of chloroform:isoamyl alcohol (24:1), transferring the aqueous phases to fresh tubes between each extraction. Continue the extractions until no more material is visible at the interface.
9. Add an equal volume of isopropanol, mix by vortexing, and then recover the precipitated DNA by centrifugation at maximum speed for 10 minutes at room temperature.
10. Remove the supernatant by aspiration and then wash the pellet of plasmid DNA and the sides of the tube with 70% ethanol. After centrifugation at maximum speed for 3 minutes at room temperature, remove the supernatant by aspiration and then allow the remaining ethanol to evaporate at room temperature.
11. (Optional: Use only if the length or quality of sequence obtained from recent minipreparations of plasmid DNA has been unsatisfactory) Dissolve the pellet in 100  $\mu$ l of TE (pH 8.0), add 1  $\mu$ l of proteinase K (10 mg/ml), and incubate the reaction for 20 minutes at 37°C. Extract the solution with phenol:chloroform and recover the DNA by adding 50  $\mu$ l of 7.5 M ammonium acetate and 300  $\mu$ l of ethanol. Remove the supernatant and allow the last traces of ethanol to evaporate at room temperature.
12. Dissolve the pellet in 32  $\mu$ l of H<sub>2</sub>O and then precipitate the DNA by adding 8.0  $\mu$ l of 4 M NaCl and 40  $\mu$ l of 13% PEG 8000. Mix the contents of the tube by inverting it several times and then store the tube for 1 hour on ice.
13. Recover the plasmid DNA by centrifugation at maximum speed for 15 minutes at 4°C.
14. Carefully remove the supernatant by aspiration and then wash the pellet of DNA with 500  $\mu$ l of 70% ethanol. After centrifugation at maximum speed for 3 minutes at room temperature, remove the supernatant by aspiration and then allow the remaining ethanol to evaporate at room temperature.
15. Dissolve the pellet of DNA in 20  $\mu$ l of H<sub>2</sub>O. Analyze 1.0  $\mu$ l of the preparation by agarose gel electrophoresis and store the remainder of the preparation at -20°C.

# Protocol 3

---

## Dideoxy-mediated Sequencing Reactions Using Bacteriophage T7 DNA Polymerase (Sequenase)

**S**EQUNASE, A MODIFIED VERSION OF BACTERIOPHAGE T7 DNA polymerase, is the enzyme of choice to catalyze automated or manual dideoxy-mediated isothermal DNA-sequencing reactions. Like the classical sequencing enzyme, the Klenow fragment of *E. coli* DNA polymerase I, Sequenase lacks 3'-5' exonuclease activity. However, by sharp contrast to the bacterial enzyme, Sequenase is capable of generating DNA ladders that are strikingly beautiful, where every band is of similar intensity and readable DNA sequence extends over the full length of the gel. Since its introduction (Tabor and Richardson 1987a), Sequenase has almost completely replaced the Klenow fragment, with consequent benefit to sequencing projects, large or small, manual, or robotic.

Of the several versions of Sequenase that are available (please see the information panel on **SEQUNASE**), most DNA sequencing is carried out with version 2.0. The reaction is carried out in the following three steps.

- **Denaturation of double-stranded DNA templates** (if necessary) and annealing of primer to its complementary sequence.
- **A brief polymerization reaction** in which the primer is elongated by 20–100 nucleotides. This step is performed under conditions where DNA polymerase is present in excess and the concentrations of the four dNTPs are limiting. A radiolabeled dNTP is included in the reaction so that the short elongation products become radiolabeled at multiple sites. During this preliminary polymerization reaction, most of the available dNTPs, including the radiolabeled dNTP, are incorporated into DNA.
- **Extension and termination reactions** of the elongated radiolabeled primers. This step is carried out in four reactions that contain high concentrations of unlabeled dNTPs and a single unlabeled ddNTP (ddA, ddG, ddC, or ddT).

Sequenase version 2.0 produces excellent DNA sequences using either single-stranded templates or denatured double-stranded DNA templates. This protocol, adapted from Tabor and Richardson (1987a, 1989b, 1990), describes DNA sequencing with single-stranded DNA templates (for production of single-stranded bacteriophage M13 or phagemid DNAs, please see Chapter 3, Protocols 4 and 8, and Chapter 12, Protocol 1). A method for denaturing double-stranded DNA templates in preparation for sequencing with Sequenase is described in Chapter 12, Protocol 2. For further details on sequencing PCR-amplified DNA, please see the information panel on **CONVENTIONAL CHAIN-TERMINATION SEQUENCING OF PCR-AMPLIFIED DNA**.

## MATERIALS

▲ **IMPORTANT** All the materials required for sequencing with Sequenase version 2.0 are contained in kits, sold by USB/Amersham Life Science, which include a detailed protocol describing the reagents and steps used in the sequencing reaction. This kit is invaluable for first-time or occasional sequencers, but it is expensive. After gaining experience, it may turn out to be more economical to purchase Sequenase version 2.0 in bulk and then assemble the remaining reagents locally.

**CAUTION:** Please see Appendix 12 for appropriate handling of materials marked with <!>.

### Buffers and Solutions

Please see Appendix 1 for components of stock solutions, buffers, and reagents.  
Dilute stock solutions to the appropriate concentrations.

Deionized distilled H<sub>2</sub>O (ice cold)

Dithiothreitol (100 mM)

dNTPs and ddNTPs, stock solutions (0.5 mM) of each of the four dNTPs and ddNTPs

Please see the information panel on **PREPARATION OF STOCK SOLUTIONS OF dNTPs AND ddNTPs FOR DNA SEQUENCING.**

5x Labeling mixture and ddNTP extension/termination mixtures (ddCTP, ddTTP, ddATP, and ddGTP)

These reaction mixtures can be assembled by mixing the volumes of the solutions shown in Table 12-5.

Formamide-loading buffer <!>

Sequenase dilution buffer

10 mM Tris-Cl (pH 7.5)

5 mM dithiothreitol

0.50 mg/ml bovine serum albumin

Store at -20°C

5x Sequenase reaction buffer with MgCl<sub>2</sub>

200 mM Tris-Cl (pH 7.5)

100 mM MgCl<sub>2</sub>

125 mM NaCl

Store at -20°C.

**TABLE 12-5 5x Labeling Mixture and ddNTP Extension/Termination Mixtures for Sequenase Reactions**

REACTION MIXTURE	STOCK SOLUTIONS OF dNTPs AND ddNTPs (ALL VOLUMES IN $\mu$ l)								OTHER REAGENTS	
	dCTP 0.5 mM	dTTP 0.5 mM	dATP 0.5 mM	dGTP 0.5 mM	ddCTP 0.5 mM	ddTTP 0.5 mM	ddATP 0.5 mM	ddGTP 0.5 mM	5 M NaCl	H <sub>2</sub> O
Labeling	15	15	—	15	—	—	—	—	—	955
ddCTP	160	160	160	160	16	—	—	—	10	334
ddTTP	160	160	160	160	—	16	—	—	10	334
ddATP	160	160	160	160	—	—	16	—	10	334
ddGTP	160	160	160	160	—	—	—	16	10	334

The 5x labeling mixture contains unlabeled dGTP, dCTP, and dTTP, each at a concentration of 7.5 mM. Radiolabeled dATP is added at Step 7 to a final concentration of ~30  $\mu$ M. Each of the ddNTP extension/termination mixtures contains all four dNTPs at a concentration of 160  $\mu$ M and a single ddNTP at a concentration of 0.16  $\mu$ M. The 5x labeling mixture and extension/termination mixtures should be dispensed in 50- $\mu$ l aliquots and stored frozen at -20°C.

When sequencing templates that are rich in GC structure, use base analogs such as 7-deaza-2'-dGTP or dITP in place of dGTP. If using 7-deaza-dGTP, simply replace the GTP in all the ddNTP extension/termination mixtures with an equimolar amount of the base analog.

If using dITP, substitute 30  $\mu$ l of a 0.5 mM stock solution of dITP for dGTP in the 5x labeling mixture and decrease the amount of H<sub>2</sub>O to 940  $\mu$ l. In the ddNTP extension/termination mixtures containing ddCTP, ddTTP, and ddATP, substitute 160  $\mu$ l of a 0.5 mM stock dITP solution for dGTP. In the extension/termination mixture containing ddGTP, substitute 320  $\mu$ l of 0.5 mM stock solution of dITP for dGTP, decrease the amount of ddGTP to 3.2  $\mu$ l, and decrease the volume of H<sub>2</sub>O to 187  $\mu$ l.

*5x Sequenase reaction buffer with MnCl<sub>2</sub>*

200 mM Tris-Cl (pH 7.5)

25 mM MnCl<sub>2</sub>

125 mM NaCl

Store at -20°C.

The presence of Mn<sup>2+</sup> in the Sequenase reaction buffer increases the efficiency with which Sequenase will utilize ddNTPs, even if Mg<sup>2+</sup> is also present (Tabor and Richardson 1989b). The net result is a more efficient termination of sequencing reactions closer to the starting primer. This modification is useful for improving the strength of the bands that run close to the oligonucleotide primer or when using a base analog such as dITP to iron out compressions in GC-rich regions of sequence.

To use Mn<sup>2+</sup>, add 1 μl of 5x Sequenase reaction buffer with MnCl<sub>2</sub> to the labeling reaction before adding Sequenase (Fuller et al. 1996). Alternatively, add 0.01 volume of 1 M MnCl<sub>2</sub> to the dideoxy-dNTP extension/termination mixtures (Kristensen et al. 1990). Do not use manganese-containing buffers that develop a slight yellowish color or that contain a yellow-brown precipitate.

*TE (pH 7.6)***Enzymes and Buffers***Sequenase (version 2.0)*

Sequenase is supplied by the manufacturer at a concentration of ~13 units/μl (~1 mg/ml). Store at -20°C (not in a frost-free freezer).

*Yeast inorganic pyrophosphatase*

Optional, please see Step 6. This is supplied by the manufacturer (USB/Amersham Life Science) at a concentration of 5 units/ml; it catalyzes the hydrolysis of pyrophosphate to two molecules of orthophosphate.

Pyrophosphatase can be mixed with Sequenase at a ratio of 1 unit of pyrophosphatase to 3 units of Sequenase. This is best done by mixing equal volumes of the two enzyme preparations and diluting the mixture with 6 volumes of enzyme dilution buffer. This dilutes Sequenase to its working concentration of ~1.6 units/μl and adds enough pyrophosphatase to prevent build-up of pyrophosphate; 2 μl of the mixture of diluted enzymes is required for each sequencing reaction.

**Nucleic Acids and Oligonucleotides***Oligonucleotide primer*

Use at a concentration of 0.5 pmole/μl (~3.3 ng/μl) in H<sub>2</sub>O or TE (pH 7.6).

Please see the information panel on **PREPARATION OF STOCK SOLUTIONS OF OLIGONUCLEOTIDE PRIMERS FOR DNA SEQUENCING**. For a list of universal primers that bind to vector sequences upstream of the target region, please see the information panel on **UNIVERSAL PRIMERS** in Chapter 8.

*Template DNAs (1 μg) in TE (pH 7.6)*

Single-stranded DNA (1 μg) or 2.0 μg of denatured double-stranded plasmid DNA is required for each set of four sequencing reactions. Linear double-stranded DNA can be denatured and annealed to the primer by mixing the template with an excess of primer and heating the mixture in a boiling water bath for ~2 minutes and then plunging the tube into an ice-water bath. The mixture should not be allowed to warm up and should be used without delay.

The concentration of single-stranded DNA in small-scale preparations of bacteriophage M13 recombinants varies from 0.05 μg/ml to 0.5 μg/ml, depending on the growth rate of the particular bacteriophage. Under the conditions normally used for sequencing, the template DNA is present in excess. Small variations in the amounts of template added to different sets of sequencing reactions do not generally affect the quality of the results; however, please see Table 12-6 at the end of this protocol.

**Radioactive Compounds**[α-<sup>35</sup>S]dATP (1000 Ci/mmole, 10 mCi/ml) <1>

or

[α-<sup>33</sup>P]dATP (1000–3000 Ci/mmole, ~20 mCi/ml) <1>

or

[α-<sup>32</sup>P]dATP (1000 Ci/mmole, 10 mCi/ml) <1>

Instead of internal labeling with [<sup>32</sup>P]dATP, carry out sequencing with a 5' <sup>32</sup>P-labeled oligonucleotide primer. In this case, 2 μl (~5 × 10<sup>5</sup> cpm; ~0.5 ng) of the radiolabeled primer and 2 μl of H<sub>2</sub>O are included in the reaction mixture in place of the unlabeled primer (Step 1) and [<sup>32</sup>P]dATP (Step 7). All other steps remain the same. The 5' termini of oligonucleotides are generally labeled by transfer of [γ-<sup>32</sup>P] from [γ-<sup>32</sup>P]ATP in a reaction catalyzed by polynucleotide kinase. For details of the labeling reaction, please see Chapter 10, Protocol 2.

## Centrifuges and Rotors

*Microfuge rotor or adaptors for use with 0.5-ml microfuge tubes or Swing-out rotor and microtiter-plate holder (e.g., Sorvall), lined with polystyrene foam or rubber pads*

## Special Equipment

*Microfuge tubes (0.5 ml) or Microtiter plates (flexible, heat-stable, with 96 U-shaped wells of ~300 μl capacity)*

Please see the information panel on **MICROTITER PLATES**.

*Water baths or heating blocks preheated to 37°C and 65°C*

## METHOD

▲ **IMPORTANT** When sequencing double-stranded plasmid DNAs that have already been denatured and annealed to a sequencing primer (Protocol 2), ignore the first two steps of this protocol and begin at Step 3.

1. To a 0.5-ml microfuge tube or well of a microtiter plate, add:

single-stranded template DNA (~1 μg/μl)	1 μl
oligonucleotide primer (~1 ng/μl)	3 μl
5x Sequenase reaction buffer containing MgCl <sub>2</sub> or MnCl <sub>2</sub>	2 μl
H <sub>2</sub> O	to 10 μl

2. Incubate the tightly closed tube for 2 minutes at 65°C. Remove the tube from the water bath and allow it to cool to room temperature over the course of 3–5 minutes.

Some investigators prefer to cool the annealing reactions more slowly over the course of 30 minutes in a small heating block or beaker of water. In our hands, both slow- and fast-cooling regimens yield sequence of the same quality.

3. While the primer and template are cooling, thaw the 5x labeling and ddNTP extension/termination mixtures and radiolabeled dATP. Store the thawed solutions on ice.

4. Transfer 2.5 μl of each ddNTP extension/termination mixture into separate 0.5-ml microfuge tubes or into individual wells of a microtiter plate color-coded or labeled C, T, A, and G.

The fluid should be deposited as a droplet on the wall of the tubes or wells, near the rim.

5. Make a fivefold dilution of the 5x labeling mixture in ice-cold H<sub>2</sub>O. A volume of 2 μl of the diluted labeling mixture is required for each template sequenced.

6. Dilute Sequenase in ice-cold Sequenase dilution buffer, with or without addition of yeast pyrophosphatase, as described above in Materials.

A volume of 2.0 μl, containing ~3.0 units of Sequenase enzyme, is required for each template sequenced. Store the diluted enzyme on ice at all times.

Pyrophosphatase is used to prevent reduction in band intensity during prolonged incubation of sequencing reactions. This reduction occurs because DNA polymerases (including Sequenase) can catalyze a reaction between the base at the 3' terminus of a DNA chain and pyrophosphate ions in solution. The products of the pyrophosphorolytic reaction are a free dNTP molecule and a DNA chain that is now one base shorter. Pyrophosphorolysis, which is the reverse of polymerization, occurs at an insignificant rate in most DNA-sequencing reactions. However, when the reactions are incubated for a long time or when dITP is used in place of dGTP, pyrophosphorolysis may become a problem. Since the efficiency of pyrophosphorolysis varies according to the nucleotide sequence at the 3' end of DNA chains, the intensities of some sequencing bands are reduced while others are unaffected. The consequent variation in band intensity can be prevented by using high concentrations of dNTPs or by including yeast pyrophosphatase in the reaction mixture (Tabor and Richardson 1990; Patel et al. 1991; Fuller 1992).

7. To carry out the labeling reaction, add the following to the 10- $\mu$ l annealing reaction of Step 2:

diluted labeling mixture (from Step 5)	2 $\mu$ l
0.1 M dithiothreitol	1 $\mu$ l
$[\alpha\text{-}^{33}\text{P}]\text{dATP}$ , $[\alpha\text{-}^{32}\text{P}]\text{dATP}$ , or $[\alpha\text{-}^{35}\text{S}]\text{dATP}$	0.5 $\mu$ l
diluted Sequenase (~1.6 units/ $\mu$ l)	2.0 $\mu$ l

Mix the components of the reaction by gently tapping the sides of the tube or microtiter plate and then incubate the reaction for 2–5 minutes at 20°C.

Store the diluted Sequenase in ice; do not allow it to warm to ambient room temperature. Store the concentrated stock of enzyme supplied by the manufacturer at –20°C. It may lose activity if stored in an ice bucket for hours.

8. Toward the end of the labeling reaction, prepare to set up the termination reactions by pre-warming the labeled microfuge tubes or microtiter plates to 37°C. *This step is important!* Then transfer the 3.5  $\mu$ l of the labeling reaction to the walls of each of the prewarmed labeled microfuge tubes or to the sides of prewarmed microtiter wells containing the appropriate dideoxy terminator mixtures (Step 4 above).
9. Place the microfuge tubes in a microfuge *at room temperature* (use appropriate rotor or adaptors for 0.5-ml tubes or place inside decapitated 1.5-ml tubes), or place the microtiter plates in a centrifuge *at room temperature* equipped with an appropriate adaptor. Centrifuge the C, T, A, and G tubes or plates for a few seconds at 2000 rpm to mix the components of the reactions. Immediately transfer the reactions to a heating block or a water bath for 3–5 minutes at 37°C.
10. Stop the reactions by adding 4  $\mu$ l of formamide-loading buffer.
11. The reactions may be stored for up to 5 days at –20°C or analyzed directly by denaturing gel electrophoresis (Protocols 8, 9, or 10, 11, and 12). After heat denaturation (2 minutes at 100°C) and quick cooling on ice, load 3  $\mu$ l of each of the C, T, A, and G reactions into individual wells of a sequencing gel.



### SEQUENCING RANGE

The reaction conditions in this protocol have been optimized to obtain the sequence of DNA lying up to 300–400 nucleotides from the 5' terminus of the primer. Reading of the sequence closer to or further away from the primer can be facilitated by the following modifications:

Distance of target DNA from 5' terminus of primer (in nucleotides)	Modification of basic procedure
20–100	Dilute labeling mixture, prepared at Step 5 above, by a factor of 10. Halve the time for incubation of both labeling and extension/termination reactions. Use $MnCl_2$ in polymerization reaction.
10–300	Use primer labeled at its 5' terminus with [ $^{32}P$ ]ATP or [ $^{33}P$ ]ATP (please see Chapter 10, Protocol 2).
100–400	Normal reaction conditions.
>400	Use four times the normal concentrations of unlabeled dNTPs and radioisotope in the labeling reaction. Double the time of incubation of the labeling reaction.

**TABLE 12-6 Problems That Commonly Arise during Dideoxy-mediated DNA Sequencing Using Sequenase**

SYMPTOM	POSSIBLE CAUSE	POSSIBLE REMEDIES
Bands are faint at the bottom of gel.	The number of primer:template complexes in the reaction is too low, which could be due to a shortage of template DNA, primer DNA, or both. In each case, the result is synthesis of a few long extension products during the labeling reaction, rather than many short products.	Optimize the amounts and ratios of primer and template DNAs in the reaction. Use a primer more distant from the target site. Decrease the concentration of dNTPs in the labeling reaction by a factor of 3.
Bands are faint at the top of the gel.	The concentration of dNTP, most probably dATP, is limiting.	Check that the specific activity of [ <sup>35</sup> S]dATP is 1000 Ci/mmole. Increase the amount of [ <sup>33</sup> P]dATP or [ <sup>35</sup> S]dATP in the labeling reaction to 1 $\mu$ l (Step 7).
Bands are smeary at the top of the gel.	Excess glycerol is present in the samples loaded onto the gel.	Use a glycerol-tolerant electrophoresis buffer or reduce the amount of glycerol in the samples. Please see the information panel on <b>GLYCEROL IN DNA SEQUENCING REACTIONS</b> .
Bands in all four tracks of sequencing reactions are at the bottom of the gel.	Sequenase is inactivated during elongation reaction.	Do not incubate the labeling reaction at temperatures >20°C or longer than 5 minutes, unless glycerol has been included in the reaction. Glycerol can be added at the labeling step by replacing Sequenase dilution buffer with glycerol enzyme dilution buffer (20 mM Tris-HCl [pH 7.5] 2 mM DTT, 0.1 mM EDTA, 50% glycerol). This will allow incubations of up to 30 minutes at 20°C, and 5 minutes at 37°C. Note that addition of glycerol necessitates the use of a glycerol-tolerant sequencing gel. Please see the information panel on <b>GLYCEROL IN DNA SEQUENCING REACTIONS</b> .
Bands in all four tracks of sequencing reactions are at the top of the gel.	The termination reaction is working inefficiently because either the template DNA contains impurities or the termination reaction was not incubated at the correct temperature.	Repurify template DNA by digestion with proteinase K, extraction with phenol, and precipitation with ethanol. The termination reactions must be incubated at a temperature of at least 37°C. Sequenase can be used at temperatures as high as 50°C. Please see the information panel on <b>GLYCEROL IN DNA SEQUENCING REACTIONS</b> .

The intensity of bands is uneven.	Pyrophosphorolysis is catalyzed by Sequenase. The termination reaction may have been incubated for too long.	Use yeast pyrophosphatase in the extension reaction (please see Step 6 of the main protocol). Reduce the termination reaction time to 2 minutes.
Background bands (weak bands) in all four tracks.	Multiple priming events due to less than optimal primer to template ratios. Possible secondary structure formation in the template.	If the amount of template can be readily quantified, adjust this ratio to 5–10:1. If the input mass of primer or template is not known, vary the volume of primer or template to determine empirically the optimum ratio for sequencing. The use of DMSO in sequencing reactions can also reduce background bands (Winship 1989). This solvent, which is thought to decrease secondary structure formation in the template, is included at a concentration of 10% (v/v) and can be conveniently added to the tubes containing the dideoxynucleotides before addition of the denatured template DNA.
Bands in all four tracks in particular regions of sequence (strong stops).	Secondary structure or unusual base composition in template.	Sequence the complementary strand of the DNA. Incubate the termination reactions at elevated temperature (up to 50°C). Add organic solvents such as DMSO to the reaction buffer. Sequenase works well in buffers containing as much as 11% (v/v) DMSO. Add the nonionic detergent Nonidet P-40 to the termination reactions. Sequenase is active in buffers containing 0.05% (v/v) of this detergent. “Chase” the DNA sequencing reactions with a different DNA polymerase. Typically, this is accomplished by adding an aliquot of a different DNA polymerase at the end of the normal incubation time. When using Sequenase, addition of 0.5–1.0 unit of the Klenow fragment to each sequencing reaction at the end of Step 8 in Protocol 3, followed by an incubation of 1–2 minutes at room temperature or 37°C, overcomes many strong stops. Other DNA polymerases such as reverse transcriptase or a thermostable DNA polymerase may also be used. Substitute 7-deaza-dGTP or dITP for dGTP, or 7-deaza-dATP for dATP in <i>Taq</i> ddNTP mixes (please see the information panel on <b>COMPRESSIONS IN DNA SEQUENCING GELS</b> ).

# Protocol 4

---

## Dideoxy-mediated Sequencing Reactions Using the Klenow Fragment of *E. coli* DNA Polymerase I and Single-stranded DNA Templates

**W**HEN THE FIRST CHAIN-TERMINATING DNA SEQUENCING METHODS were developed by Sanger and colleagues (Sanger et al. 1977b, 1980), only one suitable DNA polymerase was available — the Klenow fragment of *E. coli* DNA polymerase I. This enzyme retains the ability to polymerize dNTPs in a template-specific manner but lacks the potent 5'-3' exonuclease of complete polymerase I (please see the information panel on **THE KLENOW FRAGMENT OF *E. COLI* POLYMERASE I**). Although extensive tracts of DNA sequence were determined using the Klenow fragment, it soon became obvious that the enzyme was far from ideal as a catalyst for sequencing reactions: It was not highly processive, could not traverse regions of the template that were rich in secondary structure, greatly preferred to use dNTPs rather than ddNTPs as substrates, was adversely affected by the contaminants that frequently adulterated the DNA preparations of the time, and could work efficiently only on single-stranded DNA templates. With such a set of handicaps, it is hardly surprising that large-scale sequencing projects no longer rely on the Klenow enzyme. Today, these projects are increasingly carried out using thermostable DNA polymerases and modified versions of bacteriophage T7 DNA polymerase.

Nevertheless, the Klenow fragment is still very useful for many small-scale sequencing projects where single-stranded DNA templates are available and long reads are not required. Such projects include verification of mutations, confirmation of constructs, and pinpointing the termini of deletions. The Klenow fragment still has a faithful, but aging, coterie of supporters who believe that the enzyme has an ability to capture sequences from regions of cloned DNAs that are difficult to sequence with other DNA polymerases. Why this should be is unknown, but differences in template requirement and differential sensitivity to secondary structure are possibilities.

The enzyme works best on single-stranded DNA templates, where read-lengths of ~300–400 bases can be expected. Denatured, double-stranded DNA templates are a far more doubtful proposition. There is no good reason to use the Klenow fragment to sequence denatured plasmid DNA when so many better alternatives are available.

The following protocol, adapted from Sanger et al. (1977a, 1980), describes how to use the Klenow enzyme to sequence single-stranded DNA templates.

TABLE 12-7 ddNTP Extension/Termination Mixtures and Chase Mixtures for Klenow Sequencing

REACTION MIXTURE	STOCK SOLUTIONS OF dNTPs (1 mM) (ALL VOLUMES IN $\mu$ l)				STOCK SOLUTIONS OF ddNTPs (5 mM) (ALL VOLUMES IN $\mu$ l)				OTHER REAGENTS		
	dCTP	dTTP	dATP	dGTP	ddCTP	ddTTP	ddATP	ddGTP	TRIS-Cl (1 M, pH 8.0)	EDTA (10 mM, pH 8.0)	H <sub>2</sub> O
	ddCTP	5	100	–	100	30	–	–	–	10	10
ddTTP	100	5	–	100	–	25	–	–	10	10	675
ddATP	100	100	–	100	–	–	5	–	10	10	580
ddGTP	100	100	–	5	–	–	–	25	10	10	750
Chase dATP	245	245	245	245	–	–	–	–	10	10	–
	–	–	100	–	–	–	–	–	10	10	880

The ratios of ddNTP:dNTP in the extension/termination mixtures are 30:1, 25:1, and 25:1 for dCTP, dTTP, and dGTP respectively. In the assembled sequencing reaction, the ratio of ddATP:dATP is ~45:1.

Dispense mixtures as 50- $\mu$ l aliquots and store frozen at  $-20^{\circ}\text{C}$ .

## MATERIALS

**CAUTION:** Please see Appendix 12 for appropriate handling of materials marked with <!>.

### Buffers and Solutions

Please see Appendix 1 for components of stock solutions, buffers, and reagents. Dilute stock solutions to the appropriate concentrations.

*dATP (0.1 mM)*

Optional, please Step 4.

*Deionized distilled H<sub>2</sub>O*

*EDTA (10 mM, pH 8.0)*

*Extension/termination mixtures and chase mixture*

These reaction mixtures can be assembled by mixing the volumes (in  $\mu$ l) of the stock solutions of dNTPs and ddNTPs, as shown in Table 12-7.

*Formamide-loading buffer <!>*

*TM buffer*

100 mM Tris-Cl (pH 8.5)

50 mM MgCl<sub>2</sub>

*Tris-Cl (1 M, pH 8.0)*

### Enzymes and Buffers

*Klenow fragment of E. coli DNA polymerase I (5 units/ $\mu$ l)*

Approximately 2.5 units of enzyme are required for each set of four dideoxy sequencing reactions.

The Klenow fragment is generally supplied in a buffer containing 50% glycerol. The overenthusiastic use of the enzyme in sequencing reactions may cause distortions in sequencing gels, because of interactions between glycerol and borate ions in TBE, and the standard buffer used to pour and run DNA sequencing gels (please see the panel on **TROUBLESHOOTING** at the end of this protocol).

### Nucleic Acids and Oligonucleotides

*dNTPs, ddNTPs, stock solutions of dNTPs (1 mM) and ddNTPs (5 mM) in H<sub>2</sub>O*

*Oligonucleotide primer*

Use at a concentration of ~0.5 pmole/ $\mu$ l (~3.3  $\mu$ g/ml) in H<sub>2</sub>O.

For a list of universal primers that bind to vector sequences upstream of the target region, please see the information panel on **UNIVERSAL PRIMERS** in Chapter 8 and the information panel on **PREPARATION OF STOCK SOLUTIONS OF OLIGONUCLEOTIDE PRIMERS FOR DNA SEQUENCING** at the end of this chapter.

*Template DNA, single-stranded*

Use at a concentration of  $\sim 0.05$  pmole/ $\mu$ l, which is equivalent to  $\sim 0.15$   $\mu$ g/ $\mu$ l of bacteriophage M13 single-stranded DNA.

The concentration of single-stranded DNA in small-scale preparations of bacteriophage M13 recombinants varies from 0.05 to 0.5  $\mu$ g/ml, depending on the growth rate of the particular bacteriophage. Under the conditions normally used for sequencing, the template DNA is present in excess. Therefore, small variations in the amounts of template added to different sets of sequencing reactions do not generally affect the quality of the results; however, please see the panel on **TROUBLESHOOTING** at the end of the protocol.

**Radioactive Compounds**

[ $\alpha$ - $^{32}$ P]dATP (3000 Ci/mmmole, 10 mCi/ml) <!>

or

[ $\alpha$ - $^{33}$ P]dATP (3000 Ci/mmmole, 10 mCi/ml) <!>

or

[ $\alpha$ - $^{35}$ S]dATP (1000 Ci/mmmole, 10 mCi/ml <!>

or

5'  $^{32}$ P-labeled oligonucleotide primer <!>

Instead of internal labeling with [ $^{32}$ P]dATP, sequencing may be carried out with a 5'  $^{32}$ P-labeled oligonucleotide primer. In this case, 2  $\mu$ l ( $\sim 5 \times 10^5$  cpm;  $\sim 0.5$  ng) of the radiolabeled primer and 2  $\mu$ l of H<sub>2</sub>O are included in the reaction mixture in place of the unlabeled primer (Step 1) and [ $^{32}$ P]dATP (Step 4). All other steps remain the same. The 5' termini of oligonucleotides are generally labeled by transfer of [ $\gamma$ - $^{32}$ P]- from [ $\gamma$ - $^{32}$ P]ATP in a reaction catalyzed by polynucleotide kinase. For details of the kinasin reaction, please see Chapter 10, Protocol 2.

**Centrifuges and Rotors**

*Microfuge rotor or adaptors for use with 0.5-ml microfuge tubes, or Swing-out rotor and microtiter-plate holder (e.g., Sorvall) lined with polystyrene foam or rubber pads*

**Special Equipment**

*Microfuge tubes (0.5 ml) or Microtiter plates (flexible, heat-stable, with 96 U-shaped wells of  $\sim 300$   $\mu$ l capacity).*

Please see the information panel on **MICROTITER PLATES**.

**METHOD**

- Transfer the following to a 0.5-ml microfuge tube, or well of a microtiter plate:
 

single-stranded template DNA (0.1 $\mu$ g/ $\mu$ l)	5 $\mu$ l
oligonucleotide primer (1 $\mu$ g/ml, $\sim 160$ pmoles/ml)	4 $\mu$ l
TM buffer	1 $\mu$ l
- Close the top of the tube or seal the microtiter plate and anneal the oligonucleotide primer to the template DNA by incubating the reaction mixture for 5–10 minutes at 55°C.  
If necessary, the annealed template and primer may be stored for several months at  $-20^\circ\text{C}$ .
- Meanwhile, label four microfuge tubes or four contiguous wells of a 96-well disposable microtiter plate with the letters C, T, A, and G; then add 4  $\mu$ l of the appropriate ddNTP extension/termination mixture to each tube (i.e., 4  $\mu$ l of ddCTP mixture to tube/well labeled C, 4  $\mu$ l of ddTTP mixture to tube/well labeled T, etc.).

4. Place the annealed primer-template solution from Step 2 on ice and add:

$[\alpha\text{-}^{32}\text{P}]\text{dATP}$ or $[\alpha\text{-}^{33}\text{P}]\text{dATP}$ or $[\alpha\text{-}^{35}\text{S}]\text{dATP}$	1 $\mu\text{l}$
Klenow enzyme (~2.5 units)	1 $\mu\text{l}$
0.1 mM dATP (if $[\alpha\text{-}^{32}\text{P}]$ or $[\alpha\text{-}^{33}\text{P}]$ is used)	1 $\mu\text{l}$
or	
H <sub>2</sub> O (if $[\alpha\text{-}^{35}\text{S}]\text{dATP}$ is used)	1 $\mu\text{l}$

Store the stock of Klenow enzyme at  $-20^{\circ}\text{C}$ ; do not allow it to warm to ambient room temperature. The enzyme may lose activity if stored in an ice bucket for hours.

5. Transfer 3  $\mu\text{l}$  of the mixture from Step 4 to the walls of each of the C, T, A, and G tubes or to the sides of microtiter wells. Do not allow the radiolabeled mixture to come into contact with the ddNTP extension/termination mixture.

The fluid should be deposited as a droplet on the wall of the tubes or wells, near the rim.

6. Place the microfuge tubes in a microfuge (use appropriate rotor or adaptors for 0.5-ml tubes or place inside decapitated 1.5-ml tubes), or place the microtiter plates in a centrifuge equipped with an appropriate adaptor. Centrifuge the C, T, A, and G tubes or plates for a few seconds at 2000 rpm to mix the components and initiate the extension/termination reactions. Incubate the reactions for 10–12 minutes at  $37^{\circ}\text{C}$ .

Extension/termination and chase reactions catalyzed by the Klenow enzyme work equally well at temperatures ranging from room temperature to  $37^{\circ}\text{C}$ .

7. After 9–11 minutes of incubation, transfer 1  $\mu\text{l}$  of the chase mixture to the side of each C, T, A, and G tube or well. Do not allow the solution to slide into the polymerization reactions. When a total of 10–12 minutes has elapsed, centrifuge the tubes/plates for 2 seconds to introduce the chase mix into the extension/termination reactions. Incubate the reactions for an additional 10–12 minutes at room temperature.
8. After 9–11 minutes of the second incubation, transfer 6  $\mu\text{l}$  of formamide-loading buffer to the sides of each C, T, A, G tube or well. Again, take care that the solution does not slide down into the reaction. At the end of the incubation period, centrifuge the tubes or plates to stop the sequencing reactions.
9. The DNA sequencing reactions may be stored for up to 5 days at  $-20^{\circ}\text{C}$  or analyzed directly by denaturing gel electrophoresis (Protocols 8, 9, or 10, 11, and 12). After heat denaturation (2 minutes at  $100^{\circ}\text{C}$ ) and quick cooling on ice, load 3  $\mu\text{l}$  of each of the C, T, A, and G reactions into the individual wells of a sequencing gel.

**TROUBLESHOOTING**

Although dideoxy-mediated sequencing with the Klenow fragment usually goes smoothly, it is hardly ever perfect. For example, it is sometimes necessary to adjust the ratio of ddNTPs to dNTPs in the chain extension/chain termination reactions to maximize the amount of information that can be obtained. More serious problems that compromise the quality of the DNA sequence can be solved by adjustments to the techniques used to prepare templates or by small alterations in the conditions used for chain extension/chain termination reactions or polyacrylamide gel electrophoresis. An important first step is to determine whether the problem is systematic (i.e., affects all sequencing reactions) or whether it is template-specific. If this difference is not immediately obvious from a comparison of the results obtained from different templates sequenced on the same day, it can be rapidly ascertained by carrying out sequencing reactions with a reliable template (i.e., one that has given good results previously or one that is supplied as part of a commercially produced sequencing kit). The most common types of systematic sequencing problems are listed in Table 12-6 in Protocol 3, together with suggestions for solving them. When problems of this type arise, it is often useful to use the reagents provided in commercial sequencing kits to identify the defective component of the chain extension/chain termination reaction.

**Template Problems**

The vast majority of template-specific problems have one of the four causes listed below. The diagnostic symptoms of each of these problems and suggestions for possible solutions are listed in Table 12-6.

- **Presence of contaminating DNA** (usually bacterial chromosomal DNA) in the preparation.
- **Presence of residual PEG** or high concentrations of EDTA in the preparation.
- **Low concentrations of template DNA** in the chain extension/chain termination reactions.
- **Absence of a primer-binding site.** This problem arises chiefly when sequencing deletion mutants generated by digestion with exonuclease III (see Chapter 13, Protocol 9). Occasionally, these deletions extend back into the primer-binding region, thereby eliminating the ability to obtain DNA sequence. This problem can sometimes be corrected by using a primer complementary to sequences that lie further upstream of the target DNA.

**Secondary Structure Problems**

Regions of high secondary structure (e.g., homopolymeric tracts and palindromic sequences) in a DNA template can give rise to strong stop sequences that appear as bands in all four channels of the sequencing gel autoradiograph. These regions severely impede the progress of the DNA polymerase and are often encountered when using the Klenow fragment. The first solution is to try sequencing the other strand of the DNA. Another solution is to carry out the sequencing reactions at 50–55°C (Gomer et al. 1985). Alternatively, add a boost of Klenow (0.5 unit in a volume of 1.0  $\mu$ l) at Step 7 to replenish the enzyme that was inactivated during the termination reactions and so enhance extension beyond the block. It is possible to use dITP in place of dGTP to reduce secondary structure problems. If this modification is necessary, then substitute manganese for magnesium in the reaction buffer to enhance the ability of the Klenow enzyme to utilize the analog (Tabor and Richardson 1989b). As a final solution to secondary structure problems, sequence a template using another DNA polymerase such as Sequenase (Protocol 3) or a thermostable DNA polymerase (Protocol 5).

If problems related to secondary structure in the template persist, the addition to the chain extension/chain termination reactions (at Step 4 in the protocol above) of 0.5  $\mu$ g of single-stranded DNA-binding protein from *E. coli* (e.g., USB) usually eliminates the difficulty. If single-stranded DNA-binding protein is used, the sequencing reactions must be incubated with proteinase K (0.1  $\mu$ g/reaction) for 20 minutes at 65°C after adding the formamide-loading buffer (Step 8 above). This treatment allows the DNA to enter the sequencing gel and prevents smearing of bands.



# Protocol 5

## Dideoxy-mediated Sequencing of DNA Using *Taq* DNA Polymerase

**I**N ADDITION TO THEIR MORE FAMILIAR ROLE IN PCRS, thermostable DNA polymerases can be used in place of Sequenase or the Klenow fragment to catalyze conventional dideoxynucleotide-mediated, chain-terminating sequencing reactions (Innis et al. 1988). The ability to carry out isothermal chain-termination reactions at elevated temperature (70°C) reduces problems associated with mismatched annealing of primers at spurious binding sites in the template DNA and facilitates sequencing of templates rich in secondary structure. However, there are some disadvantages. Thermostable polymerases of the DNA polymerase I family (e.g., *Taq*) and thermostable enzymes encoded by *Archaea* (e.g., *Pfu*) catalyze the incorporation of ddNTPs at a rate that is at least two orders of magnitude slower than the rate of incorporation of dNTPs (please see Table 12-8). In addition, the efficiency of incorporation of a ddNTP at a particular site is affected by the local sequence of the template DNA. Investigators who have used *Taq* DNA polymerase for standard sequencing know the consequences: band-to-band variation in intensity on autoradiographs of sequencing gels, fading of bands from the bottom to the top of the autoradiograph, and shadow bands in locations where none should be.

These problems can be alleviated by using genetically engineered versions of thermostable DNA polymerases that lack 5'→3' exonuclease activity and catalyze the incorporation of ddNTPs with high efficiency (please see the discussion on Choosing a Sequencing System in the chapter introduction and Table 12-9 and Figure 12-6). However, these modified enzymes are relatively expensive and are best reserved for use in cycle sequencing where equality of band intensity is required to obtain long reads. Wild-type *Taq* DNA polymerase remains a useful alternative to Sequenase when problems caused by mismatching of primers or knotty secondary structures lead to ambiguous results in reading specific segments of sequence.

**TABLE 12-8** Relative Efficiency of Incorporation of dNTPs and ddNTPs by  $\Delta$ *Taq* DNA Polymerase

RATIO OF INCORPORATION OF dNTPs:ddNTPs			
G	A	T	C
200:1	2500:1	30,600:1	2400:1

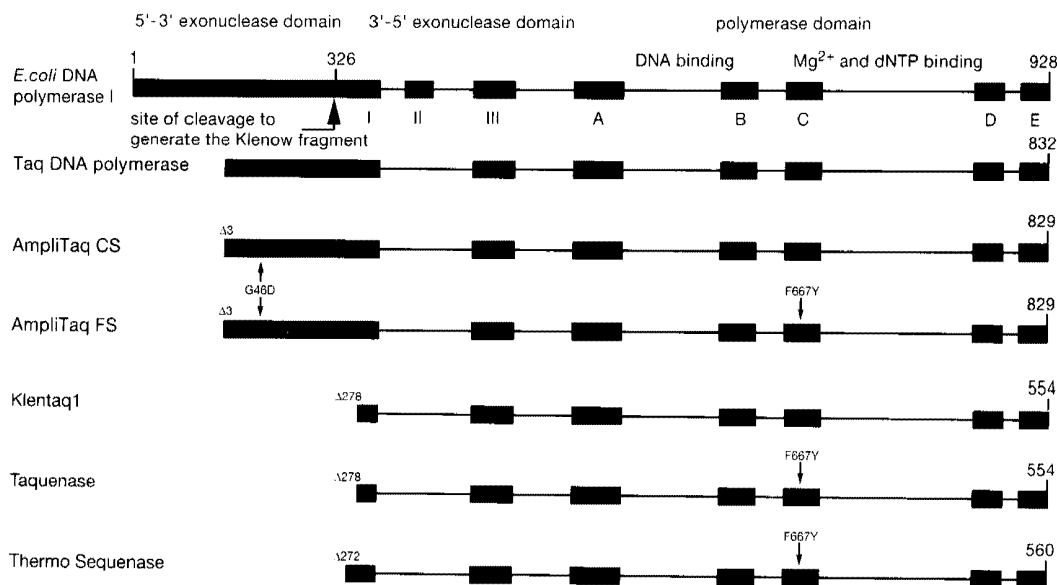
Data from Vander Horn et al. (1997).  $\Delta$ *Taq* DNA polymerase, which lacks the first 235 amino acids of the wild-type enzyme and is devoid of 5'-3' exonuclease activity, is sold by Amersham.

**TABLE 12-9 Modified Thermostable DNA Polymerases Widely Used to Catalyze Cycle-sequencing Reactions**

NAME AND SUPPLIER	STRUCTURE	PROPERTIES
<i>Taq</i> DNA polymerase (numerous sources)	832-amino-acid protein with a deduced molecular mass of 93.9 kD (Lawyer et al. 1989).	<i>Taq</i> DNA carries a potent 5'-3' exonuclease activity (Longley et al. 1990) and can catalyze the incorporation of dNTPs, dUTP, dITP in PCR (Knittel and Picard 1993; Slupphaug et al. 1993) and ddNTP in sequencing reactions; prefers dNTPs to ddNTPs or fluorescent analogs as substrates by a factor of $\sim 10^3$ (Tabor and Richardson 1995) and generates ugly ladders in cycle sequencing with highly variable intensity between adjacent bands (Voss et al 1997). The structure of the crystallized enzyme has been defined (please see the information panel on <b>TAQ DNA POLYMERASE</b> in Chapter 8).
AmpliQ CS (cycle sequencing) (Perkin-Elmer)	AmpliQ CS is not a deletion mutant like most other modified DNA polymerases. Instead, it contains a single point mutation (G46D) that eliminates exonuclease activity while retaining the processivity and extension rate of the wild-type enzyme.	Lacks the 5'-3' exonuclease activity and shows a strong preference for dNTPs over ddNTPs as substrates. AmpliQ CS is used for cycle sequencing with end-labeled primers or with radiolabeled dNTPs.
AmpliQ FS (fluorescent sequencing) (Perkin-Elmer)	AmpliQ FS like AmpliQ CS contains a point mutation (G46D) that eliminates exonuclease activity. AmpliQ FS also carries a point mutation (F667Y) that reduces the preference of wild-type <i>Taq</i> polymerase for dNTPs over ddNTPs or fluorescent analogs.	Used for fluorescence-based sequencing.
Klentq1 (AB Peptides, St. Louis, Missouri)	A Klenow-like variant of <i>Taq</i> DNA polymerase that lacks the first 278 residues of the wild-type enzyme (Barnes 1992).	Lacks the 5'-3' exonuclease activity of the wild-type enzyme. Together with Taquenase (and possibly ThermoSequenase), it is the most heat stable of the DNA polymerases but is acknowledged to be inferior to Taquenase for cycle sequencing. The structure of the crystallized enzyme has been defined (Korolev et al. 1995).
Taquenase (ScienTech Corp, St. Louis, Missouri)	A Klenow-like variant of <i>Taq</i> that lacks the first 278 residues of the wild-type enzyme and carries a point mutation (F667Y) that reduces the preference of wild-type <i>Taq</i> polymerase for dNTPs over ddNTPs or fluorescent analogs.	Lacks the 5'-3' exonuclease activity of the wild-type enzyme. Efficiently catalyzes the incorporation of dNTPs, ddNTPs, and fluorescent derivatives in cycle-sequencing reactions (Voss et al. 1997). Better suited to internal labeling than many other thermostable DNA polymerases.
ThermoSequenase (Amersham)	A Klenow-like variant of <i>Taq</i> that lacks the first 272 residues of the wild-type enzyme and carries a point mutation (F667Y) that reduces the preference of wild-type <i>Taq</i> polymerase for dNTPs over ddNTPs.	Lacks the 5'-3' exonuclease activity of the wild-type enzyme. Does not readily accept fluorescent analogs of dNTPs as substrates. When used in combination with a thermostable pyrophosphatase, it produces gels as beautiful as those of Sequenase in dye-primer sequencing.

Several other modified thermostable polymerases are marketed commercially, e.g., TaqEXPRESS (GenPak Co., UK) and SequiTherm (Epicenter Biotechnologies). Many of these modified enzymes resemble Klentq1 in structure and properties.

Mutated thermostable enzymes are quickly replacing wild-type enzymes as the DNA polymerases of choice in dideoxy-terminator sequencing. Because mutated thermostable enzymes exhibit reduced discrimination between dNTPs and ddNTPs, the ratios of these two deoxynucleotides in the DNA-sequencing reaction must be changed from those recommended in Table 12-10. The manufacturers of thermostable DNA polymerases usually provide recipes for labeling mixes that are optimal for their particular enzyme. In the absence of information from the man-



**FIGURE 12-6 Structure of Thermostable DNA Polymerases Commonly Used in DNA Sequencing**

All of the thermostable polymerases listed in the diagram are modified versions of *Taq* DNA polymerase, which shares the domain structure and many of the motifs conserved among all DNA polymerases of the polymerase I type. In the diagram, the conserved motifs in the 3'→5' exonuclease domain are marked in Roman numerals. Those in the polymerase domain are marked in uppercase Arabic characters. The numbers above the diagrams designate particular amino acid residues. The sites and nature of point mutations are marked with an arrow. For a description of the properties of these thermostable DNA polymerases, please see Table 12-9. (Diagrams drawn from data in Barnes [1992], Vander Horn et al. [1997], Wayne Barnes Internet Site [<http://barnes1.wustl.edu/~wayne/>], and literature provided by commercial companies.)

ufacturers, use the following labeling mixture recipes: Mix new ddNTP solutions that contain 150  $\mu\text{M}$  dNTP and 1.5  $\mu\text{M}$  ddNTP. For example, in the ddATP mixture, include 150  $\mu\text{M}$  each of dATP, dTTP, dCTP, and dGTP (or 7-deaza-dGTP) and 1.5  $\mu\text{M}$  of ddATP. Substitute this mixture and the other three ddNTP mixtures for those of Table 12-10 and carry out the protocol as described. The steps involved in sequencing with *Taq* DNA polymerase are similar to those used for Sequenase (Protocol 3):

- **Denaturation of double-stranded DNA templates** (if necessary) and annealing of primer to its complementary sequence.
- **A brief polymerization reaction**, carried out at low temperature (42°C) in which the primer is elongated by 20–100 nucleotides. This step is performed under conditions where the polymerase is present in excess and the concentrations of the four dNTPs are limiting. A radiolabeled dNTP is included in the reaction so that the short elongation products become radiolabeled at multiple sites. During this preliminary polymerization reaction, most of the available dNTPs, including the radiolabeled dNTP, are incorporated into DNA.
- **Extension and termination** of the elongated radiolabeled primers in four reactions that contain high concentrations of unlabeled dNTPs and a single unlabeled ddNTP (ddA, ddG, ddC, or ddT). The extension-termination reactions are carried out at 70°C.

The following protocol was supplied by D. Davis (University of Texas Southwestern Medical Center, Dallas) and is a modification of that described by Innis et al. (1988) and Brow (1990).

**MATERIALS**

**CAUTION:** Please see Appendix 12 for appropriate handling of materials marked with <!>.

**Buffers and Solutions**

Please see Appendix 1 for components of stock solutions, buffers, and reagents. Dilute stock solutions to the appropriate concentrations.

Deionized distilled H<sub>2</sub>O (ice cold)

ddNTPs, stock solutions of each of the four ddNTPs (5 mM)

dNTPs, stock solutions of each of the four dNTPs (1 mM)

Formamide-loading buffer <!>

10x Labeling mixture and ddNTP chain extension/termination mixtures

When sequencing templates that are rich in secondary structure, replace dGTP in the 10x labeling mixture and the ddNTP extension/termination mixtures with an equimolar amount of 7-deaza-2'-dGTP.

**Enzymes and Buffers**

5x Reaction buffer

200 mM Tris-Cl (pH 8.8)

25 mM MgCl<sub>2</sub>

Taq (5 units/μl) or a similar thermostable DNA polymerase

Taq dilution buffer

25 mM Tris (pH 8.8)

0.01 mM EDTA (pH 8.0)

0.15% Tween-20

0.15% Nonidet P-40

Thermostable enzymes purified from other organisms may require slightly different reaction and dilution buffers. For optimal buffers of individual enzymes, please see the specifications provided by the manufacturer. 1 unit of thermostable DNA polymerase activity is usually defined as that amount which will incorporate 10 nmoles of nucleotide into an acid-precipitable form in 30 minutes at 70–80°C.

**Nucleic Acids and Oligonucleotides**

Oligonucleotide primer

Use at a concentration of 1.0 pmole/μl (~6.6 ng/μl) in TE (pH 7.6).

For a list of universal primers that bind to vector sequences upstream of the target region, please see the information panel on **UNIVERSAL PRIMERS** in Chapter 8 and the information panel on the **PREPARATION OF STOCK SOLUTIONS OF OLIGONUCLEOTIDE PRIMERS FOR DNA SEQUENCING** at the end of this chapter.

**TABLE 12-10** 10x Labeling Mixture and ddNTP Chain Extension/Termination Mixtures for Use in Conventional DNA-sequencing Reactions Catalyzed by Taq Polymerase

REACTION MIXTURE	STOCK SOLUTION OF dNTP AND ddNTPs (ALL VOLUMES IN μl)								OTHER REAGENTS		
	dCTP 1 mM	dTTP 1 mM	dATP 1 mM	dGTP 1 mM	ddCTP 5 mM	ddTTP 5 mM	ddATP 5 mM	ddGTP 5 mM	TRIS-CL (1 M, pH 8.0)	EDTA (10 mM, pH 8.0)	H <sub>2</sub> O
Labeling	1.5	1.5	–	1.5	–	–	–	–	10	10	975
ddCTP	15	15	15	15	90	–	–	–	10	10	830
ddTTP	15	15	15	15	–	240	–	–	10	10	680
ddATP	15	15	7.5	15	–	–	120	–	10	10	800
ddGTP	15	15	15	15	–	–	–	9	10	10	911

The 10x labeling mixture contains dGTP, dCTP, and dTTP, each at a concentration of 1.5 μM.

The ratios of ddNTP:dNTP in the four ddNTP extension/termination mixtures are 30:1, 80:1, 80:1, and 3:1 for C, T, A, and G, respectively.

The 10x labeling mixture and ddNTP extension/termination mixtures should be dispensed in 50-μl aliquots and stored frozen at –20°C.

*Template DNAs (100 ng/μl) in TE (pH 7.6)*

Single-stranded DNA (500 ng) or 1.0 μg of denatured double-stranded plasmid DNA is required for each set of four sequencing reactions. Denature and anneal the linear double-stranded DNA to primer by mixing the native template DNA with an excess of primer, heating the mixture in a boiling water bath for ~2 minutes, and then plunging the tube into an ice-water bath. Do not allow the mixture to warm up; use immediately.

The concentration of single-stranded DNA in small-scale preparations of bacteriophage M13 recombinants varies from 0.05 to 0.5 μg/ml, depending on the growth rate of the particular bacteriophage. Under the conditions normally used for sequencing reactions catalyzed by *Taq* polymerase, the template DNA is present in excess. Therefore, small variations in the amounts of template added to different sets of sequencing reactions do not generally affect the quality of the results; however, please see the panel on **TROUBLESHOOTING** in Protocol 4.

**Radioactive Compounds**

[α-<sup>32</sup>P]dATP (3000 Ci/mmol, 10 mCi/ml) <!>

or

[α-<sup>35</sup>S]dATP (1000 Ci/mmol, 10 mCi/ml) <!>

or

[α-<sup>33</sup>P]dATP (2000–4000 Ci/mmol, ~10 mCi/ml) <!>

or

5' <sup>32</sup>P-labeled oligonucleotide primer <!>

Instead of internal labeling with radiolabeled dATP, carry out sequencing with an oligonucleotide primer labeled at the 5' end with <sup>32</sup>P or <sup>33</sup>P. In this case, 1.0–1.5 pmoles of the radiolabeled primer and 2 μl of H<sub>2</sub>O are included in the reaction mixture in place of the unlabeled primer (Step 1) and radiolabeled dATP (Step 6). All other steps remain the same. The 5' termini of oligonucleotides are generally labeled by transfer of [γ-<sup>32</sup>P] from [γ-<sup>32</sup>P]ATP in a reaction catalyzed by polynucleotide kinase. For details, please see Chapter 10, Protocol 2.

**Special Equipment**

*Microfuge tubes (0.5 ml) or Microtiter plates (flexible, heat-stable, with 96 U-shaped wells of ~300 μl capacity)*

Please see the information panel on **MICROTITER PLATES**.

*Programmable thermal cycler fitted with multiwell heat blocks (e.g., Dri-Block cyclers, Techne)*

Less satisfactory alternatives are water baths preheated to 45°C and 72°C; please see note to Step 8.

*Water bath preheated to 65°C*

**METHOD**

- To a 0.5-ml microfuge tube or well of a microtiter plate, add:
 

single-stranded template DNA (250 fmoles) (100 ng/μl)	5.0 μl
oligonucleotide primer (0.5 pmole) (~3.3 ng/μl)	3.0 μl
5x reaction buffer	2.0 μl
- Incubate the tightly closed tube for 2 minutes at 65°C. Remove the tube from the water bath and allow it to cool to room temperature over the course of 3–5 minutes.
 

Some investigators prefer to cool the annealing reactions more slowly over the course of 30 minutes in a small heating block or beaker of water. In our hands, both slow- and fast-cooling regimens yield sequence of the same quality.
- While the primer and template are cooling, thaw the 10x labeling and ddNTP extension/termination mixtures and radiolabeled dATP. Store the thawed solutions on ice.

### Preparing ddNTP Extension/Termination Mixtures

- For each annealing reaction, transfer 4  $\mu\text{l}$  of each ddNTP termination/extension mixture into color-coded 0.5-ml microfuge tubes or into individual wells of a microtiter plate prelabeled C, T, A, and G (i.e., 4  $\mu\text{l}$  of ddCTP mixture to tube/well labeled C, 4  $\mu\text{l}$  of ddTTP mixture into tube/well labeled T, etc.). Store the tubes/microtiter plates on ice.
- Dilute enough thermostable DNA polymerase enzyme 1:8 for all templates to be sequenced, for example,

<i>Taq</i> DNA polymerase (5–10 units/ $\mu\text{l}$ )	1 $\mu\text{l}$
<i>Taq</i> dilution buffer	7 $\mu\text{l}$

2  $\mu\text{l}$  (2 units) of diluted enzyme is needed for each set of four sequencing reactions. The final concentration of the enzyme should be  $\sim 1$  unit/ $\mu\text{l}$ . Store the diluted enzyme on ice at all times.

- Add the following to each annealing reaction (Step 2 above):

10x labeling mixture	2 $\mu\text{l}$
radiolabeled dATP	0.5 $\mu\text{l}$
diluted DNA polymerase enzyme ( $\sim 1$ unit/ $\mu\text{l}$ )	8 $\mu\text{l}$

Mix the contents of the tube by vortexing and then incubate the reactions for 5 minutes at 45°C.

- Transfer 4  $\mu\text{l}$  of the labeling reaction to the sides of each of the C, T, A, and G tubes or to the sides of microtiter wells containing the appropriate dideoxy terminator mixtures (Step 4 above).
- Place the microfuge tubes in a microfuge (use appropriate rotor or adaptors for 0.5-ml tubes or place them inside decapitated 1.5-ml tubes), or place the microtiter plates in a centrifuge equipped with an appropriate adaptor. Centrifuge the C, T, A, and G tubes or plates for a few seconds at 2000 rpm to mix the components of the reactions. Incubate the reactions for 5 minutes at 72°C.
 

Incubate the tubes/plates in an efficient heating block or place them in contact with H<sub>2</sub>O, oil, or other efficient conductor of heat. Tubes/plates placed in an air incubator set at 72°C will not reach optimum temperature for *Taq* DNA polymerase during the course of the brief incubation.
- Stop the reactions by adding 4  $\mu\text{l}$  of formamide-loading buffer .
- The reactions may be stored at  $-20^\circ\text{C}$  for up to 5 days or analyzed directly by denaturing gel electrophoresis (Protocols 8, 9, or 10, 11, and 12). After heat denaturation (2 minutes at 100°C) and quick cooling on ice, load 3  $\mu\text{l}$  of each of the C, T, A, and G reactions into individual wells of a sequencing gel.

For guidance with any difficulties, please see the panel on <b>TROUBLESHOOTING</b> at the end of Protocol 4 and Table 12-13 in Protocol 6.
--

# Protocol 6

---

## Cycle Sequencing: Dideoxy-mediated Sequencing Reactions Using PCR and End-labeled Primers

**C**YCLE DNA SEQUENCING (MORE PROPERLY CALLED THERMAL CYCLE DNA sequencing or linear amplification DNA sequencing) is a technique in which asymmetric PCR is used to generate a single-stranded template for sequencing by the Sanger dideoxy-chain termination method (Carothers et al. 1989; Murray 1989; Craxton 1991; Lee 1991; E. Lee et al. 1992). Four separate amplification reactions are set up, each containing the same oligonucleotide primer and a different chain-terminating ddNTP. Two cycling programs are typically used in a cycle-sequencing protocol. In the first program, reaction mixtures are subjected to 15–40 rounds of conventional thermal cycling (e.g., please see Halloran et al. 1992; Fulton and Wilson 1994). Each amplification cycle consists of the usual three steps: denaturation of the double-stranded DNA template, annealing of a  $^{32}\text{P}$ -labeled sequencing primer to its target sequence, and then extension of the annealed primer by a thermostable DNA polymerase and termination of the extended strand by incorporation of a ddNTP. The resulting partially double-stranded hybrid, which consists of the full-length template strand and its complementary chain-terminated product, is denatured during the first step of the next cycle, thereby liberating the template strand for another round of priming, extension, and termination. Therefore, the radiolabeled, chain-terminated products accumulate in a linear fashion during the entire first phase of the cycle-sequencing reaction. In the second program, the annealing step is omitted so that no further extension of primers is possible. Instead, the “chase” segment provides an opportunity for further extension of reaction products that were not terminated by incorporation of a ddNTP during the initial rounds of conventional thermal cycling. The radiolabeled products of cycle-sequencing reactions are finally displayed on a denaturing polyacrylamide gel and detected by autoradiography. The following are some of the advantages of cycle sequencing:

- **Works as well with double-stranded as with single-stranded templates** (Carothers et al. 1989; Murray 1989), thereby eliminating the need to subclone the DNA of interest into bacteriophage M13 or phagemid vectors.
- **Requires only femtomole amounts of template.** Sufficient DNA can be obtained from a single plaque or colony or from a PCR product purified from a gel (Smith et al. 1990; Krishnan et al. 1991; Kretz et al. 1994).

- **Can be set up in either microtiter plates or microfuge tubes.**
- **Can be adapted for use with internal labeling** by  $\alpha$ - $^{32}\text{P}$ -,  $\alpha$ - $^{33}\text{P}$ -, or  $\alpha$ - $^{35}\text{S}$ -labeled nucleotides (Carothers et al. 1989; Murray 1989) or with 5'-labeled primers (Lee 1991; Ruano and Kidd 1991; Sears et al. 1992). Cycle sequencing can also accommodate biotinylated and fluorescently labeled nucleotides (e.g., please see Wilson et al. 1990; Civitello et al. 1992; Du et al. 1993; Voss et al. 1997). The fluorescent labels can be attached to either the 5' end of the primer or to the chain-terminating nucleotides (Rosenthal and Charnock-Jones 1992).
- **Can be used with commercially available robotic workstations** (Civitello et al. 1992) and automatic DNA sequencers (Craxton 1991; Rosenthal and Charnock-Jones 1992; Sears et al. 1992).
- **Accepts nucleotide analogs such as 7-deaza-dGTP** (Mizusawa et al. 1986) and dITP, which reduce band compressions during electrophoresis (Sears et al. 1992) (please also see the information panels on **COMPRESSIONS IN DNA SEQUENCING GELS** and on **7-DEAZA-dGTP**).
- **Can be modified to obtain the sequence of each strand of a double-stranded DNA template** (Ruano and Kidd 1991).
- **Can be adapted for rapid screening of point mutants** (Carothers et al. 1989; Hattori et al. 1992).

The key to consistent success in cycle sequencing is the cleanliness of the template DNA. Impurities such as agarose, salts, and proteins all cause premature termination and pausing of DNA polymerases, whereas oligonucleotides produced by degradation of DNA and RNA cause false priming. These impurities lead to an unacceptably high level of false bands and "empty" bands (also known as dropouts). Because the only significant source of impurities in the sequencing reactions is the template DNA, problems can usually be prevented by purifying template DNAs by chromatography through spun columns of Sepharose CL-6B or Sephacryl S-400. When preparing templates from single bacteriophage M13 or  $\lambda$  plaques, use agar or agarose that is warranted to be free of inhibitors of DNA polymerases. When PCR is used to generate the DNA template, residual primers should be removed by spun column chromatography, by electrophoresis through agarose or neutral polyacrylamide gels, or by centrifugal ultrafiltration through devices such as Centricon-100 or Microcon-100 units (Krowczynska and Henderson 1992; Leonard et al. 1998; please see Chapter 8, Protocol 3). The requirement for complete removal of residual PCR primers may be eliminated by substituting a 5'  $^{32}\text{P}$ -radiolabeled oligonucleotide primer for  $\alpha$ - $^{32}\text{P}$ - or  $\alpha$ - $^{35}\text{S}$ -labeled nucleotides (Protocol 6) in cycle-sequencing reactions.

This protocol is a modification of an unpublished method of N. Sasavage (Life Technologies) which is an elaboration of a method previously published by Lee (1991). The procedure uses 5'  $^{32}\text{P}$ -labeled oligonucleotide primers and can be readily adapted to sequence a variety of DNA templates, including purified DNAs, PCR amplification products (Carothers et al. 1989; Murray 1989), plasmids in *E. coli* hosts (Krishnan et al. 1991), genomic DNA (Ruano and Kidd 1991), and bacteriophage DNAs in plaques (Krishnan et al. 1991).

An additional protocol for cycle sequencing with internal labeling of chain-terminated products by  $\alpha$ - $^{32}\text{P}$ -,  $\alpha$ - $^{33}\text{P}$ -, or  $\alpha$ - $^{35}\text{S}$ -labeled nucleotides is described at the end of this protocol.



## MATERIALS

**CAUTION:** Please see Appendix 12 for appropriate handling of materials marked with <!.>.

### Buffers and Solutions

Please see Appendix 1 for components of stock solutions, buffers, and reagents. Dilute stock solutions to the appropriate concentrations.

*ddNTP extension/termination mixtures*  
*ddNTP solutions of the four ddNTPs, each at 5.0 mM*  
*dNTP solutions of the four dNTPs, each at 1.0 mM*  
*EDTA (0.05 M, pH 8.0)*  
*Formamide-loading buffer <!.>*  
*Tris-Cl (1 M, pH 8.0)*

### Enzymes and Buffers

*AmpliTaQ CS or other exonuclease-deficient versions of Taq DNA polymerase (5 units/μl)*  
*5x Cycle-sequencing buffer*  
 200 mM Tris-Cl (pH 8.8)  
 25 mM MgCl<sub>2</sub>

*Thermostable DNA polymerase*

For advice on which enzyme to use, please see Choosing a Sequencing System in the chapter introduction and Table 12-19 in Protocol 5. This protocol has been written with AmpliTaQ CS in mind, but it will work well for thermostable enzymes with similar properties.

### Nucleic Acids and Oligonucleotides

*Oligonucleotide Primers, radiolabeled at the 5' terminus with <sup>33</sup>P or <sup>32</sup>P <!.>*

To prepare end-labeled primers, please see Chapter 10, Protocol 2.

*Template DNAs*

Plasmids, cosmids, bacteriophage λ, and bacteriophage M13 DNAs, purified from large- or small-scale cultures by any of the methods described in Chapters 1-4, can be used as templates. Table 12-12 shows the amounts of each type of template required (please also see Table 12-4).

### Special Equipment

*Microfuge tubes (0.5 ml) or Microtiter plates (flexible, heat-stable, with 96 U-shaped wells of ~300 μl capacity)*

These plates are available color-coded and/or prelabeled C, T, A, and G (please see the information panel on **MICROTITER PLATES**).

*Thermal cycler programmed with desired amplification protocol*

Please see Step 5.

**TABLE 12-11 ddNTP Extension/Termination Mixtures for Use in Cycle-sequencing Reactions**

ddNTP REACTION MIXTURE	STOCK SOLUTION OF dNTP (1 mM) AND ddNTPS (5 mM) (ALL VOLUMES IN μl)								OTHER REAGENTS		
	dCTP	dTTP	dATP	dGTP	ddCTP	ddTTP	ddATP	ddGTP	TRIS-CL (1 M, PH 8.0)	EDTA (10 mM, PH 8.0)	H <sub>2</sub> O
ddCTP	20	20	20	20	80	—	—	—	10	10	820
ddTTP	20	20	20	20	—	160	—	—	10	10	740
ddATP	20	20	20	20	—	—	120	—	10	10	780
ddGTP	20	20	20	20	—	—	—	40	10	10	860

Dispense as 50-μl aliquots; store frozen at -20°C.

The ratios of ddNTP:dNTP in the four extension/termination mixtures are 20:1, 40:1, 30:1, and 10:1 for C, T, A, and G, respectively. These ratios were optimized for reactions catalyzed by AmpliTaQ CS DNA polymerase. When using other thermostable DNA polymerases, the ratios may need to be re-optimized.

**TABLE 12-12** Amounts of Various Types of Templates Required in Cycle-sequencing Reactions

TYPE OF TEMPLATE	AMOUNT OF PURIFIED DNA REQUIRED FOR EACH SET OF FOUR DIDEOXYSEQUENCING REACTIONS (FMOLES)
Double-stranded plasmid DNA	20–200
Single-stranded bacteriophage M13 DNA	1–50
Double-stranded bacteriophage $\lambda$ DNA	20–200
Double-stranded cosmid DNA	50–200

Cycle sequencing tolerates great variation in the amount of template in the extension/termination reaction. From 1 femtomole to several hundred femtomoles of various types of double-stranded DNA vectors have been reported to work well (Kretz et al. 1994). However, there is little point in using more than 50 fmoles of template since the cycle-sequencing reaction contains only ~1 pmole of radiolabeled oligonucleotide whose concentration will become limiting during the PCR phase.

Although purified DNA templates yield the best results, crude preparations of DNA from bacteriophage M13 plaques, bacteriophage  $\lambda$  plaques, and high-copy-number plasmid DNAs in bacterial colonies may also be sequenced, albeit with reduced efficiency (Krishnan et al. 1991; Kretz et al. 1994). Our experience has shown that freshly grown colonies and plaques produce the best DNA sequence. For unknown reasons, storage of bacterial colonies or lawns of cells containing plaques overnight at 4°C drastically reduces the amount and quality of DNA sequence. This problem can be overcome by streaking the colonies or plaques on fresh agar plates (please see Chapters 1 and 2), followed by sequencing of the new colonies/plaques.

## METHOD

1. Transfer 4  $\mu$ l of appropriate ddNTP extension/termination mixture (please see Table 12-11) into 0.5-ml color-coded microfuge tubes or into individual wells of a heat-stable microtiter plate prelabeled C, T, A, and G (i.e., 4  $\mu$ l of ddCTP mixture into tube/well labeled C, 4  $\mu$ l of ddTTP mixture into tube/well labeled T, etc.). Store the tubes/microtiter plates on ice.

2. To the side of each tube or well add:

double-stranded template DNA	10–100 fmoles
1.5 pmoles of 5' $^{32}$ P-end labeled primer*	1.0 $\mu$ l
5 $\times$ cycle-sequencing buffer	2.0 $\mu$ l
H <sub>2</sub> O	to 5.0 $\mu$ l

\*If using a  $^{33}$ P end-labeled primer: 1.5  $\mu$ l of a standard preparation of  $^{33}$ P-labeled oligonucleotide contains ~5.0 pmoles of primer (please see the panel on **ADDITIONAL PROTOCOL: CYCLE SEQUENCING REACTIONS USING PCR AND INTERNAL LABELING WITH [ $\alpha$ - $^{32}$ ]dNTPs** at the end of this protocol). To maintain the stoichiometry of the components of the sequencing reaction, increase the amount of template DNA ~3-fold (30–300 fmoles) *without increasing the total volume of the reaction*.

3. Dilute an aliquot of the preparation of AmpliTaq CS DNA polymerase with 1 $\times$  cycle-sequencing buffer to a final concentration of 0.5–1.0 unit/ $\mu$ l. Add 1  $\mu$ l of the diluted enzyme to the side of each tube or well.
4. Mix the reagents by flicking the tubes with a finger or shaking the microtiter plate. If necessary, overlay each reaction with a drop of light mineral oil, cap the tubes, and centrifuge them at 2000 rpm for 2 seconds in a microfuge or briefly in a centrifuge with microtiter plate adaptors.

Make sure that the mineral oil has not been exposed to UV irradiation. Such exposure can cause the formation of potent inhibitors of PCR.

5. Load the tubes or plate into a thermocycler, preheated to 95°C. Then begin thermal cycling according to the program outlined below.

▲ **IMPORTANT** Do not delay in starting the program. Make sure that the samples are not exposed for >3 minutes to 95°C during the loading/preheating step. Otherwise, the DNA polymerase may be inactivated.

Cycle Number	Denaturation	Annealing	Polymerization
Preheating	60 sec at 95°C		
20–25 cycles	30 sec at 95°C	30 sec at 55°C	60 sec at 72°C
10 cycles	30 sec at 95°C	60 sec at 72°C	60 sec at 72°C

These times are suitable for cycle-sequencing reactions assembled in thin-walled 0.5-ml tubes and incubated in thermal cyclers such as the Perkin-Elmer 9600 or 9700, Master Cycler (Eppendorf), PTC 100 (MJ Research), and Dri-Block MW-1 and PTC- (Techne). Times and temperatures may need to be adapted to suit other types of equipment and reaction volumes.

6. Remove the tubes or plates from the thermocycler and add 5 µl of formamide-loading buffer to each cycle-sequencing reaction.
7. The reactions may be stored for up to 5 days at –20°C or analyzed directly by denaturing gel electrophoresis (Protocols 8, 9, or 10, 11, and 12). After heat denaturation (2 minutes at 100°C) and quick cooling on ice, load 3 µl of each of the C, T, A, and G reactions into individual wells of a sequencing gel.

#### **TROUBLESHOOTING: BACKGROUND IN CYCLE-SEQUENCING GELS**

For general guidance on dealing with problems, please see Table 12-13. Background bands are not usually a problem in cycle-sequencing reactions primed by an end-labeled oligonucleotide. However, if the sequencing autoradiograph has bands in the same position in more than one lane, it may be helpful to substitute 7-deaza-dGTP for dGTP in the cycle-sequencing reaction. Make up a new set of ddNTP extension/termination mixtures that contain 7-deaza-dGTP at a concentration of 45 µM, instead of dGTP at a concentration of 20 µM. The concentrations of all other components are unaltered.

Aberrant bands can also be caused by mispriming events. This problem can be alleviated by ensuring that the concentrations of primers and template DNA in the cycle-sequencing reactions are correct.

With some DNA templates, the use of 0.25% (v/v) Nonidet P-40 detergent or 0.1% Tween-20 in the 5x cycle-sequencing buffer may result in a more intense signal with fewer background bands.

TABLE 12-13 Troubleshooting: Problems That Commonly Arise during Dideoxy-DNA Sequencing

SYMPTOM	POSSIBLE CAUSE	QUESTIONS TO ASK	POSSIBLE REMEDIES
1. Faint bands or no bands at all are visible on the autoradiograph.	An essential component (enzyme, dNTPs, primer radioactive precursor) was omitted from reaction. Poor annealing of primer. Saran Wrap was not removed from gel labeled with $^{33}\text{P}$ or $^{35}\text{S}$ . Film processor is broken.	Was the correct labeled dNTP used? Was the specific activity of the labeled dNTP correct? Was the dNTP used within two half-lives? Was a control template included in the experiment? Was the correct primer used? Does the primer have the correct sequence and orientation?	If the lanes containing the control template were faint or blank and if the correct radiolabel was used, the most likely cause of this type of catastrophic failure is the labeling mixture, the DNA polymerase, or the chain extension/termination mixture. Repeat the experiment using new reaction mixtures, a new batch of enzyme, and a positive control template.  Check that the film processor is fully functional, that the correct primer is used, and that the gel is correctly processed.
2. Bands are faint at top of gel.	Template DNA is impure. Too much template was used. Ratio of ddNTP to dNTP in the extension/termination mixture was too high.	Was a control template included in the experiment? Was the chain termination/extension mixture appropriate for the DNA polymerase used to catalyze the sequencing reaction?	The key to diagnosis is the control template. If lanes containing the control template show the same symptoms, the most likely cause of the problem is the ratio of ddNTP to dNTP in the extension/termination mixture. Check that the mixture used was appropriate for the sequencing enzyme. Repeat the experiment with a new batch of extension/termination mixture.  If lanes containing the control template do not show the symptom, the templates in the remaining lanes must be contaminated with inhibitors. The remedy is to purify the templates further (proteinase K digestion, phenol extraction, and ethanol precipitation) and to redissolve them in $\text{H}_2\text{O}$ rather than TE.
3. Bands become fainter toward bottom of the gel.	Ratio of ddNTP to dNTP was too low.	Were radiolabeled dNTPs used as precursors in cycle-sequencing reactions or in isothermal reactions catalyzed by <i>Taq</i> DNA polymerase or the Klenow fragment? Was the chain termination/extension mixture appropriate for the DNA polymerase used to catalyze the sequencing reaction?	Repeat the experiment using a new batch of chain termination/extension mixture.  The best remedy is to change to an end-labeling protocol. Otherwise, repeat the reactions using twice as much labeled dNTP and be prepared to expose the dried gel to film for a long time.
4. One set of sequencing reactions yields four blank tracks.	Template DNA was omitted accidentally, or was degraded, or contains a powerful inhibitor of the sequencing reaction (e.g., EDTA), or does not contain an appropriate primer-binding site.	Were the concentration and integrity of the template verified on an agarose gel?	Purify the template further (proteinase K digestion, phenol extraction, and ethanol precipitation) and redissolve it in $\text{H}_2\text{O}$ rather than TE.  Use another primer that binds to a different site in the template DNA.

<p>5. Three of the four sequencing reactions work well with all templates (including the control) but one lane is always faint or blank.</p>	<p>One of the four chain extension/termination mixtures is defective.</p>	<p>Was the frozen stock of extension/termination mixture maltreated, e.g., by thawing in a water bath? Or was it left at room temperature after thawing?</p>	<p>Make a fresh batch of chain extension/termination mixture. Compare the results obtained from both batches in reactions containing a control template.</p> <p>If the A-track is causing the problem with all templates (including the control), the stock of dATP may be degraded. If the problem is confined to the test templates, the DNAs may be rich in A residues.</p>
<p>6. Amount of radiolabel incorporated during the sequencing reaction varies from template to template.</p>	<p>Templates are present at different concentrations.</p> <p>Template DNAs are partially degraded, or they contain an inhibitor of the sequencing reaction (e.g., EDTA).</p>		<p>Check the concentrations of the template DNAs on agarose gels; make sure that all sequencing reactions contain approximately equal amounts of template. If necessary, purify a new batch of template DNAs, dissolving them in H<sub>2</sub>O rather than TE.</p>
<p>7. High background of radiolabeled bands in all four lanes makes the sequences difficult to read.</p>	<p>Template DNAs are impure.</p> <p>Samples were heated too long before loading or, if labeled with <sup>32</sup>P, may have undergone radiolysis during storage.</p> <p>Gel plates contain a residue of silanizing agent.</p> <p>DNA polymerase has deteriorated or its concentration is limiting.</p> <p>Samples evaporated during incubation.</p>	<p>Was a control template included in the experiment?</p> <p>Is a smear of chromosomal DNA visible when the template DNAs are analyzed by agarose gel electrophoresis?</p> <p>How long were the samples boiled/stored before loading the gel?</p>	<p>If the control template is exempt from the problem, the home-made DNA templates are most likely contaminated by fragments of chromosomal DNA, which cannot be easily removed by further purification of the template DNAs. The best solution may be to isolate and more carefully purify a new set of template DNAs from freshly picked plaques or colonies.</p> <p>If the background is high in lanes containing the control DNA, the samples may have been heated too vigorously or stored too long and/or the DNA polymerase may be anemic. Repeat the sequencing reactions using a new preparation of DNA polymerase. Make sure the reactions are covered with mineral oil before incubation in a thermal cycler. Transfer the samples to microfuge tubes and denature them by heating to 95°C for 5 minutes; chill the samples to 0°C and load them onto the gel within 20 minutes.</p> <p>Make sure the gel plates are clean.</p>
<p>8. Shadow bands or double bands are present in one set of sequencing reactions.</p>	<p>More than one template is present.</p> <p>Primer is binding to more than one site.</p>		<p>Repurify the template DNA from a freshly picked plaque or colony. If the problem persists, use another primer that binds to a different site in the template DNA.</p>
<p>9. Shadow bands are present in all sequencing reactions.</p>	<p>Concentration of primer is too high.</p> <p>DNA polymerase has deteriorated or its concentration is limiting.</p>	<p>Was the annealing step carried out at the correct temperature?</p>	<p>Titrate the primer, using a new preparation of DNA polymerase. If this does not solve the problem, purify the primer by polyacrylamide gel electrophoresis.</p> <p>If using cycle sequencing, reduce the number of cycles to ~30.</p> <p>Repeat the reactions using DNA polymerase that lacks 5'-3' exonuclease activity.</p> <p>Please also see Symptom 7, above.</p>

(Continued on following pages.)

TABLE 12-13 (Continued)

SYMPTOM	POSSIBLE CAUSE	QUESTIONS TO ASK	POSSIBLE REMEDIES
	<p>Primer is heterogeneous in length and/or the annealing step was carried out at suboptimal temperature.</p> <p>Samples were boiled too long or, if labeled with <math>^{32}\text{P}</math>, may have undergone radiolysis during storage.</p> <p>DNA polymerase carrying 5'-3' exonuclease activity was used to catalyze the sequencing.</p>		
<p>10. Bands are present in all four tracks in particular regions of sequence</p> <p>or</p> <p>bands are missing from particular regions of sequence.</p>	<p>Template contains homopolymeric tracts or regions of stable secondary structure.</p>	<p>Was the template generated by PCR? If so, a primer-dimer or other PCR artifact may have been carried over to the sequencing reaction and has become labeled.</p>	<p>Sequence the complementary strand.</p> <p>Use a different DNA polymerase.</p> <p>Carry out chain extension/termination reactions at higher temperature.</p> <p>Substitute 7-deaza-dGTP for dGTP in ddNTP mixtures and substitute <math>\text{MnCl}_2</math> for <math>\text{MgCl}_2</math> in sequencing buffer (please see the information panel on <b>COMPRESSIONS IN DNA SEQUENCING GELS</b>).</p> <p>Increase the temperature of electrophoresis to 60°C. Alternatively, use a polyacrylamide gel containing 40% formamide.</p>
<p>11. Bands are diffuse through the length of the gel.</p>	<p>Polyacrylamide gel and/or electrophoresis buffer is defective.</p> <p>Samples contain high concentrations of salt.</p> <p>Urea is present in the loading area of the gel.</p> <p>Temperature of the gel is too high during electrophoresis and/or during drying.</p> <p>Poor contact between gel and film.</p>	<p>Does the control template show the same problem?</p>	<p>If the bands in the control template are sharp, the test templates probably contain too much salt. Repurify the template DNA from a freshly picked plaque or colony.</p> <p>If the bands in the template DNA are diffuse, make up new gel mixtures/electrophoresis buffer and new ammonium sulfate solution. The sequencing gel should polymerize rapidly (within 15 minutes). Make sure that the gel mixture is at room temperature when the gel is cast; otherwise, urea may precipitate. Make sure that the loading area of the gel is thoroughly washed before the samples are loaded.</p> <p>Make sure that the temperature of the gel during electrophoresis is ~60°C and that the temperature control on the gel dryer is set correctly.</p>

	Ammonium persulfate solution used to catalyze the polymerization of acrylamide was not fresh.	Make sure that the gel is in close contact with the film during exposure of the autoradiograph. If using single-sided film, make sure that the emulsion side faces the dried gel.
12. Diffuse bands extending across all lanes of the gel (including the control) ~75 bases from the 3' end of the primer.	Radiolabeled dNTP has deteriorated during storage.	Repeat the sequencing reactions using a fresh batch of radiolabel.
13. Wavy bands.	Sample wells were not thoroughly washed before loading.	Pour a new gel and wash wells thoroughly to remove urea, unpolymerized acrylamide, and loose fragments of polyacrylamide.
14. Black dots on the autoradiograph.	Precipitation of borate or urea from the gel mixtures.	Make up new gel mixtures using freshly purified components. Make sure that the gel mixture is at room temperature when gel is cast; otherwise, urea may precipitate.
15. Radioactivity remained in the sample well.	Samples were not properly denatured.	Transfer the samples to microfuge tubes and denature them by heating to 95°C for 5 minutes; chill the samples to 0°C and load them onto the gel within 20 minutes.
16. Bands are distorted at the top of the gel.	Excess glycerol is present in samples loaded onto the gel.	Use a glycerol-tolerant gel or reduce the amount of glycerol in the samples. Please see the information panel on <b>GLYCEROL IN DNA SEQUENCING REACTIONS</b> .
17. Bubbles in gel.	Gel plates were not cleaned properly or gel was poured too quickly.	Pour a new sequencing gel, using clean gel plates.
18. Samples from adjacent lanes become mixed after loading.	Top of the gel was not tightly clamped and/or the comb was not inserted deeply enough into the slot.	Pour a new sequencing gel, taking care to clamp the gel properly and to insert the comb to the correct depth.

**ADDITIONAL PROTOCOL: CYCLE SEQUENCING REACTIONS USING PCR AND INTERNAL LABELING WITH [ $\alpha$ - $^{32}$ P]dNTPs**

Most radiolabeled cycle-sequencing reactions use 5'  $^{32}$ P-labeled oligonucleotide primers to generate labeled chain-terminated products that can be detected on sequencing gels by autoradiography. Another way to achieve the same goal is to include [ $\alpha$ - $^{32}$ P]dNTPs in cycle-sequencing reactions. This method, however, in our hands, produces messier gels with higher backgrounds and cannot be recommended with enthusiasm. The following protocol is an amalgam of methods harvested from individual investigators and from the manufacturers of thermostable DNA polymerases. The protocol has been optimized for use with AmpliTaq CS, but similar thermostable enzymes from other manufacturers should be equally effective (please see Choosing a Sequencing System in the chapter introduction and Table 12-9).

**CAUTION:** Please see Appendix 12 for appropriate handling of materials marked with <!>.

**Additional Materials**

[ $\alpha$ - $^{32}$ P]dATP (3000 Ci/mmole, 10 mCi/ml) <!>

or

[ $\alpha$ - $^{35}$ S]dATP (1000 Ci/mmole, 10 mCi/ml) <!>

or

[ $\alpha$ - $^{33}$ P]dATP (2000–4000 Ci/mmole, ~10 mCi/ml) <!>

Cycle-sequencing extension/termination mixtures

Prepared as outlined in Table 12-14.

Oligonucleotide primer (unlabeled and dissolved in  $H_2O$  at a concentration of 20  $\mu$ M)

**Method**

1. Transfer 2  $\mu$ l of the appropriate ddNTP mixture (see Table 12-14) into 0.5-ml color-coded microfuge tubes or into individual wells of a heat-stable microtiter plate pre-labeled C, T, A, and G (i.e., 2  $\mu$ l of ddCTP mixture into tube/well labeled C, 2  $\mu$ l of ddTTP mixture into tube/well labeled T, etc.). Store the tubes/microtiter plates on ice.
2. For each template to be sequenced, prepare 30  $\mu$ l of the following mixture and add the reagents in the order shown.

template DNA in $H_2O$	1–100 fmoles
oligonucleotide primer (10 $\mu$ M)	1.0 $\mu$ l
$\alpha$ -labeled dATP	1.5 $\mu$ l
5x cycle-sequencing buffer	8.0 $\mu$ l
$H_2O$	to 30 $\mu$ l

Mix the reagents by gently flicking the outside of the closed tube. If necessary, centrifuge the tube briefly to deposit all the reagents in the bottom.

3. Transfer 6  $\mu$ l of the mixture prepared in Step 2 into each of the four tubes/wells prepared in Step 1.
4. Dilute an aliquot of the preparation of AmpliTaq CS DNA polymerase with 1x cycle-sequencing buffer to a final concentration of 0.5–1.0 unit/ $\mu$ l. Add 1  $\mu$ l of the diluted enzyme to the side of each tube or well.
5. Follow Steps 4–7 of the main protocol.

**TABLE 12-14** ddNTP Extension/Termination Mixtures for Use in Cycle-sequencing Reactions with Radiolabeled dATP

ddNTP REACTION MIXTURE	STOCK SOLUTION OF dNTP (1 mM) AND ddNTPS (5 mM) (ALL VOLUMES IN $\mu$ l)								OTHER REAGENTS		
	dCTP	dTTP	dATP	dGTP	ddCTP	ddTTP	ddATP	ddGTP	TRIS-Cl (1 M, pH 8.0)	EDTA (10 mM, pH 8.0)	$H_2O$
ddCTP	20	20	20	20	80	–	–	–	10	10	820
ddTTP	20	20	20	20	–	160	–	–	10	10	740
ddATP	20	20	20	20	–	–	120	–	10	10	780
ddGTP	20	20	20	20	–	–	–	40	10	10	860



# Protocol 7

## Chemical Sequencing

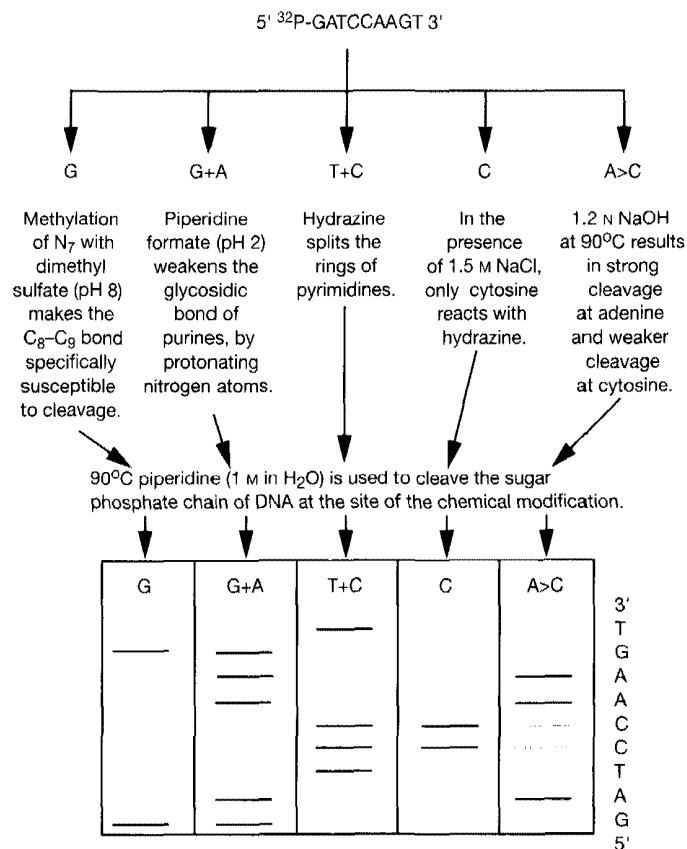
**U**NLIKE THE CHAIN-TERMINATION TECHNIQUE, WHICH INVOLVES ENZYMATIC SYNTHESIS, the Maxam-Gilbert method entails chemical degradation of a segment of DNA. A fragment of DNA radiolabeled at one end is partially cleaved in five separate chemical reactions, each of which is specific for a particular base or type of base (Maxam and Gilbert 1977, 1980). For further discussion on end-labeling, please see the panel **ADDITIONAL PROTOCOL: PREPARATION OF END-LABELED DNA FOR CHEMICAL SEQUENCING** at the end of this protocol and Figure 12-7. The cleavage reactions generate five populations of radiolabeled molecules that extend from a common point (the radiolabeled terminus) to the site of chemical cleavage. Each population consists of a mixture of molecules whose lengths are determined by the locations of a particular base along the length of the original DNA. These populations are then resolved by electrophoresis through polyacrylamide gels, and the end-labeled molecules are detected by autoradiography (please see Figure 12-7). For further details, please see the introduction (p. 12.3).

The Maxam-Gilbert method has not changed significantly since its initial development. Although additional chemical cleavage reactions have been devised (e.g., please see Ambrose and Pless 1987) and other reactions have been simplified (Muro et al. 1993; Pichersky 1996), most investigators rely on the quintet of reactions originally described by Maxam and Gilbert (1977, 1980). These cleavage reactions are carried out in two stages: (1) Specific bases (or types of bases) undergo chemical modification and (2) the modified base is removed from its sugar, and the phosphodiester bonds 5' and 3' to the modified base are cleaved (please see Table 12-15).

**TABLE 12-15 Chemical Modifications Used in the Maxam-Gilbert Method**

BASE	SPECIFIC MODIFICATION
G	Methylation of N <sub>7</sub> with dimethylsulfate at pH 8.0 renders the C <sub>8</sub> -C <sub>9</sub> bond specifically susceptible to cleavage by base.
A+G	Piperidine formate at pH 2.0 weakens the glycosidic bonds of adenine and guanine residues by protonating nitrogen atoms in the purine rings, resulting in depurination.
C+T	Hydrazine opens pyrimidine rings, which recyclize in a five-membered form that is susceptible to removal.
C	In the presence of 1.5 M NaCl, only cytosine reacts appreciably with hydrazine.
A>C	1.2 N NaOH at 90°C results in strong cleavage at A residues and weaker cleavage at C residues.

The volatile secondary amine piperidine is used to cleave the sugar-phosphate chain of DNA at the sites of base modifications. For discussions of mechanism of cleavage, please see Maxam and Gilbert (1980) and Mattes et al. (1986).



**FIGURE 12-7 Sequencing by the Maxam-Gilbert Method of Chemical Degradation**

The oligonucleotide in this example (5' GATCCAAGT 3') is subjected to five chemical cleavage reactions (G, G+A, T+C, C, A>C). The resulting products of each of the reactions are separated by electrophoresis through a denaturing acrylamide gel and visualized by autoradiography, and the original sequence is determined from the "ladders" of oligonucleotide products. For details of the chemistry of these reactions, please see the accompanying text and Table 12-15.

In every case, the reactions are carried out under carefully controlled conditions to ensure that on average only one of the target bases in each DNA molecule is modified. Subsequent cleavage of a phosphodiester bond adjacent to the damaged base by hot piperidine yields a set of end-labeled molecules whose lengths range from one to several hundred nucleotides. The piperidine is removed by either ethanol precipitation or vacuum drying or a combination of both. The end-labeled molecules are resuspended, denatured by heating to 90°C in a buffer containing 90% formamide, and then separated by electrophoresis through a polyacrylamide gel. The DNA sequence can then be read from an autoradiograph of the sequencing gel. For a number of reasons (e.g., the use of <sup>32</sup>P as a radiolabel, the low specific activity of end-labeled DNA, the statistical distribution of cleavage sites, and the limitations of gel technology), the range of the Maxam-Gilbert method is less than that of the Sanger method. The most that can be expected from a set of Maxam-Gilbert reactions is ~250 bases of sequence, beginning 10–15 bases from the radiolabeled end.

Chemical sequencing of large tracts of DNA fell out of favor in the late 1980s. This was due to two improvements in enzymatic sequencing of DNA: the introduction of DNA polymerases tailor-made for sequencing reactions, and the application of automation through robotics and

fluorescence-based sequencing machines. By contrast, DNA sequencing by the chemical method remained labor-intensive. Nevertheless, chemical sequencing retains one clear advantage: It enables sequencing to begin anywhere in the target DNA where a restriction site can be labeled or an end-labeled fragment can be produced via PCR. In addition, the target DNA can be of any length and can be radiolabeled in a number of ways, depending on the nature of the termini of the DNA (please see Figure 12-8 and the panel on **ADDITIONAL PROTOCOL: PREPARATION OF END-LABELED DNA FOR CHEMICAL SEQUENCING** at the end of this protocol). The sequence obtained in this way can be used as an entry point to generate oligonucleotides that can be used to prime enzymatic sequencing reactions.

In addition, the chemical method continues to have a crucial role in establishing the sequence of oligonucleotides, in the functional dissection of transcriptional control signals (e.g., methylation interference assays; Carey and Smale 2000), and in the identification and characterization of these regions in intact cells (genomic footprinting; Church and Gilbert 1984).

This protocol is based on the classic Maxam and Gilbert procedure. Investigators are encouraged to read the lucid and comprehensive treatise by Allan Maxam and Walter Gilbert (published in 1980), before carrying out this protocol.

## MATERIALS

**CAUTION:** Please see Appendix 12 for appropriate handling of materials marked with <!.>.

### Buffers and Solutions

Please see Appendix 1 for components of stock solutions, buffers, and reagents. Dilute stock solutions to the appropriate concentrations.

*Acetic acid (1 M), freshly diluted from glacial acetic acid (17.4 M) <!.>*

*Ethanol (absolute) chilled to -20°C.*

*Dimethylsulfate (DMS) (99%) (Gold label 99% from Aldrich) <!.>*

*DMS (10% v/v) in ethanol <!.>*

*DMS buffer*

50 mM sodium cacodylate (pH 7.0) <!.>

1 mM EDTA (pH 8.0)

▲ **WARNING** Wear gloves and a mask when weighing solid sodium cacodylate and gloves when handling DMS buffer.

*DMS stop solution*

1.5 M sodium acetate (pH 7.0)

1 M β-mercaptoethanol <!.>

250 μg/ml yeast tRNA

*EDTA (0.5 M, pH 8.0)*

*Formamide <!.>*

*Formamide-loading buffer <!.>*

*Hydrazine (95%) <!.>*

Store hydrazine (Eastman Kodak) in small aliquots in tightly capped microfuge tubes at -20°C.

*Hydrazine stop solution*

0.3 M sodium acetate (pH 7.0)

0.1 mM EDTA (pH 8.0)

100 μg/ml yeast tRNA

*NaCl (5 M)*

*NaOH (1.2 N) containing 1 mM EDTA <!.>*

*Piperidine (1 M) in H<sub>2</sub>O <!.>*

This solution should be freshly made by mixing 1 volume of piperidine (10 M; Fisher) with 9 volumes of H<sub>2</sub>O in a graduated glass cylinder.

*Piperidine formate (1 M)*

Prepared by adjusting a 4% solution of formic acid in H<sub>2</sub>O to pH 2.0 with 10 M piperidine.

*Sodium acetate (3 M, pH 5.2)***Gels***Polyacrylamide sequencing gel <!>*

The products of Maxam-Gilbert sequencing reactions are usually analyzed on 6% or 8% denaturing polyacrylamide gels (please see Protocol 8).

**Nucleic Acids and Oligonucleotides***Salmon sperm DNA (1 mg/ml) in H<sub>2</sub>O*

Sheared salmon sperm DNA is the material traditionally used as carrier in the chemical sequencing method. In fact, almost any DNA will serve the purpose equally well. Sheared salmon sperm DNA can be purchased from commercial suppliers (e.g., Sigma), or it can be generated in the laboratory as described in Chapter 6, Protocol 10.

*Target DNA, radiolabeled <!>*

Prepare at least  $5 \times 10^5$  cpm of DNA, asymmetrically end-labeled with <sup>32</sup>P and dissolved at a concentration of ~5000 cpm/μl in H<sub>2</sub>O (please see the panel on **ADDITIONAL PROTOCOL: PREPARATION OF END-LABELED DNA FOR CHEMICAL SEQUENCING**). The DNA solution *must* be free of salt.

When the quantity of radiolabeled DNA is limiting, it is possible to determine an unambiguous DNA sequence by carrying out only four (C, C+T, A+G, and G) of the five reactions detailed in the flowchart.

*Yeast tRNA (1 mg/ml) in H<sub>2</sub>O***Special Equipment***Dry ice-ethanol bath <!>*

*Equipment for Cerenkov counting (see Appendix 8)*

*Ice-water bath**Microfuge tubes*

Cleavage reactions are generally carried out in standard 1.5-ml microfuge tubes. When sequencing a number of DNAs at the same time, use different colored microfuge tubes to facilitate the identification of each base-specific cleavage reaction. Some investigators prefer to use siliconized tubes. However, this precaution is unnecessary if care is taken to ensure that all of the radioactive DNA is dissolved after each precipitation step, for example, by using a pipette tip to roll a bead of buffer over the entire inner surface of the tube, or by vigorous and extensive vortexing.

*Rotary vacuum evaporator*

For example, a Savant SpeedVac.

*Round bath rack with screw-down pressure plate*

For example, Research Products International.

Optional, please see Step 4.

*Sequencing gel apparatus and power pack*

Please see Protocol 11.

*Water bath or heating block preset to 37°C and 90°C***METHOD**

1. Subject the radiolabeled DNA to the base modification procedures outlined in the flowchart in Table 12-16.

It is usually possible to determine an unambiguous DNA sequence by carrying out only four (C, C+T, A+G, and G) of the five reactions detailed in the flowchart.

2. Resuspend each of the four or five lyophilized DNA samples containing the base-modified DNA by vortexing with 100 μl of 1 M piperidine.

Piperidine is used to cleave the sugar-phosphate chain of DNA at the sites of chemical modification.

**TABLE 12-16 Flowchart of Traditional Method of Maxam-Gilbert Sequencing**

G	A+G	C+T	C	A>C
Mix 190 $\mu$ l DMS buffer 4 $\mu$ l sonicated DNA 5 $\mu$ l $^{32}$ P-labeled DNA Chill to 0°C.	Mix 10 $\mu$ l H <sub>2</sub> O 4 $\mu$ l sonicated DNA 10 $\mu$ l $^{32}$ P-labeled DNA Chill to 0°C.	Mix 10 $\mu$ l H <sub>2</sub> O 4 $\mu$ l sonicated DNA 10 $\mu$ l $^{32}$ P-labeled DNA Chill to 0°C.	Mix 15 $\mu$ l 5 M NaCl 4 $\mu$ l sonicated DNA 5 $\mu$ l $^{32}$ P-labeled DNA Chill to 0°C.	Mix 100 $\mu$ l 1.2 N NaOH, 1 mM EDTA 4 $\mu$ l sonicated DNA 5 $\mu$ l $^{32}$ P-labeled DNA Close top of tube tightly and secure with plastic tape.
Add 5 $\mu$ l 10% DMS and mix.	Add 4 $\mu$ l piperidine formate (pH 2.0) and mix.	Add 30 $\mu$ l hydrazine and mix gently.	Add 30 $\mu$ l hydrazine and mix gently.	Incubate 7 minutes at 90°C. Chill to 0°C.
Incubate 5 minutes at 20°C.	Incubate 15 minutes at 37°C.	Incubate 7 minutes at 20°C.	Incubate 5 minutes at 20°C.	Incubate 7 minutes at 90°C. Chill to 0°C.
Add 50 $\mu$ l DMS stop solution (at 0°C) and mix.	Add 240 $\mu$ l hydrazine stop solution (at 0°C) and mix.	Add 200 $\mu$ l hydrazine stop solution (at 0°C) and mix.	Add 200 $\mu$ l hydrazine stop solution (at 0°C) and mix.	Add 150 $\mu$ l 1 M acetic acid, 5 $\mu$ l tRNA (1 mg/ml) and mix.
Add 750 $\mu$ l of ethanol (-20°C) and mix.	Add 750 $\mu$ l of ethanol (-20°C) and mix.	Add 750 $\mu$ l of ethanol (-20°C) and mix.	Add 750 $\mu$ l of ethanol (-20°C) and mix.	Add 750 $\mu$ l of ethanol (-20°C) and mix.
Store for 5 minutes at -70°C.	Store for 5 minutes at -70°C.	Store for 5 minutes at -70°C.	Store for 5 minutes at -70°C.	Store for 5 minutes at -70°C.
Centrifuge 5 minutes at 12,000g at 4°C.	Centrifuge 5 minutes at 12,000g at 4°C.	Centrifuge 5 minutes at 12,000g at 4°C.	Centrifuge 5 minutes at 12,000g at 4°C.	Centrifuge 5 minutes at 12,000g at 4°C.
Remove the supernatant carefully and dispose of it in the appropriate waste bottle.	Remove the supernatant.	Remove the supernatant carefully and dispose of it in the appropriate waste bottle.	Remove the supernatant carefully and dispose of it in the appropriate waste bottle.	Remove the supernatant.
<p>↓</p> <p>Add 300 <math>\mu</math>l 0.3 M sodium acetate (pH 5.2) at 0°C and mix by vortexing. Add 900 <math>\mu</math>l ethanol (-20°C) and mix. Store 5 minutes at -70°C. Centrifuge 5 minutes at 12,000g at 4°C. Remove supernatant carefully. Add 1 ml ethanol (-20°C) and mix. Centrifuge 2 minutes at 12,000g at 4°C. Remove supernatant carefully. Lyophilize pellet of DNA. Add 100 <math>\mu</math>l 1 M piperidine. Secure the tops of the tubes with plastic tape and mix the contents of the tubes. Incubate 30 minutes at 90°C. Lyophilize. Add 20 <math>\mu</math>l of H<sub>2</sub>O. Vortex for 30 seconds. Centrifuge 10 seconds at room temperature. Lyophilize. Add 20 <math>\mu</math>l of H<sub>2</sub>O. Vortex for 30 seconds. Centrifuge 10 seconds at room temperature. Lyophilize. Add 10 <math>\mu</math>l sequencing gel-loading buffer. Vortex for 20 seconds. Centrifuge 10 seconds at room temperature. Close the tops of the tubes tightly. Heat to 90°C for 1 minute. Load 3 <math>\mu</math>l of each sample on a lane of a sequencing gel.</p>				

3. Close the tops of the tubes securely. Mix the contents of the tubes by vortexing. If necessary, centrifuge the tubes briefly (2000 rpm) to deposit all of the fluid at the bottom.
4. Incubate the tubes for 30 minutes at 90°C. To prevent the tops of the tubes from popping open during heating, either place a heavy weight on the tubes or seal the tops with plastic tape. Alternatively, use a round bath rack with a screw-down pressure plate (e.g., Research Products International).
5. Allow the tubes to cool to room temperature. Open the lids of the tubes, and seal the open tubes with Parafilm. Pierce several holes in the Parafilm with a 21-gauge needle and evaporate the contents of the tubes to dryness in a rotary vacuum evaporator (e.g., Savant SpeedVac).

To avoid smeary bands in the final sequencing gel, it is essential to remove the last traces of piperidine from the base-specific cleavage reactions. This is best achieved by lyophilizing using an efficient rotary vacuum evaporator. This step usually takes 1–4 hours depending on the efficiency of the evaporator. Some investigators prefer to freeze the samples in a dry ice–ethanol bath just before placing the tubes in the evaporator.

6. Remove the tubes from the evaporator. Discard the Parafilm and add 20  $\mu\text{l}$  of  $\text{H}_2\text{O}$  to each tube. Close the caps of the tubes, and vortex the tubes for 30 seconds to dissolve the DNA. Centrifuge the tubes briefly to deposit all of the fluid at the bottom. Use a hand-held mini-monitor to check that all of the radiolabeled DNA has been washed from the walls of the tubes by the  $\text{H}_2\text{O}$  and is dissolved in the fluid.
7. Once again, evaporate all of the samples to dryness in a rotary vacuum evaporator (see Step 5 above). This step usually takes 15–30 minutes, depending on the efficiency of the evaporator.
8. Repeat Steps 6 and 7.

To ensure that all of the piperidine has been removed, some investigators prefer to dissolve the DNA once more in 10  $\mu\text{l}$  of  $\text{H}_2\text{O}$  and to carry out an additional cycle of evaporation. However, this step is necessary only if the samples have an “oily” look or if abnormally long periods of evaporation have been required to reduce them to dryness.
9. Estimate the amount of radioactivity remaining in each of the tubes by Cerenkov counting, and dissolve the individual modification and cleavage reactions in sequencing gel-loading buffer. An overnight exposure on Kodak XAR-5 film requires ~25,000 cpm of reactions that cleave the DNA after only one base (i.e., the C and G reactions), and ~50,000 cpm of reactions that cleave after two bases (C+T, A+G, and A>C). Therefore, the modified and cleaved DNAs should be dissolved in sequencing gel-loading buffer so that the C and G reactions contain ~25,000 cpm/3  $\mu\text{l}$  and the C+T, A+G, and A>C reactions contain ~50,000 cpm/3  $\mu\text{l}$ . Vortex the tubes to dissolve the DNA fully. Centrifuge the tubes briefly to deposit all of the fluid at the bottom. If necessary, the samples may be stored at –20°C for a few hours while the sequencing gel is prepared.
10. Heat the tubes for 1 minute at 90°C to denature the DNA before quick-cooling on ice. Analyze the reactions by electrophoresis through denaturing polyacrylamide gels as described in Protocols 8, 9, or 10, 11, and 12.

If difficulties arise with chemical sequencing, the best course of action is to read the article by Maxam and Gilbert (1980), which explains in detail how to diagnose and correct problems. Table 12-17 is reproduced, with permission, from this article.

**TABLE 12-17 Diagnosis and Correction of Aberrations in Sequencing Band Patterns**

PROBLEM	PROBABLE CAUSES	SUGGESTED SOLUTIONS
<p>1. Any of all of the following:</p> <p>a. Smearing of pyrimidine cleavage products.</p> <p>b. Loss of electrophoresis dye color in C and/or C+T samples.</p> <p>c. Bands in C and/or C+T ladders at positions where purines follow pyrimidines in the sequence.</p> <p>d. Large, water-insoluble pellets after the first ethanol precipitation.</p> <p>e. Poor suppression of Ts in the C ladder.</p>	<p>Fragments of DNA broken at pyrimidines contain one or more internal thymines and/or cytosines that reacted with hydrazine but did not then cleave with piperidine. Each of these legitimate cleavage products blurs because its charge and/or mass is heterogeneous, due to the varying number and nature of internal hydrazine reaction products. Causes include an inadequate piperidine reaction and secondary reactions with residual hydrazine during the 90°C strand-scission and heat denaturation steps. Hydrazine can be carried through the procedure when ethanol precipitation and/or lyophilization fails to remove it. An insoluble complex of hydrazine, magnesium, and possibly other ions, which appears as a larger pellet, and poor vacuum during the lyophilization steps are common causes of this problem. Hydrazine has undergone oxidation.</p>	<p>If magnesium acetate is still used in the hydrazine stop solution as originally suggested, delete it. If piperidine reactions are done in microfuge tubes, be sure to use at least 100 µl and to seal the cap tightly (otherwise, use flame-sealed capillaries). After the piperidine reaction, use a strong vacuum with rewetting of the residue to ensure removal of any residual hydrazine during lyophilization.</p>
<p>2. Ts are weak in the C+T ladder.</p>	<p>Residual salt from ethanol precipitation of end-labeled DNA is carried over into the sequencing reactions and partially suppresses the reaction of hydrazine with thymine in the C+T sample.</p>	<p>Replace the hydrazine with a fresh aliquot or new stock bottle.</p>
<p>3. Bands are present in C and/or C+T ladders at <i>all</i> guanine positions, not just those where guanine follows a pyrimidine in the sequence as in <b>1c</b> above or <b>4</b> below.</p>	<p>A reaction between hydrazine and guanine at lower pH (perhaps due to residual sodium acetate), after which piperidine breaks the DNA at guanines.</p>	<p>As a final purification step, dissolve end-labeled DNA in 25 µl of H<sub>2</sub>O and 1 ml of ethanol, mix, chill, centrifuge, and dry the pellet. Then dissolve it in H<sub>2</sub>O and distribute into sequencing reactions.</p>
<p>4. Bands in C and/or C+T ladders at positions where purines follow pyrimidines in the sequence, but not at every purine in a run as in <b>3</b> above. See also problem <b>1c</b> above.</p>	<p>Residual sodium acetate from the second ethanol precipitation buffers piperidine, leading to incomplete phosphate elimination reactions, which require a high pH. The 3' termini of 5'-labeled fragments then retain deoxyribosyl residues, have one less negative charge, and move one position slower in the gel.</p> <p>Some labeled DNA is not dissolved in the piperidine and therefore does not react with it at 90°C.</p>	<p>Keep the samples at 4°C or below during the ethanol precipitations steps. Use chilled (0–4°C) hydrazine stop solution, sodium acetate, and ethanol. See solution to problem <b>2</b>.</p>
<p>5. All DNA bands and both electrophoresis dyes are retarded in some ladders.</p>	<p>Effect of residual piperidine on gel electrophoresis.</p>	<p>Rinse the last pellet well with 95% ethanol or dissolve it in 25 µl of H<sub>2</sub>O; add 1 ml of 95% ethanol, mix, chill, and collect the reprecipitated DNA by centrifugation.</p>
<p>6. Bands in A&gt;G ladders produced by the older R2 reaction<sup>a</sup> are not sharp.</p>	<p>Overmethylation. Fragments cleaved at adenines carry too many ring-opened 7-methylguanines and are heterogeneous in charge.</p>	<p>After adding piperidine to a tube containing dry DNA, close the cap and bat the tube with fingers to splash the liquid up the walls; then collect it at the bottom with a quick spin.</p>
		<p>Wet the DNA residue, freeze, and lyophilize under a strong vacuum.</p>
		<p>Use the same dimethylsulfate reaction conditions used for reaction R5<sup>a</sup> guanine cleavage. (Weak A&gt;G bands can be strengthened by mixing more often during the acid release, slightly increasing the acid concentration, or introducing extra labeled DNA into samples destined for A&gt;G cleavage.)</p>

(Continued on following page.)

TABLE 12-17 (Continued)

PROBLEM	PROBABLE CAUSES	SUGGESTED SOLUTIONS
7. All ladders exhibit uniform chemical cleavage of desired base specificity, but the bands are not sharp enough to permit reading very far into the sequence.	Sample not evenly distributed in sample well. Diffusion or secondary structural effects during electrophoresis. Parallax or scatter during autoradiography.	Layer samples with a pointed glass capillary, using a slow, side-to-side, sweeping motion. Turn the power up until the gel runs at 50°C. Use a slab gel no more than 1.5 mm thick, preferably 0.5 mm, and compress the X-ray film against it with lead bricks during autoradiography. Dry the gel on a commercial gel dryer before autoradiography.
8. Sudden loss of expected bands, bad spacing, or band order in all four ladders in the middle of a sequencing patterns.	Nested end-labeled cleavage products become long enough to fold into stable hairpins and move anomalously in the gel (the so-called compression effect).	Be sure that the DNA is thoroughly denatured when loaded on the sequencing gel. Prerun and run the gel at a voltage that generates as much heat as the glass plates will tolerate (>50°C).
9. Loss of just one band in both pyrimidine ladders in the middle of a sequencing pattern.	Presence of 5-methylcytosine, which reacts so slowly with hydrazine (relative to unmodified cytosine) that the DNA is not cleaved at that position.	Look for guanine at the corresponding position in the sequence of the complementary strand.
10. Extraneous bands in all ladders throughout a sequencing pattern.	Contaminating end-labeled fragment.  Terminal heterogeneity generated before or during end-labeling by a contaminating nuclease. Unavoidable terminal heterogeneity originating in vivo or as a consequence of DNase I or nuclease S1 treatment in vitro.	Strive for better DNA resolution on the fragment-division or strand-separation gel, or use a different restriction enzyme for secondary cleavage. Purify restriction enzyme, phosphatase, kinase, or terminal transferase. After labeling ragged ends, cleave with restriction enzymes that will give end segments <100 bp long, denature, and fractionate on a 1.5-mm 8% sequencing gel. Strands differing in length by one or more nucleotides will resolve and can be extracted for sequence analysis.
11. An extraneous band across all four ladders at one position in a sequencing pattern	Some double-stranded DNA molecules are nicked by a restriction enzyme at a sequence that closely resembles the enzyme's true recognition site or by a sequence-specific contaminating enzyme. After end-labeling, a double-stranded fragment isolated on a non-denaturing gel retains the hidden break, which is then revealed on the denaturing sequencing gel. This can be confirmed by electrophoresis of some unreacted end-labeled DNA in parallel with the sequencing samples. Unique endogenous nicks and alkali-labile nucleotides are unlikely causes, but they are possible in rare cases and subject to similar tests.	Attempt to derive the sequence surrounding the break on both strands, and compare it with the recognition sequences of all restriction enzymes used to generate that DNA fragment. In making this comparison, remember that bands in the sequencing pattern arise from fragments that lack the nucleotide with which they are identified, whereas enzymatic cleavage products retain all nucleotides. If 3/4, 4/5, or 5/6 of the bases are homologous, tentatively assume nicking at the variant site. Then avoid excesses of that restriction enzyme in subsequent DNA digestions, ideally using just enough pure enzyme to cleave every legitimate site. If the problem persists, avoid that enzyme altogether and use another cleavage route or strand separation.



<p>12. One or a few bands in two ladders produced by cleavage reactions that do not normally share base specificity. Cleavage is consistent with base specificity everywhere else in the sequencing pattern.</p>	<p>Sequence heterogeneity in the DNA at that position. Compression.</p>	<p>Confirm by getting the complementary effect on the other strand. See <b>8</b> above.</p>
<p>13. Difficulty in identifying the band corresponding to chemical cleavage of the ultimate 5' nucleotide (<sup>32</sup>P-labeled with polynucleotide kinase and [<math>\gamma</math>-<sup>32</sup>P]ATP).</p>	<p>[<sup>32</sup>P]Orthophosphate is the product of base-specific chemical cleavage of the <sup>32</sup>P-labeled 5'-terminal nucleotide, and this migrates so rapidly that it is usually run off the gel and missed altogether. A diffuse hydrazinolysis artifact product that sometimes appears between the first and third bands further confuses the interpretation.</p>	<p>Put some [<sup>32</sup>P]phosphate in formamide–buffer–dyes solution, and run as a marker adjacent to products of the four base-specific reactions on a 20% sequencing gel. Prerun the gel, load the five samples, run the gel until the bromophenol blue marker has proceeded one third of the way down the gel, and autoradiograph. A band in one or two of the four usual lanes running even with the phosphate in the fifth indicates which base-specific reaction(s) cleaved the 5'-terminal nucleotide.</p>
<p>14. Difficulty in identifying the band corresponding to chemical cleavage of ultimate 3' nucleotide (<sup>32</sup>P-labeled and incorporated by terminal transferase or DNA polymerase).</p>	<p>With DNA 3' end-labeled by addition of more than one <sup>32</sup>P-labeled nucleotide, chemical attack at the <i>ultimate</i>, added 3' ribonucleotide releases [<sup>32</sup>P]phosphate, which is usually run off the sequencing gel and missed altogether. Furthermore, be aware that none of the four recommended reactions (G, A+G, T+C, C) will cleave riboadenylic acid, since ribonucleotides do not depurinate readily. The three other ribonucleotides should cleave like deoxynucleotides in these reactions. With DNA 3' end-labeled with DNA polymerase, chemical attack at the <i>penultimate</i> deoxynucleotide releases the <sup>32</sup>P-labeled ultimate 3' nucleotide intact.</p>	<p>Put some [<sup>32</sup>P]phosphate in formamide–buffer–dyes solution, and run adjacent to products of the four base-specific reactions on a 20% sequencing gel as described under the solution to <b>13</b> above. This marker will indicate the product of a reaction with the <i>ultimate</i> 3' base.</p>
<p>15. More than one strong band appears at the position of uncleaved DNA at the top of all sequence ladders.</p>	<p>One is a single-stranded DNA and the other double-stranded DNA. Variant or incomplete restriction enzyme cleavage. Contaminating end-labeled fragment. Fragment length heterogeneity.</p>	<p>Digest some of the end-labeled DNA with DNase and snake venom phosphodiesterase, lyophilize, dissolve in formamide–buffer–dyes, and run adjacent to products of the four base-specific reactions on a 20% sequencing gel as described under the solution to <b>13</b>. This marker will indicate the product of a reaction with the <i>penultimate</i> 3' base. Increase dimethylsulfate or hydrazine reaction times, use stronger denaturation before loading samples on the gel, or both. See <b>11</b> above. See <b>10</b> above. See <b>10</b> above.</p>

Reproduced, with permission, from Maxam and Gilbert (1980).

<sup>a</sup>For descriptions of R2 and R5 reactions, please see Maxam and Gilbert (1980).

**ALTERNATIVE PROTOCOL: RAPID MAXAM-GILBERT SEQUENCING**

During the past years, the five chemical cleavage reactions routinely used in the Maxam-Gilbert method of DNA sequencing have been supplemented by a number of additional base-specific cleavage reactions (e.g., please see Rubin and Schmid 1980; Ambrose and Pless 1987; McCarthy 1989; Jelen et al. 1991; Iverson and Dervan 1993; Muro et al. 1993). The additional reactions are usually easier and faster, but the results are generally not as clean as those obtained from the traditional set of Maxam-Gilbert reactions. Rapid methods of chemical sequencing are particularly useful for resolving regions of doubtful sequence, for confirming a known DNA sequence, or for generating DNA sequence ladders for use as size standards in DNase I footprinting (see Chapter 17). A flowchart for rapid Maxam-Gilbert sequencing is given in Table 12-18.

**Additional Materials**

**CAUTION:** Please see Appendix 12 for appropriate handling of materials marked with <!>.

*Allyl alcohol (2-propen-1-ol; Fisher)*

*n-Butanol (HPLC grade or better) <!>*

*Formic acid (8.8%) <!>*

Prepared by diluting 1 volume of concentrated formic acid (88%) with 9 volumes of H<sub>2</sub>O.

*NaOH (30% w/v) <!>*

Prepared by dissolving 30 g of NaOH in 50 ml of H<sub>2</sub>O.

After the pellets have completely dissolved and the solution has cooled, adjust the volume to 100 ml with H<sub>2</sub>O.

▲ **WARNING** NaOH is dissolved exothermically, and it is therefore essential to add the pellets slowly to prevent the solution from boiling.

*Potassium permanganate (2 mg/ml) in H<sub>2</sub>O <!>*

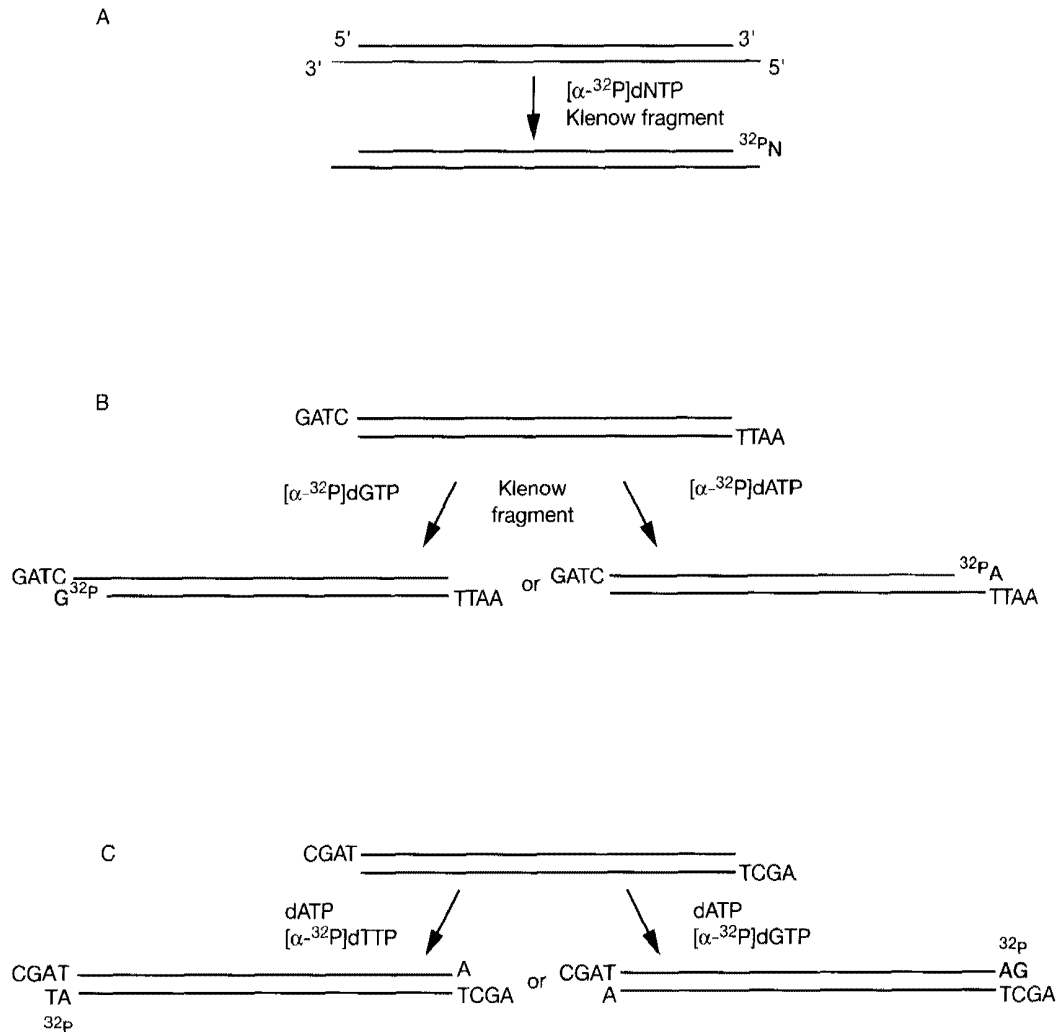
Prepare in the dark at room temperature. This stock solution may be stored in the dark for up to 1 week. The working solution of KMnO<sub>4</sub> is made on the day of use by diluting the stock solution 1:100 in H<sub>2</sub>O.

**Method**

1. Prepare <sup>32</sup>P-end-labeled DNA as described in the panel on **ADDITIONAL PROTOCOL: PREPARATION OF END-LABELED DNA FOR CHEMICAL SEQUENCING** at the end of this protocol.
2. Subject the DNA to the chemical modifications outlined in the flowchart in Table 12-18.
3. After the ethanol precipitation step at the end of the flowchart, resuspend the modified DNA in 100 μl of 1 M piperidine and follow Steps 2–10 of the main protocol.

**TABLE 12-18** Flowchart of Rapid Method of Maxam-Gilbert Sequencing (Alternative Protocol)

A+G	A>C	C+T (C>T)	T
Mix 4 $\mu$ l sonicated DNA 10 $\mu$ l $^{32}$ P-labeled DNA Add 3 $\mu$ l 8.8% formic acid. Incubate 7 minutes at 37°C. Chill to 0°C. Add 150 $\mu$ l 1 M piperidine (at 0°C). Store on ice until all reactions are ready for incubation.	Mix 4 $\mu$ l sonicated DNA 5 $\mu$ l $^{32}$ P-labeled DNA Add 1 $\mu$ l 30% NaOH. Incubate 6 minutes at 90°C. Chill to 0°C. Add 150 $\mu$ l 1 M piperidine (at 0°C). Store on ice until all reactions are ready for incubation.	Mix 4 $\mu$ l sonicated DNA 10 $\mu$ l $^{32}$ P-labeled DNA Add 15 $\mu$ l hydrazine. Incubate 4 minutes at 20°C. Chill to 0°C. Add 1 ml <i>n</i> -butanol. Vortex for 30 seconds. Centrifuge at 12,000g for 2 minutes at 4°C. Remove <i>all</i> supernatant.  Add 150 $\mu$ l H <sub>2</sub> O. Add 1.2 ml <i>n</i> - butanol. Vortex for 30 seconds. Centrifuge at 12,000g for 2 minutes at 4°C. Remove all supernatant.  Lyophilize. Add 150 $\mu$ l 1 M piperidine. Store on ice until all reactions are ready for incubation.	Mix 4 $\mu$ l sonicated DNA 5 $\mu$ l $^{32}$ P-labeled DNA  Incubate 2 minutes at 90°C. Chill to 0°C. Add 20 $\mu$ l KMnO <sub>4</sub> (20 $\mu$ g/ml).  Incubate 8 minutes at 20°C.  Add 10 $\mu$ l allyl alcohol. Vortex for 30 seconds. Lyophilize.  Add 150 $\mu$ l 1 M piperidine.  Store on ice until all reactions are ready for incubation.
Incubate 30 minutes at 90°C.	Incubate 30 minutes at 90°C.	Incubate 30 minutes at 90°C.	Incubate 30 minutes at 90°C.
Add 1.2 ml <i>n</i> -butanol. Vortex for 30 seconds.	Add 150 $\mu$ l ethanol (70%) Add 1.2 ml <i>n</i> -butanol. Vortex for 30 seconds.	Add 1.2 ml <i>n</i> -butanol. Vortex for 30 seconds.	Add 1.2 ml <i>n</i> -butanol. Vortex for 30 seconds.
<p>Centrifuge 2 minutes at 12,000g at 4°C. Remove supernatant <i>completely</i>. Add 150 <math>\mu</math>l 1% SDS, 1–2 ml <i>n</i>-butanol. Vortex for 30 seconds. Centrifuge 2 minutes at 12,000g at room temperature. Remove supernatant <i>completely</i>. Lyophilize for 20 minutes. Add 10 <math>\mu</math>l sequencing gel-loading buffer. Vortex for 20 seconds. Centrifuge 10 seconds at 12,000g at room temperature. Close the tops of the tubes tightly. Heat to 90°C for 1 minute. Load 3 <math>\mu</math>l of each sample on a lane of a sequencing gel.</p>			



**FIGURE 12-8** Examples of Methods Commonly Used to Label Double-stranded DNA Asymmetrically

(A) Isolate target DNA by cleavage with two restriction enzymes, only one of which generates a recessed 3' terminus. Radiolabel recessed terminus with the appropriate [α-<sup>32</sup>P]dNTP and the Klenow fragment. (B) Isolate target DNA by cleavage with two restriction enzymes that generate different recessed 3' termini. Radiolabel one of the recessed terminals with the appropriate [α-<sup>32</sup>P]dNTP and the Klenow fragment. (C) A variation of method B can be used to label asymmetrically target DNA that carries recessed 3' termini with similar, but not identical, sequences.

**ADDITIONAL PROTOCOL: PREPARATION OF END-LABELED DNA FOR CHEMICAL SEQUENCING**

The ends of double-stranded DNA can be labeled as follows:

- Transfer the  $\gamma$ -P from [ $\gamma$ - $^{32}$ P]ATP or, less commonly, [ $\gamma$ - $^{33}$ P]ATP to the free hydroxyl group at the 5' termini of double-stranded DNA. This *in vitro* reaction is catalyzed by bacteriophage T4 polynucleotide kinase (please see Chapter 9, Protocols 14 and 15). (Note that [ $\gamma$ - $^{35}$ S]ATP is not a good substrate for polynucleotide kinase and is transferred inefficiently to 5'-hydroxyl groups.)
- Transfer the chain-terminating base analog [ $\alpha$ - $^{32}$ P]cordycepin triphosphate (3'-desoxyribonucleoside triphosphate) to the free hydroxyl group at the 3' termini of double-stranded DNA (Chapter 9, Protocol 12). This reaction is catalyzed by calf thymus deoxynucleoside terminal transferase (Tu and Cohen 1980).
- Fill recessed 3' termini with [ $\alpha$ - $^{32}$ P]dNTPs in a synthetic reaction catalyzed by the Klenow fragment (Chapter 9, Protocol 10) (Cobianchi and Wilson 1987). Whether this reaction generates DNAs that are labeled at one or both termini depends on whether one or both termini are recessed, and if so, on the sequence of the protruding tails. Often, the filling reaction can be set up so that the radiolabeled dNTP is incorporated into only one terminus of the DNA. In this case, there is no need to cleave the radiolabeled DNA with a restriction enzyme or to purify a fragment by gel electrophoresis before proceeding to chemical sequencing. Examples of this type of asymmetric labeling are shown in Figure 12-8.
- Carry out a PCR with one radiolabeled primer and one unlabeled primer (Hoofit van Huijsduijnen 1992; Konat et al. 1994) (Chapter 8). Because only one of the two strands of the PCR products is labeled, there is no need to cleave the radiolabeled DNA with a restriction enzyme or to purify a fragment by gel electrophoresis before proceeding to chemical sequencing.

Because the first two methods almost always result in the introduction of radiolabel at both termini of the DNA, additional steps are usually required to obtain asymmetrically labeled molecules. In most cases, the radiolabeled DNA is digested with one or more restriction enzymes, and the resulting end-labeled double-stranded fragments are then purified by conventional nondenaturing agarose or polyacrylamide gel electrophoresis. The sole disadvantage of this digestion step is that it requires some prior knowledge of the pattern of cleavage of the DNA by the particular restriction enzyme(s) used.

For the reasons listed below, labeling by PCR is now the method of choice for preparing end-labeled DNAs for Maxam-Gilbert sequencing.

- Radiolabeling can be carried out using small-scale preparations of plasmid DNA.
- Target DNA can often be sequenced from both ends.
- Because labeling by PCR is rapid and simple, many different templates can be prepared for sequencing or manipulation simultaneously.
- There is no need to map the positions of restriction sites within the target DNA before sequencing.

Whatever the method used for radiolabeling, the end-labeled target fragment must contain at least  $5 \times 10^5$  cpm of  $^{32}$ P (by Cerenkov counting, please see Appendix 8) in order to obtain an autoradiograph of a sequencing gel that can be read after 24–48 hours of exposure. To achieve this goal, it is usually necessary to radiolabel at least 0.3 pmole of the target DNA (e.g., 1  $\mu$ g of a 5-kb fragment) and to use  $^{32}$ P-labeled precursors of high specific activity ( $>3000$  Ci/mole).  $^{33}$ P or  $^{35}$ S labeling is not used to prepare DNAs for Maxam-Gilbert sequencing, largely because the lower energy of decay and longer half-lives of these isotopes greatly extend the times required to establish satisfactory autoradiographs.

Whether or not the radiolabeled target DNA is recovered from a gel or directly from an enzymatic reaction, it should be purified by extraction with phenol:chloroform and ethanol precipitation in the presence of 0.3 M sodium acetate (pH 5.2). The pellet of DNA and the sides of the tube should then be washed several times with ice-cold 70% ethanol to remove residual salt. The nearly dry pellet of DNA should then be dissolved in H<sub>2</sub>O at a concentration that equals 5000 cpm/ $\mu$ l. If the quantity of radiolabeled DNA is limiting, it is usually possible to determine an unambiguous DNA sequence by carrying out only four (C, C+T, A+G, and G) of the five reactions detailed in the flow chart.

**▲ IMPORTANT** Do not dissolve the DNA in TE or any solvent containing salt. Salt interferes with the reaction between hydrazine and thymine and so reduces the intensity of the bands in the T+C reaction. Buffers such as Tris that are rich in amine groups can suppress the depurination of A and G.

# Protocol 8

---

## Preparation of Denaturing Polyacrylamide Gels

**I**N SEQUENCING, FOUR SETS OF DNA FRAGMENTS ARE RESOLVED BY ELECTROPHORESIS under denaturing conditions through a thin polyacrylamide gel. This protocol describes how to pour a DNA sequencing gel that contains one concentration of buffer and a single concentration of acrylamide throughout the gel. Urea is included in the gel as a denaturant to ensure that the separated DNA strands remain apart and migrate through the gel as linear molecules. The gel is cast between two glass plates that are separated by two thin Teflon or nylon spacers. A so-called shark's tooth comb or, less frequently, a standard slotted comb forms the sample wells into which the DNA sequencing reactions are loaded before electrophoresis.

Polyacrylamide gels used in the early days of DNA sequencing were grossly thick by today's standards. Autoradiographic exposure times were long, and the bands of DNA were diffuse as a result of quenching and dispersion of the radioactive signal. To alleviate these problems, Fred Sanger and Alan Coulson (1978) devised a method whereby "thin gels" were poured using ultra-thin spacers ranging in thickness from 0.2 mm to 0.5 mm. Thin gels are now used ubiquitously to resolve the products of DNA sequencing reactions.

The following protocol is a third-generation product (Fred Sanger of the MRC, Cambridge, UK; Michael Smith of the University of British Columbia; and David W. Russell of the University of Texas Southwestern Medical Center, Dallas) of the original Sanger and Coulson method for pouring thin gels.

### MATERIALS

---

**CAUTION:** Please see Appendix 12 for appropriate handling of materials marked with <!>.

#### Buffers and Solutions

Please see Appendix 1 for components of stock solutions, buffers, and reagents.  
Dilute stock solutions to the appropriate concentrations.

##### *Acrylamide solution (45% w/v) <!>*

acrylamide (DNA-sequencing grade)	434 g
<i>N,N'</i> -methylenebisacrylamide	16 g
H <sub>2</sub> O	to 600 ml

Heat the solution to 37°C to dissolve the chemicals. Adjust the volume to 1 liter with distilled H<sub>2</sub>O. Filter the solution through a nitrocellulose filter (e.g., Nalge, 0.45- $\mu$ m pore size), and store the filtered solution in dark bottles at room temperature.

An alternative, but more expensive method of preparing the acrylamide stock solution is to purchase a premixed powder of acrylamide:bis from a commercial manufacturer (e.g., Bio-Rad) and to reconstitute the mixture with H<sub>2</sub>O. Stabilized, premixed solutions of acrylamide:bis are available from National Diagnostics, Atlanta, Georgia.

Cheaper grades of acrylamide and bisacrylamide are often contaminated with metal ions. Stock solutions of acrylamide made with these grades can easily be purified by stirring overnight with ~0.2 volume of monobed resin (MB-1, Mallinckrodt), followed by filtration through Whatman No. 1 paper.

During storage, acrylamide and bisacrylamide are slowly converted to acrylic acid and bisacrylic acid. This deamination reaction is catalyzed by light and alkali. Check that the pH of the acrylamide solution is 7.0 or less, and store the solution in dark bottles at room temperature. Fresh solutions should be prepared every few weeks.

#### *Ammonium persulfate (1.6% w/v) in H<sub>2</sub>O <!>*

Ammonium persulfate is used as a catalyst for the polymerization of polyacrylamide gels. The polymerization reaction is driven by free radicals that are generated by an oxido-reduction reaction in which a diamine (e.g., TEMED) is used as the adjunct catalyst (Chrambach and Rodbard 1972). Old ammonium persulfate solutions may not have the catalytic power to drive the polymerization reaction to completion. Fuzzy bands of DNA and various other forms of matrix distortion are the inevitable consequence.

#### *Deionized H<sub>2</sub>O*

*Detergent, household dishwashing*

*Ethanol*

#### *KOH/Methanol solution <!>*

The solution, which is used to clean glass plates used to cast sequencing gels, is prepared by dissolving 5 g of KOH pellets in 100 ml of methanol. Store the solution at room temperature in a tightly capped glass bottle.

#### *Silanizing fluid <!>*

The traditional silanizing fluids (e.g., Sigmacote from Sigma and Repelcote from BDH Inc.) contain dichlorodimethylsilane, which is toxic, volatile, and highly flammable (for information about dichlorodimethylsilane, please see the information panel on **DICHLORODIMETHYLSILANE**). In recent years, nontoxic alternatives have become available, including Gel Slick (FMC Bioproducts), RainX (Unelko, Scottsdale Arizona), and Acrylease (Stratagene).

#### *10x TBE electrophoresis buffer*

TBE is used at a working strength of 1x (89 mM Tris-borate, 2 mM EDTA) for polyacrylamide gel electrophoresis. This 1x concentration is twice the strength usually used for agarose gel electrophoresis (please see Chapter 5). The buffer reservoirs of the vertical tanks used for polyacrylamide gel electrophoresis are fairly small, and the amount of electric current passed through them can be considerable. Use of the 1x TBE concentration provides the necessary buffering power. The pH of the buffer should be 8.3. It is generally not necessary to adjust the pH; however, the pH of each new batch of 10x TBE stock must be carefully checked.

Use the same stock of 10x TBE to prepare both the gel and the running buffers. Small differences in ionic strength or pH produce buffer fronts that can greatly distort the migration of the DNAs.

A modification of the standard TBE buffer using taurine (36 g/liter of 10x TBE buffer) in place of boric acid will eliminate distortions at the top of the gel caused by glycerol-borate anionic ester compounds (Pisa-Williamson and Fuller 1992). For further information, please see the information panel on **GLYCEROL IN DNA SEQUENCING REACTIONS**.

#### *TEMED (N,N,N',N'-tetramethylethylenediamine) <!>*

Electrophoresis-grade TEMED is sold by many manufacturers including Sigma and Bio-Rad. TEMED is hygroscopic and should be stored in a tightly sealed bottle at 4°C. TEMED is used as an adjunct catalyst for the polymerization of acrylamide.

#### *Urea, solid*

## Special Equipment

*Bulldog binder clips (5-cm length; five to seven per gel)*

*Gel-drying racks*

Although not essential, gel-drying racks are certainly extremely convenient for drying and storing glass plates used for sequencing. These racks are available from several manufacturers including BioWhittaker.

*Gel-sealing tape*

For example, 3M Scotch Stretchable Tape (Lab Safety Supply, Janesville, Wisconsin), 3M Scotch yellow electrical tape #56 (Life Technologies), or 3M Scotch polytetrafluorethylene (PTFE) extruded film tape. For a discussion of the usefulness of various types of tape and other methods of sealing gel plates, please see Hengen (1996).

*Glass plates (matched pair) and Spacers*

The rectangular plates are made from nontempered glass, with one plate 3.5–4.0 cm longer than the other, or with one plate notched. Glass is a liquid and thus plates become deformed during use. To reduce the possibility of leaks and cracking, it is best to keep sequencing plates in matched pairs and to use the plates specified by the manufacturer of the sequencing gel tanks.

*Gloves (talc-free, disposable rubber or PVC)**Petroleum jelly*

Optional, please see Step 4.

*Protective bench paper*

Plastic-backed paper (Kaydry Lab Cover from Fisher) or Benchkote.

*Sharktooth comb (0.4-mm thick, with 32, 64, or 96 teeth, depending on the capacity of the gel apparatus)**Side-arm flask (250 ml)**Spacers (two per gel, either constant thickness or wedge shaped)*

Spacers are made of thin (usually 0.4 mm) flexible plastic or Teflon (Sanger and Coulson 1978) and are used to keep the glass plates apart. A watertight seal is formed between the plates and spacers, so that the unpolymerized gel solution does not leak out when the gel is cast.

Wedge-shaped spacers are used to produce gels that are thicker at the bottom than the top. During electrophoresis, the increased cross-sectional area generates field-strength gradients, resulting in sharpening of bands and a more uniform spacing of bands over the length of the gel (Ansorge and Labeit 1984; Olsson et al. 1984). Wedge-shaped gels are recommended when the goal is to increase the read-length of the gel but are not necessarily beneficial when the aim is to resolve compressions or to maximize resolution of a particular region of sequence. Although wedge-shaped gels may overcome band spacing problems, they are difficult to pour and often crack upon drying.

*Syringe (60 cc)*

Optional, please see Step 15.

*Test-tube rack**Water bath preset at 55°C*

Pour the sequencing gels no less than 30 minutes before use. After polymerization, the gels can be stored for up to 24 hours.

## METHOD

---

▲ **IMPORTANT** To prevent contamination of the glass surfaces by skin oils, wear talc-free gloves at all times and handle the plates by their edges.

### Preparation of Glass Plates

1. If necessary, remove old silanizing reagent from plates by swabbing them with KOH/methanol solution.
2. Wash the plates and spacers in a warm, dilute solution of dishwashing liquid and then rinse them thoroughly in tap water, followed by deionized H<sub>2</sub>O. Rinse the plates with absolute ethanol to prevent water spots, and allow them time to dry.

The plates must be cleaned meticulously to ensure that air bubbles do not form when the gel is poured.



3. Treat the inner surface of the smaller or notched plate with silanizing solution. Lay the plate, inner surface uppermost, on a pad of paper towels in a chemical fume hood, and pour or spray a small quantity of silanizing fluid onto the surface of the plate. Wipe the fluid over the entire surface with a pad of Kimwipes and then allow the fluid to dry in the air (1–2 minutes). Rinse the plate first with deionized H<sub>2</sub>O and then with ethanol, and allow the plate time to dry.
4. Lay the larger (or unnotched) glass plate (clean side up) on an empty test tube rack on the bench and arrange the spacers in place along each side of the glass plate (please see Figure 12-9) so they are flush with the bottom of the plate.  
 If using wedge-shaped spacers, place the thicker end of the spacers at the bottom of the plate.  
 Small dabs of petroleum jelly between the spacers and the larger (unnotched) plate will help keep the spacers in position during the next steps.
5. Center the shorter (notched) plate, siliconized side down, on top of larger (unnotched) plate. Make sure that the spacers remain in position at the very edges of the two plates.

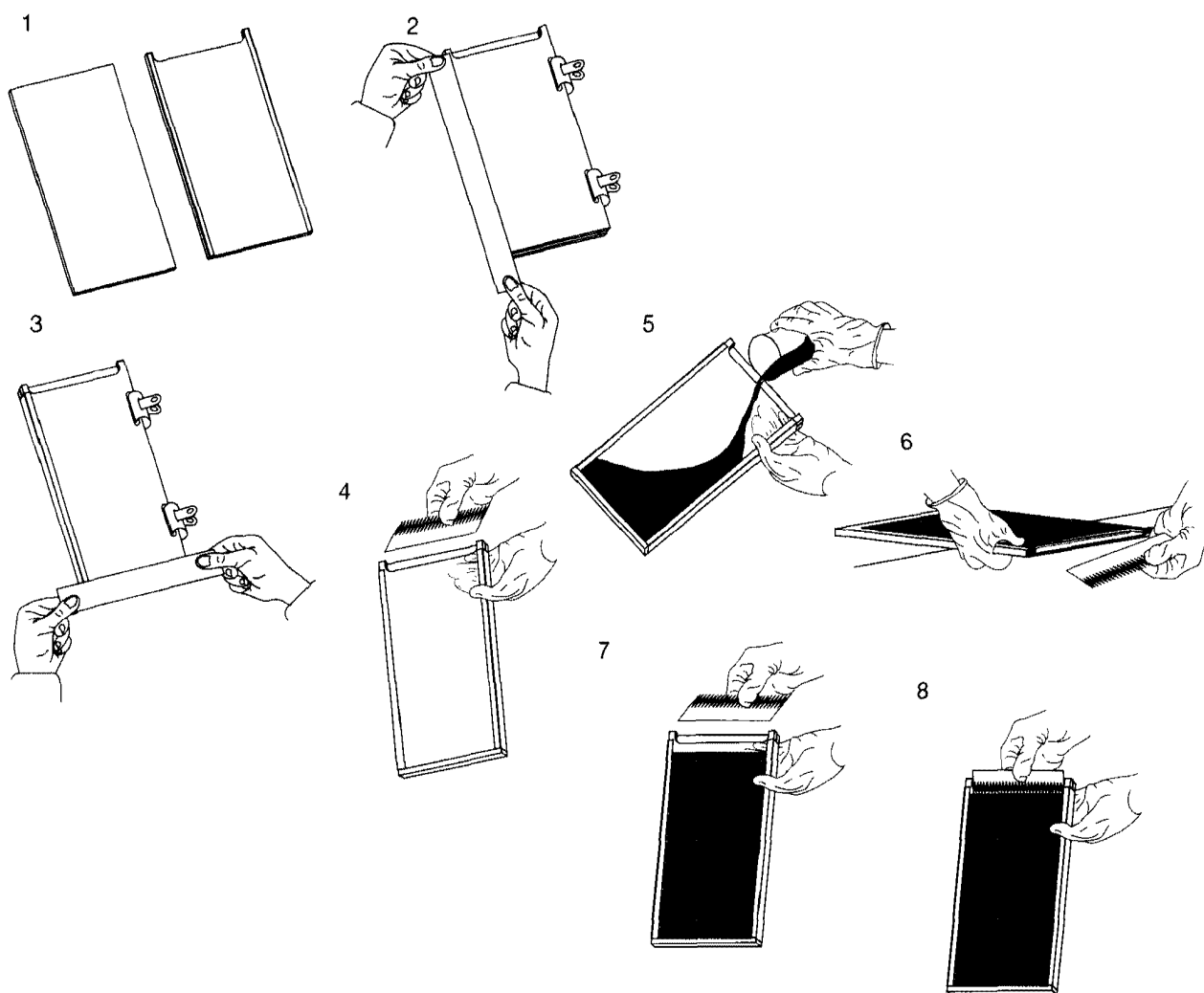


FIGURE 12-9 Preparation of a Sequencing Gel

- Clamp the plates together on one side with two or three large (5-cm length) bulldog binder clips. Bind the entire length of the other side and the bottom of the plates with gel-sealing tape to make a watertight seal.

The aim is to create a watertight seal between the plates and spacers so that unpolymerized acrylamide solution does not leak out. Most leaks occur at the bottom corners of the plates, so it is important to take particular care to leave no gaps when folding the tape around the corners. If possible, the corner sections of tape should be folded as "hospital corners."

- Remove the bulldog clips and seal this side of the gel plates with gel-sealing tape.
- Place the flat side of the sharktooth comb into the open end of the gel mold so that it fits snugly. Remove the comb and lay the empty gel mold on the test-tube rack.

## Pouring the Gel

- Cover the working area of the bench with plastic-backed protective paper.

It is almost impossible to pour sequencing gels without dripping acrylamide solutions onto the bench. Some investigators place a large developing tray on the bench to contain catastrophic spills.

- In a 250-ml side-arm flask, prepare a sequencing gel solution containing the desired concentration of acrylamide as specified in Table 12-19. The volumes given in the table are sufficient for a single 40 × 40-cm sequencing gel and can be proportionally adjusted to accommodate smaller or larger gels.

▲ **IMPORTANT** The preparation of the gel must be completed without interruption from this point onward.

- Combine all of the reagents and then heat the solution in a 55°C water bath for 3 minutes to help dissolution of the urea.

Solubilization of urea is an endothermic reaction that proceeds slowly unless an external source of heat is used. The volume of the solution will be ~66 ml. Add H<sub>2</sub>O to the solution bringing the final volume to 100 ml.

- Remove the solution from the water bath and allow it to cool at room temperature for 15 minutes. Swirl the mixture from time to time.

- Attach the side-arm flask to a vacuum line and de-gas the solution.

This step prevents the formation of air bubbles in the gel mixture during polymerization of acrylamide, which is an exothermic reaction.

- Transfer the solution to a 250-ml glass beaker. Add 3.3 ml of freshly prepared 1.6% ammonium persulfate and swirl the gel solution gently to mix the reagents.

Old ammonium persulfate solutions may not have the catalytic power to drive the polymerization reaction to completion. Fuzzy bands of DNA and various other forms of matrix distortion are the inevitable consequence.

**TABLE 12-19 Acrylamide Solutions for Denaturing Gels**

	4% GEL	6% GEL	8% GEL	10% GEL
Acrylamide:bis solution (45%)	8.9 ml	13.3 ml	17.8 ml	22.2 ml
10X TBE buffer	10 ml	10 ml	10 ml	10 ml
H <sub>2</sub> O	45.8 ml	41.4 ml	36.9 ml	32.5 ml
Urea	42 g	42 g	42 g	42 g

15. Add 50  $\mu$ l of TEMED to the gel solution and swirl the solution gently to mix the reagents. Pour the gel solution into the mold directly from the beaker in which it has been prepared (as shown in Figure 12-9). Alternatively, draw ~40 ml of the solution into a 60-cc hypodermic syringe. Do not suck air bubbles into the syringe!

Compared with polyacrylamide gels used to resolve proteins, a massive amount of TEMED is used to cast sequencing gels. The large amount of TEMED ensures that polymerization will occur rapidly and uniformly throughout the large surface area of the gel. Because the rate of polymerization is temperature-dependent, cooling the gel solution allows more time for casting the gel. Experienced gel pourers can often cast two or more 40  $\times$  40-cm gels from a single gel solution by judicious pre-cooling.

Work as quickly as possible from here onward because the gel solution will polymerize rapidly. Polymerization can be appreciably slowed by putting the gel solution on ice, a boon for inexperienced gel pourers!

16. Allow a thin stream of gel solution to flow from the beaker or syringe into the top corner of the gel mold while holding the mold at an ~45° angle to the horizontal (please see Figure 12-9).

#### TROUBLESHOOTING: AIR BUBBLES

To avoid producing air bubbles, the solution must flow in a continuous stream.

- When using a syringe, gradually lower the mold to a horizontal position as it is filled. When the syringe is nearly empty, refill it with gel solution and quickly resume pouring the gel. Take care that no air bubbles form and that the solution migrates evenly toward the top of the gel mold. This movement can be facilitated by tilting the gel as described and filling the mold at a constant rate.
- If air bubbles form while pouring the gel, tilt the mold so that the level of the acrylamide solution reaches the level of the bubble. With luck, the air bubble will fuse with the meniscus of the acrylamide solution. If this does not happen spontaneously, try tapping the glass.

Bubbles in the upper portion of the gel can sometimes be moved by tapping the glass plates or by inserting a thin spacer (bubble hook) and herding the bubbles to a position where they will not interfere with the migration of the DNA samples. The latter solution is possible only when the full width of the gel is not to be used for loading samples.

Unless the air bubbles can be moved out of the way, the preparation must be done over again. The presence of bubbles is a sign that the gel plates were not cleaned thoroughly before the mold was assembled.

17. Lay the mold down on the test-tube rack (see Figure 12-9).

This positioning reduces the hydrostatic pressure at the base of the mold and prevents leaks and bowing of the gel plates.

18. Immediately insert the *flat side* of a shark's tooth ~0.5 cm into the gel solution. Insert both ends of the comb into the fluid to an equal depth so that the flat surface is level when the gel is standing in a vertical position.

If any air bubbles are visible near the comb, slowly remove the comb from the gel. Wipe the acrylamide solution from the surface of the comb and then slowly reinsert the comb into the gel.

19. Clamp the comb into position using bulldog binder clips. Use the remaining acrylamide/urea solution in the hypodermic syringe/pipette to form a bead of acrylamide across the top of the gel. Allow the gel to polymerize for at least 15 minutes at room temperature.

20. Wash out the 60-cc syringe so that it does not become clogged with polymerized acrylamide.

▲ **WARNING** A small amount of unpolymerized acrylamide is released during washing. Wear gloves.

21. After 15 minutes of polymerization, examine the gel for the presence of a Schlieren line just underneath the flat surface of the comb. This is a sign that polymerization is occurring satis-

factorily. When polymerization is complete (~1 hour after the gel was poured), remove the bulldog clips.

▲ **WARNING** A small amount of unpolymerized acrylamide may be released. Wear gloves.

22. The gel can be used immediately (please see Protocol 11) or stored for up to 24 hours at room temperature or 48 hours at 4°C. To prevent dehydration during storage, leave the tape in place and surround the top of the gel with paper towels dampened with 1x TBE. Cover the paper towels with Saran Wrap. Do not remove the comb at this stage.

#### **TROUBLESHOOTING: LEAKING GELS**

Leakage of the gel solution from the bottom of the mold seems to be an inevitable part of a sequencer's life. Several methods are available to prevent leakage.

- Add an extra band of stretchable tape around the bottom of the glass plates. This remedy is also usually effective when older plates with chipped corners are used in the mold.
- Seal the edges of the plates with molten 3% (w/v) agarose. This approach is messy and requires some artistic talent.
- Insert a plastic spacer into the open space at the bottom of the mold, seal with tape, and then clamp the plates together with bulldog clips. (Note: A bulldog clip should be used on the bottom of the gel mold only when this third spacer is in place; otherwise, the gel will vary slightly in thickness, which in turn can cause electrophoretic abnormalities and crack the glass plates.)
- Seal the bottom of the plate with a strip of filter paper and impregnate with catalyzed acrylamide (Wahls and Kingzette 1988). This is a messy and laborious procedure.

We recommend that investigators use whichever of these methods they find to be most reliable with the particular type of gel mold that is available. Do not get discouraged if the first gel leaks. Most first-time gel pourers have a batting average of ~300. With practice, a majority of taped gel molds will not leak, batting averages will improve, and it will not generally be necessary to go to great lengths to seal the bottom of the gel.

# Protocol 9

---

## Preparation of Denaturing Polyacrylamide Gels Containing Formamide

**A** RECURRING PROBLEM IN DNA SEQUENCING IS THE PRESENCE OF COMPRESSIONS in the sequence caused by secondary structure in the DNA. A simple and straightforward method to eliminate secondary structure during electrophoresis is to include formamide in the sequencing gel (Deininger 1983). Formamide gels are particularly useful and almost a necessity when sequencing DNA templates with a G/C content >55%.

### MATERIALS

---

**CAUTION:** Please see Appendix 12 for appropriate handling of materials marked with <!.>.

This protocol requires all of the reagents listed in Protocol 8, plus:

*Formamide (100%) <!.>*

### METHOD

---

1. Clean and assemble glass plates to form a gel mold as described in Steps 1–8 of Protocol 8.
2. Cover the working area of the bench with plastic-backed protective paper.  
It is almost impossible to pour sequencing gels without dripping acrylamide solutions onto the bench. Some investigators place a large developing tray on the bench to contain catastrophic spills.
3. In a 250-ml side-arm flask, prepare a sequencing gel solution containing the desired concentration of acrylamide as specified in Table 12-20. The volumes given in this table are sufficient for a single 40 × 40-cm sequencing gel and can be proportionally adjusted to accommodate smaller or larger gels.  
**▲ IMPORTANT** The preparation of the gel must be completed without interruption from this point onward.
4. Combine all of the reagents and then heat the solution in a 55°C water bath for 3 minutes to help dissolution of the urea.  
Solubilization of urea is an endothermic reaction that proceeds slowly unless an external source of heat is used.

**TABLE 12-20** Acrylamide Solutions for Denaturing Polyacrylamide Gels Containing Formamide

	4% GEL	6% GEL	8% GEL	10% GEL
Acrylamide:bis solution (45%)	8.9 ml	13.3 ml	17.8 ml	22.2 ml
10x TBE	10 ml	10 ml	10 ml	10 ml
H <sub>2</sub> O	20.8 ml	16.4 ml	11.9 ml	7.5 ml
Formamide	25 ml	25 ml	25 ml	25 ml
Urea	42 g	42 g	42 g	42 g

5. Remove the solution from the water bath and allow it to cool for 15 minutes at room temperature. Swirl the mixture from time to time. Add H<sub>2</sub>O to the solution bringing the final volume to 100 ml.
6. Attach the side-arm flask to a vacuum line and de-gas the solution.  
This step prevents the formation of air bubbles in the gel mixture during polymerization of acrylamide, which is an exothermic reaction.
7. Transfer the solution to a 250-ml glass beaker. Add 3.3 ml of freshly prepared 1.6% ammonium persulfate and swirl the gel solution gently to mix the reagents.
8. Add 50  $\mu$ l of TEMED to the gel solution, and swirl the solution gently to mix the reagents. Draw approximately 40 ml of the solution into a 60-ml hypodermic syringe.
9. Pour the gel solution into the mold, as described in Steps 16–22 of Protocol 8.

▲ **IMPORTANT** Because formamide slows the polymerization reaction substantially, allow the gel to polymerize for 2–3 hours before clamping it in an electrophoresis apparatus.

#### COMPRESSIONS

Listed below are several variations on the above protocol that can be used to melt particularly stubborn compressions.

- Replace all of the H<sub>2</sub>O in the gel solution with formamide.
- Double the TBE concentration in the gel solution and electrophoresis buffer. This modification causes the gel to run at a higher temperature by increasing the electrical resistance and therefore lowers the stability of secondary structure.
- Carry out electrophoresis at very high wattage (see Protocol 11) or in a 37°C warm room, both of which increase the temperature of the gel and reduce formation of secondary structure.

▲ **WARNING** Be on the lookout for cracked plates when running gels at temperatures higher than normal. Stop the electrophoresis run immediately if a plate should crack.

# Protocol 10

---

## Preparation of Electrolyte Gradient Gels

A CHARACTERISTIC FEATURE OF STANDARD, DENATURING POLYACRYLAMIDE GELS used to resolve the products of DNA-sequencing reactions is that the space between the bands of the DNA is greater at the bottom of the gel than at the top of the gel. Progressively greater separation of bands along the length of the gel reflects the logarithmic relationship between the length of a fragment of DNA and its mobility in the gel. The result is that fewer bases can be read from the autoradiograph. The bands at the top are crowded while those at the bottom are sparse.

Several methods have been developed to overcome this drawback observed in sequencing gels of constant thickness, including the pouring of "wedge gels," in which tapered spacers are used to cast polyacrylamide gels that are thicker at the bottom than at the top (Ansorge and Labeit 1984; Olsson et al. 1984). The progressive increase in thickness per unit length of the gel results in a voltage gradient along the length of the gel. Because the electrophoretic mobility of DNA through polyacrylamide gels is, to a first approximation, a linear function of the electric field or voltage gradient (Cantor and Schimmel 1980; Sheen and Seed 1988; Slater et al. 1996; Yager et al. 1997), the migration of the DNA through wedge gels is slower in the thicker (anodic) part of the gel and faster in the thinner (cathodic) part. The net effect is a compression of the spacing between bands of DNA in the lower part of the gel. Although wedge gels elegantly overcome the band-spacing problem, they are difficult to pour, require specialized gel spacers, and often crack upon drying.

Another method of reducing the spacing between smaller DNA fragments and increasing the spacing between larger DNA fragments is to increase progressively the ionic concentration in the lower (anodic) portion of the gel. The voltage carried through the gel decreases with increasing ionic strength, which causes the DNA to migrate more slowly as it travels anodically through the gel. These so-called ionic gradient gels were initially used by Biggin et al. (1983) and were formed by drawing a polyacrylamide gel solution of low ionic strength into a pipette followed by a second solution of higher ionic strength. One or more bubbles were then pulled into the pipette to mix the two solutions at the interface and thereby create a "gradient" between the extremes of ionic strength. The formation of the ionic gradient by this procedure was difficult to control, which in turn led to autoradiographs that often resembled the quills of a porcupine rather than an ordered ladder of DNA bands.

A clever and simple solution to the band-spacing problem was devised by Sheen and Seed (1988), who created an electrolyte gradient within the gel by using buffers of different concentrations in the upper (low electrolyte concentration) and lower (high electrolyte concentration) chambers of the electrophoresis device. The polyacrylamide gel itself is poured with a single concentration of electrolyte throughout, using standard thin (0.4 mm) spacers. The use of these electrolyte gradient gels leads to an increase of ~30% in the number of bases that can be read on an autoradiograph.

This protocol derived from Sheen and Seed (1988) describes how to pour electrolyte gradient gels.

## MATERIALS

---

**CAUTION:**Please see Appendix 12 for appropriate handling of materials marked with <!.>.

This protocol requires all of the reagents listed in Protocol 8, plus:

*Formamide (optional) <!.>*

Electrolyte gradient gels are poured in 1x TBE buffer and can be run in the presence or absence of formamide. For information on denaturing polyacrylamide gels containing formamide, please see Protocol 9.

*Sodium acetate (3 M, pH 7.0)*

## METHOD

---

1. Clean and assemble a set of glass plates to form a gel mold as described in Steps 1–8 of Protocol 8.
2. Cover the working area of the bench with plastic-backed protective paper.
3. Prepare a denaturing polyacrylamide gel as described in Protocol 8 or Protocol 9.
4. Clamp the gel into the electrophoresis device. Fill the upper chamber with 0.5x TBE buffer and the lower chamber with a buffer composed of 2 parts 1x TBE and 1 part 3 M sodium acetate. Load the sequencing reactions and perform electrophoresis as described in Protocol 11.

As electrophoresis progresses, migration of the tracking dyes becomes progressively slower and essentially stops when the bromophenol blue reaches the bottom of the gel. Typically, electrophoresis is continued until the xylene cyanol dye is within 5–10 cm of the bottom of the gel and the bromophenol blue dye is at the bottom.

Bands of DNA can be compressed at different times during the experiment by delaying the addition of the 3 M sodium acetate solution to the lower buffer reservoir. The electrophoretic run is begun with 1x TBE in both the lower and upper reservoirs. At an appropriate stage during the run, one part (0.5 volume) of a solution of 3 M sodium acetate (pH 7.0) is added to the lower buffer reservoir. With experience, it is possible to compress different regions of the sequencing ladder as required to maximize read lengths.



# Protocol 11

---

## Loading and Running DNA-sequencing Gels

**T**HE SETS OF NESTED DNA FRAGMENTS GENERATED BY THE ENZYMATIC or chemical methods of DNA sequencing are resolved by electrophoresis through thin denaturing polyacrylamide gels. The four reactions (G, A, T, and C) in a sequencing set are loaded into adjacent lanes of a polyacrylamide gel, to which a large current is then applied. The negatively charged DNAs migrate anodically at rates that are determined by their sizes. A typical denaturing polyacrylamide gel will resolve DNA fragments in the 15–400-nucleotide size range. For a discussion on the physical basis of DNA movement through gels, please see the information panel on **ELECTRICAL MOBILITY OF DNA**.

### MATERIALS

---

**CAUTION:** Please see Appendix 12 for appropriate handling of materials marked with <!>.

#### Buffers and Solutions

Please see Appendix 1 for components of stock solutions, buffers, and reagents. Dilute stock solutions to the appropriate concentrations.

*0.5x TBE and/or 1x TBE*

#### Gels

*Denaturing polyacrylamide gel <!>*  
Prepared as described in Protocol 8, 9, or 10.

#### Nucleic Acids and Oligonucleotides

*DNA sequencing reactions <!>*  
Carry out the reactions as described in Protocols 3–7.

#### Special Equipment

*Automatic micropipettor (20  $\mu$ l)*  
The micropipettor should be equipped with flat capillary pipette tips (e.g., Multi-Flex tip, Research Products International) or other loading device (please see the panel on **LOADING SEQUENCING GELS** following Step 8).

*Bulldog binder clips (5-cm length; five to seven per gel)*

*Gel temperature-monitoring strips*

These strips are thermochromic liquid crystal (TLC) indicators that change color as the temperature of the gel rises during electrophoresis. Temperature-monitoring strips are sold by several commercial companies, including BioWhittaker. If using an electrophoresis apparatus that has a built-in thermal sensor, the gel temperature-monitoring strips are not needed.

*Pasteur pipette*

*Plastic-covered metal plate*

Optional, please see Step 2.

*Power pack capable of delivering >75 W at constant power*

Most power packs can be set to deliver constant voltage, constant power, or constant current, with automatic crossover. A power pack equipped with multiple sets of outlet sockets and capable of delivering ~300 W of constant power at up to 7000 V can easily handle two or three sequencing gels simultaneously.

*Scalpel fitted with disposable blade*

The scalpel is used to remove the tape from the sequencing gel mold and sometimes to scrape residual polyacrylamide from the walls of the loading well.

*Sequencing gel tanks*

Many types of electrophoresis apparatuses are commercially available. All follow the same general design, but the arrangement of the glass plates and spacers differs slightly from manufacturer to manufacturer. Most commercial devices work well and the choice of manufacturers is largely a personal one. However, we recommend the purchase of devices with built-in metal plates. These plates, which are usually aluminum, distribute heat arising from electrical resistance evenly across the surface of the gel, thereby preventing "smiling" artifacts at the edges of the gel.

*Sharks tooth comb (0.4-mm thick, with 32, 64, or 96 teeth, depending on the capacity of the gel apparatus)*

It is essential to use the same shark's tooth comb that was used during the casting of the gel.

*Syringe (10 cc) and 22-gauge hypodermic needles*

*Water bath set at 85°C or heating block set at 100°C*

The water bath is required only if the sequencing reactions were carried out in microtiter dishes. The heating block is required if the reactions were carried out in microfuge tubes.

## METHOD

---

▲ **WARNING** Large voltages are passed through DNA-sequencing gels at substantial amperages. More than enough current is used in these gels to cause severe burns, ventricular fibrillation, central respiratory arrest, and asphyxia due to paralysis of the respiratory muscles. Make sure that the gel boxes used for electrophoresis are well insulated, that all buffer chambers are covered, and that the box is used on a stable bench top that is dry. Always turn off the power to the box before sample loading or dismantling the gel.

1. Use damp paper towels or a wet sponge to wipe away any dried polyacrylamide/urea from the outside of the gel mold. Pipette several ml of 1× TBE buffer along the top of the smaller or notched glass plate and slowly remove the comb from gel. Cut the electrical tape with a scalpel and strip it from the bottom of the gel mold. *Do not remove the tape from the sides of the gel!*
2. Attach the gel mold to the electrophoresis apparatus with bulldog binder clips, plastic-coated laboratory clamps, or, in the case of electrophoretic devices with built-in screw clamps, according to manufacturer's instructions. The smaller or notched plate should be in direct

contact with the electrophoresis device. The larger, unnotched plate should face the investigator.

If the device does not contain a metal plate to distribute heat produced during electrophoresis, clamp a metal plate to the gel. A plastic-covered aluminum plate, cut to the same size as the unnotched glass plate works well and weighs very little.

3. Fill the upper and lower reservoirs of the apparatus with the appropriate buffer.

#### FOR STANDARD OR FORMAMIDE-CONTAINING GELS

- a. Fill the upper and lower buffer reservoirs with 1X TBE. Make sure that the level of the buffer in the lower chamber is well above the bottom of the plates. The level of the buffer in the upper chamber should be well above the level of the upper edge of the shorter or notched plate and be in direct contact with the gel.
- b. Use a 10-ml syringe filled with 1X TBE to rinse the top of the gel. Make sure that excess polyacrylamide and urea are removed from the gel. If necessary, use a syringe needle to scrape off any polyacrylamide sticking to the glass plates. Remove air bubbles under the bottom of the glass plates in the lower reservoir using a Pasteur pipette.
- c. Attach the electrodes to the electrophoresis apparatus and the power supply. The cathode (black lead) should be attached to the upper reservoir and anode (red lead) to the bottom. Attach the built-in thermal sensor (if available) or temperature-monitoring strip. Run the gel at constant wattage (50–70 W) for ~45 minutes or until the temperature of the gel reaches 45–50°C. Turn off the power supply and disconnect the electrodes.

#### FOR ELECTROLYTE GRADIENT GELS

- a. Fill the upper reservoir with 0.5X TBE, and the lower reservoir with a solution consisting of 2 volumes of 1X TBE plus 1 volume of 3 M sodium acetate (please see Protocol 10).
  - b. Wash the well with 0.5X TBE and remove urea/polyacrylamide as described above. Do not pre-run electrolyte gradient gels.
4. Incubate the microfuge tubes containing the sequencing reactions for 2 minutes in a heating apparatus set at 100°C. If the reactions have been carried out in a microtiter plate, remove the cover from the plate and float the open plate in a water bath for 5 minutes at 85°C.
  5. While the tubes or plates are incubating, fill a 10-cc syringe fitted with a 22-gauge hypodermic needle with 0.5X or 1X TBE, as appropriate. Squirt the TBE forcibly across the submerged loading surface of the gel to remove any remaining urea and fragments of polyacrylamide from the loading area. Continue squirting until no more urea can be seen in the loading area.
 

Urea quickly diffuses from the gel and will remain as a cushion at the bottom of the well or slot. The urea cushion, being of higher density than the sequencing reactions, will displace the reactions from the base of the well. Displacement results in an uneven migration of the DNA fragments into the gel and distortion in the sequence ladder.
  6. Gently insert the shark's tooth comb (teeth downward) into the loading slot. Push the comb down until the points of the teeth just penetrate the surface of the gel.
  7. Transfer the microfuge tubes or microtiter plate from the water bath or heating block to ice. Keep the samples at 0°C until they are loaded onto the gel. Quick-cooling to low temperature retards renaturation of the template and radiolabeled strands.

8. Load 1–5  $\mu\text{l}$  (please see Protocols 3–7 for recommended volumes) of each sequencing reaction into adjacent slots of the gel.

Please see the panel on **LOADING SEQUENCING GELS**.

The sample will flow into the well and form a tight band on the surface of the polyacrylamide gel. Keep a record of the order of the templates and load the samples in every reaction set in the same order.

An aliquot of an old sequencing reaction can be loaded into an extra slot at the end of the gel to serve as a landmark. This control unambiguously distinguishes right from left on the final autoradiograph.

### LOADING SEQUENCING GELS

#### Order of Bases

The four or five base-specific reactions generated in an enzymatic or chemical DNA-sequencing experiment are loaded onto denaturing polyacrylamide gels in a specific order from left to right. Many investigators prefer to load the reactions into adjacent lanes in the order TCGA. The two tracks (G and C) that suffer most from abnormal patterns of migration (e.g., compression) are then located next to each other, which facilitates base-calling. Other investigators prefer the order CTAG, because that is the way it has always been done in Cambridge, England. Fred Sanger preferred an alphabetical order with his pyrimidines first followed by his purines. If the gel is loaded in either of these two orders, then the sequence of the complementary strand (3'-5') can be read by flipping the autoradiograph over and reading the gel from the bottom. The tracks on the flipped autoradiograph are read from left to right and their order is then recorded as TCGA or CTAG.

Some types of DNA sequencings call for a specialized loading order. For example, when sequencing a G/C-rich template, there are advantages to loading the reactions in duplicate in the order GATCG-TAC. Each of the four sequencing reactions is then adjacent to the other three, which allows closely spaced bands to be ordered more easily. A similar tactic is followed when using base analogs such as 7-deaza-dGTP and dITP. The quality of sequence produced with these analogs is not as high as that produced with dGTP, and the migration of DNAs containing them is slightly different. To alleviate gel reading problems, it is helpful to load adjacent lanes of a polyacrylamide gel in the order IATCITAC, where I is the sequencing reaction in which dITP or 7-deaza-dGTP was substituted for dGTP in the chain-terminating reaction.

In some enzymatic sequencing reactions, only a single dideoxynucleotide reaction is carried out. These so-called T tracks or G tracks, etc., were initially used by Sanger et al. (1980) to distinguish between large numbers of bacteriophage M13 templates in a shotgun DNA-sequencing strategy. A variation on this strategy can be put to good use when using DNA sequencing to screen for naturally occurring or induced mutations in a gene or exon. In a typical experiment, DNA templates corresponding to a normal or wild-type gene and one or more putative mutation-bearing alleles are sequenced separately by the enzymatic method using all four ddNTPs. On the resulting sequencing gel, all of the ddC reactions derived from the normal and mutant allele templates are loaded next to each other, followed by all of the ddTTP reactions, the ddATP reactions, and the ddGTP reactions. If one wild-type and three mutant templates were sequenced, then the order on the gel would be CCCC, TTTT, AAAA, GGGG, where the first lane in each group of four corresponds to the normal allele. This type of loading simplifies the identification of templates whose DNA sequence differs from that of the normal allele. Bases that are identical between the normal and mutant alleles will generate bands at the same position, whereas a mutant will not. In the case of a point mutation, for example, a novel band corresponding to the substituted base will appear at the position of the normal base. Insertion or deletion mutations can be easily located by identifying the position on the gel at which the correspondence between bands obtained from mutant and wild-type alleles first becomes disrupted.

#### Loading Devices

Several different methods can be used to load the samples into the wells of the gel. The best by far is a automatic micropipettor (20  $\mu\text{l}$ ) equipped with a flat capillary pipette tip that fits comfortably into the well formed by the teeth of a shark's tooth comb (Multi-Flex Tip, Research Products International). The sample can thus be layered directly on the surface of the gel. The tip should be washed out with 0.5x or 1x TBE between loadings.

Alternatively, a syringe equipped with a 30-gauge needle can be used. This needle is narrow enough to enter the space between the two glass plates, and the sample can be layered directly on the surface of the gel. Take care not to touch the gel with the needle. The syringe and needle must be washed well with 0.5x or 1x TBE between samples. Excess TBE should be ejected before the next sample is drawn into the syringe and needle.

**TABLE 12-21 Migration Rates of Marker Dyes through Denaturing Polyacrylamide Gels**

POLYACRYLAMIDE GEL	BROMOPHENOL BLUE <sup>a</sup>	XYLENE CYANOL FF <sup>a</sup>
5%	35	130
6%	29	106
8%	26	76
10%	12	55
20%	8	28

In electrolyte gradient gels, bromophenol blue migrates progressively more slowly as it travels anodically through the gel. Migration essentially ceases when the dye nears the bottom of the gel. The xylene cyanol tracking dye behaves in a similar fashion. Typically, electrophoresis is continued until the xylene cyanol dye is within 5–10 cm of the bottom of the gel and the bromophenol blue dye is at the bottom.

<sup>a</sup>The numbers are the approximate sizes of DNA (in nucleotides) with which the indicated marker dye will comigrate in a standard DNA sequencing gel.

9. When all of the samples have been loaded, connect the electrodes to the power pack and the electrophoresis apparatus: cathode (black) to the upper reservoir and anode (red) to the bottom reservoir. Run the gel at sufficient constant power to maintain a temperature of 45–50°C.

Gel Size (cm)	Power (W)	Voltage (V)
20 x 40	35–40	~1700
40 x 40	55–75	~2–3000
40 x 40 (electrolyte gradient gel)	75	~2100

The time required to achieve optimal resolution of the sequence of interest must be determined empirically. Monitor the progress of the electrophoretic run by following the migration of the marker dyes in the formamide gel-loading buffer (please see Table 12-21).

10. Depending on the distance between the sequence of interest and the oligonucleotide primer, apply a second loading of the sequencing samples to a standard or formamide-containing denaturing polyacrylamide gel ~15 minutes after the bromophenol blue in the first set of samples has migrated to the bottom of the gel (1.5–2.0 hours). The sequence obtained from the first loading will be more distal to the primer, whereas that obtained from the second loading will be more proximal. The length of readable sequence can be extended by ~35% by reloading the samples into a fresh set of lanes 2 hours after the samples were first loaded.
- Turn off the power supply and disconnect the sequencing apparatus.
  - Replace the buffer in the top and bottom reservoirs.
  - Denature the samples by heating as described in Step 4 above.
  - Load the samples.
  - Reconnect the sequencing apparatus to the power supply.
  - Run the gel, as before, at sufficient constant power to maintain a temperature of 45–50°C. Alternatively, extend the length of readable sequence by replacing the buffer in the lower chamber with a buffer composed of 2 parts 1X TBE and 1 part 3 M sodium acetate at an appropriate stage in the electrophoretic run (please see Protocol 10).
11. At the end of the run, follow the procedures described in Protocol 12 to dismantle the gel and perform autoradiography.

# Protocol 12

---

## Autoradiography and Reading of Sequencing Gels

**F**OR FURTHER INFORMATION ABOUT AUTORADIOGRAPHY, PLEASE REFER to the discussion in Appendix 9.

### MATERIALS

---

**CAUTION:** Please see Appendix 12 for appropriate handling of materials marked with <!.>.

#### Buffers and Solutions

Please see Appendix 1 for components of stock solutions, buffers, and reagents. Dilute stock solutions to the appropriate concentrations.

*Gel-fixing solution (mix in the order shown) <!.>*

- 300 ml of methanol
- 2.4 liters of H<sub>2</sub>O
- 300 ml of glacial acetic acid

#### Radioactive Compounds

*Radioactive ink or Chemiluminescent markers <!.>*

Please see Appendix 9.

Reusable alternatives to radioactive ink are chemiluminescent markers available from Stratagene (Glogos). The markers can be used multiple times and should be exposed to fluorescent light just prior to a new round of autoradiography.

#### Gels

*DNA sequencing gels*

Prepared and run as described in Protocols 8–11.

#### Special Equipment

*Autoradiography cassettes (metal, spring-loaded 35.6 x 43.2 cm)*

*Enhancing screens (as appropriate).*

Two large enhanced calcium tungstate screens (e.g., Lightning Plus, Dupont) are needed per film.

*Gel dryer set at 80°C.*

The gel dryer should be connected via a trap to a vacuum system.

*Mylar sheet (~5 cm larger than the gel in length and breadth)*

The Mylar sheet is used to keep the gel flat during drying under vacuum.

Saran Wrap

Stainless steel metal spatula or scalpel

Tray for fixing the gel

The tray should be ~5 cm larger than the gel in length and breadth.

Whatman 3MM CHR paper (or equivalent)

Whatman 3MM paper (or equivalent)

X-ray film (blue sensitive 35 x 43 cm)

For  $^{32}\text{P}$ -labeled DNA, use a double-sided film such as X-Omat-AR (Kodak) or BioMax MS (Kodak). For  $^{33}\text{P}$ - and  $^{35}\text{S}$ -labeled DNAs, use a single-sided film such as BioMax MR (Kodak).

X-ray film processor

## METHODS

1. At the end of the electrophoretic run (Protocol 11), turn off the power and disconnect the sequencing apparatus from the power pack. Dispose of the electrophoresis buffer and then remove the gel mold from the apparatus.
2. Lay the gel mold flat on plastic-backed protective bench paper with the smaller (notched) plate uppermost. Allow the gel to cool to  $<37^{\circ}\text{C}$  before proceeding.
3. Remove any remaining pieces of gel-sealing tape. Use the end of a metal spatula to pry apart the plates of the mold slowly and gently. The gel should remain attached to the longer (non-siliconized) glass plate.

▲ **WARNING** Wear safety glasses. Glass plates will occasionally chip during this procedure. Note that the surfaces of the glass plates that were in contact with the gel may be contaminated with radioactivity and should be treated appropriately.

If the gel adheres to both plates, replace the partially dislodged, smaller or notched plate back on the gel, invert the plates, and try again. If the gel remains stuck, follow the gel-fixing procedure described in Step 12 of this protocol to float the gel off one of the plates.

Steps 4–13 of this protocol may be omitted if the products of the sequencing reactions are labeled with  $^{32}\text{P}$ , for example, if the enzymatic sequencing was primed with  $^{32}\text{P}$ -labeled oligonucleotide primer or if  $[\alpha\text{-}^{32}\text{P}]\text{dNTP}$  was incorporated during extension of an unlabeled primer. A reading of 20–100 cps when a minimonitor is used to scan the surface of the gel indicates that sufficient radioactivity is present to forego drying. In this case, cover the gel with Saran Wrap, make sure that there are no wrinkles, mark the orientation, and directly expose the gel (still attached to its glass plate) to X-ray film. This procedure has the disadvantages of tying up gel electrophoresis plates during autoradiography and does not yield bands that are as sharp or as intense as those of a dried gel. In addition, radioactive fluid tends to ooze from the gel during exposure to X-ray film. Having come this far, do not take such a risk for the sake of saving a couple of hours work.

The radiolabeled products of Maxam-Gilbert sequencing reactions are generally not labeled sufficiently to forego fixing and drying.

4. When the glass plates have been separated, cut off a bottom or top corner on the side of the gel that was loaded first. This landmark serves to orient the gel during subsequent manipulations.
5. Fix the gel in gel-fixing solution (methanol/acetic acid; please see Materials).  
Sequencing gels with  $^{33}\text{P}$  or  $^{35}\text{S}$  should be fixed before drying. This step is optional for gels labeled with  $^{32}\text{P}$ . However, fixation improves resolution, sometimes enhances the signal derived from low amounts of radioactivity, and eliminates high concentrations of urea or formamide from the gel. Fixation is also a last resort for removing a gel that is impossibly stuck to both plates of the mold.

6. Transfer the gel (together with its supporting glass plate), to a shallow tray containing methanol:acetic acid solution. Fix the gel for 30 minutes at room temperature. Do not agitate the fluid while the gel is being fixed.

Thinner gels are fixed more rapidly, thicker more slowly. A gel 0.2 mm in thickness is fixed in 10 minutes; a gel 0.6 mm in thickness requires ~1 hour.

The same batch of fixation fluid can be used to fix several gels. If the gel shows signs of detaching from the supporting glass plate, cover it with a piece of stiff plastic netting (available from many hardware stores) to prevent the gel from escaping and forming a crumpled mass.

7. After 30 minutes, lift the glass plate very, very slowly from the fixation solution. Try to keep the plate horizontal until most of the fixation solution has drained away. Lay the plate, gel side uppermost, on a stack of paper towels. Blot excess fixation solution from the glass plate with Kimwipes. Try not to touch the surface of the gel with the Kimwipes. Remove wrinkles and blemishes from the gel by gently caressing its surface with gloved fingers.
8. Prepare a piece of Whatman 3MM CHR paper (or equivalent) that is slightly larger (2–3 cm) than the gel in both length and width. Hold the paper in a bow shape and touch the center of the bow to the center of the gel. Let the paper fall gently onto the surface of the gel and then apply gentle pressure so that the gel becomes firmly attached to the rough surface of the paper.
9. Hold the paper in place with one hand and pick up the supporting glass plate with the other hand. Quickly flip the sandwich over and lay it down on the bench top with the glass plate facing upward. Gently separate the 3MM CHR paper from the glass plate by lifting the plate upward. The gel will stick to the 3MM CHR paper as the glass plate is pulled away.
10. Lay the 3MM CHR paper (gel uppermost) on two pieces of Whatman 3MM paper of the same size. Cut a piece of Saran Wrap slightly longer and wider than the gel and lay it on top of the gel. Try to avoid creases and bubbles. This step is more easily accomplished with the help of another person. Hold the corners of the Saran Wrap and pull outward so that it is tightly stretched. Lower the stretched Saran Wrap onto the surface of the gel. Once the Saran Wrap has touched the gel, do not attempt to remove it, since this can cause the gel to tear. The flat end of an agarose gel comb, a Kimwipe, or a plastic card can be used to remove any bubbles of air trapped between the gel and wrap.

Alternatively, stretch and tape an appropriately sized piece of Saran Wrap to the bench, ensuring that there are no wrinkles. Then invert the gel and place face down on the Saran Wrap.
11. Use a paper cutter or sharp pair of scissors to trim all three pieces of Whatman paper and the Saran Wrap to approximately the same size as the gel.
12. Place the sandwich of paper, gel, and Saran Wrap on the gel dryer, with the plastic wrap uppermost. Use a sheet of Mylar to keep the sandwich flat during drying.
13. Following the instructions of the manufacturer of the gel dryer, dry the gel for 30–60 minutes under vacuum at 80°C.

Drying the gel reduces the distance that radioactive particles must travel before hitting the X-ray film, thereby increasing the sensitivity of detection.
14. Remove the gel from the dryer and peel off the Saran Wrap. The dried gel should feel smooth to the touch and not sticky. A quick remedy to stickiness is to turn a powdered latex glove inside out and use the talcum powder on the inside of the glove to dust the gel. To orient the gel, attach a small adhesive label marked with radioactive or chemiluminescent ink to the 3MM CHR paper in the space created by cutting the bottom corner of the gel (Step 4).



15. In a darkroom, place the dried gel (gel side up) in a spring-loaded metal cassette. Cover the gel with a sheet of unexposed X-ray film. Close the cassette. Establish an autoradiograph by exposing the gel to the film for 16–24 hours at room temperature or  $-80^{\circ}\text{C}$ .

The time required for a perfect exposure of a sequencing gel cannot be predicted with accuracy. If everything has gone very well during the sequencing reactions, 16–24 hours may turn out to be too long by a factor of 5 or more. In less fortunate circumstances, considerably longer exposure may be required. The major aim at this point is to take a first look at the gel, to see if the sequencing reactions have gone well, and to use the intensity of the bands as a guide to set up one or more additional exposures.

16. Develop the autoradiograph according to the recommendations of the manufacturer of the film and read the sequence of the DNA as described in the information panel on **READING AN AUTORADIOGRAPH**.

*From a book full of mysterious pictures, they learned about the uses of hair and eggshells and feces and worms, herbs and the blood of a red-haired man. They painted black the walls of their room and then hung pictures they snipped from their books; alchemists' labs juxtaposed with models of DNA and the three-dimensional structure of hemoglobin. Their father turned dirt and sunlight into wine; was that alchemy or chemistry? Either one might turn their isolation into freedom.*

*And so of course they studied biochemistry in college...*

Andrea Barrett, *The Marburg Sisters In Ship Fever*.

## AUTOMATED DNA SEQUENCING

From its inception, the dideoxy chain-termination method of DNA sequencing (Sanger et al. 1977a), with enzymatic reactions carried out in aqueous solvents at moderate temperatures, was an obvious candidate for automation. By the early 1980s, the development of automated sequencing was well under way, using DNA molecules labeled with fluorescent dyes rather than the traditional radioisotopes (Smith et al. 1986). By the middle of the decade, automated fluorescent sequencers had been developed in which the products of dideoxy-sequencing reactions were separated by gel electrophoresis, dye molecules were excited by a laser beam, and the fluorescent signals were amplified and detected by photomultiplier tubes (or a CCD camera in later models) (for reviews, please see Chen et al. 1991; Hunkapiller et al. 1991; Chen 1994). Because fluorescent signals could be detected and processed continuously, gels could be run for longer times and more data could be collected. Computer software identified each nucleotide based on the distinctive color (emission wavelength) of each different dye, to identify (call) each base according to the shape of the fluorescent peak and the distance between successive peaks.

### Evolution of the Technology

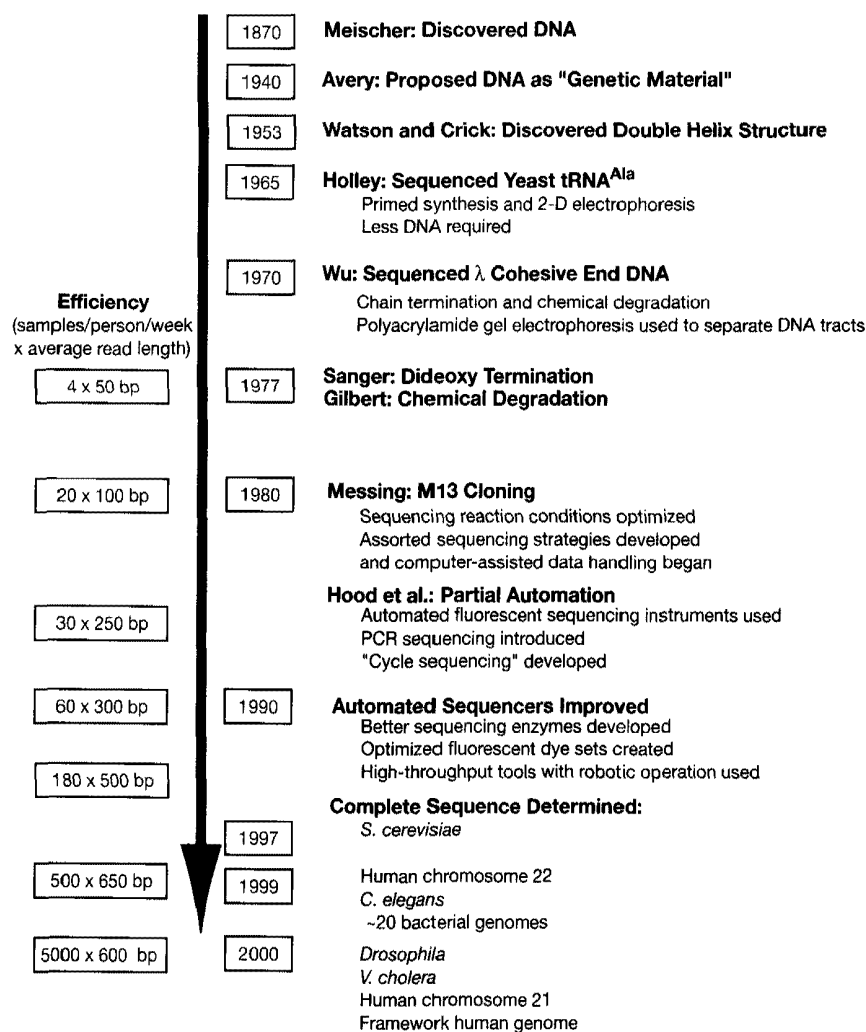
The events leading to current automated sequencing technology are summarized in Figure 12-10. The powerful impact of technical advances on sequencing efficiency is evident from the improvement in the number of samples (and average read-length per sample) that can be achieved in 1 week by a skilled, dedicated investigator. Judged from today's standards, the capacity of automated sequencers available up to 1990 was low, and data were often variable and poor in quality (Martin and Davies 1986; Chen et al. 1991; Hunkapiller et al. 1991). However, there was a great leap forward when PCR was harnessed to the dideoxy method in "cycle sequencing" (Carothers et al. 1989), a process that linearly amplifies signals and thereby greatly augments the sensitivity of sequencing. Additional improvements in dye chemistry and modifications of DNA polymerases have been a further source of enormous progress throughout the 1990s. As a consequence, the rate of sequencing had increased ~30-fold by 1998, so that a single investigator in a well-equipped laboratory could handle 500 samples a week with an average read-length of 650 bases per sample. By the year 2000, that rate had increased by another order of magnitude in high-throughput facilities equipped with capillary-based sequencers and robotic tools.

Initially, there were two major types of commercial instruments, both of which used gel electrophoretic separation of DNA fragments, one using single-dye four-lane separation (Ansorge et al. 1987), and the other using four-dye single-lane separation (Smith et al. 1986). Because of their higher throughput, greater consistency, and lower sensitivity to electrophoretic artifacts, the single-lane instruments have gradually become the approach of choice. The current slab gel model ABI 377 automated sequencer, which dominated the commercial market during the late 1990s, has a capacity of 96 samples per run, with two to four runs a day (depending on the read-lengths desired).

Capillary-based equipment delivers six to eight runs a day while eliminating the tedious gel preparation and sample loading steps. Capillary electrophoresis (Swerdlow and Gesteland 1990; Smith 1991; Yan et al. 1996; Dovichi 1999) also offers other advantages over traditional slab gel systems.

- Because each capillary is very small in diameter (50–100  $\mu\text{m}$ ), heat generated during electrophoresis can be rapidly dissipated. Very high voltages can therefore be applied to achieve separation of the products of sequencing reactions in a shorter period of time.
- Because each sample is loaded into a discrete capillary, there is no need for time-consuming tracking of lanes on gel images.

As of early 2000, three 96-channel, one 8-channel, and one 1-channel capillary-based sequencers were available (Boguslavsky 2000): MegaBACE (96-channel, Molecular Dynamics, California), ABI 3700 and ABI 310 (96-channel and 1-channel, respectively; PE Biosystems), SCE9610 (96-channel, Spectru-Medix, Pennsylvania), and CEQ 2000 (8-channel, Beckman Coulter, California). The ABI 3700 model is also equipped with an automated loader, permitting >6 runs a day unattended by an operator, or a capability of >4000 samples a week. Including the resultant savings in person power, this machine can increase sequencing efficiency by tenfold from the operations using previous models and has the potential to reduce the cost per finished base by a comparable factor.



**FIGURE 12-10 DNA Sequencing History**

Courtesy of E.Y. Chen.

Of course, sequencing efficiency is also directly related to the nature of the DNA substrate. In general practice, DNA molecules that contain more repetitive sequence tracks or homopolymer sequence elements, or higher GC content, require more work (E.Y. Chen et al. 1996). Within a single project, some regions also tend to be more troublesome. To solve specific problems, several modifications of the dideoxy method have been developed in the past decade. For example, the use of nucleotide analogs such as inosine or deaza compounds can help eliminate "gel-compression" problems (Jensen et al. 1991), in which a sequence tract is concealed in a single unresolved band; the inclusion of pyrophosphatase to decompose the pyrophosphate accumulated during chain elongation prevents the loss of peaks ("missing peaks") resulting from reverse polymerase reactions (Tabor and Richardson 1990); the addition of single-strand-binding proteins to sequencing reactions improves the quality of the data produced from DNA templates enriched in looping structures (Chen et al. 1991); and, finally, the use of different cloning vectors provides an alternative when a particular M13 clone is unstable (Chen and Seeburg 1985; Chisoe et al. 1997). Many of these variations have been incorporated into current automated sequencing protocols, particularly as part of extensive projects.

### Methods in Automated Sequencing

The following discussion is based on the specifications of the ABI model Automated Sequencer, the equipment currently used by most sequencing facilities.

### Dye-Primer Sequencing

In sequencing with dye primers, four separate reactions are carried out for each DNA sample, each reaction containing a different dye-labeled primer. This set of four reactions is then mixed and loaded into a single channel for gel electrophoresis (Smith et al. 1986; Lee et al. 1997). The sequencing reagent "kit" has a set of four primers, each containing a different dye incorporated into an oligonucleotide, typically 17–20 bases in length. Sensitivity can be improved and signal intensity enhanced by using "energy transfer" (ET) primers that carry two separate dyes (Ju et al. 1995; Lee et al. 1997). These ET primers typically contain a single donor dye, which can be easily excited by the argon ion laser. The donor dye transfers the energy to one of four secondary (acceptor) dyes, each with a distinctive emission spectrum. Compared to the earlier single-dye primer sets, the ET primers typically provide three- to fourfold stronger signals (Ju et al. 1995). Amersham and PE Biosystems are two vendors of dye-primer reagents. Amersham (ET primer kit) provides the two dyes attached at two different bases, about five nucleotides apart; PE Biosystems (BigDye-primer kit) provides the two dyes connected by an aminobenzoic acid linker (the so-called BigDye), both attached to the 5' end of the primers.

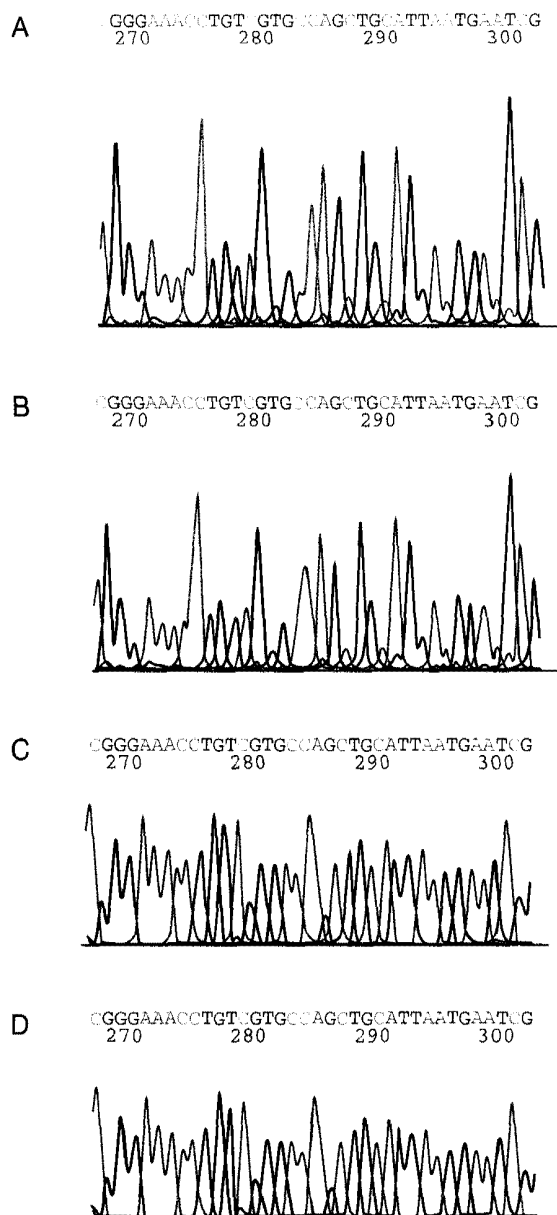
Either *Taq* polymerase, T7 DNA polymerase (Sequenase; Tabor and Richardson 1987a, 1995), or Thermo Sequenase (Reeve and Fuller 1995) can be used, but the *Taq* polymerase mutant (e.g., AmpliTaq FS from PE Biosystems) is frequently used under cycle sequencing conditions. With thermostable enzymes, the signal is linearly amplified, and hence only 0.1 µg or less of template is needed. This feature is especially important when a robotic operation is used to prepare hundreds of templates in smaller quantities. The standard sequencing kit replaces dGTP with deaza-dGTP to reduce gel compression (see above). For unknown reasons, the use of the deaza compound sometimes results in peak broadening, which reduces the readable length of sequencing tracts. Nevertheless, the average read-length with dye-primer sequencing has now reached 650–700 bp at >99% accuracy in 11–12-hour runs (2400 V with 48-cm slab gel) on the ABI 377 Sequencer (C. Chen et al. 1996). Detailed experimental protocols are provided with convenient manufacturer's kits that contain all of the reagents necessary for dye-primer sequencing reactions.

### Dye-Terminator Systems

Although the dye-primer method is suitable for sequencing projects that use universal primers, projects that require custom-designed primers become cumbersome and expensive because each primer must be modified in four separate dye-labeling reactions. One way around this problem is to attach the fluorescent dyes to dideoxynucleotides that become incorporated at the 3' end of the products of sequencing reactions (L. Lee et al. 1992; Rosenblum et al. 1997). Each of the four ddNTPs is labeled with a different dye linked to the nitrogenous base via a linker. Four chain-extension reactions can then be carried out with the same primer in a single tube, sparing considerable labor and cost. By contrast to dye-primers, dye-terminator chemistry has the additional advantage that it eliminates noise arising from premature chain termination without attendant incorporation of dideoxynucleotides.

In its earlier phase of development, dye-terminator chemistry had major problems resulting from the attachment of bulky dye moieties to the dideoxy terminator molecules. Because substrate affinity was altered, it became necessary to tailor a specific set of dye-labeled terminators for use with each DNA polymerase (L. Lee et al. 1992). Unfortunately, the intensity of the signals generated by these polymerase-substrate pairs was frustratingly uneven, which reduced the accuracy of base calling and limited the range of readable sequence (please see Figure 12-11A). During the late 1990s, this problem was largely solved by the use of modified enzymes (please see Figure 12-11B and discussion below) as well as by the introduction of optimized sets of new dyes and linker arms (Figure 12-11C,D). These improvements provided clearer peak patterns, minimal mobility shifts, and cleaner signals. As a consequence, the quality of the data from current dye-terminator sequencing became comparable to results obtained using dye-primers (Rosenblum et al. 1997; Heiner et al. 1998).

At present, two sets of second-generation dye terminators are available. One incorporates dichlororhodamine dyes (dRhodamine Terminator, PE Biosystems); the other incorporates the BigDyes (BigDye Terminator, PE Biosystems). The BigDyes are used in dye-primer sequencing (see above). They contain a fluorescein isomer as the donor dye and four dichlororhodamine dyes as the acceptors. Both terminators work well with AmpliTaq polymerase FS (please see Figure 12-11, bottom panels). Convenient cycle-sequencing conditions are normally used, and the sequencing reactions can be carried out with any primer and with a wide variety of templates (single-stranded DNA, double-stranded DNA, or PCR-generated



**FIGURE 12-11 Comparison of Profiles of Dye-Terminator Sequencing Chemistries**

(A) Rhodamine dye terminators sequenced with AmpliTaq polymerase results in very uneven peak pattern. The most noticeable ones are the small C peaks after G, small T peaks after T and G, and large C peaks after C (Parker et al. 1995). (B) Rhodamine dye terminators sequenced with AmpliTaq polymerase FS results in a much improved pattern when compared to the original AmpliTaq sequencing data. However, small G peaks after A and C, and large A peaks after G can sometimes cause errors in base calling (Parker et al. 1996). (C) Dichlororhodamine dye terminators and AmpliTaq polymerase FS result in very even peak patterns. The overall signal is slightly weaker than the rhodamine terminator chemistry, but the weak G peaks after A and large A peaks after G are moderated. (D) BigDye terminators sequenced with AmpliTaq polymerase FS result in very even peak heights and stronger signals. The overall signal and evenness of peak height are much improved compared to dichlororhodamine terminator chemistry. (Courtesy of E.Y. Chen.)

DNA). In addition, because reactions with AmpliTaq FS use far fewer dye terminators, tedious gel-filtration (spun column) steps to remove unincorporated dyes before gel loading can often be replaced by simple ethanol precipitation. Again, dGTP is replaced with dITP (deoxyinosine triphosphate) to reduce gel compressions.

### Sequencing Enzymes

Naturally occurring polymerases have features that are often not optimal for DNA sequencing. The relevant and desirable properties of sequencing polymerases include (Tabor and Richardson 1987a, 1989a,b, 1995):

- **High processivity.** Processivity is the degree to which chain extension continues before the enzyme dissociates from a primer-template annealing complex. T7 Sequenase is the most processive of the current catalog of sequencing enzymes, whereas the Klenow fragment is the least.
- **Thermostability.** Resistance to inactivation or dissociation at high temperatures is a most important factor in the cycle-sequencing reactions that are the basis for modern high-throughput sequencing. *Taq* polymerase or variants are the only feasible options.
- **Incorporation of nucleotide analogs such as dye terminators.** The ability to incorporate analogs is a critical factor for the dideoxy chain-termination method. The efficiency of chain termination with each of the dye-labeled terminators must be similar to avoid low-quality data with uneven peaks (see Figure 12-11). Enzymes such as AmpliTaq FS with a high affinity for their dye terminators have an advantage because a much lower concentration of the dye terminators can be used, with savings in both cost and effort otherwise needed to remove the unincorporated dyes.
- **Exonuclease activities.** Polymerases often have 3'-exonuclease "proofreading" and/or 5'-exonuclease activities that remove RNA primers after DNA replication. Because neither activity is desirable for sequencing, variants of the polymerases should be used that lack these activities (e.g., Thermal Sequenase [Amersham] and AmpliTaq polymerase FS [PE Biosystems]).

For more information on modified thermostable DNA polymerases. Please see Table 12-9 in Protocol 5.

### Sequencing Templates

Until recently, the primary data in large-scale sequencing operations have been traditionally collected using dye-primer sequencing; dye-terminator sequencing has been used only to fill gaps or to deal with troublesome regions (E.Y. Chen et al. 1996). However, obtaining "finished" data of the highest quality requires that all sequences be acquired either in both orientations or using both chemistries. Comparison of the results obtained using both chemistries provides a check of sequence quality, because the pattern of errors for each chemistry is usually different (Chissoe et al. 1997). With recent improvements, however, the less laborious dye-terminator method is gradually replacing dye-primers in most large-scale sequencing projects. Sequencing with two sets of dye terminators, dRhodamine and BigDye, could become a new standard for the achievement of the desired "double coverage."

BigDye terminator sequencing reactions work well with a wide variety of templates, including single-stranded, double-stranded, and PCR-generated DNAs, as well as with bacterial artificial chromosome (BAC) clones or genomic DNA fragments as large as 5 Mb (C. Chen et al. 1996; Heiner et al. 1998). The optimal sequencing conditions for various templates are given in Table 12-22. Although the intensity of signals tends to be lower with larger templates, base-calling quality remains high, because the baseline noise is sharply reduced by the increased brightness and improved spectral resolution of the dyes (Rosenblum et al. 1997). To compensate for the lower molarity of larger templates in sequencing reactions, increased primer concentrations (2–5 $\times$ ) may be used, and the reaction can be maintained for an increased number of cycles. These alterations enhance signal intensities and produce more accurate, longer read-lengths.

### Optimizing the Reaction

Several other factors remain important for achieving optimal results with automated sequencing.

- Although this is a "low-tech" consideration, it is critical to use template DNA clean and free of any contaminants that might interfere with primer annealing. For PCR products in particular, contaminating oligonucleotides and dNTPs can be conveniently digested by *ExoI/SAP* treatment (Hanke and Wink 1994; Werle et al. 1994; C. Chen et al. 1996).
- For loading on capillary-based automated DNA sequencers, samples must be free of ions as they interfere with the electrokinetic injection process. Take special care to eliminate excess dye-terminators before loading samples on gels in both conventional and automated sequencers. This is particularly important when template DNAs are large, since residual dyes can make obscure low-intensity signals (Heiner et al. 1998).

**TABLE 12-22 BigDye-Terminator Sequencing Conditions for Various Types of Templates**

Template types	M13/ PCR Products	Plasmid	BAC	Microbial DNA
Typical sizes	2–9 kb	<10 kb	200 kb	up to 5 Mb
<b>Reaction mix</b>				
Template DNA (approximately)	30 ng	400 ng	500 ng	2–3 µg
BigDye Terminator Mix	3 µl	4 µl	16 µl	16 µl
Primer	3 pmoles	3 pmoles	6 pmoles	12 pmoles
Total volume	10 µl	10 µl	40 µl	40 µl
<b>Cycling conditions</b>				
Initial denaturation	96°C/1 minute	96°C/1 minute	95°C/5 minutes	95°C/5 minutes
Denaturation	96°C/10 seconds	96°C/10 seconds	95°C/30 seconds	95°C/30 seconds
Annealing	52°C/10 seconds	52°C/10 seconds	55°C/20 seconds	55°C/20 seconds
Extension	60°C/4 minutes	60°C/4 minutes	60°C/4 minutes	60°C/4 minutes
Number of cycles	25	25–50	30–75	45–99
<b>Reaction clean-Up</b>				
Ethanol or isopropanol precipitation	yes	yes	yes	yes?
G-50 Spun column	no	no	yes	yes
<b>Loading on 377 Sequencing Gel</b>				
Resuspension volume	3+ µl	3+ µl	2 µl	2 µl
Loading volume	1 µl	1 µl	1–2 µl	2 µl
Read-length (bases)	750+	750+	550–750	500–600

Courtesy of E.Y. Chen.

- As might be expected, the design of the primer is critical. In general, the same rules are used to design primers for automated sequencers and for sequencing by hand. In brief, successful primers consist of a unique sequence of 16–25 nucleotides (the larger the template DNAs, the longer the oligonucleotides), with an appropriate GC content and a low predisposition to fold into secondary structure (Buck et al. 1999).
- For laboratories analyzing large numbers of samples, an effective quality-controlling system, together with operational tools such as liquid-handling robots, is essential to maintain consistently high-throughput and accuracy.

## Genome Sequencing Strategy

The expansive increase in data throughput resulting from technological advances has been accompanied by innovations in sequencing strategies. Until 1998, the general approach taken for sequencing larger genomes (those >5 Mb, including yeast, nematode, *Arabidopsis*, and humans) consisted of mapping followed by sequencing. Specifically, the construction of overlapping arrays of large-insert *E. coli* subclones (e.g., BACs) averaging 150–200 kb was followed by the complete sequencing of each of these clones one by one. The BAC clones are sequenced by a well-established shotgun method that uses random cloning of 1–2-kb fragments, followed by the sequencing of enough samples to cover the target region randomly.

With increased sequencing throughput, the mapping process tends to become a bottleneck. However, recent sequencing approaches based on a whole-genome shotgun approach (Weber and Myers 1997; Venter et al. 1998) have successfully challenged the traditional clone-by-clone strategy (Green 1997). This strategy has been used as an alternative to finish the Human Genome Project and to move ahead with mouse and other complex genomes (for news report, see Pennisi 2000). The technical difference lies in the fact that the whole-genome shotgun approach for a large genome like that of the human requires the “simultaneous” assembly of some 60 million sequence reads (~500 bases each), whereas the former strategy (mapping followed by sequencing) relies on the assembly of a few thousand reads at a time. Thus, intense arguments

among the proponents of the two approaches have focused on issues such as computing capability, gap-filling problems, and cost efficiency. Nevertheless, it is generally agreed that a whole-genome shotgun approach can rapidly generate new data, albeit in an often fragmentary form, to facilitate faster discovery of novel genes. The successful application of this strategy is dependent on high-powered computers and sophisticated software that can digitize data quality while comparing and matching the reads from both ends of each of the millions of sequencing samples. In the real world, shotgun approaches also make use of a variety of mapping information from clones, genes, and genetic markers, all of which help to assist assembly. Furthermore, using DNA samples from multiple individuals will likely result in the discovery and cataloging of millions of polymorphic sites. By early 2000, a growing number of scientists believed that a combination of the map/sequence and shotgun strategies was the optimal approach (see Pennisi 2000).

## Prospects

The last 15 years have brought sequencing instrumentation and chemistry to a point that truly approaches fully automatic sequencing (please see Figure 12-10). Accompanying improvements in base-calling software, assembly software, and template preparations have progressively simplified both the sequencing operation and the later editing processes. As a result, the limiting factors for most large-scale projects are the purchase and upkeep of machines and the cost of reagents rather than the involvement of a large number of highly skilled personnel. Investigators should thus be free to carry out the tasks for which automated sequencing was invented in the first place — to identify genes, rivet them to physical maps, chase them to their evolutionary roots, and chart their organization, patterns of expression, and biological function.

---

## MICROTITER PLATES

---

The components of dideoxy-mediated DNA sequencing reactions can be assembled in the wells of heat-resistant microtiter plates with 96 U-shaped wells of ~300- $\mu$ l capacity. All steps of the subsequent reactions — from initial annealing of primers and template to addition of formamide-dye stop mixture — can then be carried out without transferring the reaction mixtures to fresh tubes or plates. Microtiter plates are especially valuable when several sets of sequencing reactions are performed simultaneously. The various components of the reaction can be transferred to the wells with 8- or 12-channel multichannel pipettors so efficiently that 96 sequencing reactions can be completed with ease within 1 hour. Because the individual components of the reactions are delivered as droplets to the walls of the wells, all 96 reactions can be started simultaneously simply by centrifuging the plates in a swing out rotor equipped with plate holders. Both fluorescent and radioactive labels can be accommodated (Smith et al. 1993). The following are the chief problems.

- **Heating the microtiter plate** during the annealing step, so that the fluid in all of the wells of the plate is the same. It is important to use microtiter plates that are designed for use in thermal cyclers and are thin enough to facilitate rapid transfer of heat into and out of the plate. Incubation at 55°C (the annealing step), 37°C (the extension-termination step), or 85°C (the denaturation step) can then be carried out in a thermal cycler or by purchasing or constructing a heating block that can be accommodated in a standard modular heating unit (Koop et al. 1990). Sequencing reactions were heated in earlier days by floating open microtiter plates, like armadas, on the surface of water baths. This was fun but led to contamination of many water baths by radioactivity and the ruination of many sequencing reactions by flooding or evaporation.
- **Condensation and evaporation.** Nowadays most heating devices and thermal cyclers are usually equipped with heated covers, which greatly reduce evaporation and condensation. Evaporation can be further reduced by covering the plate with Saran Wrap or with a well-fitting plastic lid (e.g., Falcon 3913; Becton Dickinson).
- **Cross-contamination of wells.** Careful handling is required to prevent accidental transfer of fluid between different wells. It is best to seal the plates for the mixing and storage steps with plastic plate sealers and pressure-sensitive film (Falcon 3073; Becton Dickinson).
- **Centrifugation.** A centrifuge fitted with a rotor capable of supporting microtiter plates and capable of speeds up to 4000 rpm is required. The rotor trays should be well-padded with rubber or polystyrene foam.



## THE KLENOW FRAGMENT OF *E. COLI* DNA POLYMERASE I

*E. coli* DNA polymerase I (Pol I), an enzyme central to DNA replication and repair (Kornberg and Baker 1992), is cleaved by mild treatment with subtilisin into two fragments, the larger of which, comprising residues 326–928, is known as the Klenow fragment. The DNA polymerase and 3'→5' exonuclease activities of Pol I are carried on the Klenow fragment (Brutlag et al. 1969; Klenow and Henningsen 1970; Klenow and Overgaard-Hansen 1970), whereas the 5'→3' exonuclease activity of the holoenzyme is carried on the smaller amino-terminal fragment (residues 1–325), which is nameless (for review, please see Joyce and Steitz 1987; please also see Table 12.23).

The nucleotide sequence of the Pol I gene is known (Joyce et al. 1982), and the segment of DNA encoding the Klenow fragment has been cloned into various expression vectors. Large amounts of the protein have been prepared both for commercial purposes and for biophysical and biochemical studies, including X-ray crystallography (e.g., please see Joyce and Grindley 1983; Pandey et al. 1993).

### Uses of Klenow Enzyme in Molecular Cloning

- **Filling the recessed 3' termini created by digestion of DNA with restriction enzymes.** In many cases, a single buffer can be used for both cleavage of DNA with a restriction enzyme and subsequent filling of recessed 3' termini. The end-filling reaction can be controlled by omitting one, two, or three of the four dNTPs from the reaction and thereby generating partially filled termini that contain novel cohesive ends.
- **Labeling the 3' termini of DNA fragments by incorporation of radiolabeled dNTPs.** In general, these labeling reactions contain three unlabeled dNTPs each at a concentration in excess of the  $K_m$  and one radiolabeled dNTP at a far lower concentration, which is usually below the  $K_m$ . Under these conditions, the proportion of label that is incorporated into DNA can be very high, even though the rate of the reaction may be far from maximal. The presence of high concentrations of three unlabeled dNTPs lessens the possibility of exonucleolytic removal of nucleotides from the 3' terminus of the template. Which of the four  $\alpha$ -labeled dNTPs is added to the reaction depends on the sequence and nature of the DNA termini.

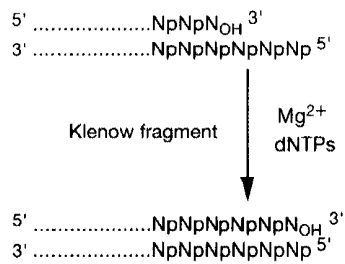
Recessed 3' termini can be labeled with any dNTP whose base is complementary to an unpaired base in the protruding 5' terminus. Therefore, radioactivity can be incorporated at any position within the rebuilt terminus depending on the choice of radiolabeled dNTP. To ensure that all the radiolabeled molecules are the same length, it may be necessary to complete the end-filling reaction by carrying out a "chase" reaction containing high concentrations of all four unlabeled dNTPs.

Blunt-ended and protruding 3' termini may be labeled in an enzymatic reaction that uses both domains of the Klenow fragment. First, the 3'→5' exonuclease activity removes any protruding tails from the DNA and creates a recessed 3' terminus. Then, in the presence of high concentrations of one radiolabeled precursor, exonucleolytic degradation is balanced by incorporation of radiolabeled dNTP at the 3' terminus. This reaction, which consists of cycles of removal and replacement of the 3' terminus from recessed or blunt-ended DNA, is sometimes called an exchange or replacement reaction. The specific activities that can be achieved with this reaction are modest because the 3'→5' exonuclease of the Klenow enzyme is rather sluggish, especially on double-stranded substrates. T4 DNA polymerase carries a more potent 3'→5' exonuclease that is ~200-fold more active than the Klenow fragment and is the enzyme of choice for this type of reaction.

**TABLE 12-23** Division of *E. coli* Pol I into Functional Domains

ENZYMATIC FUNCTION	DOMAIN
Polymerization of dNTPs	Carboxy-terminal domain (46 kD) (residues 543–928)
Exonucleolytic digestion of DNA in a 3'→5' direction	Central domain (22 kD) (residues 326–542)
Exonucleolytic digestion of DNA in a 5'→3' direction	Amino-terminal domain (residues 1–325)

The first two domains constitute the Klenow fragment of polymerase I.



**FIGURE 12-12 Filling-in Recessed 3' Termini of DNA Fragments Using Klenow DNA Polymerase**

The 3' termini generated by digestion with restriction endonucleases may be labeled using the Klenow fragment of DNA polymerase I in the presence of dNTPs and  $Mg^{2+}$ .

If a [ $^{35}S$ ]dNTP is used instead of the conventional [ $\alpha$ - $^{32}P$ ]dNTP, the reaction is limited to one cycle of removal and replacement since the 3'→5' exonuclease of *E. coli* DNA Pol I, unlike the exonuclease of T4 DNA polymerase, cannot attack thioester bonds (Kunkel et al. 1981; Gupta et al. 1984).

- **Labeling single-stranded DNA by random priming** (Feinberg and Vogelstein 1983, 1984) (please see Chapter 9, Protocol 1).
- **Production of single-stranded probes by primer extension** (Meinkoth and Wahl 1984; Studencki and Wallace 1984) (please see Chapter 7, Protocol 12).

For many years, the Klenow enzyme was the highest-quality DNA polymerase that was commercially available and, in consequence, was the enzyme of first and last resort for in vitro synthesis of DNA. However, as polymerases that are better suited to various synthetic tasks have been discovered or engineered, Klenow has been gradually replaced and is no longer the enzyme of first choice for a wide variety of procedures in molecular cloning. Listed below are some of these procedures.

- **DNA sequencing by the Sanger method.** Klenow has been replaced by T7 DNA polymerase (Sequenase) and thermostable polymerases that give longer read-lengths.
- **Synthesis of double-stranded DNA from single-stranded templates** during in vitro mutagenesis. Although the Klenow fragment is still widely used for in vitro synthesis of circular DNAs using mutagenic primers, it is not always the best enzyme for this purpose. Unless large quantities of ligase are present in the polymerization/extension reaction mixture, the Klenow enzyme can displace the mutagenic oligonucleotide primer from the template strand, thereby reducing the number of mutants obtained. This problem can be solved by using DNA polymerases that are unable to carry out strand displacement, including bacteriophage T4 DNA polymerase (Nossal 1974; Lechner et al. 1983; Geisselsoder et al. 1987), bacteriophage T7 DNA polymerase (Bebenek and Kunkel 1989), and Sequenase (Schena 1989). Bacteriophage T4 gene 32 protein can be used in primer-extension reactions catalyzed by DNA polymerases (including the Klenow enzyme) to alleviate stalling problems caused by templates rich in secondary structure (Craik et al. 1985; Kunkel et al. 1987).
- **Polymerase chain reactions.** The Klenow fragment was the enzyme used in the first PCRs (Saiki et al. 1985). However, it has now been completely replaced by thermostable DNA polymerases that need not be replenished after each round of synthesis and denaturation.

## Facts and Figures

The standard assay used to measure the polymerase activity of the Klenow fragment is that of Setlow (1974) with poly(d[A-T]) as template. One unit of polymerizing activity is the amount of enzyme that catalyzes the incorporation of 3.3 nmoles of dNTP into acid-soluble material in 10 minutes at 37°C. A sample of pure Klenow fragment has a specific activity of ~10,000 units/mg protein (Derbyshire et al. 1993). The reaction is usually carried in the presence of  $Mg^{2+}$ . Substitution of  $Mn^{2+}$  for  $Mg^{2+}$  increases the rate of misincorporation and decreases the accuracy of proofreading (Carroll and Benkovic 1990). The  $K_m$  of the enzyme for the four dNTPs varies between 4 and 20  $\mu M$ . For methods to assay the exonuclease activity of the Klenow fragment, please see Freemont et al. (1988) and Derbyshire et al. (1988).

**PREPARATION OF STOCK SOLUTIONS OF OLIGONUCLEOTIDE PRIMERS FOR DNA SEQUENCING**

Dideoxy-mediated DNA-sequencing reactions generally contain five to ten times more molecules of oligonucleotide primers than single-stranded DNA template. However, this is not a hard and fast rule, and investigators should not feel constrained to maintain the ratio of primer:template if the results of sequencing reactions are unsatisfactory. Among the problems that can often be solved by increasing or decreasing the ratio of primer:template are sequencing artifacts caused by multiple priming events; inefficient priming of double-stranded DNA templates; and low yields of products in cycle-sequencing reactions. With custom-synthesized oligonucleotide primers, it is sometimes necessary to determine empirically the optimum ratio of primer to template in the sequencing reaction.

Stock solutions of oligonucleotide primers can be used for both DNA sequencing and 5'-end labeling. Wear gloves when dissolving or diluting oligonucleotide primers. If the oligonucleotide primers are to be used solely for DNA sequencing, lyophilized powder stocks should be dissolved at a concentration of 1–2 µg/ml (0.03–0.05 A<sub>260</sub>/ml) in H<sub>2</sub>O. Stock solutions are stored at –20°C.

It is often convenient to have on hand two solutions of an oligonucleotide primer, one of 185 µg/ml (5.0 A<sub>260</sub>/ml), which can be phosphorylated in reactions catalyzed by polynucleotide kinase (see Chapter 10, Protocol 2) and used in sequencing reactions, and the other at a concentration of 1–2 µg/ml (0.03–0.05 A<sub>260</sub>/ml) for sequencing reactions with a radiolabeled dNTP.

A universal primer (1 µg) that is 19 nucleotides in length is ≈160 pmoles. For conversion values of oligonucleotides of other lengths, please see Table 12-24.

Primers synthesized in the laboratory and destined for DNA sequencing in the presence of a radiolabeled dNTP generally need not be purified by gel electrophoresis before use. The amount of contamination by "off size" oligonucleotides is usually too small (<10%) to affect the quality of the DNA sequence. This observation is not true when 5'-radiolabeled oligonucleotides are used as primers in sequencing reactions. Primers that have been purified by gel electrophoresis (see Chapter 10, Protocol 1) are preferred for this purpose. Primers purified in this way also yield the best sequence data in cycle-sequencing protocols (Protocol 6).

Universal primers of several different lengths (from 15 to 26 nucleotides) are available from a number of different commercial suppliers (please see the information panel on **UNIVERSAL PRIMERS** in Chapter 8). There is no detectable difference in the quality of the sequence obtained from recombinant bacteriophage M13 templates with primers of different lengths. However, when denatured double-stranded DNA templates such as bacteriophage or plasmids are used, longer primers (>20 nucleotides) give rise to fewer artifactual bands.

**TABLE 12-24** Converting Molarities of Oligonucleotides to Units of Weight

SIZE OF OLIGONUCLEOTIDE (NUCLEOTIDES)	PMOLES OF DNA IN 1 µg	MOLECULES OF DNA IN 1 µg
8	385	2.32 × 10 <sup>14</sup>
10	308	1.85 × 10 <sup>14</sup>
12	257	1.55 × 10 <sup>14</sup>
14	220	1.34 × 10 <sup>14</sup>
16	193	1.16 × 10 <sup>14</sup>
18	171	1.03 × 10 <sup>14</sup>
20	154	9.27 × 10 <sup>13</sup>

Numbers given in the table are calculated, based on the assumed molecular mass of the nucleotide of 324.5 daltons and the value of Avogadro's number to be 6.0220 × 10<sup>23</sup>.

---

**SEQUENASE**

---

**Wild-type T7 DNA Polymerase**

This polymerase consists of two subunits, one encoded by the bacteriophage, the other by the *trxA* gene of *E. coli*. Gene 5 of bacteriophage T7 encodes a DNA polymerase ( $M_r \sim 80,000$ ) that consists of three separate domains, one of which bears a high degree of homology with the DNA-binding and polymerization domains of other members of the B(Pol $\alpha$ ) family of DNA polymerases, including *Taq* polymerase and *E. coli* DNA polymerase I (for reviews, please see Joyce and Steitz 1994, 1995; Pelletier 1994; Perler et al. 1996; Steitz 1998). The binding/polymerization domain occupies most of the carboxy-terminal sequences of the wild-type T7 DNA polymerase. The amino-terminal domain of the molecule carries a powerful 3'-5' exonuclease activity that is active on both single- and double-stranded DNAs. A third domain of the polymerase (the 76-residue "thumb" domain) forms a 1:1 complex with the host-encoded protein, thioredoxin (Doublé et al. 1998; Kiefer et al. 1998).

Because of its rapid rate of polymerization and high processivity, the polymerase:thioredoxin complex is able to replicate the entire genome of T7 without dissociating from the template DNA (Huber et al. 1987; Tabor et al. 1987; Bedford et al. 1997).

**Sequenase Versions 1.0 and 2.0**

The potent 3'-5' exonuclease activity of wild-type T7 DNA polymerase, which would butcher any attempt to use the enzyme for DNA sequencing, can be greatly reduced by incubating the enzyme for several days with a reducing agent, molecular oxygen, and stoichiometric concentrations of ferrous ions (Tabor and Richardson 1987b). Inactivation is thought to be the result of site-specific modifications of the exonuclease domain by locally produced free radicals. Bacteriophage T7 DNA polymerase that had been chemically modified in this fashion was at one time marketed by United States Biochemical (USB), under the trade-name Sequenase. This first version of the sequencing enzyme was later superseded by Sequenase version 2.0 in which the 3'-5' exonuclease domain has been completely inactivated by deletion of 28 amino acids (Tabor and Richardson 1989a). The exonuclease-deficient forms of Sequenase display a powerful strand-displacement ability, which enables them to negotiate regions of template that are folded into secondary structures.

One unit of Sequenase catalyzes the incorporation of 1 nmole of nucleotide into an acid-insoluble form in 30 seconds at 37°C, using 5  $\mu$ g of primer and M13mp18 DNA as the template under standard assay conditions. Because the specific activities of Sequenase and Sequenase version 2.0 are different from each other, the manufacturer (USB) used different definitions for the units of activity of the two enzymes. Approximately 2.5 units of Sequenase is equivalent to 1 unit of Sequenase version 2.0. Both enzymes are supplied by the manufacturer at a concentration that generally is optimal for sequencing after dilution by 8–20-fold. Dilution is required to reduce the concentration of glycerol, which reacts with borate ions in the electrophoresis buffer and causes distortions in the region of the sequencing gel that contains fragments of DNA in the 400–600-nucleotide range (please see the information panel on **GLYCEROL IN DNA SEQUENCING REACTIONS**).

**Sequenase Efficiently Incorporates ddNTPs and Other Analogs of dNTPs**

Sequenase is such a good enzyme for DNA sequencing because it generates long sequencing ladders with little variation in labeling intensity from one band to the next (Fuller 1992). Remarkably, this property turns out to be in large part due to a single hydroxyl group attached to the tyrosine residue at position 526 of the enzyme (Tabor and Richardson 1995). Sequencing polymerases other than Sequenase catalyze the incorporation of ddNTPs at only 0.02–1% of the rate of dNTPs. Sequenase is far more efficient. Under conditions routinely used for DNA sequencing, Sequenase catalyzes the incorporation of ddNTPs at ~100 nucleotides/second, which is ~33% of the rate of dNTPs. However, replacing the tyrosine residue at position 526 with phenylalanine decreases the efficiency of usage of ddNTPs by >2000-fold. Conversely, replacing the analogous amino acid of *E. coli* DNA polymerase I or *Taq* polymerase with a tyrosine residue increases the efficiency of usage of ddNTPs up to 8000-fold (Tabor and Richardson 1995). Enzymes that have been modified in this way (please see Table 12-9) can generate sequencing gels that match those of Sequenase in length, beauty, and sharpness. Like several other sequencing enzymes, Sequenase readily uses as substrates

dye-labeled terminators (L. Lee et al. 1992; Fuller et al. 1996),  $\alpha$ -thio dNTPs, and dGTP analogs such as 7-deaza dGTP and dITP, which are used to eliminate compression artifacts from sequencing gels (Tabor and Richardson 1987a).

The development of Sequenase has been predominantly the work of just one laboratory — that of Charles Richardson at Harvard Medical School — with the bulk of the work being carried by Stanley Tabor, then an M.D./Ph.D. student. Tabor is the son of Herbert Tabor, for many years the Editor-in-Chief of the *Journal of Biological Chemistry*, and Cecilia Tabor, a leader in the field of polyamines. In a logical and elegant series of papers, Tabor and Richardson reported the use of the chemically modified version of bacteriophage T7 DNA polymerase as a replacement in dideoxy-sequencing reactions for the Klenow enzyme of *E. coli* DNA polymerase I (Tabor and Richardson 1987b); the use of  $Mn^{2+}$  instead of  $Mg^{2+}$  (Tabor and Richardson 1989b) to generate bands that are highly uniform in intensity (Tabor and Richardson 1989b); the engineering of Sequenase version 2.0 (Tabor and Richardson 1989a); the use of pyrophosphatase to prevent pyrophosphorylytic removal of ddNTP residues from the 3' terminus of terminated chains that can occur during prolonged sequencing reactions (Tabor and Richardson 1990); and finally, the identification of the residue critical for efficient use of ddNTPs as substrates (Tabor and Richardson 1995). This entire body of wonderful work is an example of the power of enzymology in intelligent hands. The most detailed descriptions of the work are published in a series of patents issued to Tabor and Richardson in the late 1980s and early 1990s (U.S. Patents 4,946,786; 4,795,699; and 4,910,130).

---

**CONVENTIONAL CHAIN-TERMINATION SEQUENCING OF PCR-AMPLIFIED DNA**

---

Methods to sequence the amplified double-stranded products of PCRs are attractive in theory but unreliable in practice. The methods appeal to the investigator who wants to sequence either or both strands of template DNA, and they offer the ability to generate templates for sequencing without the labor of cloning into bacterial or bacteriophage vectors. However, direct sequencing of double-stranded PCR products remains a technical challenge, as the diversity and number of papers on the topic make manifest.

The keys to success are rigorous optimization of the amplification step to suppress mispriming and meticulous purification to rid the PCR product of residual primers, thermostable DNA polymerase, unused dNTPs, and nonspecific reproductions of the original template. Purification generally involves chromatography through spun columns or commercial resins, followed by elution of the desired fragment from an agarose or polyacrylamide gel. With this amount of work, it is perhaps not surprising that many investigators turn to cycle sequencing (please see Protocol 6) or opt for the well-trodden traditional route of cloning PCR products into plasmids or bacteriophage M13 vectors.

Because of differences in the size, yield, and specificity of the amplification product, none of the available purification methods can be used to purify each and every PCR product. However, with some effort, it is almost always possible to devise a successful purification scheme for the products of a specific PCR. The following guide lists the main options that are available. Detailed protocols for many of these options are presented in other sections of this manual.

- **Removal of Residual Primers and Unused dNTPs**

*Spun column chromatography* through Sepharose CL-6B or Sephacryl S-400 (please see Appendix 8). Sepharose CL-6B equilibrated in TE (pH 7.6) excludes double-stranded DNAs >190 bp in size. Sephacryl S-400 excludes double-stranded DNAs >260 bp in size. Both matrices will retard the passage of dNTPs, primers, and primer-dimers.

*Centrifugal ultrafiltration* through Centricon-100 or Microcon-100 units (Krowczynska and Henderson 1992; Leonard et al. 1998; please see Chapter 8, Protocol 3).

- **Elimination of Residual Thermostable DNA Polymerase**

*Taq* polymerase, and presumably other thermostable DNA polymerases, survive extraction with phenol:chloroform, ethanol precipitation, and other regimens commonly used to purify the products of PCR (Crowe et al. 1991; Barnes 1992). The continuing presence of the DNA polymerase together with residual dNTPs may befoul chain-termination sequencing reactions catalyzed by other thermostable enzymes such as Thermo Sequenase and AmpliTaq. A method to remove residual thermostable DNA polymerase is described in Chapter 8, Protocol 3.

- **Elimination of Nonspecific Amplification Products**

Target DNA can be separated from amplified DNAs that differ in size by electrophoresis through low melting/gelling temperature agarose (please see Chapter 5). The desired PCR product can then be recovered from the gel by one of the methods described in Chapter 5.

When the PCR yields a heterogeneous set of products of similar size, it may be necessary to carry out a second round of PCR using nested primers, or to use a restriction enzyme to cleave unwanted products, or to use a more sophisticated electrophoretic system, for example, denaturing gradient gel electrophoresis (Fischer and Lerman 1983; for review, please see Myers et al. 1998).

Finally, some of the difficulties encountered in sequencing amplified DNAs are not unique. Like any other double-stranded DNA, amplified DNAs will inevitably reassociate after denaturation, whereupon the sequencing primer may be unable to anneal or the DNA polymerase may be unable to proceed along the full length of the template (Gyllensten and Erlich 1988). These problems can be minimized by rapidly transferring the amplified DNA, after denaturation by heat (Kusukawa et al. 1990) or alkali (Wrischnik et al. 1987), to conditions that do not favor reassociation of DNA strands, namely, low temperature and low ionic strength. The quicker the denatured DNA is used in the annealing and extension/termination reactions, the better (please see Protocol 2).

## PREPARATION OF STOCK SOLUTIONS OF dNTPS AND ddNTPS FOR DNA SEQUENCING

At each step during the primer-extension phase of dideoxy-sequencing reactions, there are two possible outcomes: chain elongation and chain termination. Chain elongation occurs when the DNA polymerase catalyzes the incorporation of a conventional dNTP into the growing chain of DNA; chain termination results from the incorporation of a ddNTP molecule. Therefore, the balance between chain elongation and chain termination is determined by the ratio of dNTP to ddNTP in each sequencing reaction.

Each of the DNA polymerases used for dideoxy-mediated sequencing has a different affinity for conventional dNTPs and chain-terminating ddNTPs. Thus, reaction mixtures that give good results with one enzyme are unlikely to work well with another. It is almost always necessary to "fine-tune" the concentration of ddNTPs to obtain optimal results for the particular task at hand. When sequencing for the first time with a particular DNA polymerase, we recommend purchasing a kit from a commercial manufacturer that contains the relevant DNA polymerase, pretested chain extension/termination mixtures, single-stranded templates, and oligonucleotide primers (for suppliers, please see Appendix 13). As components of the kit are used up, they may be replaced with homemade materials, which are less expensive and can be made in a wide range of concentrations. Each new batch of reagents should be checked by setting up a series of test reactions with a standard template and primer and a range of concentrations of dNTPs and ddNTPs. Initially, it is best to use fixed concentrations of dNTPs and variable concentrations of ddNTPs. Often, several series of test reactions are necessary to define optimal conditions. The following stock solutions are used to prepare the working solutions of dNTPs and ddNTPs for sequencing reactions using either the Klenow fragment of *E. coli* DNA polymerase I, Sequenase, or thermostable (e.g., *Taq*) DNA polymerases.

Stock solutions usually contain a single dNTP or ddNTP at a concentration of 10 mM or 20 mM, according to the needs of the investigator. These stocks are stored at  $-20^{\circ}\text{C}$  in small aliquots, and they may be diluted to generate, for example, solutions that contain all four dNTPs at a concentration of 5 mM.

A microbalance is used to weigh out the required amounts of dNTP or ddNTP into sterile microfuge tubes. Either use a disposable spatula or clean the spatula well with ethanol between each weighing when making up solutions of different dNTPs or ddNTPs. The table shows the amount of solid, anhydrous deoxynucleotide or dideoxynucleotide required to make 1 ml of a 20 mM stock solution.

Deoxynucleotide	FW	Amount (in mg) required to make 1 ml of a 20 mM solution
dATP	491.2	9.82
dCTP	467.2	9.34
dTTP	482.2	9.64
dGTP	507.2	10.14
dITP	508.2	10.16
ddATP	475.2	9.50
ddCTP	451.2	9.02
ddTTP	466.2	9.32
ddGTP	491.2	9.82
7-deaza-dGTP	506.2	10.12
7-deaza-dITP	507.2	10.14

Dissolve the deoxynucleotides or dideoxynucleotides in a small volume of  $\text{H}_2\text{O}$ , and then use pH paper and an automatic pipeting device to adjust the pH to  $\sim 8.0$  by adding small amounts of 2 N NaOH until the pH reaches 8.0.

Alternatively, the stock solutions may be generated from monosodium salts of the deoxynucleotide triphosphates or dideoxynucleotide triphosphates by dissolving an appropriate amount of the solid in 1.0 ml of  $\text{H}_2\text{O}$ . Mix the contents of the tube well and store the stock solution in small aliquots at  $-20^{\circ}\text{C}$ .

pH-adjusted solutions of dNTPs and ddNTPs are available from many commercial manufacturers.

The base analogs dITP and 7-deaza-dGTP are substituted for dGTP in chain extension/termination reactions to reduce secondary structure problems. These analogs form base pairs with dC that contain only two hydrogen bonds instead of the three normally formed by G-C base pairs. Therefore, the analog-C base pairs are more readily denatured before separation by gel electrophoresis and have less of a tendency to form secondary structure during the actual electrophoretic run. However, because the use of dITP and 7-deaza-dGTP accentuates pauses in the chain extension/termination reaction, sequencing reactions containing a base analog should always be run in parallel with reactions containing dGTP.

---

**GLYCEROL IN DNA SEQUENCING REACTIONS**

---

Most DNA polymerases used in DNA sequencing are supplied by commercial manufacturers in buffers containing 50% glycerol, which allows the enzyme preparations to be stored at  $-20^{\circ}\text{C}$  without freezing. Because glycerol and other vicinal diols also stabilize protein-protein interactions (including interdomain interactions in single-subunit proteins) and therefore protect enzymes against denaturation, DNA-sequencing reactions may be carried out at higher temperatures and for longer times, without significant loss of enzyme activity. However, high concentrations of glycerol ( $>5\%$ ) in samples applied to DNA-sequencing gels generate bends in the sequencing tracks and blurring of bands  $>300$  bases in size (Tabor and Richardson 1987a). These effects are almost certainly due to the reaction of glycerol with boric acid in the gel-running buffer to form negatively charged esters that migrate anodically through the gel during electrophoresis. This problem can be solved in several ways (Pisa-Williamson and Fuller 1992):

- **Dilute the DNA polymerase** into ice-cold buffers that do not contain glycerol. As a general rule, use enzymes immediately after dilution and discard any unused remnants.
- **Remove the glycerol** from the manufacturer's buffer by centrifugation through a spun column of P2 gel filtration medium (Bio-Rad), equilibrated in the manufacturer's recommended storage buffer without glycerol (Trevino et al. 1993).
- **Precipitate the products** of the sequencing reaction with ethanol before loading onto the gel.
- **Replace boric acid in the gel** and in the electrophoresis buffer with taurine, a weak aminosulfonic acid with a  $\text{p}K_{\text{a}}$  similar to that of boric acid (Pisa-Williamson and Fuller 1992). Taurine/EDTA/Tris electrophoresis buffer consists of 89 mM Tris, 29 mM taurine, and 0.1 mM EDTA. A 20x solution therefore contains 216 g of Tris, 72 g of taurine, and 2 g of EDTA per liter.



---

**COMPRESSIONS IN DNA SEQUENCING GELS**

---

Compressions occur when two or more single-stranded DNAs of different lengths migrate through a polyacrylamide gel with the same mobility. This results in coincidence of bands in different lanes and anomalous spacing of bands above and below the region of compression. Because of the difficulty in calling the correct sequence from these bands, compression artifacts often appear as regions of different sequence on the two DNA strands. Compressions arise when single-stranded DNAs are not fully denatured during electrophoresis. DNAs containing secondary structures are less subject to viscous drag than are single-stranded DNAs of equivalent length and sequence and so migrate more rapidly through the gel.

Compressions, which occur in both the Maxam-Gilbert and Sanger sequencing methods, mostly affect reading of the G and C tracks, although the A and T tracks are by no means immune. Compressions arise when sequences displaying dyad symmetry are located at or near the 3' termini of single-stranded DNAs, particularly those DNAs ending in regions with three or more G/C base pairs in succession. Such sequences may form intrastrand secondary structures (hairpins and cruciforms) that are not fully denatured during electrophoresis through standard sequencing gels (50°C and 7 M urea).

Several methods can be used to resolve compressions in sequencing gels. The easiest, which cures about half of the problems, is simply to use a different DNA polymerase to catalyze the chain-terminating sequencing reaction. GC-rich regions that bar the passage of one type of DNA polymerase will frequently yield to another. Many compressions can be bypassed by sequencing the other strand of DNA. In some cases, the compression turns out to be specific to one strand; in others, the compression occurs in both strands but is offset by a few nucleotides. Either way, a composite sequence can be constructed through the region of compression. If all else fails, try adding cosolvents such as dimethylsulfoxide or formamide to a final concentration of 10% in the chain-terminating sequencing reaction. Glycerol can also be used, again at a concentration of 10%. However, it is then necessary to use a glycerol-tolerant electrophoresis buffer to prevent artifacts caused by the interaction of glycerol with borate ions in conventional TBE buffer (please see the information panel on **GLYCEROL IN DNA SEQUENCING REACTIONS**).

Another way to alleviate compressions is to reduce the opportunity for base pairing during electrophoresis. None of these methods is foolproof and all of them have drawbacks. Furthermore, the choice between them is not straightforward since few head-to-head comparisons have been published of their ability to relieve compressions of various severities. In the most thorough study to date, F. Blattner (pers. comm.) has analyzed the ability of nucleotide analogs and gel additives to resolve a battery of bacteriophage M13 clones that produce sequencing compressions of various types. The gel additives were generally ineffective when standard dNTPs were used in the reaction mixtures. However, the combination of nucleotide analogs and gel additives was able to resolve even the most stubborn compressions. One nucleotide analog — dITP — was effective against all compressions, as was a combination of 7-deaza-dGTP and 7-deaza-dATP. 7-deaza-dGTP alone resolved ~50% of the compressions. Please note that dITP should not be used in sequencing reactions catalyzed by *Taq* DNA polymerase and its numerous derivatives (please see Table 12-25).

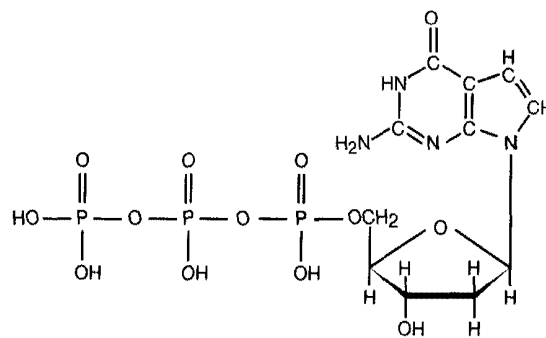
TABLE 12-25 Methods to Resolve Compressions

METHOD	COMMENTS
<p><b>dITP</b> dITP and ddITP are substituted for dGTP and ddGTP in the chain extension/termination reactions. Usually, the dITP:dGTP ratio in the reaction mixtures is 4 and the concentration of ddITP:ddGTP in the G termination mixture is 8.</p>	<p>Inosine forms base pairs containing only two hydrogen bonds instead of the three normally formed by G-C base pairs. The consequent weakening of Watson-Crick base pairing results in a substantial reduction in the formation of intramolecular "hairpin" structures. Sequenase is the choice polymerase for reactions containing inosine nucleotides. Avoid <i>Taq</i> DNA polymerase and its various derivatives (please see Table 12-9) when using dITP as a substrate. Because the use of dITP accentuates pauses in the chain-termination reaction, always run sequencing reactions containing the base analog in parallel with standard reactions containing dGTP. Substitution of dITP for dGTP causes nucleic acids to migrate slightly faster through polyacrylamide gels. The USB ThermoSequenase-radiolabeled terminator sequencing kit recommends dITP be used for all new sequences and any that give rise to compressions. With dITP, USB suggests using an "extension" temperature of 60°C with a duration of at least 4 minutes. The quality of sequence is never as good when base analogs are used in place of conventional dNTPs. It is therefore helpful to load each set of reactions into eight adjacent lanes of a polyacrylamide gel in the order IATCITAC. This ensures that each of the four sequencing reactions is adjacent to the other three and allows the order of closely spaced bands to be determined more easily. References: Mills and Kramer (1979); Bankier and Barrell (1983); Barr et al. (1986); Tabor and Richardson (1987a); Innis et al. (1988).</p>
<p><b>7-deaza dGTP</b> 7-deaza-2'-deoxy-guanosine-5'-triphosphate is substituted for dGTP in the chain extension/termination reactions. Usually, equimolar amounts of 7-deaza-GTP and dGTP are used in the reaction mixtures.</p>	<p>The methine group at the N-7 position of 7-deaza-dGTP is thought to preclude formation of Hoogsteen bonds and thereby to suppress formation of secondary structures (Barr et al. 1986). However, this mechanism has since been called into question (Jensen et al. 1991). It now seems likely that 7-deaza analogs cure compressions by reducing vertical stacking interactions between purines (Seela et al. 1982, 1989; Jensen et al. 1991). 7-deaza-dGTP is effective at resolving many compressions preceded by a G residue. Compressions preceded by A are best resolved by 7-deaza-dATP or by a combination of both analogs (Jensen et al. 1991). Because the use of 7-deaza-dGTP accentuates pauses in the chain-termination reaction, sequencing reactions containing the base analog should always be run in parallel with standard reactions containing dGTP. Substitution of 7-deaza-dGTP for dGTP causes nucleic acids to migrate slightly faster through polyacrylamide gels. The quality of sequence is never as good when base analogs are used in place of conventional dNTPs. It is often helpful to load each set of reactions into eight adjacent lanes of a polyacrylamide gel in the order aZATCaZTAC. This ensures that each of the four sequencing reactions is adjacent to the other three and allows the order of closely spaced bands to be determined more easily. Reference: Mizusawa et al. (1986).</p>
<p><b>7-deaza-dATP</b> 7-deaza-2'-deoxyadenosine-5'-triphosphate is used to replace dATP in the chain extension/termination reactions.</p>	<p>The methine group at the N-7 position of 7-deaza-dATP may preclude formation of Hoogsteen bonds and thereby suppress formation of secondary structures. However, 7-deaza-dATP may also cure compressions by reducing vertical stacking interactions between purines (Jensen et al. 1991). 7-deaza-dATP helps to resolve compressions preceded by an A residue. This type of compression usually cannot be resolved by 7-deaza-dGTP alone. Reference: Jensen et al. (1991).</p>
<p><b>Formamide</b> Including 20–50% formamide in the sequencing gel resolves some compressions.</p>	<p>Inclusion of formamide in sequencing gels run at 50°C has been reported to resolve compressions. However, gels containing formamide run slower and cooler than conventional polyacrylamide gels run at the same voltage. It is usually necessary to increase the voltage by ~10% to maintain temperature. Because gels containing formamide are extremely sticky and difficult to dry, it is best wherever possible to freeze the wet gel for exposure to X-ray film. References: Martin (1987); Rocheleau et al. (1992).</p>
<p><b>Voltage</b></p>	<p>Increasing the voltage raises the temperature of the gel which, in turn, destabilizes secondary structures. Unfortunately, it also generates steep temperature gradients across the glass plates, which then crack.</p>
<p><b>Chemical modification of cytosine residues</b></p>	<p>Deamination of cytosine with bisulfite or bisulfite plus methoxyamine converts the base to uracil and reduces the potential for G-C base pairing. Reference: Ambartsumyan and Mazo (1980).</p>

## 7-DEAZA-dGTP

7-deaza-dGTP (also called 7-aza-dGTP) is a base analog of dGTP that destabilizes intramolecular interactions in single-stranded nucleic acids (see Figure 12-13). The substitution of 7-deaza-dGTP for dGTP most likely reduces vertical stacking interactions between adjacent purine residues because of alterations of the  $\pi$  electron system and a decrease in the dipole moment (Seela et al. 1982, 1989; Jensen et al. 1991). 7-deaza-dGTP is used under the following circumstances in molecular cloning:

- **To relieve compressions** in chain-termination DNA sequencing (Barr et al. 1986; Mizusawa et al. 1986). 7-deaza-dGTP is used as a substrate in chain extension/termination reactions that contain either no dGTP or equimolar amounts of dGTP and the base analog. Under these conditions, many compressions that are preceded by G are resolved. Compressions preceded by A are more efficiently relieved by 7-deaza-dATP, whereas compound compressions may require a combination of 7-deaza-dGTP and 7-deaza-dATP (Jensen et al. 1991; please also see the information panel on **COMPRESSIONS IN DNA SEQUENCING GELS**).
- **Because 7-deaza-dGTP (aZ) accentuates pauses** in the chain-termination reaction, sequencing reactions containing the base analog should be run in parallel with standard reactions containing dGTP. In addition, because the quality of sequence is never as good when base analogs are used in place of conventional dNTPs, each set of reactions should be loaded into eight adjacent lanes of a polyacrylamide gel in the order aZATCaZTAC. This ensures that each of the four sequencing reactions is adjacent to the other three and allows the order of closely spaced bands to be determined more easily. The substitution of 7-deaza-dGTP for dGTP causes nucleic acids to migrate slightly faster through polyacrylamide gels.
- **To facilitate PCR amplification** of DNA templates containing G+C-rich regions or stable secondary structures (McConlogue et al. 1988). However, there is a price to pay for this increased efficiency. When 7-deaza-dGTP is substituted for dGTP in PCR, the resulting amplified fragment is resistant to cleavage with many restriction enzymes whose recognition sites contain one or more G residues, for example, *EcoRI*, *SmaI*, *SalI*, *PstI*, *BamHI*, *Sau3A*, *AluI*, and *AccI* (Grime et al. 1991).



**FIGURE 12-13** Structure of the Nucleotide Analog 7-deaza-dGTP

---

**DICHLORODIMETHYLSILANE**

---

Dichlorodimethylsilane is one of a large family of organosilicon oxide polymers that display remarkably high chemical stability and an unusual lack of adhesive properties. The best known of these compounds are (1) Silly Putty, whose deformative, elastic, and recoiling properties are sure to be well known to those who grew up in the 1960s, and (2) GAK, a revolting green goo that was a source of delight for 4-year olds in the 1990s.

In molecular cloning, organosilicon oxide polymers are used to prevent loss of material by adsorption onto surfaces. Dichlorodimethylsilane, for example, is the active ingredient in silanizing solutions that are commonly used to prevent thin polyacrylamide gels used for DNA sequencing from sticking to their supporting glass plates. Most commercial silanizing solutions contain 2% dichlorodimethylsilane dissolved in 1,1,1-trichloroethane. This mixture is smeared over the surface of one of the two glass plates and allowed to dry in air. A more even and durable coating can be achieved by standing the plates in a bath of 5% dichlorodimethylsilane dissolved in chloroform or heptane. The glass plates are allowed to dry at room temperature and then rinsed many times with H<sub>2</sub>O before use.

Small items (e.g., microfuge tubes and disposable pipette tips) used in the Maxam-Gilbert method of DNA sequencing are best siliconized by evaporative deposition of a small amount of undiluted dichlorodimethylsilane inside a glass desiccator. Glassware is then baked for 2 hours at 180°C and plasticware is rinsed extensively with H<sub>2</sub>O before use.

## READING AN AUTORADIOGRAPH

Reading DNA sequences from gels is an acquired skill — it is not as easy as it looks. The following list of tips may help to simplify the process and minimize problems.

- As soon as the autoradiograph is developed, label the film with the date, exposure time, and names of the templates. Mark each set of sequencing reactions clearly. Indicate the order of the sequencing reactions loaded in each lane (e.g., CTAG).
- Be sure to distinguish the left and the right sides of the gel. The image of the radioactive ink or chemiluminescent marker should appear next to the sequencing reaction that was loaded on the first track of the gel.
- When searching for correspondence between a new DNA sequence and one that is already known, or for overlap between complementary sequences or sequential gel loads, look for obvious “signatures” such as homopolymeric runs (e.g., consecutive T residues) or alternating purine and pyrimidines (e.g., GTGT-GT). Once found, use these signatures to locate the sequence of interest quickly.
- Read and record an unknown sequence at least twice, preferably by different people. Alternatively, enter the sequence twice if a computer-assisted gel reader is used. Compare the two readings and resolve the discrepancies by careful reinspection and, if necessary, by further sequencing. When reading DNA sequences generated on a machine, compare separate sequencing reactions on a computer and resolve discrepancies by reinspection of the original color-coded printout. Pay careful attention to peak heights and overlaps, and ask the person in charge of the machine to help resolve discrepancies.
- If the gel has been loaded in the order TCGA or CTAG, read the sequence of the complementary strand (3′ to 5′) by flipping the autoradiograph over and reading the gel from the bottom. (The tracks on the flipped autoradiograph are read from left to right and their order is assumed to be TCGA or CTAG.)
- The following guidelines are useful when reading gels:

Pay special attention to gaps or uneven spacing in the autoradiograms. These are usually signatures of compression or DNA polymerase pausing problems. In sequences generated by the Maxam-Gilbert procedure, watch for gaps associated with the sequence 5′-CA/TGG-3′. Hydrazine will not modify 5-methylated cytosine residues in the sequence CCA/TGG, the recognition sequence for a restriction/modification system in *E. coli*, thus leading to a gap between the first C residue and the A/T residue (see Comment below).

In enzymatic reactions, single C bands are generally weaker than single bands of the three other nucleotides.

The first A in a homopolymeric run of As is generally stronger than the rest.

The first C in a homopolymeric run of Cs is usually much weaker than the second.

G bands are weak when they are preceded by a T.

These latter observations are variably true depending on the DNA polymerase used in the sequencing reactions.

- It is initially somewhat more difficult to determine the sequence of DNA from a chemical-degradation sequencing gel than from a Sanger dideoxy-mediated chain-termination sequencing gel. Because the chemical cleavage reactions are not all absolutely base-specific, it is necessary to deduce the position of T residues by subtracting bands appearing in the C track from those in the C+T track. Similarly, the position of A residues is deduced by subtracting bands in the G track from those in the A+G track. The presence of an A residue is confirmed if a strong band is present in the A>C track. Beware of the sequence 5′-CA/TGG-3′, as this sequence may indicate the presence of a methylated CCA/TGG sequence in the DNA. This is an *EcoRII* restriction endonuclease site and the second C is methylated at the 5-position in almost all standard laboratory *E. coli* strains (with the exception of those carrying a *dcm* allele). The 5-methylated C is not susceptible to hydrazine modification and therefore appears as a blank (i.e., C\_A/TGG) sequence in the ladder.
- Because Maxam-Gilbert sequencing is carried out with <sup>32</sup>P-labeled DNA, the bands are fuzzier and broader than those obtained from DNA sequenced by the Sanger method in which [<sup>35</sup>S]dNTPs or [<sup>33</sup>P]dNTPs have been used. This lack of resolution limits the amount of reliable sequence that can be obtained from a single gel to ~200–250 nucleotides.

---

**ELECTRICAL MOBILITY OF DNA**

---

A lively debate has been ongoing for several years about the mechanism by which DNA molecules move through gels. One theory treats DNA as a chain passing through a tube. At any one point, the shape and dimensions of the tube are defined by the neighboring fibers of the gel. In the absence of an electric current, long-chain polymers diffuse through these snake-like tubes by a form of random motion known as reptation (de Gennes 1971). Under the influence of a constant electric field, the diffusion process becomes biased so that the flexible DNA molecules tend to move through the tube toward the anode (Lerman and Frisch 1982; Bean and Hervet 1983; Lumpkin et al. 1985; Slater and Noolandi 1989). Reptation theory assumes that the DNA is always encased in a tube and that the overall length of the tube varies little when the electric field strength remains low. Higher electric fields cause straightening of the DNA molecules with an effective increase in the length of the tube. DNA molecules can then take a more direct path toward the anode and hence travel faster through the gel (Lumpkin et al. 1985).

In recent years, reptation theory has come under increasingly severe scrutiny with the understanding of the physical nature of gels and the better documentation of the behavior of DNA in different types of electrical fields. In several cases, experimental data conflict with predictions made from reptation theory. For example, reptation theory anticipates that DNAs will show the same dependence of mobility on chain length in both constant- and variable-field gel electrophoresis. However, this prediction is clearly at odds with the observed separation of large fragments of DNA by pulsed-field gel electrophoresis. Second, tube models predict that the mobility of shorter segments of DNA should depend on electric field strength raised to an exponent greater than one. In fact, however, DNA mobility through a variety of gels is directly proportional to the electrical field strength over a wide range of DNA sizes (Johnson and Grossman 1977; McDonnell et al. 1977; Calladine et al. 1991). Finally, reptation theory fails to account adequately for the observation that a segment of curved DNA or a curved protein-DNA complex reduces mobility when it is located in the middle, but not the ends, of a long DNA fragment (Wu and Crothers 1984).

A number of alternative theories of DNA mobility have been proposed that deal comfortably with these and other issues by suggesting that the microstructure of the gel presents an entropic barrier to DNA movement (Smisek and Hoagland 1990; Zimm and Lumpkin 1993; Völkel and Noolandi 1995; for review, please see Yager et al. 1997). The mobility of the DNA therefore becomes a statistical variable that depends chiefly on the size of the DNA relative to the spacing and strength of barriers. Whenever a DNA molecule encounters a barrier, it piles up against it, eventually applying sufficient force to dislodge the obstacle from the direct pathway to the anode. The model therefore accounts for the extra band broadening that occurs during diffusion or electrophoresis and predicts that the electrophoretic mobility of DNA should scale inversely with the third power of DNA length. This dependence, which has been confirmed under certain electrophoretic conditions (Calladine et al. 1991), is much stronger than that predicted by reptation models.

## REFERENCES

- Alderton R.P., Eccleston L.M., Howe R.P., Read C.A., Reeve M.A., and Beck S. 1992. Magnetic bead purification of M13 DNA sequencing templates. *Anal. Biochem.* **201**: 166–169.
- Ambartsumyan N.S. and Mazo A.M. 1980. Elimination of the secondary structure effect in gel sequencing of nucleic acids. *FEBS Lett.* **114**: 265–268.
- Ambrose B.J. and Pless R.C. 1987. DNA sequencing: Chemical methods. *Methods Enzymol.* **152**: 522–538.
- Anderson S. 1981. Shotgun DNA sequencing using cloned DNase I-generated fragments. *Nucleic Acids Res.* **9**: 3015–3027.
- Anson W. and Labeit S. 1984. Field gradients improve resolution on DNA sequencing gels. *J. Biochem. Biophys. Methods* **10**: 237–243.
- Anson W., Sproat B.S., Stegemann J., Schwager C., and Zenke M. 1987. Automated DNA sequencing: Ultra-sensitive detection of fluorescent bands during electrophoresis. *Nucleic Acids Res.* **15**: 4593–4602.
- Baer R., Bankier A.T., Biggin M.D., Deininger P.L., Farrell P.J., Gibson T.J., Hatfull G., Hudson G.S., Satchwell S.C., Seguin C., et al. 1984. DNA sequence and expression of the B95-8 Epstein-Barr virus genome. *Nature* **310**: 207–211.
- Bankier A.T. and Barrell B.G. 1983. Shotgun DNA sequencing. In *Techniques in life sciences: Techniques in nucleic acid biochemistry* (ed. R.A. Flavell), vol. B5, pp. 1–34. Elsevier, Amsterdam, The Netherlands.
- Bankier A.T., Weston K.M., and Barrell B.G. 1987. Random cloning and sequencing by the M13/dideoxynucleotide chain termination method. *Methods Enzymol.* **155**: 51–93.
- Barnes W.M. 1992. The fidelity of Taq polymerase catalyzing PCR is improved by an N-terminal deletion. *Gene* **112**: 29–35.
- Barr P.J., Thayer R.M., Laybourn P., Najarian R.C., Seela F., and Tolan D.R. 1986. 7-deaza-2'-deoxyguanosine-5'-triphosphate: Enhanced resolution in M13 dideoxy sequencing. *BioTechniques* **4**: 428–432.
- Bean C.P. and Hervet H. 1983. Motion of DNA through gels. *Biophys. J.* **41**: A289.
- Bebenek K. and Kunkel T.A. 1989. The use of native T7 DNA polymerase for site-directed mutagenesis. *Nucleic Acids Res.* **17**: 5408.
- Bedford E., Tabor S., and Richardson C.C. 1997. The thioredoxin binding domain of bacteriophage T7 DNA polymerase confers processivity on *Escherichia coli* DNA polymerase I. *Proc. Natl. Acad. Sci.* **94**: 479–484.
- Biggin M.D., Gibson T.J., and Hong G.F. 1983. Buffer gradient gels and 35S label as an aid to rapid DNA sequence determination. *Proc. Natl. Acad. Sci.* **80**: 3963–3965.
- Birnboim H.C. and Doly J. 1979. A rapid alkaline extraction procedure for screening recombinant plasmid DNA. *Nucleic Acids Res.* **7**: 1513–1523.
- Birren B., Green E.D., Klapholz S., Myers R.M., and Roskams J. 1997. *Genome analysis: A laboratory manual*, vol. 1. *Analyzing DNA* (ed. E.D. Green et al.). Cold Spring Harbor Laboratory Press, Cold Spring Harbor, New York.
- Bodenteich A., Chisoe S., Wang Y.-E., and Roe B.A. 1994. Shotgun cloning as the strategy of choice to generate templates for high-throughput dideoxynucleotide sequencing. In *Automated DNA sequencing and analysis* (ed. M.D. Adams et al.), pp. 42–50. Academic Press, San Diego, California.
- Boguslavsky J., ed. 2000. DNA sequencers reach production scale. *Drug Discovery & Development* **Jan./Feb.**: 36–38. (<http://www.ddmag.com/feats/index/htm>)
- Bonfield J.K., Smith K.F., and Staden R. 1995. A new DNA sequence assembly program. *Nucleic Acids Res.* **23**: 4992–4999.
- Brow M.A.D. 1990. Sequencing with Taq DNA polymerase. In *PCR protocols: A guide to methods and applications* (ed. M.A. Innis et al.), pp. 189–196. Academic Press, New York.
- Brownlee G.G. and Sanger F. 1967. Nucleotide sequences from the low molecular weight ribosomal RNA of *Escherichia coli*. *J. Mol. Biol.* **23**: 337–353.
- Brutlag D., Atkinson M.R., Setlow P., and Kornberg A. 1969. An active fragment of DNA polymerase produced by proteolytic cleavage. *Biochem. Biophys. Res. Commun.* **37**: 982–989.
- Buck G.A., Fox J.W., Gunthorpe M., Hager K.M., Naevae C.W., Pon R.T., Adams P.S., and Rush J. 1999. Design strategies and performance of custom DNA sequencing primers. *BioTechniques* **27**: 528–536.
- Calladine C.R., Collis C.M., Drew H.R., and Mott M.R. 1991. A study of electrophoretic mobility of DNA in agarose and polyacrylamide gels. *J. Mol. Biol.* **221**: 981–1005.
- Campbell V.W. and Jackson D.A. 1980. The effect of divalent cations on the mode of action of DNase I. The initial reaction products produced from covalently closed circular DNA. *J. Biol. Chem.* **255**: 3726–3735.
- Cantor C.R. and Schimmel P.R. 1980. *Biophysical chemistry*. Part III. *The behavior of biological macromolecules*. W.H. Freeman, New York.
- Carey M. and Smale S.T. 2000. *Transcriptional regulation in eukaryotes: Concepts, strategies, and techniques*. Cold Spring Harbor Laboratory Press, Cold Spring Harbor, New York.
- Carothers A.M., Urlaub G., Mucha J., Grunberger D., and Chasin L.A. 1989. Point mutation analysis in a mammalian gene: Rapid preparation of total RNA, PCR amplification of cDNA, and Taq sequencing by a novel method. *BioTechniques* **7**: 494–499.
- Carroll S.S. and Benkovic S.J. 1990. Mechanistic aspects of DNA polymerases: *Escherichia coli* DNA polymerase I (Klenow fragment) as a paradigm. *Chem. Rev.* **90**: 1291–1307.
- Chrambach A. and Rodbard D. 1972. Polymerization of polyacrylamide gels: Efficiency and reproducibility as a function of catalyst concentrations. *Sep. Sci.* **7**: 663–703.
- Chen C., Su Y., Baybayan P., Siruno A., Nagaraja R., Mezzarella R., Schlessinger D., and Chen E.Y. 1996. Ordered shotgun sequencing of a 135 kb Xq25 YAC containing ANT-2 and four possible genes, including three confirmed by EST matches. *Nucleic Acids Res.* **24**: 4034–4041.
- Chen E.Y. 1994. The efficiency of automated DNA sequencing. In *Automated DNA sequencing and analysis* (ed. M.D. Adams et al.), pp. 3–10. Academic Press, London, United Kingdom.
- Chen E.Y. and Seeburg P.H. 1985. Supercoil sequencing: A fast and simple method for sequencing plasmid DNA. *DNA* **4**: 165–170.
- Chen E.Y., Kuang W.-J., and Lee A.L. 1991. Overview of manual and automated DNA sequencing by the dideoxy chain termination method. *Methods* **3**: 3–19.
- Chen E.Y., Zollo M., Mazzarella R., Ciccodicola A., Chen C., Zuo L., Heiner C., Burrough F., Ripetto M., Schlessinger D., and D'Urso M. 1996. Long-range sequence analysis in Xq28: Thirteen known and six candidate genes in 219.4 kb of high GC DNA between the human RCP/GCP and G6PD loci. *Hum. Mol. Genet.* **5**: 659–668.
- Chisoe S.L., Marra M.A., Hillier L., Brinkman R., Wilson R.K.,

- and Waterston R.H. 1997. Representation of cloned genomic sequences in two sequence vectors: Correlation of DNA sequence and subclone distribution. *Nucleic Acids Res.* **25**: 2960–2966.
- Church G.M. and Gilbert W. 1984. Genomic sequencing. *Proc. Natl. Acad. Sci.* **81**: 1991–1995.
- Civitello A.B., Richards S., and Gibbs R.A. 1992. A simple protocol for the automation of DNA cycle sequencing reactions and polymerase chain reactions. *DNA Seq.* **3**: 17–23.
- Cobianchi F. and Wilson S.H. 1987. Enzymes for modifying and labeling DNA and RNA. *Methods Enzymol.* **152**: 94–110.
- Craik C.S., Largman C., Fletcher T., Rocznik S., Barr P.J., Fletterick R., and Rutter W.J. 1985. Redesigning trypsin: Alteration of substrate specificity. *Science* **228**: 291–297.
- Craxton M. 1991. Linear amplification sequencing, a powerful method for sequencing DNA. *Methods* **3**: 20–26.
- Crowe J.S., Cooper H.J., Smith M.A., Sims M.J., Parker D., and Gewert D. 1991. Improved cloning efficiency of polymerase chain reaction (PCR) products after proteinase K digestion. *Nucleic Acids Res.* **19**: 184.
- Davidson P.F. 1959. The effect of hydrodynamic shear on the deoxyribonucleic acid from T2 and T4 bacteriophages. *Proc. Natl. Acad. Sci.* **45**: 1560–1568.
- . 1960. Biophysics: Sedimentation of deoxyribonucleic acid isolated under low hydrodynamic shear. *Nature* **185**: 918–920.
- Dear S. and Staden R. 1991. A sequence assembly and editing program for efficient management of large projects. *Nucleic Acids Res.* **19**: 3907–3911.
- Dear S., Durbin R., Hillier L., Marth G., Thierry-Mieg J., and Mott R. 1998. Sequence assembly with CAFTOOLS. *Genome Res.* **8**: 260–267.
- de Gennes P.G. 1971. Reptation of a polymer chain in the presence of fixed obstacles. *J. Chem. Phys.* **55**: 572–578.
- Deininger P.L. 1983. Approaches to rapid DNA sequence analysis. *Anal. Biochem.* **135**: 247–263.
- Derbyshire V., Astatke M., and Joyce C.M. 1993. Re-engineering the polymerase domain of Klenow fragment and evaluation of overproduction and purification strategies. *Nucleic Acids Res.* **21**: 5439–5448.
- Derbyshire V., Freemont P.S., Sanderson M.R., Beese L., Friedman J.M., Joyce C.M., and Steitz T.A. 1988. Genetic and crystallographic studies of the 3',5'-exonucleolytic site of DNA polymerase I. *Science* **240**: 199–201.
- Doublé S., Tabor S., Long A.M., Richardson C.C., and Ellenberger T. 1998. Crystal structure of a bacteriophage T7 DNA replication complex at 2.2 Å resolution (see comments). *Nature* **391**: 251–258.
- Dovichi N. 1999. Development of DNA sequencer. *Science* **285**: 1016.
- Du Z., Hood L., and Wilson R.K. 1993. Automated fluorescent DNA sequencing of polymerase chain reaction products. *Methods Enzymol.* **218**: 104–121.
- Edwards A., Voss H., Rice P., Civitello A., Stegemann J., Schwager C., Zimmermann J., Erfle H., Caskey C.T., and Ansorge W. 1990. Automated DNA sequencing of the human HPRT locus. *Genomics* **6**: 593–608.
- Eperon I.C. 1986. Rapid preparation of bacteriophage DNA for sequence analysis in sets of 96 clones, using filtration. *Anal. Biochem.* **156**: 406–412.
- Feinberg A.P. and Vogelstein B. 1983. A technique for radiolabeling DNA restriction endonuclease fragments to high specific activity. *Anal. Biochem.* **132**: 6–13.
- . 1984. A technique for radiolabeling DNA restriction endonuclease fragments to high specific activity. Addendum. *Anal. Biochem.* **137**: 266–267.
- Fischer S.G. and Lerman L.S. 1983. DNA fragments differing by single base-pair substitutions are separated in denaturing gradient gels: Correspondence with melting theory. *Proc. Natl. Acad. Sci.* **80**: 1579–1583.
- Fitzgerald M.C., Skowron P., Van Etten J.L., Smith L.M., and Mead D.A. 1992. Rapid shotgun cloning utilizing the two base recognition endonuclease *Cvi*I. *Nucleic Acids Res.* **20**: 3753–3762.
- Freemont P.S., Friedman J.M., Beese L.S., Sanderson M.R., and Steitz T.A. 1988. Cocrystal structure of an editing complex of Klenow fragment with DNA. *Proc. Natl. Acad. Sci.* **85**: 8924–8928.
- Fry G., Lachenmeier E., Mayrand E., Giusti B., Fisher J., Johnston-Dow L., Cathcart R., Finne E., and Kilaas L. 1992. A new approach to template purification for sequencing applications using paramagnetic particles. *BioTechniques* **13**: 124–131.
- Fuller C.W. 1992. Modified T7 DNA polymerase for DNA sequencing. *Methods Enzymol.* **216**: 329–354.
- Fuller C.W., McArdle B.F., Griffin A.M., and Griffin H.G. 1996. DNA sequencing using sequenase version 2.0 T7 DNA polymerase. *Methods Mol. Biol.* **58**: 373–387.
- Fulton L.L. and Wilson R.K. 1994. Variations on cycle sequencing. *BioTechniques* **17**: 298–301.
- Geisselsoder J., Witney F., and Yuckenberg P. 1987. Efficient site-directed *in vitro* mutagenesis. *BioTechniques* **5**: 786–791.
- Gilbert W. 1981. DNA sequencing and gene structure (Nobel Lecture, December 8, 1980). *Biosci. Rep.* **1**: 353–375.
- Gilbert W. and Maxam A. 1973. The nucleotide sequence of the *lac* operator. *Proc. Natl. Acad. Sci.* **70**: 3581–3584.
- Gingrich J.C., Boehrer D.M., and Basu S.B. 1996. Partial *Cvi*I digestion as an alternative approach to generate cosmid sublibraries for large-scale sequencing projects. *BioTechniques* **21**: 99–104.
- Gomer R., Datta S., and Firtel R. 1985. Sequencing homopolymer regions. *Focus (Life Technologies)* **7**: 6.
- Green P. 1997. Against a whole-genome shotgun. *Genome Res.* **7**: 410–417.
- Grime S.K., Martin R.L., and Holaway B.L. 1991. Inhibition of restriction enzyme cleavage of DNA modified with 7-deaza-dGTP. *Nucleic Acids Res.* **19**: 2791.
- Gupta A.P., Benkovic P.A., and Benkovic S.J. 1984. The effect of the 3',5' thiophosphoryl linkage on the exonuclease activities of T4 polymerase and the Klenow fragment. *Nucleic Acids Res.* **12**: 5897–5911.
- Gyllenstein U.B. and Allen M. 1993. Sequencing of *in vitro* amplified DNA. *Methods Enzymol.* **218**: 3–16.
- Gyllenstein U.B. and Erlich H.A. 1988. Generation of single-stranded DNA by the polymerase chain reaction and its application to direct sequencing of the HLA-DQA locus. *Proc. Natl. Acad. Sci.* **85**: 7652–7656.
- Halloran N., Du Z., and Wilson R.K. 1992. Sequencing reactions for the applied biosystems 373A automated DNA sequencer. *Methods Mol. Biol.* **23**: 297–315.
- Hanke M. and Wink M. 1994. Direct DNA sequencing of PCR-amplified vector inserts following enzymatic degradation of primer and dNTP's. *BioTechniques* **17**: 858–860.
- Hattori M. and Sakaki Y. 1986. Dideoxy sequencing method using denatured plasmid templates. *Anal. Biochem.* **152**: 232–238.
- Hattori M., Yoshioka K., and Sakaki Y. 1992. High-sensitive fluo-



- rescent DNA sequencing and its application for detection and mass-screening of point mutations. *Electrophoresis* **13**: 560–565.
- Hawkins T.L., O'Connor-Morin T., Roy A., and Santillan C. 1994. DNA purification and isolation using a solid-phase. *Nucleic Acids Res.* **22**: 4543–4544.
- Heiner C.R., Hunkapiller L.K., Chen S.-M., Glass J.I., and Chen E.Y. 1998. Sequencing multimegabase-template DNA with BigDye terminator chemistry. *Genome Res.* **8**: 557–561.
- Hengen P.N. 1996. Methods and reagents. Pouring sequencing gels the old-fashioned way. *Trends Biochem. Sci.* **21**: 273–274.
- . 1997. Shearing DNA for genomic library construction. *Trends Biochem. Sci.* **22**: 273–274.
- Higuchi R.G. and Ochman H. 1989. Production of single-stranded DNA templates by exonuclease digestion following the polymerase chain reaction. *Nucleic Acids Res.* **17**: 5865.
- Holley R.W., Madison J.T., and Zamir A. 1964. A new method for sequence determination of target oligonucleotides. *Biochim. Biophys. Res. Commun.* **17**: 389–394.
- Holley R.W., Apgar J., Everett G.A., Madison J.T., Marguise M., Merrill S.H., Penwick J.R., and Zamir A. 1965. The base sequence of yeast alanine transfer RNA. *Science* **147**: 1462–1465.
- Hooft van Huijsduijnen R.A. 1992. PCR-generated probes for the study of DNA-protein interactions. *BioTechniques* **12**: 830–832.
- Hsiao K. 1991. A fast and simple procedure for sequencing double stranded DNA with sequenase. *Nucleic Acids Res.* **19**: 2787.
- Huang G.M., Wang K., Kuo C., Paepfer B., and Hood L. 1994. A high-throughput plasmid DNA preparation method. *Anal. Biochem.* **223**: 35–38.
- Huang X. 1996. An improved sequence assembly program. *Genomics* **33**: 21–31.
- Huber H.E., Tabor S., and Richardson C.C. 1987. *Escherichia coli* thioredoxin stabilizes complexes of bacteriophage T7 DNA polymerase and primed templates. *J. Biol. Chem.* **262**: 16224–16232.
- Hunkapiller T., Kaiser R.J., Koop B.F., and Hood L. 1991. Large-scale and automated DNA sequencing determination. *Science* **254**: 59–67.
- Innis M.A., Myambo K.B., Gelfand D.H., and Brow M.A. 1988. DNA sequencing with *Thermus aquaticus* DNA polymerase and direct sequencing of polymerase chain reaction-amplified DNA. *Proc. Natl. Acad. Sci.* **85**: 9436–9440.
- Iverson B.L. and Dervan P.B. 1993. Adenine-specific DNA chemical sequencing reaction. *Methods Enzymol.* **218**: 222–227.
- Jelen F., Karlovsky P., Makaturová E., Pecinka P., and Palecek E. 1991. Osmium tetroxide reactivity of DNA bases in nucleotide sequencing and probing of DNA structure. *Gen. Physiol. Biophys.* **10**: 461–473.
- Jensen M.A., Zagursky R.J., Trainor G.L., Cocuzza A.J., Lee A., and Chen E.Y. 1991. Improvements in the chain-termination method of DNA sequencing through the use of 7-deaza-2'-deoxyadenosine. *DNA Seq.* **1**: 233–239.
- Johnson P.H. and Grossman L.I. 1977. Electrophoresis of DNA in agarose gels. Optimizing separations of conformational isomers of double- and single-stranded DNAs. *Biochemistry* **16**: 4217–4225.
- Joyce C.M. and Grindley N.D. 1983. Construction of a plasmid that overproduces the large proteolytic fragment (Klenow fragment) of DNA polymerase I of *Escherichia coli*. *Proc. Natl. Acad. Sci.* **80**: 1830–1834.
- Joyce C.M. and Steitz T.A. 1987. DNA polymerase I: From crystal structure to function via genetics. *Trends Biochem. Sci.* **12**: 288–292.
- . 1994. Function and structure relationships in DNA polymerases. *Annu. Rev. Biochem.* **63**: 777–822.
- . 1995. Polymerase structures and function: Variations on a theme? *J. Bacteriol.* **177**: 6321–6329.
- Joyce C.M., Kelley W.S., and Grindley N.D. 1982. Nucleotide sequence of the *Escherichia coli* polA gene and primary structure of DNA polymerase I. *J. Biol. Chem.* **257**: 1958–1964.
- Ju J., Ruan C., Fuller C.W., Glazer A.N., and Mathies R.A. 1995. Fluorescence energy transfer dye-labeled primers for DNA sequencing and analysis. *Proc. Natl. Acad. Sci.* **92**: 4347–4351.
- Kiefer J.R., Mao C., Braman J.C., and Beese L.S. 1998. Visualizing DNA replication in a catalytically active *Bacillus* DNA polymerase crystal (see comments). *Nature* **391**: 304–307.
- Klenow H. and Henningsen I. 1970. Selective elimination of the exonuclease activity of the deoxyribonucleic acid polymerase from *Escherichia coli* B by limited proteolysis. *Proc. Natl. Acad. Sci.* **65**: 168–175.
- Klenow H. and Overgaard-Hansen K. 1970. Proteolytic cleavage of DNA polymerase from *Escherichia coli* B into an exonuclease unit and a polymerase unit. *FEBS Lett.* **6**: 25–27.
- Knittel T. and Picard D. 1993. PCR with degenerate primers containing deoxyinosine fails with Pfu DNA polymerase. *PCR Methods Appl.* **2**: 346–347.
- Konat G.W., Laszkiewicz I., Grubinska B., and Wiggins R.C. 1994. Generation of labeled DNA probes by PCR. In *PCR technology: Current innovations* (ed. H.G. Griffin and A.M. Griffin), pp. 37–42. CRC Press, Boca Raton, Florida.
- Koop B.F., Wilson R.K., Chen C., Halloran N., Sciammis R., Hood L., and Lindelien J.W. 1990. Sequencing reactions in microtiter plates. *BioTechniques* **9**: 32–37.
- Kornberg A. and Baker T.A. 1992. *DNA replication*, 2nd edition. W.H. Freeman, New York.
- Korolev S., Nayal M., Barnes W.M., Di Cera E., and Waksman G. 1995. Crystal structure of the large fragment of *Thermus aquaticus* DNA polymerase I at 2.5-Å resolution: Structural basis for thermostability. *Proc. Natl. Acad. Sci.* **92**: 9264–9268.
- Kretz K., Callen W., and Hedden V. 1994. Cycle sequencing. *PCR Methods Appl.* **3**: S107–S112.
- Krishnan B.R., Blakesley R.W., and Berg D.E. 1991. Linear amplification DNA sequencing directly from single phage plaques and bacterial colonies. *Nucleic Acids Res.* **19**: 1153.
- Kristensen T., Vass H., Ansorge W., and Prydz H. 1990. DNA dideoxy sequencing with T7 DNA polymerase: Improved sequencing data by the addition of manganese chloride. *Trends Genet.* **6**: 2–3.
- Krowczynska A.M. and Henderson M.B. 1992. Efficient purification of PCR products using ultrafiltration. *BioTechniques* **13**: 286–289.
- Kunkel T.A., Roberts J.D., and Zakour R.A. 1987. Rapid and efficient site-specific mutagenesis without phenotypic selection. *Methods Enzymol.* **154**: 367–382.
- Kunkel T.A., Eckstein F., Mildvan A.S., Koplitz R.M., and Loeb L.A. 1981. Deoxynucleoside [1-thio]triphosphates prevent proofreading during in vitro DNA synthesis. *Proc. Natl. Acad. Sci.* **78**: 6734–6738.
- Kusukawa N., Uemori T., Asada K., and Kato I. 1990. Rapid and reliable protocol for direct sequencing of material amplified by the polymerase chain reaction. *BioTechniques* **9**: 66–72.
- Lawyer F.C., Stoffel S., Saiki R.K., Myambo K., Drummond R.,

- and Gelfand D.H. 1989. Isolation, characterization, and expression in *Escherichia coli* of the DNA polymerase gene from *Thermus aquaticus*. *J. Biol. Chem.* **264**: 6427–6437.
- Lechner R.L., Engler M.J., and Richardson C.C. 1983. Characterization of strand displacement synthesis catalyzed by bacteriophage T7 DNA polymerase. *J. Biol. Chem.* **258**: 11174–11184.
- Lee E., Nestorowicz A., Marshall I.D., Weir R.C., and Dalgarno L. 1992. Direct sequence analysis of amplified dengue virus genomic RNA from cultured cells, mosquitoes and mouse brain. *J. Virol. Methods* **37**: 275–288.
- Lee J.S. 1991. Alternative dideoxy sequencing of double-stranded DNA by cyclic reactions using Taq polymerase. *DNA Cell Biol.* **10**: 67–73.
- Lee L., Connell C.R., Woo S.L., Cheng R.D., McArdle B.F., Fuller C.W., Halloran N.D., and Wilson R.K. 1992. DNA sequencing with dye-labeled terminators and T7 DNA polymerase: Effect of dyes and dNTP's on incorporation of dye-terminators and probability analysis of termination fragments. *Nucleic Acids Res.* **20**: 2471–2483.
- Lee L., Spurgeon S.L., Heiner C.R., Benson S.C., Rosenblum B.B., Menchen S.M., Graham R.J., Constantinescu A., Upadhyaya K.G., and Cassel J.M. 1997. New energy transfer dyes for DNA sequencing. *Nucleic Acids Res.* **25**: 2816–2822.
- Leonard J.T., Grace M.B., Buzard G.S., Mullen M.J., and Barbagallo C.B. 1998. Preparation of PCR products for DNA sequencing. *BioTechniques* **24**: 314–317.
- Lerman L.S. and Frisch H.L. 1982. Why does the electrophoretic mobility of DNA in gels vary with the length of the molecule? *Biopolymers* **21**: 995–997.
- Longley M.J., Bennett S.E., and Mosbaugh D.W. 1990. Characterization of the 5' to 3' exonuclease associated with *Thermus aquaticus* DNA polymerase. *Nucleic Acids Res.* **18**: 7317–7322.
- Lumpkin O.J., Dejardin P., and Zimm B.H. 1985. Theory of gel electrophoresis of DNA. *Biopolymers* **24**: 1573–1593.
- Mardis E.R. and Roe B.A. 1989. Automated methods for single-stranded DNA isolation and dideoxynucleotide DNA sequencing reactions on a robotic workstation. *BioTechniques* **7**: 840–850.
- Martin R. 1987. Overcoming DNA sequencing artifacts: Stops and compressions. *Focus (Life Technologies)* **9**: 8–10.
- Martin W.J. and Davies R.W. 1986. Automated DNA sequencing: Progress and prospects. *Bio/Technology* **4**: 890–895.
- Mattes W.B., Hartley J.A., and Kohn K.W. 1986. Mechanism of DNA strand breakage by piperidine at sites of N7-alkylguanines. *Biochim. Biophys. Acta* **868**: 71–76.
- Maxam A.M. and Gilbert W. 1977. A new method for sequencing DNA. *Proc. Natl. Acad. Sci.* **74**: 560–564.
- . 1980. Sequencing end-labeled DNA with base-specific chemical cleavages. *Methods Enzymol.* **65**: 499–560.
- McCarthy J.G. 1989. An improvement in thymine specific chemical DNA sequencing. *Nucleic Acids Res.* **17**: 7541.
- McConlogue L., Brow M.A., and Innis M.A. 1988. Structure-independent DNA amplification by PCR using 7-deaza-2'-deoxyguanosine. *Nucleic Acids Res.* **16**: 9869.
- McDonell M.W., Simon M.N., and Studier F.W. 1977. Analysis of restriction fragments of T7 DNA and determination of molecular weights by electrophoresis in neutral and alkaline gels. *J. Mol. Biol.* **110**: 119–146.
- McKee J.R., Christman C.L., O'Brien W.D., Jr., and Wang S.Y. 1977. Effects of ultrasound on nucleic acid bases. *Biochemistry* **16**: 4651–4654.
- Meinkoth J. and Wahl G. 1984. Hybridization of nucleic acids immobilized on solid supports. *Anal. Biochem.* **138**: 267–284.
- Melgar E. and Goldthwait D.A. 1968. Deoxyribonucleic acid nucleases. II. The effects of metals on the mechanism of action of deoxyribonuclease I. *J. Biol. Chem.* **243**: 4409–4416.
- Messing J. 1983. New M13 vectors for cloning. *Methods Enzymol.* **101**: 20–78.
- Mierendorf R.C. and Pfeffer D. 1987. Direct sequencing of denatured plasmid DNA. *Methods Enzymol.* **152**: 556–562.
- Mills D.R. and Kramer F.R. 1979. Structure-independent nucleotide sequence analysis. *Proc. Natl. Acad. Sci.* **76**: 2232–2235.
- Mizusawa S., Nishimura S., and Seela F. 1986. Improvement of the dideoxy chain termination method of DNA sequencing by use of deoxy-7-deazaguanosine triphosphate in place of dGTP. *Nucleic Acids Res.* **14**: 1319–1324.
- Mohler W.A. and Blau M. 1997. Rapid plasmid minipreps in microplate format from culture to gel. *BioTechniques* **22**: 388–390.
- Muro A.F., Pesce C.G., and Kornblihtt A.R. 1993. DNA sequencing by the chemical method: A 10 minute procedure for the G+A reaction. *Trends Genet.* **9**: 337–338.
- Murray V. 1989. Improved double-stranded DNA sequencing using the linear polymerase chain reaction. *Nucleic Acids Res.* **17**: 8889.
- Myers R.M., Ellenson L.H., and Hayashi K. 1998. Detection of DNA variation. In *Genome analysis: A laboratory manual* (ed. B. Birren et al.), vol. 2, pp. 287–384. Cold Spring Harbor Laboratory Press, Cold Spring Harbor, New York.
- Nossal N.G. 1974. DNA synthesis on a double-stranded DNA template by the T4 bacteriophage DNA polymerase and the T4 gene 32 DNA unwinding protein. *J. Biol. Chem.* **249**: 5668–5676.
- Oefner P.J., Hunicke-Smith S.P., Chiang L., Dietrich F., Mulligan J., and Davis R.W. 1996. Efficient random subcloning of DNA sheared in a recirculating point-sink flow system. *Nucleic Acids Res.* **24**: 3879–3886.
- Olsson A., Moks T., Uhlen M., and Gaal A.B. 1984. Uniformly spaced banding pattern in DNA sequencing gels by use of field-strength gradient. *J. Biochem. Biophys. Methods* **10**: 83–90.
- Pandey V.N., Kaushik N., Sanzgiri R.P., Patil M.S., Modak M.J., and Barik S. 1993. Site directed mutagenesis of DNA polymerase I (Klenow) from *Escherichia coli*. The significance of Arg682 in catalysis. *Eur. J. Biochem.* **214**: 59–65.
- Parker L.T., Deng Q., Zakeri H., Carlson C., Nickerson D.A., and Kwok P.Y. 1995. Peak height variations in automated sequencing of PCR products using Taq dye-terminator chemistry. *BioTechniques* **19**: 116–121.
- Parker L.T., Zakeri H., Deng Q., Spurgeon S., Kwok P.Y., and Nickerson D.A. 1996. AmpliTaq DNA polymerase, FS dye-terminator sequencing: Analysis of peak height patterns. *BioTechniques* **21**: 694–699.
- Patel S.S., Wong I., and Johnson K.A. 1991. Pre-steady-state kinetic analysis of processive DNA replication including complete characterization of an exonuclease-deficient mutant. *Biochemistry* **30**: 511–525.
- Pelletier H. 1994. Polymerase structures and mechanism. *Science* **266**: 2025–2026.
- Pennisi E. 2000. Mouse sequencers take up the shotgun. *Science* **287**: 1179–1180.
- Perler E.B., Kumar S., and Kong H. 1996. Thermostable DNA polymerases. *Adv. Protein Chem.* **48**: 377–435.
- Pichersky E. 1996. DNA sequencing by the chemical method.

- Methods Mol. Biol.* **65**: 133–136.
- Pisa-Williamson D. and Fuller C.W. 1992. Glycerol tolerant DNA sequencing gels. *Comments* (U.S. Biochemical Corp.) **19**: 29–36.
- Rao V.B. 1994. Strategies for direct sequencing of PCR-amplified DNA. *PCR Methods Appl.* **4**: S15–S23.
- Reeve M.A. and Fuller C.W. 1995. A novel thermostable polymerase for DNA sequencing. *Nature* **376**: 796–797.
- Reddy P. and McKenney K. 1996. Improved method for the production of M13 phage and single-stranded DNA for DNA sequencing. *BioTechniques* **20**: 854–860.
- Robertson H.D., Barrell B.G., Weith H.L., and Donelson J.E. 1973. Isolation and sequence analysis of a ribosome-protected fragment from bacteriophage phiX 174 DNA. *Nat. New Biol.* **241**: 38–40.
- Rocheleau M.J., Grey R.J., Chen D.Y., Harke H.R., and Dovichi N.J. 1992. Formamide modified polyacrylamide gels for DNA sequencing by capillary gel electrophoresis. *Electrophoresis* **13**: 484–486.
- Rosenblum B.B., Lee L.G., Spurgeon S.L., Khan S.H., Menchen S.M., Heiner C.R., and Chen S.-M. 1997. New dye-labeled terminators for improved DNA sequencing patterns. *Nucleic Acids Res.* **25**: 4500–4504.
- Rosenthal A. and Charnock-Jones D.S. 1992. New protocols for DNA sequencing with dye terminators. *DNA Seq.* **3**: 61–64.
- Ruano G. and Kidd K.K. 1991. Coupled amplification and sequencing of genomic DNA. *Proc. Natl. Acad. Sci.* **88**: 2815–2819.
- Rubin C.M. and Schmid C.W. 1980. Pyrimidine-specific chemical reactions useful for DNA sequencing. *Nucleic Acids Res.* **8**: 4613–4619.
- Saiki R.K., Scharf S., Faloona F., Mullis K.B., Horn G.T., Erlich H.A., and Arnheim N. 1985. Enzymatic amplification of  $\beta$ -globin genomic sequences and restriction site analysis for diagnosis of sickle cell anemia. *Science* **230**: 1350–1354.
- Sanger F. and Coulson A.R. 1975. A rapid method for determining sequences in DNA by primed synthesis with DNA polymerase. *J. Mol. Biol.* **94**: 441–448.
- . 1978. The use of thin acrylamide gels for DNA sequencing. *FEBS Lett.* **87**: 107–110.
- Sanger F., Brownlee G.G., and Barrell B.G. 1965. A two-dimensional fractionation procedure for radioactive nucleotides. *J. Mol. Biol.* **13**: 373–398.
- Sanger F., Nicklen S., and Coulson A.R. 1977a. DNA sequencing with chain-terminating inhibitors. *Proc. Natl. Acad. Sci.* **74**: 5463–5467.
- Sanger F., Coulson A.R., Barrell B.G., Smith A.J., and Roe B.A. 1980. Cloning in single-stranded bacteriophage as an aid to rapid DNA sequencing. *J. Mol. Biol.* **143**: 161–178.
- Sanger F., Donelson J.E., Coulson A.R., Kossel H., and Fischer D. 1973. Use of DNA polymerase I primed by a synthetic oligonucleotide to determine a nucleotide sequence in phage  $\phi$ 1 DNA. *Proc. Natl. Acad. Sci.* **70**: 1209–1213.
- Sanger F., Air G.M., Barrell B.G., Brown N.L., Coulson A.R., Fiddes C.A., Hutchison C.A., Slocombe P.M., and Smith M. 1977b. Nucleotide sequence of bacteriophage phiX174 DNA. *Nature* **265**: 687–695.
- Schena P. 1989. High efficiency oligonucleotide mutagenesis. *Comments* (U.S. Biochemical Corp.) **15**: 23.
- Schriefer L.A., Gebauer B.K., Qui L.Q., Waterston R.H., and Wilson R.K. 1990. Low pressure DNA shearing: A method for random DNA sequence analysis. *Nucleic Acids Res.* **18**: 7455–7456.
- Sears L.E., Moran L.S., Kissinger C., Creasy T., Perry-O'Keefe H., Roskey M., Sutherland E., and Slatko B. 1992. CircumVent™ thermal cycle sequencing and alternative manual and automated DNA sequencing protocols using the highly thermostable Vent<sub>R</sub>™ (exo<sup>-</sup>) DNA polymerase. *BioTechniques* **13**: 626–633.
- Seela F., Berg H., and Rosemeyer H. 1989. Bending of oligonucleotides containing an isosteric nucleobase: 7-deaza-2'-deoxyadenosine replacing dA within d(A)<sub>6</sub> tracts. *Biochemistry* **28**: 6193–6198.
- Seela F., Tran-Thi Q.H., and Franzen D. 1982. Poly(7-deaza-guanilylic acid), the homopolynucleotide of the parent nucleoside of queuosine. *Biochemistry* **21**: 4338–4343.
- Setlow P. 1974. DNA polymerase I from *Escherichia coli*. *Methods Enzymol.* **29**: 3–12.
- Sheen J.-Y. and Seed B. 1988. Electrolyte gradients for DNA sequencing. *BioTechniques* **6**: 942–944.
- Slater G.W. and Noolandi J. 1989. The biased reptation model of DNA gel electrophoresis: Mobility vs molecular size and gel concentration. *Biopolymers* **28**: 1781–1791.
- Slater G.W., Mayer P., and Drouin G. 1996. Migration of DNA through gels. *Methods Enzymol.* **270**: 272–295.
- Slupphaug G., Alseth I., Eftedal I., Volden G., and Krokan H.E. 1993. Low incorporation of dUMP by some thermostable DNA polymerases may limit their use in PCR amplifications. *Anal. Biochem.* **211**: 164–169.
- Smisek D.L. and Hoagland D.A. 1990. Electrophoresis of flexible macromolecules: Evidence for a new mode of transport in gels. *Science* **248**: 1221–1223.
- Smith D.P., Johnstone E.M., Little S.P., and Hsiung H.M. 1990. Direct DNA sequencing of cDNA inserts from plaques using the linear polymerase chain reaction. *BioTechniques* **9**: 48–52.
- Smith L.M. 1991. High-speed DNA sequencing by capillary gel electrophoresis. *Nature* **349**: 812–813.
- Smith L.M., Sanders J.Z., Kaiser R.J., Hughes P., Dodd C., Connell C.R., Heiner C., Kent S.B.H., and Hood L.E. 1986. Fluorescence detection in automated DNA sequence analysis. *Nature* **321**: 674–679.
- Smith V., Craxton M., Bankier A.T., Brown C.M., Rawlinson W.D., Chee M.S., and Barrell B.G. 1993. Preparation and fluorescent sequencing of M13 clones: Microtiter methods. *Methods Enzymol.* **218**: 173–187.
- Steitz T.A. 1998. A mechanism for all polymerases. *Nature* **391**: 231–232.
- Studencki A.B. and Wallace R.B. 1984. Allele-specific hybridization using oligonucleotide probes of very high specific activity: Discrimination of the human beta A- and beta S-globin genes. *DNA* **3**: 7–15.
- Swerdlow H. and Gesteland R. 1990. Capillary gel electrophoresis for rapid, high resolution DNA sequencing. *Nucleic Acids Res.* **18**: 1415–1419.
- Tabor S. and Richardson C.C. 1987a. DNA sequence analysis with a modified bacteriophage T7 DNA polymerase. *Proc. Natl. Acad. Sci.* **84**: 4767–4771.
- . 1987b. Selective oxidation of the exonuclease domain of bacteriophage T7 DNA polymerase. *J. Biol. Chem.* **262**: 15330–15333.
- . 1989a. Selective inactivation of the exonuclease activity of bacteriophage T7 DNA polymerase by in vitro mutagenesis. *J. Biol. Chem.* **264**: 6447–6458.
- . 1989b. Effect of manganese ions on the incorporation of dideoxynucleotides by bacteriophage T7 DNA polymerase

- and *Escherichia coli* DNA polymerase I. *Proc. Natl. Acad. Sci.* **86**: 4076–4080.
- , —, —. 1990. DNA sequence analysis with a modified bacteriophage T7 DNA polymerase. Effect of pyrophosphorolysis and metal ions. *J. Biol. Chem.* **265**: 8322–8328.
- , —, —. 1995. A single residue in DNA polymerases of the *Escherichia coli* DNA polymerase I family is critical for distinguishing between deoxy- and dideoxyribonucleotides. *Proc. Natl. Acad. Sci.* **92**: 6339–6343.
- Tabor S., Huber H.E., and Richardson C.C. 1987. *Escherichia coli* thioredoxin confers processivity on the DNA polymerase activity of the gene 5 protein of bacteriophage T7. *J. Biol. Chem.* **262**: 16212–16223.
- Trevino R.J., Horowitz P.M., and Chirgwin J.M. 1993. Elimination of glycerol artifacts in cycle sequencing. *BioTechniques* **15**: 366–368.
- Tu C.P. and Cohen S.N. 1980. 3'-end labeling of DNA with [ $\alpha$ -<sup>32</sup>P]cordycepin-5'-triphosphate. *Gene* **10**: 177–183.
- Tu C.P. and Wu R. 1980. Sequence analysis of short DNA fragments. *Methods Enzymol.* **65**: 620–638.
- Vander Horn P.B., Davis M.C., Cunniff J.J., Ruan C., McArdle B.F., Samols S.B., Szasz J., Hu G., Hujer K.M., Domke S.T., Brummet S.R., Moffett R.B., and Fuller C.W. 1997. Thermo Sequenase™ DNA polymerase and *T. acidophilum* pyrophosphatase: New thermostable enzymes for DNA sequencing. *BioTechniques* **22**: 758–765.
- Venter J.C., Adams M.D., Sutton G.G., Kerlavage A.R., Smith H.O., and Hunkapiller M. 1998. Shotgun sequencing of the human genome. *Science* **280**: 1540–1542.
- Völkel A.R. and Noolandi J. 1995. Electrophoresis between sieving and reptation: An investigation of the role of shape fluctuations in electrophoresis. *Electrophoresis* **16**: 2086–2093.
- Voss H., Nentwich U., Duthie S., Wiemann S., Benes V., Zimmermann J., and Ansoerge W. 1997. Automated cycle sequencing with Taqenase: Protocols for internal labeling, dye primer and “doublex” simultaneous sequencing. *BioTechniques* **23**: 312–318.
- Wahlberg J., Holmberg A., Bergh S., Hultman T., and Uhlén M. 1992. Automated magnetic preparation of DNA templates for solid phase sequencing. *Electrophoresis* **13**: 547–551.
- Wahls W.P. and Kingzette M. 1988. No runs, no drips, no errors: A new technique for sealing polyacrylamide gel electrophoresis apparatus. *BioTechniques* **6**: 308–309.
- Wang B. and Sodja A. 1991. Alternate approach to sequencing double-stranded template DNAs. *BioTechniques* **10**: 198–201.
- Weber J.L. and Myers E.W. 1997. Human whole-genome shotgun sequencing. *Genome Res.* **7**: 401–409.
- Werle E., Schneider C., Renner M., Volker M., and Fiehn W. 1994. Convenient single-step, one tube purification of PCR products for direct sequencing. *Nucleic Acids Res.* **22**: 4354–4355.
- Wilson R.K. 1993. High-throughput purification of M13 templates for DNA sequencing. *BioTechniques* **15**: 414–422.
- Wilson R.K., Chen C., and Hood L. 1990. Optimization of asymmetric polymerase chain reaction for rapid fluorescent DNA sequencing. *BioTechniques* **8**: 184–189.
- Winship P.R. 1989. An improved method for directly sequencing PCR amplified material using dimethyl sulphoxide. *Nucleic Acids Res.* **17**: 1266.
- Wrishnik L.A., Higuchi R.G., Stoneking M., Erlich H.A., Arnheim N., and Wilson A.C. 1987. Length mutations in human mitochondrial DNA: Direct sequencing of enzymatically amplified DNA. *Nucleic Acids Res.* **15**: 529–542.
- Wu H.M. and Crothers D.M. 1984. The locus of sequence-directed and protein-induced DNA bending. *Nature* **308**: 509–513.
- Wu R. and Taylor E. 1971. Nucleotide sequence analysis of DNA. II. Complete nucleotide sequence of the cohesive ends of bacteriophage lambda DNA. *J. Mol. Biol.* **57**: 491–511.
- Xia Y.N., Burbank D.E., Uher L., Rabussay D., and Van Etten J.L. 1987. IL-3A virus infection of a *Chlorella*-like green alga induces a DNA restriction endonuclease with novel sequence specificity. *Nucleic Acids Res.* **15**: 6075–6090.
- Yager T.D., Dunn J.M., and Stevens J.K. 1997. High speed DNA sequencing in ultrathin slab gels. *Curr. Opin. Biotechnol.* **8**: 107–113.
- Yan J.Y., Bests N., Zhang J.Z., Ren H.J., Jiang R., Hou J., and Dovichi N.J. 1996. The limiting mobility of DNA sequencing fragments for both crosslinked and noncrosslinked polymers in capillary electrophoresis DNA sequencing at 1,200 V cm<sup>-1</sup>. *Electrophoresis* **17**: 1037–1045.
- Ziff E.B., Sedat J.W., and Galibert F. 1973. Determination of the nucleotide sequence of a fragment of bacteriophage phiX 174 DNA. *Nat. New Biol.* **241**: 34–37.
- Zimm B.H. and Lumpkin O. 1993. Reptation of a polymer chain in an irregular matrix: Diffusion and electrophoresis. *Macromolecules* **26**: 226–234.
- Zollo M. and Chen E.Y. 1994. A manual high-throughput M13 DNA preparation. *BioTechniques* **16**: 370–372.

# Chapter 13

---

## Mutagenesis

### INTRODUCTION

### PROTOCOLS

- 1 Preparation of Uracil-containing Single-stranded Bacteriophage M13 DNA 13.11
- 2 Oligonucleotide-directed Mutagenesis of Single-stranded DNA 13.15
- 3 In Vitro Mutagenesis Using Double-stranded DNA Templates: Selection of Mutants with *DpnI* 13.19
- 4 Oligonucleotide-directed Mutagenesis by Elimination of a Unique Restriction Site (USE Mutagenesis) 13.26
- 5 Rapid and Efficient Site-directed Mutagenesis by the Single-tube Megaprimer PCR Method 13.31
- 6 Site-specific Mutagenesis by Overlap Extension 13.36
- 7 Screening Recombinant Clones for Site-directed Mutagenesis by Hybridization to Radiolabeled Oligonucleotides 13.40
  - Alternative Protocol: Screening Phagemid-containing Bacterial Colonies by Hybridization to Radiolabeled Oligonucleotides 13.47
  - Alternative Protocol: Detection of Defined Mutants by PCR 13.48
- 8 Detection of Mutations by Single-strand Conformational Polymorphism and Heteroduplex Analysis 13.49
- 9 Generation of Sets of Nested Deletion Mutants with Exonuclease III 13.57
- 10 Generation of Bidirectional Sets of Deletion Mutants by Digestion with BAL 31 Nuclease 13.62

### INFORMATION PANELS

- BAL 31 13.68
- Exonuclease III 13.72
- Linker-scanning Mutagenesis 13.75
- Random Mutagenesis 13.78
- Alanine-scanning Mutagenesis 13.81
- Mutagenic Oligonucleotides 13.82
- Selecting against Wild-type DNA in Site-directed Mutagenesis 13.84
- N*<sup>6</sup>-methyladenine, *Dam* Methylase, and Methylation-sensitive Restriction Enzymes 13.87
- Commercial Kits for Site-directed Mutagenesis 13.89
- Glycerol 13.90
- Mutation Detection 13.91

**13.1**

**I**N VITRO MUTAGENESIS IS USED TO CHANGE THE BASE SEQUENCE of a segment of DNA. The changes may be localized or general, random or targeted. More catholic and less specific methods of mutagenesis are better suited to analysis of regulatory regions of genes, whereas more precise types of mutagenesis are used to understand the contribution of individual amino acids, or groups of amino acids, to the structure and function of a target protein. Both methods share the virtue of generating mutants in vitro, without phenotypic selection.

## MUTAGENESIS OF REGULATORY REGIONS

---

Most of the *cis*-acting elements that control expression of mammalian genes were originally identified and localized by analyzing nested sets of deletions, generated by in vitro mutagenesis, that penetrate the region of interest for different distances. To make these deletions, the target DNA was digested from a fixed point upstream or downstream from the region of interest with an enzyme such as BAL 31, which progressively shortens a double-stranded DNA fragment, or with exonuclease III, which digests double-stranded DNA from 3' termini. For further details on these enzymes, please see the information panels on **BAL 31** and **EXONUCLEASE III** at the end of this chapter. Nested deletions allowed definition of the outer borders of the regulatory domains and opened the way to more precise mapping and analysis of internal subdomains by linker scanning (please see the information panel on **LINKER-SCANNING MUTAGENESIS**) and site-directed mutagenesis.

Work of this type was central to our current understanding of mammalian gene control and led to the description of binding sites for many transcription factors and to the identification of other types of *cis*-acting elements. Productive as this work may have been, it was certainly formulaic and dreary! To our great relief, nested deletions and linker-scanning mutagenesis passed their zenith sometime in the late 1980s and are now used only rarely (please see Protocols 9 and 10). Regulatory elements are nowadays more easily identified by computer searches for consensus sequences in regulatory regions, whereas mutations in *cis*-acting elements are more efficiently constructed by polymerase chain reaction (PCR)-mediated methods (please see Protocols 5 and 6).

## MUTAGENESIS OF CODING SEQUENCES

---

Several different types of mutagenesis are used to understand the contribution of specific amino acids and groups of amino acids to the structure and function of proteins.

### Saturation Mutagenesis

Saturation mutagenesis is used to generate mutations at many sites in a particular coding sequence. Every effort is made to introduce mutations in an unbiased fashion; preconceptions and knowledge about the functions of individual amino acids in the wild-type sequence are disregarded. The aim is to gather information about the entire "sequence space," i.e., about the relationship between the amino acid sequence and the three-dimensional structure of the protein.

Saturation mutagenesis is usually carried out on small segments of DNA that encode an individual structural domain. At its best, the method can provide catalogs of amino acids or combinations of amino acids that are tolerated within a domain without deleterious effect on structure and function. Studies of the bacteriophage  $\lambda$  repressor, for example, have shown that a large number of combinations of amino acids can satisfy the structural and functional requirements

of the hydrophobic core and  $\alpha$  helices of the molecule (Reidhaar-Olson and Sauer 1988; Lim and Sauer 1989). For further details about saturation mutagenesis, please see the information panel on **RANDOM MUTAGENESIS**.

### Scanning Mutagenesis

Alanine-scanning mutagenesis is used to analyze the function(s) of particular amino acid residues on the surface of a protein. The charged residues that normally dapple the surface of proteins are not usually required for structural integrity, but they are generally involved in ligand binding, oligomerization, or catalysis. Systematic replacement of charged amino acids with alanine residues eliminates side chains beyond the  $\beta$ -carbon and disrupts the functional interactions of the amino acids without changing the conformation of the main chain of the protein. Alanine scanning is therefore a powerful method for assigning functions to particular regions of the protein surface (Cunningham and Wells 1989) (please see the information panel on **ALANINE-SCANNING MUTAGENESIS**).

In an extension of this approach — cysteine-scanning mutagenesis — unpaired cysteine residues are used to replace individual amino acid residues at particular sites in the protein. Unpaired cysteine residues are of average size, uncharged, and hydrophobic. Because they react efficiently with modifying reagents such as *N*-ethylmaleimide, cysteine residues introduced by scanning mutagenesis can be used as biochemical tags to verify the topology of transmembrane proteins and to measure the accessibility of residues to modifying reagents in the aqueous or lipid phases (e.g., please see Akabas et al. 1992; Dunten et al. 1993; Kürz et al. 1995; Frillingos and Kaback 1996, 1997; He et al. 1996; Frillingos et al. 1997a,b, 1998).

### Oligonucleotide-directed Mutagenesis

Oligonucleotide-directed mutagenesis is used to test the role of particular residues in the structure, catalytic activity, and ligand-binding capacity of a protein. In the absence of a three-dimensional structure, this type of protein engineering relies on informed guesses concerning the structure of the protein and the contribution of individual residues to protein stability and function. A major problem is distinguishing mutations that affect local structures from those that have profound and deleterious effects on the folding or stability of the entire protein. Consider a typical experiment in which a number of point mutations have been generated at various sites in a gene coding for an enzyme. When the activities of these mutants are assayed, some of them show a reduction in catalytic function and others do not. In the absence of any other data, it is not possible to draw firm conclusions about the structure of the enzyme from this result. There is no way to know whether the substitution of one amino acid for another has affected only the function of the active site or whether it has had more global effects. The problem would remain even if the three-dimensional structure of the wild-type enzyme were known. No algorithms have yet been devised that accurately predict the perturbations in protein structure caused by the substitution, addition, or deletion of amino acid residues. However, these difficulties can be alleviated by developing independent assays for the folding of the protein of interest. Such assays commonly include the ability of the protein to react with mono- or polyclonal antibodies that are specific for native or unfolded epitopes, the proper movement and posttranslational modification of the protein within a cell, the retention of catalytic or ligand-binding functions, and the sensitivity or resistance of the mutant protein to digestion with proteases.

If reliable assays are available to confirm that the mutagenized protein is correctly folded, oligonucleotide-directed mutagenesis becomes an analytical technique with both exquisite specificity and extraordinary breadth. Mutations that could never be found in nature can now be

placed precisely in the target gene; functions of proteins can be mapped to specific structural domains; undesirable activities of enzymes can be eliminated and their desirable catalytic and physical properties can be enhanced. In short, oligonucleotide-directed mutagenesis has become the genetic engineer's alchemy.

## METHODS OF OLIGONUCLEOTIDE-DIRECTED MUTAGENESIS

---

The scientific literature on oligonucleotide-directed mutagenesis is both highly redundant and unnecessarily complex. In fact, the hundreds of methods that have been described during the last two decades are all based on a simple concept (Zoller and Smith 1982, 1983, 1984; for review, please see Smith 1985).

- A synthetic oligonucleotide encoding the desired mutation is annealed to the target region of the wild-type template DNA where it serves as a primer for initiation of DNA synthesis *in vitro*.
- Extension of the oligonucleotide by a DNA polymerase generates a double-stranded DNA that carries the desired mutation.
- The mutated DNA is then inserted at the appropriate location of the target gene, and the mutant protein is expressed.

Figure 13-1 shows one way in which this general scheme has been adapted for use with a plasmid vector and a DNA polymerase such as bacteriophage T4 DNA polymerase. Many elaborations and improvements have been made to this scheme over the years, particularly since the advent of PCR, but the basic principles have not changed.

## DESIGN OF MUTAGENIC OLIGONUCLEOTIDES

---

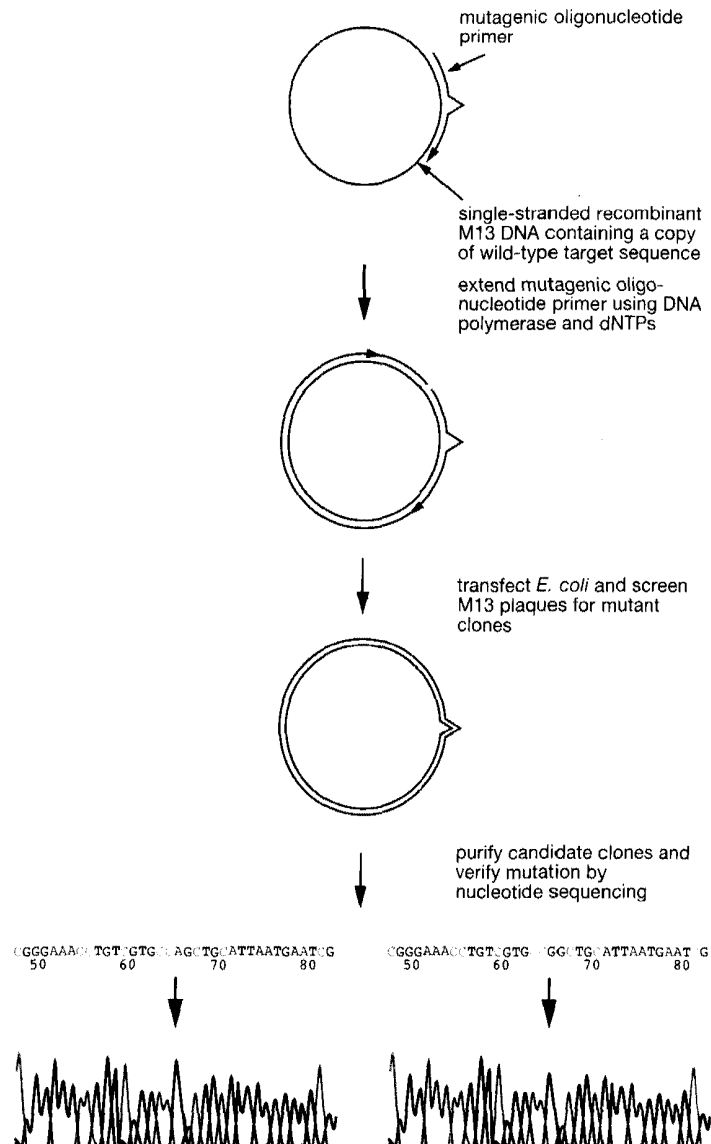
A crucial step in site-directed mutagenesis is the design of the mutagenic oligonucleotide. By definition, mutagenic oligonucleotides must contain at least one base change, but they may incorporate far more complicated mutations including insertions, deletions, and compound substitutions. The minimum length of the mutagenic oligonucleotide is defined by the complexity of the mutation. Simple single-base substitutions can be accomplished with oligonucleotides ~25 bases in length. More complicated mutations may require oligonucleotides 80 bases or more in length, which is close to the practical limit of most automated synthesizers. Once the length of the oligonucleotide is defined, other properties such as base sequence, base composition, melting temperature, propensity to form secondary structures, and specificity of annealing must be brought into balance in order to maximize the efficiency of mutagenesis. For the principles that guide these design features, please see the information panel on **MUTAGENIC OLIGONUCLEOTIDES**.

## CLASSICAL SITE-DIRECTED MUTAGENESIS

---

The feasibility of introducing specific changes at defined locations in DNA was first recognized in the early 1970s from work aimed at mapping the locations of mutations on the single-stranded genome of the small bacteriophage  $\phi$ X174. When fragments of denatured wild-type bacteriophage DNA were transfected into susceptible bacteria together with intact single-stranded bacte-





**FIGURE 13-1** General Scheme for Oligonucleotide-directed Mutagenesis

riophage DNA carrying an amber mutation, “marker rescue” was observed, i.e., bacteriophages carrying wild-type genomes were generated. Marker rescue occurred in the transfected bacteria because the fragment of wild-type DNA annealed to the corresponding sequence of the amber mutant, forming a mismatched heteroduplex that was converted by host-specified mismatch-repair systems into a full-length wild-type genome. It was quickly realized that this process could also be used in reverse, i.e., that specific mutations could be introduced into wild-type DNA using mutated double-stranded fragments of viral DNA (Weisbeek and van de Pol 1970; Hutchison and Edgell 1971). Later, when pioneering work in DNA chemistry led to the routine synthesis of oligonucleotides (Letsinger and Lunsford 1976; Khorana 1979; Caruthers et al. 1983), and when the availability and quality of DNA polymerases and DNA ligases had improved, Smith and colleagues developed *in vitro* techniques for oligonucleotide-directed DNA mutagenesis. The first methods used synthetic oligonucleotides that were completely homologous to single-stranded

bacteriophage  $\phi$ X174 DNA except for a single base change that, if incorporated into the bacteriophage genome, would generate a selectable phenotype. The oligonucleotides were annealed to single-stranded bacteriophage  $\phi$ X174 DNA and used as primers for DNA synthesis catalyzed *in vitro* by the Klenow fragment of *Escherichia coli* DNA polymerase I. When the resulting heteroduplexes were transfected into bacteria, a dramatic increase was observed in the frequency of bacteriophages displaying the desired phenotype (Hutchison et al. 1978; Razin et al. 1978).

Many of the methods used for oligonucleotide-mediated mutagenesis differ little in principle from the marker rescue techniques used originally by Clyde Hutchison and his colleagues at Chapel Hill, North Carolina. Throughout the 1980s, protocols for oligonucleotide-mediated mutagenesis typically involved the following steps:

- Design and synthesis of mutagenic oligonucleotides.
- Hybridization of mutagenic oligonucleotides to single-stranded target DNA cloned in a bacteriophage or phagemid vector. Use of such single-stranded templates eliminates competition between the mutagenic oligonucleotide and a complementary strand of DNA.
- Extension of the hybridized oligonucleotide by DNA polymerase in the presence of all four deoxynucleoside triphosphates (dNTPs).
- Formation of closed circular DNA by ligation with DNA ligase.
- Transfection of susceptible bacteria.
- Screening of clones by hybridization (e.g., to the mutagenic oligonucleotide primer) for those carrying the desired mutation.
- Preparation of single-stranded DNA from the mutagenized clones.
- Confirmation by DNA sequencing that the target DNA in the mutagenized clones carries the desired mutation and no other.
- Recovery of the mutated fragment of DNA.
- Substitution of the mutagenized fragment for the corresponding segment of wild-type DNA.

Throughout the 1980s, a succession of improvements to virtually all of the technical aspects of the procedure included:

- Development of a versatile set of bacteriophage M13 and phagemid vectors, equipped with polycloning sites.
- Use of two oligonucleotide primers, one of which is a standard universal primer and the other a mutagenic primer (Norris et al. 1983; Zoller and Smith 1984, 1987). The use of two primers in the extension reaction eliminated the need to isolate covalently closed circular DNA.
- Use of two primers and a double-stranded plasmid or phagemid DNA as template (Schold et al. 1984). This procedure, although less efficient in terms of yield of mutants, eliminated the need to subclone target DNA into a bacteriophage M13 vector.
- Improvement of techniques to screen bacteriophage M13 plaques for the desired mutation by oligonucleotide hybridization (Wallace et al. 1979, 1981; Suggs et al. 1981).
- Use of highly accurate DNA polymerases encoded by bacteriophage T4 or T7, which shorten the time required to synthesize the heteroduplex from 12 hours to 1 or 2 hours (Nossal 1974; McClary et al. 1989; Schena 1989). These polymerases have the additional advantage of not causing displacement of the 5' end of the mutagenic oligonucleotide primer.

In classical methods of site-directed mutagenesis, the proportion of clones containing the desired mutation varies from 0.1% to >50% depending on the efficiency of the mutagenic oligonucleotide. Several methods have been developed to select against clones that contain non-mutant DNAs, including (1) selective digestion of template DNAs by removal of modified bases (Kunkel 1985; Kunkel et al. 1991), restriction enzymes (Hofer and Kühlein 1993), or exonucleases (Taylor et al. 1985); (2) restoration of an antibiotic resistance gene or an origin of replication (Hashimoto-Gotoh et al. 1995); and (3) elimination of a restriction site from mutant DNAs (Deng and Nickoloff 1992). For a more detailed discussion of these methods, please see the information panel on **SELECTING AGAINST WILD-TYPE DNA IN SITE-DIRECTED MUTAGENESIS**.

Because of these improvements, the classic method of oligonucleotide-mediated site-directed mutagenesis over the years became extremely efficient and reliable. However, like many other elegant and inventive techniques, it was quickly rendered obsolete by PCR and is no longer the first choice to create mutations in a target segment of DNA. Most site-directed mutations these days are more easily generated by one of the many variants of PCR than by the classic methods.

## PCR-MEDIATED SITE-DIRECTED MUTAGENESIS

---

Most of the PCR-based methods of mutagenesis in current use are direct descendants of techniques originally described in the late 1980s, soon after the introduction of thermostable DNA polymerases to PCR (Higuchi et al. 1988; Ho et al. 1989; Kadowaki et al. 1989; Vallette et al. 1989). At that time, it was already known that centrally located single-base mismatches in hybrids between oligonucleotide primers and the target DNA did not affect the efficiency of amplification. Early investigators showed that these mismatches could be converted into mutations located in the primer regions of PCR products, which, in turn, could be substituted for the homologous wild-type segment in, for example, a recombinant plasmid. The following are important advantages of PCR-based methods for site-directed mutagenesis:

- **High rates of recovery of mutants.** In many cases, the yield of mutants is so high that selection against nonmutant templates is not required.
- **Ability to use double-stranded DNA templates** and to introduce mutations at almost any site.
- **Use of high temperatures** to reduce the ability of the template DNA to form secondary structures that lower the efficiency of the extension reaction on single-stranded DNA templates.
- **Development of methods** in which all of the reactions are carried out in one tube (e.g., please see Marini et al. 1993; Picard et al. 1994; Ke and Madison 1997).
- **Availability of commercial kits.**
- **Speed and ease.** No more cloning in bacteriophage M13 vectors!

The following are potential disadvantages of PCR-based methods:

- **Relatively high rate of errors in PCR products** that often contain unwanted mutations in addition to desired alterations. This problem can be minimized by (1) limiting the number of amplification cycles and (2) using, in preference to *Taq*, thermostable DNA polymerases, such as *Pfu* and *Vent*, which carry a 3'-5' exonuclease activity and have an editing ability.
- **Introduction of unwanted nucleotides at the 3' termini of amplified DNAs.** This problem can also be solved by using *Pfu* DNA polymerase rather than *Taq*.

- **Large number of primers and amplification reactions required for each mutagenesis experiment by some PCR-based methods.** For example, some of the “megaprimer” methods discussed below require three or four primers and/or three sequential PCRs.
- **Requirement to optimize the conditions for PCR for each new set of primers and/or template.** Without optimization, the DNA products of the PCR-based methods may be heterogeneous in size and may migrate through agarose gels as a smear, rather than as a discrete band.
- **High frequency of unmutagenized clones resulting from contamination of the PCR-amplified DNA with the parental, wild-type DNA used as template in the PCR.** This problem is best solved by using a restriction enzyme such as *DpnI* to digest the plasmid selectively (e.g., please see Weiner et al. 1994; Ansaldi et al. 1996; Li and Wilkinson 1997) (please see the information panel on **SELECTING AGAINST WILD-TYPE DNA IN SITE-DIRECTED MUTAGENESIS**).
- **Inefficiency in amplifying DNA fragments longer than 2–3 kb by standard PCR.** Potential solutions to this problem are discussed in Chapter 8, Protocol 13.

This list of disadvantages may seem long, but it should not be seen as formidable. Most of the problems can be avoided entirely with a little forethought and planning; solutions to others are available either in Chapter 8 of this manual, in the literature that accompanies commercially available mutagenesis kits, on manufacturers’ Internet sites, or in the scientific literature.

## METHODS OF PCR-BASED MUTAGENESIS

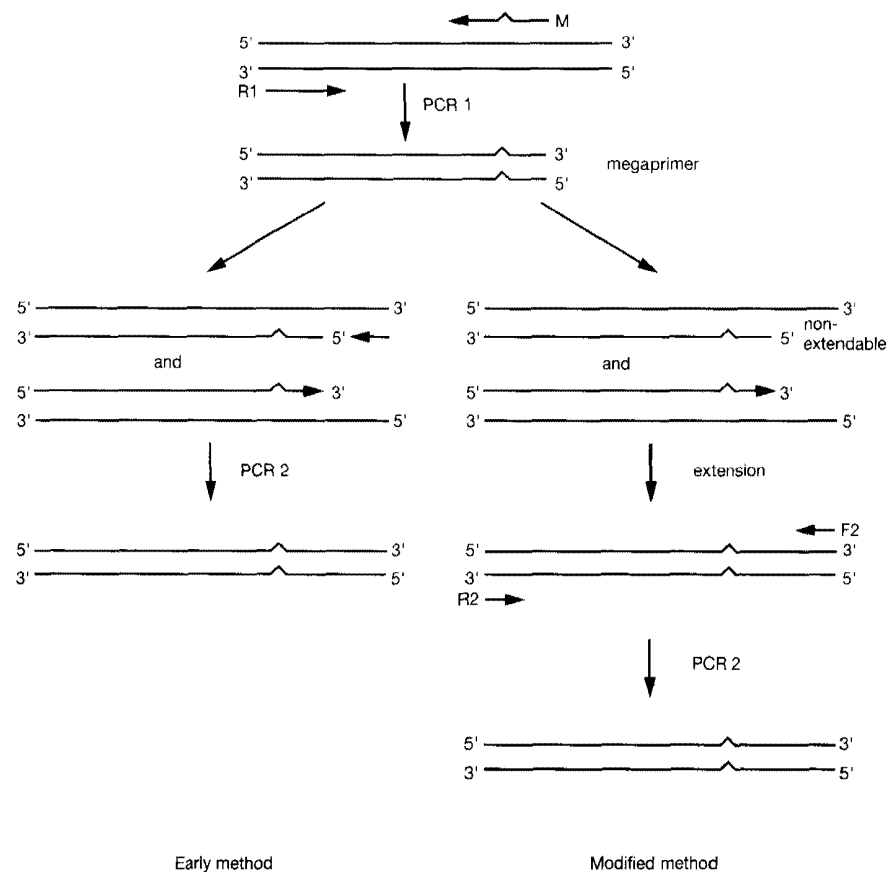
---

Of the many published variants of PCR-based mutagenesis, two stand out for their durability and robustness: overlap extension mutagenesis and megaprimer mutagenesis.

In overlap extension mutagenesis (Higuchi et al. 1988; Ho et al. 1989), two overlapping DNA fragments are amplified in separate PCRs (please see Protocol 6). The mutation of interest is constructed in the region of overlap and is present in both amplified fragments. The overlapping fragments are mixed and, in a third PCR, are amplified into a full-length DNA using two primers that bind to the extremes of the two initial fragments. The method is surprisingly effective, but it requires two mutagenic primers, two flanking oligonucleotides, and three PCRs to construct a mutation. In some cases, a simpler version of the method can be used (one mutagenic primer and two sequential PCRs) if strategically placed restriction sites are available to clone the segment of amplified DNA containing the mutation (Aiyar et al. 1996). This is not always the case.

The megaprimer method introduced by Kamman et al. (1989) and subsequently modified by Sarkar and Sommer (1990, 1992), Giebel and Spritz (1990), and Landt et al. (1990) is the simplest and most cost-effective method of PCR-based mutagenesis currently available. The method involves two rounds of PCR that employ two flanking primers and one internal mutagenic primer containing the desired base substitutions. The flanking primers can be complementary to sequences in the cloned gene or to adjacent vector sequences. The mutagenic primer can, in theory, be oriented toward either of the flanking primers. In practice, however, the mutagenic primer is always oriented toward the nearer of the two flanking primers so that the length of the megaprimer is kept to a minimum.

In the original protocols (please see Figure 13-2), the first round of PCR is performed with the mutagenic primer, the nearer of the flanking primers, and a wild-type DNA template. The product of this first reaction, a double-stranded megaprimer, is purified and used in a second PCR, together with the reverse flanking primer. The product is a double-stranded DNA that contains the mutation and whose size is equal to the distance between the two outside flanking



**FIGURE 13-2 The Basic Megaprimer Method**

PCR 1 is performed with a mutagenic forward primer (M) and a reverse primer (R1) to generate and amplify a double-stranded megaprimer (shown in color). (Left) In the early method, the megaprimer is purified and used with an additional forward primer (F2) in PCR 2 to obtain the desired full-length mutant. (Right) In the modified method, the megaprimer is extended on the original template to form mutant: wild-type heteroduplexes, which are used as templates in a second PCR (PCR 2), primed by oligonucleotides R2 and F2. (Modified, with permission, from Ling and Robinson 1997 [©Academic Press].)

primers. If the flanking primers contain restriction sites for ease of cloning, the product of the second-round PCR can be used to reconstruct a mutagenized version of the target gene.

In the second and more recent method, a purified or unpurified megaprimer is extended on a wild-type DNA template (Marini et al. 1993). Because only one strand of the megaprimer can be extended, the product of the reaction is a full-length single-stranded DNA that carries the desired mutation(s). This DNA is then amplified using the two flanking primers (Picard et al. 1994; Ling and Robinson 1997). In our hands, however, this protocol is tricky and works well only when the extended megaprimer is purified and used in high concentration in a second PCR whose parameters have been carefully optimized.

The chief problem with both variants of the megaprimer method is the time-consuming and laborious purification step, which is usually accomplished by agarose gel electrophoresis and elution. Purification is required to remove residual primers from the amplified megaprimer synthesized in the first PCR. An ingenious and simple solution to this difficulty is to use flanking primers with significantly different melting temperatures ( $T_m$ ) to prime the two PCRs (Ke and Madison 1997). The first flanking primer is just 15 or 16 bases long and has a calculated  $T_m$  of

~45°C. The first PCR is therefore programmed with a low annealing temperature. At the end of the first PCR, the second flanking primer, 25–30 bases in length and with a calculated  $T_m$  of 72–80°C, is added directly to the reaction tube. The second PCR is then carried out using a high-temperature annealing step (usually 72–80°C). The final, full-length DNA product is therefore generated by priming with the megaprimer and the second flanking primer. Because annealing of the first flanking primer is suppressed at high temperature, the wild-type template DNA is not amplified efficiently in the second PCR. The product of the second PCR therefore consists almost entirely of mutated DNA.

## METHODS USED IN THIS CHAPTER

**TABLE 13-1 Site-directed Mutagenesis**

PROTOCOL	TEMPLATE	METHOD USED TO ENRICH FOR MUTANTS
1 and 2	single-stranded DNA	selection against uracil-substituted DNA
3	double-stranded DNA	selection of mutants with <i>DpnI</i>
4	double-stranded DNA	elimination of a restriction site (USE mutagenesis)
5	double-stranded DNA	megaprimer
6	double-stranded DNA	splice overlap extension

The methods of site-directed mutagenesis described in the first six protocols of this chapter are summarized in Table 13-1. Protocol 7 describes screening of bacteriophage plaques for mutants by radiolabeled oligonucleotides, whereas Protocol 8 describes two methods to detect mutations: SSCP and heteroduplex analysis. For further details of screening, scanning, and identification of mutations, please see the information panel on **MUTATION DETECTION** and its accompanying table that summarizes methods commonly used to detect mutations. In addition, we describe methods to generate nested unidirectional (Protocol 9) and bidirectional deletions (Protocol 10) using exonuclease III and BAL 31 nuclease, respectively.

Finally, as is increasingly the trend for many methods in molecular biology, a wide variety of kits are available from various manufacturers (please see the information panel on **COMMERCIAL KITS FOR SITE-DIRECTED MUTAGENESIS**).

*Any sufficiently advanced technology is indistinguishable from magic.*

Arthur C. Clarke

# Protocol 1

---

## Preparation of Uracil-containing Single-stranded Bacteriophage M13 DNA

**T**HE CLASSIC KUNKEL METHOD OF OLIGONUCLEOTIDE-DIRECTED MUTAGENESIS takes advantage of the strong selection against uracil-substituted DNA exhibited by strains of *E. coli* that express uracil-DNA glycosylase (please see the information panel on **MUTAGENIC OLIGONUCLEOTIDES**). Template DNA is first prepared by growth of an appropriate recombinant bacteriophage M13 in a strain of *E. coli* that is *dut<sup>-</sup> ung<sup>-</sup>* F' (described in this protocol). The resulting uracil-containing single-stranded DNA is used as the template in a standard oligonucleotide-directed mutagenesis procedure to generate a heteroduplex molecule with uracil in the template strand and thymine in the strand synthesized in the *in vitro* reaction (Protocol 2). Transformation of this DNA into an *ung<sup>+</sup>* strain results in destruction of the template strand, with consequent suppression of the production of wild-type bacteriophages. A large proportion (up to 80%) of the progeny bacteriophages are therefore derived from replication of the transfected uracil-free (–) strand. Because the synthesis of this strand is primed by the mutagenic oligonucleotide, a high proportion of the progeny bacteriophages carry the desired mutation.

### MATERIALS

---

**CAUTION:** Please see Appendix 12 for appropriate handling of materials marked with <!.>.

#### Buffers and Solutions

Please see Appendix 1 for components of stock solutions, buffers, and reagents.  
Dilute stock solutions to the appropriate concentrations.

*Ethanol*

*NaCl (2.5 M) containing 15% polyethylene glycol (w/v, PEG 8000) <!.>*

*Phenol (pH 8.0) <!.>*

*Phenol:chloroform (1:1, v/v) <!.>*

*Sodium acetate (3 M, pH 5.2)*

*TE (pH 7.6)*

#### Gels

*Agarose gel*

Please see Step 16.

## Nucleic Acids and Oligonucleotides

Marker DNA, single-stranded DNA from the original bacteriophage M13 recombinant

## Media

2x YT medium

2x YT medium containing 0.25 µg/ml uridine

## Centrifuges and Rotors

Sorvall GSA rotor or equivalent

Sorvall SS-34 rotor or equivalent

## Special Equipment

Corex centrifuge tubes (15 ml and 30 ml)

Pasteur pipettes

Spun-column chromatography resin

Use a prepacked resin such as Sephacryl S-400 (Pharmacia) or Miniprep Spun Columns (Promega).

Water bath preset to 60°C

## Additional Reagents

Step 1 of this protocol requires the reagents listed in Chapter 3, Protocols 3, 4, and 6.

Step 6 of this protocol requires the reagents listed in Chapter 3, Protocol 1.

## Vectors and Bacterial Strains

Please see Appendix 3.

*E. coli* strain CJ236 (*dut*<sup>-</sup> *ung*<sup>-</sup> *F'*)

For details, please see Kunkel (1985) and Kunkel et al. (1987).

*E. coli* strain TG1, JM109, or equivalent

Please see Step 6.

## METHOD

---

1. Prepare for mutagenesis.
  - a. Clone a small fragment of DNA (<500 bp) carrying the target sequence into an appropriate bacteriophage M13 vector such as M13mp18 or mp19.
  - b. Isolate single-stranded template DNA and double-stranded replicative form DNA from a freshly grown plaque generated by the recombinant bacteriophage.

Methods for cloning into bacteriophage M13 vectors and for preparation of single-stranded and replicative form bacteriophage DNA are given in Chapter 3, Protocols 3, 4, and 6.
  - c. Check the fidelity of the recombinant clone by restriction mapping of the replicative form DNA and by DNA sequencing of the single-stranded DNA.

The Kunkel procedure can also be applied to produce uracil-substituted single-stranded DNAs generated from phagemid vectors (McClary et al. 1989; Wang et al. 1989; Liu et al. 1990; for review, please see Hagemeyer 1996). Here, the double-stranded phagemid DNA containing the target sequence is first used to transform *E. coli* CJ236 (or another strain of genotype *dut*<sup>-</sup> *ung*<sup>-</sup> *F'*) to ampicillin resistance. The resulting bacteria are superinfected with a helper bacteriophage to shift the replication mode of the phagemid DNA from the production of double-stranded DNA to single-stranded DNAs (please see Chapter 3, Protocol 8). Following growth in medium containing uridine, the single-stranded DNAs, which contain uracil residues in place of some of the thymine bases, are packaged into viral particles and



secreted into the growth medium. This DNA is then isolated (as described from Step 5 onward) and used as a template in site-directed mutagenesis (Protocol 2). The use of phagemid vectors circumvents the need to clone the starting target DNA into a bacteriophage M13 vector before site-directed mutagenesis.

2. Use a sterile Pasteur pipette to transfer a single plaque produced by the bacteriophage M13 recombinant to a microfuge tube containing 1 ml of 2× YT medium.
3. Incubate the tube for 5 minutes at 60°C to kill bacterial cells. (It is important to kill the bacterial cells to prevent them from continuing to produce thymidine-containing viral DNA during the next round of bacteriophage growth.) Vortex the tube vigorously for 30 seconds to release the bacteriophages trapped in the top agar. Remove dead bacterial cells and fragments of agar by centrifuging the tube at maximum speed for 2 minutes at 4°C in a microfuge.
4. Transfer 50 µl of the supernatant to a 500-ml flask containing 50 ml of 2× YT medium supplemented with 0.25 µg/ml uridine. There is no need to supplement the medium with thymidine or adenosine as originally described by Kunkel (1985). Add 5 ml of a mid-log-phase culture of *E. coli* strain CJ236 (*dut<sup>-</sup> ung<sup>-</sup> F'*). Incubate the culture with vigorous shaking (300 cycles/minute on a rotary shaker) for 6 hours at 37°C. Efficient aeration is crucial for efficient growth of bacteriophages.

The bacteriophage suspension used as an inoculum typically contains between  $10^9$  and  $10^{10}$  pfu/ml. A mid-log-phase culture of *E. coli* contains  $\sim 5 \times 10^8$  bacteria/ml. The low multiplicity of viral infection (0.02–0.2 pfu/cell) ensures that the vast majority of the bacteriophages recovered from the culture will have been generated in the *dut<sup>-</sup> ung<sup>-</sup> F'* strain of *E. coli*.

5. Pellet the cells by centrifugation at 5000g (6470 rpm in a Sorvall SS-34 rotor) for 30 minutes at 4°C. Transfer the supernatant to a fresh 250-ml centrifuge bottle that will fit into a Sorvall GSA rotor or equivalent.
6. Determine the relative titer of the bacteriophage suspension on *E. coli* strain CJ236 (*dut<sup>-</sup> ung<sup>-</sup> F'*) and a strain such as JM109 or TG1 (please see Chapter 3, Protocol 1). The titer on strain CJ236 should be four to five orders of magnitude greater than that on the *dut<sup>+</sup> ung<sup>+</sup>* strain of *E. coli*.

To save time, most investigators purify the bacteriophage particles before the results of the titration are available. However, if the purification is postponed, store the crude bacteriophage suspension in ice.

The yield of bacteriophages varies from recombinant to recombinant. Typically, the titer of virus particles in the supernatant, measured on a *dut<sup>-</sup> ung<sup>-</sup> F'* *E. coli* strain (CJ236), is  $5 \times 10^{10}$  to  $1 \times 10^{11}$  pfu/ml. However, poorly growing recombinants may attain titers of only  $1 \times 10^{10}$  to  $2 \times 10^{10}$  pfu/ml. If the yield of single-stranded DNA is inadequate, the following are two possible remedies:

- Measure the titer of the bacteriophage stock used to infect the *dut<sup>-</sup> ung<sup>-</sup> F'* strain of *E. coli*. Adjust the volume of the inoculum to achieve a multiplicity of infection of 0.1 pfu/bacterial cell. Grow the infected culture for 6 hours as described.
- Incubate the infected cultures for 12 hours rather than 6 hours. As discussed in Chapter 3, deleted variants may outgrow the original recombinant during extended periods of incubation, and thus it is advisable to verify that the majority of the single-stranded DNA used as template is of the correct size. Methods to analyze the size of bacteriophage M13 DNA by gel electrophoresis are described in Chapter 3, Protocol 7.

7. Measure the volume of the bacteriophage suspension, and then add 0.25 volume of 2.5 M of NaCl containing 15% (w/v) PEG 8000. Mix the contents of the centrifuge bottle by swirling, and store the bottle on ice for 1 hour.
8. Recover the precipitated bacteriophage particles by centrifugation at 5000g (5500 rpm in a Sorvall GSA rotor) for 20 minutes at 4°C. Remove the supernatant by aspiration, and then

invert the bottle to allow the last traces of supernatant to drain away. Use a pipette attached to a vacuum line to remove any drops of solution adhering to the walls of the bottle.

9. Resuspend the bacteriophage pellet in 4 ml of TE (pH 7.6). Transfer the suspension to a 15-ml Corex centrifuge tube, and wash the walls of the centrifuge bottle with another 2 ml of TE (pH 7.6). Transfer the washing to the Corex tube. Vortex the suspension vigorously for 30 seconds, and then store the tube on ice for 1 hour.
10. Vortex the suspension vigorously for 30 seconds, and then pellet the bacterial debris by centrifugation at 5000g (6470 rpm in a Sorvall SS-34 rotor) for 20 minutes at 4°C.
11. Taking care not to disturb the pellet of bacterial debris, transfer the supernatant to a 15-ml polypropylene tube. Extract the suspension twice with phenol (pH 8.0) and once with phenol:chloroform. Separate the phases by centrifugation at 4000g (5800 rpm in a Sorvall SS-34 rotor) for 5 minutes at room temperature. Avoid transferring material from the interface.
12. Transfer the aqueous phase from the final extraction to a glass centrifuge tube (e.g., a 30-ml Corex tube). Measure the volume of the solution, and add 0.1 volume of 3 M of sodium acetate (pH 5.2), followed by 2 volumes of ethanol at 0°C. Mix the contents of the tube thoroughly, and then store the tube on ice for 30 minutes.
13. Recover the DNA by centrifugation at 5000g (6470 rpm in a Sorvall SS-34 rotor) for 20 minutes at 4°C. Carefully remove the supernatant. Add 10 ml of 70% ethanol at room temperature, vortex the solution briefly, and recentrifuge.
14. Carefully remove the supernatant by aspiration and store the tube in an inverted position at room temperature until the last traces of ethanol have evaporated. Dissolve the DNA in 200  $\mu$ l of TE (pH 7.6).
15. Purify the resuspended single-stranded uracil-containing bacteriophage M13 DNA by spun-column chromatography using columns that exclude large DNAs (>100 nucleotides) as described in Appendix 8.

The single-stranded bacteriophage M13 DNA that has been propagated in the *dut<sup>-</sup> ung<sup>-</sup> F'* strain of *E. coli* is purified by spun-column chromatography to remove contaminating small DNA and RNA oligonucleotides. These nonspecific oligonucleotides can act as primers in subsequent mutagenesis reactions, causing a high background of false positive plaques.
16. Measure the DNA spectrophotometrically at 260 nm (1 OD<sub>260</sub> = 40  $\mu$ g/ml) (for details on quantitating DNA, please see Appendix 8). Analyze the size of an aliquot of the DNA (0.5  $\mu$ g) by gel electrophoresis, using single-stranded DNA of the original bacteriophage M13 recombinant (Step 1) as a size marker.
17. Carry out oligonucleotide-directed mutagenesis as described in Protocol 2.

# Protocol 2

---

## Oligonucleotide-directed Mutagenesis of Single-stranded DNA

**T**HIS CLASSIC PROTOCOL COMBINES THE DOUBLE-PRIMER TECHNIQUE of Zoller and Smith (1984, 1987) and the Kunkel (1985) method of enriching the yield of mutants (please see the information panel on **SELECTING AGAINST WILD-TYPE DNA IN SITE-DIRECTED MUTAGENESIS**). The single-stranded DNA templates used in the protocol contain a higher than normal number of uracil residues because they are prepared from M13 bacteriophages grown in a strain of *E. coli* that carries mutations in the *ung* and *dut* genes (please see Protocol 1).

---

### MATERIALS

---

#### Buffers and Solutions

Please see Appendix 1 for components of stock solutions, buffers, and reagents. Dilute stock solutions to the appropriate concentrations.

*ATP (10 mM)*

*10x PE1 buffer*

200 mM Tris-Cl (pH 7.5)

100 mM MgCl<sub>2</sub>

500 mM NaCl

10 mM dithiothreitol

*10x PE2 buffer*

200 mM Tris-Cl (pH 7.5)

100 mM MgCl<sub>2</sub>

100 mM dithiothreitol

#### Enzymes and Buffers

*Bacteriophage T4 DNA ligase*

*Bacteriophage T4 polynucleotide kinase*

*Klenow fragment of E. coli DNA polymerase I*

Any of several different DNA polymerases may be used in the extension reaction (Steps 4 and 5). The Klenow fragment lacks 5' exonucleolytic activity and is therefore incapable of degrading the template. However, other enzymes, such as bacteriophage T4 DNA polymerase (Nossal 1974; Geisselsoder et al. 1987), native T7 DNA polymerase (Bebenek and Kunkel 1989), and Sequenase (Schena 1989; Venkitaraman 1989) require shorter incubation times. These enzymes are obligatory when a phospho-

rylated mutagenic oligonucleotide is used as the single primer in the polymerization/extension reaction. Unlike the Klenow fragment, neither Sequenase nor the native DNA polymerases encoded by bacteriophages T4 and T7 are able to displace the mutagenic oligonucleotide from its template (Nossal 1974; Kunkel 1985; Bebenek and Kunkel 1989; Schemm 1989).

## Nucleic Acids and Oligonucleotides

### *Bacteriophage M13 universal sequencing primer*

Any commercially available universal primer used to prime dideoxy sequencing reactions from (+) strand bacteriophage M13 templates will work well in this protocol.

### *dNTP solution containing all four dNTPs, each at 2 mM*

Use dNTPs of the highest quality to minimize the possibility that contaminating dUTP will be incorporated into the newly synthesized strand of DNA. The concentrated dNTP solutions sold by Pharmacia have worked well in our hands.

### *Mutagenic bacteriophage M13 single-stranded DNA template*

#### *Mutagenic oligonucleotide primer*

The mutagenic oligonucleotide should be designed as outlined in the information panel on **MUTAGENIC OLIGONUCLEOTIDES**. Before use in site-directed mutagenesis, purify the mutagenic oligonucleotide by Sep-Pak C<sub>18</sub> column chromatography to remove salts and other impurities (please see Chapter 10, Protocol 6). It is not necessary to purify the oligonucleotide by polyacrylamide gel electrophoresis unless the oligonucleotide is more than 30 nucleotides in length or is to be used for "loop-in" or "loop-out" mutagenesis.

## Media

*2x YT top agar and YT agar plates*

## Special Equipment

*Falcon 2059 tubes (chilled) or Electroporation cuvettes*

*Heat block or water bath preset to 47°C*

*Water baths preset to 16°C, 42°C, and 68°C*

*Water bath preset to the appropriate denaturation temperature*

Please see Step 3. Alternatively, a thermal cycler can be used for this step.

## Additional Reagents

*Step 1 of this protocol requires the reagents listed in Protocol 1 of this chapter.*

*Step 7 of this protocol requires the reagents listed in Chapter 12, Protocol 3 or 4.*

*Step 7 of this protocol may require the reagents listed in Protocol 7 of this chapter.*

## Vectors and Bacterial Strains

*Please see Appendix 3.*

*E. coli strain suitable for transformation (e.g., TG1)*

*E. coli strain TG1, competent for transformation*

Prepare competent cells as described in Chapter 1, Protocol 25 or 26.

*E. coli strain TG1, overnight culture*

## METHOD

---

1. Prepare the single-stranded bacteriophage M13 template as described in Protocol 1. Purify the uracil-containing template by spun-column chromatography.
2. Phosphorylate the mutagenic oligonucleotide and the universal sequencing primer with bacteriophage T4 polynucleotide kinase. In separate microfuge tubes mix:

synthetic oligonucleotide	100–200 pmoles
10x bacteriophage T4 polynucleotide kinase buffer	2 $\mu$ l
10 mM ATP	1 $\mu$ l
bacteriophage T4 polynucleotide kinase	4 units
H <sub>2</sub> O	to 20 $\mu$ l

Incubate the reactions for 1 hour at 37°C and then heat them for 10 minutes at 68°C to inactivate the polynucleotide kinase.

3. Anneal the phosphorylated mutagenic oligonucleotide and universal sequencing primer to the single-stranded bacteriophage M13 DNA containing the target sequence. Mix:

single-stranded template DNA (~1 $\mu$ g)	0.5 pmole
phosphorylated mutagenic oligonucleotide	10 pmoles
phosphorylated universal primer	10 pmoles
10x PE1 buffer	1 $\mu$ l
H <sub>2</sub> O	to 10 $\mu$ l

Heat the mixture for 5 minutes to 20°C above the theoretical  $T_m$  of a perfect hybrid formed by the mutagenic oligonucleotide, calculated from the formula  $T_m = 4(G+C) + 2(A+T)$ , where (G+C) = the sum of G and C residues in the oligonucleotide and where (A+T) = the sum of the A and T residues in the oligonucleotide. Transfer the tube containing the reaction mixture to a beaker containing H<sub>2</sub>O at 20°C above the  $T_m$ . Stand the beaker on the bench, and allow the reaction to cool slowly to room temperature (~20 minutes). Centrifuge the tube briefly (5 seconds) in a microfuge to collect any fluid that has condensed on the walls of the tube.

Alternatively, heat and cool the nucleic acids and oligonucleotides in a thermal cycler.

The molar ratio of primer to template should be between 10:1 and 50:1. Using more primer will increase the frequency of mutation at ectopic sites in the target DNA.

4. While the annealing reaction cools to room temperature, mix the following reagents in a fresh 0.5-ml microfuge tube:

10x PE2 buffer	1.0 $\mu$ l
2 mM dNTP solution	1.0 $\mu$ l
10 mM ATP	1.0 $\mu$ l
bacteriophage T4 DNA ligase	5 Weiss units
Klenow fragment	2.5 units
H <sub>2</sub> O	to 10 $\mu$ l

Store the mixture on ice until needed.

When using bacteriophage T4 DNA polymerase or Sequenase, incubate the polymerization/extension reaction (Step 5) for 5 minutes at 0°C, 5 minutes at room temperature, and then 2 hours at 37°C. Incubation at low temperature optimizes initiation of DNA synthesis from the 3' terminus, and the subsequent incubation at 37°C improves the efficiency of the extension reaction. In addition, the concentration of each of the four dNTPs in the reaction should be increased to 500  $\mu$ M. This increase enhances the efficiency of the extension reaction and suppresses the strong 3' exonuclease activity of bacteriophage T4 DNA polymerase.

5. Add 10  $\mu$ l of the ice-cold reaction mixture from Step 4 to the reaction mixture containing single-stranded DNA and annealed oligonucleotides (Step 3). Incubate the final reaction mixture for 6–15 hours at 16°C.

6. Transfect competent *E. coli* of an appropriate host strain (e.g., TG1) as follows:
- Prepare a series of dilutions of the reaction mixture (1:10, 1:100, and 1:500) in 10 mM Tris-Cl (pH 7.6).
  - To a series of chilled (0°C) Falcon 2059 tubes, transfer 1  $\mu$ l and 5  $\mu$ l of (i) the original reaction mixture and (ii) each dilution. Add 200  $\mu$ l of a preparation of competent TG1 cells to each tube.
  - Store the mixtures on ice for 30 minutes, and then transfer them for exactly 2 minutes to a water bath equilibrated at 42°C.
  - Remove the transfected cultures from the water bath, and add 100  $\mu$ l of a standard overnight culture of TG1 cells. The addition of cells makes it easier to see bacteriophage M13 plaques in the lawn of bacterial cells.
 

There is no need to add TG1 cells if freshly prepared, rather than frozen, competent bacterial cells are used in Step b.
  - Add 2.5 ml of 2x YT top agar (melted and cooled to 47°C) to each tube, and plate the resulting mixtures on separate YT agar plates. Incubate the plates for 12–16 hours at 37°C to allow plaques to form.

The mutated DNA can also be introduced into *E. coli* by electroporation. Because the frequency of transfection is in general much higher with electroporation, an aliquot of the mutagenesis reaction should first be diluted 1/100, 1/500, 1/1000, and 1/10,000 in H<sub>2</sub>O before electroporation of 1–10  $\mu$ l of the diluted mixtures.

If single-stranded DNA derived from a phagemid such as pUC118 or pUC119 is used as the template for mutagenesis, use 1- $\mu$ l and 5- $\mu$ l aliquots of the undiluted reaction mixture to transform competent cultures of an *E. coli* strain suitable for phagemid propagation (for a description of this strain, please see Chapter 3, Protocol 8; for a description of the transformation method, please see Chapter 1). Plate 50- $\mu$ l and 100- $\mu$ l aliquots of each transformation mixture onto LB agar plates containing 50  $\mu$ g/ml ampicillin. Ampicillin-resistant colonies should appear after 18–24 hours of incubation at 37°C. Screen the transformed colonies as described in Protocol 7.

7. Screen plaques by sequencing preparations of single-stranded bacteriophage DNA (please see Chapter 12, Protocol 3 or 4). If necessary, the plaques can be screened by hybridization with a radiolabeled oligonucleotide probe to detect mutants that arise at a low frequency (Protocol 7).

#### TROUBLESHOOTING

If plaques obtained after transfection do not contain the desired DNA sequence:

- Purify the mutagenic oligonucleotide by polyacrylamide gel electrophoresis before carrying out the mutagenesis protocol.
- Repurify the bacteriophage M13 template by spun-column chromatography as described in Appendix 8. Use a resin (e.g., Sephacryl S-400) that excludes high-molecular-weight DNAs.
- Test the mutagenic oligonucleotide for its ability to prime DNA synthesis at the appropriate location on the single-stranded template DNA (Zoller and Smith 1987). Use a universal sequencing primer as a positive control. If priming occurs from more than one site, synthesize a longer mutagenic oligonucleotide that binds specifically to the template DNA. Use a shorter oligonucleotide as a hybridization probe to screen for the desired mutant as described in Protocol 7. If priming by the mutagenic oligonucleotide is inefficient, resynthesize the oligonucleotide and purify it by polyacrylamide gel electrophoresis.

# Protocol 3

---

## In Vitro Mutagenesis Using Double-stranded DNA Templates: Selection of Mutants with *DpnI*

**I**N BOTH THIS PROTOCOL AND PROTOCOL 4, TWO OLIGONUCLEOTIDES are used to prime DNA synthesis by a high-fidelity polymerase on a denatured plasmid template. The two oligonucleotides both contain the desired mutation and have the same starting and ending positions on opposite strands of the plasmid DNA. In this protocol, the entire lengths of both strands of the plasmid DNA are amplified in a linear fashion during several rounds of thermal cycling, generating a mutated plasmid containing staggered nicks on opposite strands (Hemsley et al. 1989).

Because of the amount of template DNA used in the amplification reaction, the background of transformed colonies containing wild-type plasmid DNA can be quite high unless steps are taken to enrich for mutant molecules. In this protocol, the products of the linear amplification reaction are treated with the restriction enzyme *DpnI*, which specifically cleaves fully methylated G<sup>Me</sup>ATC sequences (Vovis and Lacks 1977). *DpnI* will therefore digest the bacterially generated DNA used as template for amplification, but it will not digest DNA synthesized during the course of the reaction in vitro (please see the information panel on *N*<sup>6</sup>-METHYLADENINE, DAM METHYLASE AND METHYLATION-SENSITIVE RESTRICTION ENZYMES). *DpnI*-resistant molecules, which are rich in the desired mutants, are recovered by transforming *E. coli* to antibiotic resistance. Depending on the complexity of the mutation, and the length of the template DNA, between 15% and 80% of the transformed colonies will contain plasmids with the desired mutation (Weiner et al. 1994). Because the method works well with virtually any plasmid of moderate size (<7 kb), it can be used to introduce mutations directly into full-length cDNAs and eliminates the need for subcloning into specialized vectors.

The key to success with this method, which is often called circular mutagenesis, lies in the design of the primers and the choice of the appropriate thermostable DNA polymerase.

### DESIGN OF PRIMERS

---

The two oligonucleotide primers:

- **Must anneal to the complementary strands** of the same target sequence.
- **Must be of equal length** (between 25 and 45 bp), with a calculated melting temperature of 78°C or greater. The  $T_m$  should be high enough to suppress false priming and low enough to allow complete dissociation of primer-primer hybrids during the denaturation step of the amplification reaction.

- **Should terminate in a G or C residue.**
- **Need not be phosphorylated.** This is because *Pfu*, the thermostable DNA polymerase most commonly used to catalyze the amplification reaction, is unable to displace oligonucleotides hybridized to their target sequence, whether or not the oligonucleotides are phosphorylated.
- **Can generally be used without purification.** However, higher efficiencies of mutation, especially with insertions and deletions, are obtained if the primers are purified by either fast-performance liquid chromatography (FPLC) or polyacrylamide gel electrophoresis (PAGE).

When a point mutation is to be introduced, one primer carries a wild-type sequence, whereas the other primer carries the desired mutation and has a minimum of 12 bases of correct sequence on each side of the centrally placed mutation. If a deletion is to be introduced, the two primers may both have a wild-type sequence, but they are spaced a distance apart on the template that corresponds to the length of the deletion. Insertion mutations require one primer of wild-type sequence and one with the sequence to be inserted located at its 5' terminus.

## THERMOSTABLE DNA POLYMERASE

---

Three properties are required of thermostable DNA polymerases used for mutagenesis of denatured plasmid templates:

- an efficient proofreading activity
- a low rate of incorporation of mismatched bases
- a lack of untemplated terminal transferase activity

*Taq* does not fulfill these criteria and is therefore entirely unsuitable for site-directed mutagenesis (Stemmer and Morris 1992; Watkins et al. 1993). However, a 160:1 mixture of Klentaq (AB Peptides) and *Pfu* polymerase (Stratagene) has the appropriate set of properties. A typical mixture contains 0.187 unit of *Pfu* and 33.7 units of Klentaq1 in a total volume of 1.2  $\mu$ l. Examples of commercially available mixtures include TaqPlus from Stratagene and the Expand High Fidelity PCR System from Boehringer Mannheim.

Single thermostable DNA polymerases that have been used successfully in circular PCR include *Pwo* DNA polymerase (Hidajat and McNicol 1997), *rTth* DNA polymerase XL (Du et al. 1995; Gatlin et al. 1995), *VentR* DNA polymerase (Hughes and Andrews 1996), and *Pfu* DNA polymerase (please see below). These polymerases have one major disadvantage: Relatively high concentrations of oligonucleotide primers are required (1) to counteract the effects of degradation by 3'-5' exonuclease activity and (2) to ensure that the primers are in vast molar excess (50–100-fold) over the template DNA (please see Chapter 8, Table 8-1). Unfortunately, such high concentrations favor the formation of hybrids between the two complementary oligonucleotide primers, thereby reducing the efficiency of the amplification reaction. Because of the consequent uncertainty about the effective concentration of primers, some investigators carry out preliminary experiments to optimize the components of the amplification reaction. Typically, these experiments use agarose gel electrophoresis to measure the yield of linear full-length DNA synthesized in amplification reactions containing a constant amount of template DNA (usually 50 ng) and a range of primer concentrations (e.g., please see Parikh and Guengerich 1998). However, in our hands, optimization of primers is unnecessary unless the mutations are complex (more than three single-base changes; deletion or insertion of more than two nucleotides).



When using single thermostable DNA polymerases, additional steps may be taken to further minimize the chance of unwanted mutants accumulating during amplification:

- The initial concentrations of dNTPs and  $Mg^{2+}$  in the reaction mixture must not exceed 250  $\mu M$  and 1.5 mM, respectively.
- Because thermostable DNA polymerases such as *Pfu* and *Pwo* require a more alkaline buffer than *Taq*, the pH of the Tris-buffered reaction mixture should be 8.9 (measured at 25°C).
- The number of cycles of linear amplification must be kept to a bare minimum (please see Step 6 of this protocol), even if this constraint means using relatively large amounts of template DNA in the reaction mixture.

Commercially available kits for circular mutagenesis include QuikChange (Stratagene), which has a plasmid DNA template and mutagenic primers that can be used as a positive control. The kit is therefore especially useful for investigators who are using circular mutagenesis for the first time.

## MATERIALS

**CAUTION:** Please see Appendix 12 for appropriate handling of materials marked with <!>.

### Buffers and Solutions

Please see Appendix 1 for components of stock solutions, buffers, and reagents. Dilute stock solutions to the appropriate concentrations.

*ATP (10 mM)*

*dNTP solution containing all four dNTPs, each at 5 mM*

*10x Long PCR buffer (when using mixtures of DNA polymerases)*

500 mM Tris-Cl (pH 9.0 at room temperature)

160 mM ammonium sulfate

25 mM  $MgCl_2$

1.5 mg/ml bovine serum albumin

Buffers supplied by the manufacturer and suitable for use with thermostable DNA polymerases may be used in place of the above buffers.

or

*10x Mutagenesis buffer (when using DNA polymerases such as Pfu)*

100 mM KCl

100 mM ammonium sulfate

200 mM Tris (pH 8.9 at room temperature)

20 mM  $MgSO_4$

1% Triton X-100

1 mg/ml nuclease-free bovine serum albumin

*NaOH (1 M)/EDTA (1 mM) (optional) <!>*

*Sodium acetate (3 M, pH 4.8) (optional)*

This solution is used as a neutralizing agent and therefore has a slightly lower pH than most sodium acetate solutions used in molecular cloning.

*TE (pH 8.0)*

### Enzymes and Buffers

*Bacteriophage T4 DNA ligase (optional)*

*Bacteriophage T4 polynucleotide kinase (optional)*

*DpnI restriction endonuclease*

*Thermostable DNA polymerase (e.g., Pfu DNA polymerase)*

The conditions described in this protocol are optimized for *PfuTurbo* DNA polymerase. However, they are easily adapted for use with other thermostable polymerases or mixtures of polymerases. *Pfu* is avail-

able from Stratagene in three forms: the native enzyme, a recombinant enzyme expressed from a cloned version of the *Pfu* gene, and a preparation *Pfu*Turbo which is a formulation of recombinant *Pfu* DNA polymerase and a novel thermostability factor whose nature is undisclosed but which is said to enhance the yield of amplified product without altering the fidelity of DNA replication. The manufacturer claims that *Pfu*Turbo DNA polymerase is able to amplify DNAs 15 kb in length. In our hands, however, the efficiency of amplification decreases when the length of double-stranded plasmid DNA exceeds 7–8 kb.

## Gels

*Agarose gel (1%) containing 0.5 µg/ml ethidium bromide <1>*

Please see Step 8.

## Nucleic Acids and Oligonucleotides

### *Oligonucleotide primers*

For advice on the design of oligonucleotide primers, please see the introduction to this protocol and the information panel on **MUTAGENIC OLIGONUCLEOTIDES**. The best results are achieved if the oligonucleotide primers are purified by FPLC or PAGE to reduce the level of contamination with salts (please see Chapter 10, Protocol 1 or 5). The purified primers are dissolved in H<sub>2</sub>O at a concentration of 20 mM.

### *Plasmid DNA*

The template DNA used for mutagenesis is a circular plasmid containing the gene or cDNA of interest. In general, the shorter the plasmid, the more efficient the amplification of the target DNA. Plasmids with a total length of <7 kb work well; however, success has been achieved with plasmid templates up to 11.5 kb in length (Gatlin et al. 1995). The plasmid DNA should be dissolved at 1 µg/ml in 1 mM Tris-Cl (pH 7.6) containing a low concentration of EDTA (<0.1 mM).

## Special Equipment

*Barrier tips for automatic micropipettes*

*Microfuge tubes (0.5 ml, thin-walled for amplification) or Microtiter plates*

*Positive-displacement pipette*

*Thermal cycler programmed with desired amplification protocol*

If the thermal cycler is not equipped with a heated lid, use either mineral oil or paraffin wax to prevent evaporation of liquid from the reaction mixture during PCR.

## Additional Reagents

*Step 14 of this protocol requires the reagents listed in Chapter 1, Protocol 23.*

*Step 15 of this protocol requires the reagents listed in Chapter 1, Protocol 1.*

*Step 16 of this protocol requires the reagents listed in Chapter 12, Protocol 3, 4, or 5.*

## Vectors and Bacterial Strains

*Please see Appendix 3.*

*Competent E. coli strain with an hsdR17 genotype (e.g., XL1-Blue, XL2-Blue MRF', or DH5α)*

## METHOD

---

### Amplification of the Target DNA with Mutagenic Primers

Steps 1 and 2 are optional (please see note after Step 3).

1. Denature the plasmid DNA template in a reaction containing 1–10 µg of plasmid DNA dissolved in 40 µl of H<sub>2</sub>O plus 10 µl of 1 M NaOH/1 mM EDTA. Incubate the DNA in the denaturing solution for 15 minutes at 37°C.
2. Add 5 µl of 3 M sodium acetate (pH 4.8) to neutralize the solution. Precipitate the DNA with 150 µl of ice-cold ethanol.

3. Collect the denatured plasmid DNA by centrifugation for 10 minutes at 4°C in a microfuge. Carefully decant the ethanolic supernatant and rinse the pellet with 150 µl of 70% ethanol. Recentrifuge for 2 minutes, decant the supernatant, and allow the last traces of ethanol to evaporate at room temperature. Resuspend the DNA in 20 µl of H<sub>2</sub>O.

In theory, there is no need to denature the plasmid DNA before it is used as a template in PCR. If the alkaline denaturation step is omitted, superhelical, native double-stranded DNA will be denatured by heating to 94°C in the first cycle of PCR. So why bother with Steps 1 and 2? The answer probably lies in the state of the plasmid DNA after prolonged denaturation in alkali. During exposure to 0.2 N NaOH, the plasmid DNA collapses into a dense, irreversibly denatured coil that can serve as a template in PCR but has little ability to transform bacteria. The background of colonies containing unmutated wild-type DNA is therefore markedly reduced (Du et al. 1995; Dorrell et al. 1996). By contrast, brief exposure to 95°C in the first cycle of PCR disrupts Watson-Crick base pairs but does not necessarily destroy the transforming capacity of the plasmid molecules. A higher proportion of the transformed colonies will therefore contain unmutated, parental, plasmid molecules. The value of alkaline denaturation does not become apparent until the end of the experiment when the investigator is faced with the task of sifting through colonies to identify those that contain mutated DNA. If the efficiency of mutagenesis is low and the selection by *DpnI* inefficient, the proportion of colonies containing wild-type molecules may be unacceptably high.

4. In sterile 0.5-ml microfuge tubes, set up a series of reaction mixtures containing different amounts (e.g., 5, 10, 25, and 50 ng) of plasmid DNA and a constant amount of each of the two oligonucleotide primers.

10x mutagenesis buffer	5 µl
template plasmid DNA	5–50 ng
oligonucleotide primer 1 (20 mM)	2.5 µl
oligonucleotide primer 2 (20 mM)	2.5 µl
dNTP mix	2.5 µl
H <sub>2</sub> O	to 50 µl

Add 2.5 units of *PfuTurbo* DNA polymerase.

It is important to add the reagents in the order shown to reduce the opportunity for the 3'-5' exonuclease activity of *PfuTurbo* to degrade the primers.

5. If the thermal cycler is not fitted with a heated lid, overlay the reaction mixtures with 1 drop (~50 µl) of light mineral oil or a bead of paraffin wax to prevent evaporation of the samples during repeated cycles of heating and cooling. Place the tubes in the thermal cycler.
6. Amplify the nucleic acids using the denaturation, annealing, and polymerization times and temperatures listed in the table.

Cycle Number	Denaturation	Annealing	Polymerization
1 cycle	1 min at 95°C		
2–18 cycles <sup>a</sup>	30 sec at 95°C	1 min at 55°C	2 min/kb of plasmid DNA at 68°C
Last cycle	1 min at 94°C	1 min at 55°C	10 min at 72°C

These times are suitable for 50-µl reactions assembled in thin-walled 0.5-ml tubes and incubated in thermal cyclers such as the Perkin-Elmer 9600 or 9700, Master Cycler (Eppendorf), and PTC 100 (MJ Research). Times and temperatures may need to be adapted to suit other types of equipment and reaction volumes.

<sup>a</sup>For single-base substitutions, use 12 cycles of linear amplification; for substitution of one amino acid with another (usually two or three contiguous base substitutions), use 16 cycles; for insertions and deletions of any size, use 18 cycles.

The rate of DNA synthesis is 1.5–2.0 times slower in amplification reactions catalyzed by *Pfu* than in reactions catalyzed by *Taq*.

A small number of cycles is used together with a large amount of starting template to reduce the introduction of spurious mutations during amplification of the plasmid DNA and gene/cDNA.

7. After amplification of the DNA, place the reactions on ice.
8. Verify that the target DNA was amplified by analyzing 10  $\mu$ l of each reaction by electrophoresis through a 1% agarose gel containing 0.5  $\mu$ g/ml ethidium bromide. As standards, load 50 ng of unamplified linearized plasmid DNA and a 1-kb DNA ladder into the outer lanes of the gel.

If the efficiency of amplification is low, set up a series of reactions to optimize the components of the amplification reaction and the cycling parameters.

### Ligation and Transformation of Amplified Product

Steps 9–12 are optional and are generally used only when the efficiency of mutagenesis is expected to be low (e.g., when constructing insertions and deletions).

9. Extract the amplified DNAs twice with phenol:chloroform and precipitate with ethanol.
10. Resuspend the DNA pellets in the following:

10x bacteriophage T4 polynucleotide kinase buffer	5 $\mu$ l
10 mM ATP	5 $\mu$ l
bacteriophage T4 polynucleotide kinase	5 units
H <sub>2</sub> O	to 50 $\mu$ l

Incubate the reactions for 1 hour at 37°C. Inactivate the kinase enzyme by heating at 68°C for 10 minutes. Extract the phosphorylated DNAs twice with phenol:chloroform and collect the DNAs by ethanol precipitation.

11. Resuspend the pellets of phosphorylated DNA (~0.9  $\mu$ g each) in 90  $\mu$ l of TE. Set up a series of ligation reactions containing the phosphorylated DNAs at concentrations ranging from 0.1 to 1  $\mu$ g/ml.

phosphorylated DNA	(10 ng to 100 ng)
10x bacteriophage T4 DNA ligase buffer	10 $\mu$ l
10 mM ATP	10 $\mu$ l
bacteriophage T4 DNA ligase	4 units
H <sub>2</sub> O	to 100 $\mu$ l

Incubate the reactions for 12–16 hours at 16°C.

If the 10x bacteriophage T4 ligase buffer supplied by the manufacturer contains ATP, omit the ATP in the above ligation reactions.

Conditions that favor the formation of monomeric circles during ligation are well understood in theory (Collins and Weissman 1984) but are difficult to achieve in practice. The molar concentration of DNA ends must be low in order to favor the formation of intramolecular circles over concatamers. However, it is difficult to calculate an appropriate concentration when working with amplified DNAs generated by inverse PCR because the proportion of full-length products with undamaged termini is unknown.

12. Extract the ligated DNAs twice with phenol:chloroform and collect the DNA by ethanol precipitation. Resuspend each pellet in 45  $\mu$ l of H<sub>2</sub>O. Add 5  $\mu$ l of 10x *DpnI* buffer to each tube.
13. Digest the amplified DNAs by adding 10 units of *DpnI* directly to the remainder of the amplification reactions (Step 7) or to the phosphorylated and ligated DNAs (Step 12). Mix the reagents by pipetting the solution up and down several times, centrifuge the tubes for 5 seconds in a microfuge, and then incubate them for 1 hour at 37°C.

If temperature cycling was carried out in the presence of mineral oil or wax, it is important to ensure that the *DpnI* is added to the aqueous portion of the reaction mixture. Use barrier micropipette tips and be sure to insert the end of the tip below the mineral oil or wax overlay.

14. Transform competent *E. coli* with 1, 2, and 5  $\mu$ l of digested DNA according to the procedure described in Chapter 1, Protocol 23.

Make sure that no mineral oil is transferred from the digestion mixture to the competent cells.

The use of ultracompetent XL2-Blue MRF<sup>+</sup> *E. coli* (Stratagene) and a modified transformation procedure have been reported to facilitate the recovery of mutants (Dorrell et al. 1996). However, in our hands, homemade preparations of highly competent *E. coli* are adequate for most forms of circular mutagenesis.

15. Prepare plasmid DNA from at least 12 independent transformants. Screen the DNA preparations for mutations by DNA sequencing, by oligonucleotide hybridization (see Protocol 7), or by restriction digestion of small preparations of plasmid DNA if a site was created or destroyed by the introduced mutation, or if an insertion or deletion was introduced into the template.
16. Sequence the entire segment of target DNA to verify that the desired mutation has been generated and that no spurious mutations occurred during amplification (please see Chapter 12, Protocol 3, 4, or 5).

#### TROUBLESHOOTING

- If none of the plasmids prepared in Step 15 carry the desired mutation, the entire population of transformants can be screened by oligonucleotide hybridization to identify rare colonies that carry the desired mutation.
- If the amplification reactions have worked well but the yield of mutants is poor, *DpnI* is the likely culprit. Set up a series of reactions to check that the enzyme is capable of digesting 50 ng of parental plasmid to completion in 1x *Pfu* reaction buffer. If necessary, adjust the amount of *DpnI* used and the time of the digestion.
- If digestion with *DpnI* is working efficiently, consider using two-stage amplification reactions (Wang and Malcolm 1999). In the first stage, two separate asymmetric amplification reactions are set up, each containing just one of the two oligonucleotide primers. The products of these reactions are single-stranded DNAs that can serve as templates for the second-stage linear amplification, which is carried out with both oligonucleotides, essentially as described above. The goal of the first-stage reaction is to generate templates to which the mutagenic primers can bind perfectly, without competition from a wild-type duplex.

# Protocol 4

---

## Oligonucleotide-directed Mutagenesis by Elimination of a Unique Restriction Site (USE Mutagenesis)

**I**N THIS METHOD, TWO OLIGONUCLEOTIDE PRIMERS ARE HYBRIDIZED to the same strand of a denatured double-stranded recombinant plasmid. One primer (the mutagenic primer) introduces the desired mutation into the target sequences, whereas the second primer carries a mutation that destroys a unique restriction site in the plasmid. Both primers are elongated in a reaction catalyzed by bacteriophage T4 or T7 DNA polymerase. Nicks in the strand of newly synthesized DNA are sealed with bacteriophage T4 DNA ligase. The product of the first part of the method is a heteroduplex plasmid consisting of a wild-type parental strand and a new full-length strand that carries the desired mutation but no longer contains the unique restriction site. The population of plasmids therefore consists (1) of wild-type molecules that, for one reason or another, were never used as templates for DNA synthesis primed by the two oligonucleotide primers and (2) of heteroduplex molecules that have lost the unique restriction site and gained the desired mutation.

In the second phase of the method, the mixed population is incubated with the restriction enzyme that cleaves the unique site. The wild-type molecules are linearized and the mutated plasmids are resistant to digestion. The mixture of circular heteroduplex DNA and linear wild-type DNA is then used to transform a strain of *E. coli* that is deficient in repair of mismatched bases. Because linear DNA transforms 10–1000-fold less efficiently than circular DNA (Conley and Saunders 1984), many of the wild-type molecules are unable to reestablish themselves in *E. coli*. The circular heteroduplex molecules, however, begin to replicate. Because the mismatched bases are not repaired, the first round of replication generates a wild-type plasmid that carries the original restriction site and a mutated plasmid that does not. DNA from the first set of transformants is recovered, digested once more with the same restriction enzyme to linearize the wild-type molecules, and then used to transform a standard laboratory strain of *E. coli*. This biochemical selection can be sufficiently powerful to ensure that a high proportion of the resulting transformants carry the desired mutation (Deng and Nickoloff 1992; Zhu 1996). The theoretical maximum yield of mutants in the standard form of USE (unique site elimination) described in this protocol is 50%. However, in most laboratories, the frequency with which mutant plasmids are recovered varies between 5% and 30%, depending on the complexity of the mutation and the efficiency of cleavage with the restriction enzyme. If necessary, the rate of mutant recovery can be improved significantly by combining USE with the Kunkel method of selection against uracil-containing template DNAs (Markvardsen et al. 1995) or by increasing the concentration of the mutagenic primer to 10:1 in favor of the mutagenic primer.

With the USE method, a gene may, in principle, be mutated in any double-stranded circular vector provided the vector contains a unique restriction site and a selectable marker (e.g., a gene conferring antibiotic resistance). Several companies sell selection primers and kits containing a range of the components required for USE mutagenesis (Chameleon Double-stranded Site-directed Mutagenesis kit marketed by Stratagene; Transformer sold by CLONTECH, and the USE mutagenesis kit sold by Pharmacia). These kits can be used successfully with many of the commonly used vectors; however, please see the panel on **TROUBLESHOOTING** at the end of this protocol.

## MATERIALS

**CAUTION:** Please see Appendix 12 for appropriate handling of materials marked with <!>.

### Buffers and Solutions

Please see Appendix 1 for components of stock solutions, buffers, and reagents. Dilute stock solutions to the appropriate concentrations.

*10x Annealing buffer*

200 mM Tris-Cl (pH 7.5)  
100 mM MgCl<sub>2</sub>  
500 mM NaCl

*10x Synthesis buffer*

100 mM Tris-Cl (pH 7.5)  
dTTP, dATP, dCTP, and dGTP, each at a concentration of 5 mM  
10 mM ATP  
20 mM dithiothreitol

### Enzymes and Buffers

*Bacteriophage T4 DNA ligase*

*Bacteriophage T4 DNA polymerase or Sequenase*

The native DNA polymerase encoded by bacteriophage T4 is unable to displace the oligonucleotide primers from the template DNA (Nossal 1974; Kunkel 1985; Bebenek and Kunkel 1989; Schena 1989).

*Unique site restriction endonuclease*

### Gels

*Agarose gel (1%) containing 0.5 µg/ml ethidium bromide <!>*

### Nucleic Acids and Oligonucleotides

*Mutagenic primer*

*Selection primer*

Both mutagenic and selection primers must anneal to the same strand of the target DNA, and the 5' end of each primer must be phosphorylated. The mutagenic primer should be designed as described in the information panel on **MUTAGENIC OLIGONUCLEOTIDES**, with the engineered mutations in the middle flanked on each side by 10–15 bases that pair perfectly with the template DNA. The oligonucleotide primers should be purified by FPLC or PAGE before use (please see Chapter 10, Protocol 1 or 5).

Several companies (CLONTECH, Pharmacia) sell selection primers and some companies (e.g., Pharmacia) also market pairs of “toggle” primers that are used for forward and reverse conversion of restriction sites and allow sequential rounds of mutagenesis without subcloning of the template.

*Plasmid DNA*

Closed circular plasmid DNA, purified either by chromatography through a commercial resin or by the alkaline lysis method (please see Chapter 1, Protocol 2 or 9).

**Media**

*LB agar plates and LB medium containing the appropriate antibiotic*

**Special Equipment**

*Water baths preset to 70°C and to the appropriate temperature for restriction endonuclease digestion*

**Additional Reagents**

*Steps 7 and 14 of this protocol require the reagents listed in Chapter 1, Protocol 23, 24, or 26 for the transformation of E. coli.*

*Steps 10 and 16 of this protocol require the reagents listed in Chapter 1, Protocol 1 for the minipreparation of plasmid DNA.*

*Step 17 of this protocol requires the reagents listed in Chapter 12, Protocol 3, 4, or 5.*

**Vectors and Bacterial Strains**

*Please see Appendix 3.*

*E. coli strain with a mut<sup>S</sup> genotype (e.g., BMH 71-18) competent for transformation*

*E. coli strain with a mut<sup>+</sup> phenotype competent for transformation*

*Please see Step 14.*

**METHOD**

---

**Synthesis of the Mutant DNA Strand**

1. Mix the following components in a microfuge tube:

10x annealing buffer	2 μl
plasmid DNA	0.025 to 0.25 pmole
selection primer	25 pmoles
mutagenic primer	25 pmoles
H <sub>2</sub> O	to 20 μl

Incubate the tube in a boiling water bath for 5 minutes.

The optimal amount of plasmid DNA is dependent on both the primer and the plasmid to be used.

2. Immediately chill the tube in ice for 5 minutes. Centrifuge the tube for 5 seconds in a microfuge to deposit the fluid at the base.
3. To the tube of annealed primers and plasmid, add:

10x synthesis buffer	3 μl
bacteriophage T4 DNA polymerase (2–4 units/μl)	1 μl
bacteriophage T4 DNA ligase (4–6 units/μl)	1 μl
H <sub>2</sub> O	5 μl

Mix the reagents well by gentle up and down pipetting. Centrifuge the tube for 5 seconds in a microfuge to deposit the fluid at the base. Incubate the reaction for 1–2 hours at 37°C.

4. Stop the reaction by heating the tube for at least 5 minutes at 70°C to inactivate the enzymes. Store the tube on the bench to allow it cool to room temperature.



## Primary Selection by Restriction Endonuclease Digestion

- Adjust the NaCl concentration of the reaction to a level that is optimal for the selected unique site restriction endonuclease. Use the 10x annealing buffer, a stock of NaCl, or the 10x buffer supplied with the restriction enzyme.

The concentration of NaCl in the synthesis/ligation mixture is 37.5 mM in a total volume of 30  $\mu$ l.

If the restriction digestion needs less or no NaCl, the DNA mixture in the synthesis/ligation buffer can be precipitated with ethanol or passed through a spun column and resuspended in the appropriate restriction enzyme buffer.

- Add 20 units of the selective restriction endonuclease to the reaction mixture. Incubate the reaction for at least 1 hour at the appropriate digestion temperature.

▲ **IMPORTANT** The volume of enzymes added to the reactions (including polymerase and ligase) should not exceed 10% of the total reaction volume. Adjust the reaction volume accordingly.

## First Transformation and Enrichment for Mutant Plasmids

- Transform a *mutS E. coli* strain such as BMH 71-18 with the plasmid DNAs contained in the digestion mixture, using one of the transformation procedures described in Chapter 1, Protocols 23–26.

- Spread 10, 50, and 250  $\mu$ l of the transformation mixture onto LB agar plates containing the appropriate antibiotic. Incubate the plates overnight at 37°C. Carry out Step 9 while the plates are incubating.

These plates are used to determine the number of primary transformants, which should be between 100 and 300 colonies per 50  $\mu$ l of transformation mixture plated.

- Amplify the plasmids by adding the remaining transformation mixture to 3 ml of LB medium containing the appropriate antibiotic. Incubate the culture overnight at 37°C with shaking.
- The next day, prepare plasmid DNA from ~2.5 ml of the overnight culture (please see Chapter 1, Protocol 1).
- Digest the plasmid DNA prepared in Step 10 with the selective restriction enzyme:

plasmid DNA	500 ng
10x restriction enzyme buffer	2 $\mu$ l
unique site restriction endonuclease	20 units
H <sub>2</sub> O	to 20 $\mu$ l

Incubate the reaction for 2 hours at the appropriate temperature.

- Add an additional 10 units of the restriction enzyme, and incubate for at least 1 further hour.
- Assess the extent of digestion by running 5–10  $\mu$ l of the plasmid DNA on a 1% agarose gel containing 0.5  $\mu$ g/ml ethidium bromide.

Linearized plasmid DNA will run as a discrete band; undigested (circular) DNA will run as two bands, corresponding to the relaxed circular form and the supercoiled form. However, since the parental plasmid makes up a greater part of the total plasmid pool, the bands corresponding to the undigested mutant plasmids may be quite faint compared to the digested parental plasmid band.

## Final Transformation

14. Transform competent *mutS*<sup>+</sup> *E. coli* cells with either 2–4  $\mu$ l of the digested plasmid DNA (~50–100 ng) for transformation of chemically treated competent cells or 1  $\mu$ l of plasmid DNA diluted fivefold with sterile H<sub>2</sub>O (~5 ng) for transformation by electroporation (please see Chapter 1, Protocols 23–26).
15. Spread 10, 50, and 250  $\mu$ l of the transformation mixture onto LB agar plates containing the appropriate antibiotic. Incubate the plates overnight at 37°C.
16. The next day, prepare minipreparations of plasmid DNA from at least 12 independent transformants. Screen the preparations by restriction endonuclease digestion and agarose gel electrophoresis to identify plasmids that are resistant to cleavage by the selective restriction enzyme.
17. Use DNA sequencing to confirm that the plasmids contain the desired mutation (please see Chapter 12, Protocol 3, 4, or 5).

### TROUBLESHOOTING

If the rate of mutant recovery is low, try

- combining USE with the Kunkel method of selection against uracil-containing template DNAs (Markvardsen et al. 1995)  
and/or
- increasing the concentration of the mutagenic primer so that the molar ratio of the two primers is 10:1 in favor of the mutagenic primer (Hutchinson and Allen 1997).
- incubating the extension reaction catalyzed by T4 DNA polymerase at 42°C rather than 37°C (Pharmacia Instruction Booklet)

Vectors of the pBluescript family have been reported to yield mutants with very low efficiency, perhaps because they contain a knotty region of secondary structure that impedes the progress of the DNA polymerase during the extension of primers *in vitro*. This problem can be avoided completely by using a plasmid vector that is not a member of the pBluescript family or by using a thermostable DNA polymerase and DNA ligase and incubating the extension reaction at high temperatures (Wong and Komaromy 1995).

# Protocol 5

---

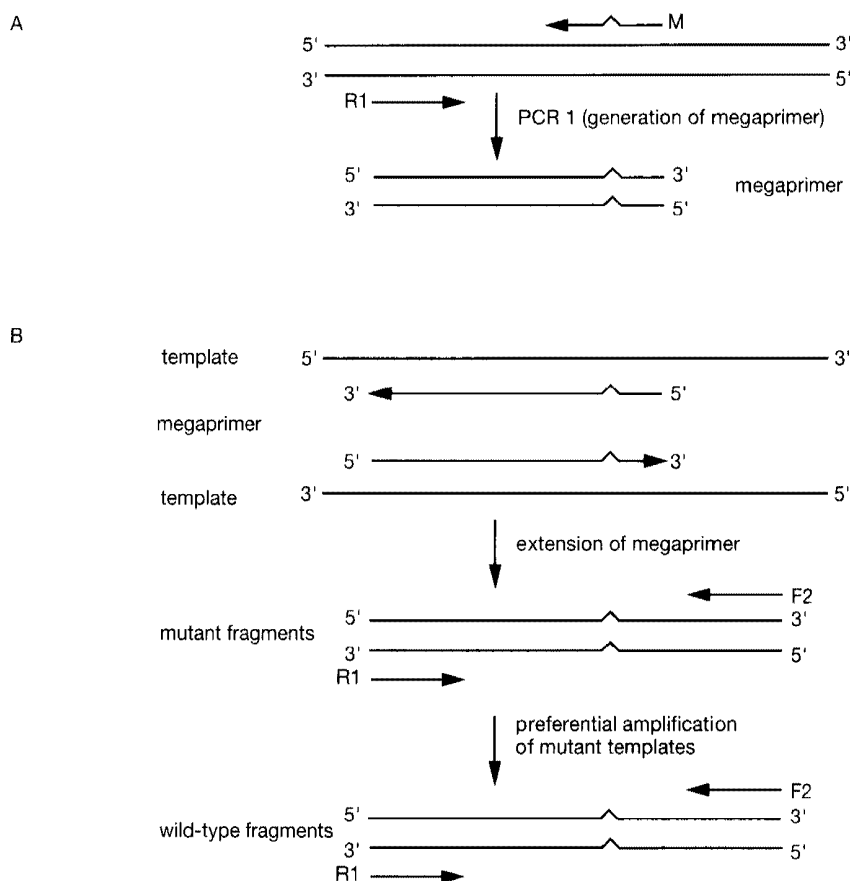
## Rapid and Efficient Site-directed Mutagenesis by the Single-tube Megaprimer PCR Method

**T**HE MEGAPRIMER METHOD INTRODUCED BY KAMMANN et al. (1989) and subsequently modified by many investigators, including Sarkar and Sommer (1990, 1992), Giebel and Spritz (1990), Landt et al. (1990), Marini et al. (1993), Picard et al. (1994), and Ling and Robinson (1997), is the simplest and most cost-effective method of PCR-based mutagenesis currently available. The megaprimer method of site-directed mutagenesis uses three oligonucleotide primers and two rounds of PCR. One of the oligonucleotides is mutagenic, and the other two are forward and reverse primers that lie upstream and downstream from the binding site for the mutagenic oligonucleotide (please see Figure 13-3). The flanking primers can be complementary to sequences in the cloned gene or to adjacent vector sequences. The mutagenic primer can, in theory, be oriented toward either one of the flanking primers. In practice, however, the mutagenic primer is oriented toward the nearer of the two flanking primers so that the length of the megaprimer is kept to a minimum.

The mutagenic primer and the nearer of the external primers are used in the first PCR to generate and amplify a mutated fragment of DNA. This amplified fragment — the megaprimer — is used in the second PCR in conjunction with the remaining external primer to amplify a longer region of the template DNA (Kammann et al. 1989; Giebel and Spritz 1990; Landt et al. 1990; Sarkar and Sommer 1990, 1992).

The original megaprimer methods were efficient only when the megaprimer was purified by polyacrylamide gel electrophoresis from the residual oligonucleotides used to prime the first PCR (Kammann et al. 1989; Giebel and Spritz 1990). Purification was a time-consuming and wearisome step in an otherwise elegant protocol. Recently, Ke and Madison (1997) have developed a megaprimer method that has the important advantage of not requiring purification of DNA between the two rounds of PCR. The method uses forward and reverse external primers with significantly different melting temperatures. A megaprimer is synthesized in the first amplification reaction using a mutagenic primer, an external primer with a low  $T_m$ , and a low annealing temperature. The second PCR is performed in the same tube as the first and utilizes the megaprimer produced in the first reaction, an external primer with a high  $T_m$ , and an annealing temperature (usually 72°C) high enough to prevent priming by the residual low  $T_m$  primer. The average mutagenesis efficiency of this method is >80% (Ke and Madison 1997).

Careful design of DNA primers is essential for achieving rapid and highly efficient mutagenesis using this PCR-based protocol. Optimal, short external primers are usually 15–16 bases long



**FIGURE 13-3 The Megaprimer Method**

(A) PCR 1 is performed with a mutagenic forward primer (M) and a reverse primer (R1) to generate and amplify a double-stranded megaprimer (shown in color). (B) In the first cycle(s) of PCR 2, the megaprimer formed in PCR 1 is extended on the original template. In the subsequent cycles, which use forward and reverse primers F2 and R2, the desired mutants are further amplified. (Modified, with permission, from Colosimo et al. 1999.)

and typically possess a calculated  $T_m$  between 42°C and 46°C. The  $T_m$  (in °C) of oligonucleotide primers can be estimated using the standard formulas:

$$T_m = 4(G+C) + 2(A+T)$$

where  $(G+C)$  is the sum of G and C residues in the oligonucleotide and  $(A+T)$  is the sum of the A and T residues in the oligonucleotide.

or

$$T_m = 81.5 + 16.6 \log_{10} [\text{Na}^+] + 0.41 (\%[G+C]) - (675/n) - (\% \text{ mismatch})$$

where  $n$  is the length of the primer in bases. The first formula is appropriate for short oligonucleotides, whereas the second formula is used with longer DNA.

The mutagenic oligonucleotide should also be designed to have a low estimated  $T_m$  and a length of 16–25 bases. The desired mutation, and therefore the mismatched region of the primer/template duplex, should be located in the middle of the primer with 8–10 bases of correctly

matched sequences on each side of the mismatched region. When using *Taq* DNA polymerase, which possesses a terminal transferase-like activity that sometimes incorporates an untemplated dA residue at the 3' end of the amplified megaprimer, the mutagenic primer is designed so that its first 5' nucleotide follows a T residue in the same strand of the template sequence. The longer of the two flanking primers should be designed to contain 25–30 bases and possess a calculated  $T_m$  between 72°C and 85°C.

This protocol was kindly provided by Ed Madison and Song Ke of Corvas Inc., San Diego, California.

## MATERIALS

---

**CAUTION:** Please see Appendix 12 for appropriate handling of materials marked with <!.>.

### Buffers and Solutions

Please see Appendix 1 for components of stock solutions, buffers, and reagents. Dilute stock solutions to the appropriate concentrations.

*10x Amplification buffer*

*dNTP solution containing all four dNTPs, each at a 2.5 mM*

### Enzymes and Buffers

*Thermostable DNA polymerase (Hot-Tub DNA Polymerase [Amersham] or equivalent)*

Most thermostable DNA polymerases are supplied in a storage buffer containing 50% glycerol. This solution is very viscous and is difficult to pipette accurately. The best sampling method is to centrifuge the tube containing the enzyme at maximum speed for 10 seconds at 4°C in a microfuge and then to withdraw the required amount of enzyme using a positive-displacement pipette. Use automatic pipetting devices equipped with barrier tips to assemble the components of PCRs.

### Gels

*Agarose gel (1%) or polyacrylamide gel containing 0.5 µg/ml ethidium bromide <!.>*

Please see Step 6.

### Nucleic Acids and Oligonucleotides

*Primers*

Dissolve the forward and reverse external primers in H<sub>2</sub>O at a concentration of 100 µM (100 pmoles/µl).

Dissolve the mutagenic primer in H<sub>2</sub>O at a concentration of 10 µM (10 pmoles/µl).

*Template DNA*

Superhelical, double-stranded plasmid DNA, purified by ethidium bromide–CsCl density gradient centrifugation (Chapter 1, Protocol 10 or 11) or chromatography on a Qiagen resin (Chapter 1, Protocol 9).

Dissolve the template DNA in TE (pH 8.0) at a concentration of 0.1 µg/ml.

### Special Equipment

*Barrier tips for automatic micropipettes*

*Microfuge tubes (5 ml, thin-walled for amplification)*

*Positive-displacement pipette*

*Thermal cycler programmed with desired amplification protocol*

If the thermal cycler is not equipped with a heated lid, use either mineral oil or paraffin wax to prevent evaporation of liquid from the reaction mixture during PCR.

### Additional Reagents

*Step 6 of this protocol requires the reagents listed in Chapter 1, Protocol 17 or 19.*

## METHOD

1. In a sterile 0.5-ml microfuge tube or amplification tube (on ice), mix the following reagents for the first amplification reaction:

10x amplification buffer	10 $\mu$ l
plasmid template DNA	200–400 pg
2.5 mM dNTP solution	8 $\mu$ l
mutagenic primer	10 pmoles
low $T_m$ flanking primer	100 pmoles
thermostable DNA polymerase	0.5 $\mu$ l (2.5 units)
H <sub>2</sub> O	to 100 $\mu$ l

If the 10x amplification buffer supplied by the manufacturer of the thermostable DNA polymerase does not contain MgCl<sub>2</sub>, add an appropriate volume of 0.1 M MgCl<sub>2</sub> so that the reaction mixture contains the optimum concentration of divalent ion for the particular DNA polymerase being used.

2. If the thermocycler does not have a heated lid, overlay the PCRs with 1 drop (~50  $\mu$ l) of light mineral oil. Place the tubes in a thermocycler.
3. Amplify the nucleic acids using the denaturation, annealing, and polymerization times and temperatures listed in the table.

Cycle Number	Denaturation	Annealing	Polymerization
1st cycle	4 min at 94°C	1 min at 42–46°C	1 min at 72°C
24 cycles	40 sec at 94°C	1 min at 42–46°C	1 min at 72°C
Last cycle	40 sec at 94°C	1 min at 42–46°C	5 min at 72°C

These times are suitable for 100- $\mu$ l reactions assembled in thin-walled 0.5-ml tubes and incubated in thermal cyclers such as the Perkin-Elmer 9600 or 9700, Master Cycler (Eppendorf), and PTC 100 (MJ Research). Times and temperatures may need to be adapted to suit other types of equipment and reaction volumes.

Polymerization should be carried out for 1 minute for every 1000 bp of length of the target DNA.

4. After completion of the first PCR, add to the reaction tube:

high $T_m$ flanking primer	100 pmoles
thermostable DNA polymerase	0.5 $\mu$ l (2.5 units)
2.5 mM dNTP solution	3 $\mu$ l

Mix the reagents gently by pipetting the reaction mixture up and down several times. If necessary, centrifuge the tube briefly to deposit the reagents in the bottom.

If desired, successful synthesis of the megaprimer PCR product can be verified at this point by using 3–5  $\mu$ l of reaction mixture to perform rapid, analytical agarose gel electrophoresis.

5. Carry out the second amplification reaction, which consists of 25 cycles with the following two-step temperature profile:

94°C for 40 seconds  
72°C for 90 seconds with a final extension step for 5 minutes at 72°C

6. Analyze 5% of the second amplification reaction on an agarose or polyacrylamide gel and estimate the concentration of amplified target DNA.

If restriction sites were placed in the sequences of the external primers, digest the amplified DNA with the appropriate enzymes and then subclone it into an appropriate vector. Alternatively, phosphorylate the amplified DNA fragment from Step 5 and then ligate it into a vector that has been cleaved with a restriction enzyme that yields blunt ends. Because this method yields mutants with an efficiency of ~80%, it is generally necessary to select only six colonies for DNA sequencing to verify the presence of the desired mutation(s) and to confirm the absence of any additional mutations in the entire product DNA sequence.

# Protocol 6

---

## Site-specific Mutagenesis by Overlap Extension

**F**OUR PRIMERS ARE NEEDED TO INTRODUCE A SITE-SPECIFIC MUTATION by overlap extension (please see Figure 13-4) (Higuchi et al. 1988; Ho et al. 1989). One pair of primers is used to amplify the DNA that contains the mutation site together with upstream sequences. The forward primer (FM) contains the mutation(s) to be introduced into the wild-type template DNA, whereas the reverse primer R2 contains a wild-type sequence. Many investigators include a restriction site in the 5' region of primer 1 to facilitate subcloning of the mutated segment of DNA.

The second pair of primers is used to amplify the DNA that contains the mutation site together with downstream sequences. The reverse primer (RM) of this pair contains the mutation(s) to be introduced into the template DNA. At least 15 bases of primer RM should be exactly complementary to primer FM. The forward primer (F2) has a wild-type sequence and may, if desired, have a restriction site in its 5' region.

The two sets of primers are used in two separate amplification reactions to amplify overlapping DNA fragments (reactions 1 and 2 of Figure 13-4). The mutation(s) of interest is located in the region of overlap and therefore in both sets of resulting amplified fragments. The overlapping fragments (resulting from the first and second rounds of amplification) are mixed, denatured, and annealed to generate heteroduplexes that can be extended and, in a third PCR (reaction 3), amplified into a full-length DNA using two primers that bind to the extremes of the two initial fragments. The method is surprisingly effective, but it requires two mutagenic primers, two flanking oligonucleotides, and three PCRs to construct a mutation. In some cases, a simpler version of the method can be used (one mutagenic primer and two sequential PCRs) if strategically placed restriction sites are available to clone the segment of amplified DNA containing the mutation (Aiyar et al. 1996).

---

### MATERIALS

**CAUTION:** Please see Appendix 12 for appropriate handling of materials marked with <!>.

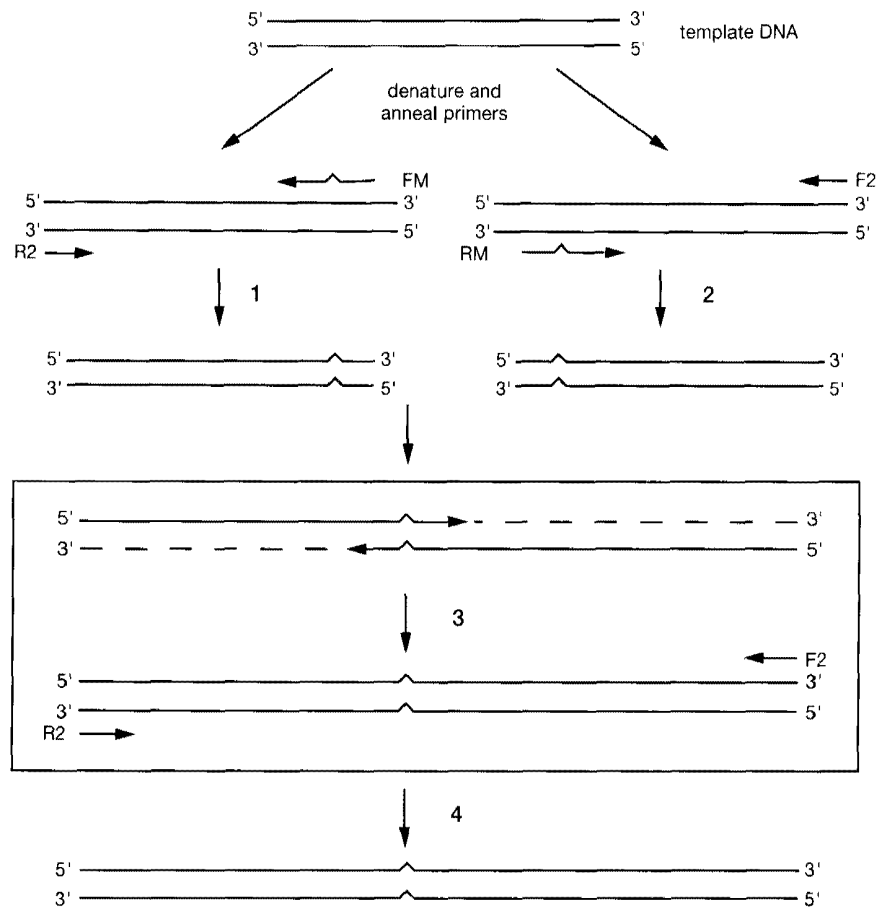
#### Buffers and Solutions

Please see Appendix 1 for components of stock solutions, buffers, and reagents. Dilute stock solutions to the appropriate concentrations.

*10x Amplification buffer*

*dNTP solution containing all four dNTPs, each at 20 mM*





**FIGURE 13-4 Site-directed Mutagenesis by Overlap Extension**

In separate amplifications, 1 and 2, two fragments of the target gene are amplified. PCR 1 utilizes primers FM and R2, whereas PCR 2 utilizes primers RM and F2. The boxed portion of the figure represents the intermediate steps that are likely to occur during the course of PCR 3, in which denatured FMR 2 and RMF 2 anneal at the region of overlap and are extended as shown by the dashed lines to form full-length double-stranded mutant DNA. In PCR 4, the full-length mutant DNA is amplified using primers R2 and F2. (Modified, with permission, from Ho et al. 1989 [©Elsevier Science].)

## Enzymes and Buffers

### *Thermostable DNA polymerase*

To avoid the introduction of erroneous bases, use a highly processive thermostable DNA polymerase with 3'-5' exonuclease "proofreading" capacity in overlap extension mutagenesis. In addition, the DNA polymerase used must not catalyze the nontemplate addition of adenine residues. Thermostable DNA polymerases with the appropriate properties include *Pwo* DNA polymerase (Boehringer Mannheim), *rTth* DNA polymerase XL (Perkin-Elmer), *VentR* DNA polymerase (New England Biolabs), and *Pfu* DNA polymerase (Stratagene).

Mixes of thermostable DNA polymerases designed for use in long PCR are also well suited for overlap extension mutagenesis.

## Gels

*Agarose gel (1%) or polyacrylamide gel containing 0.5 µg/ml ethidium bromide <!>*

Please see Steps 6 and 11.

## Nucleic Acids and Oligonucleotides

### Oligonucleotide Primers

Each primer should be 20–30 nucleotides in length and contain approximately equal numbers of the four bases, with a balanced distribution of G and C residues and a low propensity to form stable secondary structure. The sequences of the mutagenic oligonucleotide primers FM and RM should share at least a 15-bp overlap (please see Figure 13-4), and the mismatched base pairs within these primers should be located in the center of the oligonucleotide. The primer sequences at the 5' and 3' ends of the DNA fragment to be amplified (i.e., those with wild-type sequences R2, F2) can incorporate unique restriction endonuclease cleavage sites to aid in the subsequent cloning of the mutagenized DNA fragment. For general features of primer design, please see the discussion on Design of Oligonucleotide Primers in the introduction to Chapter 10.

Oligonucleotide primers synthesized on an automated DNA synthesizer can generally be used in overlap extension mutagenesis without further purification.

### Template DNA

The template DNA used for mutagenesis is usually a plasmid DNA containing the gene or cDNA of interest. Dissolve the DNA at 1 µg/ml in 10 mM Tris-Cl (pH 7.6) containing a low concentration of EDTA (<0.1 mM).

## Special Equipment

*Barrier tips for automatic micropipettes*

*Microfuge tubes (0.5 ml, thin-walled for amplification) or Microtiter plates*

*Positive-displacement pipette*

*Thermal cycler programmed with desired amplification protocol*

If the thermal cycler is not equipped with a heated lid, use either mineral oil or paraffin wax to prevent evaporation of liquid from the reaction mixture during PCR.

## Additional Reagents

*Step 11 of this protocol requires the reagents listed in Chapter 1, Protocol 17 or 19.*

*Step 12 of this protocol requires the reagents listed in Chapter 12, Protocol 3, 4, or 5.*

## METHOD

---

1. Design and synthesize oligonucleotide primers FM, RM, R2, and F2 based on the known sequence of the DNA, as outlined in the protocol introduction and Materials section.
2. In a sterile 0.5-ml microfuge tube or amplification tube, set up PCR 1 by mixing the following reagents:

template DNA	~100 ng
10x amplification buffer	10 µl
20 mM mixture of four dNTPs	1.0 µl
5 µM primer FM (30 pmoles)	6.0 µl
5 µM primer R2 (30 pmoles)	6.0 µl
thermostable DNA polymerase	1–2 units
H <sub>2</sub> O	to 100 µl

3. In a second sterile 0.5-ml microfuge tube or amplification tube, set up PCR 2 by mixing the following reagents:

template DNA	~100 ng
10x amplification buffer	10 µl
20 mM mixture of four dNTPs	1.0 µl
5 µM primer RM (30 pmoles)	6.0 µl
5 µM primer F2 (30 pmoles)	6.0 µl
thermostable DNA polymerase	1–2 units
H <sub>2</sub> O	to 100 µl

4. If the thermocycler does not have a heated lid, overlay the PCRs with 1 drop (~50  $\mu$ l) of light mineral oil. Place the tubes in a thermocycler.
5. Amplify the nucleic acids using the denaturation, annealing, and polymerization times and temperatures listed in the table below.

Cycle Number	Denaturation	Annealing	Polymerization
20 cycles	1 min at 94°C	1 min at 50°C	1–3 min at 72°C
Last cycle	1 min at 94°C	10 min at 72°C	

These times are suitable for 100- $\mu$ l reactions assembled in thin-walled 0.5-ml tubes and incubated in thermal cyclers such as the Perkin-Elmer 9600 or 9700, Master Cycler (Eppendorf), and PTC 100 (MJ Research). Times and temperatures may need to be adapted to suit other types of equipment and reaction volumes.

The length of the polymerization step should be calculated from the polymerization rate of the thermostable DNA polymerase employed and the length of the DNA template to be amplified.

The temperature of the annealing reaction may have to be adjusted depending on the sequence of the mutagenic primers.

6. Analyze 5% of each of the two PCRs on an agarose or polyacrylamide gel and estimate the concentration of amplified target DNAs.
7. (*Optional*) Purify the two PCR products using one of the protocols described in Chapter 5. Including this purification step often increases the yield of the desired amplification product in Step 8 of the protocol and reduces the background of spurious amplification products.
8. In a sterile 0.5-ml microfuge tube or amplification tube, mix the following reagents in an amplification reaction to join the 5' and 3' ends of the target gene:

amplification product PCR 1 (Step 2)	~50 ng
amplification product PCR 2 (Step 3)	~50 ng
10x amplification buffer	10 $\mu$ l
5 $\mu$ M primer F2 (30 pmoles)	6.0 $\mu$ l
5 $\mu$ M primer R2 (30 pmoles)	6.0 $\mu$ l
thermostable DNA polymerase	1–2 units
H <sub>2</sub> O	to 100 $\mu$ l

9. If the thermocycler does not have a heated lid, overlay the PCRs with 1 drop (~50  $\mu$ l) of light mineral oil. Place the tubes in a thermocycler.
10. Amplify the nucleic acids using the denaturation, annealing, and polymerization times and temperatures listed above in Step 5.
11. Analyze 5% of the PCR on an agarose or polyacrylamide acrylamide gel and estimate the concentration of amplified target DNA.

If restriction enzyme sites were placed in the sequences of primers F2 and R2, digest the amplified DNA with these enzymes and then subclone them into an appropriate vector. Alternatively, phosphorylate the amplified DNA fragment from Step 10 and then ligate it into a vector that has been cleaved with a restriction enzyme that yields blunt ends.

12. Verify the complete sequence of the amplified DNA fragment after cloning to ensure that no mutations other than those in primers FM and RM were introduced during these manipulations.

All DNA polymerases exhibit a measurable error rate when used in *in vitro* reactions.

# Protocol 7

---

## Screening Recombinant Clones for Site-directed Mutagenesis by Hybridization to Radiolabeled Oligonucleotides

**W**HEN PROTOCOLS FOR SITE-DIRECTED MUTAGENESIS of single-stranded bacteriophage M13 DNA were developed in the early 1980s, genetic techniques to select against the wild-type template strand were not available. Because the efficiency of mutagenesis was often low, methods were required to identify a small minority of mutant plaques in a dense background of wild-type plaques. For many years, the technique of choice was screening of plaques by hybridization, using a radiolabeled mutagenic oligonucleotide as a probe (e.g., please see Zoller and Smith 1982, 1983). Hybridization was carried out under conditions that allowed the radiolabeled oligonucleotide to anneal to both mutant and wild-type DNAs. The resulting hybrid between the radiolabeled mutagenic oligonucleotide and the wild-type sequence would therefore contain one or more mismatched base pairs, whereas the hybrid formed between the newly created mutant and the oligonucleotide probe would be perfectly matched. The thermal stability of these two types of hybrids would be expected to differ, with mismatched hybrids dissociating at a temperature lower than that of the corresponding perfect hybrid. At the time, however, the quantitative effects of mismatches on thermal stability of oligonucleotide duplexes were not well understood. It was obvious that the position of the mismatch, the number of mismatched bases, the length of the oligonucleotide, the content of G and C residues, and sequence context effects would all influence the stability of the mismatched hybrid. But it proved difficult to weave these factors into an equation that would satisfy all circumstances. In the absence of a strong underlying theory, the success of site-directed mutagenesis depended on the ability of the investigator to find an empirical combination of temperature and ionic strength that caused mismatched hybrids to dissociate but had no effect on perfect hybrids.

Although methods to reduce the proportion of wild-type clones have substantially reduced the need for screening by hybridization, the protocol described here remains useful in situations where the desired mutant is obtained with low frequency (e.g., when creating large deletions or complex rearrangements). In addition, this protocol has other applications in molecular biology, including allele-specific oligonucleotide hybridization, colony hybridization, identification of specific mutations among a population of random mutants, and measuring the relatedness among members of a gene family.

The main protocol describes the screening of bacteriophage M13 recombinant clones, whereas an alternative protocol presents a method for screening phagemid-containing bacterial colonies. A final alternative protocol included in this collection describes the detection of defined mutants using PCR.

**MATERIALS**

**CAUTION:** Please see Appendix 12 for appropriate handling of materials marked with <!.>.

**Buffers and Solutions**

Please see Appendix 1 for components of stock solutions, buffers, and reagents. Dilute stock solutions to the appropriate concentrations.

*Ammonium formate (0.2 M) <!.>*

*Oligonucleotide hybridization solution*

6x SSC

5x Denhardt's reagent

10<sup>6</sup> to 10<sup>7</sup> dpm/ml radiolabeled oligonucleotide

*Oligonucleotide prehybridization solution*

6x SSC

5x Denhardt's reagent

0.1% (w/v) SDS

6x SSC

6x SSC should be warmed to various temperatures. Please see Steps 11, 12, and 13.

*TE (pH 7.6)*

**Enzymes and Buffers**

*Bacteriophage T4 polynucleotide kinase*

*Restriction enzymes*

Please see Steps 18 and 19.

**Gels**

*Preparative agarose gel*

Please see Step 18.

**Nucleic Acids and Oligonucleotides**

*Mutagenic oligonucleotide (10 pmoles/ $\mu$ l)*

**Radioactive Compounds**

*$\gamma$ -<sup>32</sup>P]ATP (>5000 Ci/mmole, 10 mCi/ml) <!.>*

**Media**

*2x YT top agar and YT agar plates*

**Special Equipment**

*Forceps, blunt-ended (e.g., Millipore forceps)*

*Hypodermic needle (18 gauge) and India Ink (optional)*

*Incubator preset to 65°C, for prehybridization*

*Incubator preset to appropriate hybridization temperature*

Please see note to Step 7.

*Nitrocellulose or nylon filters*

*Vacuum oven*

Water bath preset to 68°C

Whatman DEAE paper (DE-81)

Store the paper at room temperature, and wear gloves when handling.

### Additional Reagents

Step 4 of this protocol requires the reagents listed in Chapter 10, Protocol 4.

Step 14 of this protocol requires the reagents listed in Chapter 3, Protocol 4.

Steps 15 and 16 of this protocol require the reagents listed in Chapter 12, Protocol 3, 4, or 5.

Step 17 of this protocol requires the reagents listed in Chapter 3, Protocol 3.

Step 20 of this protocol requires the reagents listed in Chapter 6, Protocols 8 and 10.

### Vectors and Bacterial Strains

*Bacteriophage M13 recombinants, previously mutagenized*

Please use plates containing bacteriophage M13 plaques generated in Protocol 2.

*Bacteriophage M13 recombinants, nonmutagenized*

These serve as a negative control; please see Step 5.

*E. coli strain TG1 or equivalent*

## METHOD

---

### Radiolabeling of Oligonucleotides by Phosphorylation

1. In a sterile microfuge tube, mix:

mutagenic oligonucleotide (10 pmoles/μl)	1 μl
10× bacteriophage T4 polynucleotide kinase buffer	1 μl
10 mCi/ml [ $\gamma$ - <sup>32</sup> P]ATP (10–50 pmoles)	1 μl
H <sub>2</sub> O	6 μl
5–10 units/μl bacteriophage T4 polynucleotide kinase	1 μl

Incubate the reaction mixture for 30 minutes at 37°C.

2. Dilute the reaction mixture to 100 μl by the addition of 90 μl of TE (pH 7.6) and inactivate the polynucleotide kinase by heating for 10 minutes at 68°C.
3. Measure the efficiency of transfer of <sup>32</sup>P to the oligonucleotide and estimate its specific activity by chromatography on DE-81 paper as follows:
  - a. Cut a strip of Whatman DE-81 paper ~1 cm wide and 7–10 cm long. With a soft-lead pencil, draw a fine line across the strip ~1.5 cm from one end. This line marks the origin of the chromatogram.
  - b. Spot 1.0 μl of the diluted phosphorylation reaction at the origin. Fill a 250-ml beaker to a depth of ~0.5 cm with ~25–50 ml of 0.2 M ammonium formate. Place the DE-81 strip vertically in a beaker so that the radioactive sample(s) at the origin is just above the buffer solution. Cover the beaker with a glass plate or aluminum foil and allow the chro-

matogram to develop until the solvent front has migrated almost to the top of the beaker.

- c. Wrap the strip of DE-81 paper in Saran Wrap and subject it to a very brief period of autoradiography. Use the developed X-ray film as a guide to cut out the radioactive region at the solvent front, the origin, and any other region that contains radioactivity. Measure the amount of radioactivity in each section in a scintillation counter.

Oligonucleotides remain at the origin, whereas ATP and inorganic phosphate migrate in the same direction as the solvent. Inorganic phosphate migrates slightly behind the solvent front, whereas ATP is approximately equidistant from the origin and the inorganic phosphate. Thus, transfer of phosphate from [ $\gamma$ - $^{32}\text{P}$ ]ATP to the oligonucleotide results in the appearance of radioactivity at the origin. Calculate the specific activity of the radiolabeled probe from the molar quantities of oligonucleotide, the specific activity of the [ $\gamma$ - $^{32}\text{P}$ ]ATP in the reaction, and the efficiency of transfer of the label to the oligonucleotide. >50% of the radioactivity in the reaction mixture (Step 1) should be transferred to the oligonucleotide.

4. (Optional) Remove unincorporated radiolabel from the oligonucleotide by precipitation with cetylpyridinium bromide as described in Chapter 10, Protocol 4.

This step is necessary only when background hybridization is a persistent problem. Under normal circumstances, the unfractionated reaction mixture may be used as a probe.

## Screening of Bacteriophage M13 Plaques

5. Prepare replicas of the bacteriophage M13 plaques that are to be screened with the radiolabeled oligonucleotide as follows:
  - a. Transfer plates containing 100–500 plaques to 4°C for at least 30 minutes.
 

Include at least one plate that contains plaques of the original wild-type recombinant bacteriophage M13. This plate serves as a negative control in the hybridization and washing steps.
  - b. When the plates are thoroughly chilled, remove them from the cold room and immediately lay a numbered, dry nitrocellulose or nylon filter on the agar surface of each plate. Use an 18-gauge hypodermic needle to make a series of holes in each filter and the underlying agar. These holes will later serve to key the filters to the plates.
 

To make an indelible spot, dip the needle in a small amount of India Ink before stabbing the filter.
  - c. After 30 seconds to 4 minutes, use blunt-ended forceps to peel each filter carefully from its plate. Spread out all of the filters (plaque side up) on a pad of paper towels. Wrap the plates in Saran Wrap, and store them at 4°C until they are needed.
  - d. When the filters have dried (~30 minutes at room temperature), bake them for 1 hour at 80°C in a vacuum oven.
 

It is not necessary to denature the DNA by base treatment when screening bacteriophage M13 plaques because the baking step releases the single-stranded DNA from the virus.
6. Transfer all of the filters to a heat-sealable plastic bag (e.g., Sears Seal-A-Meal), or to an evaporating dish of the appropriate diameter, or to a hybridization roller bottle. Add oligonucleotide prehybridization solution (~10 ml/82-mm filter in bags or dishes; 5 ml/82-mm filter in bottles). Seal the bag, cover the evaporating dish with Saran Wrap, or cap the roller bottle, and incubate the filters for 1–2 hours at 65°C.

7. Discard the prehybridization solution, and replace it with oligonucleotide hybridization solution (~5 ml/82-mm filter). Reseal the bag, recover the evaporating dish, or recap the hybridization roller bottle, and incubate the hybridization reaction for 4–6 hours at the appropriate temperature.

Perform hybridization with the radiolabeled oligonucleotide at a temperature 5–10°C below the  $T_m$  estimated from the following formula:

$$T_m = 4(G+C) + 2(A+T).$$

where (G+C) is the sum of G and C residues in the oligonucleotide, and where (A+T) is the sum of the A and T residues in the oligonucleotide.

8. At the end of the hybridization period, quickly transfer the filters to a tray containing 200–300 ml of 6× SSC at room temperature. Cover the tray with Saran Wrap, and place it on a rotating shaker for 15 minutes. Replace the washing fluid every 5 minutes. Meanwhile, transfer the remainder of the radioactive hybridization solution from the bag, dish, or roller bottle to a disposable plastic tube. Close the tube tightly, and store the radioactive solution at –20°C until it is needed for rescreening positive plaques (Step 13).

Label and store the tube appropriately.

9. At the end of the washing period, quickly transfer the filters to a piece of Saran Wrap stretched on the bench. Cover the filters with another piece of Saran Wrap. Fold the edges of the two pieces of Saran Wrap together to form a tight seal. Apply adhesive dot labels marked with radioactive or chemiluminescent ink to the outside of the package, and generate an autoradiograph by exposing the package of filters to X-ray film for 1–2 hours at –70°C, using an intensifying screen (please see Appendix 9).

▲ **IMPORTANT** Do not allow the filters to dry on the Saran Wrap.

10. Compare the pattern of hybridization with the distribution of plaques. At this stage, it is normal to find that virtually every plaque hybridizes to the probe. Typically, however, some plaques hybridize more strongly than others, and these often turn out to be the plaques carrying the desired mutation.
11. Transfer the filters to a plastic box containing 100–200 ml of 6× SSC that has been warmed to 10°C below the  $T_m$ . Agitate the filters in the solution for 2 minutes (please see note below), and then transfer them to a piece of Saran Wrap as described in Step 9. Establish another autoradiograph. At this stage, it is often possible to identify two types of plaques: those whose radioactive signal has decreased in intensity and those that show no change in intensity.

If a short oligonucleotide probe (<20 bases) is used, do not wash the filters for more than 2 minutes at 10°C below the  $T_m$ . Otherwise, the perfect hybrids formed between the radioactive oligonucleotide and the mutagenized target sequence may dissociate. Longer oligonucleotide probes require more extensive washing times which must be established empirically. This optimization can be done using a hand-held minimonitor and listening for a decrease in the intensity of the radioactive signal as washing proceeds.

12. Repeat the cycles of washing and autoradiography, increasing the temperature of the washing solution by 2–10°C in each cycle. The aim is to find a temperature that does not markedly affect perfect hybrids but causes dissociation of mismatched hybrids (such as those formed between the mutagenic oligonucleotide and the original wild-type sequence).

With practice, it is possible to eliminate some of the cycles of washing and autoradiography by scanning the filters after each wash with a hand-held minimonitor.



## Purification of Positive Plaques

13. Positively hybridizing plaques usually contain a mixture of both mutant and wild-type sequences. It is therefore *essential* to plaque-purify the bacteriophages from positively hybridizing plaques as follows:
  - a. Touch the blunt end of a sterile, disposable wooden toothpick to the surface of a positively hybridizing plaque.
  - b. Drop the toothpick into a sterile tube containing 1 ml of sterile TE (pH 7.6). Store the tube for 10–15 minutes at room temperature, shaking it from time to time to dislodge bacteriophage particles.
  - c. Make a series of tenfold dilutions of the bacteriophage suspension with TE (pH 7.6). Mix 10  $\mu$ l of the  $10^{-3}$ ,  $10^{-4}$ , and  $10^{-5}$  dilutions with 100- $\mu$ l aliquots of an overnight culture of an appropriate strain of *E. coli* (e.g., TG1).
  - d. Add 2.5 ml of 2x YT top agar (melted and cooled to 45°C) to each culture, and plate the entire mixture on a single YT agar plate. Incubate the plate for 16 hours at 37°C to allow plaques to form.
  - e. Rescreen the plaques with the radiolabeled oligonucleotide as described in Steps 5–12. In this second round of screening, there is no need to increase the temperature of the washing solution in a stepwise fashion. Instead, the filters can be transferred directly from the washing solution at room temperature (Step 8) to 6x SSC previously warmed to the discriminatory temperature found empirically in Step 12.
14. Pick two plaques from each of three independent putative mutants. Prepare single-stranded DNA from small-scale cultures infected with bacteriophages derived from each of these plaques as described in Chapter 3, Protocol 4.
15. Carry out DNA sequencing by the dideoxy-mediated chain-termination method (please see Chapter 12, Protocol 3 or 4) through the region containing the target sequence. Use either a universal sequencing primer or a custom-synthesized primer that binds 50–100 nucleotides upstream of the mutation site.
16. When the presence of the mutation has been confirmed, verify the sequence of the entire region of the target DNA cloned in the bacteriophage M13 vector to ensure that no adventitious mutations have been generated during propagation of the recombinant in bacteriophage M13. Often, this requires the synthesis of custom-designed sequencing primers that are complementary to segments of the target DNA spaced ~200–400 bp apart.
17. Isolate bacteriophage M13 replicative form DNA from a culture infected with plaque-purified recombinant bacteriophages (Step 14) that carry the desired mutation and show no other changes in sequence in the target region. For methods to isolate and purify bacteriophage M13 replicative form DNA, please see Chapter 3, Protocol 3.
18. Recover the mutated target sequence by digestion of bacteriophage M13 replicative form DNA with the appropriate restriction enzyme(s) and preparative gel electrophoresis. Clone the target DNA into the desired vector.

19. Use several different restriction enzymes to digest aliquots of either a recombinant that carries the original (nonmutagenized) target sequence or the recombinant that carries the mutagenized target sequence.
20. Separate the resulting fragments by gel electrophoresis, and transfer them to a solid support (e.g., nitrocellulose or nylon membrane) as described in Chapter 6, Protocol 8. Carry out Southern hybridization at  $10^{\circ}\text{C}$  below the  $T_m$ , using the  $^{32}\text{P}$ -labeled mutagenic oligonucleotide as a probe. Wash the filter under the discriminatory conditions and establish an autoradiograph.

The final autoradiograph should show hybridization only to the relevant fragments of the mutagenized target DNA.

#### TROUBLESHOOTING

The hybridization and washing conditions described above work well for short oligonucleotides (<20 bases), and it is almost always possible to identify strongly hybridizing plaques or colonies after several cycles of washing and autoradiography. If after repeated washings, all the plaques or colonies continue to hybridize to the oligonucleotide probe, consider the following:

- Check that there is no region of extensive homology between the probe and ectopic regions of the vector or the target DNA.
- Increase the stringency of washing by decreasing the concentration of SSC in the buffer or dramatically increasing the temperature. For longer oligonucleotide probes (e.g., 40-mers), such as those used to delete large segments of a cloned DNA, washing may require  $0.1\times$  SSC buffers and a washing temperature of  $80^{\circ}\text{C}$ . Unusual base compositions or secondary structures in oligonucleotide probes may require the use of tetramethylammonium salts to distinguish mutant from wild-type templates (please see Chapter 10, Protocol 8).
- Remove bacterial debris from the filters before hybridization by wiping the filters with Kimwipes soaked in warm  $2\times$  SSC, 0.1% SDS.
- Purify the mutagenic oligonucleotide by polyacrylamide gel electrophoresis. If the background problem persists, resynthesize the oligonucleotide, and consider synthesizing a shorter oligonucleotide for use as a probe.

**ALTERNATIVE PROTOCOL: SCREENING PHAGEMID-CONTAINING BACTERIAL COLONIES BY HYBRIDIZATION TO RADIOLABELED OLIGONUCLEOTIDES**

This protocol is identical in principle and similar in practice to the main protocol (screening bacteriophage M13). However, because colonies of bacteria transformed by the products of site-directed mutagenesis reactions often contain a mixture of wild-type and mutated molecules, a second round of transformation and screening is required to segregate the two types of phagemids. Note that simple restreaking of positive colonies does not generally yield pure populations of bacteria: The copy number of phagemids is so high that complete segregation of mutant from wild-type phagemids occurs only rarely.

An alternative method of obtaining pure mutant phagemids before oligonucleotide hybridization is to scrape the colonies transformed by the products of in vitro DNA synthesis into a small volume of liquid medium. Phagemid DNA is isolated from the pooled colonies by a standard minipreparation method and used to transform another batch of competent *E. coli* cells. The resulting colonies, which will contain pure populations of either mutant or wild-type phagemids, are then screened by hybridization using the mutagenic oligonucleotide as a probe.

**Additional Materials**

*E. coli* strain MV1184, competent for transformation

Please see Chapter 3, Protocol 8, for phagemid strain information.

LB medium containing the appropriate antibiotic

Please see Step 6.

2x SSC containing 0.1% (w/v) SDS

Water bath preset to 55°C

**Method**

1. Radiolabel the mutagenic oligonucleotide by phosphorylation, as described in Steps 1–4 of the main protocol.
2. Transfer the transformed colonies to nitrocellulose or nylon filters as described in Chapter 1, Protocol 29.  
Incubate the bacterial master plates for a few hours at 37°C to allow the colonies to regrow, then seal the plates in Saran Wrap, and store them at 4°C until they are needed.
3. Lyse the colonies transferred to the filter with alkali (please see Chapter 1, Protocol 31). Neutralize the filters, and then fix the liberated DNA in situ by baking for 1 hour at 80°C in a vacuum oven.
4. Soak the filters in 6x SSC, 0.1% (w/v) SDS at 37°C. Use Kimwipes soaked in the same solution to gently rub the filters to remove all bacterial debris. Incubate the filters in fresh 6x SSC, 0.1% (w/v) SDS for 3 hours at 55°C.
5. Carry out hybridization with the <sup>32</sup>P-labeled mutagenic oligonucleotide as described in Steps 6–12 of the main protocol.
6. Identify colonies that hybridize preferentially to the mutagenic oligonucleotide. Set up a number of small-scale liquid cultures in LB medium using individual colonies as inocula. Grow the cultures to saturation in the presence of the appropriate antibiotic.
7. Isolate superhelical phagemid DNA from each of the cultures by one of the methods described in Chapter 1.
8. Transform competent *E. coli* with each of the phagemid DNA preparations.
9. Prepare single-stranded phagemid DNA by superinfection of individual transformants as described in Chapter 3, Protocol 8.
10. Sequence the target DNA to verify the presence of the desired mutation and to confirm that no adventitious mutations have arisen.
11. Recover the mutated fragment by digestion of the phagemid vector with the appropriate restriction enzyme(s) and preparative gel electrophoresis. Clone the target DNA into an appropriate vector (if needed).
12. Confirm the presence of the mutation by Southern hybridization as described in Steps 19 and 20 of the main protocol.

**ALTERNATIVE PROTOCOL: DETECTION OF DEFINED MUTANTS BY PCR**

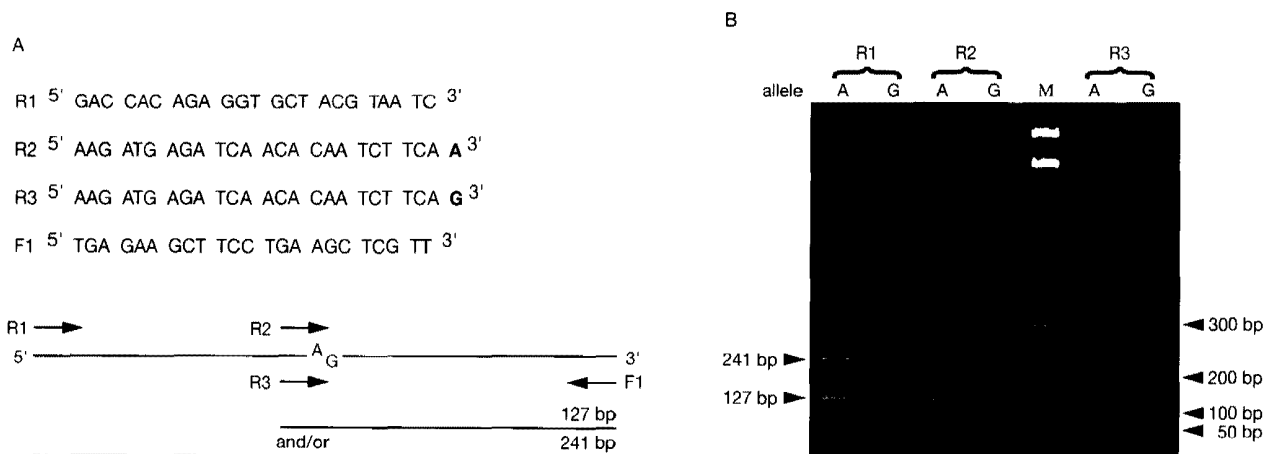
Several techniques have been described to screen DNA samples for the presence or absence of a defined mutation (Glisic and Alavantic 1996; Zhu and Clark 1996; Humbert and Elard 1997; Alavantic et al. 1998). All of these methods are built on the observation that PCRs require the 3'-terminal base of the oligonucleotide primer to be perfectly complementary to the DNA template. If the 3'-terminal base cannot form a conventional Watson-Crick base pair with the base in the corresponding position of the template, the efficiency of priming drops dramatically.

Figure 13-5 outlines the technique described by Glisic and Alavantic (1996), which requires four primers. Oligonucleotides 1 and 4 are forward and reverse primers for amplification of the target region containing the mutation site. Oligonucleotides 2 and 3 are allele-specific primers that anneal to a defined sequence within the target region and differ only in the 3'-terminal base: one of the oligonucleotides corresponds to the wild-type allele, and the other corresponds to the mutant allele. Two amplification reactions are set up, with 35 pmoles of oligonucleotides 1, 2, and 4 in one tube and identical amounts of oligonucleotides 1, 3, and 4 in the other tube. The template DNA can be mammalian genomic DNA (500 ng), yeast genomic DNA (10 ng), bacteriophage M13 DNA (1–5 pg), plasmid DNA (1–5 pg), or in fact any other DNA that may carry the defined mutation.

Amplification is carried out under standard PCR conditions and the products are analyzed by agarose gel electrophoresis. Both reactions should yield a prominent band of amplified DNA corresponding in size to the target region. This DNA, whose synthesis is primed by oligonucleotides 1 and 4, serves as a template for amplification by the allele-specific oligonucleotides. If the template DNA is homozygous, one of the two reactions should contain a second smaller band whose synthesis is primed by oligonucleotide 1 and either oligonucleotide 2 or oligonucleotide 3, depending on whether the template is mutant or wild-type. If the template DNA is heterozygous, both reactions will yield two bands.

The smaller band is usually present in lower molar concentration than the larger band. The reason is that amplification by the allele-specific oligonucleotide depends on prior amplification of the target region by oligonucleotides 1 and 4.

This method is simple, rapid, and robust, and can be used to screen many samples simultaneously. The disadvantage is that it requires four separate oligonucleotides and two amplification reactions.



**FIGURE 13-5 PCR Amplification of Specific Alleles**

(A) Primers R1 and F1 generate a 241-bp fragment, which serves as a template for either primer R2 or primer R3 that differ in their 3'-terminal nucleotide. Use of either primer R2 or R3 in combination with F1 generates a 127-bp fragment that matches either allele A or allele G. (B) Gel electrophoresis of the products of a PCR to detect a point mutation at nucleotide 12932 (codon 4311) in exon 29 of the *apoB* gene. Each sample is represented by two lanes of the gel. Sample 1 is homozygous for allele A, sample 2 is a heterozygote, and sample 3 is homozygous for allele G. (Lane M) DNA standards (AmpliSize; Bio-Rad). (Modified, with permission, from Glisic and Alavantic 1996 [©Elsevier Science].)

# Protocol 8

---

## Detection of Mutations by Single-strand Conformational Polymorphism and Heteroduplex Analysis

**D**ETECTION OF MUTATIONS IS ESSENTIAL FOR MOLECULAR CHARACTERIZATION, diagnosis, prevention, and treatment of inherited diseases of humans and, more generally, to correlate phenotype with genotype in organisms as diverse as mice and slime molds. The goal of mutation detection is to locate and precisely describe changes in DNA sequence that are responsible for particular phenotypes. The range of possible mutations is very great and includes deletions, insertions, inversions, translocations, transitions, and transversions. Some large-scale changes can be detected, for example, by cytochemical analysis of chromosomes or Southern blotting of genomic DNA. However, base-by-base comparison of wild-type and mutant DNAs is at present the only method to pinpoint mutations that affect single bases or groups of bases. Because sequencing of kilobase lengths of DNA is expensive, slow, and dreary, many different techniques have been developed to localize mutations and hence reduce sequencing to a minimum. These scanning methods differ widely in their power, accuracy, speed, and cost, and each can detect only a subset of mutations. At present, therefore, detection and localization of uncharacterized point mutations often require the sequential application of two or more scanning methods, followed by DNA sequencing to specify the mutation. The order in which these scanning methods are applied and their sensitivity vary from gene to gene and from mutation to mutation.

Scanning methods in common use are based on differences in electrophoretic migration and chromatographic behavior between mutant and reference (wild-type) DNAs. These methods, which include single-strand conformational polymorphism (SSCP; this protocol), heteroduplex analysis (HA; this protocol), denaturing gradient gel electrophoresis (DGGE), and, more recently, coupling ion-pair reversed-phase liquid chromatography, can map mutations to an accuracy of  $\pm 200$  bp. Dideoxyfingerprinting (ddf), a hybrid between dideoxysequencing and SSCP, is more difficult and expensive, but it is capable of mapping mutations with a resolution of  $\sim 10$  bp.

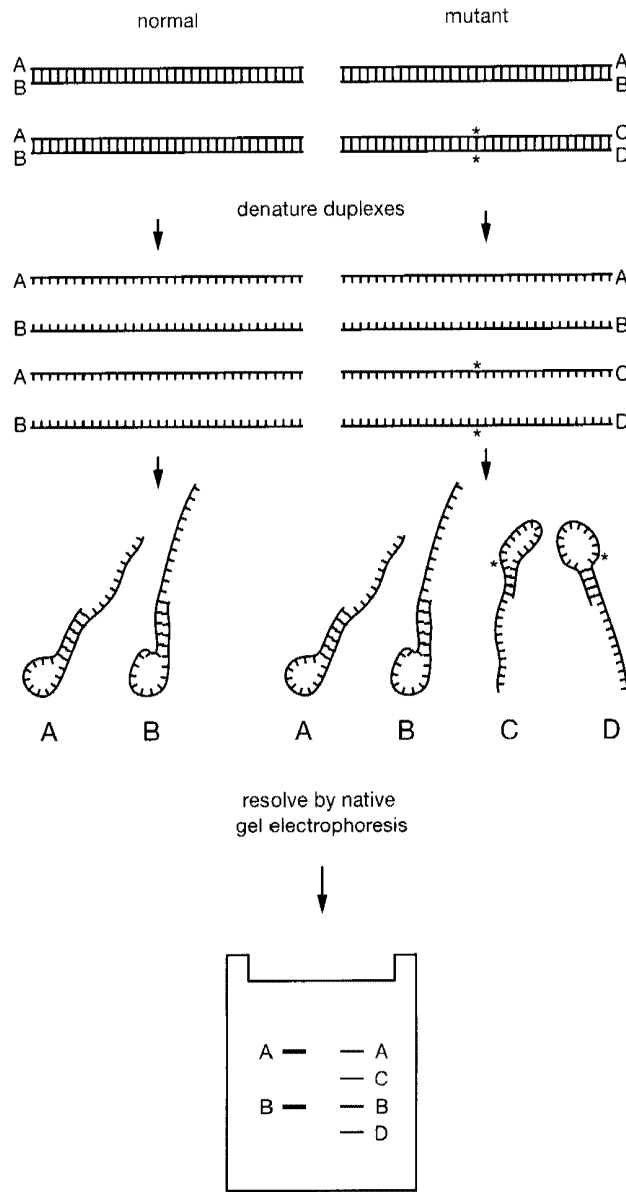
---

### SINGLE-STRAND CONFORMATIONAL POLYMORPHISM

---

SSCP involves three steps:

- amplification by PCR of the target region of the gene
- denaturation of the PCR product
- electrophoresis of the single-stranded DNA through a gel at neutral pH



**FIGURE 13-6 Schematic for Single-stranded Conformational Polymorphism**

A mixed population of DNA duplexes consisting of normal (wild type) as well as mutant sequences is denatured as described in the text, and the resulting single-stranded probes are resolved by electrophoresis under non-denaturing conditions.

Single-stranded DNA molecules fold into complex three-dimensional structures as a result of intrastrand base pairing. Single strands of equal length but different sequence can therefore vary considerably in electrophoretic mobility as a result of the looping and compaction caused by intrastrand pairing. Alteration of the nucleotide sequence of the molecule by as little as a single base can reshape the secondary structure, with consequent changes in electrophoretic mobilities through native gels (please see Figure 13-6). SSCP exploits the differences in mobility between wild-type and mutant strands of DNA (Orita et al. 1989a,b, 1990; Ainsworth et al. 1991; Dean and Gerrard 1991; Condie et al. 1993; Glavac and Dean 1993; for reviews, please see Fan et al. 1993; Axton and Hanson 1998; Jaeckel et al. 1998; Nataraj et al. 1999).

## Amplification

Both single- and double-stranded DNAs can be analyzed by SSCP. In each case, the DNA is amplified from genomic DNA templates by either conventional PCR or asymmetric PCR (PCR-SSCP). Using double-stranded DNA allows both strands of the target region to be analyzed simultaneously. This may be an advantage since the sensitivity of mutation detection is often greater for one strand of DNA than the other, and it is not possible to predict which strand will yield the best conformers for SSCP.

Most investigators find that the efficiency of detection of mutations is maximal when the DNA is 150–200 bases in length and decreases rapidly as the size of the DNA increases (Sheffield et al. 1993; Ravnik-Glavac et al. 1994). However, others report that the effects of fragment length are not so dramatic (Fan et al. 1993; Highsmith et al. 1999).

A majority of investigators use *Taq* or *Pfu* to catalyze amplification reactions, which are generally run under standard conditions. There is usually no need to remove unused primers or dNTPs before the sample is analyzed. However, it is important to minimize the production of nonspecific amplification products, whose presence can complicate the interpretation of results of gel electrophoresis.

## Denaturation

Before loading on the gel, double-stranded DNA is denatured by alkali or, more commonly, by a combination of formamide and heat. If the DNA has been amplified from a heterozygote, a proportion of the denatured complementary strands may reanneal to one another before the DNA is loaded onto the gel. A proportion of these molecules will be heteroduplexes formed by annealing of complementary wild-type and mutant strands. The presence of both single-stranded and heteroduplex DNAs in the same sample provides an opportunity to use two scanning methods simultaneously (SSCP and HA; see below). If the DNA under test has been amplified from a haploid organism or from a homozygous diploid, the formation of heteroduplexes can be promoted by adding an appropriate amount of the corresponding segment of wild-type (Axton and Hanson 1998). However, we recommend the simultaneous use of two scanning techniques only for those investigators who are fluent in SSCP and HA.

## Electrophoresis

Conformers of single-stranded DNA are separated by gel electrophoresis under non-denaturing conditions. Because their mobility varies considerably with temperature and ionic strength, it is usually necessary to analyze samples under two or more sets of conditions to obtain acceptable resolution of different conformers. Close to 100% of mutations can be detected if SSCP is carried out in a range of buffers and temperatures (e.g., 0.5x TBE at 4°C and 15°C or 0.5x TBE with and without compounds such as glycerol that are rich in hydroxyl groups [Glavac and Dean 1993; Hayashi and Yandell 1993; Highsmith et al. 1999; Liu et al. 1999]) (please see the information panel on **GLYCEROL**). Accurate control of temperature during electrophoresis is essential to prevent dissociation of intrastrand base pairs, destabilization of conformers, and, consequently, loss of resolution.

The sensitivity of SSCP varies with the type of gel matrix, with optimum results being obtained from cross-linked polyacrylamide. To achieve reproducibility, many investigators use premade commercial solutions of acrylamide and bisacrylamide (e.g., Acrylogel BDH). However, the best resolution is obtained from the Hydrolink series of gel matrices (Molinari et al. 1993); these are sold under the trade name of MDE (Mutation Detection Enhancement) by FMC BioProducts, Rockland, Maine.

## Detection

To suppress the formation of a surfeit of double-stranded molecules, only small amounts of DNA can be loaded onto thin (0.4 mm) gels. The conformers are then detected by autoradiography of PCR products or by staining of unlabeled DNA with SYBR Gold or silver. When thick (1 mm) gels are used, the DNA may be detectable by staining with ethidium bromide.

## Advantages and Disadvantages of SSCP

SSCP has dramatically improved the efficiency with which mutations can be identified by molecular analyses of mammalian tissues. The method can also be used to detect different mutant alleles arising from chemical mutagenesis, cassette mutagenesis, or site-directed mutagenesis with families of oligonucleotide mutagens. The technique requires no special equipment, is relatively straightforward to perform, is well suited to nonradioactive methods of detection, and can be adapted to a range of electrophoretic conditions.

A major disadvantage is that the technique is empirical. At present, there are no algorithms capable of accurately predicting the number of conformers of a segment of single-stranded DNA or their electrophoretic properties. Gels containing multiple bands can therefore be difficult to interpret. Finally, SSCP is capable of detecting almost 100% of mutations, but it may require a variety of electrophoretic conditions to do so.

The following protocol obtained from Daphne Davis (University of Texas Southwestern Medical Center, Dallas) describes SSCP analysis of a segment of human genomic DNA.

## MATERIALS

---

**CAUTION:** Please see Appendix 12 for appropriate handling of materials marked with <!.>.

### Buffers and Solutions

**Please see Appendix 1 for components of stock solutions, buffers, and reagents. Dilute stock solutions to the appropriate concentrations.**

*10x Amplification buffer*

*dNTP solution (PCR grade) containing all four dNTPs, each at a concentration of 1 mM (pH 7.0)*

*Formamide-loading buffer <!.>*

*Sucrose gel-loading buffer (buffer type I)*

*10x TBE electrophoresis buffer*

Use TBE at a working strength of 1x (89 mM Tris-borate, 2 mM EDTA) for polyacrylamide gel electrophoresis. Use of the 1x TBE concentration provides the necessary buffering power. The pH of the buffer should be 8.3. It is generally not necessary to adjust the pH; however, check this variable with each new batch of 10x TBE stock prepared in the laboratory.

Use the same stock of 10x TBE to prepare both the gel and the running buffers. Small differences in ionic strength or pH produce buffer fronts that can greatly distort the DNA bands.

### Enzymes and Buffers

*Restriction enzymes (optional)*

*Thermostable DNA polymerase*

*Taq DNA polymerase is recommended.*

### Nucleic Acids and Oligonucleotides

*Human genomic DNA to be screened for point mutations*

*Dissolve the DNA at 10 µg/ml in TE (pH 7.6).*

*Oligonucleotide primers, forward and reverse (35 µM each) in TE (pH 7.6)*

### Radioactive Compounds

*[α-<sup>32</sup>P]dCTP (3000 Ci/mmol, 10 mCi/ml) <!.>*



## Gels

### *Acrylamide:bisacrylamide (29:1%; w/v) <1>*

Many investigators use premade commercial solutions of acrylamide and bisacrylamide (e.g., Acrylogel, BDH). However, the best resolution of conformers is obtained from the Hydrolink series of gel matrices (Molinari et al. 1993), which are sold under the trade name of MDE (Mutation Detection Enhancement) by FMC BioProducts (Rockland, Maine).

### *Ammonium persulfate (10% w/v) <1>*

#### *Glycerol*

Use a highly purified grade, such as UltraPure (Life Technologies). Please see the information panel on **GLYCEROL**.

### *TEMED (N,N,N',N'-tetramethylethylenediamine) <1>*

Electrophoresis-grade TEMED is sold by many manufacturers including Sigma and Bio-Rad. TEMED is hygroscopic and should be stored in a tightly sealed bottle at 4°C.

TEMED is used as an adjunct catalyst for the polymerization of acrylamide.

## Special Equipment

*Barrier tips for automatic micropipettor*

*Boiling-water bath*

*Electrophoresis plates, glass (two 40 × 40 cm) with 0.4-mm spacers*

*Gel-drying apparatus*

*Glass capillary tube (drawn-out) or Micropipettor with gel-loading tips*

*Hamilton syringe or Pasteur pipette*

*Microfuge tubes (0.5 ml, thin-walled for amplification)*

*Positive-displacement pipette*

*Thermal cycler programmed with desired amplification protocol*

If the thermal cycler is not equipped with a heated lid, use either light mineral oil or paraffin wax to prevent evaporation of liquid from the reaction mixture during PCR.

*Water bath(s) preset to the appropriate temperature(s) for restriction endonuclease digestion*

*Whatman 3MM filter paper*

## METHOD

### Amplification of the DNA to be Screened for Point Mutations

1. In a sterile 0.5-ml microfuge tube, mix in the following order:

1 mM dNTP solution	1 μl
10x amplification buffer	2 μl
35 μM 5'-oligonucleotide solution	1 μl (35 pmoles)
35 μM 3'-oligonucleotide solution	1 μl
10 μCi/μl [ $\alpha$ - <sup>32</sup> P]dCTP	1 μl
human genomic DNA	10 μl (100 ng)
thermostable DNA polymerase	1–3 units
H <sub>2</sub> O	to 20 μl

[ $\alpha$ -<sup>32</sup>P]dCTP is incorporated in the PCRs to label the amplified DNA uniformly. <sup>32</sup>P-labeled oligonucleotide primers can be used in place of [ $\alpha$ -<sup>32</sup>P]dCTP to produce an end-labeled DNA.

If possible, set up control reactions using two DNA samples known to contain alleles that differ in sequence by one or more base pairs and that are known to resolve on SSCP gels. In addition, set up a contamination control in which no template DNA is added to the reaction.

2. If the thermal cycler is not fitted with a heated lid, overlay the reaction mixtures with 1 drop (~50 μl) of light mineral oil to prevent evaporation of the samples during repeated cycles of heating and cooling. Alternatively, place a bead of paraffin wax into the tube if using a hot start protocol. Place the tubes in the thermal cycler.

- Amplify the nucleic acids using the denaturation, annealing, and polymerization times and temperatures listed in the table. For advice on thermal cycler programs, please see Chapter 8, Protocol 1.

Cycle Number	Denaturation	Annealing/Polymerization
30 cycles	5–30 sec at 94°C	0.5–1 min at 68°C
Last cycle	1 min at 94°C	5–10 min at 68°C

These times are suitable for 50- $\mu$ l reactions assembled in thin-walled 0.5-ml tubes and incubated in thermal cyclers such as the Perkin-Elmer 9600 or 9700, Master Cycler (Eppendorf), and PTC 100 (MJ Research). Times and temperatures may need to be adapted to suit other types of equipment and reaction volumes.

### Preparation of the SSCP Gel

- While the thermal cycler program is running, prepare a 5.5% polyacrylamide gel containing 10% (v/v) glycerol in 1x TBE gel buffer.

10x TBE gel buffer	10 ml
29:1% acrylamide:bisacrylamide solution	18 ml
10% ammonium persulfate	0.5 ml
glycerol	10 ml
H <sub>2</sub> O	61.5 ml

Mix the reagents by gentle swirling or stirring.

This volume of gel solution is sufficient for one polyacrylamide gel of standard size (40 x 40-cm plates with 0.4-mm spacers). The volume of the gel solution can be increased or decreased as needed for other gel sizes.

Use the same stock of 10x TBE gel buffer to prepare enough 1x TBE gel buffer to fill the tanks of the electrophoresis apparatus.

- Assemble and tape together two 40 x 40-cm glass electrophoresis plates with 0.4-mm spacers. To obtain maximum resolution of single-stranded DNA conformers, it is important to use “thin-gel” spacers that are less than or equal to 0.4 mm in thickness.
- Add 100  $\mu$ l of TEMED to the gel solution. Mix the solution by gently swirling the flask, and pour the gel.
 

Work quickly as the acrylamide solution will polymerize rapidly. For instructions on pouring thin gels, please see Chapter 12, Protocol 8.
- Assemble the polymerized gel into an electrophoresis apparatus at room temperature. Fill the buffer tanks with 1x TBE gel buffer made from the same stock as the gel solution.

### Preparation of Samples for SSCP Electrophoresis

- (Optional) If the amplified DNA fragment is to be digested with a restriction enzyme, remove the PCR tubes from the thermal cycler at the end of the run and place them on ice. Set up the following restriction enzyme digestion:

PCR solution	5 $\mu$ l
10x restriction enzyme buffer	4 $\mu$ l
restriction enzyme (2–50 units)	2 $\mu$ l
H <sub>2</sub> O	29 $\mu$ l

Incubate for 1–2 hours at the temperature appropriate for the restriction enzyme.

The ability of SSCP gels to resolve point mutations and polymorphisms decreases as a function of the size of DNA fragment. The simplest way to resolve sequence differences in longer DNA fragments is to digest the double-stranded DNA before electrophoresis with a restriction enzyme that produces fragments 200–300 bp in length. This strategy is especially helpful when screening for polymorphisms in the introns of a gene or for detecting mutations that reside in long exons. If the DNA sequence of the fragment is known, then an appropriate restriction enzyme can be identified with ease. If the DNA sequence is not known, then a random assortment of enzymes (e.g., *AluI*, *DdeI*, *HaeIII*, *HinfI*, *MspI*, *RsaI*) that recognizes 4-bp sequences may be used. Cleaving the DNA with a battery of frequently cutting enzymes will often result in the point mutation/polymorphism being located at different distances from the end of the DNA and in fragments of different sizes. Both features can affect the migration of the resulting single-stranded conformers by SSCP. Finally, digesting a 200–300-bp DNA into two or more smaller fragments followed by SSCP analysis will often resolve an otherwise undetectable mutation.

9. Dilute either 1.5  $\mu$ l of the original PCR (from Step 3) or 5  $\mu$ l of the restriction-enzyme-digested PCR (from Step 8) into 20  $\mu$ l of sucrose gel-loading buffer. Dilute similar aliquots into 20  $\mu$ l of formamide dye mix.

The samples diluted into formamide dye mix will be denatured, whereas those diluted into sucrose gel-loading buffer will remain double-stranded and serve as controls.

10. Boil the formamide-containing samples for 6 minutes, and then plunge the tubes directly into ice.

### Separation and Analysis of DNA Fragments by SSCP Gel Electrophoresis

11. Use a Pasteur pipette or a Hamilton syringe to wash out the wells of the polyacrylamide gel with 1 $\times$  TBE gel buffer. With a drawn-out glass capillary tube or a micropipettor equipped with a gel-loading tip, load 2  $\mu$ l of each sample on the polyacrylamide gel.
12. Apply 6–7 V/cm ( $\sim$ 250 V [and 15 mA] for a 40  $\times$  40-cm gel) to the gel for  $\sim$ 14 hours.
13. At the completion of electrophoresis, separate the glass plates, and transfer the gel to a sheet of Whatman 3MM filter paper. Dry the gel on a vacuum dryer for 30–60 minutes.
14. Subject the dried gel to autoradiography for 4–16 hours at room temperature without an intensifying screen.

The nondenatured PCR samples (i.e., those diluted into the sucrose gel-loading buffer) will migrate through the gel as double-stranded DNAs. By contrast, the denatured samples (i.e., those resuspended in formamide dye mix and boiled) will usually migrate as a mixture of double-stranded and single-stranded DNAs. The single-stranded DNAs will generally migrate through polyacrylamide gels more slowly than the double-stranded molecules (Maxam and Gilbert 1977, 1980; Szalay et al. 1977). Only one single-stranded band will be detected if the two complementary strands of the DNA fold into conformations that cannot be resolved by SSCP. Two single-stranded DNA bands will be detected if the complementary strands fold into resolvable conformers. The PCR product of a heterozygous allele from a diploid organism should generate at least four bands, two whose mobility should be identical to that of the wild-type bands and two that are characteristic of the particular mutation. Often, however, there will be more than two bands, either as a consequence of genetic heterogeneity in the sample or because the two complementary strands of a DNA molecule each fold into more than one conformer. The patterns can be quite complex and are not easily predictable based on DNA sequence, base composition, or fragment length; however, a given pattern is often diagnostic for a particular mutation.

**TROUBLESHOOTING: GEL VARIATIONS**

This protocol resolves ~75% of all single-base-pair changes in DNA fragments of <300 bp. If the results are not satisfactory, there are a multitude of different gel conditions that can be used to resolve single-stranded DNA conformers. For example:

- Carry out electrophoresis for 12–16 hours at 4–6°C.
- Cast a polyacrylamide gel as described above, but with either 5% (v/v) glycerol or no glycerol. Carry out electrophoresis for 12–16 hours at 4–6°C.
- Cast a polyacrylamide gel using a high-resolution gel solution such as Mutation Detection Gel Solution (e.g., MDE Gel Solution FMC Bioproducts, Maine). This solution contains a proprietary vinyl polymer in place of acrylamide. MDE gels resolve some single-stranded DNA conformers better than polyacrylamide gels. Because double-stranded DNAs migrate more rapidly on these gels than they do on polyacrylamide SSCP gels, the single-stranded DNAs are often the only fragments detected by autoradiography. Follow the manufacturer's instructions for pouring MDE gels and note that a different strength TBE buffer is usually used.
- Load different volumes of the starting amplification reaction (after denaturation) on the SSCP gel. In some cases, loading less DNA decreases the chance that the separated single strands will reanneal with one another and will instead form intrastrand hydrogen-bonded structures that are separated on the SSCP gel.
- Dilute the PCR into an SDS-containing buffer before electrophoresis. In the above example, dilute 1.5  $\mu$ l of the PCR with 8.5  $\mu$ l of 0.1% (w/v) SDS in 10 mM EDTA and 10  $\mu$ l of formamide dye mix. Boil the sample as described in Step 10, and analyze 2  $\mu$ l of the denatured DNA on an SSCP gel. For unknown reasons, the presence of SDS sometimes facilitates the resolution of single-stranded DNA conformers.
- Substitute 1x TBE gel buffer containing 20 mM HEPES for 1x TBE gel buffer in the protocol. This simple addition greatly changes the electrophoretic mobilities of the single-stranded DNAs. Greater than 95% of conformers in DNA fragments  $\leq$  350 bp (Liu and Sommer 1998) can be resolved using two gels, one containing 1x TBE gel buffer, and the other containing 1x TBE gel buffer supplemented with 20 mM HEPES.
- Add urea (5%) or formamide (5%) to the gel buffer to prevent smearing of conformers with high contents of G+C (Glavac and Dean 1993). Addition of higher concentrations of urea produces ultrasharp bands but also a decrease in sensitivity of SSCP (Liu et al. 1999).

# Protocol 9

---

## Generation of Sets of Nested Deletion Mutants with Exonuclease III

**N**ESTED DELETION MUTANTS LACKING PROGRESSIVELY MORE NUCLEOTIDES from one end or the other of a target DNA are used to define the boundaries of functional *cis*-acting control elements or, more rarely these days, as templates for directed DNA sequencing. The methods rely on nucleases such as BAL 31, pancreatic DNase I, or exonuclease III, which digest DNA in a predictable fashion. Of these enzymes, exonuclease III is by far the best:

- The exonucleolytic reaction proceeds at a remarkably uniform and predictable rate, making possible the simultaneous isolation both of nested deletions and of groups of deletions with tightly clustered endpoints.
- The method is not restricted to any particular vector.
- The entire series of enzymatic reactions (exonuclease digestion, treatment with nuclease S1/mung bean nuclease, and recircularization) can be carried out in a single set of tubes without purification of intermediate products (Henikoff 1984, 1987, 1990).

In the method described by Henikoff (1984), the double-stranded DNA of recombinant plasmid, phagemid, or bacteriophage M13 replicative form DNA is digested with two restriction enzymes whose sites of cleavage both lie between one end of the target DNA and the binding site of a universal primer. The enzyme that cleaves nearer the target sequence must generate either a blunt end or a recessed 3' terminus; the other enzyme must generate a 4-nucleotide protruding 3' terminus. Because only the blunt or recessed 3' terminus of the resulting linear DNA is susceptible to exonuclease III, digestion proceeds unidirectionally away from the site of cleavage and into the target DNA. The exposed single strands are then removed by digestion with nuclease S1 or mung bean nuclease, and the DNA is then recircularized. If desired, a synthetic linker can be inserted at the site of recircularization.

The only significant limitation of the method is the requirement for an appropriate restriction site at one end of the target DNA that is not susceptible to attack by exonuclease III. However, in practice, this limitation is not a serious impediment. The range of cloning sites currently available in bacteriophage M13, phagemid, and plasmid vectors is so large that it is almost always possible to find a vector that is suitable for the particular target fragment under study. In those rare instances when no suitable restriction site is available, recessed 3' termini can be protected from attack by filling with the Klenow fragment of *E. coli* DNA polymerase I and  $\alpha$ -thiophosphate dNTPs (Guo and Wu 1983; Jasin et al. 1983). Alternatively, a protective "buffer" fragment can be

inserted between the site of cleavage and the flanking vector sequences (Haltiner et al. 1985). If the buffer fragment is long enough, the progressive removal of the target DNA by exonuclease III is unlikely to be accompanied by loss of essential sequences from the flanking vector.

For this mutagenesis procedure to be effective, it is essential that digestion of the template DNA by the appropriate restriction enzymes be complete. However, if the two restriction sites are close to each other, complete digestion may require digesting for extended times with large amounts of one or both enzymes, which may lead to nicking of the template. Because exonuclease III efficiently attacks the 3' end of a nick (Masamune et al. 1971), deletions may then be generated in undesirable locations in both the vector and the target DNA. In our hands, this problem remains largely a theoretical possibility that occurs rarely in practice. We therefore recommend the use of a protocol based on digestion of the template DNA with two restriction enzymes, as described by Henikoff (1984).

## MATERIALS

---

**CAUTION:** Please see Appendix 12 for appropriate handling of materials marked with <!.>.

### Buffers and Solutions

**Please see Appendix 1 for components of stock solutions, buffers, and reagents. Dilute stock solutions to the appropriate concentrations.**

*dNTP solution containing dATP, dGTP, and dTTP, each at 0.5 mM in 25 mM Tris-Cl (pH 8.0)*

*Ethanol (100%, ice cold, and 70%, room temperature)*

*10x Exonuclease III buffer*

660 mM Tris-Cl (pH 8.0)

66 mM MgCl<sub>2</sub>

100 mM β-mercaptoethanol <!.>

*Nuclease S1 stop mixture*

0.3 M Tris base

50 mM EDTA (pH 8.0)

*Phenol:chloroform <!.>*

*Sodium acetate (3 M, pH 5.2)*

### Enzymes and Buffers

*Exonuclease III*

The quality of exonuclease III varies from manufacturer to manufacturer and should be checked in analytical digests before large-scale preparation of nested deletion templates.

*Klenow mixture (sufficient for 30 samples)*

H<sub>2</sub>O 20 μl

1 M MgCl<sub>2</sub> 6 μl

0.1 M Tris-Cl (pH 7.6) 3 μl

Klenow fragment 3 units

Prepare this mixture on ice just before use.

*Ligase mixture (sufficient for 24 samples)*

H<sub>2</sub>O 550 μl

10x bacteriophage T4 ligation buffer 100 μl

5 mM rATP 100 μl

polyethylene glycol (30% w/v PEG 8000) <!.> 250 μl

bacteriophage T4 DNA ligase 5 Weiss units

Prepare this mixture on ice just before use.

*Nuclease S1 reaction mixture*

H <sub>2</sub> O	172 $\mu$ l
10x S1 buffer	27 $\mu$ l
nuclease S1	60 units

Prepare this mixture just before use.

Mung bean nuclease can be substituted for nuclease S1 in this reaction mixture.

*Restriction enzymes (two)*

For a discussion on choice of enzymes and engineering their recognition sites properly into the target DNA, please see the introduction to this protocol and the information panel on **EXONUCLEASE III**.

**Gels**

Agarose gels (two), 1% (w/v) agarose

**Nucleic Acids and Oligonucleotides***Target DNA*

Analyze the sequence of the target DNA for the presence of suitable restriction sites. Clone the DNA to be digested into a plasmid or bacteriophage vector that contains as few nonessential sequences as possible. Analyze an aliquot of the preparation of recombinant plasmid DNA that is to be used as a substrate for mutagenesis by agarose gel electrophoresis in TAE buffer (please see Chapter 5, Protocol 1). The plasmid must be >90% superhelical molecules. Repurify the preparation if any linear or >10% nicked or relaxed plasmids are detected.

Because exonuclease III will initiate digestion from single-strand nicks, it is important that the template DNA consist predominantly of closed circular molecules. Purification of the template has the added advantage of removing small pieces of DNA and RNA from the closed circular DNA preparation. These can interfere with digestion by exonuclease III.

**Special Equipment**

Microfuge tubes (0.5 ml) or Microtiter plates with "U"-shaped wells (e.g., Baxter B1190-17)  
Waterbaths preset to 30°C, 37°C, and 70°C

**Additional Reagents**

Step 14 of this protocol requires the reagents listed in Chapter 1, Protocol 24, 25, or 26 (for transformation).

Step 15 of this protocol requires the reagents listed in Chapter 1, Protocol 1 or 4 (for minipreparation of plasmid DNA) or in Chapter 3, Protocol 3 (for preparation of replicative form of M13 DNA).

Step 16 of this protocol requires the reagents listed in Chapter 12, Protocol 3, 4, or 5.

**METHOD**

1. Digest 10  $\mu$ g of target DNA (recombinant bacteriophage M13 replicative form DNA, phagemid DNA, or plasmid DNA) with two restriction enzymes that cleave the polycloning site between the primer-binding site of the vector and the target DNA.

To maximize the efficiency of cleavage, avoid using restriction sites located immediately adjacent to each other in a polycloning site. Perform the digests under conditions of low DNA concentration and large reaction volume with the appropriate buffer recommended by the enzyme's manufacturer. Digest first with the restriction enzyme that generates the blunt or recessed 3' terminus. When all of the closed circular DNA has been converted to linear DNA, as confirmed by agarose gel electrophoresis, adjust the buffer and add the second enzyme. Alternatively, perform a standard phenol:chloroform extraction and ethanol precipitation, and set up a fresh digestion in the appropriate buffer for the second enzyme. Any DNA that escapes cleavage by the second enzyme will be digested in both directions by exonuclease III and will therefore be unlikely to generate viable

clones. The efficiency of cleavage by the second restriction enzyme can be checked by end labeling with  $^{32}\text{P}$  the first cleavage site and checking for the subsequent loss of ~50% of the radiolabel.

If difficulties are encountered in cleaving the template DNA to completion with two restriction enzymes, we recommend using a commercial kit based on a method described by Henikoff (1990). In this procedure, single-stranded circular phagemid DNA is used as a template for extension of an oligonucleotide primer by bacteriophage T4 DNA polymerase. This reaction generates a double-stranded circular molecule containing a small nick or gap immediately 5' to the primer. Exonuclease III is then used to resect the resulting 3' end, and the exposed single-stranded DNA is removed by digestion with a single-strand-specific endonuclease (nuclease S1 or mung bean nuclease). The resulting set of linear nested DNA fragments have a common terminus corresponding to the 5' end of the primer. These deleted molecules are then recircularized and used to transform cells. This method has the advantages that nested deletions can be made from any point in the target DNA and that the enzymatic reactions can be carried out sequentially in a single tube; thus, there is no need to extract the solution with organic solvents or to precipitate the DNA.

Several commercial kits are available for construction of deletion mutants using Henikoff's (1990) method (please see the information panel on **COMMERCIAL KITS FOR SITE-DIRECTED MUTAGENESIS**).

2. Purify the DNA by standard extraction with phenol:chloroform and precipitation with ethanol. Carefully remove the supernatant, and add 0.5 ml of 70% ethanol to the pellet.  
Rinsing the pellet with ethanol is important because sodium ions inhibit exonuclease III (Hoheisel 1993) (please see the information panel on **EXONUCLEASE III**).
3. Recover the washed pellet of DNA by centrifuging at maximum speed for 2 minutes at 4°C in a microfuge, and then carefully remove the supernatant. Incubate the open tube on the bench to allow the last traces of ethanol to evaporate, and then dissolve the DNA in 60  $\mu\text{l}$  of 1 $\times$  exonuclease III buffer. Store the dissolved DNA on ice.
4. Place 7.5  $\mu\text{l}$  of nuclease S1 reaction mixture in each of 25 0.5-ml microfuge tubes or in 25 wells of a 96-well microtiter plate with U-shaped wells. Store the microtiter plate or microfuge tubes on a bed of ice.
5. Incubate the DNA solution prepared in Step 3 for 5 minutes at 37°C. Transfer 2.5  $\mu\text{l}$  of the solution to the first microfuge tube or well of the microtiter plate containing the nuclease S1 reaction mixture.
6. To the remainder of the DNA solution, add 150 units of exonuclease III per pmole of recessed 3' termini (1 unit of exonuclease III will generate 1 nmole of acid-soluble total nucleotide in 30 minutes at 37°C). Tap the tube to mix the contents and immediately return the tube to the 37°C water bath.

Under these conditions, the amount of exonuclease III is saturating, and ~200 nucleotides per minute are removed from the blunt end or recessed 3' terminus of each of the DNA molecules in the solution. More or less DNA can be removed by varying the intervals between successive samples. In general, the rate of exonucleolytic digestion of DNA, which determines the range of the exonuclease III digestion endpoints, varies depending on the molar ratio of enzyme to template. To ensure that all DNA templates are degraded at the same rate and that synchronicity is maintained over several kilobases of DNA fragment, exonuclease III must be present in excess in the digestion reaction.

The rate of exonuclease digestion can also be controlled by carrying out the digestion reactions at different temperatures. Henikoff (1987) estimates that a 2°C difference in temperature in the range of 30–40°C can change the rate of digestion by 100 bases/minute.

7. At 30-second intervals, remove 2.5- $\mu\text{l}$  samples of the DNA solution and place them in successive microfuge tubes or wells of the microtiter plate containing the nuclease S1 reaction mixture.
8. When all of the samples have been harvested, incubate the microfuge tubes or microtiter plate containing the nuclease S1 and digested plasmid DNA for 30 minutes at 30°C.



9. Add 1  $\mu$ l of nuclease S1 stop mixture to each of the microfuge tubes or wells and incubate the reaction mixtures for 10 minutes at 70°C.  
Heating to 70°C inactivates nuclease S1 and any residual exonuclease III. For further information on these enzymes, please see the information panels on **NUCLEASE S1** in Chapter 7 and **EXONUCLEASE III** at the end of this chapter.
10. Transfer the microfuge tubes or microtiter plate to a bed of ice and analyze aliquots of each of the samples by agarose gel electrophoresis.  
Choose a concentration of agarose that will allow maximum discrimination between the original DNA and fragments that are smaller in size by up to 2 kb.
11. Pool the samples containing DNA fragments of the desired size. Add 1  $\mu$ l of Klenow mixture for each 10  $\mu$ l of pooled sample and incubate the reaction mixture for 5 minutes at 37°C.
12. For each 10  $\mu$ l of pooled sample, add 1  $\mu$ l of 0.5 mM dNTPs. Continue incubation for 15 minutes at room temperature.  
The initial brief incubation with the Klenow enzyme in Step 11 is carried out in the absence of dNTPs to allow the 3' exonuclease activity of the enzyme to remove any remaining protruding 3' termini from the digested DNA.
13. Add 40  $\mu$ l of T4 bacteriophage ligase mixture for each 10  $\mu$ l of pooled sample. Mix and continue incubation for 2 hours at room temperature.
14. Transform the appropriate *E. coli* host with aliquots of the ligated DNA.
15. Prepare minipreparations of bacteriophage M13 replicative form DNA, plasmid, or phagemid DNA from at least 24 randomly selected plaques or colonies.
16. Linearize the DNAs by digestion with an appropriate restriction enzyme and analyze their sizes by electrophoresis through a 1% agarose gel. Include the original plasmid or bacteriophage DNA that has been linearized by restriction enzyme digestion as a marker. Choose clones of an appropriate size for sequencing (Chapter 12) or additional restriction enzyme mapping.  
Approximately 80–90% of the deletions will typically retain a universal or reverse primer-binding site and can be sequenced using the appropriate oligonucleotides. For DNA sequencing, it is best to select clones that differ in size by ~400 bp to ensure that an overlapping set will be analyzed. For appropriate DNA sequencing protocols using the religated and retransformed DNAs, see Chapter 12.

# Protocol 10

---

## Generation of Bidirectional Sets of Deletion Mutants by Digestion with BAL 31 Nuclease

**I**N THIS METHOD, THE NUCLEASE BAL 31 (purified from the marine bacterium *Alteromonas espejiana* BAL 31) is used to make uni- or bidirectional deletions in a segment of cloned DNA. BAL 31 is a complex enzyme and tends to digest a population of double-stranded DNA targets in an asynchronous fashion (please see the information panel on **BAL 31**). The resulting deletions are therefore far more heterogeneous in size than those created by processive enzymes such as exonuclease III (please see Protocol 9).

### MATERIALS

---

**CAUTION:** Please see Appendix 12 for appropriate handling of materials marked with <!.>.

#### Buffers and Solutions

Please see Appendix 1 for components of stock solutions, buffers, and reagents. Dilute stock solutions to the appropriate concentrations.

5x BAL 31 buffer

2.5 M NaCl

62.5 mM CaCl<sub>2</sub>

62.5 mM MgCl<sub>2</sub>

100 mM Tris-Cl (pH 8.0)

dNTP solution of all four dNTPs, each at 0.5 mM

EGTA (0.5 M, pH 8.0)

Ethanol

Phenol:chloroform (1:1, v/v) <!.>

Sodium acetate (3 M, pH 5.2)

Sucrose gel-loading buffer

TE (pH 7.6)

#### Enzymes and Buffers

Bacteriophage T4 DNA polymerase

BAL 31 nuclease

Klenow fragment of *E. coli* DNA polymerase I

Restriction endonucleases

Please see Steps 3, 23, and 31.

## Gels

### *Agarose gels*

Please see Steps 3 and 32.

### *Agarose gel (0.8%) containing 0.5 µg/ml ethidium bromide <math>\langle ! \rangle</math>*

Please see Step 11.

### *Agarose gel cast in TBE containing 0.5 µg/ml ethidium bromide*

Please see Step 25.

### *Preparative agarose gel*

Please see Step 27.

## Nucleic Acids and Oligonucleotides

*Marker DNA for gel electrophoresis*

## Special Equipment

*Stopwatch*

*Water baths preset to 65°C and to the appropriate temperature(s) for restriction endonuclease digestion*

## Additional Reagents

*Step 1 of this protocol requires the reagents listed in Chapter 1, Protocols 17–19, or the reagents listed in Chapter 3, Protocol 6.*

*Step 2 of this protocol requires the reagents listed in Chapter 1, Protocol 9.*

*Step 27 of this protocol requires the reagents listed in Chapter 5, Protocol 4, 5, 6, or 7.*

*Step 30 of this protocol requires the reagents listed in Chapter 1, Protocols 23–26, or the reagents listed in Chapter 3, Protocol 6 or 8.*

*Step 31 of this protocol requires the reagents listed in Chapter 1, Protocol 1, or the reagents listed in Chapter 3, Protocol 3.*

*Step 34 of this protocol requires the reagents listed in Chapter 12, Protocol 3, 4, or 5.*

## METHOD

---

### Preparation of Target DNA for Digestion by BAL 31

1. Clone the target fragment into an appropriate plasmid or bacteriophage M13 vector.  
If deletion mutants are to be constructed from both termini of the target DNA, it will be necessary to clone the parental target DNA in both orientations with respect to the polycloning site in an appropriate vector.
2. Purify the closed circular recombinant DNA(s) by column chromatography on Qiagen columns (or their equivalent) and precipitation with ethanol. Redissolve the DNA in the smallest practical volume of Tris/EDTA.  
It is essential to use highly purified closed circular DNA (i) to minimize the contribution of contaminating RNA and small fragments of *E. coli* chromosomal DNA to the total concentration of termini in the reaction and (ii) to eliminate nicked circular molecules, which are degraded by BAL 31 from the site of the nick.
3. Digest 30 µg of the closed circular DNA to completion with a restriction endonuclease that cleaves at one end of the target DNA. This site defines the common point from which the nested deletions will begin. Use agarose gel electrophoresis to verify that digestion with the restriction endonuclease is complete.

4. Purify the DNA by extraction with an equal volume of phenol:chloroform. Separate the aqueous and organic phases by centrifugation at maximum speed for 3 minutes at 0°C in a microfuge, and then transfer the aqueous phase to a fresh microfuge tube.
5. Add 0.1 volume of 3 M sodium acetate (pH 5.2) and 2 volumes of ice-cold ethanol. Store the tube for 10 minutes at 0°C, and then recover the DNA by centrifugation at maximum speed for 10 minutes at 4°C in a microfuge.
6. Remove the supernatant, and wash the pellet of DNA carefully with 70% ethanol at room temperature. Dry the pellet at room temperature, and dissolve it in TE (pH 7.6) at a concentration of 1 µg/µl. Store the DNA at -20°C.

### Assaying BAL 31 Activity

Most commercial preparations of BAL 31 contain two kinetically distinct forms of the enzyme: a fast form and a slow form (please see the information panel on **BAL 31**). The slow form is a proteolytic degradation product of the fast form. The rate at which BAL 31 digests DNA is a function of the proportion of the fast and slow forms in the particular preparation of the enzyme used. Pure preparations of the fast form are available (Wei et al. 1983), but they are expensive and, in any case, they frequently decay into the slow form during storage. To preserve BAL 31 in the fast form, do not freeze the enzyme, and store it at 4°C.

Because the ratio of fast and slow forms of BAL 31 varies from preparation to preparation, it is essential to assay the activity of the particular batch of enzyme that will be used to generate deletions.

7. In a microfuge tube, mix:
 

linearized DNA (1 µg/µl)	4 µl
H <sub>2</sub> O	48 µl
5x BAL 31 buffer	13 µl

Dispense 9 µl of this mixture into each of seven separate microfuge tubes.

8. Make a series of seven twofold dilutions of BAL 31 in 1x BAL 31 buffer. Enzyme dilution is best carried out by placing seven aliquots (2 µl) of 1x BAL 31 buffer on the surface of a piece of Parafilm lying on a bed of ice or on a cold block. Use a disposable micropipette tip to mix 2 µl of the BAL 31 preparation under test with the first drop. Use a fresh tip to transfer 2 µl of the mixture to the next drop, and again mix. Continue in this fashion until the enzyme has been added to all of the drops. Working quickly, add 1 µl of each of the last six dilutions to six of the microfuge tubes containing the linear DNA being tested. Do not add enzyme to the seventh tube.

Most commercial preparations of BAL 31 are supplied at a concentration of ~1 unit/µl; 0.05–0.1 unit of most commercial preparations of BAL 31 is sufficient to digest 1 µg of a 2-kb segment of linear DNA to fragments <200 bp in length.

9. Incubate all of the microfuge tubes (including the tube that received no enzyme) for 30 minutes at 30°C.
10. Add 1 µl of 200 mM EGTA (pH 8.0) to each tube, and then heat the tubes for 5 minutes at 65°C.
 

BAL 31 requires Ca<sup>2+</sup> for activity and is therefore completely inhibited by EGTA. The enzyme is also inactivated by heating for 5 minutes at 65°C.
11. Mix each of the samples with 3 µl of agarose gel-loading buffer and analyze the size of the DNAs by electrophoresis through a 0.8% agarose gel containing 0.5 µg/ml ethidium bromide.

12. Examine the gel by UV illumination, and determine the dilution of enzyme just sufficient to digest the DNA to the point where only a smear of small (200-bp) fragments is detectable. This dilution of BAL 31 will be used in the large-scale digestion (Step 15).

Another way to check the progress of the BAL 31 digestion is to set up a large-scale digestion with BAL 31 and to withdraw aliquots at various times. Each of these aliquots is then digested with a restriction enzyme that cleaves the target fragment several times. As the digestion with BAL 31 proceeds, the restriction fragments disappear in a defined order. Knowing the size and map positions of the restriction fragments, it is possible to estimate the rate of BAL 31 digestion. The amount of enzyme added to the large-scale digest (below) should be sufficient to digest <20% of the length of the target fragment in the first 5 minutes of the reaction.

### Large-scale Digestion with BAL 31

13. Mix:
- |                          |        |
|--------------------------|--------|
| linearized DNA (1 µg/µl) | 20 µl  |
| H <sub>2</sub> O         | 240 µl |
| 5x BAL 31 buffer         | 65 µl  |

Incubate the mixture in a water bath at 30°C.

14. While the mixture is warming to 30°C, prepare a set of eight microfuge tubes, each containing 5 µl of 200 mM EGTA (pH 8.0). Label the tubes 1.5 minutes, 3.0 minutes, 4.5 minutes, etc.
15. Add 36 µl of the appropriate dilution of BAL 31 (please see Step 12) to the reaction mixture prepared in Step 13. Quickly mix the enzyme by tapping the side of the tube, and then return the tube to the water bath set at 30°C and start a stopwatch.
16. At 1.5-minute intervals, transfer 45 µl of the reaction mixture to the appropriately labeled microfuge tube. Store the tubes on ice until all of the samples have been collected.
17. Heat the tubes for 5 minutes at 65°C to inactivate the BAL 31.
18. Add 5 µl of 3 M sodium acetate (pH 5.2) to each tube, followed by 100 µl of ice-cold ethanol. Mix the solution by vortexing, and store the tubes on ice for 20–30 minutes.
19. Recover the DNAs by centrifugation at maximum speed for 10 minutes at 4°C. Remove the supernatants, and wash the pellets with 200 µl of ice-cold 70% ethanol. Centrifuge for a further 2 minutes.
20. Carefully remove the supernatants, and stand the open tubes at room temperature until all of the ethanol has evaporated. Dissolve each of the pellets in 23 µl of TE (pH 7.6).

### Isolation of Truncated Target Fragments

21. Add to each of the DNA preparations:
- |  |      |
|--|------|
| 0.5 mM dNTP solution                       | 3 µl |
| 10x polymerase buffer                      | 3 µl |
| bacteriophage T4 DNA polymerase (~5 units) | 1 µl |

Incubate the reactions for 15 minutes at room temperature, and then add ~1 µl (~5 units) of the Klenow fragment. Continue the incubation for a further 15 minutes at room temperature.

The use of two different DNA polymerases in the repair reaction results in an approximately three-fold increase in recovery of mutants.

22. Purify the DNAs by extraction with phenol:chloroform, and then precipitate the DNAs with ethanol as described in Steps 18–20. Dissolve each of the DNAs in 16  $\mu$ l of TE (pH 7.6).
23. To each DNA, add 2  $\mu$ l of the appropriate 10x restriction enzyme buffer and 8 units of a restriction enzyme that will separate the target DNA from the vector. Incubate the reactions for 1 hour at the appropriate temperature.
24. At the end of the incubation, transfer an aliquot (3  $\mu$ l) from each digest to a fresh microfuge tube. Store the remainder of the digests on ice until needed in Step 27.
25. Add 1  $\mu$ l of sucrose gel-loading buffer to each 3- $\mu$ l aliquot, and load the contents of each tube into the wells of an agarose gel cast in 0.5x TBE and containing 0.5  $\mu$ g/ml ethidium bromide. The wells at the sides of the gel should contain markers of the appropriate size.  
Cast the gel with a percentage of agarose that allows separation of the target fragment and the vector (please see Table 5-2, in the introduction to Chapter 5).
26. Separate the target fragments from the vector DNA by electrophoresis. Examine the gel by UV illumination, and determine which of the samples has been digested to an appropriate size by BAL 31.
27. Pool the samples (from Step 24) containing target DNA of the appropriate size, and isolate the target fragments by preparative gel electrophoresis. Recover the target DNA fragments from the gel using one of the methods described in Chapter 5, Protocols 4–7.
28. Estimate the amount of purified target DNA from the intensity of ethidium-bromide-mediated fluorescence (please see Appendix 8).

### Cloning of Deleted Target Fragments

29. Ligate the deleted target fragments with a plasmid, phagemid, or bacteriophage M13 vector (please see Chapter 1 or 3) that carries one blunt end and one terminus that is compatible with the restriction enzyme used in Step 23.

The exact composition and volume of the ligation reaction will depend on the amount of target DNA available. If possible, use between 50 and 100 ng of target DNA, and make sure that the molar ratio of vector DNA to target DNA is at least 5 (to minimize the number of recombinants that contain more than one fragment of target DNA). To maximize the formation of recombinants, the ligation reaction should be carried out under conditions that favor blunt-end ligation, i.e., in a small volume in the presence of high concentrations of bacteriophage T4 DNA ligase and polyethylene glycol and low concentrations of ATP. For details on ligation conditions, please see Chapter 1, Protocol 19.

30. Transform (plasmids or phagemids) or transfect (bacteriophage M13 replicative form DNA) competent *E. coli* of an appropriate strain with small aliquots or dilutions of the ligation mixture. The next day, grow small-scale cultures of 12 transformed colonies or bacteriophage M13 plaques, chosen at random.
31. Purify plasmid, phagemid, or bacteriophage M13 replicative form DNA from each of the 12 cultures by using one of the methods described in Chapter 1 or 3. Digest the DNAs with a restriction enzyme(s) that will liberate the target fragment from the vector.
32. Analyze the size of the target fragment liberated from each of the DNAs by agarose gel electrophoresis, using size markers of an appropriate size.

33. If the results are satisfactory (i.e., if the target fragments fall within the desired size range), pick a large number of individual transformed colonies or plaques and determine the size of the inserts as described above. Preserve those cultures that carry recombinants of the desired size.
34. Determine the exact endpoints of the deletion in each mutant by DNA sequencing (please see Chapter 12, Protocol 3, 4, or 5).

**BAL 31**

BAL 31, isolated from the marine bacterium, *Alteromonas espejiana* sp., is a calcium-dependent nuclease whose predominant activity against DNA is exonucleolytic. Magnesium ions are also required for full activity. BAL 31 contains:

- A 3'→5' **exonuclease activity** that removes mononucleotides from double-stranded DNA (Zhou and Gray 1990).
- A 5'→3' **exonuclease activity** that works efficiently on single-stranded DNA (Gray and Lu 1993).
- An **endonuclease that digests single-stranded DNA** slowly and cleaves a variety of torsionally strained DNA substrates, including negatively supercoiled DNA, junctions between left- and right-handed DNA (B-Z junctions), and superhelical DNAs carrying apurinic sites or covalent cross-links (Legerski et al. 1977, 1978; Lau and Gray 1979; Kilpatrick et al. 1983; Wei et al. 1984).

The combination of the two exonuclease activities causes both strands of double-stranded DNA to be shortened from both ends. BAL 31 will also digest single-stranded RNA and double-stranded RNA, the latter much less efficiently than double-stranded DNA (Bencen et al. 1984). In molecular cloning, the exonucleolytic reaction of BAL 31 has been used:

- **To produce uni- and bidirectional deletion mutations at specific sites in cloned DNAs.** Unidirectional deletions are best generated in target DNAs cloned between two unique restriction sites in a plasmid or phagemid vector. Bidirectional deletions can be generated from a unique internal restriction site in the target DNA (please see Figures 13-7 and 13-8).
- **As an aid to restriction mapping of cloned DNAs** (Legerski et al. 1978; Hauser and Gray 1991). When linear duplex DNA is digested with BAL 31, the terminal restriction fragments are destroyed first, followed by the subterminal fragments and so on. The order of restriction fragments in an unmapped segment of cloned DNA can therefore be ascertained from the order in which restriction fragments disappear from samples that have been digested with BAL 31 for increasing periods of time.

So far, the functions of >200 genes and the organization of at least 100 *cis*-acting sequences have been analyzed by assaying the function of deletion mutants created by BAL 31. In addition, unidirectional deletions generated by BAL 31 have been used to create sets of nested templates for sequencing long segments of DNA cloned in bacteriophage M13 vectors (Poncz et al. 1982).

**Properties of BAL 31**

Most commercial preparations of BAL 31 contain two kinetically distinct forms of the enzyme, a fast (F) form with a molecular weight ( $M_r$ ) of 105,000 and a slow (S) form ( $M_r = 85,000$ ). The S form is a proteolytic degradation product of the F form and is generated by a protease in the supernatant of *Alteromonas* cultures. The F form itself appears to be a degradation product of an even larger protein (Hauser and Gray 1990).

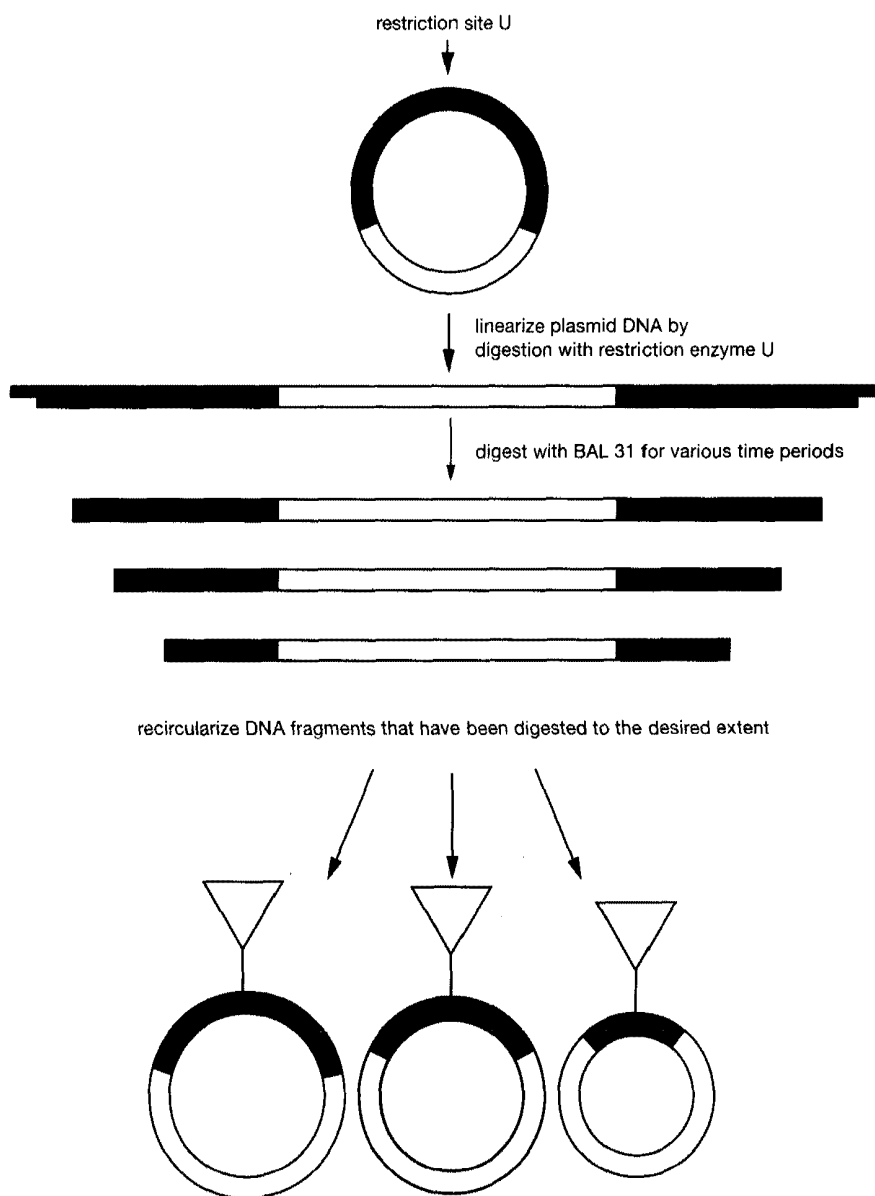
The two forms of BAL 31 degrade single-stranded DNA at approximately equal rates, but they differ markedly in the activity that generates uni- and bidirectional deletions, i.e., the 3'→5' exonucleolytic degradation of double-stranded DNA. The rate of the reaction of the F form is described by the equation of Wei et al. (1983):

$$F(v_0, [S]) = F(V_{\max}^{\text{app}} [S] + K_m^{\text{app}}) \quad (1)$$

where  $v_0$  is the initial reaction velocity,  $[S]$  is the initial substrate concentration expressed in mole/liter of duplex termini,  $V_{\max}^{\text{app}}$  is the apparent maximum velocity at the concentration of enzyme used, and  $K_m^{\text{app}}$  is the apparent Michaelis constant. The value of  $K_m^{\text{app}}$  is ~58 nM when the initial length of the duplex substrate is in the range of 2.0–2.5 kb (Gray and Lu 1993).

At high substrate concentrations and working at maximum velocity, one unit of the F form releases 2.1 nmoles of nucleotide/liter/minute from duplex DNA molecules. This value of  $V_{\max}^{\text{app}}$  applies to DNAs whose content of (G+C) is between 52 and 67 Mol%. However, because the activity of the F form of BAL 31 on double-stranded DNA increases slightly as the (G+C) content of the substrate decreases,  $V_{\max}^{\text{app}}$  should be increased by interpolation by a factor of 1.7 as the (G+C) content decreases from 52 to 37 Mol% (Gray and Lu 1993).





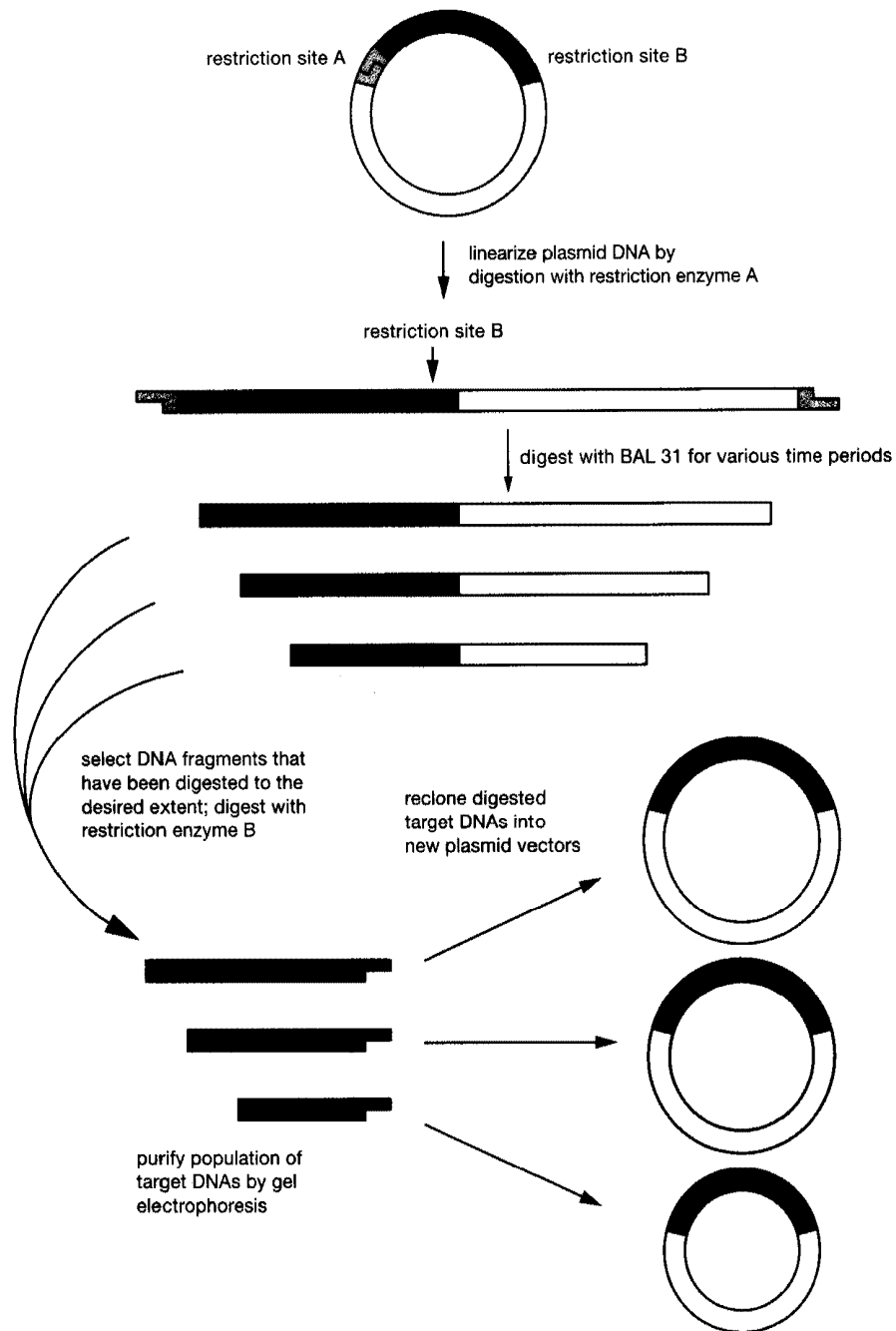
**FIGURE 13-7 Generation of Bidirectional Deletions by Digestion with BAL 31**

Digestion proceeds from a site within the target.

Equation 1 cannot be used to predict the kinetics of degradation for the S form of BAL 31 because the values of  $K_m^{app}$  for this enzyme are larger than the highest concentration of substrate that can be assembled in the reaction (Gray and Lu 1993). However, since  $[S]$  is much less than  $K_m^{app}$ , a plot of  $v_o$  versus  $[S]$  yields a straight line. The term on the right-hand side of Equation 1 reduces to  $F(V_{max}^{app}, K_m^{app})$ , which is constant at fixed enzyme concentration.

Because this term is the slope of the plot of  $v_o$  versus  $[S]$ , it is possible to calculate  $F(v_o, [S])$  for any given concentration of the S form of BAL 31 and to extrapolate results from one enzyme concentration to another. For example, if  $x$  units of the S form catalyze the release of 0.5 residue/minute from a certain concentration of double-stranded substrate, then  $2x$  units will catalyze the release of 1.0 residue/minute.

In general, the S form of BAL 31 truncates linear duplex DNA 20–30-fold more slowly than the F form (Wei et al. 1983). However, by contrast to the F form, the activity of the S form on double-stranded DNA



**FIGURE 13-8** Generation of Unidirectional Deletions by Digestion with BAL 31

Digestion proceeds from each end of the target.

decreases markedly with increasing G+C content, with a 4.2-fold change in  $F(v_0, [S])$  over the range 37–66 Mol% G+C (Legerski et al. 1978; Gray and Lu 1993). The dependence of  $F(v_0, [S])$  on G+C content can be estimated from the following equation:

$$F(v_0, [S]) = 16.85 - 0.546P + 0.00456P^2 \quad (2)$$

where  $P$  is the Mol% G+C, and the value of  $F(v_0, [S])$  corresponds to an enzyme concentration of 1 unit/ml. The desired value of  $F(v_0, [S])$  can be calculated by multiplying the quantity obtained from Equation 2 by

the concentration of the S form to be used in the experiment (Gray and Lu 1993). Because of these complications, the F species is the enzyme of choice for controlled shortening of duplexes whose base composition shows wide local variation.

When the products of BAL 31 digestion are to be ligated, it is important to consider that the average length of single-stranded tails created by digestion of linear double-stranded DNA is dependent on the ratio of F and S forms and on their concentration. The average length of the protruding 5' tails decreases with increasing enzyme concentration (Zhou and Gray 1990). High concentrations of the F or S form (>2 and 10 units/ml, respectively) will generate DNA molecules that carry an average of seven nucleotides of single-stranded DNA per terminus; 2–4% of these molecules can be blunt-end-ligated to one another without further treatment. Low concentrations of either form (below ~1 and 5 units/ml of the F and S nuclease, respectively) will generate long single-stranded termini whose efficiency of blunt-end ligation is very low. Thus, a low concentration of F enzyme in a preparation may be compensated in this regard by a relatively high concentration of S form. However, repair with bacteriophage T4 DNA polymerase (or, in some cases, the Klenow fragment) is obligatory at low concentrations and desirable at high concentrations of BAL 31.

Although pure preparations of the F and S forms of BAL 31 are commercially available, they are very expensive. Results using mixed preparations will vary, depending on the relative amounts of the two forms in the initial preparation. However, mixed preparations of the enzyme work perfectly well for most purposes, although it is necessary to carry out preliminary experiments to determine the concentration of enzyme and the time of digestion that give the desired results.

Preparations rich in the F form are preferred for such tasks as removal of long (>1000 bp) segments from the termini of double-stranded DNA, degradation of double-stranded RNA, and mapping of restriction sites, B-Z DNA junctions, and lesions in double-stranded DNA. The S form of the enzyme is best suited for removal of short segments (10–100 bp) from the termini of double-stranded DNA. Mixed preparations of the enzyme can be used for any of these tasks, although the results will vary as mentioned above.

## Facts and Figures

- Digestions with BAL 31 are usually carried out at 30°C in a buffer (pH 8.0) containing between 0.4 and 0.6 M NaCl and 12.5 mM of both Ca<sup>2+</sup> and Mg<sup>2+</sup>.
- The DNA should be purified by chromatography on Qiagen columns (or their equivalent), concentrated by precipitation with ethanol, resuspended in the smallest practical volume of Tris/EDTA, and then diluted into the reaction mixture to a final concentration of >20 mg/ml (for a fragment ~2 kb in length).
- The amount of enzyme used should be calculated to digest <20% of the length of the target fragment in the first 5 minutes of the reaction.
- Aliquots withdrawn from the reaction at various times should be stored at 4°C in 20 mM EGTA.
- A good way to check the progress of the BAL 31 digestion is to digest an aliquot of the samples taken at various times with a restriction enzyme that cleaves the target fragment several times. As the digestion proceeds, the fragments disappear from the digest in a defined order. Knowing their size and map positions, it is possible to estimate the rate of BAL 31 digestion.

## Historical Footnote

BAL 31 was discovered accidentally by Horace Gray when he was an assistant professor at the University of Houston in the early 1970s. At this time — several years before molecular cloning of DNA became possible — the only source of milligram amounts of prokaryotic closed circular duplex DNA was the bacteriophage PM2, which had been discovered by Romilio Espejo, a Chilean microbiologist. Espejo was a peripatetic visitor to the California Institute of Technology, where Gray was a postdoctoral fellow in Jerry Vinograd's laboratory. Gray and others in Vinograd's laboratory were interested in the hydrodynamic properties of closed circular DNA and so needed to purify bacteriophage PM2 on a large scale. The bacteriophage was routinely grown on *Alteromonas espejiana*, a marine bacterium that had also been isolated by Espejo some years before. Espejo originally characterized it as a *Pseudomonas*. However, when it was reexamined and found to fit the small genus *Alteromonas*, the authors of that paper (Chan et al. 1978) named it after Espejo.

Pursuing studies on PM2 DNA at the University of Houston, Gray was surprised to find that some batches of the bacteriophage particles lysed in preparative CsCl gradients, releasing their viral DNA, which then sedimented to the bottom of the centrifuge tubes. The released DNA was a mixture of closed circular and linear forms and Gray and his colleagues were excited by the possibility that a restriction enzyme might be present either in the bacteriophage particles or in lysates of *Alteromonas*. However, they soon noticed that the linear DNA produced from closed circular DNA became progressively shorter during incubations with *Alteromonas* culture supernatants and realized that the *Alteromonas* lysate contained an exonuclease (the source of lysis was never discovered). The exonuclease was given the name BAL 31 and Gray spent a good part of the next 15 years working out its biochemistry and structure. Almost everything that we know about the enzyme is due to the work carried out in his laboratory in Houston. Espejo returned to Chile but lost contact with former colleagues in the United States when he was forbidden to travel from Chile during the 1970s.

### EXONUCLEASE III

Exonuclease III of *E. coli* removes 5' mononucleotides from the 3'-hydroxyl ends of duplex DNA, leaving protruding 5' termini (Richardson and Kornberg 1964; Richardson et al. 1964). At 37°C, a limited number of 5' mononucleotides are removed during each binding event. Resection of DNA molecules therefore occurs in a distributive and quasi-synchronous fashion. The favorable kinetics of digestion and the immunity of single-stranded 3' termini to attack led to the development of methods (1) to generate single-stranded templates for DNA sequencing (Smith 1979; Guo and Wu 1982; Sorge and Blinderman 1989; Li and Tucker 1993) and (2) to produce unidirectional sets of progressive deletions in populations of linear DNA molecules with one resistant (3' protruding) terminus and one susceptible (blunt or 5' protruding) terminus (Henikoff 1984, 1987, 1990; Hoheisel and Pohl 1986). 3' termini that are resistant to exonuclease III can be generated by digestion with certain restriction enzymes (see Table 13-2), by digestion with  $\lambda$  exonuclease, or by "tailing" with terminal deoxynucleotidyl transferase.

**TABLE 13-2 Substrate Specificity of Exonuclease III**

TYPE OF TERMINI	RESISTANT OR SENSITIVE TO EXONUCLEASE III	REFERENCES
Blunt-ended	Sensitive	Richardson et al. (1964)
Recessed 3'	Sensitive	Richardson et al. (1964); Weiss (1981)
Protruding 3' termini with <4 unpaired bases	Sensitive	Henikoff (1984)
Protruding 3' termini with >3 unpaired bases	Resistant unless the terminal base is C. Most 4-base protruding 3' termini generated by restriction enzymes are resistant to exonuclease III. However, termini generated by <i>ApaI</i> , <i>BanII</i> , <i>Bsp1286I</i> , <i>HaeII</i> , and <i>KpnI</i> , which cleave 3' to a C residue, are sensitive to the enzyme. These enzymes should therefore be avoided when designing templates for exonuclease-III-based deletion and DNA sequencing.	Henikoff (1984); Hoheisel (1989, 1993)
3' termini filled with $\alpha$ -thio deoxynucleotides	Resistant	Putney et al. (1981); Olsen and Eckstein (1990)

Exonuclease III is a 31-kD globular protein, encoded by the *xth* gene of *E. coli*, which has been sequenced (Saporito et al. 1988). Surprisingly for such a small protein, exonuclease III possesses multiple catalytic activities.

- A 3'→5' **exonuclease** that degrades double-stranded DNA (Richardson et al. 1964).
- A 3' **phosphomonoesterase** (Richardson and Kornberg 1964; Brutlag and Kornberg 1972) that removes a number of 3' termini from double-stranded DNA, including 3' phosphoglycoaldehyde and 3' phosphoglycolate residues (for review, please see Doetsch and Cunningham 1990).
- A **nucleotidyl hydrolase** cutting 5' to apurinic/apyrimidinic sites in DNA (Weiss 1976, 1981; Weiss et al. 1978).
- A **powerful exonucleolytic ribonuclease H** (Keller and Crouch 1972; Weiss et al. 1978).

This constellation of activities, which are catalyzed by a single active site (Weiss 1976, 1981), is consistent with genetic data indicating that exonuclease III acts within the cell as part of the prokaryotic base-excision repair pathway (Rogers and Weiss 1980).

Exonuclease III supplied from most commercial manufacturers is purified from a strain of *E. coli* containing a chimeric plasmid (pSGR3) that carries a 3-kb fragment of the *E. coli* genome encompassing the *xth* gene (Rao and Rogers 1978). Exonuclease III contains a bound divalent cation that is required for activity. The purified enzyme does not require  $Mn^{2+}$  or  $Mg^{2+}$  in the reaction buffer unless it has been exposed to EDTA.  $Ca^{2+}$  can partially substitute for  $Mg^{2+}$  for the exonucleolytic activity of exonuclease III (Kow 1989). The mechanism by which exonuclease III degrades DNA exonucleolytically is affected by temperature, the concentration of monovalent cation, and the concentration and structure of the 3' termini (please see Table 13-3).

Arrhenius plots of the temperature dependence of the rate of exonucleolytic digestion by exonuclease III in the presence of  $Mg^{2+}$  show a transition at 25–30°C (Henikoff 1987; Kow 1989; Hoheisel 1993), suggesting that the enzyme exists in two conformational states. In one state, which predominates at temperatures <25°C, exonuclease III binds tightly to DNA and works in a processive fashion. At temperatures >30°C, the enzyme has a lower activation energy and hydrolyzes populations of 3' termini in a distributive fashion (Hoheisel 1993).  $Ca^{2+}$  ions stabilize exonuclease III in its low-temperature conformation (Kow 1989). The activity of exonuclease III is inhibited at temperatures in excess of 46°C (Hoheisel 1993). Table 13-4 lists some of the applications of the enzymatic activities of exonuclease III to molecular cloning.

**TABLE 13-3 Exonucleolytic Activities of Exonuclease III**

REACTION CONDITIONS	ENZYMATIC ACTIVITY	REFERENCES
70 mM NaCl at 5°C	Exonuclease III removes six nucleotides from the end of a duplex and remains bound as a stable complex.	Donelson and Wu (1972)
50 mM NaCl at 5°C	An initial burst of exonucleolytic activity removes six nucleotides from the end of a duplex. This is followed by a slower rate of progressive hydrolysis.	Donelson and Wu (1972)
23–28°C	Exonucleolytic digestion is synchronous for ~250 nucleotides and is processive. At saturating enzyme concentrations, 5' mononucleotides are removed at a rate of ~100 nucleotides/min/3' end.	Wu et al. (1976); Hoheisel (1993)
37°C	Exonucleolytic digestion is distributive and quasi-synchronous. At saturating enzyme concentrations, 5'-mononucleotides are removed at a rate of ~400 nucleotides/min/3' end.	Thomas and Olivera (1978); Hoheisel (1993)

Exonuclease III is inhibited by NaCl and displays maximal activity in buffers containing 15 mM Tris-Cl (pH 8.0) and 6.6 mM  $MgCl_2$ . No enzymatic activity is detectable in buffers containing 300 mM NaCl (Hoheisel 1993).

**TABLE 13-4** Uses of Exonuclease III in Molecular Cloning

ENZYMATIC REACTION	USES	REFERENCES
Exonucleolytic digestion of double-stranded DNA from its 3' end.	<p>resected molecules are used</p> <ul style="list-style-type: none"> <li>• as substrates for labeling reactions</li> <li>• as templates for DNA sequencing</li> </ul> <ul style="list-style-type: none"> <li>• in mapping restriction sites by exonuclease/hybridization</li> <li>• for chemical or oligonucleotide-directed mutagenesis</li> <li>• to eliminate primers from completed PCRs</li> </ul>	<p>James and Leffak (1984) Smith (1979); Guo and Wu (1982); Labeit et al. (1986); Hoheisel and Pohl (1987); Sorge and Blinderman (1989); Henikoff (1990)</p> <p>Li and Tucker (1993); Tartof (1992)</p> <p>Shortle and Nathans (1978); Nakamaye and Eckstein (1986)</p> <p>Zhu et al. (1991)</p>
Exonucleolytic digestion of double-stranded DNA from its 3' end in combination with a single-strand-specific nuclease such as S1 (Protocol 9).	<p>to generate sets of nested deletions</p> <p>to map genetic markers and repetitive sequences</p>	<p>Henikoff (1984, 1987, 1990); Hoheisel and Pohl (1986)</p> <p>Peters and Baumeister (1986); Garon et al. (1975)</p>
Blockage of exonuclease III digestion by DNA binding proteins.	to localize protein-binding sites	Riley and Weintraub (1978)

### Production of Nested Deletions by Digestion with Exonuclease III

Henikoff (1984) described a method whereby the double-stranded DNA of recombinant plasmid, phagemid, or bacteriophage M13 replicative form DNA is digested with two restriction enzymes whose sites of cleavage both lie between one end of the target DNA and the binding site for universal primer. The enzyme that cleaves nearer the target sequence must generate either a blunt end or a recessed 3' terminus; the other enzyme must generate a 4-nucleotide protruding 3' terminus. Because only the blunt or recessed 3' terminus of the resulting linear DNA is susceptible to exonuclease III (please see Table 13-3), digestion proceeds unidirectionally away from the site of cleavage and into the target DNA. The exposed single strands are then removed by digestion with nuclease S1 or mung bean nuclease, and the DNA is then recircularized. If desired, a synthetic linker can be inserted at the site of recircularization.

The major defect of this method is that it requires two unique restriction sites immediately adjacent to the point from which deletions originate. In most cases, these sites are located in the polycloning site to one side of the target sequence. For the procedure to be effective, it is essential that digestion of these two sites by the appropriate restriction enzymes be complete. However, if the two sites are close to each other, this can be achieved only by digesting for extended times with large amounts of one or both enzymes, which can lead to nicking of the template. Because exonuclease III efficiently attacks the 3' end of a nick (Masamune et al. 1971), deletions may be generated in undesirable locations in both the vector and the target DNA.

To solve this problem, Henikoff (1990) described a method in which a single-stranded circular phagemid DNA is used as a template for extension of an oligonucleotide primer by bacteriophage T4 DNA polymerase. This reaction generates a double-stranded circular molecule containing a small nick or gap

immediately 5' to the primer. Exonuclease III is then used to resect the resulting 3' end, and the exposed single-stranded DNA is removed by digestion with a single-strand-specific endonuclease (nuclease S1 or mung bean nuclease). The resulting set of linear nested DNA fragments have a common terminus corresponding to the 5' end of the primer. These deleted molecules are then recircularized and used to transform cells. This method has three advantages:

- Nested deletions can be made from any point in the target DNA.
- Restriction enzymes are not used.
- The enzymatic reactions can be carried out sequentially in a single tube, and there is no need to extract the solution with organic solvents or to precipitate the DNA.

Another method to control the extent of resection is to label the DNA randomly with thionucleotides before digestion with exonuclease III. Because thio-containing nucleotides are resistant to hydrolysis by exonuclease III, digestion will stop at the first place the enzyme encounters a thio-substituted nucleoside. By controlling the amount of  $\alpha$ -thio incorporation, investigators can more readily obtain sets of resected DNA fragments of the desired size (King and Goodbourn 1992).

### Making Templates for Dideoxysequencing with Exonuclease III

Sequencing strategies based on digestion of double-stranded DNA templates with exonuclease III have been in use since 1982 when Guo and Wu (1983) developed a method in which the DNA sequence was obtained by resynthesis of the resected strand. This method eliminated the need for a primer-binding site, but it required knowledge of the restriction map of the target DNA. Although improvements were made (Guo and Wu 1983), exonuclease III was not used extensively to prepare templates for DNA sequencing until 1984, when Henikoff's protocol to create nested deletions was published. However, this method is labor-intensive and, in addition to enzymatic resection, requires much subcloning, growth of bacterial cultures, and purification of nucleic acids. In addition, a new deletion is needed for each 300–500 nucleotides of sequence.

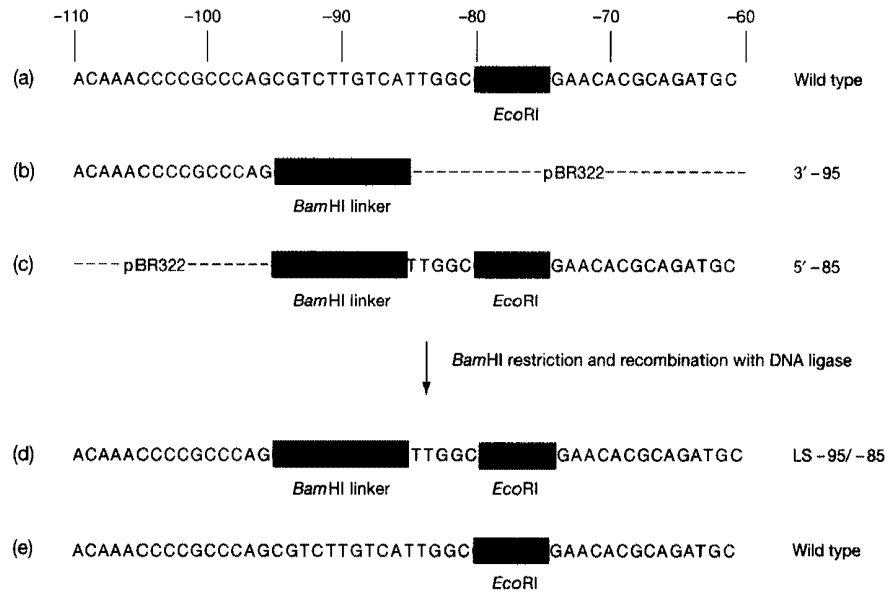
---

## LINKER-SCANNING MUTAGENESIS

---

Linker-scanning mutagenesis (McKnight and Kingsbury 1982) is designed to locate and identify functional elements in promoters, replication origins, and other *cis*-acting regulatory regions. A canon of mutants is generated in which short segments of the target DNA are replaced in a systematic fashion with a "neutral" DNA sequence. Replacing the natural DNA sequence with a sequence of the same length will usually destroy the function of a particular regulatory element, but it will not change the spacing, torsional topology, or orientation of functional elements within the domain. The phenotypes of individual mutants can therefore be mapped with some confidence to specific locations within the regulatory region. Because all mutants carry the same neutral sequence, comparison of their phenotypes is valid in most cases.

In the original linker-scanning method (McKnight and Kingsbury 1982), 5'- and 3'-deletion mutants were first generated by resection with exonuclease III (please see the information panel on **EXONUCLEASE III**). The termini of these mutations were then precisely mapped to identify pairs of mutants whose endpoints differed by precisely the number of nucleotides present in the neutral synthetic linker. Pairs of mutants were then yoked together through a synthetic linker (please see Figure 13-9). This sounds simple in theory, but it is extremely laborious and time-consuming in practice. To obtain a usable set of linker-scanning mutants by this method, a large number of 5' and 3' deletions must be constructed, sequenced, and matched. In their original paper, McKnight and Kingsbury (1982) used 43 5' and 42 3' deletions to obtain a canon of 15 linker-scanning mutants. Although the method was later streamlined (e.g., please see



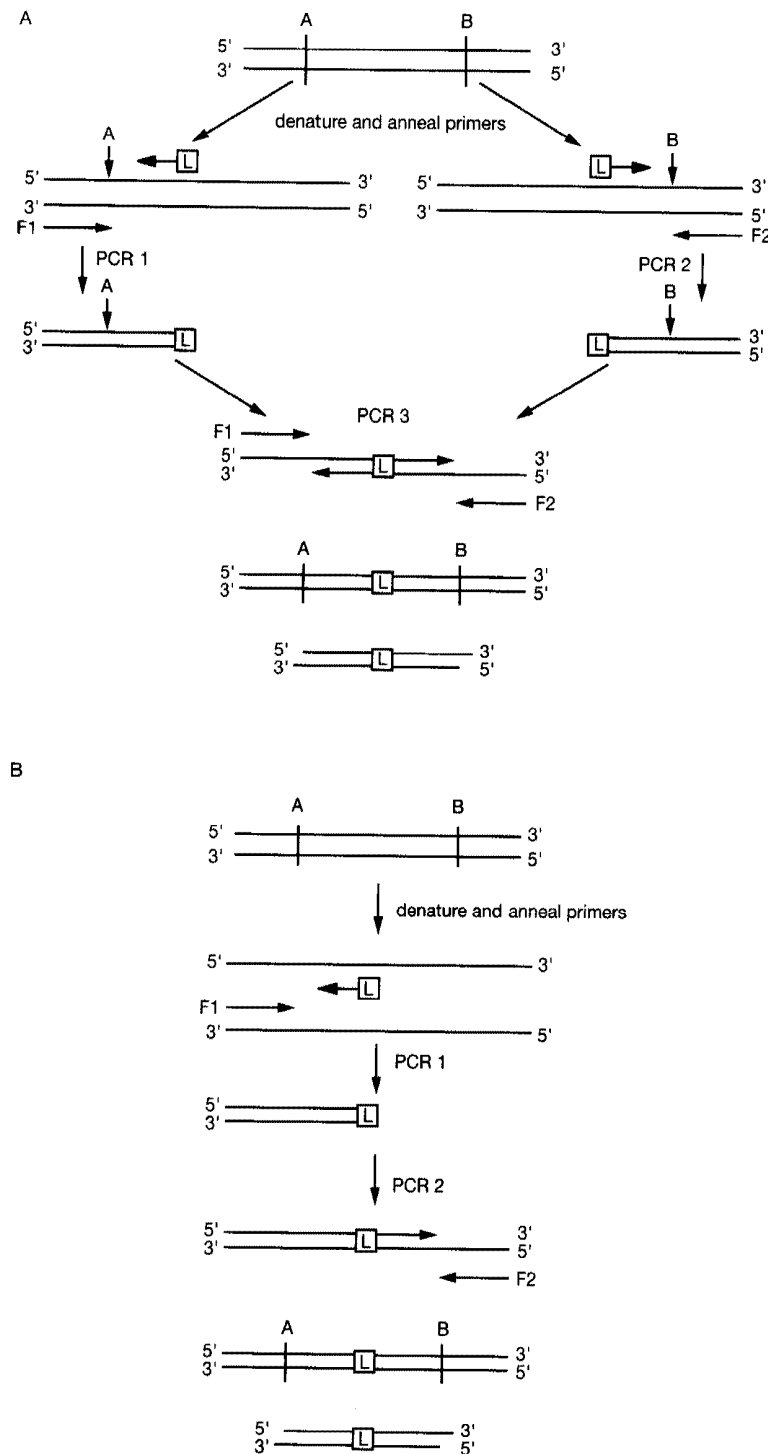
**FIGURE 13-9 Construction of a Linker-scanning Mutant**

(a) Nucleotide sequence of the normal HSV *tk* gene between 60 and 110 residues upstream of the transcription initiation site is shown on the top and bottom lines. This sequence is referred to as wild type. (b, c) Nucleotide sequences of two linker deletion mutants 3'–95 and 5'–85. (d) Linker-scanning mutant –95/–85 was constructed by recombining 3'–95 and 5'–85 at the *Bam*HI restriction site. The nucleotide residues of the *tk* gene that are substituted by this procedure are shown in bold type. (Redrawn, with permission, from McKnight and Kingsbury 1982 [©AAAS].)

Haltiner et al. 1985; Luckow et al. 1987; Südhof et al. 1987; Luckow and Schütz 1991), it remained a daunting proposition until synthetic oligonucleotides became available at reasonable cost. Since then, many methods have been described to generate linker-scanning mutants by oligonucleotide ligation (Hobson et al. 1996) or PCR (e.g., please see Gustin and Burk 1993; Li and Shapiro 1993; Viville 1994; Harlow et al. 1996; Schanke 1997; Barnhart 1999). These methods save much labor by eliminating the need to generate two sets of deletions with exonucleases. In addition, they allow the investigator to define the length of the linkers and to place them with precision in predetermined locations within the target DNA. However, PCR methods can be both laborious and extensive. For example, the technique described by Gustin and Burk (1993) requires four oligonucleotide primers, three PCRs, and two ligations for each mutant.

More efficient PCR-based methods are based on variations on overlap extension PCR (Higuchi et al. 1988; Ho et al. 1989; Harlow et al. 1994), megaprimer PCR (Schanke 1997), or, for longer scanning mutations, a combination of circular PCR and linker insertion (Barnhart 1999). Figure 13-10 shows two methods based on overlap extension that work efficiently and require two partially complementary mutagenic oligonucleotides per mutation and two common oligonucleotides that are used to amplify all mutants in the canon.





**FIGURE 13-10 Linker Scanning**

Generation of linker-scanning mutations by PCR. (A) In the overlap method, two complementary oligonucleotides carrying linker sequences at the 3' termini are used to prime PCR 1 and PCR 2. In each case, the second primer (F1 or F2) is complementary to sequences lying outside unique restriction sites (shown as A and B). The products of PCR 1 and PCR 2 are mixed and denatured and used as templates in PCR 3, which is primed by the two flanking oligonucleotides (F1 or F2). The PCR product is then cleaved with restriction enzymes A and B and cloned into a suitable vector. (B) In the asymmetric method, PCR is primed by F1 and another primer carrying linker sequences at its 3' terminus. The products of the reactions are purified and used, together with oligonucleotide F2, to prime PCR 2. The product of PCR 2 is cleaved with restriction enzymes A and B and cloned into a suitable vector. (Modified, with permission, from Harlow et al. 1994.)

---

**RANDOM MUTAGENESIS**


---

Four methods are used to construct multiple mutations into a defined region of cloned DNA: chemical mutagenesis, cassette mutagenesis, misincorporation mutagenesis, and mutagenesis with doped or spiked oligonucleotides.

**Chemical Mutagenesis**

Chemical mutagenesis, the most venerable method of local randomized mutagenesis, involves exposing a short fragment (<200 bp) of double-stranded DNA to a mutagen, such as nitrous acid, hydroxylamine, bisulfite, or hydrazine (please see Table 13-5). The population of mutagenized fragments is then used to create a small library of recombinant clones that contain a mutagenized fragment in place of the homologous wild-type sequence. Individual recombinants carrying mutations that generate a novel phenotype are identified by appropriate functional tests. The exact location and specific characteristics of the mutations(s) can be ascertained by any one of a number of methods, including DNA sequencing (please see Protocol 7).

Unfortunately, the frequency at which mutants are recovered by chemical mutagenesis can be unacceptably low (Chu et al. 1979; Solnick 1981; Busby et al. 1982; Kadonaga and Knowles 1985). Furthermore, as shown in Table 13-5, most commonly used chemical mutagens react with bases in a specific manner, so that the spectrum of mutations obtained with a single mutagen may be too narrow to allow a comprehensive analysis of a particular segment of a protein (Shortle and Nathans 1978; DiMaio and Nathans 1980; Peden and Nathans 1982). Finally, chemical mutagenesis of double-stranded DNA is highly nonrandom, with regions prone to denaturation being the most vulnerable. This problem can be alleviated, but not

**TABLE 13-5 Mode of Action of Commonly Used Chemical Mutagens**

MUTAGEN	MODE OF ACTION
Nitrous acid	<p>Reacts with the amines of purines and pyrimidines to generate diazonium derivatives that are rapidly hydrolyzed in aqueous solution to ketonic products. Because the rates of these deamination reactions increase with decreasing pH, mutagenesis with nitrous acid is usually carried out at pH 5.2.</p> <p>guanine→xanthine, which pairs with thymine            adenine→hypoxanthine, which pairs with cytidine            cytosine→uracil, which pairs with adenine</p> <p>Nitrous acid therefore generates transition mutations, where purines are replaced by purines and pyrimidines are replaced by pyrimidines. Of the three bases, cytosine is deaminated most efficiently and guanine the least efficiently. The relative rates of reaction of cytosine:adenine:guanine are 6:2:1 (Schuster 1960).</p>
Hydroxylamine	<p>Deaminates cytosine at low pH (&lt;pH 2.5) and converts it to uracil. <sup>m</sup>5-cytosine, however, is resistant to deamination. At pH 6.0, the deamination of cytosine is incomplete and a stable intermediate product (hydroxyaminocytosine) is formed that can pair with adenine (Lawley 1967). In both cases, the result is a transition mutation where C-G base pairs are converted to A-T.</p>
Bisulfite	<p>Reacts almost exclusively with cytosine, which it deaminates to uracil (Shapiro et al. 1973). Bisulfite and hydroxylamine therefore generate the same type of transition mutations.</p>
Hydrazine	<p>Cleaves the heterocyclic rings of cytosine and thymidine, which leads to hydrolytic depyrimidation of DNA at the site of attack (Brown et al. 1966) The higher the monovalent cation concentration in the reaction, the greater the preference of hydrazine for cytosine. During DNA replication, any of the four bases can be inserted into the daughter strand opposite the apyrimidinic site.</p>

---

entirely eliminated, by using single-stranded DNAs as substrates for mutagenesis (Greenfield et al. 1975; Shortle and Botstein 1983). The yield of mutants can be increased by transfecting chemically mutagenized DNA into an *ung*<sup>-</sup> strain of *E. coli* that lacks uracil *N*-glycosylase and is therefore unable to remove uracil residues generated by deamination (Pine and Huang 1987).

Myers et al. (1985b) introduced methods to treat single-stranded DNA with chemicals that damage all four bases. Here, single-stranded DNA of a recombinant M13 bacteriophage is exposed under defined conditions to chemicals (nitrous acid, formic acid, and hydrazine) that modify bases in single-stranded DNA without breaking the phosphodiester backbone. After removal of the chemicals, a universal sequencing primer and a DNA polymerase are used to synthesize the complementary strand of DNA. When the polymerase encounters damaged bases in the template strand, it incorporates nucleotides essentially at random. Because all possible nucleotides can be incorporated at a single position, there is a 75% probability of mutation at every site of damage. Furthermore, because transversions are generated twice as frequently as transitions, the resulting mutations generate DNAs (and subsequently proteins) with a wide spectrum of changes. After the extension reaction is completed, the double-stranded target fragment is excised and recloned into an appropriate vector. Mutants can be identified directly by DNA sequencing of random clones.

The major problem with Myers' method is the frequency with which useful mutations can be isolated. To prevent the formation of unacceptable numbers of multiple mutants, it is necessary to limit carefully the length of time the single-stranded DNA is exposed to damaging chemicals. However, this requirement means that many of the template strands escape modification altogether. Therefore, the best that can be achieved by this method is a frequency of single mutations of 10–15%. This problem can sometimes be alleviated by using denaturing gradient gel electrophoresis to purify fragments of DNA that carry mutations (Myers et al. 1985b,c) or by using a screening method such as single-stranded DNA conformation analysis (Orita et al. 1989b) to identify rapidly clones that carry mutations. For a comprehensive discussion of methods used in chemical mutagenesis, please see Walton et al. (1991).

## Cassette Mutagenesis

In the simplest form of cassette mutagenesis (Wells et al. 1985), a small section of DNA is removed from the wild-type gene and replaced by a synthetic segment of DNA that carries one or more mutations. Cassette mutagenesis can therefore be used to introduce single or multiple amino acids within the target zone. In theory, the method is capable of, for example, generating a canon of mutants encoding all possible amino acid residues at a particular codon or inserting or deleting amino acids at every position.

There are many ways to design pools of oligonucleotides that carry mutations at the desired site(s). A particularly efficient method is to synthesize one strand of the cassette as a pool of oligonucleotides with equal mixtures of all four nucleotides in the first two positions of the target codon and an equal mixture of G and C in the third position (Reidhaar-Olson and Sauer 1988). This composition produces a truncated version of the genetic code that contains only 32 codons and yet encodes the entire set of amino acids (Scott and Smith 1990; Reidhaar-Olson et al. 1991). The second strand of the cassette is synthesized with inosine at each target position. Inosine is able to form base pairs with each of the four conventional bases (Martin et al. 1985). The two strands are then annealed, and the population of mutagenic cassettes is ligated into the open-jawed vector.

The resulting population of doped cassettes will include codons specifying each of the 20 amino acids at each target site(s). However, because of redundancy in the code, some amino acids will be represented more frequently than others, and it may be necessary to sequence many candidates to obtain a complete collection of cassettes. If only a subset of amino acid substitutions is required, it would be worthwhile to consider doping schemes that generate oligonucleotides encoding specific subsets of amino acids and excluding others (e.g., please see Arkin and Youvan 1992).

In cassette mutagenesis, the frequency of particular mutations and of double and triple mutations usually deviates from theoretical predictions. This deviation is probably a result of inequalities in the efficiency with which the four nucleotide precursors are incorporated into the mutagenic cassettes. However, these deviations only become serious when the aim is to isolate a complete sampling of mutations. In this case, it may be better to harvest most of the mutations from the pool and then to complete the set by conventional site-directed mutagenesis.

### Misincorporation Mutagenesis

In the early 1980s, suites of mutants were generated by enzymatic incorporation of nucleotide analogs or by misincorporation of normal nucleotides (Müller et al. 1978; Shortle et al. 1982; Zakour and Loeb 1982; Shortle and Botstein 1983; Shortle and Lin 1985). However, the rate of recovery of useful mutations was too low and the distribution of the mutations too biased to allow the assembly of a complete library of mutants. More recently, however, misincorporation mutagenesis has been revived in a more efficient form.

Misincorporation of bases occurs when one of the four nucleotides in an *in vitro* DNA synthesis reaction is present in a limiting amount (usually 1–10% of the normal concentration). The DNA polymerase, starved of the correct nucleotide, stalls briefly and then inserts one of the three available nucleotides. The synthetic reaction can be catalyzed either by a thermolabile polymerase such as the Klenow fragment (e.g., please see Lehtovaara et al. 1988) or, more efficiently, in a PCR catalyzed by an error-prone thermostable polymerase such as *Taq*. In the latter case, four PCRs are carried out, each depleted for a different nucleotide but containing high concentrations of dITP (Spee et al. 1993; Kuipers 1996). The thermostable DNA polymerase therefore has the option of incorporating an inosine residue at sites requiring the depleted nucleotide or of incorporating one of the three available conventional nucleotides. Because all four natural bases can form base pairs with inosine, there is a theoretical probability of 75% that a mutation will arise during the next PCR cycle at the site of incorporation of inosine. The combination of both types of mutageneses elevates the frequency of mutation approximately tenfold over the already high basal rate of *Taq* polymerase ( $5 \times 10^{-4}$ ). The frequency of mutation can be further elevated by including  $Mn^{2+}$  at a concentration of 0.5 mM in the PCR buffer (Leung et al. 1989).

### Spiked Oligonucleotide Primers

Random mutations in short (<80-nucleotide) regions of DNA can be constructed using spiked oligonucleotides as primers in the classic method of oligonucleotide-mediated mutagenesis (e.g., please see Hermes et al. 1989; Dale et al. 1991; Dale and Belfield 1996). Spiked oligonucleotides are synthesized on an automated DNA synthesizer by mixing each of the phosphoamidite precursors with a mixture of the other three bases. The frequency of mutations depends on the degree of spiking oligonucleotide primers, which can be adjusted by the investigator (Dale and Belfield 1996). In theory, spiked oligonucleotide primers should generate a truly random distribution of mutations. In practice, this degree of perfection is not achieved, perhaps because oligonucleotides that differ in sequence — even by as little as one nucleotide — prime with different efficiencies, perhaps as a consequence of differences in secondary structure.

---

**ALANINE-SCANNING MUTAGENESIS**

---

Alanine-scanning mutagenesis is a scheme to change the surface residues of a protein while preserving its underlying three-dimensional structure. The technique was originally designed to map the surfaces of a protein that are involved in interactions with other proteins or small ligands (Cunningham and Wells 1989; Bass et al. 1991; Wells 1991). The amino acid sequence of the protein was surveyed for clusters of highly charged residues, typically Arg, Lys, Asp, and Glu. The side chains of these residues are usually exposed to solvent on the surface of proteins where they can contribute to interactions with substrates, inhibitors, and other ligands, including proteins. Site-directed mutagenesis was then used to delete (or truncate) these wild-type side chains and replace them with a chemically inert side chain that does not extend beyond the  $\beta$ -carbon. The substitution of innocuous alanine for charged residues on the surface generally does not disrupt folding of the core of the protein. However, the absence of polar groups from critical locations may severely compromise functions of the protein that involve residues on the surface.

Alanine-scanning mutagenesis of charged amino acids generates a systematic set of mutant proteins that can be assayed for loss of function and avoids the necessity of generating, sequencing, and characterizing a large library of random mutants. Even so, the number of mutants generated by a comprehensive alanine scan can be formidable. For example, scanning the surface of tissue-plasminogen activator, a 527-amino-acid protein, involved the conversion of some 134 charged amino acids to alanine residues (Bennett et al. 1991). To reduce the amount of work, charged amino acids were collected into arbitrary clusters. Each cluster contained Arg, Lys, Asp, Glu, and His residues that lie within five residues of each other in the primary sequence. The charged amino acids in each of these clusters were simultaneously changed to alanine residues by oligonucleotide-mediated site-directed mutagenesis. This strategy generated a total of 64 mutants (12 single mutants, 35 doubles, 12 triples, and 5 quadruples), which were then expressed and assayed. The decision to include histidine residues in this alanine scan is questionable. Although its pK is near neutrality, the charged group of histidine is often involved in binding the buried charge of another reactive group (Richardson and Richardson 1989). Substitution of histidine by alanine may therefore destabilize the protein or result in other undesirable structural changes in the mutant protein.

Alanine scanning is not for the faint-hearted. The surveying power of the method depends on the breadth of its synoptic coverage. However, comprehensive scrutiny of charged residues, or even of charged clusters, on the surface of a moderate-sized protein may require the generation, expression, and assay of many mutants. Perhaps for this reason, alanine scanning of entire proteins has been used chiefly by commercial companies. Genentech developed a technique whereby alanine scanning is used to define functional motifs involved in catalysis and substrate binding of yeast cAMP-dependent protein kinase (Gibbs and Zoller 1991), to identify residues required for binding of interleukin 8 to its receptor (Hébert et al. 1991), to identify hormone-binding determinants in the human growth hormone receptor (Bass et al. 1991; for review, please see Wells 1996), to map antigenic epitopes on human growth factor (Jin et al. 1992), and to assign certain functions to particular structural domains of tissue-plasminogen activator (Bennett et al. 1991).

Academic laboratories have used the technique in a more limited way, for example, to produce detailed maps of functional residues in individual domains or subdomains of proteins and to evaluate the contribution of different side chains to the stability and folding of particular domains in proteins of known structure. For purposes such as these, alanine scanning remains the method of choice; papers founded on the technique continue to be published at the rate of several a month.

---

**MUTAGENIC OLIGONUCLEOTIDES**


---

All methods for site-directed mutagenesis require the use of one or more mutagenic oligonucleotides to alter the target sequence. If these oligonucleotides are correctly designed, the desired mutants will be produced with ease and efficiency. If not, the yield of mutants may be unacceptably low. Oligonucleotides used for conventional (non-PCR) site-directed mutagenesis must:

- **Be complementary to the appropriate strand of the target DNA.**
- **Be sufficiently long (>20 nucleotides) to anneal specifically to the target sequences.** Primers carrying two or more base substitutions should be at least 25 nucleotides in length.
- **Carry the mismatched base(s) in the center,** thus providing 10–15 bases on either side that perfectly match the template strand. Efficient introduction of insertions, deletions, or substitutions >3 nucleotides in size require primers that have as much as 30 nucleotides complementary to the template on each side of the mutation's site. Whenever possible, the calculated thermal stabilities of the duplexes formed between the target DNA and the 5'- and 3'-terminal regions of the mutagenic oligonucleotide should be equal to one another. For information on calculating the melting temperature of oligonucleotides, please see the introduction to Chapter 10.
- **Contain a 5'-terminal region that forms a perfect hybrid with the template,** so that DNA synthesis initiated from an upstream primer does not easily displace the mutagenic oligonucleotide. Approximately eight to ten perfectly matched nucleotides are required to suppress displacement of the oligonucleotide by the Klenow fragment. Displacement can also be prevented by using enzymes such as bacteriophage T4 DNA polymerase (Nossal 1974; Kunkel 1985), which have no 5'-3' exonuclease activity, or Sequenase (Schna 1989), which cannot readily remove the hybridized mutagenic primer from its template.
- **Form a hybrid sufficiently stable to allow efficient priming of DNA synthesis** from the 3' terminus of the oligonucleotide. If the mismatched nucleotide is too close to the 3' terminus, the 3' segment of the oligonucleotide will be unable to form a stable hybrid with the target DNA and will therefore be susceptible to exonucleolytic degradation if, for example, the Klenow fragment is used in the primer-extension reaction (Gillam and Smith 1979a,b). In addition, an increase in the frequency of priming at incorrect locations might occur because the unhybridized 3' region of the mutagenic oligonucleotide is now free to anneal to incorrect sites on the template. To suppress these effects, between 10 and 15 perfectly matched nucleotides are required at the 3' terminus of the mutagenic oligonucleotide.
- **Be free of palindromic, reiterated, or self-complementary sequences** that might form stable structures. The greater the potential for such structures, the lower the efficiency with which the oligonucleotide will hybridize to its target sequence in the template DNA. In extremely rare cases, the secondary structure of the oligonucleotide (or its complementary target sequence) is so great that mutants cannot be obtained. Under such circumstances, it may be necessary to carry out mutagenesis with a much longer synthetic oligonucleotide whose 5' and 3' termini extend well beyond (15–20 nucleotides) the problem region. Screening recombinants for the desired mutants is then carried out with a much smaller oligonucleotide (17–19 nucleotides) that carries the potentially mismatched bases in the central position.

The same general guidelines apply when designing primers for use in PCR-based methods of site-directed mutagenesis. However, an additional design feature is required when using a DNA polymerase such as *Taq* that catalyzes the template-independent addition of a nucleotide (usually adenosine) to the 3' terminus of the amplified product (please see the information panel on **TAQ DNA POLYMERASE** in Chapter 8). In many cases, the additional nucleotide will not be complementary to the template strand. To restore the correspondence between the PCR product and the target DNA, the oligonucleotide should be designed so that its 5' end is immediately preceded on the template strand by a deoxythymidine residue (Kuipers et al. 1991). An adenosine residue added by the DNA polymerase does not change the amino acid sequence and does not interfere with the use of the amplified DNA as a megaprimer in a subsequent round of PCR.

In many cases, mutagenic oligonucleotides can be designed so as to introduce a new restriction site or eliminate an existing site located close to the site of mutation. This strategy allows candidate clones to be screened by restriction enzyme cleavage and thereby facilitates identification of mutants. A computer pro-

gram entitled Primer Generator permits investigators to determine whether an oligonucleotide can be designed that both introduces a desired mutation and alters a nearby restriction site (Turchin and Lawler 1999). An alternative more powerful option that is independent of the DNA sequence near the site of mutation uses two primers: one to mutagenize the target site and another to remove a nonessential unique restriction site in the flanking vector sequences (Deng and Nickoloff 1992). This method can be extended to build both mutations into a single long "megaprimer" that can be used in a second PCR to generate a large amount of mutated double-stranded DNA (Kammann et al. 1989; Landt et al. 1990; Sarkar and Sommer 1990, 1992; Ke and Madison 1997).

The sequence of mutagenic oligonucleotides should be analyzed for the ability to form fortuitous, stable hybrids with regions of the template molecules other than the target sequences. Most commonly available programs for computer analysis of DNA sequences can be used to scan potential mutagenic primers for features such as hairpin formation, dimer formation, potential false annealing sites, position and number of mutations/insertions, melting temperature, and stability of 5' and 3' ends. Some programs can calculate the predicted stability ( $\Delta G$ ) of 5-bp windows across the length of an oligonucleotide-template hybrid. Oligonucleotides whose 3' pentamers have  $\Delta G$  values between  $-6$  and  $-10$  kcal/mole usually provide the maximum yield of mutations (Piechocki and Hines 1994), presumably because the hybrids formed by their 3' ends (1) are stable enough to compensate for the mismatch(es) in the center of the oligonucleotide but (2) are sufficiently unstable to suppress false priming from unwanted sites.

If necessary, the specificity of hybridization of the mutagenic oligonucleotide can be checked either in a DNA-sequencing reaction in which the oligonucleotide is used as a primer or by extending the primer in the presence of a small amount of one labeled dNTP and four unlabeled dNTPs and then digesting the product with appropriate restriction enzymes. The pattern of radioactive bands will reveal whether priming has occurred at the desired site and the length to which the primer has been extended (Zoller and Smith 1984). However, tests of this type are generally carried out only when difficulties are encountered in obtaining the desired mutation.

In general, the larger the size of the mutation to be constructed, the lower the efficiency of oligonucleotide-directed mutagenesis. For example, large deletions (i.e., deletions of several hundred nucleotides) are generated with  $\sim 50$ -fold lower efficiency than mutations involving only local changes in sequence. This inefficiency stems from two sources. First, the ability of the mutagenic oligonucleotide to form stable hybrids with two separate sequences on the template DNA decreases as a function of the distance between the two sequences. Second, there is an increased probability that the oligonucleotide will hybridize to incorrect sequences on the template DNA. The consequence of these effects is that the efficiency of "loop-in/loop-out" mutagenesis is far lower than the efficiency of mutagenesis of one or two contiguous nucleotides. Furthermore, the proportion of clones that carry alterations at ectopic sites is greatly increased. For these reasons, it is often necessary to screen putative loop-in/loop-out mutants by hybridization with oligonucleotides that are complementary to the desired deletion/insertion junction ("positive probes") and with oligonucleotides that are complementary to the deleted sequence or the starting insertion point ("negative probes") (please see Thigpen and Russell 1992). Finally, because of the high frequency with which incorrect mutations are created, it is essential to determine the complete sequence of the mutagenized DNA (not just the region that is the planned target).

---

**SELECTING AGAINST WILD-TYPE DNA IN SITE-DIRECTED MUTAGENESIS**


---

The frequency of mutations generated by oligonucleotide-mediated mutagenesis varies from >0.1% to nearly 50%, depending on the complexity of the mutation and the underlying efficiency of the method used. In classical oligonucleotide-mediated mutagenesis, a fraction of the wild-type bacteriophage M13, phagemid, or plasmid DNA will escape mutation and will generate nonmutant colonies or plaques, sometimes in considerable numbers. A similar problem arises in PCR-based mutagenesis when double-stranded plasmid DNAs are used as templates (e.g., please see Weiner and Costa 1994; Weiner et al. 1994; Costa et al. 1996).

To alleviate these difficulties, methods have been developed to destroy nonmutant DNAs selectively in vitro or suppress the growth of wild-type clones. In both cases, the net effect is to increase the proportion of mutant clones in the recombinants recovered after site-directed mutagenesis. These selective methods are of particular value when attempting to isolate "difficult" mutants that are generated with low efficiency in primer extension or PCRs (e.g., large deletion mutants and multiple point mutants) or when using pools of oligonucleotides to generate many mutants simultaneously at a defined location in the target DNA.

### Selection In Vitro

#### ***Destruction of Parental Template with DpnI***

The restriction enzyme *DpnI* cleaves double-stranded DNA specifically at the methylated sequence G<sup>m</sup>ATC (Lacks and Greenberg 1975, 1977; Geier and Modrich 1979). Plasmid and bacteriophage DNAs isolated from almost all commonly used strains of *E. coli* have been fully methylated in vivo by the endogenous Dam methylase and are therefore sensitive to cleavage by *DpnI* (McClelland and Nelson 1988). Hemimethylated DNAs are cleaved by *DpnI* at somewhat lower efficiency. By contrast, DNA synthesized in vitro using the four conventional deoxynucleotides is unmethylated and therefore completely resistant to cleavage. Consequently, *DpnI* can be used at the end of site-directed mutagenesis to degrade residual methylated wild-type templates and to enrich for unmethylated DNAs synthesized in vitro. Selective destruction of parental templates by *DpnI* is used chiefly as a method to disinfect double-stranded DNAs synthesized during PCR-based mutagenesis (e.g., please see Ponce and Micol 1992; Weiner and Costa 1994; Costa et al. 1996; Wang and Malcolm 1999).

Another way to achieve biochemical discrimination against the template strand is to incorporate methylated nucleoside triphosphate into the mutant strand during synthesis in vitro. The mutant strand will then be protected against digestion with restriction enzymes such as *HhaI*, *Sau3AI*, and *MspI*, which will degrade the unmodified parental template DNA into small fragments (e.g., please see Vandeyar et al. 1988; Hofer and Kühlein 1993).

#### ***Destruction of Parental Template with Uracil-DNA Glycosylase: The Kunkel Method***

Single-stranded templates of bacteriophage M13 DNA, generated in a strain of *E. coli* carrying *ung*<sup>-</sup> *dut*<sup>-</sup> mutations (please see the panels on *DUT* and *UNG*) contain 20–30 uracil residues in place of thymines (Sagher and Strauss 1983). When this DNA is used as a template in a classical mutagenesis procedure, the product is a heteroduplex molecule with uracil in the wild-type strand and thymine in the strand synthesized in vitro. Exposure of the heteroduplex to uracil-DNA glycosylase, either in vitro or after transfection of the DNA into an *ung*<sup>+</sup> strain, results in removal of the uracil and cleavage of the phosphodiester backbone at the resulting apyrimidinic sites. These lethal lesions result in selective and efficient destruction of the template strand and a reduction in infectivity of approximately five orders of magnitude. A large proportion (up to 80%) of the bacteriophage plaques are therefore derived by replication of the transfecting, uracil-free (-) strand. Because synthesis of this strand is primed by the mutagenic oligonucleotide, many of the progeny bacteriophages carry the desired mutation.

The Kunkel method has changed very little since its introduction (Kunkel 1985; for review, please see Kunkel et al. 1991). Perhaps the one significant improvement is the extension of the technique to include double-stranded templates derived from phagemids (McClary et al. 1989; Wang et al. 1989; Liu et al. 1990; for review, please see Hagemeyer 1996) and plasmids (Jung et al. 1992). This improvement eliminates the need to subclone the fragment of interest into single-stranded vectors before mutagenesis. However, the



yield of mutants is generally rather low and additional steps are often required to reduce the background of wild-type phagemids or plasmids. In addition, because the inserts that can be propagated in double-stranded vectors are larger, significantly more DNA sequencing may be required to confirm the mutation(s) of interest and to verify that no mutations have arisen anywhere else within the target DNA.

### **DUT**

The *dut* gene of *E. coli* encodes dUTPase, a zinc-containing tetrameric pyrophosphatase ( $M_r = 64,000$ ) (Shlomai and Kornberg 1978; Lundberg et al. 1983). In *dut* mutants, the cell's ability to convert dUTP to dUMP is impaired. This decrease results in a 25–30-fold increase in the intracellular pool of dUTP. The elevated ratio of dUTP:dTTP leads to an increase in the frequency of misincorporation of dUTP at a random subset of the sites normally occupied by thymine.

The *dut*<sup>-</sup> mutants of *E. coli* used in the Kunkel method all contain a trace of dUTPase activity (Konrad and Lehman 1975; Hochhauser and Weiss 1978), perhaps because a complete lack of the enzyme is lethal (el-Hajj et al. 1988). Viable *dut*<sup>-</sup> mutants show increased rates of recombination and spontaneous mutation, which result from the temporary strand breaks and gaps in DNA caused by excision of the uracil residues by uracil-DNA glycosylase, encoded by the *ung* gene.

### **UNG**

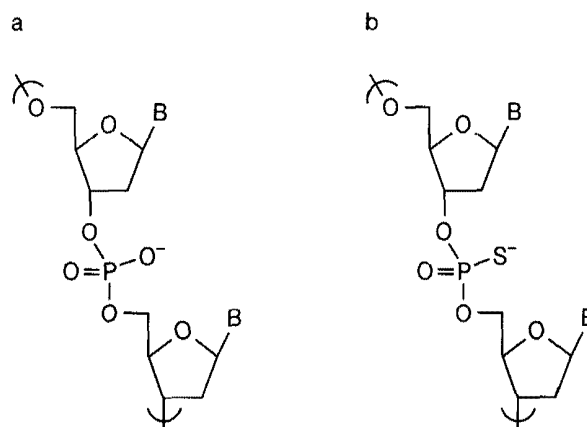
Uracil residues incorporated into DNA in *E. coli* are normally removed by the small monomeric enzyme uracil-DNA glycosylase (deduced  $M_r = 25,664$ ) which cleaves the *N*-glycosidic bond between the base and the deoxyribose phosphate backbone, generating an apyrimidinic site (Lindahl 1974; for review, please see Lindahl 1982; Tomilin and Aprelikova 1989). The phosphodiester backbone at these sites is cleaved by endonucleases (exonuclease III or endonuclease IV) (for review, please see Lloyd and Linn 1993) and then repaired by DNA polymerase I and ligase. Cells deficient in uracil-DNA glycosylase cannot cleave the *N*-glycosidic bond and display increased rates of spontaneous mutation which are biased toward G:C→A:T transitions (Duncan and Miller 1980; Duncan and Weiss 1982).

The *ung* gene of *E. coli* has been cloned (Duncan and Chambers 1984), as have highly conserved *ung* genes from many other organisms including yeast, humans, and herpesviruses (for references, please see Oisen et al. 1991; Lloyd and Linn 1993). These genes probably evolved to remove mutagenic deaminated cytosine residues from DNA.

### **Unique Restriction Site Elimination**

Unique site elimination (USE) is employed in classical oligonucleotide-directed mutagenesis to digest unmutated double-stranded plasmid DNAs that carry a unique restriction site in a nonessential region (Deng and Nickoloff 1992). In this method, two primers are hybridized simultaneously to the denatured template DNA and one primer introduces the desired mutation in the target DNA; the other destroys the unique restriction site in the plasmid. After the *in vitro* mutagenesis reaction is completed, the plasmid DNA is used to transform a strain of *E. coli* that is deficient in correcting mismatched bases, for example, a strain carrying a *mutS*<sup>-</sup> mutation. The mismatched base pairs in the heteroduplex DNA are resolved by replication, rather than repair. The plasmid DNA prepared from pooled transformants is then digested with the restriction enzyme that cleaves wild-type DNA at the unique site. Plasmids that have escaped mutagenesis will be cleaved by the enzyme into linear DNA, which transforms *E. coli* inefficiently. Mutant plasmids, on the other hand, are resistant to digestion, retain full transforming ability, and are efficiently recovered after transformation of a *mutS*<sup>+</sup> strain of *E. coli* (Deng and Nickoloff 1992; Ogetman et al. 1996).

The USE method works with increased efficiency if the two mutations can be combined into a single primer, which may be synthesized *de novo* or, more commonly, generated by PCR. This application is especially useful (1) if the restriction site used for selection is *Bam*HI, *Bgl*III, or *Pvu*II; the restriction site selection based on these enzyme recognition sites, for unknown reasons, does not work well when two separate mutagenic primers are used or (2) if the plasmid used as template is large (>6 kb). For more information, please see instructions provided by the manufacturers of USE mutagenesis kits (e.g., Amersham-Pharmacia) (please see the information panel on **COMMERCIAL KITS FOR SITE-DIRECTED MUTAGENESIS**).



**FIGURE 13-11 Structure of Phosphorothioate-containing Oligonucleotide**

Phosphorothioate analogs of DNA and RNA contain a sulfur atom in place of oxygen in the phosphodiester linkage between bases. (a) Structure of the normal phosphodiester linkage; (b) structure of the phosphorothioate-containing linkage. (Redrawn, with permission, from TriLink BioTechnologies, Inc.)

#### ***Incorporation of Phosphorothioate Analogs into the Mutant Strand***

Phosphorothioate analogs of DNA and RNA contain a sulfur atom in place of a nonbridging oxygen at one or more of the linkages between adjacent nucleotides (for review, please see Eckstein 1985; Zon and Geiser 1991). Nucleic acids containing phosphorothioate internucleotide links can be synthesized *in vitro* by DNA and RNA polymerases in reactions containing nucleoside phosphorothioates as substrates (available from Synthesgen or Applied Biosystems). When supplied with  $S_p$ -diastereomers of dNTP-S or NTP-S, both types of polymerases efficiently catalyze the formation of phosphorothioate internucleotide linkages exclusively in the  $R_p$ -diastereomeric configuration (for review, please see Eckstein and Gish 1989). Incorporation of nucleoside phosphorothioates into a growing DNA or RNA chain therefore involves net inversion of configuration at the bridging phosphorus atom (please see Figure 13-11) (Eckstein 1985).

Phosphorothioate-containing DNAs and RNAs are very similar in structure to conventional nucleic acids. However, the presence of a sulfur atom with a larger van der Waals radius, lower electronegativity, and reduced ability to form multiple bonds results in useful changes in chemical properties that can be harnessed for a variety of purposes in molecular biology and molecular cloning. For example, because of the reduced electrophilicity of the sulfur atom, phosphorothioate linkages in DNA and RNA are resistant to hydrolysis by certain nucleases, with the degree of resistance being dependent on the particular nuclease, the stereochemistry of the phosphorothioate linkage, its distance from the scissile bond, and the type of metal cofactor required by the enzyme.

Phosphorothioates may be used to increase the efficiency of oligonucleotide-directed mutagenesis of both single-stranded templates (Taylor et al. 1985; Nakamaye and Eckstein 1986; Sayers et al. 1988a,b, 1992; Sayers and Eckstein 1989, 1991; Sugimoto et al. 1989) and double-stranded templates (Olsen and Eckstein 1990, 1991). In the case of single-stranded templates, a mismatched oligonucleotide primer is annealed to a single-stranded DNA template as described by Zoller and Smith (1983). The primer is extended by a polymerization reaction catalyzed by bacteriophage T7 DNA polymerase or the Klenow fragment. In this reaction, one of the conventional dNTPs (usually dCTP) is replaced by the corresponding dNTP-S. The resulting heteroduplex therefore consists of a template strand whose backbone contains conventional phosphodiester bonds and a mutated (+) strand that carries phosphorothioate internucleotide linkages to the 5' side of all dC residues apart from those contributed by the mutagenic oligonucleotide primer. Incubation of the heteroduplex with a restriction enzyme (usually *Nci*I or *Ava*I) results in a partial reaction in which the template strand is selectively nicked. The strand carrying phosphorothioate residues is resistant to digestion by the restriction enzyme. The nicks in the template strand are extended by reaction with an exonuclease (exonuclease III, T7 exonuclease, or  $\lambda$  exonuclease). The gap generated in this way is then filled in a second

polymerization reaction in which the mutant (+) strand is used as a template. Because the mutation is now carried on both strands of the DNA, >90% of the plaques generated after transfection consist exclusively of the desired mutant.

When this technique was first developed, the choice of restriction enzymes was limited to those that generated nicked heteroduplexes when presented with substrates that had been asymmetrically labeled with phosphorothioates (Sayers et al. 1988a). However, the number of suitable enzymes is enlarged when the nicking reaction is carried out in the presence of ethidium bromide. Under these conditions, many restriction enzymes introduce nicks into the strand consisting of conventional phosphodiester bonds but are unable to cleave the strand containing phosphorothioate residues (Sayers et al. 1988b; Sayers and Eckstein 1991).

When oligonucleotide-directed mutagenesis is carried out on double-stranded DNA templates, exonuclease digestion is used to generate a region of single-stranded DNA to which the mutagenic oligonucleotide can efficiently anneal. Following polymerization in the presence of three dNTPs and one dNTP-S, a restriction enzyme is used to introduce nicks into the wild-type strand, which contains only conventional phosphodiester bonds. After the nick has been expanded as described above, a second round of polymerization is used to generate a homoduplex that carries the desired mutation in both strands (Olsen and Eckstein 1990, 1991).

### Selection In Vivo

Two primers are hybridized simultaneously to the denatured template DNA; one primer introduces the desired mutation in the target DNA and the other repairs a mutation in an antibiotic resistance gene carried in the vector. After the *in vitro* mutagenesis reaction is completed, the resulting heteroduplex DNA is used to transform a strain of *E. coli* that is deficient in correcting the mismatched base, for example, a strain carrying a *mutS*<sup>-</sup> mutation. The mismatched base pairs in the heteroduplex DNA are resolved by replication, rather than repair. A fraction of the plasmids recovered from the *mutS*<sup>-</sup> transformants will then carry the desired mutation and a newly functional antibiotic resistance gene. These plasmids are then recovered in a second round of transformation — this time into a mismatch-repair competent host — with selection for the restored antibiotic resistance gene (Lewis and Thompson 1990; Hashimoto-Gotoh et al. 1995; Postina and Fahrenholz 1995; Bohnsack 1996).

---

## ***N*<sup>6</sup>-METHYLADENINE, DAM METHYLASE, AND METHYLATION-SENSITIVE RESTRICTION ENZYMES**

---

### **Methylation of Adenine Residues by Dam Methylase**

In *E. coli*, adenine residues embedded in the sequence 5'.....GATC.....3' carry a methyl group attached to the *N*<sup>6</sup> atom (Hattman et al. 1978). More than 99% of these modified adenine bases, which are found on both strands of the palindromic recognition sequence, are formed by action of DNA adenine methylase (*dam*), a single-subunit nucleotide-independent (type II) DNA methyltransferase that transfers a methyl group from S-adenosylmethionine to adenine residues in the recognition sequence (Geier and Modrich 1979; for reviews, please see Marinus 1987; Palmer and Marinus 1994).

The recognition sites of several restriction enzymes (including *PvuI*, *BamHI*, *BclI*, *BglII*, *XhoII*, *MboI*, and *Sau3AI*) contain the sequence 5'.....GATC.....3', as do a proportion of the sites recognized by *ClaI* (~1 site in 4), *XbaI* (1 site in 16), *MboII* (1 site in 16), *TaqI* (1 site in 16), and *HphI* (1 site in 16). The transfer of a methyl group to the *N*<sup>6</sup> atom of adenine places a bulky alkyl substituent in the major groove of B-form DNA and completely prevents cleavage *in vitro* by some restriction enzymes (e.g., *MboI*; Dreiseikelmann et al. 1979). Other restriction enzymes will at best cleave a subset of their recognition sites. For example, *ClaI* recognizes the sequence 5'ATCGAT3'. If this sequence is preceded by G, followed by C, or both, either or both of the A residues will be methylated and the site protected from cleavage. However, methylation does not endow the sequence GATC with absolute immunity from cleavage by any and all restriction enzymes. For example, the restriction enzyme *Sau3AI*, an isoschizomer of *MboI*, cleaves -GATC- sequences regardless of

their state of adenine methylation, whereas the enzyme *DpnI* specifically cleaves fully methylated  $-G^{m6}ATC-$  sequences (Lacks and Greenberg 1975, 1977; Geier and Modrich 1979). DNAs modified by *dam* methylase in vitro also remain sensitive to restriction by the *E. coli* *mcr* and *mrr* systems. Mammalian DNA is not methylated at the  $N^6$  position of adenine and therefore can be cleaved to completion by restriction enzymes that are sensitive to *dam* methylation of prokaryotic DNA.

Lists of restriction enzymes whose pattern of cleavage is affected by *dam* methylation have been assembled by Kessler and Manta (1990) and McClelland and Nelson (1988); additional information may be found in the brochures of most commercial suppliers of enzymes and in a database of restriction and modification enzymes (REBASE) accessible via the Internet at:

<http://www.neb.com/rebase/rebase.html>

When it is necessary to cleave prokaryotic DNA at every possible site with restriction enzymes that are sensitive to *dam* methylation, the DNA must be isolated from strains of *E. coli* that are *dam*<sup>-</sup> (Marinus 1973; Backman 1980; Roberts et al. 1980; McClelland and Nelson 1988). These strains (e.g., GM2163 is available from New England Biolabs and JM110 from the ATCC) exhibit a quirky phenotype, including elevated rates of spontaneous mutation and recombination, increased sensitivity to UV irradiation, high rates of recombination, and increased rates of induction of lysogenic bacteriophages (for discussion, please see Marinus 1987; Palmer and Marinus 1994). *dam*<sup>-</sup> strains are generally less robust than wild-type K-12 strains because deficiency of *dam* impairs the ability of the mismatch repair system to correct errors in the progeny strand of newly replicated DNA (Lu et al. 1983; Pukkila et al. 1983; for reviews, please see Modrich 1989; Palmer and Marinus 1994). The absence of *dam* methylation therefore leads to increased rates of spontaneous mutation. *dam*<sup>-</sup> strains may also exhibit aberrant regulation of certain classes of genes and a reduced efficiency of initiation of DNA replication. Because of these problems, *dam*<sup>-</sup> strains should not be grown for long periods in continuous culture or stored on plates or stab cultures for long periods. Instead, these strains should be stored in small aliquots at  $-70^{\circ}\text{C}$ . In some *E. coli* strains, maintenance of the *dam* mutation is enhanced by growing the cells in the presence of chloramphenicol or kanamycin. In these strains, the *dam* gene was inactivated by insertion of the transposon Tn9, which encodes chloramphenicol resistance (Marinus et al. 1983), or by replacement of part of the gene with a DNA fragment carrying a *kan*<sup>r</sup> marker to inactivate the *dam* gene (Parker and Marinus 1988). A list of commonly used *dam*<sup>-</sup> strains has been published by Palmer and Marinus (1994).

### Unmethylated and Hemimethylated Adenine Residues in GATC

In some strains of *E. coli*, a small fraction ( $\sim 0.2\%$  or less) of the estimated 18,000  $5' \dots \text{GATC} \dots 3'$  sequences are unmethylated (Ringquist and Smith 1992). These unmodified sites appear to be preferentially located near the origin of replication or in regions of genomic DNA that are protected from *dam* methylation in vivo by DNA-binding proteins (e.g., cAMP receptor protein) (Ringquist and Smith 1992; Wang and Church 1992; Hale et al. 1994).

The unique origin of replication in the chromosome of *E. coli* (*oriC*) is highly enriched in GATC sequences. The time of initiation of DNA synthesis is controlled by a number of factors, including the state of methylation of these sequences (for review, please see Crooke 1995). Punctual and timely initiation requires that these *oriC*-proximal GATC sequences be fully methylated by the Dam nuclease. Semiconservative replication generates hemimethylated GATC sequences, which become bound to the bacterial membrane, where they are no longer accessible to Dam methylase. Before the next round of DNA synthesis is initiated, the *oriC* region is released from the membrane and the local GATC sites once again become fully methylated. How these processes are coordinated is not fully understood.

---

**COMMERCIAL KITS FOR SITE-DIRECTED MUTAGENESIS**


---

**TABLE 13-6 Web Resources and Commercial Tools for Mutagenesis**

SOURCE	WEBSITE ADDRESS	COMMENTS/KITS
U.S. Dept. of Commerce	<a href="http://www.nwfsc.noaa.gov/protocols/resources">www.nwfsc.noaa.gov/protocols/resources</a>	Links to many protocol sites as well as to kit and reagent suppliers.
Java-Based Molecular Biology Work Bench	<a href="http://www.embl-heidelberg.de/~toldo/JaMBW">www.embl-heidelberg.de/~toldo/JaMBW</a>	Multiple links to sequence analyses programs, including PCR Primer Design by Luca and Toldo and Oligonucleotide Calculator by Eugen Buehler.
Primer3	<a href="http://www.genome.wi.mit.edu/cgi-bin/primer/primer3.cgi">www.genome.wi.mit.edu/cgi-bin/primer/primer3.cgi</a>	Primer selection programs.
Amersham-Pharmacia Biotech	<a href="http://www.apbiotech.com">www.apbiotech.com</a>	Sculptor IVM Mutagenesis kit.  Unique Site Elimination (USE) mutagenesis kit.
Bio-Rad	<a href="http://www.bio-rad.com/index1">www.bio-rad.com/index1</a>	Muta-gene in vitro mutagenesis kit.
CLONTECH	<a href="http://www.clontech.com">www.clontech.com</a>	Transformer site-directed mutagenesis kit.
Life Technologies	<a href="http://www.lifetech.com">www.lifetech.com</a>	CFLP PowerScan mutation detection system.
PanVera	<a href="http://www.panvera.com/ls/index">www.panvera.com/ls/index</a>	Mutan-Express Km Kit.
Promega	<a href="http://www.promega.com">www.promega.com</a>	Altered Sites II in vitro mutagenesis systems.  Gene Editor System.  Interchange in vivo mutagenesis system.
Stratagene	<a href="http://www.stratagene.com">www.stratagene.com</a>	Quik Change site-directed mutagenesis kit.  ExSite PCR-based site-directed mutagenesis kit.  Chameleon double-stranded site-directed mutagenesis kit.
NEB	<a href="http://www.neb.com">www.neb.com</a>	Code20 kit.
Ana-Gen Technologies Inc.	<a href="http://www.ana-gen.com/Mutagenesis.htm">www.ana-gen.com/Mutagenesis.htm</a>	Provides mutagenesis service.

---

**GLYCEROL**


---

Glycerol (please see Figure 13-12) is used for several purposes in molecular cloning, including:

- **For stabilization of enzymes.** Most enzymes are supplied by commercial manufacturers in buffers containing 50% glycerol, which allows the preparations to be stored at  $-20^{\circ}\text{C}$  without freezing. Glycerols and other polyols are thought to exert their effects by stabilizing protein-protein interactions. Glycerol is therefore widely used to generate continuous density gradients for the analysis of the composition and molecular weights of protein complexes.
- **In gel-loading buffers.** Glycerol is used to increase the density of gel-loading buffers and thereby facilitate the loading of nucleic acids and proteins into the slots of agarose and polyacrylamide gels.

High concentration of glycerol (>8%) in samples applied to DNA sequencing gels, however, generate bends in the sequencing tracks and blurring of bands >300 bases in size (Tabor and Richardson 1987). This smearing is almost certainly because glycerol reacts with boric acid in the gel-running buffer to form negatively charged esters that migrate through the gel during electrophoresis (Böeseken 1949). This problem can be solved in several ways (Pisa-Williamson and Fuller 1992):

Diluting the DNA polymerase into buffers that do not contain glycerol.

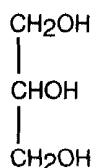
Replacing boric acid in the gel and in the running buffer with taurine, a weak aminosulfonic acid with a  $pK_a$  similar to that of boric acid. Taurine/EDTA/Tris buffer consists of 1.78 M Tris, 0.57 M taurine, and 0.01 M EDTA. A 20x solution therefore contains 216 g of Tris, 72 g of taurine, and 2 g of EDTA per liter.

Precipitating the products of the sequencing reaction with ethanol before loading onto the gel.

- **In polyacrylamide gels.** Glycerol is included in some types of nondenaturing polyacrylamide gels to improve the electrophoretic separation of conformers of single-stranded DNA molecules during analysis of mutations by SSCP (Glavac and Dean 1993).

The reasons for the beneficial effects of glycerol, which are most evident when SSCP gels are run at room temperature, are unclear. Kukita et al. (1997) showed that the pH of the gel buffer is lowered from 8.4 to 7.7 by the addition of glycerol, which reacts with the borate ions in TBE. However, it is difficult to see how this effect could explain the temperature-dependent improvement in resolution of single-stranded conformers. Hayashi (1991) proposed that glycerol and other polyols such as sucrose and polyethylene glycol (Markoff et al. 1997) are weak denaturants, whose polar OH groups disrupt the filigree of hydrogen bonding in single-stranded conformers. This explanation is consistent with the observation that glycerol preferentially increases the mobility of conformers that are rich in purines.

- **For glycerol boosts that increase the efficiency** of transient expression and transformation of mammalian cells. Transfected cultures are exposed briefly to 15–20% glycerol in isotonic saline (Frost and Williams 1978; Parker and Stark 1979). Glycerol is toxic, but the speed and efficiency of its poisonous effects vary widely from one type of cell to another. The optimal time, length, and intensity of treatment must therefore be determined empirically for each cell line.
- **In glycerol step gradients** (Vande Woude et al. 1979), which are used as a faster and cheaper alternative to CsCl step gradients (Yamamoto et al. 1970) in the large-scale purification of bacteriophage  $\lambda$  particles. Pure glycerol has a density of 1.26 g/ml, which is hardly sufficient to support bacteriophage  $\lambda$  particles (density  $\sim 1.40$  g/ml). Glycerol step gradients are therefore centrifuged only for sufficient time to concentrate the virus particles at one of the steps.
- **For long-term storage of bacterial stocks.** Bacterial cultures can be stored indefinitely at  $-70^{\circ}\text{C}$  without significant loss of viability in media containing 15% (v/v) of glycerol.



**FIGURE 13-12** Structure of Glycerol

---

## MUTATION DETECTION

Detection of mutations is essential for the molecular analysis of inherited diseases of humans, for positional cloning of the genes that cause such diseases, and more generally, to correlate phenotype with genotype in organisms as diverse as mice and slime molds. In mutation detection, proband DNAs are tested for differences from a reference (wild-type DNA). At present, DNA sequencing is the only method capable of detecting and identifying single-base mutations with certainty and precision. However, because sequencing of kilobase lengths of DNA is expensive, slow, and dreary, many different techniques have been developed to localize mutations and hence reduce sequencing to a minimum. The existing tests differ widely in their power of ascertainment, accuracy, speed, and cost, and each only detects a subset of mutations. At present, therefore, detection and localization of uncharacterized mutations often require the sequential application of two or more tests, followed by confirmatory DNA sequencing. Tests to detect mutations can be divided into two categories: scanning methods and specific methods.

Scanning methods are used to search segments of DNA for uncharacterized mutations. Three types of scanning tests are in common use:

- **Tests based on differences** in electrophoretic migration between mutant and reference (wild-type) DNAs. Included in this class are denaturing gradient gel electrophoresis (DGGE) and single-stranded conformational polymorphism (SSCP). These tests, which are simple and cheap, are typically used to localize mutations to segments of DNA ~200 bp in length.
- **Tests based on detection** of sequence changes in concert with electrophoretic migration differences. Two fingerprinting strategies have been described that use SSCP to resolve differences generated either by the creation or loss of a dideoxy termination site, known as dideoxy fingerprinting (ddF) or bidirectional dideoxy fingerprinting (Bi-ddF), or by the creation or loss of a restriction endonuclease recognition site, known as restriction endonuclease fingerprinting (REF). In general, the fingerprinting methods are more difficult and expensive, but they are capable of mapping mutations with a resolution of ~10 bp, and thus are easily confirmed by sequencing.
- **Tests based on chemical cleavage** of mismatched bases (CCM) in heteroduplexes formed between reference and mutant nucleic acids. Such mismatches can be cleaved by enzymes such as RNases, DNA repair enzymes, and resolvases or by chemicals such as hydroxylamine and osmium tetroxide. These tests can be used to scan segments of nucleic acids up to 1.5 kb in length and can ascertain the position of the mutation with accuracy. However, enzymatic tests detect different types of mismatches with different efficiencies, and the extent of cleavage is often dependent on local context. CCM is more dependable but requires toxic chemicals, which must be handled in an appropriately vented chemical fume hood.

Specific methods are used to ascertain whether a previously characterized mutation is present in a particular proband DNA. These methods include hybridization to allele-specific oligonucleotides (ASO), allele-specific amplification (amplification refractory mutation system [ARMS], or competitive oligonucleotide priming [COP]), oligonucleotide ligation assay (OLA), or base-specific primer extension. For mutations that alter restriction sites, additional methods are available, including restriction fragment length polymerase (RFLP)/PCR.

Table 13-7 catalogs the commonly used tests to screen mammalian genes for mutations. The strengths and weaknesses of many of these tests have been extensively reviewed (e.g., please see Cotton 1989, 1992; Rossiter and Caskey 1990; Condie et al. 1993; Grompe 1993; Prosser 1993; Saleeba and Cotton 1993; Smooker and Cotton 1993; Dean 1995; Forrest et al. 1995; Liu and Sommer 1995; Liu et al. 1997).

**TABLE 13-7 Summary of Methods Commonly Used to Detect Mutations**

METHOD AND ACRONYM	PRINCIPLE	STRENGTHS/LIMITATIONS	KEY REFERENCES
Protein truncation test (PTT)	PTT is used to search coding sequences for mutations that result in premature chain termination of a specific target protein. PCR is first used to detect a mammalian sequence for initiation of translation, and a sequence unique for the segment of DNA to be amplified, in-frame with the initiating ATG. PCR products are then used without purification in a coupled transcription-translation system. The resulting radiolabeled polypeptides are analyzed by SDS-PAGE. Chain-terminating mutations will generate truncated products.	PTT detects chain-terminating mutations in 1–2-kb segments of amplified cDNA or a single large exon of genomic DNA. Overlapping PCR from cDNA templates must be used to ensure that mutations near the beginning of exons are ascertained.  PTT does not localize the underlying mutation precisely and is not useful for small exons since very short protein fragments are easily lost by degradation or during SDS-PAGE.	Powell et al. (1993); Roest et al. (1993); Prosser et al. (1994)
Denaturing gradient gel electrophoresis (DGGE)	When double-stranded DNA migrates through increasing concentrations of urea and formamide, the complementary strands will dissociate in a domain-dependent fashion. The dissociation causes an abrupt decrease in the mobility of the fragment in polyacrylamide gels. The presence of a mutation may change the stability of its local domain and hence alter its pattern of migration.	DGGE/CDGE is used to analyze PCR-amplified, G-C clamped segments of DNA <500 bp in length. The technique is best suited to scanning multiple samples for mutations in the same DNA fragment. An experienced investigator can detect close to 100% of single-base mutations, assign them to a domain, and make an intelligent guess about the nature of the mutation. A change from A/T to G/C usually increases the stability of the local domain; a change from G/C to A/T usually has a destabilizing effect. The exact position and nature of the mutation must be confirmed by DNA sequencing. DGGE requires specialized equipment and a distinctly user-unfriendly computer program, which is needed to select sequences for oligonucleotide primers.	Fischer and Lerman (1983); Myers et al. (1987); Sheffield et al. (1989)
	When preparing DNA for analysis by DGGE, PCR is used to attach an ~40-bp G-C clamp to one end of the fragment. This clamp provides a highly stable, denaturation-resistant domain that allows mutations in lower melting domains to be ascertained (Sheffield et al. 1989). Heteroduplexes between a wild-type strand and a potential mutant strand will be destabilized by the single base-pair mismatch and will therefore migrate more slowly than either homoduplex. Heteroduplexes generated during PCR amplification of heterozygous genomic DNA can therefore greatly assist in the detection of mutations.		
	A variation of DGGE (constant denaturant gel electrophoresis or CDGE) uses a temperature gradient and a gel containing a constant concentration of denaturant (Rosenbaum and Riesner 1987; Riesner et al. 1989; Borreson et al. 1991a,b; Hovig et al. 1991).		Rosenbaum and Riesner (1987); Riesner et al. (1989); Borreson et al. (1991a,b); Hovig et al. (1991)



Single-strand conformational polymorphism (SSCP)

Intrastrand base pairing causes single-stranded DNA molecules to form complex secondary structures. Alteration of the nucleotide sequence of the molecule by as little as a single base can reshape the secondary structure, with consequent changes in electrophoretic mobility. SSCP exploits the differences in mobility between wild-type and mutant strands of DNA. In most cases, the material analyzed by SSCP has been amplified by PCR from genomic DNA (PCR-SSCP) and is 50–400 bases in length. The DNA is denatured with alkali and then analyzed by electrophoresis under non-denaturing conditions at neutral pH. With a wild-type molecule, two bands are generally seen on the gel, corresponding to each of the single strands of the PCR product. However, additional bands, corresponding to different conformations, may sometimes be seen. The PCR product of a heterozygous allele should generate at least four bands, two of which should be identical in mobility to the wild-type bands and two that are characteristic of the particular mutation.

SSCP requires no specialized equipment and is the fastest and simplest of all the techniques to scan DNA fragments for the presence of mutations. Like DGGE, however, SSCP assigns mutations to a region but does not define them or map them precisely. Close to 100% of mutations can be detected in fragments of 100–300 bases if the analysis is performed under several different gel-running conditions (e.g., 0.5x TBE at 4°C with and without 5% glycerol). The use of longer fragments leads to decreasing efficiency of detection.

Orita et al. (1989a,b, 1990); Ainsworth et al. (1991); Dean and Gerrard (1991); Condie et al. (1993); Glavac and Dean (1993)

RNase cleavage of mismatches

Mismatches in RNA:RNA heteroduplexes formed between a reference wild-type RNA and a putative mutant RNA are cleaved by ribonuclease A. Mismatches in RNA:DNA heteroduplexes are cleaved by RNase I or by a combination of ribonuclease T1 and ribonuclease A. After digestion, the size of the probe strand is assayed by denaturing polyacrylamide gel electrophoresis. The reference and probe nucleic acids are generated by amplifying individual exons of genomic DNA or cDNA encoded by the target gene. The upstream primer contains a consensus sequence for the bacteriophage T7 promoter which can be used to generate RNA templates. A variation, known as the nonisotopic RNase cleavage assay (NIRCA) is based on the ability of RNase A to cleave both strands of a duplex RNA target carrying mismatched base pairs (Goldrick et al. 1996). Cleavage products of duplex RNA, generated by *in vitro* transcription of the amplified target DNA, are resolved by electrophoresis and detected by staining.

Some mismatches in heteroduplexes, particularly those with purines in the probe strand, are cleaved poorly by RNase A and RNase T1; cleavage is often context-dependent and nonspecific cleavages are common. Between 30% and 60% of single-base substitutions go undetected by this assay (Cotton 1992; Prosser 1993). RNase I (Murthy et al. 1995) may be a better alternative since it has a broader specificity. At its best, however, the method is capable of scanning 1-kb tracts of DNA and of localizing the position of the mutation with accuracy.

Freeman and Huang (1981); Gibbs and Caskey (1987); Winter et al. (1985); Myers et al. (1985a, 1988); Rojas et al. (1995); Murthy et al. (1995); Goldrick et al. (1996)

In the alternative assay (NIRCA), the transcription reaction produces target RNA sufficient to detect cleavage products directly in the gel, thus bypassing the need to synthesize and purify a radiolabeled probe. Reagents required for the NIRCA protocol are available as a kit (Mismatch Detect II from Ambion).

(Continued on the following pages.)

TABLE 13-7 (Continued)

METHOD AND ACRONYM	PRINCIPLE	STRENGTHS/LIMITATIONS	KEY REFERENCES
Detection of point mutations with DNA mismatch repair enzymes	The <i>E. coli mutY</i> gene encodes an enzyme that cleaves the adenine residue in G:A mismatches. HeLa cell thymidine glycosylase cleaves the thymine residue in G:T mismatches. For mutation detection, heteroduplexes formed in vitro between proband DNA and wild-type DNA are cleaved by a combination of mismatch repair enzymes. The size of cleavage products is then ascertained by denaturing PAGE.	The method, which is used on PCR-amplified exons of genomic DNA, is claimed to detect as little as 1% mutant sequences in a mixture of mutant and wild-type DNAs; all possible single-base mismatches can be detected, albeit with varying efficiencies. The location of the mutation is determined with accuracy. Nonspecific cleavage by <i>mutY</i> and thymidine glycosylase is a possible problem.	Lu and Hsu (1992); Hsu et al. (1994)  Marshall et al. (1995); Youil et al. (1995)
Cleavage of mismatches with bacteriophage resolvases (T4 endonuclease VII and T7 endonuclease I)	Resolvases recognize mismatched bases in double-stranded DNA and cut the DNA at the mismatch. For mutation detection, heteroduplexes are formed in vitro between proband DNA and wild-type DNA and cleaved by resolvases. The size of cleavage products is ascertained by denaturing PAGE.	Nearly all possible mismatches are cleaved, albeit with varying efficiencies. The location of the mutation is determined with accuracy.  In the test series reported by Youil et al. (1995) and Marshall et al. (1995), two single-base mismatches (G:A and A:T) went undetected, suggesting that context may affect the efficiency of cleavage. Nonspecific cleavage by resolvases is also a possible problem.	
Dideoxy fingerprinting (ddF and Bi-ddF)	ddF is a combination of SSCP and Sanger dideoxy sequencing. A conventional dideoxy sequencing reaction is carried out with a single dideoxy terminator and the products are analyzed by electrophoresis under nondenaturing conditions. The banding patterns (fingerprints) obtained from ddF resemble a rather blurry sequencing gel. Mutations, which are detected by comparing fingerprints generated from reference and probe sequences, can result in gain or loss of a termination site, a change in mobility of the products of the reaction, or both. In most cases, the templates for ddF are RNAs generated by in vitro transcription of amplified genomic DNAs. However, any sequencing protocol could be adapted to ddF.	Unlike SSCP, ddF provides information about the position of the mutation within the fragment under analysis. With experience in reading gels, mutations can be localized with an accuracy of ~10 bp when segments of 200 bp are analyzed. Larger segments of DNA can be amplified and then screened in 200-bp segments by primer walking. When ddF reactions are carried out in both directions (bidirectional or Bi-ddF), heterozygous mutations can be detected with high efficiency (Liu and Sommer 1994; Blaszyk et al. 1995; Liu et al. 1997). Detection rates approaching 100% for homozygous mutations have been reported and the method has been adapted for use with automated DNA sequencers (Ellison et al. 1994). ddF requires ~50% more effort and costs about twice as much as SSCP performed under one condition.	Sarkar et al. (1992); Ellison et al. (1994); Liu and Sommer (1994); Blaszyk et al. (1995); Liu et al. (1997)
Restriction endonuclease fingerprinting (REF)	Similar in concept to ddF, REF is used to detect mutations in target fragments that result in the creation or loss of a restriction endonuclease recognition site. A set of overlapping segments of DNA is created by amplification of the target segment, and, after individual digestion with a member of a reference group of restriction endonucleases, the target sequences are resolved by SSCP and then confirmed by DNA sequencing.	REF is best used for detecting mutations in large exons or in many small introns, for example, in fragments ranging from 1.5 to 2 kb in length. Selecting the optimal group of restriction endonucleases is facilitated by the use of special software designed for this application. The REF Select program is available from <a href="mailto:ssomers@smtplink.coh.org">ssomers@smtplink.coh.org</a> . Detection rates approaching 100% for a 1.9-kb segment of DNA have been reported (Liu et al. 1997).	

CDI modification	Water-soluble carbodiimide reacts with the imino sites of mispaired guanine and thymine residues forming a bulky adduct that (1) subtly alters the electrophoretic mobility of heteroduplexes containing single-base mismatches, (2) can be cleaved with piperidine, and (3) prevents extension of a primer by <i>Taq</i> DNA polymerase. In the latter case, the truncated product is detected by PAGE.	Piperidine cleavage of CDI adducts can detect most, if not all, mispaired guanine and thymine residues in heteroduplexes, albeit with varying efficiency. Using inhibition of primer extension, only ~50% of mispaired guanine residues are detected. Problems encountered include internal priming and nonspecific modification by CDI. The method, which does not identify the location of mutations precisely, needs careful optimization before it can be applied routinely.	Novack et al. (1986); Ganguly et al. (1989); Ganguly and Prockop (1990)
Chemical cleavage of mismatch (CCM)	A labeled heteroduplex molecule between a wild-type sequence and a potential mutant is treated with either hydroxylamine (which modifies mismatched cytosine residues), osmium tetroxide (which modifies mismatched thymine residues), or both reagents. The chemically modified bases are then cleaved with piperidine, and the resulting fragments of DNA are analyzed by PAGE.	100% of mutations can be ascertained when heteroduplexes are end-labeled on the coding and noncoding strands, respectively, and are modified in parallel reactions by both hydroxylamine and osmium tetroxide. Heteroduplexes >1 kb in size can be analyzed, and mutations can be localized with high precision. The major drawback of the chemical cleavage method is that it uses hazardous chemicals, is labor-intensive, and is not easily automated. However, the use of strand-specific fluorophores as end labels instead of radioactive isotopes (Verpy et al. 1994) opens the possibility that the products of chemical cleavage reactions could be analyzed on automated DNA sequencers.	Cotton et al. (1988); Cotton (1992); Condie et al. (1993); Smooker and Cotton (1993); Verpy et al. (1994)
RFLP/PCR	RFLP is used to detect mutations (small deletions, insertions, and single-base changes) that render restriction sites resistant to cleavage. Wild-type genomic DNA is eliminated from the sample by restriction digestion and the resistant DNA is then amplified by PCR, using primers that lie upstream and downstream from the restriction site.	RFLP/PCR can detect specific mutations with high sensitivity. This is because the PCR step suppresses background caused by the presence of wild-type DNA. However, the method is of limited value since it can be applied only to sequences that harbor a known restriction site. The method therefore cannot be used to establish the entire spectrum of mutations in a gene.	Pourzand and Cerutti (1993)
Allele-specific oligonucleotides (ASO)	Allele-specific oligonucleotides, usually 14–17 bases in length, can be used as hybridization probes to distinguish between wild-type and a known mutant allele. Hybridization and washing conditions are established that (1) preserve perfect hybrids between the oligonucleotide probe and its target sequence and (2) eliminate hybrids that contain a mismatched nucleotide. Originally carried out on total genomic DNA (Conner et al. 1983; for review, please see Cotton 1989), ASO is now used exclusively to establish the presence or absence of specific mutations in PCR-amplified fragments of genomic DNA. In the so-called reverse ASP system, a range of different oligonucleotides representing different mutations are bound to a solid matrix and labeled PCR products of proband DNAs are hybridized to them.	ASO can only be used when the mutation of interest has been mapped precisely and ascertained by sequencing. Design of the oligonucleotide is the key to success, with the mutant bases being placed in the center of the oligonucleotide, where they exert maximum destabilizing effect when they are mispaired.	Saiki et al. (1986)

(Continued on the following page.)

TABLE 13-7 (Continued)

METHOD AND ACRONYM	PRINCIPLE	STRENGTHS/LIMITATIONS	KEY REFERENCES
Amplification refractory mutation system (ARMS) and competitive oligonucleotide priming (COP)	<p>ARMS can be used to distinguish between wild-type and a known mutant allele. An oligonucleotide carrying a base that forms a mismatch with the template strand primes DNA synthesis with very low efficiency in PCRs. In ARMS, two pairs of primers are used. One oligonucleotide of each pair contains either the wild-type or mutant base at its 3' end. The PCR will work efficiently only when the 3' base of the oligonucleotide forms a perfect hybrid with the template DNA, i.e., wild-type DNA with the normal oligonucleotide and mutant DNA with the mutant oligonucleotide.</p> <p>In COP, a wild-type oligonucleotide and a mutant oligonucleotide, labeled with different fluorophores, compete for the same sequence on the template DNA. Amplification occurs only when the oligonucleotide perfectly matches the template. The potentially mismatched base is placed in the center of the oligonucleotide, where its destabilizing effect on the hybrid is maximal.</p>	<p>ARMS is the more useful of these two techniques. By contrast to COP, which requires an automated sequencer to detect which fluor has been incorporated into the PCR product, ARMS requires no special equipment. Mandatory controls in both systems include the use of wild-type and previously validated mutant templates.</p>	<p>Newton et al. (1989); Sommer et al. (1989); Gibbs et al. (1989)</p>
Oligonucleotide ligation assay (OLA)	<p>Two oligonucleotides are positioned on the template with the 5' base of one oligonucleotide abutting the 3' base of the other. If these two bases form perfect hybrids with the target DNA, the oligonucleotides can be ligated together by DNA ligase. If a thermostable ligase is used, the reaction can be carried out for multiple cycles, much like a linear PCR. This greatly enhances the ratio of signal to noise.</p>		<p>Wu and Wallace (1989); Barany (1991a,b); Landegren (1993)</p>
Primer extension	<p>This method relies on extension by one labeled nucleotide of an oligonucleotide primer that binds to sequences immediately adjacent to the site of a previously defined mutation. Each labeled [<math>\alpha</math>-<sup>32</sup>P]dNTP is used in a separate PCR, and the products of all four reactions are analyzed by electrophoresis through a 20% polyacrylamide gel.</p>	<p>This method ascertains previously defined mutations in genomic DNA with high accuracy. Other primer extension methods have been developed, but these are less accurate and/or technically more demanding.</p>	<p>Sokolov (1990)</p>

## REFERENCES

- Ainsworth P.J., Surh L.C., and Coulter-Mackie M.B. 1991. Diagnostic single strand conformational polymorphism, (SSCP): A simplified non-radioisotopic method as applied to a Tay-Sachs B1 variant. *Nucleic Acids Res.* **19**: 405-406.
- Aiyar A., Xiang Y., and Leis J. 1996. Site-directed mutagenesis using overlap extension PCR. *Methods Mol. Biol.* **57**: 177-191.
- Akabas M.H., Stauffer D.A., Xu M., and Karlin A. 1992. Acetylcholine receptor channel structure probed in cysteine-substitution mutants. *Science* **258**: 307-310.
- Alavantic D., Glisic S., Radovanovic N., and Romic M. 1998. A simple PCR with different 3' ends of the third primer for detection of defined point mutations: HCV genotyping as an example. *Clin. Chem. Lab. Med.* **36**: 587-588.
- Ansaldi M., Lepelletier M., and Mejean V. 1996. Site-specific mutagenesis by using an accurate recombinant polymerase chain reaction method. *Anal. Biochem.* **234**: 110-111.
- Arkin A.P. and Youvan D.C. 1992. Optimizing nucleotide mixtures to encode specific subsets of amino acids for semi-random mutagenesis. *Bio/Technology* **10**: 297-300.
- Axon R.A. and Hanson I.M. 1998. Conformation-based mutation detection. *Elsevier Trends Journals Technical Tips Online* (#01390).
- Backman K. 1980. A cautionary note on the use of certain restriction endonucleases with methylated substrates. *Gene* **11**: 169-171.
- Barany F. 1991a. Genetic disease detection and DNA amplification using cloned thermostable ligase. *Proc. Natl. Acad. Sci.* **88**: 189-193.
- . 1991b. The ligase chain reaction (LCR) in a PCR world. *PCR Methods Appl.* **1**: 5-16.
- Barnhart K.M. 1999. Simplified PCR-mediated, linker-scanning mutagenesis. *BioTechniques* **26**: 624-626.
- Bass S.H., Mulkerrin M.G., and Wells J.A. 1991. A systematic mutational analysis of hormone-binding determinants in the human growth hormone receptor. *Proc. Natl. Acad. Sci.* **88**: 4498-4502.
- Bebenek K. and Kunkel T.A. 1989. The use of native T7 DNA polymerase for site-directed mutagenesis. *Nucleic Acids Res.* **17**: 5408.
- Bencen G.H., Wei C.F., Robberson D.L., and Gray Jr., H.B. 1984. Terminally directed hydrolysis of duplex ribonucleic acid catalyzed by a species of the BAL 31 nuclease from *Alteromonas espejiana*. *J. Biol. Chem.* **259**: 13584-13589.
- Bennett W.F., Paoni N.E., Keyt B.A., Botstein D., Jones A.J., Presta L., Wurm F.M., and Zoller M.J. 1991. High resolution analysis of functional determinants on human tissue-type plasminogen activator. *J. Biol. Chem.* **266**: 5191-5201.
- Blaszyk H., Hartmann A., Schroeder J.J., McGovern R.M., Sommer S.S., and Kovach J.S. 1995. Rapid and efficient screening for p53 gene mutations by dideoxyfingerprinting. *BioTechniques* **18**: 256-260.
- Bösesken J. 1949. The use of boric acid for the determination of the configuration of carbohydrates. *Adv. Carbohydr. Chem.* **4**: 189-210.
- Bohnsack R.N. 1996. Site-directed mutagenesis using positive antibiotic selection. *Methods Mol. Biol.* **57**: 1-12.
- Borreson A.-L., Hovig E., Smith-Sorensen B., Lystad S., and Brogger A. 1991a. Mutations analysis in human cancers using PCR and constant denaturant gel electrophoresis. *Adv. Mol. Genet.* **4**: 63-71.
- Borreson A.-L., Hovig E., Smith-Sorensen B., Malkin D., Lystad S., Andersen I.T., Nesland J.M., Isselbacher K.J., and Friend S.H. 1991b. Constant denaturant gel electrophoresis as a rapid screening technique for p53 mutations. *Proc. Natl. Acad. Sci.* **88**: 8405-8409.
- Brown D.M., McNaught A.D., and Schell P.D. 1966. The chemical basis of hydrazine mutagenesis. *Biochem. Biophys. Res. Commun.* **24**: 967-971.
- Brutlag D. and Kornberg A. 1972. Enzymatic synthesis of deoxyribonucleic acid. 36. A proofreading function for the 3' leads to 5' exonuclease activity in deoxyribonucleic acid polymerases. *J. Biol. Chem.* **247**: 241-248.
- Busby S., Irani M., and Crombrughe B. 1982. Isolation of mutant promoters in the *Escherichia coli* galactose operon using local mutagenesis on cloned DNA fragments. *J. Mol. Biol.* **154**: 197-209.
- Caruthers M.H., Beaucage S.L., Becker C., Efcavitch J.W., Fisher E.F., Galluppi G., Goldman R., deHaseth P., Matteucci M., McBride L., et al. 1983. Deoxyoligonucleotide synthesis via the phosphoramidite method. *Gene Amplif. Anal.* **3**: 1-26.
- Chan K.Y., Baumann L., Garza M.M., and Baumann P. 1978. Two new species of *Alteromonas*: *Alteromonas espejiana* and *Alteromonas undina*. *J. Syst. Bacteriol.* **28**: 217-222.
- Chu C.T., Parris D.S., Dixon R.A., Farber F.E., and Schaffer P.A. 1979. Hydroxylamine mutagenesis of HSV DNA and DNA fragments: Introduction of mutations into selected regions of the viral genome. *Virology* **98**: 168-181.
- Collins F.S. and Weissman S.M. 1984. Directional cloning of DNA fragments at a large distance from an initial probe: A circularization method. *Proc. Natl. Acad. Sci.* **81**: 6812-6816.
- Colosimo A., Xu Z., Novelli G., Dallapiccola B., and Gruenert D.C. 1999. Simple version of "megaprimer" PCR for site-directed mutagenesis. *BioTechniques* **26**: 870-873.
- Condie A., Eeles R., Borresen A.L., Coles C., Cooper C., and Prosser J. 1993. Detection of point mutations in the p53 gene: Comparison of single-strand conformation polymorphism, constant denaturant gel electrophoresis, and hydroxylamine and osmium tetroxide techniques. *Hum. Mutat.* **2**: 58-66.
- Conley E.C. and Saunders J.R. 1984. Recombination-dependent circularization of linearized pBR322 plasmid DNA following transformation of *Escherichia coli*. *Mol. Gen. Genet.* **194**: 211-218.
- Conner B.J., Reyes A.A., Morin C., Itakura K., Teplitz R.L., and Wallace R.B. 1983. Detection of sickle cell  $\beta$  S-globin allele by hybridization with specific oligonucleotides. *Proc. Natl. Acad. Sci.* **80**: 278-282.
- Costa G.L., Bauer J.C., McGowan B., Angert M., and Weiner M.P. 1996. Site-directed mutagenesis using a rapid PCR-based method. *Methods Mol. Biol.* **57**: 239-248.
- Cotton R.G.H. 1989. Detection of single base changes in nucleic acids. *Biochem. J.* **263**: 1-10.
- . 1992. Detection of single base changes in nucleic acid. *Adv. Genome Biol.* **1**: 253-300.
- Cotton R.G.H., Rodriguez N.R., and Campbell R.D. 1988. Reactivity of cytosine and thymine in single-base-pair mismatches with hydroxylamine and osmium tetroxide and its application to the study of mutations. *Proc. Natl. Acad. Sci.* **85**: 4397-4401.

- Crooke E. 1995. Regulation of chromosomal replication in *E. coli*: Sequestration and beyond. *Cell* **82**: 877–880.
- Cunningham B.C. and Wells J.A. 1989. High-resolution epitope mapping of hGH-receptor interactions by alanine-scanning mutagenesis. *Science* **244**: 1081–1085.
- Dale S.J. and Belfield M. 1996. Oligonucleotide-directed random mutagenesis using the phosphorothioate method. *Methods Mol. Biol.* **57**: 369–374.
- Dale S.J., Belfield M., and Richardson T.C. 1991. Oligonucleotide-directed random mutagenesis using a high efficiency procedure. *Methods* **3**: 145–153.
- Dean M. 1995. Resolving DNA mutations. *Nat. Genet.* **9**: 103–104.
- Dean M. and Gerrard B. 1991. Helpful hints for the detection of single-stranded conformation polymorphisms. *BioTechniques* **10**: 332–333.
- Deng W.P. and Nickoloff J.A. 1992. Site-directed mutagenesis of virtually any plasmid by eliminating a unique site. *Anal. Biochem.* **200**: 81–88.
- DiMaio D. and Nathans D. 1980. Cold-sensitive regulatory mutants of simian virus 40. *J. Mol. Biol.* **140**: 129–142.
- Doetsch P.W. and Cunningham R.P. 1990. The enzymology of apurinic/aprimidinic endonucleases. *Mutat. Res.* **236**: 173–201.
- Donelson J.E. and Wu R. 1972. Nucleotide sequence analysis of deoxyribonucleic acid. VII. Characterization of *Escherichia coli* exonuclease 3 activity for possible use in terminal nucleotide sequence analysis of duplex deoxyribonucleic acid. *J. Biol. Chem.* **247**: 4661–4668.
- Dorrell N., Gyselman V.G., Foyne S., Li S.R., and Wren B.W. 1996. Improved efficiency of inverse PCR mutagenesis. *BioTechniques* **21**: 604–608.
- Dreiseikelmann B., Eichenlaub R., and Wackernagel W. 1979. The effect of differential methylation by *Escherichia coli* of plasmid DNA and phage T7 and lambda DNA on the cleavage by restriction endonuclease *MboI* from *Moraxella bovis*. *Biochim. Biophys. Acta* **562**: 418–428.
- Du Z., Regier D.A., and Desrosiers R.C. 1995. Improved recombinant PCR mutagenesis procedure that uses alkaline-denatured plasmid template. *BioTechniques* **18**: 376–378.
- Duncan B.K. and Chambers J.A. 1984. The cloning and overproduction of *Escherichia coli* uracil-DNA glycosylase. *Gene* **28**: 211–219.
- Duncan B.K. and Miller J.H. 1980. Mutagenic deamination of cytosine residues in DNA. *Nature* **287**: 560–561.
- Duncan B.K. and Weiss B. 1982. Specific mutator effects of *ung* (uracil-DNA glycosylase) mutations in *Escherichia coli*. *J. Bacteriol.* **151**: 750–755.
- Duntzen R.L., Sahin-Tóth M., and Kaback H.R. 1993. Cysteine scanning mutagenesis of putative helix XI in the lactose permease of *Escherichia coli*. *Biochemistry* **32**: 12644–12650.
- Eckstein F. 1985. Nucleoside phosphorothioates. *Annu. Rev. Biochem.* **54**: 367–402.
- Eckstein F. and Gish G. 1989. Phosphorothioates in molecular biology. *Trends Biochem. Sci.* **14**: 97–100.
- el-Hajj H.H., Zhang H., and Weiss B. 1988. Lethality of a *dut* (deoxyuridine triphosphatase) mutation in *Escherichia coli*. *J. Bacteriol.* **170**: 1069–1075.
- Ellison J., Squires G., Crutchfield C., and Goldman D. 1994. Detection of mutations and polymorphisms using fluorescence-based dideoxy fingerprinting (F-ddF). *BioTechniques* **17**: 742–753.
- Fan E., Levin D.B., Glickman B.W., and Logan D.M. 1993. Limitations in the use of SSCP analysis. *Mutat. Res.* **288**: 85–92.
- Fischer S.G. and Lerman L.S. 1983. DNA fragments differing by single base-pair substitutions are separated in denaturing gradient gels: Correspondence with melting theory. *Proc. Natl. Acad. Sci.* **80**: 1579–1583.
- Forrest S., Cotton R., Landegran U., and Southern E. 1995. How to find all those mutations. *Nat. Genet.* **10**: 375–378.
- Freeman G.J. and Huang A.S. 1981. Mapping temperature-sensitive mutants of vesicular stomatitis virus by RNA heteroduplex formation. *J. Gen. Virol.* **57**: 103–117.
- Frillingos S. and Kaback H.R. 1996. Probing the conformation of the lactose permease of *Escherichia coli* by in situ site-directed sulfhydryl modification. *Biochemistry* **35**: 3950–3956.
- . 1997. The role of helix VIII in the lactose permease of *Escherichia coli*. II. Site-directed sulfhydryl modification. *Protein Sci.* **6**: 438–443.
- Frillingos S., Gonzalez A., and Kaback H.R. 1997a. Cysteine-scanning mutagenesis of helix IV and the adjoining loops in the lactose permease of *Escherichia coli*: Glu126 and Arg144 are essential. *Biochemistry* **36**: 14284–14290.
- Frillingos S., Sahin-Tóth M., Wu J., and Kaback H.R. 1998. Cys-scanning mutagenesis: A novel approach to structure function relationships in polytopic membrane proteins. *FASEB J.* **12**: 1281–1299.
- Frillingos S., Ujwal M.L., Sun J., and Kaback H.R. 1997b. The role of helix VIII in the lactose permease of *Escherichia coli*. I. Cys-scanning mutagenesis. *Protein Sci.* **6**: 431–437.
- Frost E. and Williams J. 1978. Mapping temperature-sensitive and host-range mutations of adenovirus type 5 by marker rescue. *Virology* **91**: 39–50.
- Ganguly A. and Prockop D.J. 1990. Detection of single-base mutations by reaction of DNA heteroduplexes with a water-soluble carbodiimide followed by primer extension: Application to products from the polymerase chain reaction. *Nucleic Acids Res.* **18**: 3933–3939.
- Ganguly A., Rooney J.E., Hosomi S., Zeiger A.R., and Prockop D.J. 1989. Detection and location of single-base mutations in large DNA fragments by immunomicroscopy. *Genomics* **4**: 530–538.
- Garon C.F., Berry K.W., and Rose J.A. 1975. Arrangement of sequences in the inverted terminal repetition of adenovirus 18 DNA. *Proc. Natl. Acad. Sci.* **72**: 3039–3043.
- Gatlin J., Campbell L.H., Schmidt M.G., and Arrigo S.J. 1995. Direct-rapid (DR) mutagenesis of large plasmids using PCR. *BioTechniques* **19**: 559–564.
- Geier G.E. and Modrich P. 1979. Recognition sequence of the *dam* methylase of *Escherichia coli* K12 and mode of cleavage of *Dpn I* endonuclease. *J. Biol. Chem.* **254**: 1408–1413.
- Geisselsoder J., Witney E., and Yuckenberg P. 1987. Efficient site-directed mutagenesis. *BioTechniques* **5**: 786–791.
- Gibbs C.S. and Zoller M.J. 1991. Rational scanning mutagenesis of a protein kinase identifies functional regions involved in catalysis and substrate interactions. *J. Biol. Chem.* **266**: 8923–8931.
- Gibbs R.A. and Caskey C.T. 1987. Identification and localization of mutations at the Lesch-Nyhan locus by ribonuclease A cleavage. *Science* **236**: 303–305.
- Gibbs R.A., Nguyen P.-N., and Caskey T. 1989. Detection of single DNA base differences by competitive priming. *Nucleic Acids Res.* **17**: 2437–2448.
- Giebel L.B. and Spritz R.A. 1990. Site-directed mutagenesis using a double-stranded DNA fragment as a PCR primer. *Nucleic*

- Acids Res.* **18**: 4947.
- Gillam S. and Smith M. 1979a. Site-specific mutagenesis using synthetic oligodeoxyribonucleotide primers. I. Optimum conditions and minimum oligodeoxyribonucleotide length. *Gene* **8**: 81-97.
- . 1979b. Site-specific mutagenesis using synthetic oligodeoxyribonucleotide primers. II. In vitro selection of mutant DNA. *Gene* **8**: 99-106.
- Glavac D. and Dean M. 1993. Optimization of the single-strand conformation polymorphism (SSCP) technique for detection of point mutations. *Hum. Mutat.* **2**: 404-414.
- Glisic S. and Alavantic D. 1996. A simple PCR method for detection of defined point mutations. *Trends Genet.* **12**: 391-392.
- Goldrick M.M., Kimball G.R., Liu Q., Martin L.A., Sommer S.S., and Tseng J.Y.-H. 1996. NIRCA: A rapid robust method for screening for unknown point mutations. *BioTechniques* **21**: 106-112.
- Gray Jr., H.B. and Lu T. 1993. The BAL 31 nucleases (EC 3.1.11). *Methods Mol. Biol.* **16**: 231-252.
- Greenfield L., Simpson L., and Kaplan D. 1975. Conversion of closed circular DNA molecules to single-nicked molecules by digestion with DNAase I in the presence of ethidium bromide. *Biochim. Biophys. Acta* **407**: 365-375.
- Groppe M. 1993. The rapid detection of unknown mutations in nucleic acids. *Nat. Genet.* **5**: 111-117.
- Guo L.H. and Wu R. 1982. New rapid methods for DNA sequencing based in exonuclease III digestion followed by repair synthesis. *Nucleic Acids Res.* **10**: 2065-2084.
- . 1983. Exonuclease III: Use for DNA sequence analysis and in specific deletions of nucleotides. *Methods Enzymol.* **100**: 60-96.
- Gustin K.E. and Burk R.D. 1993. A rapid method for generating linker scanning mutants utilizing PCR. *BioTechniques* **14**: 22-24.
- Hagemeyer C. 1996. Site-directed mutagenesis using a uracil-containing phagemid template. *Methods Mol. Biol.* **57**: 45-54.
- Hale W.B., van der Woude M.W., and Low D.A. 1994. Analysis of nonmethylated GATC sites in the *Escherichia coli* chromosome and identification of sites that are differentially methylated in response to environmental stimuli. *J. Bacteriol.* **176**: 3438-41.
- Haltiner M., Kempe T., and Tjian R. 1985. A novel strategy for constructing clustered point mutations. *Nucleic Acids Res.* **13**: 1015-1025.
- Harlow P.P., Hobson G.M., and Benfield P.A. 1994. Construction of linker-scanning mutations using the polymerase chain reaction. *Methods Mol. Biol.* **31**: 87-96.
- . 1996. Construction of linker-scanning mutations using PCR. *Methods Mol. Biol.* **57**: 287-295.
- Hashimoto-Gotoh T., Mizuno T., Ogasahara Y., and Nakagawa M. 1995. An oligodeoxyribonucleotide-directed dual amber method for site-directed mutagenesis. *Gene* **152**: 271-275.
- Hattman S., van Ormondt H., and de Waard A. 1978. Sequence specificity of the wild-type (*dam*<sup>+</sup>) and mutant (*dam*<sup>b</sup>) forms of bacteriophage T2 DNA adenine methylase. *J. Mol. Biol.* **119**: 361-376.
- Hauser C.R. and Gray Jr., H.B. 1990. Precursor-product relationship of larger to smaller molecular forms of the BAL 31 nuclease from *Alteromonas espejiana*: Preferential removal of duplex exonuclease relative to endonuclease activity by proteolysis. *Arch. Biochem. Biophys.* **276**: 451-459.
- . 1991. Vectors containing infrequently cleaved restriction sites for use in BAL 31 nuclease-assisted and end-label-mediated analysis of cloned DNA fragments. *Genet. Anal. Tech. Appl.* **8**: 139-147.
- Hayashi K. 1991. PCR-SSCP: A simple and sensitive method for detection of mutations in the genomic DNA. *PCR Methods Appl.* **1**: 34-38.
- Hayashi K. and Yandell D.W. 1993. How sensitive is PCR-SSCP? *Hum. Mutat.* **2**: 338-346.
- He M.M., Sun J., and Kaback H.R. 1996. Cysteine-scanning mutagenesis of transmembrane domain XII and the flanking periplasmic loop in the lactose permease of *Escherichia coli*. *Biochemistry* **35**: 12909-12914.
- Hébert C.A., Vitangcol R.V., and Baker J.B. 1991. Scanning mutagenesis of interleukin-8 identifies a cluster of residues required for receptor binding. *J. Biol. Chem.* **266**: 18989-18994.
- Hemsley A., Arnheim N., Toney M.D., Cortopassi G., and Galas D.J. 1989. A simple method for site-directed mutagenesis using the polymerase chain reaction. *Nucleic Acids Res.* **17**: 6545-6551.
- Henikoff S. 1984. Unidirectional digestion with exonuclease III creates targeted breakpoints for DNA sequencing. *Gene* **28**: 351-359.
- . 1987. Unidirectional digestion with exonuclease III in DNA sequence analysis. *Methods Enzymol.* **155**: 156-165.
- . 1990. Ordered deletions for DNA sequencing and *in vitro* mutagenesis by polymerase extension and exonuclease III gapping of circular templates. *Nucleic Acids Res.* **18**: 2961-2966.
- Hermes J.D., Parekh S.M., Blacklow S.C., Koster H., and Knowles J.R. 1989. A reliable method for random mutagenesis: The generation of mutant libraries using spiked oligodeoxyribonucleotide primers. *Gene* **84**: 143-151.
- Hidajat R. and McNicol P. 1997. Primer-directed mutagenesis of an intact plasmid by using *Pwo* DNA polymerase in long distance inverse PCR. *BioTechniques* **22**: 32-34.
- Highsmith W.E.J., Nataraj A.J., Jin Q., O'Connor J.M., El-Nabi S.H., Kusukawa N., and Garner M.M. 1999. Use of DNA toolbox for the characterization of mutation scanning methods. II. Evaluation of single-strand conformation polymorphism analysis. *Electrophoresis* **20**: 1195-1203.
- Higuchi R., Krummel B., and Saiki R.K. 1988. A general method of *in vitro* preparation and specific mutagenesis of DNA fragments: Study of protein and DNA interactions. *Nucleic Acids Res.* **16**: 7351-7367.
- Ho S.N., Hunt H.D., Horton R.M., Pullen J.K., and Pease L.R. 1989. Site-directed mutagenesis by overlap extension using the polymerase chain reaction. *Gene* **77**: 51-59.
- Hobson G.M., Harlow P.P., and Benfield P.A. 1996. Construction of linker-scanning mutations by oligonucleotide ligation. *Methods Mol. Biol.* **57**: 279-285.
- Hochhauser S.J. and Weiss B. 1978. *Escherichia coli* mutants deficient in deoxyuridine triphosphatase. *J. Bacteriol.* **134**: 157-166.
- Hofer B. and Kühlein B. 1993. Site-specific mutagenesis in plasmids: A gapped circle method. *Methods Enzymol.* **217**: 173-189.
- Hoheisel J.D. 1989. Ultrafast microprep protocol for large-number preparations of recombinant plasmids and cosmids. *Technique* **1**: 21-27.
- . 1993. On the activities of *Escherichia coli* exonuclease III. *Anal. Biochem.* **209**: 238-246.
- Hoheisel J.D. and Pohl F.M. 1986. Simplified preparation of unidirectional deletion clones. *Nucleic Acids Res.* **14**: 3605.

1987. Searching for potential Z-DNA in genomic *Escherichia coli* DNA. *J. Mol. Biol.* **193**: 447–464.
- Hovig E., Smith-Sorensen B., Broger A., and Borreson A.-L. 1991. Constant denaturant gel electrophoresis: A modification of denaturing gel electrophoresis in mutation detection. *Mutat. Res.* **262**: 63–71.
- Hsu I.C., Yang Q.P., Kahng M., and Xu J.-F. 1994. Detection of point mutations with DNA mismatch repair enzymes. *Carcinogenesis* **15**: 1657–1662.
- Hughes M.J. and Andrews D.W. 1996. Creation of deletion, insertion and substitution mutations using a single pair of primers and PCR. *BioTechniques* **20**: 188–196.
- Humbert J.-F. and Elard L. 1997. A simple PCR method for rapidly detecting defined point mutations. *Elsevier Trends Journals Technical Tips Online* (#40776).
- Hutchinson M.J. and Allen J.M. 1997. Improved efficiency of two-primer mutagenesis. *Elsevier Trends Journals Technical Tips Online* (#40072).
- Hutchison III, C.A. and Edgell M.H. 1971. Genetic assay for small fragments of bacteriophage phi X174 deoxyribonucleic acid. *J. Virol.* **8**: 181–189.
- Hutchison III, C.A., Phillips S., Edgell M.H., Gillam S., Jahnke P., and Smith M. 1978. Mutagenesis at a specific position in a DNA sequence. *J. Biol. Chem.* **253**: 6551–6560.
- Jaeckel S., Epplen J.T., Kauth M., Mitterski B., Tschentscher F., and Epplen C. 1998. Polymerase chain reaction-single strand conformation polymorphism or how to detect reliably and efficiently each sequence variation in many samples and many genes. *Electrophoresis* **19**: 3055–3061.
- James C.D. and Leffak I.M. 1984. Replacement synthesis labeling of DNA molecules in vitro using the *Escherichia coli* exonuclease III/DNA polymerase I enzyme pair. *Anal. Biochem.* **141**: 33–37.
- Jasin M., Regan L., and Schimmel P. 1983. Modular arrangement of functional domains along the sequence of an aminoacyl tRNA synthetase. *Nature* **306**: 441–447.
- Jin L., Fendly B.M., and Wells J.A. 1992. High resolution functional analysis of antibody-antigen interactions. *J. Mol. Biol.* **226**: 851–865.
- Jung R., Scott M.P., Oliveira L.O., and Nielsen N.C. 1992. A simple and efficient method for the oligodeoxyribonucleotide-directed mutagenesis of double-stranded plasmid DNA. *Gene* **121**: 17–24.
- Kadonaga J.T. and Knowles J.R. 1985. A simple and efficient method for chemical mutagenesis of DNA. *Nucleic Acids Res.* **13**: 1733–1745.
- Kadowaki H., Kadowaki T., Wondisford F.E., and Taylor S.I. 1989. Use of polymerase chain reaction catalyzed by Taq DNA polymerase for site-specific mutagenesis. *Gene* **76**: 161–166.
- Kammann M., Laufs J., Schell J., and Gronenborn B. 1989. Rapid insertional mutagenesis of DNA by polymerase chain reaction (PCR). *Nucleic Acids Res.* **17**: 5404.
- Ke S.H. and Madison E.L. 1997. Rapid and efficient site-directed mutagenesis by single-tube “megaprimer” PCR method. *Nucleic Acids Res.* **25**: 3371–3372.
- Keller W. and Crouch R. 1972. Degradation of DNA RNA hybrids by ribonuclease H and DNA polymerases of cellular and viral origin. *Proc. Natl. Acad. Sci.* **69**: 3360–3364.
- Kessler C. and Manta V. 1990. Specificity of restriction endonucleases and DNA modification methyltransferases (review, edition 3). *Gene* **92**: 1–248.
- Khorana H.G. 1979. Total synthesis of a gene. *Science* **203**: 614–625.
- Kilpatrick M.W., Wei C.F., Gray Jr., H.B., and Wells R.D. 1983. BAL 31 nuclease as a probe in concentrated salt for the B-Z DNA junction. *Nucleic Acids Res.* **11**: 3811–3822.
- King P. and Goodbourn S. 1992. A method for sequence-specific deletion mutagenesis. *Nucleic Acids Res.* **20**: 1039–1044.
- Konrad E.B. and Lehman I.R. 1975. Novel mutants of *Escherichia coli* that accumulate very small DNA replicative intermediates. *Proc. Natl. Acad. Sci.* **72**: 2150–2154.
- Kow Y.W. 1989. Mechanism of action of *Escherichia coli* exonuclease III. *Biochemistry* **28**: 3280–3287.
- Kuipers O.P. 1996. Random mutagenesis by using mixtures of dNTP and dITP in PCR. *Methods Mol. Biol.* **57**: 351–356.
- Kuipers O.P., Boot H.J., and de Vos W.M. 1991. Improved site-directed mutagenesis method using PCR. *Nucleic Acids Res.* **19**: 4558.
- Kukita Y., Tahira T., Sommer S.S., and Hayashi K. 1997. SSCP analysis of long DNA fragments in low pH gel. *Hum. Mutat.* **10**: 400–407.
- Kunkel T.A. 1985. Rapid and efficient site-specific mutagenesis without phenotypic selection. *Proc. Natl. Acad. Sci.* **82**: 488–492.
- Kunkel T.A., Bebenek K., and McClary J. 1991. Efficient site-directed mutagenesis using uracil-containing DNA. *Methods Enzymol.* **204**: 125–139.
- Kunkel T.A., Roberts J.D., and Zakour R.A. 1987. Rapid and efficient site-specific mutagenesis without phenotypic selection. *Methods Enzymol.* **154**: 367–382.
- Kürz L.L., Zühlke R.D., Zhang H.J., and Joho R.H. 1995. Side-chain accessibilities in the pore of a K<sup>+</sup> channel probed by sulfhydryl-specific reagents after cysteine-scanning mutagenesis (erratum *Biophys. J.* [1995] **69**: 288). *Biophys. J.* **68**: 900–905.
- Labeit S., Lehrach H., and Goody R.S. 1986. A new method of DNA sequencing using deoxynucleoside alpha-thiotriphosphates. *DNA* **5**: 173–177.
- Lacks S. and Greenberg B. 1975. A deoxyribonuclease of *Diplococcus pneumoniae* specific for methylated DNA. *J. Biol. Chem.* **250**: 4060–4066.
- . 1977. Complementary specificity of restriction endonucleases of *Diplococcus pneumoniae* with respect to DNA methylation. *J. Mol. Biol.* **114**: 153–168.
- Landegren U. 1993. Ligation-based DNA diagnostics. *BioEssays* **15**: 761–765.
- Landt O., Grunert H.P., and Hahn U. 1990. A general method for rapid site-directed mutagenesis using the polymerase chain reaction. *Gene* **96**: 125–128.
- Lau P.P. and Gray Jr., H.B. 1979. Extracellular nucleases of *Alteromonas espejiana* BAL 31. IV. The single strand-specific deoxyriboendonuclease activity as a probe for regions of altered secondary structure in negatively and positively supercoiled closed circular DNA. *Nucleic Acids Res.* **6**: 331–357.
- Lawley P.D. 1967. Reaction of hydroxylamine at high concentration with deoxycytidine or with polycytidylic acid: Evidence that substitution of amino groups in cytosine residues by hydroxylamino is a primary reaction, and the possible relevance to hydroxylamine mutagenesis. *J. Mol. Biol.* **24**: 75–81.
- Legerski R.J., Gray Jr., H.B., and Robberson D.L. 1977. A sensitive endonuclease probe for lesions in deoxyribonucleic acid helix structure produced by carcinogenic or mutagenic agents. *J. Biol. Chem.* **252**: 8740–8746.
- Legerski R.J., Hodnett J.L., and Gray Jr., H.B. 1978. Extracellular nucleases of *Pseudomonas* BAL 31. III. Use of the double-



- strand deoxyriboexonuclease activity as the basis of a convenient method for the mapping of fragments of DNA produced by cleavage with restriction enzymes. *Nucleic Acids Res.* **5**: 1445–1464.
- Lehtovaara P.M., Koivula A.K., Bamford J., and Knowles J.K. 1988. A new method for random mutagenesis of complete genes: Enzymatic generation of mutant libraries *in vitro*. *Protein Eng.* **2**: 63–68.
- Letsinger R.L. and Lunsford W.B. 1976. Synthesis of thymidine oligonucleotides by phosphite triester intermediates. *J. Am. Chem. Soc.* **98**: 3655–3661.
- Leung D.W., Chen E., and Goeddel D.V. 1989. A method for random mutagenesis of a defined DNA segment using a modified polymerase chain reaction. *Technique* **1**: 11–15.
- Lewis M.K. and Thompson D.V. 1990. Efficient site directed *in vitro* mutagenesis using ampicillin selection. *Nucleic Acids Res.* **18**: 3439–3443.
- Li C. and Tucker P.W. 1993. Exo-sequencing DNA. *Nucleic Acids Res.* **21**: 1239–1244.
- Li S. and Wilkinson M.F. 1997. Site-directed mutagenesis: A two-step method using PCR and DpnI. *BioTechniques* **23**: 588–590.
- Li X.M. and Shapiro L.J. 1993. Three-step PCR mutagenesis for "linker scanning." *Nucleic Acids Res.* **21**: 3745–3748.
- Lim W.A. and Sauer R.T. 1989. Alternative packing arrangements in the hydrophobic core of lambda repressor. *Nature* **339**: 31–36.
- Lindahl T. 1974. An N-glycosidase from *Escherichia coli* that releases free uracil from DNA containing deaminated cytosine residues. *Proc. Natl. Acad. Sci.* **71**: 3649–3653.
- . 1982. DNA repair enzymes. *Annu. Rev. Biochem.* **51**: 61–87.
- Ling M.M. and Robinson B.H. 1997. Approaches to DNA mutagenesis: An overview. *Anal. Biochem.* **254**: 157–178.
- Liu J.S., Roesler W.J., and Hanson R.W. 1990. An efficient method for introducing block mutations into specific regions of a gene. *BioTechniques* **9**: 738–742.
- Liu Q. and Sommer S.S. 1994. Parameters affecting the sensitivities of dideoxy fingerprinting and SSCP. *PCR Methods Appl.* **4**: 97–108.
- . 1995. Restriction endonuclease fingerprinting (REF): A sensitive method for screening mutations in long, contiguous segments of DNA. *BioTechniques* **18**: 470–477.
- . 1998. The SSCP phenomenon: Addition of HEPES buffer dramatically affects electrophoretic mobility. *BioTechniques* **25**: 50–56.
- Liu Q., Feng J., and Sommer S.S. 1997. In a blinded analysis, restriction endonuclease fingerprinting (REF) detects all the mutations in a 1.9-kb segment. *BioTechniques* **23**: 836–839.
- Liu Q., Feng J., Buzin C., Wen C., Nozari G., Mengos A., Nguyen V., Liu J., Crawford L., Fujimura F.K., and Sommer S.S. 1999. Detection of virtually all mutations-SSCP (DOVAM-S): A rapid method for mutation scanning with virtually 100% sensitivity. *BioTechniques* **26**: 932–942.
- Lloyd R.S. and Linn S. 1993. Nucleases involved in DNA repair. In *Nucleases*, 2nd edition (ed. S.M. Linn et al.), pp. 263–316. Cold Spring Harbor Laboratory Press, Cold Spring Harbor, New York.
- Lu A. and Hsu I.C. 1992. Detection of single DNA base mutations with mismatch repair enzymes. *Genomics* **14**: 249–255.
- Lu A.L., Clark S., and Modrich P. 1983. Methyl-directed repair of DNA base-pair mismatches *in vitro*. *Proc. Natl. Acad. Sci.* **80**: 4639–4643.
- Luckow B. and Schütz G. 1991. Linker scanning mutagenesis. In *Directed mutagenesis: A practical approach* (ed. M.J. McPherson), pp. 101–133. IRL Press, Oxford, United Kingdom.
- Luckow B., Renkawitz R., and Schütz G. 1987. A new method for constructing linker scanning mutants. *Nucleic Acids Res.* **15**: 417–429.
- Lundberg L.G., Thoresson H.O., Karlstrom O.H., and Nyman P.O. 1983. Nucleotide sequence of the structural gene for dUTPase of *Escherichia coli* K-12. *EMBO J.* **2**: 967–971.
- Marini III, F., Naem A., and Lapeyre J.-N. 1993. An efficient 1-tube PCR method for internal site-directed mutagenesis of large amplified molecules. *Nucleic Acids Res.* **21**: 2277–2278.
- Marinus M.G. 1973. Location of DNA methylation genes on the *Escherichia coli* K-12 genetic map. *Mol. Gen. Genet.* **127**: 47–55.
- . 1987. Methylation of DNA. In *Escherichia coli and Salmonella typhimurium: Cellular and molecular biology* (ed. F.C. Neidhardt et al.), vol. 1, pp. 697–702. American Society for Microbiology, Washington D.C.
- Marinus M.G., Carraway M., Frey A.Z., Brown L., and Arraj J.A. 1983. Insertion mutations in the *dam* gene of *Escherichia coli* K-12. *Mol. Gen. Genet.* **192**: 288–289.
- Markoff A., Savov A., Vladimirov V., Bogdanova N., Kremensky I., and Ganey V. 1997. Optimization of single-strand conformation polymorphism analysis in the presence of polyethylene glycol (erratum *Clin. Chem.* [1997] **43**: 692]. *Clin. Chem.* **43**: 30–33.
- Markvardsen P., Lassen S.F., Borchert V., and Clausen I.G. 1995. Uracil-USE, an improved method for site-directed mutagenesis on double-stranded plasmid DNA. *BioTechniques* **18**: 370–372.
- Marshall R.D., Koontz J., and Sklar J. 1995. Detection of mutations by cleavage of DNA heteroduplexes with bacteriophage resolvases. *Nat. Genet.* **9**: 177–183.
- Martin F.H., Castro M.M., Aboul-ela F., and Tinoco Jr., I. 1985. Base pairing involving deoxyinosine: Implications for probe design. *Nucleic Acids Res.* **13**: 8927–8938.
- Masamune Y., Fleischman R.A., and Richardson C.C. 1971. Enzymatic removal and replacement of nucleotides at single strand breaks in deoxyribonucleic acid. *J. Biol. Chem.* **246**: 2680–2691.
- Maxam A.M. and Gilbert W. 1977. A new method for sequencing DNA. *Proc. Natl. Acad. Sci.* **74**: 560–564.
- . 1980. Sequencing end-labeled DNA with base-specific chemical cleavages. *Methods Enzymol.* **65**: 499–560.
- McClary J.A., Witney F., and Geisselsoder J. 1989. Efficient site-directed *in vitro* mutagenesis using phagemid vectors. *BioTechniques* **7**: 282–289.
- McClelland M. and Nelson M. 1988. The effect of site-specific DNA methylation on restriction endonucleases and DNA modification methyltransferases — A review. *Gene* **74**: 291–304.
- McKnight S.L. and Kingsbury R. 1982. Transcriptional control signals of a eukaryotic protein-coding gene. *Science* **217**: 316–324.
- Modrich P. 1989. Methyl-directed DNA mismatch correction. *J. Biol. Chem.* **264**: 6597–6600.
- Molinari R.J., Conners M., and Shorr R.G.L. 1993. Hydrolink gels for electrophoresis. *Adv. Electrophor.* **6**: 44–60.
- Müller W., Weber H., Meyer F., and Weissmann C. 1978. Site-directed mutagenesis in DNA: Generation of point mutations in cloned beta globin complementary dna at the posi-

- tions corresponding to amino acids 121 to 123. *J. Mol. Biol.* **124**: 343–358.
- Murthy K.K., Shen S.-H., and Banville D. 1995. A sensitive method for detection of mutations — A PCR-based RNase protection assay. *DNA Cell Biol.* **14**: 87–94.
- Myers R.M., Larin Z., and Maniatis T. 1985a. Detection of single-base substitutions by ribonuclease cleavage at mismatches in RNA:DNA duplexes. *Science* **230**: 1242–1246.
- Myers R.M., Lerman L.S., and Maniatis T. 1985b. A general method for saturation mutagenesis of cloned DNA fragments. *Science* **229**: 242–247.
- Myers R.M., Maniatis T., and Lerman L.S. 1987. Detection and localization of single base changes by denaturing gradient gel electrophoresis. *Methods Enzymol.* **155**: 501–527.
- Myers R.M., Sheffield V.C., and Cox D.R. 1988. Detection of single base changes in DNA: Ribonuclease cleavage and denaturing gradient gel electrophoresis. In *Genome analysis: A practical approach* (ed. K. Davies), pp. 95–139. IRL Press, Oxford, United Kingdom.
- Myers R.M., Fischer S.G., Lerman L.S., and Maniatis T. 1985c. Nearly all single base substitutions in DNA fragments joined to a GC-clamp can be detected by denaturing gradient gel electrophoresis. *Nucleic Acids Res.* **13**: 3131–3145.
- Nakamaye K.L. and Eckstein F. 1986. Inhibition of restriction endonuclease Nci I cleavage by phosphorothioate groups and its application to oligonucleotide-directed mutagenesis. *Nucleic Acids Res.* **14**: 9679–9698.
- Nataraj A.J., Olivos-Glander I., Kusukawa N., and Highsmith W.E.J. 1999. Single-strand conformation polymorphism and heteroduplex analysis for gel-based mutation detection. *Electrophoresis* **20**: 1177–1185.
- Newton C.R., Graham A., Heptinstall L.E., Powell S.J., Summers C., Kalsheker N., Smith J.C., and Markham A.F. 1989. Analysis of any point mutation in DNA. The amplification refractory mutation system (ARMS). *Nucleic Acids Res.* **17**: 2503–2516.
- Norris K., Norris E., Christiansen L., and Fiil N. 1983. Efficient site-directed mutagenesis by simultaneous use of two primers. *Nucleic Acids Res.* **11**: 5103–5112.
- Nossal N.G. 1974. DNA synthesis on a double-stranded DNA template by the T4 bacteriophage DNA polymerase and the T4 gene 32 DNA unwinding protein. *J. Biol. Chem.* **249**: 5668–5676.
- Novack D.F., Casna N.J., Fischer S.G., and Ford J.P. 1986. Detection of single-base-pair mismatches in DNA by chemical modification followed by electrophoresis in 15% polyacrylamide gel. *Proc. Natl. Acad. Sci.* **83**: 586–590.
- Ogretman B., Carpo C., and Safa A.R. 1996. Site-directed mutagenesis by unique site elimination using filamentous phage-derived ssDNA templates for plasmids that are resistant to denaturation. *BioTechniques* **20**: 209–213.
- Olsen D.B. and Eckstein F. 1990. High-efficiency oligonucleotide-directed plasmid mutagenesis. *Proc. Natl. Acad. Sci.* **87**: 1451–1455.
1991. Phosphorothioate-based double stranded plasmid mutagenesis. In *Directed mutagenesis: A practical approach* (ed. M.J. McPherson), pp. 83–99. IRL Press, Oxford, United Kingdom.
- Olsen L.C., Aasland R., Krokan H.E., and Helland D.E. 1991. Human uracil-DNA glycosylase complements *E. coli ung* mutants. *Nucleic Acids Res.* **19**: 4473–4478.
- Orita M., Sekiya T., and Hayashi K. 1990. DNA sequence polymorphisms in Alu repeats. *Genomics* **8**: 271–278.
- Orita M., Suzuki Y., Sekiya T., and Hayashi K. 1989a. Rapid and sensitive detection of point mutations and DNA polymorphisms using the polymerase chain reaction. *Genomics* **5**: 874–879.
- Orita M., Iwahana H., Kanazawa H., Hayashi K., and Sekiya T. 1989b. Detection of polymorphisms of human DNA by gel electrophoresis as single-strand conformation polymorphisms. *Proc. Natl. Acad. Sci.* **86**: 2766–2770.
- Palmer B.R. and Marinus M.G. 1994. The *dam* and *dcm* strains of *Escherichia coli* — A review. *Gene* **143**: 1–12.
- Parikh A. and Guengerich F.P. 1998. Random mutagenesis by whole-plasmid PCR amplification. *BioTechniques* **24**: 428–431.
- Parker B. and Marinus M.G. 1988. A simple and rapid method to obtain substitution mutations in *Escherichia coli*: Isolation of a *dam* deletion/insertion mutation. *Gene* **73**: 531–535.
- Parker B.A. and Stark G.R. 1979. Regulation of simian virus 40 transcription: Sensitive analysis of the RNA species present early in infections by virus or viral DNA. *J. Virol.* **31**: 360–369.
- Peden K.W. and Nathans D. 1982. Local mutagenesis within deletion loops of DNA heteroduplexes. *Proc. Natl. Acad. Sci.* **79**: 7214–7217.
- Peters J. and Baumeister W. 1986. Molecular cloning, expression, and characterization of the gene for the surface (HPI)-layer protein of *Deinococcus radiodurans* in *Escherichia coli*. *J. Bacteriol.* **167**: 1048–1054.
- Picard V., Ersdal-Badju E., Lu A., and Bock S.C. 1994. A rapid and efficient one-tube PCR-based mutagenesis technique using Pfu DNA polymerase. *Nucleic Acids Res.* **22**: 2587–2591.
- Piechocki M.P. and Hines R.N. 1994. Oligonucleotide design and optimized protocol for site-directed mutagenesis. *BioTechniques* **16**: 702–707.
- Pine R. and Huang P.C. 1987. An improved method to obtain a large number of mutants in a defined region of DNA. *Methods Enzymol.* **154**: 415–430.
- Pisa-Williamson D. and Fuller C.W. 1992. Glycerol tolerant DNA sequencing gels. *Comments (U.S. Biochemical Corp.)* **19**: 29–36.
- Ponce M.R. and Micol J.L. 1992. PCR amplification of long DNA fragments. *Nucleic Acids Res.* **20**: 623.
- Poncz M., Solowiejczyk D., Ballantine M., Schwartz E., and Surrey S. 1982. “Nonrandom” DNA sequence analysis in bacteriophage M13 by the dideoxy chain-termination method. *Proc. Natl. Acad. Sci.* **79**: 4298–4302.
- Postina R. and Fahrenholz F. 1995. Total *in vitro* synthesis of plasmid DNA facilitates site-directed mutagenesis. *Anal. Biochem.* **232**: 254–258.
- Pourzand C. and Cerutti P. 1993. Genotypic mutation analysis by RFLP/PCR. *Mutat. Res.* **288**: 113–121.
- Powell S.M., Petersen G.M., Krush A.J., Booker S., Jen J., Giardello F.M., Hamilton S.R., Vogelstein B., and Kinzler K.W. 1993. Molecular diagnosis of familial adenomatous polyposis. *N. Engl. J. Med.* **329**: 1982–1987.
- Prosser J. 1993. Detecting single-base mutations. *Trends Biotechnol.* **11**: 238–246.
- Prosser J., Condie A., Wright M., Horn J.M., Fantes J.A., Wyllie A.H., and Dunlop M.G. 1994. APC mutation analysis by chemical cleavage of mismatch and a protein truncation assay in familial adenomatous polyposis. *Br. J. Cancer* **70**: 841–846.
- Pukkila P.J., Peterson J., Herman G., Modrich P., and Meselson M. 1983. Effects of high levels of DNA adenine methylation on

- methyl-directed mismatch repair in *Escherichia coli*. *Genetics* **104**: 571–582.
- Putney S.D., Benkovic S.J., and Schimmel P.R. 1981. A DNA fragment with an alpha-phosphorothioate nucleotide at one end is asymmetrically blocked from digestion by exonuclease III and can be replicated *in vivo*. *Proc. Natl. Acad. Sci.* **78**: 7350–7354.
- Rao R.N. and Rogers S.G. 1978. A thermoinducible lambda phage-ColE1 plasmid chimera for the overproduction of gene products from cloned DNA segments. *Gene* **3**: 247–263.
- Ravnik-Glavac M., Glavac D., and Dean M. 1994. Sensitivity of single-strand conformation polymorphism and heteroduplex method for mutation detection in the cystic fibrosis gene. *Hum. Mol. Genet.* **3**: 801–807.
- Razin A., Hirose T., Itakura K., and Riggs A.D. 1978. Efficient correction of a mutation by use of chemically synthesized DNA. *Proc. Natl. Acad. Sci.* **75**: 4268–4270.
- Reidhaar-Olson J.F. and Sauer R.T. 1988. Combinatorial cassette mutagenesis as a probe of the informational content of protein sequences. *Science* **241**: 53–57.
- Reidhaar-Olson J.F., Bowie J.U., Breyer R.M., Hu J.C., Knight K.L., Lim W.A., Mossing M.C., Parsell D.A., Shoemaker K.R., and Sauer R.T. 1991. Random mutagenesis of protein sequences using oligonucleotide cassettes. *Methods Enzymol.* **208**: 564–586.
- Richardson C.C. and Kornberg A. 1964. A deoxyribonucleic acid phosphatase-exonuclease from *Escherichia coli*. I. Purification of the enzyme and characterization of the phosphatase activity. *J. Biol. Chem.* **239**: 242–250.
- Richardson C.C., Lehmann I.R., and Kornberg A. 1964. A deoxyribonucleic acid phosphatase-exonuclease from *Escherichia coli*. II. Characterization of the exonuclease activity. *J. Biol. Chem.* **239**: 251–258.
- Richardson J.S. and Richardson D.C. 1989. Principles and patterns of protein conformation. In *Prediction of protein structure and the principles of protein conformation* (ed. G.D. Fasman), pp. 1–98. Plenum Press, New York.
- Riesner D., Steger G., Zimmat R., Owens R.A., Wagenhofer M., Hillen W., Vollbach S., and Henco K. 1989. Temperature-gradient gel electrophoresis of nucleic acids: Analysis of conformational transitions, sequence variations, and protein-nucleic acid interactions. *Electrophoresis* **10**: 377–389.
- Riley D. and Weintraub H. 1978. Nucleosomal DNA is digested to repeats of 10 bases by exonuclease III. *Cell* **13**: 281–293.
- Ringquist S. and Smith C.L. 1992. The *Escherichia coli* chromosome contains specific, unmethylated *dam* and *dcm* sites. *Proc. Natl. Acad. Sci.* **89**: 4539–4543.
- Roberts T.M., Swanberg S.L., Poteete A., Riedel G., and Backman K. 1980. A plasmid cloning vehicle allowing a positive selection for inserted fragments. *Gene* **12**: 123–127.
- Roest P.A.M., Roberts R.G., Sugino S., van Ommen G.-J.B., and den Dunnen J.T. 1993. Protein truncation test (PTT) for rapid detection of translation-terminating mutations. *Hum. Mol. Genet.* **2**: 1719–1721.
- Rogers S.G. and Weiss B. 1980. Cloning of the exonuclease III gene of *Escherichia coli*. *Gene* **11**: 187–195.
- Rojas J.M., Dopazo J., Santana M., Lopez-Galindez C., and Tabares E. 1995. Comparative study of the genetic variability in thymidine kinase and glycoprotein B genes of herpes simplex viruses by the RNase A mismatch cleavage method. *Virus Res.* **35**: 205–214.
- Rosenbaum V. and Riesner D. 1987. Temperature-gradient gel electrophoresis. Thermodynamic analysis of nucleic acids and proteins in purified form and in cellular extracts. *Biophys. Chem.* **26**: 235–246.
- Rossiter B.J.F. and Caskey C.T. 1990. Molecular scanning methods of mutation detection. *J. Biol. Chem.* **265**: 12753–12756.
- Sagher D. and Strauss B. 1983. Insertion of nucleotides opposite apurinic/apyrimidinic sites in deoxyribonucleic acid during *in vitro* synthesis: Uniqueness of adenine nucleotides. *Biochemistry* **22**: 4518–4526.
- Saiki R.K., Bugawan T.L., Horn G.T., Mullis K.B., and Erlich H.A. 1986. Analysis of enzymatically amplified  $\beta$ -globin and HLA-DQ  $\alpha$  DNA with allele-specific oligonucleotide probes. *Nature* **324**: 163–166.
- Saleeba J.A. and Cotton R.G.H. 1993. Chemical cleavage of mismatch to detect mutations. *Methods Enzymol.* **217**: 286–295.
- Saporito S.M., Smith-White B.J., and Cunningham R.P. 1988. Nucleotide sequence of the *xth* gene of *Escherichia coli* K-12. *J. Bacteriol.* **170**: 4542–4547.
- Sarkar G. and Sommer S.S. 1990. The “megaprimer” method of site-directed mutagenesis. *BioTechniques* **8**: 404–407.
- . 1992. Double-stranded DNA segments can efficiently prime the amplification of human genomic DNA. *Nucleic Acids Res.* **20**: 4937–4938.
- Sarkar G., Yoon H.-S., and Sommer S.S. 1992. Dideoxy fingerprinting (ddF): A rapid and efficient screen for the presence of mutations. *Genomics* **13**: 441–443.
- Sayers J.R. and Eckstein F. 1989. Site-directed mutagenesis, based on the phosphorothioate approach. In *Protein function: A practical approach* (ed. T.E. Creighton), pp. 279–295. IRL Press, Oxford, United Kingdom.
- . 1991. Phosphorothioate-based site-directed mutagenesis for single-stranded vectors. In *Directed mutagenesis: A practical approach* (ed. M.J. McPherson), pp. 49–69. IRL Press, Oxford, United Kingdom.
- Sayers J.R., Krekel C., and Eckstein F. 1992. Rapid high-efficiency site-directed mutagenesis by the phosphorothioate approach. *BioTechniques* **13**: 592–596.
- Sayers J.R., Schmidt W., and Eckstein F. 1988a. 5'-3' Exonucleases in phosphorothioate-based oligonucleotide-directed mutagenesis. *Nucleic Acids Res.* **16**: 791–802.
- Sayers J.R., Schmidt W., Wendler A., and Eckstein F. 1988b. Strand specific cleavage of phosphorothioate-containing DNA by reaction with restriction endonucleases in the presence of ethidium bromide. *Nucleic Acids Res.* **16**: 803–814.
- Schanke J.T. 1997. Linker scanning mutagenesis by three-step PCR. *Methods Mol. Biol.* **67**: 197–202.
- Schena M. 1989. High efficiency oligonucleotide-directed mutagenesis using Sequenase. *Comments (U.S. Biochemical Corp.)* **15**: 23.
- Schold M., Colombero A., Reyes A.A., and Wallace R.B. 1984. Oligonucleotide-directed mutagenesis using plasmid DNA templates and two primers. *DNA* **3**: 469–477.
- Schuster H. 1960. The reaction of nitrous acid with deoxyribonucleic acid. *Biochem. Biophys. Res. Commun.* **2**: 320–323.
- Scott J.K. and Smith G.P. 1990. Searching for peptide ligands with an epitope library. *Science* **249**: 386–390.
- Shapiro R., Braverman B., Louis J.B., and Servgis R.E. 1973. Nucleic acid reactivity and conformation. II. Reaction of cytosine and uracil with sodium bisulfite. *J. Biol. Chem.* **248**: 4060–4064.
- Sheffield V.C., Cox D.R., Lerman L.S., and Myers R.M. 1989. Attachment of a 40-bp G + C rich sequence (GC-clamp) to genomic DNA fragments by the polymerase chain reaction results in improved detection of single-base changes. *Proc.*

- Natl. Acad. Sci.* **86**: 232–236.
- Sheffield V.C., Beck J.S., Kwitek A.E., Sandstrom D.W., and Stone E.M. 1993. The sensitivity of single-strand conformation polymorphism analysis for the detection of single base substitutions. *Genomics* **16**: 325–332.
- Shlomag J. and Kornberg A. 1978. Deoxyuridine triphosphatase of *Escherichia coli*. Purification, properties, and use as a reagent to reduce uracil incorporation into DNA. *J. Biol. Chem.* **253**: 3305–3312.
- Shortle D. and Botstein D. 1983. Directed mutagenesis with sodium bisulfite. *Methods Enzymol.* **100**: 457–468.
- Shortle D. and Lin B. 1985. Genetic analysis of staphylococcal nuclease: Identification of three intragenic “global” suppressors of nuclease-minus mutations. *Genetics* **110**: 539–555.
- Shortle D. and Nathans D. 1978. Local mutagenesis: A method for generating viral mutants with base substitutions in preselected regions of the viral genome. *Proc. Natl. Acad. Sci.* **75**: 2170–2174.
- Shortle D., Grisafi P., Benkovic S.J., and Botstein D. 1982. Gap misrepair mutagenesis: Efficient site-directed induction of transition, transversion, and frameshift mutations in vitro. *Proc. Natl. Acad. Sci.* **79**: 1588–1592.
- Smith A.J. 1979. The use of exonuclease III for preparing single stranded DNA for use as a template in the chain terminator sequencing method. *Nucleic Acids Res.* **6**: 831–848.
- Smith M. 1985. In vitro mutagenesis. *Annu. Rev. Genet.* **19**: 423–462.
- Smooker P.M. and Cotton R.G.H. 1993. The use of chemical reagents in the detection of DNA mutations. *Mutat. Res.* **288**: 65–77.
- Sokolov B.P. 1990. Primer extension technique for the detection of single nucleotide in genomic DNA. *Nucleic Acids Res.* **18**: 3671.
- Solnick D. 1981. An adenovirus mutant defective in splicing RNA from early region 1A. *Nature* **291**: 508–510.
- Sommer S.S., Cassady J.D., Sobell J.L., and Bottema C.D.K. 1989. A novel method for detecting point mutations or polymorphisms and its application to population screening for carriers of phenylketonuria. *Mayo Clin. Proc.* **64**: 1361–1372.
- Sorge J.A. and Blinderman L.A. 1989. ExoMeth sequencing of DNA: Eliminating the need for subcloning and oligonucleotide primers. *Proc. Natl. Acad. Sci.* **86**: 9208–9212.
- Spee J.H., de Vos W.M., and Kuipers O.P. 1993. Efficient random mutagenesis method with adjustable mutation frequency by use of PCR and dITP. *Nucleic Acids Res.* **21**: 777–778.
- Stemmer W.P. and Morris S.K. 1992. Enzymatic inverse PCR: A restriction site independent, single-fragment method for high-efficiency, site-directed mutagenesis. *BioTechniques* **13**: 214–220.
- Südhof T.C., van der Westhuyzen D.R., Goldstein J.L., Brown M.S., and Russell D.W. 1987. Three direct repeats and a TATA-like sequence are required for regulated expression of the human low density lipoprotein receptor gene. *J. Biol. Chem.* **262**: 10773–10779.
- Suggs S.V., Wallace R.B., Hirose T., Kawashima E.H., and Itakura K. 1981. Use of synthetic oligonucleotides as hybridization probes: Isolation of cloned cDNA sequences for human beta 2-microglobulin. *Proc. Natl. Acad. Sci.* **78**: 6613–6617.
- Sugimoto M., Esaki N., Tanaka H., and Soda K. 1989. A simple and efficient method for the oligonucleotide-directed mutagenesis using plasmid DNA template and phosphorothioate-modified nucleotide. *Anal. Biochem.* **179**: 309–311.
- Szalay A.A., Grohmann K., and Sinsheimer R.L. 1977. Separation of the complementary strands of DNA fragments on polyacrylamide gels. *Nucleic Acids Res.* **4**: 1569–1578.
- Tabor S. and Richardson C.C. 1987. DNA sequence analysis with a modified bacteriophage T7 DNA polymerase. *Proc. Natl. Acad. Sci.* **84**: 4767–4771.
- Tartof K.D. 1992. Cloning vectors and techniques for exonuclease-hybridization restriction mapping. *Methods Enzymol.* **216**: 574–584.
- Taylor J.W., Ott J., and Eckstein F. 1985. The rapid generation of oligonucleotide-directed mutations at high frequency using phosphorothioate-modified DNA. *Nucleic Acids Res.* **13**: 8765–8785.
- Thigpen A.E. and Russell D.W. 1992. Four-amino acid segment in steroid 5 alpha-reductase 1 confers sensitivity to finasteride, a competitive inhibitor. *J. Biol. Chem.* **267**: 8577–8583.
- Thomas K.R. and Olivera B.M. 1978. Processivity of DNA exonucleases. *J. Biol. Chem.* **253**: 424–429.
- Tomilin N.V. and Aprelikova O.N. 1989. Uracil-DNA glycosylases and DNA uracil repair. *Int. Rev. Cytol.* **114**: 125–179.
- Turchin A. and Lawler Jr., J.F. 1999. The primer generator: A program that facilitates the selection of oligonucleotides for site-directed mutagenesis. *BioTechniques* **26**: 672–676.
- Vallette F., Mege E., Reiss A., and Adesnik M. 1989. Construction of mutant and chimeric genes using the polymerase chain reaction. *Nucleic Acids Res.* **17**: 723–733.
- Vande Woude G.F., Oskarsson M., Enquist L.W., Nomura S., Sullivan M., and Fischinger P.J. 1979. Cloning of integrated Moloney sarcoma proviral DNA sequences in bacteriophage lambda. *Proc. Natl. Acad. Sci.* **76**: 4464–4468.
- Vandeyar M.A., Weiner M.P., Hutton C.J., and Batt C.A. 1988. A simple and rapid method for the selection of oligodeoxynucleotide-directed mutants. *Gene* **65**: 129–133.
- Venkitaraman A.R. 1989. Use of modified T7 DNA polymerase (sequenase version 2.0) for oligonucleotide site-directed mutagenesis. *Nucleic Acids Res.* **17**: 3314.
- Verpy E., Biasotto M., Meo T., and Tosi M. 1994. Efficient detection of point mutations on color-coded strands of target DNA. *Proc. Natl. Acad. Sci.* **91**: 1873–1877.
- Viville S. 1994. Site-directed mutagenesis using a double-stranded DNA template. *Methods Mol. Biol.* **31**: 57–65.
- Vovis G.F. and Lacks S. 1977. Complementary action of restriction enzymes endo R-DpnI and endo R-DpnII on bacteriophage phi DNA. *J. Mol. Biol.* **115**: 525–538.
- Wallace R.B., Johnson M.J., Hirose T., Miyake T., Kawashima E.H., and Itakura K. 1981. The use of synthetic oligonucleotides as hybridization probes. II. Hybridization of oligonucleotides of mixed sequence to rabbit beta-globin DNA. *Nucleic Acids Res.* **9**: 879–894.
- Wallace R.B., Shaffer J., Murphy R.F., Bonner J., Hirose T., and Itakura K. 1979. Hybridization of synthetic oligodeoxynucleotides to phiX174 DNA: The effect of single base pair mismatch. *Nucleic Acids Res.* **6**: 3543–3557.
- Walton C., Booth R.K., and Stockley P.G. 1991. Random chemical mutagenesis and the non-selective isolation of mutated DNA sequences in vitro. In *Directed mutagenesis: A practical approach* (ed. M.J. McPherson), pp. 135–162. IRL Press, Oxford, United Kingdom.
- Wang L.M., Geihl D.K., Choudhury G.G., Minter A., Martinez L., Weber D.K., and Sakaguchi A.Y. 1989. Site-directed deletion mutagenesis using phagemid vectors and genetic selection. *BioTechniques* **7**: 1000–1010.
- Wang M.X. and Church G.M. 1992. A whole genome approach to in vivo DNA-protein interactions in *E. coli*. *Nature* **360**:

- 606-610.
- Wang W. and Malcolm B.A. 1999. Two-stage PCR protocol allowing introduction of multiple mutations, deletions and insertions using QuikChange Site-Directed Mutagenesis. *BioTechniques* **26**: 680-682.
- Watkins B.A., Davis A.E., Cocchi F., and Reitz M.S.J. 1993. A rapid method for site-specific mutagenesis using larger plasmids as templates. *BioTechniques* **15**: 700-704.
- Wei C.F., Alianell G.A., Bencen G.H., and Gray Jr., H.B. 1983. Isolation and comparison of two molecular species of the BAL 31 nuclease from *Alteromonas espejiana* with distinct kinetic properties. *J. Biol. Chem.* **258**: 13506-13512.
- Wei C.F., Legerski R.J., Alianell G.A., Robberson D.L., and Gray Jr., H.B. 1984. A single apurinic site can elicit BAL 31 nuclease-catalyzed cleavage in duplex DNA. *Biochim. Biophys. Acta* **782**: 408-414.
- Weiner M.P. and Costa G.L. 1994. Rapid PCR site-directed mutagenesis. *PCR Methods Appl.* **4**: S131-136.
- Weiner M.P., Costa G.L., Schoettlin W., Cline J., Mathur E., and Bauer J.C. 1994. Site-directed mutagenesis of double-stranded DNA by the polymerase chain reaction. *Gene* **151**: 119-123.
- Weisbeek P.J. and van de Pol J.H. 1970. Biological activity of phi X174 replicative form DNA fragments. *Biochim. Biophys. Acta* **224**: 328-338.
- Weiss B. 1976. Endonuclease II of *Escherichia coli* is exonuclease III. *J. Biol. Chem.* **251**: 1896-1901.
- . 1981. Exodeoxyribonucleases of *Escherichia coli*. In *The enzymes* (ed. P.D. Boyer), vol. 14, pp. 203-231. Academic Press, New York.
- Weiss B., Rogers S.G., and Taylor A.F. 1978. The endonuclease activity of exonuclease III and the repair of uracil-containing DNA in *Escherichia coli*. In *DNA repair mechanisms* (ed. P.C. Hanawalt et al.), pp. 191-194. Academic Press, New York.
- Wells J.A. 1991. Systematic mutational analyses of protein-protein interfaces. *Methods Enzymol.* **202**: 390-411.
- . 1996. Binding in the growth hormone receptor complex. *Proc. Natl. Acad. Sci.* **93**: 1-6.
- Wells J.A., Vasser M., and Powers D.B. 1985. Cassette mutagenesis: An efficient method for generation of multiple mutations at defined sites. *Gene* **34**: 315-323.
- Winter E., Yamamoto F., Almoguera C., and Perucho M. 1985. A method to detect and characterize point mutations in the transcribed genes: Amplification and expression of the mutant c-Ki-ras allele in human tumor cells. *Proc. Natl. Acad. Sci.* **82**: 7575-7579.
- Wong F. and Komaromy M. 1995. Site-directed mutagenesis using thermostable enzymes. *BioTechniques* **18**: 1034-1038.
- Wu D.Y. and Wallace R.B. 1989. The ligation amplification reaction (LAR)(Amplification of specific DNA sequences using sequential rounds of template-dependent ligation. *Genomics* **4**: 560-569.
- Wu R., Ruben G., Siegel B., Jay E., Spielman P., and Tu C.P. 1976. Synchronous digestion of SV40 DNA by exonuclease III. *Biochemistry* **15**: 734-740.
- Yamamoto K.R., Alberts B.M., Benzinger R., Lawhorne L., and Treiber G. 1970. Rapid bacteriophage sedimentation in the presence of polyethylene glycol and its application to large-scale virus purification. *Virology* **40**: 734-744.
- Youil R., Kemper B.W., and Cotton R.G.H. 1995. Screening for mutations by enzyme mismatch cleavage with T4 endonuclease VII. *Proc. Natl. Acad. Sci.* **92**: 87-91.
- Zakour R.A. and Loeb L.A. 1982. Site-specific mutagenesis by error-directed DNA synthesis. *Nature* **295**: 708-710.
- Zhou X.G. and Gray Jr., H.B. 1990. Mechanism of exonuclease action of BAL 31 nuclease. *Biochim. Biophys. Acta* **1049**: 83-91.
- Zhu K.Y. and Clark J.M. 1996. Addition of a competitive primer can dramatically improve the specificity of PCR amplification of specific alleles. *BioTechniques* **21**: 586, 590.
- Zhu L. 1996. In vitro site-directed mutagenesis using the unique restriction site elimination (USE) method. *Methods Mol. Biol.* **57**: 13-29.
- Zhu Y.S., Isaacs S.T., Cimino C.D., and Hearst J.E. 1991. The use of exonuclease III for polymerase chain reaction sterilization. *Nucleic Acids Res.* **19**: 2511.
- Zoller M.J. and Smith M. 1982. Oligonucleotide-directed mutagenesis using M13-derived vectors: An efficient and general procedure for the production of point mutations in any fragment of DNA. *Nucleic Acids Res.* **10**: 6487-6500.
- . 1983. Oligonucleotide-directed mutagenesis of DNA fragments cloned into M13 vectors. *Methods Enzymol.* **100**: 468-500.
- . 1984. Oligonucleotide-directed mutagenesis: A simple method using two oligonucleotide primers and a single-stranded DNA template. *DNA* **3**: 479-488.
- . 1987. Oligonucleotide-directed mutagenesis: A simple method using two oligonucleotide primers and a single-stranded DNA template. *Methods Enzymol.* **154**: 329-350.
- Zon G. and Geiser T.G. 1991. Phosphorothioate oligonucleotides: Chemistry, purification, analysis, scale-up and future directions. *Anti-Cancer Drug Des.* **6**: 539-568.



# Chapter 14

## Screening Expression Libraries

---

### INTRODUCTION

### PROTOCOLS

- |   |  |       |
|---|--|-------|
| 1 | Screening Expression Libraries Constructed in Bacteriophage $\lambda$ Vectors  | 14.4  |
| 2 | Screening Expression Libraries Constructed in Plasmid Vectors  | 14.14 |
| 3 | Removal of Cross-reactive Antibodies from Antiserum: Pseudoscreening   | 14.23 |
|   | • Alternative Protocol: Adsorbing Antibodies with Lysates of Bacteriophage-infected Cells                                  | 14.25 |
| 4 | Removal of Cross-reactive Antibodies from Antiserum: Incubation with <i>E. coli</i> Lysate                                 | 14.26 |
| 5 | Removal of Cross-reactive Antibodies from Antiserum: Affinity Chromatography   | 14.28 |
| 6 | Identifying DNA-binding Proteins in Bacteriophage $\lambda$ Expression Libraries   | 14.31 |
| 7 | Preparation of Lysates Containing Fusion Proteins Encoded by Bacteriophage $\lambda$ Lysogens: Lysis of Bacterial Colonies | 14.37 |
| 8 | Preparation of Lysates Containing Fusion Proteins Encoded by Bacteriophage $\lambda$ : Lytic Infections on Agar Plates     | 14.41 |
| 9 | Preparation of Lysates Containing Fusion Proteins Encoded by Bacteriophage $\lambda$ : Lytic Infections in Liquid Medium   | 14.44 |

### INFORMATION PANELS

- |  |       |
|--|-------|
| Plasmid and Bacteriophage $\lambda$ Expression Vectors | 14.47 |
| Using Antibodies in Immunological Screening            | 14.50 |

**S**UCCESSFUL SCREENING OF CDNA EXPRESSION LIBRARIES requires probes that bind to target proteins with high specificity and dissociate from them slowly. Discussed below are three classes of probes that fit these criteria.

- **Antibody Probes.** Antibodies that recognize antigenic determinants or epitopes specific for the protein of interest are used to screen protein imprints of cDNA expression libraries. Because of their ability to react with cognate epitopes when the surrounding protein is malformed or denatured, antibodies are the reagents of choice for primary screening of expression libraries when no nucleic acid probes are available for the gene of interest (for reviews, please see Helfman and Hughes 1987; Mierendorf et al. 1987; Young and Davis 1991; Hurst 1997). Since 1983, when Young and Davis (1983a,b) introduced immunological screening, cDNA clones encoding hundreds of different proteins have been isolated by this method.

Immunological screening does not depend on the expression of a functional protein, merely on the synthesis of an immunologically reactive epitope. Although some epitopes are complicated topological structures formed by the folding of noncontiguous regions of one or more polypeptide chains, others consist of short tracts of adjacent amino acids from a single polypeptide chain (Geysen et al. 1987). Such localized epitopes can be formed in foreign proteins expressed in bacteria even though the protein as a whole may be malformed and non-functional. Simple epitopes can also form in fusion proteins, which will therefore display at least a part of the characteristic immunological reactivity of the entire target protein.

cDNA libraries suitable for immunological screening are occasionally constructed in plasmid vectors (Helfman et al. 1983; Helfman and Hughes 1987), but, more commonly, they are constructed in bacteriophage  $\lambda$  expression vectors such as gt11 (Huynh et al 1985) and its close relatives:  $\lambda$ gt18-23,  $\lambda$ ZAP,  $\lambda$ ZAP Express, and  $\lambda$ ZAPII. For further information about these expression systems, please see the information panel on **PLASMID AND BACTERIOPHAGE  $\lambda$  EXPRESSION VECTORS** at the end of this chapter.

- **Oligonucleotide Probes.** Double-stranded synthetic oligonucleotides of defined sequence are used to screen protein imprints of expression libraries for cDNA clones that express sequence-specific DNA-binding proteins (Schleif 1988; Singh et al. 1988; Vinson et al. 1988; Singh 1993). Screening can be laborious because the mRNAs for many proteins of this class are rare and because screening is generally carried out in a serial fashion with oligonucleotide probes that (1) correspond to the wild-type consensus binding sequence and (2) carry a mutated version of the binding sequence with reduced affinity for the transcription factor. Despite these disadvantages, screening expression libraries with DNA ligands has proven to be a remarkably rewarding technique. The rich harvest of clones encodes mammalian transcription factors containing several types of DNA-binding motifs including helix-turn-helix, zinc fingers, leucine zippers, and helix-loop-helix domains (for reviews, please see Singh et al. 1989; Singh 1993).
- **Specialized Probes.** Listed below are more specialized probes used to screen protein imprints of expression libraries.

*Labeled proteins or small organic molecules.* For example,  $^{125}\text{I}$ -labeled calmodulin has been used to isolate cDNA clones encoding proteins that bind to calmodulin (Sikela and Hahn 1987; Mutzel et al. 1990), whereas radiolabeled cAMP has been used as a probe to isolate cDNAs encoding cAMP-binding proteins (Lacombe et al. 1987). This type of interaction cloning has also led to the isolation of cDNAs encoding, for example, proteins involved in signal transduction pathways (Skolnik et al. 1991) and heterodimeric transcription factors (Blonar and Rutter 1992). However, such successes are rare, probably because the sensitivity of the technique is too low. These days, yeast two- and three-hybrid procedures would be the methods of choice to isolate cDNAs encoding interacting proteins (please see Chapter 18).

*Short RNA probes* have been used to isolate cDNAs encoding proteins that interact with the probe in a sequence-specific manner and with high affinity ( $K_b > 10^9 \text{ M}^{-1}$ ) (Qian and Wilusz 1993; for reviews, please see Bagga and Wilusz 1999; Webster and Macdonald 1999).

*Apurinic DNA* has been used as a probe to identify cDNA clones expressing DNA-repair proteins (Lenz et al. 1990).

- **Antibodies specific for phosphotyrosine residues.** Tyrosine residues of recombinant proteins expressed in bacteria can be phosphorylated by cognate kinases in posttranslational modification reactions. Antibodies directed against phosphotyrosine residues can therefore be used to screen protein imprints of mammalian cDNA libraries for clones encoding peptides rich in phosphotyrosine residues that are substrates for a particular kinase (e.g., please see Kornbluth et al. 1988; Lindberg et al. 1988).



Among the reagents that have been used to detect antibody bound to its antigen on nitrocellulose filters are the following:

- $^{125}\text{I}$ -labeled antibodies reactive with species-specific determinants on the primary antibodies (Helfman et al. 1983; Helfman and Hughes 1987).
- Protein A of *Staphylococcus aureus* radiolabeled with  $^{125}\text{I}$  (Kemp and Cowman 1981; Johnson et al. 1985).
- Second antibodies conjugated directly to horseradish peroxidase (HRP) (de Wet et al. 1984). Alternatively, HRP coupled to avidin may be used to detect a second antibody coupled to biotin (Young et al. 1985; French et al. 1986).
- Second antibodies conjugated to alkaline phosphatases (AP) (Mierendorf et al. 1987).
- Radiolabeled ligand, which binds to a divalent antibody that is attached monovalently to antigen on the nitrocellulose filter (Chao et al. 1989). This method can be used only in those rare circumstances when pure ligand is available in quantity.

Although a systematic comparison of these reagents has not been published, enzymatic methods of detection are generally more sensitive and give lower backgrounds than do radiochemical methods. In addition, enzymatic methods produce signals directly on the nitrocellulose filter (rather than on a sheet of X-ray film), so that positive plaques can be located more accurately.

Antibodies coupled to either HRP or AP that react with species-specific determinants on the primary antibodies are available commercially, and both have been used successfully to isolate cDNA clones from expression libraries constructed in bacteriophage  $\lambda$  vectors. Both enzymes catalyze the formation of an insoluble colored precipitate on the surface of a nitrocellulose filter at the site of an antigen-antibody complex (Towbin et al. 1979; Hawkes et al. 1982; Blake et al. 1984; Knecht and Dimond 1984; Towbin and Gordon 1984; Hawkes 1986). AP, however, offers some potential advantages: The enzyme remains active for several hours, during which the end product of the reaction — a dark-blue precipitate of diformazan (McGadey 1970) — continues to accumulate and intensify in color. By contrast, although HRP-conjugated antibodies can efficiently detect antigen-antibody complexes on the surfaces of nitrocellulose filters (Mierendorf et al. 1987), the yellow-brown color fades over the course of time. Some protocols also require the use of a carcinogenic chromogen, *o*-dianisidine, which requires special handling and disposal.

In addition to probes that bind to target proteins, expression libraries can of course be screened in the conventional manner with labeled DNA or RNA probes. Screening by hybridization does not require expression of the target protein, merely the presence in the recombinant clone of a DNA sequence encoding all or part of the protein. The technique may therefore be used to screen DNA imprints of any type of library constructed in any type of vector. For further details, please see Chapters 1 and 2.

In this chapter, we describe methods for the immunological screening of bacteriophage  $\lambda$  and plasmid cDNA expression libraries, methods for the purification of antibody probes, procedures for antibody-based screening of expression libraries, and methods for the production and analysis of fusion proteins in bacteriophage  $\lambda$  recombinants.

*Genetics tells us almost nothing about ourselves that we did not know before... . Genetics answers all the questions about the human condition, except for the interesting ones.*

Steve Jones

# Protocol 1

---

## Screening Expression Libraries Constructed in Bacteriophage $\lambda$ Vectors

**I**N A TYPICAL IMMUNOLOGICAL SCREENING EXPERIMENT, a library constructed in a bacteriophage  $\lambda$  expression vector is plated on an appropriate *Escherichia coli* strain in the absence of isopropylthio- $\beta$ -D-galactoside (IPTG). The absence of inducer ensures that no fusion proteins toxic to the host are synthesized until plaque formation is well under way. After 2–4 hours, the plates are moved from 42°C to 37°C to stabilize any fusion proteins that are temperature-sensitive, and filters impregnated with IPTG are laid on top of the developing plaques to collect an imprint of the induced fusion proteins. After incubation for a further 2–4 hours, the filters are removed and probed with antibody as described in the protocol. The plates are then stored at 4°C until the results of immunological screening are available. Positive plaques are recovered and analyzed further as described in detail in Protocols 7, 8, and 9 of this chapter and in Chapter 2.

Three alternative methods to detect bound antibodies are discussed: radiochemical screening, chromagenic screening, and chemiluminescent screening. The advantages and disadvantages of these methods are discussed in the introduction to this chapter.

### MATERIALS

---

**CAUTION:** Please see Appendix 12 for appropriate handling of materials marked with <!>.

#### Buffers and Solutions

**Please see Appendix 1 for components of stock solutions, buffers, and reagents. Dilute stock solutions to the appropriate concentrations.**

##### *Blocking buffer*

- 10 mM Tris-Cl (pH 8.0)
- 150 mM NaCl
- 0.05% (v/v) Tween-20
- 20% (v/v) fetal bovine serum

Alternative blocking buffers are 5% (w/v) nonfat dried milk or TNT buffer containing 1% (w/v) gelatin and 3% (w/v) bovine serum albumin. Opinion of the relative virtues of these blocking agents varies from laboratory to laboratory. We recommend that the investigator carry out preliminary experiments to determine which of them works best with the primary and secondary antibodies that will be used for screening. Blocking buffer can be stored at 4°C and reused several times. Sodium azide <!> should be added to a final concentration of 0.05% (w/v) to inhibit the growth of microorganisms.

**Chloroform <1>****IPTG (10 mM)**

Just before use in Step 4, dissolve 0.6 g of solid IPTG in 250 ml of H<sub>2</sub>O. Sterilize the solution by passage through a 0.25- $\mu$ m filter.

**Reagents for detection of antigen-antibody complexes:**

*Reagents for chromogenic screening with alkaline-phosphatase-conjugated antibody*

*Reagents for chromogenic screening with horseradish-peroxidase-conjugated antibody*

*Reagents for chemiluminescent screening*

For a list of reagents needed for the desired screening method, please see Step 15. For information on commonly used methods to detect antibodies, please see the information panel on **USING ANTIBODIES IN IMMUNOLOGICAL SCREENING** at the end of this chapter. For further details, please see the information panels in Appendix 9.

**SM**

Store SM at room temperature in 50-ml aliquots. Discard each aliquot after use to reduce the possibility of contamination.

**TNT buffer**

10 mM Tris-Cl (pH 8.0)

150 mM NaCl

0.05% (v/v) Tween-20

Approximately 1 liter of TNT buffer is required per 10 filters screened. Store TNT buffer at room temperature.

**Washing buffers:**

*TNT buffer containing 0.1% (w/v) bovine serum albumin*

*TNT buffer containing 0.1% (w/v) bovine serum albumin and 0.1% (v/v) Nonidet P-40*

These buffers should not contain sodium azide.

## Radioactive Compounds

*<sup>125</sup>I-labeled protein A or <sup>125</sup>I-labeled immunoglobulin (optional) <1>*

**Radioiodinated secondary antibody <1>**

Use this antibody if detecting the antigen-antibody complexes with a radiolabeled secondary antibody in Step 15.

### RADIOIODINATION OF IgG

**▲ WARNING** Perform this procedure behind appropriate shielding in a correctly vented chemical fume hood.

This method can be used to radiolabel an IgG fraction for use as a secondary antibody.

1. Prepare IgG from antiserum by protein A-Sepharose chromatography as described by Harlow and Lane (1999). Dilute the IgG with 50 mM sodium phosphate (pH 7.5) to obtain a final concentration of 1 mg/ml.
2. To 50  $\mu$ l of the diluted IgG, add 4  $\mu$ l of <sup>125</sup>I (sodium <sup>125</sup>I, 10 mCi/ml).
3. Add 15  $\mu$ l of chloramine T (2 mg/ml in 50 mM sodium phosphate [pH 7.5]).
4. Incubate the reaction for 90 seconds at room temperature.
5. Add 50  $\mu$ l of sodium metabisulfite (5 mg/ml in 50 mM sodium phosphate [pH 7.5]).
6. Apply the solution to a 5-ml column of Sephadex G-25 (equilibrated in 50 mM sodium phosphate [pH 7.5]) (please see Appendix 8).
7. Collect 0.5-ml fractions until all of the radioactivity has been eluted (~3 ml).
8. Pool the radioactive material.

Usually, >95% of the radiolabel is incorporated, and the specific activity of the radiolabeled antibody exceeds 10<sup>8</sup> cpm/mg. Do not store radiolabeled antibody for prolonged periods before use.

## Antibodies

### Primary antibody

For advice on choosing primary and secondary antibodies, please see the information panel on **USING ANTIBODIES IN IMMUNOLOGICAL SCREENING** at the end of this chapter.

## Media

### LB agar plates

Each 90-mm Petri dish should contain 30–35 ml of agar medium, whereas each 150-mm plate should contain ~50 ml. The plates must be dry; otherwise, the top agarose will peel off when the nitrocellulose filter is removed. Usually, 2-day-old plates that have been dried for an additional 1–2 hours at 37°C with their lids slightly open work well. LB agar plates without ampicillin are used in the screening procedure because *E. coli* Y1090*hsdR* grows slowly in the presence of the antibiotic.

### LB top agarose

Melt the top agarose by microwaving for a short period of time and then cooling to 47°C. Dispense the molten top agar as 3-ml aliquots (for 90-mm plates) or 7.5-ml aliquots (for 150-mm plates) in sterile tubes. Place the aliquots in a 47°C heating block or water bath to prevent the top agar from gelling.

## Special Equipment

*Air incubator preset to 42°C*

*Culture tubes (sterile 13 × 100 mm)*

*Forceps, blunt-ended*

*Needle (18-gauge) and syringe filled with waterproof black drawing ink (India Ink)*

### Nitrocellulose filters

Filters suitable for binding protein and immunoblotting include nitrocellulose filters free of Triton X-100 (Millipore HATF or equivalent), and supported nitrocellulose derivatives such as Hybond-C extra (Amersham Pharmacia Biotech). Nylon membranes and charged nylon membranes should not be used for immunological screening because of their poor retention of proteins and high backgrounds.

Number the filters with a soft-lead pencil or ballpoint pen, wet them with water, and sandwich them between dry Whatman 3MM papers. Wrap the stack of filters in aluminum foil, and sterilize them by autoclaving at 10 psi (0.70 kg/cm<sup>2</sup>) on liquid cycle.

## Additional Reagents

*Step 1 of this protocol requires the reagents listed in Chapter 2, Protocol 1.*

*Step 17 of this protocol requires the reagents listed in Chapter 2 Protocol 2.*

## Vectors and Bacterial Strains

### Bacteriophage $\lambda$ expression library

Construct a cDNA library in an appropriate expression vector as described in Chapter 11 or purchase the library from a commercial supplier. Before beginning the screening experiment, determine the titer of the bacteriophage solution as described in Chapter 2, Protocol 1.

### *E. coli*

Different bacterial host strains used in expression screening require different growth media. For example, *E. coli* Y1090*hsdR*, which is commonly used as a host strain for cDNA libraries constructed in  $\lambda$ gt11, carries a mutation in the *lon* gene which encodes an ATP-dependent protease. Fusion proteins expressed in these strains are often more stable than those expressed in strains lacking this mutation. This strain also carries a plasmid (pMC9) that encodes the *lac* repressor and prevents synthesis of potentially toxic fusion proteins from the  $\beta$ -galactosidase promoter. This plasmid also carries a selectable marker (*amp<sup>r</sup>*). To ensure against loss of the plasmid, grow *E. coli* strain Y1090*hsdR* in media containing 50  $\mu$ g/ml ampicillin (except when screening, please see note with LB agar plates above).

*E. coli* strains BB4 and XL1-Blue, which are used for immunological screening of libraries constructed in  $\lambda$ ZAP and its derivatives, carry a *lacI<sup>q</sup>* gene and a *ter<sup>r</sup>* marker on an F' factor. These strains should be grown in media containing 12.5  $\mu$ g/ml tetracycline.

Before plating the host strain to be used, become familiar with its genotype and any unique growth requirements.

## METHOD

---

### Plating Bacteriophage $\lambda$

1. Using a single colony of the appropriate strain of *E. coli* as inoculum, prepare a plating culture as described in Chapter 2, Protocol 1.
2. Calculate the number of plates that will be required to screen the library, assuming  $0.5 \times 10^4$  to  $2 \times 10^4$  plaques per 90-mm plate or  $0.5 \times 10^4$  to  $5 \times 10^4$  plaques per 150-mm plate. Arrange a set of sterile tubes (13  $\times$  100 mm) in a rack; use a fresh tube for each plate. In each tube, mix 0.1 ml of the plating bacteria with 0.1 ml of SM containing the desired number of plaque-forming units of the bacteriophage  $\lambda$  expression library. Incubate the infected bacteria for 20 minutes at 37°C.

Immunological screening works best when the density of plaques is low. The color produced by the chromogenic reaction is most intense at the expanding edge of the plaque. Well-isolated immunopositive plaques therefore display a characteristic ring-like pattern. When plaques crowd against one another, their morphology becomes fragmented, and the intensity of color at the common border between adjacent plaques is greatly reduced. However, immunopositive plaques can still be recognized as long as some portions of their borders do not make contact with the borders of neighboring plaques. When the density exceeds  $\sim 500$  plaques/cm<sup>2</sup>, the borders between neighboring plaques disappear and antigen-positive plaques become increasingly difficult to identify. The number of plaques per plate given in this step should therefore be regarded as the upper limit for immunological screening.

3. Add to each tube 2.5 ml (90-mm plate) or 7.5 ml (150-mm plate) of molten top agarose, and immediately pour the mixture onto an LB agar plate. Incubate the infected plates for 3.5 hours at 42°C.

An incubation temperature of 42°C is used to ensure inactivation of the  $\lambda$  repressor protein (encoded by the *cI*s857 allele) and activation of the lytic program of bacteriophage  $\lambda$  development.

### Induction of Protein Expression on Filters

4. Number the nitrocellulose filters with a soft-lead pencil or a ballpoint pen. Use gloves to handle the filters because skin oils will prevent the transfer of proteins. Soak the filters in 10 mM IPTG for a few minutes. Use blunt-ended forceps (e.g., Millipore forceps) to remove the filters from the solution, and allow them to dry at room temperature on a pad of Kimwipes.
5. Remove one plate at a time from the incubator, and quickly overlay it with an IPTG-impregnated nitrocellulose filter. Do not move the filter once contact is made with the plate. Put the plate in the 37°C incubator and repeat the above procedure until all plates contain a nitrocellulose filter.

The easiest way to place the filter on the plate without trapping air bubbles is to hold it by its edges, bending it slightly so that the middle of the filter makes contact with the center of the plate. Wetting action then pulls the filter onto the plate.

It is important to place filters on the plates one at a time so that the temperature of the plates does not drop below 37°C. The growth of bacteriophages is severely retarded at temperatures  $< 30^\circ\text{C}$ .

6. Incubate the plates for at least 4 hours at 37°C.

During primary screening of a library, it is often difficult to distinguish immunoreactive plaques from false positives. The frequency with which false positives appear depends on several factors, including the care taken in handling the filters, the characteristics of the particular antiserum, and the method used to detect antigen-antibody complexes. In general, chromogenic methods of detection yield fewer false positives than radiochemical methods and chemiluminescent methods. Even

under the best conditions, however, false positives arise at a frequency of approximately one per plate. To avoid the labor and expense of screening large numbers of plaques for a second time, we recommend that primary screening be carried out in duplicate.

If the library is not to be screened in duplicate, the original filter can be left on the plate for 10–12 hours. If duplicate filters are required, please see the panel following Step 9.

7. Remove the lids from the plates and continue the incubation for a further 20 minutes at 37°C. This step strengthens the bond between the soft agarose and the agar plate.
8. Move the plates in small batches to room temperature. Use an 18-gauge needle attached to a syringe containing waterproof black ink to mark each filter in at least three asymmetric locations by stabbing through it and into the agar underneath.
9. Use blunt-ended forceps to peel the filters off the plates and immediately immerse them in a large volume of TNT buffer. Rinse away any small remnants of agarose by gently agitating the filters in the buffer. The speed of the shaking incubator should be high enough to prevent the filters from sticking to one another.

If large areas of the top agarose stick to the nitrocellulose filters, chill the plates for 30 minutes at 4°C or 5 minutes at –20°C before peeling the filters off the surface of the agarose.

#### To Prepare Duplicate Filters

- a. Remove the lids from the plates 30 minutes before removing the first filter.
- b. Chill the plates for 30 minutes at 4°C or 5 minutes at –20°C.
- c. Mark each filter with waterproof black ink.
- d. Remove the filters and immediately immerse them in TNT buffer.
- e. Overlay each of the plates with a second filter impregnated with IPTG.
- f. Incubate the plates for a further 4–6 hours at 37°C.
- g. Meanwhile, process the first set of filters as described in Step 10 onward.
- h. After the second batch of filters has been incubated on the plates for 4–6 hours, mark them with ink, immerse them in TNT buffer, and process them as described in Step 10 onward.

10. After all of the filters have been transferred to the TNT buffer, wrap the plates in plastic film and store them at 4°C until the results of the immunological screening are available.

### Detection of Plaques Expressing Fusion Protein

▲ **IMPORTANT** Do not allow the filters to dry out during any of the subsequent steps. Antibodies bound nonspecifically and reversibly to wet filters become permanently attached if the filters dry out. It is also essential that the filters do not stick to one another when they are immersed in the various buffers and antibody solutions. This problem can be minimized by dividing the filters into small batches (e.g., five filters per batch) and using a separate large Petri dish or crystallizing dish for each batch. The Petri dishes can be stacked on top of one another on a slowly rotating platform shaker.

11. When all of the filters have been rinsed, transfer them one at a time to a fresh batch of TNT buffer. After transfer, agitate the buffer and filters gently for a further 30 minutes at room temperature.

If necessary, the filters may be removed from the buffer at this stage, wrapped in Saran Wrap, and stored for up to 24 hours at 4°C.

12. Use blunt-ended forceps to transfer the filters individually to a glass tray(s) containing blocking buffer (7.5 ml for each 82-mm filter, 15 ml for each 138-mm filter). When all of the filters have been submerged, agitate the buffer and filters slowly on a rotary platform for 30 minutes at room temperature.

13. Use blunt-ended forceps to transfer the filters to a fresh glass tray(s) containing the primary antibody diluted in blocking buffer (7.5 ml for each 82-mm filter, 15 ml for each 138-mm filter). Use the highest dilution of antibody that gives acceptable background yet still allows detection of 50–100 pg of denatured antigen. When all of the filters have been submerged, agitate the solution gently on a rotary platform for 2–4 hours at room temperature.

The antibody solution can be stored at 4°C and reused several times. Sodium azide should be added to a final concentration of 0.05% (w/v) to inhibit the growth of microorganisms.

14. Wash the filters for 10 minutes in each of the buffers below, in the order given. Transfer the filters individually from one buffer to the next. Use 7.5 ml of each buffer for each 82-mm filter and 15 ml for each 138-mm filter.

TNT buffer containing 0.1% bovine serum albumin

TNT buffer containing 0.1% bovine serum albumin and 0.1% Nonidet P-40

TNT buffer containing 0.1% bovine serum albumin

15. Detect the antigen-antibody complexes with the chosen radiochemical, chromogenic, or chemiluminescent reagent.

---

#### RADIOCHEMICAL SCREENING

---

Use ~1  $\mu$ Ci of  $^{125}$ I-labeled protein A or immunoglobulin per filter. Radiolabeled protein A is available from commercial sources (specific activity 2–100  $\mu$ Ci/ $\mu$ g). Radioiodinated secondary antibody is available commercially or can be prepared as described in the panel on **RADIOIODINATION OF IgG** above in Materials.

- a. Dilute radiolabeled ligands in blocking buffer (7.5 ml for each 82-mm filter, 15 ml for each 138-mm filter).
- b. Incubate the filters for 1 hour at room temperature, and then wash them several times in TNT buffer before establishing autoradiographs as described in Appendix 9.

*Continue at Step 16.*

---

#### CHROMOGENIC SCREENING

---

Antibodies coupled to horseradish peroxidase (HRP) or alkaline phosphatase (AP) that react with species-specific determinants on primary antibodies are available from commercial sources and should be used at the recommended dilution in accordance with the manufacturer's instructions. Typically, 5  $\mu$ l of conjugated antiserum is used for each 82-mm filter in 7.5 ml of blocking buffer (without sodium azide). For further details on HRP or AP, please see the information panels in Appendix 9.

#### *Antigen-Antibody-Antibody-AP Complexes Located Using BCIP and NBT*

##### **Materials for Chromogenic Screening with AP-conjugated Antibodies**

*Alkaline phosphatase-conjugated anti-immunoglobulin antibodies*

*AP buffer*

100 mM Tris-Cl (pH 9.5)

100 mM NaCl

5 mM MgCl<sub>2</sub>

*5-Bromo-4-chloro-3-indolyl phosphate (BCIP)*

*Dimethylformamide <math>\langle ! \rangle</math>*

*Nitro blue tetrazolium (NBT)*

- a. Gently agitate the filters for 1.5–2 hours at room temperature in the solution of AP-conjugated antibody.
- b. Wash the filters as described in Step 14.
- c. Prepare stock solutions of BCIP (50 mg/ml in 100% dimethylformamide) and NBT (50 mg/ml in 70% dimethylformamide). These solutions are stable when stored in the dark.
- d. Prepare the BCIP/NBT developing solution just before use as follows:
  - i. Add 33  $\mu$ l of the NBT solution to 5 ml of AP buffer and mix well.
  - ii. Add 16.5  $\mu$ l of the stock solution of BCIP. Mix again. Protect the solution from strong light and use it within 1 hour.
- e. Blot the washed filters on paper towels.
- f. Incubate the filters (Step d) in the BCIP/NBT developing solution (7.5 ml for each 82-mm filter, 15 ml for each 138-mm filter) for several hours at room temperature.
- g. Rinse the filters briefly in two changes of H<sub>2</sub>O. An intense purple color will develop at the site of antigen-antibody complexes.

Continue at Step 16.

#### Antigen-Antibody-Antibody-HRP Complexes Located Using 4-Chloro-1-Naphthol

##### Materials for Chromogenic Screening with HRP-conjugated Antibodies

4-Chloro-1-naphthol  
 H<sub>2</sub>O<sub>2</sub> (30%) <!  
 HRP-conjugated anti-immunoglobulin antibodies  
 Methanol <!  
 NaCl (5 M)  
 Tris-Cl (1 M, pH 7.5)  
 Tris-Cl (10 mM, pH 7.5) containing 150 mM NaCl

- a. Gently agitate the filters in the HRP-conjugated antibody solution for 1.5–2 hours at room temperature.
- b. Wash the filters as described in Step 14.
- c. To prepare developing solution, dissolve 60 mg of 4-chloro-1-naphthol in 20 ml of ice-cold methanol. Just before use, mix the solution with 100 ml of 10 mM Tris-Cl (pH 7.5), 150 mM NaCl containing 60  $\mu$ l of 30% H<sub>2</sub>O<sub>2</sub>.
- d. Blot the washed filters on paper towels and wash them briefly in 10 mM Tris-Cl (pH 7.5) containing 150 mM NaCl.
- e. Incubate the filters for 15–20 minutes at room temperature in the 4-chloro-1-naphthol developing solution (10 ml for each 82-mm filter, 25 ml for each 138-mm filter).
- f. Wash the filters in two changes of H<sub>2</sub>O. An intense purple color will develop at the site of antigen-antibody complexes.

Biotinylated species-specific antibodies and avidin-conjugated HRP are available from commercial sources. They should be diluted according to individual manufacturer's instructions and used for immunological screening as described above for HRP-conjugated antibodies.



Clones of bacteriophage  $\lambda$  can be recovered directly from stained filters after chromogenic screening (Alter and Patrie 1990). The amounts of infectious particles recovered by the recommended method — scraping the filters with a scalpel blade — are highly variable, ranging from  $<100$  to  $>10^4$  pfu per stained imprint. The scrapings from each imprint are mixed with 20- $\mu$ l aliquots of SM, stored overnight at 4°C, and then replated in a series of dilutions on the appropriate strain of *E. coli*. Of course, much greater quantities of bacteriophages can be recovered by the traditional method of aligning the stained filters with the original plaques. However, large quantities of bacteriophage are not necessarily an advantage since the next step is to plaque-purify the recombinant bacteriophage.

If the scraping method is used, we recommend continuing the traditional method of keying the filters to the plaques, especially when screening large cDNA libraries. This extra effort provides insurance if the desired recombinants fail to be recovered by scraping.

*Continue at Step 16*

---

### CHEMILUMINESCENT SCREENING

---

Chemiluminescence is the most sensitive method for detecting immunopositive plaques. The secondary antibody is typically conjugated to either AP or HRP. Use of AP-conjugated antibodies requires substrates such as 1,2-dioxetane phosphates that emit light at a maximum wavelength of 466 nm upon dephosphorylation. HRP-conjugated antibodies oxidize the substrate luminol, which in the presence of hydrogen peroxide and phenol emits an intense light emission with a maximum at 428 nm. With either system, the light emission can be captured by autoradiography. Chemiluminescent detection is quick, produces a permanent record of the screened filter (an X-ray film or phosphoimage), and is sensitive (1–10 pg of antigen in a plaque can be detected). Two potential drawbacks are the inflated cost of the reagents and the need to identify positives on the original agar plate by comparison to an autoradiogram. A typical protocol follows.

#### Materials for Chemiluminescent Screening

*AP- or HRP-conjugated anti-immunoglobulin antibodies*  
*Chemiluminescent substrates (commercially available from, e.g., Tropix)*  
*Saran Wrap*

- a. Gently agitate the filters for 1.5–2 hours in the AP- or HRP-conjugated antibody solution at room temperature.
- b. Wash the filters as described in Step 14.
- c. Prepare the chemiluminescent substrates according to the manufacturer's instructions.
- d. Incubate the washed filters in the chemiluminescent substrates for 1–5 minutes (again, consult the manufacturer's recommendations for optimal exposure times).
- e. Drain the excess solution from the filters, and immediately wrap the filters in Saran Wrap. Do not allow the filters to dry out.
- f. Establish an autoradiogram (please see Appendix 9). Typically, the initial exposure is 1 minute. This interval provides enough information to establish the proper exposure time.

*Continue at Step 16.*

16. Identify the locations of positive plaques or, if made, compare the duplicate filters, searching for coincident signals. For screens involving radiolabeled or chemiluminescent probes, compare the resulting autoradiograms with the agar plates on a light box. For screens involving chromogenic reagents that leave a visible positive residue on the filter, carry out the following steps:
  - a. Lay a sheet of Saran Wrap or Mylar film over the filters.
  - b. On the surface of the Saran Wrap, mark the locations of the holes in the filters and the locations of antigen-positive clones with different colored waterproof markers. Label the Saran Wrap to identify the plates from which the filters were derived.
  - c. Place the sheet of Saran Wrap on a light box, and align the plates containing the original bacteriophage  $\lambda$  plaques on top of it.
  - d. Identify the area containing the positive plaque, and remove a plug of agar from this area using the large end of a Pasteur pipette. Transfer the plug to 1 ml of SM containing 2 drops of chloroform.
  - e. Keep the sheet of Saran Wrap, which provides a permanent record of the locations of the positive plaques. The colored spots on the original filters fade quite rapidly.
17. Allow the bacteriophage particles to elute from the agar plug for several hours at 4°C. Measure the titer of the bacteriophages in the eluate, and then replat them so as to obtain ~3000 plaques per 90-mm plate. Rescreen the plaques as described above (from Step 4 onward), and repeat the process of screening and plating until a homogeneous population of immunopositive recombinant bacteriophages is obtained.

#### VALIDATION OF CLONES ISOLATED BY IMMUNOLOGICAL SCREENING

The identification of immunoreactive clones from expression libraries cannot be taken as proof that the cDNA of interest has been isolated. The specificity of antibodies is never absolute and the epitope(s) recognized on the protein is usually undefined. Further tests are therefore required to validate the identity of the initial isolates. In decreasing order of stringency, these tests include:

- **Demonstration that the protein encoded by the cloned cDNA displays the correct biological or enzymatic activity.** This test usually requires the isolation of full-length cDNA clones and expression in prokaryotic or eukaryotic vectors that do not generate fusion proteins. In only a few cases has it been possible to demonstrate the appropriate enzymatic activity in fusion proteins synthesized in bacteriophage  $\lambda$ gt11 vectors (e.g., firefly luciferase [de Wet et al. 1984] and cat brain glutamate decarboxylase [Kaufman et al. 1986]).
- **Comparison of the amino acid sequence of the protein with the amino acid sequence deduced from the sequence of the cloned cDNA.** At present, this test can rarely be applied, since there is usually no amino acid sequence available for proteins whose genes are cloned by immunological screening. However, as the catalog of human genes is completed, this test should become routine.
- **Demonstration that the fusion protein expressed by the clone can block the interaction between the purified protein of interest and a specific antibody.** For example, the fusion protein could protect an enzyme from inactivation by an antibody. Alternatively, the fusion protein can be used as a ligand in affinity purification of an antibody (e.g., please see Earnshaw and Rothfield 1985). The affinity-purified antibody is then used as a probe in western blots of purified antigen. Finally, the fusion protein may be used as an immunogen to raise antibodies that can be tested for their ability to bind to, or inhibit the activity of, the protein of interest. For the preparation of fusion proteins, please see Protocols 7, 8, and 9 in this chapter and Chapter 15.

These tests are by no means the only ones that may be used to validate clones isolated by immunological screening. Regardless of the method used, it is essential to devise independent tests that do not rely on the same immunological reagents used to identify the clone in the first place.

**TROUBLESHOOTING**

A variety of problems are encountered when using antibodies to screen an expression library in a bacteriophage  $\lambda$  vector. Consider the following if "cursed" with no positive clones or "blessed" with an abundance of positives. General texts on immunochemistry can provide insights and solutions to certain problems (Johnstone and Thorpe 1982; Harlow and Lane 1999).

- The antibody used may not recognize the antigen when the latter is expressed in *E. coli*. This problem can occur when screening for eukaryotic cell surface proteins that have an abundance of posttranslational modifications such as carbohydrates, lipids, and disulfide bonds. Each of these modifications are antigenic and not generally present on proteins expressed in bacteria. Monospecific polyclonal antibodies that recognize fully denatured, deglycosylated proteins should be used whenever possible to avoid these problems.
- Use a TNT buffer that does not contain Tween. Nonionic detergents can disrupt the binding of low-affinity antibodies to an antigen. Omitting Tween can, however, lead to the detection of an abundance of false positive clones due to the accompanying reduction in stringency.
- The use of excess primary or secondary antibody in the screening reactions can lead to the detection of too many "positive" clones. These clones are presumed to result from binding of antibody to proteins that are related to the two targets, but are not identical to them. Diluting the antibody may eliminate or reduce cross-reactions without significantly affecting the binding of the antibody to its two targets.
- Too many positives can sometimes reflect a problem with the blocking reagent. Try one of the other blocking reagents suggested under the blocking buffer entry in the Materials list. Alternatively, increase the concentration of Tween or try another nonionic detergent such as Nonidet P-40 in the rinsing and washing buffers. The temperature at which the blocking, rinsing, and washing steps are carried out can be increased to as high as 50°C.
- If positive plaques are not detected, vary the incubation times in the protocol. For example, the incubation of the IPTG-soaked filters on the agar plates can be varied between 2 and 10 hours. Snyder et al. (1987) reported that an 8–10-hour incubation yields a signal that is 5–10 times stronger than a 2-hour incubation. Similarly, an overnight incubation with primary antibody or incubation at 4°C works better for some antibodies, especially those with low affinity for antigen.

# Protocol 2

---

## Screening Expression Libraries Constructed in Plasmid Vectors

**M**OST CDNA LIBRARIES CONSTRUCTED IN PLASMIDS TODAY USE EXPRESSION vectors of the pUC, pUR, or pEX series (please see Chapters 11 and 15 and Appendix 3). In the pUC and pUR vectors, the cDNA is inserted into polycloning sites that lie within the amino-terminal region (pUC) or the carboxy-terminal region (pUR) of the *E. coli*  $\beta$ -galactosidase gene. Although libraries constructed in both pUR and pUC vectors have been screened successfully with antibodies (e.g., please see Helfman et al. 1983), pUR vectors have some advantages. First, because the polycloning site is available in all three translational reading frames, any open reading frame of a sequenced fragment of cDNA can be easily inserted in the appropriate frame for expression. Second, fusion proteins in which the foreign sequences are located in the carboxy-terminal region of  $\beta$ -galactosidase are more stable than fusion proteins with insertions in the amino-terminal region (Stanley 1983). In at least some cases, fusion proteins synthesized from recombinants constructed in pUR vectors retain  $\beta$ -galactosidase activity (Rüther and Müller-Hill 1983), which can serve as a useful marker during protein purification (please see Chapter 15, Protocol 1, and Chapter 17, Protocol 7). Expression of fusion proteins in both pUC and pUR plasmids is controlled by the upstream *lac* promoter and is therefore repressed in strains of bacteria that overproduce the *lac* repressor ( $I^q$  strains). Continual repression is important to prevent constitutive expression of foreign proteins, which are frequently toxic to *E. coli* (Amann et al. 1983; Gething and Sambrook 1983). Plasmids encoding toxic proteins can therefore be propagated and amplified under conditions that allow only minimal expression of the fusion protein. Maximal synthesis of the fusion protein is transiently induced by exposing the culture to IPTG before immunological screening is undertaken. Several expression plasmids have been described that carry their own copy of the *lacI<sup>q</sup>* gene (e.g., please see Stark 1987). Expression of sequences cloned in these plasmids is tightly regulated, regardless of the strain of bacteria used.

The pEX family of plasmids also contains polycloning sites in all three reading frames at the 3' terminus of a fusion gene composed of bacteriophage  $\lambda$  *cro* sequences and *E. coli* *lacZ* sequences (Stanley and Luzio 1984). Expression of *cro*- $\beta$ -galactosidase fusion proteins is controlled by the bacteriophage  $\lambda$   $p_R$  promoter, which can be repressed during growth and amplification of the plasmid by the bacteriophage  $\lambda$  *cI* gene product. The pEX vectors are normally grown at 30°C in a bacterial strain carrying a defective bacteriophage  $\lambda$  prophage that synthesizes a temperature-sensitive *cI* gene product. Transient expression of the fusion protein is induced by raising the temperature of incubation to 42°C before immunological screening.

Although quantitative comparisons have not been carried out, it is clear that each of these three families of plasmids can efficiently direct the synthesis of large quantities of fusion proteins

(up to 40% of the total extractable cellular protein). Within any one system, smaller fusion proteins are expressed to higher levels than larger fusion proteins and are degraded less rapidly by cellular proteases, perhaps because they more readily form precipitates (known as inclusion bodies; please see Chapter 15, Protocol 8) within the cell (Stanley and Luzio 1984).

Three alternative methods to detect bound antibodies are discussed: radiochemical screening, chromagenic screening, and chemiluminescent screening. The advantages and disadvantages of these methods are discussed in the introduction to this chapter.

## MATERIALS

**CAUTION:** Please see Appendix 12 for appropriate handling of materials marked with <!>.

### Buffers and Solutions

Please see Appendix 1 for components of stock solutions, buffers, and reagents. Dilute stock solutions to the appropriate concentrations.

#### *Blocking buffer*

10 mM Tris-HCl (pH 8.0)  
150 mM NaCl  
0.05% (v/v) Tween-20  
20% (v/v) fetal bovine serum

Alternative blocking buffers are 5% (w/v) nonfat dried milk or TNT buffer containing 1% (w/v) gelatin and 3% (w/v) bovine serum albumin. Opinion of relative virtues of these blocking agents varies from laboratory to laboratory. We recommend that the investigator carry out preliminary experiments to determine which of them works best with the primary and secondary antibodies that will be used for screening. Blocking buffer can be stored at 4°C and reused several times. Sodium azide <!> should be added to a final concentration of 0.05% (w/v) to inhibit the growth of microorganisms.

#### *Chloroform <!>*

#### *Lysis buffer*

100 mM Tris-Cl (pH 7.8)  
150 mM NaCl  
5 mM MgCl<sub>2</sub>  
1.5% (w/v) bovine serum albumin  
1 µg/ml pancreatic DNase I  
40 µg/ml lysozyme

Add DNase I and lysozyme to this buffer just before use in Step 11.

#### *Reagents for detection of antigen-antibody complexes:*

*Reagents for chromogenic screening with alkaline-phosphatase-conjugated antibody*  
*Reagents for chromogenic screening with horseradish-peroxidase-conjugated antibody*  
*Reagents for chemiluminescent screening*

For a list of reagents needed for the screening method, please see Step 19. For information on commonly used methods to detect antibodies, please see the information panel on **USING ANTIBODIES IN IMMUNOLOGICAL SCREENING**. For further details, please see the information panels in Appendix 9.

#### *SM*

Store SM at room temperature. Discard each aliquot after use to reduce the possibility of contamination.

#### *TNT buffer*

10 mM Tris-Cl (pH 8.0)  
150 mM NaCl  
0.05% (v/v) Tween-20

Approximately 1 liter of TNT buffer is required per 10 filters screened. Store TNT buffer at room temperature.

#### *Washing buffers:*

*TNT buffer containing 0.1% (w/v) bovine serum albumin*

*TNT buffer containing 0.1% (w/v) bovine serum albumin and 0.1% (v/v) Nonidet P-40*

These buffers should not contain sodium azide.

## Radioactive Compounds

<sup>125</sup>I-labeled protein A or <sup>125</sup>I-labeled immunoglobulin (optional) <!>

Radioiodinated secondary antibody <!>

Use this antibody if detecting the antigen-antibody complexes with a radiolabeled secondary antibody in Step 19.

### RADIOIODINATION OF IgG

▲ **WARNING** Perform this procedure behind appropriate shielding in a correctly vented chemical fume hood.

This method can be used to radiolabel an IgG fraction for use as a secondary antibody.

1. Prepare IgG from antiserum by protein A-Sepharose chromatography as described by Harlow and Lane (1999). Dilute the IgG with 50 mM sodium phosphate (pH 7.5) to obtain a final concentration of 1 mg/ml.
2. To 50  $\mu$ l of the diluted IgG, add 4  $\mu$ l of <sup>125</sup>I (sodium <sup>125</sup>I, 10 mCi/ml).
3. Add 15  $\mu$ l of chloramine T (2 mg/ml in 50 mM sodium phosphate [pH 7.5]).
4. Incubate the reaction for 90 seconds at room temperature.
5. Add 50  $\mu$ l of sodium metabisulfite (5 mg/ml in 50 mM sodium phosphate [pH 7.5]).
6. Apply the solution to a 5-ml column of Sephadex G-25 (equilibrated in 50 mM sodium phosphate [pH 7.5]) (please see Appendix 8).
7. Collect 0.5-ml fractions until all of the radioactivity has eluted (~3 ml).
8. Pool the radioactive material.

Usually, >95% of the radiolabel is incorporated, and the specific activity of the radiolabeled antibody exceeds 10<sup>8</sup> cpm/mg. Do not store radiolabeled antibody for prolonged periods before use.

## Antibodies

### Primary antibody

For advice on choosing primary and secondary antibodies, please see the information panel on **USING ANTIBODIES IN IMMUNOLOGICAL SCREENING** at the end of this chapter. For further information on antibodies, please see the information panels in Appendix 9.

## Media

### LB or SOB agar plates

Include the appropriate antibiotic for the expression system or vector used to construct the cDNA library. Each 90-mm Petri dish should contain 30–35 ml of agar medium, whereas each 150-mm plate should contain ~50 ml. The plates must be dry; otherwise, the top agarose will peel off when the nitrocellulose filter is removed. Usually, 2-day-old plates that have been dried for an additional 1–2 hours at 37°C with their lids slightly open work well.

### LB or SOB agar plates containing 1 mM IPTG

Plates containing IPTG are required if the expression vector carries the lac promoter. For additional details on IPTG-induced expression of proteins, please see the discussion on Expression Vectors Containing an IPTG-inducible Promoter in the introduction to Chapter 15.

## Special Equipment

### Air incubators preset at 30°C and 42°C

These are required if the expression vector carries the bacteriophage  $\lambda$  p<sub>R</sub> promoter (e.g., pEX series); otherwise the incubators are set at 37°C.

### Forceps, blunt-ended

Needle (18-gauge) and syringe filled with waterproof black ink (India Ink)

*Nitrocellulose filters*

Filters suitable for binding protein and immunoblotting include nitrocellulose filters free of Triton X-100 (Millipore HATF or equivalent) and supported nitrocellulose derivatives such as Hybond-C extra (Amersham Pharmacia Biotech). Nylon membranes and charged nylon membranes should not be used for immunological screening because of their poor retention of proteins and high backgrounds.

Number the filters with a soft-lead pencil or ballpoint pen, wet them with water, and sandwich them between dry Whatman 3MM papers. Wrap the stack of filters in aluminum foil, and sterilize them by autoclaving at 10 psi (0.70 kg/cm<sup>2</sup>) on liquid cycle.

*Plastic box and Glass Petri dish**Whatman 3MM papers, in a stack*

Prepare one Whatman 3MM paper for each filter plus a few spares. Wrap the stack of papers in aluminum foil, and sterilize them by autoclaving at 10 psi (0.70 kg/cm<sup>2</sup>) on liquid cycle.

**Vectors and Bacterial Strains***Plasmid expression library*

Construct a cDNA library in an appropriate expression vector as described in Chapter 11 or purchase the library from a commercial supplier.

**Additional Reagents**

Step 19 of this protocol requires the reagents listed in Protocol 1.

**METHOD**

---

**Preparation of Master Plates and Filters**

1. Use sterile blunt-ended forceps (e.g., Millipore forceps) to place a sterile nitrocellulose filter, numbered side down, on an LB (or SOB) plate. Remove the filter from the plate, invert it, and replace it, numbered side up.
2. Apply the bacteria in a small volume of liquid (<0.5 ml containing up to 20,000 bacteria for a 138-mm filter, <0.2 ml containing up to 10,000 bacteria for an 82-mm filter). Spread the liquid over the surface of the filter with a sterile bent glass rod. Leave a border 2–3 mm wide at the edge of the filter free of bacteria. Store the plates at room temperature until all of the liquid has been absorbed.
3. Invert the plates and incubate them until very small (0.1-mm diameter) colonies appear (8–10 hours).

Grow colonies containing expression vectors carrying the *lac* promoter at 37°C. Grow colonies containing expression vectors carrying the bacteriophage  $\lambda$  *p<sub>R</sub>* promoter at 30°C to prevent the expression of fusion proteins.

**Preparation of Replica Filters**

4. Wet a numbered, sterile nitrocellulose filter by touching it, numbered side up, to the surface of a fresh agar plate containing the appropriate antibiotic. Leave the filter in contact with the surface of the agar. The numbers on the set of replica filters should correspond to those on the master filters.
5. Use sterile blunt-ended forceps to remove the master filter gently from one of the agar plates (Step 3) and place it, colony side up, on the stack of sterile Whatman 3MM papers.

6. Carefully place the second, correspondingly numbered, wetted filter numbered side down on top of the master filter, being careful not to move the filters once contact has been made. Place a circle of 3MM paper on top of the filter sandwich. Place the bottom of an empty Petri dish on top of the 3MM paper and exert hand pressure on the sandwich.
7. Use an 18-gauge needle to make a characteristic set of registration holes in the filters while they are sandwiched together. Gently peel the filters apart. Transfer the replica filter to the plate used for wetting (Step 4). Transfer the master filter, colony side up, to a fresh agar plate containing the appropriate antibiotic.

If required, several replicas can be made from a single master filter. However, if the master filter is to be used to make more than two replicas, reincubate it for a few hours to allow the colonies to regenerate. Generally, it is best to make only two replicas from a single master to avoid problems caused by smearing of the colonies.
8. Repeat Steps 4–7 until all the master filters have been replicated.
9. Induce the expression of a gene cloned into an expression vector carrying the *lac* promoter as described below.
  - a. Incubate the plates (masters and replicas) at 37°C until colonies 1–2 mm in diameter have appeared. Colonies on the master plates generally reach the desired size more rapidly.
  - b. Allow the master plates to cool to room temperature on the laboratory bench, wrap them in plastic film, and store them at 4°C until the results of the immunological screens are available.
  - c. Transfer the replica filters numbered side up to fresh agar plates, prewarmed to 37°C, containing IPTG at a concentration of 1 mM. Incubate the IPTG-containing plates for a further 2–4 hours.
  - d. To induce synthesis in expression vectors that carry the bacteriophage  $\lambda$   $p_R$  promoter (e.g., the pEX vectors; please see Appendix 3), transfer the filters to a series of prewarmed agar plates and incubate them for 2–4 hours at 42°C.

### Processing Filters for Immunological Screening of Colonies

10. Use blunt-ended forceps to remove the nitrocellulose filters from the plates and place them on damp paper towels *in a chemical fume hood*. Cover the filters with an inverted plastic box. Place an open glass Petri dish containing chloroform under the box with the filters. Expose the bacterial colonies on the filters to chloroform vapor for 15 minutes.
11. Transfer small groups of filters to Petri dishes containing lysis buffer (6 ml per 82-mm filter, 12 ml per 138-mm filter). When all of the filters have been submerged, stack the Petri dishes on a rotary platform and agitate the lysis buffer by gentle rotation of the platform. Lysis of the bacterial colonies takes 12–16 hours at room temperature.
12. Transfer the filters to Petri dishes or glass trays containing TNT buffer. Incubate the filters for 30 minutes at room temperature.
13. Repeat Step 12 using fresh TNT buffer.
14. Transfer the filters, one by one, to a glass tray containing TNT buffer. Use Kimwipes to remove the residue of the colonies from the surfaces of the filters.



## Detection of Clones Expressing Fusion Protein

▲ **IMPORTANT** Do not allow the filters to dry out during any of the subsequent steps. Antibodies bound nonspecifically and reversibly to wet filters become permanently attached if the filters dry out. It is also essential that the filters do not stick to one another when they are immersed in the various buffers and antibody solutions. This problem can be minimized by dividing the filters into small batches (e.g., five filters per batch) and using a separate large Petri dish for each batch. The Petri dishes can be stacked on top of one another on a slowly rotating platform shaker.

15. When all of the filters have been rinsed, transfer them one at a time to a fresh batch of TNT buffer. After transfer, agitate the buffer and filters gently for a further 30 minutes at room temperature.

If necessary, the filters may be removed from the buffer at this stage, wrapped in Saran Wrap, and stored for up to 24 hours at 4°C.

16. Use blunt-ended forceps to transfer the filters individually to glass trays or Petri dishes containing blocking buffer (7.5 ml for each 82-mm filter, 15 ml for each 138-mm filter). When all of the filters have been submerged, agitate the buffer slowly on a rotary platform for 30 minutes at room temperature.

17. Use blunt-ended forceps to transfer the filters to fresh glass trays or Petri dishes containing the primary antibody diluted in blocking buffer (7.5 ml for each 82-mm filter, 15 ml for each 138-mm filter). Use the greatest dilution of antibody that gives acceptable background yet still allows detection of 50–100 pg of denatured antigen. When all of the filters have been submerged, agitate the solution gently on a rotary platform for 2–4 hours at room temperature.

The antibody solution can be stored at 4°C and reused several times. Sodium azide should be added to a final concentration of 0.05% (w/v) to inhibit the growth of microorganisms.

18. Wash the filters for 10 minutes in each of the buffers below in the order given. Transfer the filters individually from one buffer to the next. Use 7.5 ml of each buffer for each 82-mm filter and 15 ml for each 138-mm filter.

TNT buffer containing 0.1% bovine serum albumin

TNT buffer containing 0.1% bovine serum albumin and 0.1% Nonidet P-40

TNT buffer containing 0.1% bovine serum albumin

19. Detect the antigen-antibody complexes with the chosen radiochemical, chromogenic, or chemiluminescent reagent.

---

### RADIOCHEMICAL SCREENING

---

Use ~1  $\mu\text{Ci}$  of  $^{125}\text{I}$ -labeled protein A or immunoglobulin per filter. Radiolabeled protein A is available from commercial sources (specific activity 2–100  $\mu\text{Ci}/\mu\text{g}$ ). Radioiodinated second antibody is available commercially, or it can be prepared as described in the panel on **RADIOIODINATION OF IgG** above in Materials.

- a. Dilute radiolabeled ligands in blocking buffer (7.5 ml for each 82-mm filter, 15 ml for each 138-mm filter).
- b. Incubate the filters for 1 hour at room temperature, and then wash them several times in TNT buffer before establishing autoradiographs as described in Appendix 9.

*Continue at Step 20.*

**CHROMOGENIC SCREENING**

Antibodies coupled to horseradish peroxidase (HRP) or alkaline phosphatase (AP) that react with species-specific determinants on primary antibodies are available from commercial sources and should be used at the recommended dilution in accordance with the manufacturer's instructions. Typically, 5  $\mu$ l of conjugated antiserum is used for each 82-mm filter in 7.5 ml of blocking buffer (without sodium azide). For further details on HRP, please see the information panels in Appendix 9.

**Antigen-Antibody-Antibody-AP Complexes Located Using BCIP and NBT****Materials for Chromogenic Screening with AP-conjugated Antibodies**

*Alkaline phosphatase-conjugated anti-immunoglobulin antibodies*

*AP buffer*

100 mM Tris-Cl (pH 9.5)

100 mM NaCl

5 mM MgCl<sub>2</sub>

*5-Bromo-4-chloro-3-indolyl phosphate (BCIP)*

*Dimethylformamide <!>*

*Nitro blue tetrazolium (NBT)*

- a. Gently agitate the filters for 1.5–2 hours at room temperature in the solution of AP-conjugated antibody.
- b. Wash the filters as described in Step 18.
- c. Prepare stock solutions of BCIP (50 mg/ml in 100% dimethylformamide) and NBT (50 mg/ml in 70% dimethylformamide). These solutions are stable when stored in the dark.
- d. Prepare the BCIP/NBT developing solution just before use as follows:
  - i. Add 33  $\mu$ l of the NBT solution to 5 ml of AP buffer and mix well.
  - ii. Add 16.5  $\mu$ l of the stock solution of BCIP. Mix again. Protect the solution from strong light and use it within 1 hour.
- e. Blot the washed filters on paper towels.
- f. Incubate the filters (Step d) in the BCIP/NBT developing solution (7.5 ml for each 82-mm filter, 15 ml for each 138-mm filter) for several hours at room temperature.
- g. Rinse the filters briefly in two changes of H<sub>2</sub>O. An intense purple color will develop at the site of antigen-antibody complexes.

*Continue at Step 20.*

**Antigen-Antibody-Antibody-HRP Complexes Located Using 4-Chloro-1-Naphthol****Materials for Chromogenic Screening with HRP-conjugated Antibodies**

*4-Chloro-1-naphthol*

*H<sub>2</sub>O<sub>2</sub> (30%) <!>*

*HRP-conjugated anti-immunoglobulin antibodies*

*Methanol <!>*

*NaCl (5 M)*

*Tris-Cl (1 M, pH 7.5)*

*Tris-Cl (10 mM, pH 7.5) containing 150 mM NaCl*

- a. Gently agitate the filters for 1.5–2 hours at room temperature in the solution of HRP-conjugated antibody.
- b. Wash the filters as described in Step 18.
- c. To prepare developing solution, dissolve 60 mg of 4-chloro-1-naphthol in 20 ml of ice-cold methanol. Just before use, mix the solution with 100 ml of 10 mM Tris-Cl (pH 7.5), 150 mM NaCl containing 60  $\mu$ l of 30% H<sub>2</sub>O<sub>2</sub>.
- d. Blot the washed filters on paper towels and wash them briefly in 10 mM Tris-Cl (pH 7.5) containing 150 mM NaCl.
- e. Incubate the filters for 15–20 minutes at room temperature in the 4-chloro-1-naphthol developing solution (10 ml for each 82-mm filter, 25 ml for each 138-mm filter).
- f. Wash the filters in two changes of H<sub>2</sub>O. An intense purple color will develop at the site of antigen-antibody complexes.

Biotinylated species-specific antibodies and avidin-conjugated HRP are available from commercial sources. They should be diluted according to individual manufacturer's instructions and used for immunological screening as described above for HRP-conjugated antibodies.

*Continue at Step 20.*

---

#### CHEMILUMINESCENT SCREENING

---

Chemiluminescence is the most sensitive method for detecting immunopositive colonies. The secondary antibody is typically conjugated to either AP or HRP. Use of AP-conjugated antibodies requires substrates such as 1,2-dioxetane phosphates that emit light at a maximum wavelength of 466 nm upon dephosphorylation. HRP-conjugated antibodies oxidize the substrate luminol, which in the presence of hydrogen peroxide and phenol, emits an intense light emission with a maximum at 428 nm. With either system, the light emission can be captured by autoradiography. Chemiluminescent detection is quick, produces a permanent record of the screened filter (an X-ray film or phosphoimage), and is sensitive (1–10 pg of antigen in a colony can be detected). Two potential drawbacks are the high costs of reagents and the need to identify positives on the original agar plate by comparison to an autoradiograph. A typical protocol follows.

##### **Materials for Chemiluminescent Screening**

AP- or HRP-conjugated anti-immunoglobulin antibodies  
 Chemiluminescent substrates (commercially available from, e.g., Tropix)  
 Saran Wrap

- a. Gently agitate the filters for 1.5–2 hours at room temperature in the solution of AP- or HRP-conjugated antibody.
- b. Wash the filters as described in Step 18.
- c. Prepare the chemiluminescent substrates according to the manufacturer's instructions.
- d. Incubate the washed filters in the chemiluminescent substrates for 1–5 minutes (again, consult the manufacturer's recommendations for optimal exposure times).
- e. Drain the excess solution from the filters, and immediately wrap the filters in Saran Wrap. Do not allow the filters to dry out.
- f. Establish an autoradiogram (please see Appendix 9). Typically, the initial exposure is for 1 minute. This interval provides enough information to establish the proper exposure time.

*Continue at Step 20.*

20. Identify the locations of positive colonies or, if made, compare the duplicate filters, searching for coincident signals. For screens involving radiolabeled or chemiluminescent probes, compare the resulting autoradiograms with the agar plates on a light box. For screens involving chromogenic reagents that leave a visible positive residue on the filter, carry out the following steps.
  - a. Lay a sheet of Saran Wrap or Mylar film over the filters.
  - b. On the surface of the Saran Wrap, mark the locations of the holes in the filters and the locations of antigen-positive clones with different colored waterproof markers. Label the Saran Wrap to identify the plates from which the filters were derived.
  - c. Place the sheet of Saran Wrap on a light box, and align the plates containing the original bacterial colonies on top of it.
  - d. Identify the areas containing the positive colonies, and transfer a segment of each putative colony to 1 ml of LB medium containing the appropriate antibiotic. Incubate the cultures for 12–16 hours at the appropriate temperature.
  - e. Keep the sheet of Saran Wrap, which provides a permanent record of the locations of the positive colonies. The colored spots on the original filters fade quite rapidly.
21. Repeat the process of plating and screening until a homogeneous population of immunopositive colonies is obtained.
22. Validate the clones isolated by immunological screening using one of the methods discussed in the panel on **VALIDATION OF CLONES ISOLATED BY IMMUNOLOGICAL SCREENING** at the end of Protocol 1.

# Protocol 3

---

## Removal of Cross-reactive Antibodies from Antiserum: Pseudoscreening

**S**EVERAL METHODS CAN BE USED TO REMOVE ANTIBODIES that react with bacterial- and phage-encoded proteins from polyclonal sera:

- **Incubating the antiserum with nitrocellulose filters** to which nonrecombinant bacteriophage plaques have been transferred (this protocol).
- **Incubating the antiserum with a lysate** of *E. coli* host cells prior to screening (Protocol 4).
- **Chromatography of the antiserum** on a resin to which *E. coli* proteins have been covalently attached (Protocol 5).

It is not easy to predict which of these methods will yield the optimum antiserum for immunoscreening purposes; thus, more than one method may be required to free an antiserum of cross-reacting antibodies. For example, the adsorption method described in this protocol works only for preparations of antiserum that contain relatively low titers of anti-*E. coli* antibodies. If the treated antiserum continues to give an unacceptably high level of reaction with host components, it should be further purified by chromatography on a column that contains immobilized *E. coli* components (Protocol 5).

### MATERIALS

---

**CAUTION:** Please see Appendix 12 for appropriate handling of materials marked with <!>.

#### Buffers and Solutions

Please see Appendix 1 for components of stock solutions, buffers, and reagents. Dilute stock solutions to the appropriate concentrations.

##### *Blocking buffer*

10 mM Tris-Cl (pH 8.0)

150 mM NaCl

0.05% (v/v) Tween-20

blocking agent (1% w/v gelatin, 3% w/v bovine serum albumin, or 5% w/v nonfat dried milk)

Opinion of the relative virtues of these agents varies from laboratory to laboratory. We recommend that the investigator carry out preliminary experiments to determine which of them works best with the chosen primary and secondary antibodies. Blocking buffer can be stored at 4°C and reused several times. Sodium azide <!> should be added to a final concentration of 0.05% (w/v) to inhibit the growth of microorganisms.

## Antibodies

*Antibody preparation that is to be used for screening*

## Media

### *LB agar plates*

Each 90-mm Petri dish should contain 30–35 ml of agar medium. Each 150-mm plate should contain ~50 ml of agar medium. The plates must be dry; otherwise, the top agarose will peel off when the nitrocellulose filter is removed. Usually, 2-day-old plates that have been dried for an additional 1–2 hours at 37°C with the lids slightly open work well.

### *LB top agarose*

Melt the top agarose just before use by microwaving for a short period of time and then cooling to 47°C. Dispense the molten top agar as 3-ml aliquots (for 90-mm plates) or 7.5-ml aliquots (for 150-mm plates) in sterile tubes. Place the aliquots in a 47°C heating block or water bath to prevent the top agar from gelling.

## Special Equipment

### *Nitrocellulose filters*

Filters suitable for binding protein and immunoblotting include nitrocellulose filters free of Triton X-100 (Millipore HATF or equivalent), and supported nitrocellulose derivatives such as Hybond-C extra (Amersham Pharmacia Biotech). Nylon membranes and charged nylon membranes should not be used for immunological screening because of their poor retention of proteins and high backgrounds.

## Additional Reagents

*Step 1 of this protocol requires the reagents listed in Chapter 2, Protocol 1.*

*Step 2 of this protocol requires the reagents listed in Protocol 1 of this chapter.*

## Vectors and Bacterial Strains

### *Bacteriophage $\lambda$ vector*

Use the expression vector and bacterial strain that was used to produce the cDNA library of interest.

## METHOD

---

1. On ten LB agar plates, plate out nonrecombinant bacteriophage  $\lambda$  so as to obtain semiconfluent lysis of the bacterial lawn (please see Chapter 2, Protocol 1).
2. Prepare imprints of the lysed lawns on nitrocellulose filters as described in Steps 5–12 of Protocol 1, but omitting the treatment with IPTG.

It is not necessary to key the filters as described in Protocol 1, Step 8.
3. Dilute the preparation of antibody that is to be used for screening 1:10 with blocking buffer.
4. Incubate the filters for 6 hours with the diluted antibody. The treated antibody may be stored at 4°C in the presence of 0.05% (w/v) sodium azide until used for immunological screening.

This method can be adapted easily to remove anti-*E. coli* antibodies by pseudoscreening of bacterial colonies. On nitrocellulose filters, establish bacterial colonies that carry the empty expression vector (please see Protocol 2). Then follow the cell lysis and filter washing procedures described in Protocol 2, Steps 10–16. Finally, treat the antiserum as described in Steps 3 and 4 above.

**ALTERNATIVE PROTOCOL: ADSORBING ANTIBODIES WITH LYSATES OF BACTERIOPHAGE-INFECTED CELLS**

This method to adsorb antibodies that react with bacteriophage-encoded proteins involves incubating five strips of nitrocellulose (3 x 10 cm) in a lysate of bacteriophage-infected cells. The lysate is provided as a component of several commercially available kits that contain materials required for immunoscreening of plaques (e.g., please see Stratagene's picoBlue Immunoscreening Kit or Novagen's Phagefinder Immunoscreening Kit).

**Method**

1. Incubate five (3 x 10 cm) strips of nitrocellulose in a lysate of bacteriophage-infected cells.
2. Remove the strips from the lysate and incubate them for 1 hour at room temperature in blocking buffer.
3. Dilute 1-2 ml of the antibody preparation 1:10 in blocking buffer and incubate with one of the filters for 20 minutes at room temperature.
4. Remove the strip of nitrocellulose and replace with a fresh strip.
5. Repeat this process until all five strips have been used. The adsorbed antibody may be stored at 4°C in the presence of 0.05% (w/v) sodium azide until used for immunological screening.

# Protocol 4

---

## Removal of Cross-reactive Antibodies from Antiserum: Incubation with *E. coli* Lysate

**T**HIS PROTOCOL DESCRIBES A METHOD FOR REMOVING FROM POLYCLONAL antisera antibodies that react with bacterial-encoded proteins by incubating the antisera with a bacterial lysate. This method of adsorption only works for preparations of antisera that contain relatively low titers of anti-*E. coli* antibodies. If the treated antiserum continues to give an unacceptably high level of reaction with host components, it should be further purified by chromatography on a column that contains immobilized *E. coli* components (Protocol 5).

### MATERIALS

---

**CAUTION:** Please see Appendix 12 for appropriate handling of materials marked with <!.>.

#### Buffers and Solutions

**Please see Appendix 1 for components of stock solutions, buffers, and reagents. Dilute stock solutions to the appropriate concentrations.**

##### *Blocking buffer*

10 mM Tris-Cl (pH 8.0)

150 mM NaCl

0.05% (v/v) Tween-20

blocking agent (1% w/v gelatin, 3% w/v bovine serum albumin, or 5% w/v nonfat dried milk)

Opinion of the relative virtues of these agents varies from laboratory to laboratory. We recommend that the investigator carry out preliminary experiments to determine which of them works best with the chosen primary and secondary antibodies. Blocking buffer can be stored at 4°C and reused several times. Sodium azide <!.> should be added to a final concentration of 0.05% (w/v) to inhibit the growth of microorganisms.

##### *Cell resuspension buffer*

50 mM Tris-Cl (pH 8.0)

10 mM EDTA (pH 8.0)

Filter-sterilize and store the buffer at 4°C in 50-ml aliquots.



## Antibodies

*Antibody preparation that is to be used for screening*

## Media

*LB medium*

## Centrifuges and Rotors

*Sorvall GSA rotor or equivalent*

## Special Equipment

*Probe sonicator appropriate for sonication of bacterial cells*

## Vectors and Bacterial Strains

*E. coli strain Y1090hsdR*

This strain can be obtained from Stratagene, Life Technologies, or the ATCC ([www.atcc.org](http://www.atcc.org)).

## METHOD

---

1. Grow a 100-ml culture of *E. coli* strain Y1090hsdR to saturation in LB medium.
2. Harvest the cells by centrifugation at 5000g (5500 rpm in a Sorvall GSA rotor) for 10 minutes at 4°C.
3. Resuspend the cells in 3 ml of cell resuspension buffer. Freeze and thaw the suspension several times, and then sonicate it at full power for six periods of 20 seconds, each at 0°C.
4. Centrifuge the extract at maximum speed for 10 minutes at 4°C in a microfuge. Transfer the supernatant to a fresh tube. Store the lysate at -20°C.
5. Just before using the lysate, dilute the preparation of antibody that is to be used for screening 1:10 with blocking buffer.
6. Add 0.5 ml of lysate for every milliliter of antibody preparation to be processed. Incubate the mixture for 4 hours at room temperature on a slowly rotating wheel. The treated antibody may be stored at 4°C in the presence of 0.05% (w/v) sodium azide until used for immunological screening.

# Protocol 5

---

## Removal of Cross-reactive Antibodies from Antiserum: Affinity Chromatography

**T**HIS PROTOCOL, ADAPTED FROM DE WET ET AL. (1984), DESCRIBES A METHOD for removing antibodies that react with bacterial-encoded proteins by passing a crude preparation of immunoglobulins through an affinity matrix bound to bacterial proteins. This procedure can also be used with extracts of cultured cells or tissues to remove cross-reacting antibodies. It is of course crucial that the antigen of interest not be present in the extract attached to the column.

### MATERIALS

---

**CAUTION:** Please see Appendix 12 for appropriate handling of materials marked with <!.>.

#### Buffers and Solutions

Please see Appendix 1 for components of stock solutions, buffers, and reagents. Dilute stock solutions to the appropriate concentrations.

##### *Cell lysis buffer*

0.1 M sodium borate (pH 8.0)  
1 M NaCl

Sterilize the cell lysis buffer using a 0.45- $\mu$ m filter, and store at room temperature. Approximately 100 ml of cell lysis buffer is required per 1 liter of bacterial culture.

##### *NaOH (1 N) <!.>*

*Tris-buffered saline (TBS) and TBS containing 0.2% (w/v) sodium azide <!.>*

##### *Triton X-100*

#### Enzymes and Buffers

##### *Lysozyme*

Use a molecular biology grade of lysozyme. Add solid lysozyme to assist lysis of bacterial cells.

##### *Pancreatic DNase I*

Add solid DNase I to the bacterial cell lysate to digest chromosomal DNA.

## Antibodies

### *Antibody preparation that is to be used for screening*

This protocol works best when using an IgG fraction, prepared by chromatography of the antiserum on protein A-Sepharose. For a method of protein A-Sepharose chromatography, please see Harlow and Lane (1999).

## Media

### *Growth medium*

One liter of growth medium appropriate for the *E. coli* strain of choice is required.

## Centrifuges and Rotors

*Sorvall GSA rotor or equivalent*

*Sorvall SS-34 rotor or equivalent*

## Special Equipment

### *Chromatography column*

A 5-ml plastic syringe plugged with glass wool or a Bio-Rad Poly-Prep column is suitable.

*Cyanogen-bromide-activated Sepharose 4B (Amersham Pharmacia Biotech) or Affi-Gel 10 (Bio-Rad)*

## Vectors and Bacterial Strains

*E. coli* strain used as host for preparation of expression library

## METHOD

---

1. Grow a 1-liter culture of the appropriate strain of *E. coli* (e.g., Y1090*hsdR*, XL1-Blue, or DH1) to stationary phase.
2. Recover the bacteria by centrifugation at 4000g (5000 rpm in a Sorvall GSA rotor) for 20 minutes at 4°C.
3. Pour off the medium, and stand the centrifuge tubes in an inverted position to allow the last traces of medium to drain away.
4. Resuspend the pellet in 100 ml of cell lysis buffer.
5. Add 200 mg of lysozyme, and incubate the bacterial suspension for 20 minutes at room temperature.
6. Add 1 mg of pancreatic DNase I and 200  $\mu$ l of Triton X-100.
7. Incubate the bacterial suspension for 1 hour at 4°C, or until the turbidity clears and the viscosity decreases.
8. Centrifuge the bacterial lysate at 8000g (8200 rpm in a Sorvall SS-34 rotor) for 20 minutes at 4°C. Carefully decant the supernatant into a fresh flask.
9. Adjust the pH of the supernatant to 9.0 with 1 M NaOH.
10. Determine the concentration of protein in the lysate using the Lowry, Bradford, or other method of measurement.

11. Chill the extract to 0°C, and then bind the bacterial proteins to cyanogen-bromide-activated Sepharose 4B or to Affi-Gel 10 according to the manufacturer's instructions.
12. Before use, equilibrate the Sepharose 4B or Affi-Gel 10 resin containing conjugated *E. coli* proteins in TBS containing 0.2% (w/v) sodium azide.
13. Use 1 ml of settled volume of resin coupled to *E. coli* antigen for each milligram of IgG protein to be purified by affinity chromatography. Mix the IgG and the coupled resin and incubate for 12–18 hours at room temperature on a rotating wheel device.
14. Load the slurry into a chromatography column. Recover the antibody by washing the column with TBS. Collect fractions (0.2 column volume each) until the OD<sub>280</sub> drops to zero. Pool the fractions containing antibody, and store the pool at –20°C until it is used for immunological screening.

# Protocol 6

---

## Identifying DNA-binding Proteins in Bacteriophage $\lambda$ Expression Libraries

**C**OMPLEMENTARY DNA LIBRARIES CONSTRUCTED IN BACTERIOPHAGE EXPRESSION VECTORS can be screened with synthetic oligonucleotides to identify clones corresponding to specific DNA-binding proteins (Singh et al. 1988; Vinson et al. 1988). The methods are very similar to those used for immunological screening of expression libraries, except that the nitrocellulose filters carrying immobilized proteins are screened with  $^{32}\text{P}$ -labeled double-stranded DNA rather than with antibodies. Initially, screening was carried out with radiolabeled double-stranded DNA carrying a single binding site (Singh et al. 1988). However, under these circumstances, the signal from a positive clone was often weak and easily washed from the filter. The equilibrium association binding constants of sequence-specific DNA-binding proteins range from  $10^8$  to  $10^{12} \text{ M}^{-1}$ . Assuming that a protein has an equilibrium association binding constant of  $10^{10} \text{ M}^{-1}$  and an association rate constant of  $10^7 \text{ M}^{-1}\cdot\text{s}^{-1}$ , the dissociation rate constant of the resulting DNA-protein complex will be  $10^{-3} \text{ M}^{-1}\cdot\text{s}^{-1}$ , and its half-life will be  $\sim 10$  minutes (Singh et al. 1988; Singh 1993). Thus, only one eighth of the complexes will survive a 30-minute wash. Consequently, screening of expression libraries with double-stranded oligonucleotide probes is unlikely to be successful if the equilibrium association binding constant of the DNA-binding protein is  $<10^9 \text{ M}^{-1}$ . The problem can be alleviated by using a concatenated probe that contains multiple binding sites (Clerc et al. 1988; Staudt et al. 1988; Vinson et al. 1988). In side-by-side comparisons, a much stronger signal was generated with probes containing multiple binding sites, presumably because the probe is tethered at more than one site to the DNA-binding protein produced in the bacteriophage plaque. With concatenated probes that have been radiolabeled to a specific activity in excess of  $10^8$  cpm/ $\mu\text{g}$ , it is possible to detect as little as 1 pg of a  $\beta$ -galactosidase fusion protein that contains a DNA-binding site (Singh 1993).

Plaques generated by recombinant  $\lambda\text{gt}11$  bacteriophages typically contain 50–100 pg of fusion protein. However, only a small proportion of the protein produced by the bacteriophage-infected cells would normally be folded into a conformation suitable for binding to its DNA ligand. This situation can sometimes be improved by exposing the fusion protein briefly to denaturing agents (Vinson et al. 1988). Nitrocellulose filters carrying the fusion proteins synthesized by recombinant bacteriophages are soaked in 6 M guanidine HCl. During this process, insoluble aggregates of fusion proteins are solubilized and denatured proteins are made accessible to solvent. The denaturant is then gradually removed, potentially allowing an increased proportion of the fusion protein to refold into a conformationally active form. However, it is important to note

that exposure to denaturant is not always beneficial, apparently because some proteins are not readily renatured after treatment with guanidine HCl. A safe course of action is to first screen a set of filters containing protein imprints that have been exposed to guanidine HCl. If no clones of interest are identified, the screening should be repeated, this time using a set of protein imprints that have not been treated with guanidine HCl. In some cases, it is possible to use Southwestern blotting to find out whether the DNA-binding protein of interest will survive denaturation and renaturation. In this technique, nuclear extracts containing the protein of interest are fractionated by SDS-polyacrylamide gel electrophoresis, transferred to nitrocellulose membranes, and probed with a catenated oligonucleotide probe, before and after being exposed to a cycle of denaturation and renaturation with guanidine HCl. A positive result, in which a single polypeptide is shown to bind the relevant probe, provides encouragement to screening an expression library (Müller et al. 1988). Aliquots of the nuclear extracts, treated and untreated with guanidine HCl, can be assayed for specific DNA-binding activity in methylation protection experiments, by DNase I footprinting, or in electrophoretic mobility shift assays (please see Chapter 17).

Potentially positive plaques that react strongly with double-stranded oligonucleotide probes are picked, replated at appropriate dilutions, and retested for their ability to react with both specific and nonfunctional concatenated oligonucleotide probes. If possible, the nonfunctional probes should be generated from oligonucleotides containing base substitutions known to prevent interaction between the target protein and its binding site. The aim of the second round of screening is to identify clones encoding proteins that react with the wild-type oligonucleotide but not the mutant version of the DNA-binding site. Clones with these properties are used to generate lysogenic strains of bacteria that may be induced to synthesize large amounts of protein for use in biochemical assays. Ultimately, the functionality of the protein must be demonstrated in expression experiments in which a plasmid carrying the full-length cloned cDNA is introduced into target cells together with a plasmid containing multiple copies of the recognition sequence upstream of a basal promoter and the coding sequence of a reporter protein. The ability of the protein encoded by the cDNA to activate or repress transcription from the promoter can then be assayed by analysis of RNA extracted from the transfected cells.

Concatenated probes are usually prepared by transferring  $^{32}\text{P}$  residues to the 5'-hydroxyl termini of two complementary synthetic oligonucleotides, annealing the phosphorylated and radiolabeled DNAs, and ligating the annealed DNAs to form concatemers. Alternatively, the double-stranded concatemers may be radiolabeled by using reverse transcriptase or the Klenow fragment to catalyze template-directed addition of [ $\alpha$ - $^{32}\text{P}$ ]dNTPs to recessed 3' termini. Replica filters are prepared from a bacteriophage  $\lambda$  expression library. The radiolabeled concatemers are then used to probe the filters for plaques harboring the proteins of interest. The following protocol was provided by Steve McKnight (University of Texas Southwestern Medical Center, Dallas).

## MATERIALS

---

**CAUTION:** Please see Appendix 12 for appropriate handling of materials marked with <!>.

### Buffers and Solutions

Please see Appendix 1 for components of stock solutions, buffers, and reagents. Dilute stock solutions to the appropriate concentrations.

#### ATP (100 mM)

Make two ATP solutions, 10 mM and 50 mM, respectively, by dilution of the 100 mM stock into 25 mM Tris-Cl (pH 8.0).

**10x Binding buffer**

250 mM HEPES (pH 7.9)

30 mM MgCl<sub>2</sub>

40 mM KCl

**1x Binding buffer containing 1 mM dithiothreitol**

This solution is used to dilute full-strength denaturation solution to generate the series of washes in the protocol. Please see Steps 11–13 to calculate the volume of solution required.

**1x Binding buffer containing 1 mM dithiothreitol and 0.25% nonfat dry milk**

Approximately 75 ml of 1x binding buffer is needed per 82-mm filter screened or 180 ml per 138-mm filter. Do not scrimp on the amounts of this buffer used in the washing procedure.

**1x Binding buffer containing 5% (w/v) nonfat dry milk**

About 10 ml of this blocking solution is needed per 82-mm filter screened or 25 ml per 138-mm filter.

**1x Binding buffer containing 0.25% (w/v) nonfat dry milk**

About 10 ml of this blocking solution is needed per 82-mm filter screened or 25 ml per 138-mm filter.

**Denaturation solution (freshly made)**

Dilute 10x binding buffer (see above) with 5 volumes of distilled H<sub>2</sub>O. The resulting solution (2x binding buffer) is then added to the appropriate amount of solid guanidine HCl <math>\langle ! \rangle</math> to make a 6 M solution.

When the guanidine HCl has completely dissolved, adjust the concentration of the binding buffer to 1x with distilled H<sub>2</sub>O and add dithiothreitol to a final concentration of 1 mM. About 15 ml of full-strength (6 M) denaturation solution is needed for each 82-mm filter to be screened, or 25 ml for each 138-mm filter.

**Dithiothreitol (1 M)****EDTA (0.5 M)****Ethanol****10x Kinase/ligase buffer**

500 mM Tris-Cl (pH 7.6)

100 mM MgCl<sub>2</sub>**Phenol:chloroform (1:1, v/v) <math>\langle ! \rangle</math>****Screening buffer**

1x binding buffer

0.25% (w/v) nonfat dry milk

1 mM dithiothreitol

10  $\mu$ g/ml denatured salmon or herring sperm DNA

About 10 ml of screening buffer is needed for each 82-mm filter or 25 ml for each 138-mm filter. For preparation of denatured salmon or herring sperm DNA, please see Chapter 6, Protocol 10.

**SDS (20% w/v)****Sodium acetate (3 M, pH 5.2)****TE (pH 8.0)****Enzymes and Buffers***Bacteriophage T4 DNA ligase**Bacteriophage T4 polynucleotide kinase***Nucleic Acids and Oligonucleotides****Synthetic oligonucleotides**

Single-stranded oligonucleotides of complementary sequence, 20–25 nucleotides in length, should be purified by gel electrophoresis and Sep-Pak chromatography as described in Chapter 10, Protocol 1 and dissolved in TE (pH 7.6) at a concentration of 0.2 mg/ml. When reannealed, the central region of the oligonucleotides should form a double-stranded monomeric version of the site that has been established by gel retention or Southwestern blotting to be optimum for binding of the target protein. At least one complementary pair of “mutant” oligonucleotides is also required in the second round of screening. When annealed, the central region of the “mutant” oligonucleotide duplex should form a defective version of the optimum binding site that is unable to bind the target protein. Sequential screening with a positive probe (the optimum double-stranded binding sequence) and a negative probe (the closely related but mutated double-stranded sequence) eliminates most false positives.

Both pairs of oligonucleotides should be designed with protruding, cohesive termini that can be ligated to one another.

## Radioactive Compounds

*[ $\alpha$ -<sup>32</sup>P]ATP (10 mCi/ml, 5000 Ci/mmol) <!>*

## Gels

*Nondenaturing polyacrylamide gel <!>*

Please see Step 7.

## Special Equipment

*Adhesive labels marked with radioactive ink or chemiluminescent markers <!>*

Reusable alternatives to radioactive ink are chemiluminescent markers available from Stratagene (Glogos). The markers can be used many times and should be exposed to fluorescent light just before each new round of autoradiography.

*Baking dishes (12 × 8 inches)*

*Crystallizing dish*

*Forceps, blunt-ended*

*Needle (18-gauge) and syringe filled with waterproof black ink (India Ink)*

*Nitrocellulose filters*

*Sephadex G-75 spun column, equilibrated in TE (pH 7.6)*

*Water baths preset to 16°C, 65°C, and 85°C*

*Whatman 3MM blotting paper*

## Additional Reagents

*Steps 8 and 10 of this protocol require the reagents listed in Protocol 1 of this chapter.*

## METHOD

---

### Preparation of Radiolabeled Concatenated Probes

1. Set up two separate phosphorylation reactions, each containing one of the synthetic oligonucleotides to be annealed:

oligonucleotide	200 ng
10× kinase/ligase buffer	2.5 $\mu$ l
100 mM dithiothreitol	2.5 $\mu$ l
[ $\gamma$ - <sup>32</sup> P]ATP	100 $\mu$ Ci
H <sub>2</sub> O	to 23 $\mu$ l
bacteriophage T4 polynucleotide kinase (8–10 units/ $\mu$ l)	2 $\mu$ l

Incubate the reactions for 1 hour at 37°C.

2. Mix the two phosphorylation reactions together. Anneal the oligonucleotides by incubating the mixture in the following sequence, which is most conveniently carried out in a thermal cycler:

2 minutes at 85°C  
15 minutes at 65°C  
15 minutes at 37°C  
15 minutes at 22°C  
15 minutes at 4°C



3. Add 4  $\mu$ l of bacteriophage T4 DNA ligase (1 Weiss unit/ $\mu$ l) and 1  $\mu$ l of 50 mM ATP. Incubate the mixture for 12 hours at 16°C.
4. Add 0.5 M EDTA (pH 8.0) to a final concentration of 5 mM.
5. Separate the labeled oligonucleotides from unused [ $\gamma$ - $^{32}$ P]ATP, single-stranded oligonucleotides, and unligated double-stranded oligonucleotides by spun-column chromatography through a Sephadex G-75 column (please see Appendix 8).
6. Estimate the specific activity of the final probe.
 

The specific activity should be  $\geq 2 \times 10^6$  cpm/pmole.

It is also possible to achieve the specific activity required in this protocol by filling the recessed 3' ends of unlabeled concatenated oligonucleotides. After the ligation, set up the end-filling reaction as described in Protocol 7 of Chapter 10. Wherever possible, use two [ $\alpha$ - $^{32}$ P]dNTPs in each reaction to increase the specific activity of the radiolabeled products. At the end of the reaction, separate the labeled oligonucleotides from the unused [ $\alpha$ - $^{32}$ P]dNTPs by spun-column chromatography (please see Appendix 8).
7. Analyze the size of the radiolabeled DNA by nondenaturing polyacrylamide gel electrophoresis and autoradiography (please see Appendix 9). If all has gone well in the above annealing and radiolabeling experiment, the concatenated DNA should form a ladder of polymers of the original duplex oligonucleotide.

## Preparation of Filters

8. Prepare agar plates containing plaques of the bacteriophage  $\lambda$  expression library and numbered nitrocellulose filters exactly as described in Protocol 1, Steps 1–8.
 

Wherever possible, use an unamplified expression library. If the protein of interest is toxic to bacteria or suppresses growth of the recombinant bacteriophage, the clone may be underrepresented in amplified libraries.
9. Use blunt-ended forceps (e.g., Millipore forceps) to remove the numbered nitrocellulose filters from the lawn of plaques and place them on Whatman 3MM paper with the side exposed to the plaques facing upward. Allow the filters to dry for 15 minutes at room temperature.
10. Lay a second (numbered) filter impregnated with IPTG on each agar plate (please see Step 4 of Protocol 1). Use an 18-gauge needle to make holes in each filter in the same locations as the holes used to key the first filter to the lawn. Incubate the plates for 2 additional hours at 37°C and then remove the filters. Allow them to dry at room temperature as described in the preceding step.
 

▲ **IMPORTANT** Carry out all subsequent steps at 4°C. The first set of filters is probed directly without denaturation with guanidine HCl (i.e., omitting Steps 11–13), whereas the second set is processed as described in Steps 11–14.
11. Place the second set of numbered filters in a 12  $\times$  8-inch baking dish containing denaturation solution at 4°C. Agitate the filters gently on a platform shaker for 5 minutes at 4°C. Decant the denaturation solution, and replace it with fresh solution. Agitate the filters for an additional 5 minutes at 4°C.
12. Decant the second batch of denaturation solution into a graduated cylinder. Dilute the solution with an equal volume of 1 $\times$  binding buffer containing dithiothreitol. Pour this solution into a clean glass dish, and transfer the filters to the solution one at a time, making sure that each filter becomes thoroughly exposed to the diluted denaturation solution containing dithiothreitol.

13. Repeat the process described in Step 12 four more times, diluting the denaturation solution by a factor of 2 each time. The concentrations of guanidine HCl in the solutions are therefore 3 M (Step 11), 1.5 M, 0.75 M, 0.375 M, 0.187 M, and 0.094 M. Finally, wash the filters twice in 1× binding buffer containing dithiothreitol.
14. Place both sets of numbered filters (i.e., denatured and nondenatured) in 1× binding buffer containing 5% nonfat dried milk. Agitate the filters gently for 30 minutes at 4°C.
15. Rinse the filters in 1× binding buffer containing 0.25% nonfat dried milk.

### Probing of Immobilized Proteins with Radiolabeled DNA

16. In a crystallizing dish, add the <sup>32</sup>P-labeled concatenated DNA probe from Step 5 to screening buffer to make a hybridization solution (~10 ml for each 82-mm filter or ~25 ml for each 138-mm filter).

Optimal results are usually obtained when the final concentration of radiolabeled probe (specific activity  $2 \times 10^8$  to  $5 \times 10^8$  cpm/ $\mu$ g) in the screening reaction is ~25 ng/ml. However, concentrations as low as 2.5 ng/ml can be used if the amount of probe is limiting.

In the original description of this method (Singh et al. 1988), poly(dI:dC) was used as a nonspecific competitor. However, lower backgrounds are generally achieved when sonicated, denatured salmon sperm or calf thymus DNA is used. It is possible that the presence of some DNA binding-fusion proteins will be masked by any DNA, synthetic or complex, that is used as a competitor. Sensitivity to various blocking reagents such as salmon sperm DNA, poly(dI:dC), poly(A), and others should be established in gel retardation assays or Southwestern blotting (please see Chapter 17) before cDNA screening.

17. Transfer the filters to the radiolabeled probe solution in the crystallizing dish. Incubate the filters with gentle agitation on a rotating platform for 2–12 hours at 4°C.

The ionic composition of the binding/screening buffer used here is suitable for many DNA-protein interactions. However, in some cases, it may be necessary to adjust the concentrations of salt and magnesium ions to conform to the optimal conditions for binding established in gel retardation assays or other methods. An alternative to the binding buffer recommended here is a buffer containing 25 mM HEPES (pH 7.9)/25 mM NaCl/5 mM MgCl<sub>2</sub>/0.5 mM DTT (Singh 1993).

18. Wash the filters for 5 minutes at 4°C in a large volume (25 ml for each 82-mm filter, 60 ml for each 138-mm filter) of binding buffer containing 1 mM dithiothreitol and 0.25% nonfat dried milk.
19. Repeat Step 18 twice more.

20. Decant the final wash buffer. Arrange the damp filters on a sheet of Saran Wrap. Cover the filters with another sheet of Saran Wrap. Apply adhesive labels marked with radioactive ink or chemiluminescent markers to several asymmetric locations on the Saran Wrap.

Cover the radioactive labels with Scotch Tape to prevent contamination with the radioactive ink of the film holder or intensifying screen.

21. Establish an autoradiograph as described in Appendix 9.
22. Pick positive plaques, and rescreen them with specific and nonspecific probes as discussed in the introduction to this protocol.

Filters may be reprobbed for other DNA-binding protein cDNAs by repeating the denaturation/renaturation cycle (Steps 11–13), which effectively removes the probe from the filters.

# Protocol 7

---

## Preparation of Lysates Containing Fusion Proteins Encoded by Bacteriophage $\lambda$ Lysogens: Lysis of Bacterial Colonies

THE ISOLATION OF RECOMBINANT BACTERIOPHAGES ENCODING FUSION PROTEINS that bind to an antibody, a double-stranded oligonucleotide, or other type of ligand is just the first step in the cloning of cDNAs that code for an enzyme, structural protein, or transcription factor of interest. Additional experiments are required to ensure that the desired protein has been identified. The next steps in the expression cloning process are production of the fusion protein and testing of the expressed protein for unique properties such as DNA binding, enzymatic activity, or immunological specificity. Fusion proteins can be produced following the formation of bacteriophage  $\lambda$  lysogens (this protocol) or after lytic infection of an *E. coli* host (Protocols 8 and 9). In the former method, a bacteriophage lysogen is constructed from the recombinant bacteriophage  $\lambda$  expressing the fusion protein of interest. The resulting colonies are induced to synthesize the fusion protein, which is isolated from the lysogen, and then subjected to further functional and biochemical analyses. This method has three advantages over the lytic infection of a bacterial host:

- $\lambda$ gt11 genomes inherited as part of the host-cell chromosome may be more genetically stable than genomes propagated by lytic infection.
- The repression of synthesis of potentially toxic fusion proteins may be more complete in cells containing only one integrated copy of the recombinant genome rather than in lytically infected cells that rapidly accumulate many hundreds of copies of the fusion gene.
- The amount of fusion protein produced in a lysogenic colony is at least 10 times greater than in a bacteriophage  $\lambda$  plaque (Mutzel et al. 1990).

Lysogens do, however, have two drawbacks. The formation and induction of lysogens requires several days to complete, and, for unknown reasons, a small minority of bacteriophage  $\lambda$  recombinants are unable to form stable lysogens (Huynh et al. 1985).

Bacteriophage  $\lambda$  vectors  $\lambda$ gt11,  $\lambda$ gt18-23,  $\lambda$ ZAP, and  $\lambda$ ZipLox carry a mutation (*cI*ts857) that renders the repressor encoded by the viral *cI* gene thermosensitive. At 42°C, where the *cI*ts857 repressor is only partially functional (Lieb 1979), these vectors (and recombinants derived from them) form plaques on strains of *E. coli* (such as Y1090*hsdR*) that carry the amber suppressor *supF*. At temperatures where the repressor is active (32°C), these bacteriophage strains can also form lysogens (Young and Davis 1983b). Such lysogens can be stably maintained as prophage only when lysogenic cultures are carried out at 32°C. Lytic development of bacteriophage begins immediately after the temperature is raised (Sussman and Jacob 1962).

After a recombinant  $\lambda$ gt11 that synthesizes a fusion protein of interest has been identified, lysogens are established from which preparative amounts of the recombinant protein can be

obtained. Because the foreign cDNA sequence is fused to the carboxyl terminus of  $\beta$ -galactosidase, the standard method involves production of lysogens in *E. coli* strain Y1089 and induction of the *lacZ* fusion protein by IPTG (Mierendorf et al. 1987). Alternatively, fusion proteins can be prepared from liquid (Runge 1992) or plate cultures (Huang and Jong 1994) of strain Y1090 that have been lytically infected with high multiplicities of the recombinant bacteriophage. In the following protocol, modified from Snyder et al. (1987), Singh et al. (1989), and Singh (1993), lysogens of individual recombinant bacteriophages are generated at 32°C and then exposed briefly to high temperature (44°C), which inactivates the thermolabile repressor and induces a round of lytic bacteriophage infection (for more details, please see the introduction to Chapter 2). Synthesis of the fusion protein encoded by the recombinant bacteriophage is induced by treating the cells with IPTG.

## MATERIALS

---

**CAUTION:** Please see Appendix 12 for appropriate handling of materials marked with <!>.

### Buffers and Solutions

Please see Appendix 1 for components of stock solutions, buffers, and reagents. Dilute stock solutions to the appropriate concentrations.

#### *IPTG (1 M)*

Approximately 40  $\mu$ l of 1 M IPTG is required per lysogen induced.

#### *Lysogen extraction buffer*

50 mM Tris-Cl (pH 7.5)

1 mM EDTA (pH 8.0)

5 mM dithiothreitol

50  $\mu$ g/ml phenylmethylsulfonyl fluoride (PMSF) <!>

Add PMSF to the lysogen extraction buffer just before it is used in Steps 13 and 18. Approximately 100 ml of lysogen extraction buffer is needed per 20 lysogens induced.

#### *NaCl (5 M)*

Store the solution of NaCl at 4°C.

### Enzymes and Buffers

#### *Lysozyme (10 mg/ml)*

Dissolve solid lysozyme (molecular biology grade) at a concentration of 10 mg/ml in 10 mM Tris-Cl (pH 8.0). This solution should be freshly prepared for use in Step 15.

### Media

*LB agar plates containing 50  $\mu$ g/ml ampicillin*

*LB medium*

*LB medium containing 50  $\mu$ g/ml ampicillin*

*LB medium containing 10 mM MgCl<sub>2</sub>*

*LB medium containing 10 mM MgCl<sub>2</sub>, 0.2% (w/v) maltose, and 50  $\mu$ g/ml ampicillin*

### Special Equipment

*Air incubators preset to 32°C and 42°C*

*Liquid nitrogen <!>*

*Millipore filter(s)*

Circular 138-mm filters (Millipore type VS, 0.025- $\mu$ m pore size filters) are used to dialyze the lysates. As many as 20 lysates can be dialyzed per filter.

*Shaking water bath preset to 44°C*

A static H<sub>2</sub>O bath set at 44°C will usually suffice if a shaking water bath is not available.

*Toothpicks or Inoculating loops*

## Additional Reagents

Step 1 of this protocol requires the reagents listed in Chapter 2, Protocol 3.

## Vectors and Bacterial Strains

### Bacteriophage $\lambda$ gt11, $\lambda$ gt18-23, $\lambda$ ZAP, and $\lambda$ ZipLox recombinant

This protocol has been optimized for a bacteriophage  $\lambda$ gt11 recombinant that expresses a recombinant fusion protein (identified by methods outlined in Protocol 1 or 6 or by hybridization and DNA sequence analysis). Recombinants constructed in many other bacteriophage  $\lambda$  expression vectors can be used to establish lysogens essentially as described here.

### *E. coli* strains Y1090*hsdR* and Y1089

These strains, which are available from the ATCC (www.atcc.org), are maintained on LB agar plates containing 50  $\mu$ g/ml ampicillin. The Y1090 and Y1089 strains carry mutations in the *lon* gene, which encodes an ATP-dependent protease. Fusion proteins expressed in these strains are often more stable than those expressed in strains lacking this mutation. Y1089 carries the *hflA* mutation, which dramatically increases the frequency of lysogenization by bacteriophage  $\lambda$ . In addition, Y1089 lacks a suppressor tRNA gene; thus, the amber mutation in the *S* gene (lysis gene) of  $\lambda$ gt11 is not suppressed in this strain, allowing large amounts of bacteriophage- $\lambda$ -encoded gene products (including LacZ fusion proteins) to accumulate to high levels within an induced cell. For additional information on *E. coli* strains Y1090 and Y1089, please see the information panel on **PLASMID AND BACTERIOPHAGE  $\lambda$  EXPRESSION VECTORS**.

## METHOD

1. Make a plate stock of each of the recombinant bacteriophage(s) of interest using the methods described in Chapter 2, Protocols 2–3. The titer of the stocks, measured on *E. coli* strain Y1090*hsdR*, should be  $>10^{10}$  pfu/ml.
2. Grow a 2-ml culture of *E. coli* strain Y1089 to saturation in LB medium containing 10 mM MgCl<sub>2</sub>, 0.2% maltose, and ampicillin (50  $\mu$ g/ml).
3. Dilute 50  $\mu$ l of the saturated culture with 2 ml of LB medium containing 10 mM MgCl<sub>2</sub>. Transfer four 100- $\mu$ l aliquots of the diluted culture to fresh culture tubes.
4. To each of three of the tubes, add  $1 \times 10^7$ ,  $5 \times 10^7$ , and  $2 \times 10^8$  plaque-forming units of the bacteriophage stock. The fourth tube should receive no bacteriophage. Incubate all four tubes for 20 minutes at 37°C to allow virus attachment.
5. Dilute 10  $\mu$ l of each of the four cultures with 10 ml of LB medium. Immediately plate aliquots (100  $\mu$ l) of each of the four diluted cultures onto LB agar plates containing 50  $\mu$ g/ml ampicillin. Incubate the plates for 18–24 hours at 32°C.
 

A lawn of cells should appear on the plates inoculated with the uninfected culture of *E. coli* Y1089. Infected cultures should give rise to 50–500 colonies, depending on the density of the original saturated culture and on the exact multiplicity of bacteriophage infection.
6. Use sterile toothpicks or inoculating loops to transfer a series of individual colonies onto two LB plates that contain 50  $\mu$ g/ml ampicillin. Incubate one plate at 32°C and the other plate at 42°C for 12–16 hours. Clones that give rise to colonies at 32°C but not at 42°C are lysogenic for recombinant bacteriophage  $\lambda$ gt11. Usually, 10–70% of the colonies tested are lysogens.
7. Inoculate 2 ml of LB medium containing 50  $\mu$ g/ml ampicillin with individual bacteriophage  $\lambda$ gt11 lysogens. Grow the cultures for 12–16 hours at 32°C with vigorous agitation (300 cycles/minute in a rotary shaker).
8. Add 50  $\mu$ l of each culture to 4 ml of prewarmed (32°C) LB medium containing 50  $\mu$ g/ml ampicillin. Continue incubation at 32°C with vigorous agitation.

9. Grow the cultures until the  $OD_{600} = 0.45$  (~3 hours of incubation).

▲ **IMPORTANT** The  $OD_{600}$  of the cultures should not exceed 0.5 ( $\sim 2 \times 10^8$  bacteria/ml) before induction of the lysogens.

10. Transfer the cultures to a shaking water bath equilibrated to 44°C. Incubate the cultures for 15 minutes at 44°C.

The maximal efficiency of induction is obtained by rapidly raising the temperature from 32°C to 44°C. It is therefore preferable to transfer the cultures to a water bath set at 44°C rather than to a hot-air incubator. Shake the cultures vigorously from time to time during incubation at 44°C, if using a static water bath.

Heating to these temperatures only partially inactivates the *clts857* repressor, which can also renature when the culture is cooled to 37°C (Mandal and Lieb 1976). However, the concentration of repressor is too low to prevent synthesis of Cro protein, which binds to OR3 and prevents further synthesis of the repressor. After heating, the culture becomes irretrievably committed to a cycle of lytic bacteriophage growth.

11. Add IPTG to each culture to a final concentration of 10 mM, and then incubate the cultures for 1 hour at 37°C with vigorous agitation.
12. Transfer 1.5-ml aliquots of each of the induced lysogenic cultures to two microfuge tubes. Immediately centrifuge the tubes at maximum speed for 30 seconds at 4°C in a microfuge.
13. Remove the medium by aspiration, and then rapidly resuspend the bacterial pellets by vortexing in 100  $\mu$ l of lysogen extraction buffer.
14. Close the caps of the tubes, and place the tubes in liquid nitrogen.
15. After 2 minutes, recover the tubes from the liquid nitrogen. Hold the tubes in one hand to warm them until the lysates just thaw, and then immediately add to each tube 20  $\mu$ l of 10 mg/ml lysozyme. Store the tubes for 15 minutes in an ice bath.
16. Add 250  $\mu$ l of 5 M NaCl to each tube. Mix the contents by flicking the side of each tube with a finger. Incubate the tubes for 30 minutes at 4°C on a rotating wheel.
17. Centrifuge the tubes at maximum speed for 30 minutes at 4°C in a microfuge.
18. Float a Millipore filter (Type VS, 0.025- $\mu$ m pore size) on the surface of a Petri dish (150 mm) filled with lysogen extraction buffer at 4°C.

This step is best carried out in a corner of a cold room away from drafts. Take care that no lysogen extraction buffer spills over onto the upper surface of the filter.

19. Transfer the supernatants from the centrifuge tubes to the upper surface of the filter. Up to 20 different samples can be applied to the same filter.
20. After 1–2 hours at 4°C, transfer the dialyzed samples to fresh microfuge tubes, which can be stored at –70°C until needed.
21. Analyze the cell lysates directly for the presence of DNA-binding proteins, for example, in methylation protection experiments, by DNase I footprinting, or in gel electrophoresis DNA-binding assays (electrophoretic mobility-shift assays) (please see Chapter 17).

Fusion proteins can be purified using commercially available affinity chromatography kits (e.g., ProtoSorb LacZ immunoaffinity absorbent, Promega) or as described in Chapter 15.

Crude lysates or purified fusion protein can be assayed for the presence of an enzyme activity associated with the foreign protein or for immunochemical cross-reactivity by immunoblotting.

Purified fusion proteins can be used to raise antibodies against the foreign protein, which in turn can be used to confirm the identity of a suspected cDNA-encoded protein (by tissue surveys or analysis of partially purified fractions), to inhibit an enzyme activity, or to purify the native foreign protein by affinity chromatography.

# Protocol 8

---

## Preparation of Lysates Containing Fusion Proteins Encoded by Bacteriophage $\lambda$ : Lytic Infections on Agar Plates

**F**USION PROTEINS ENCODED BY BACTERIOPHAGE  $\lambda$  RECOMBINANTS are generally prepared from lysogenic colonies of *E. coli* strain 1089. However, the production of lysogens from large numbers of individual plaques can be tiresome and may not be successful in every case (Huynh et al. 1985). As an alternative, a lytic bacteriophage infection can be established either in soft agarose (this protocol) or in liquid culture (Protocol 9). Following induced expression, the fusion protein can be recovered from the infected bacterial cells.

In general, these protocols are more versatile, require less IPTG, and yield more fusion protein than induced bacterial lysogens. However, they require a greater amount of recombinant bacteriophage than is needed to establish lysogens. In addition, greater accumulation of the fusion protein in the host cells may, in rare cases, disrupt lytic expression systems. This protocol was adapted from Huang et al. (1989) and Huang and Jong (1994).

---

### MATERIALS

---

#### Buffers and Solutions

**Please see Appendix 1 for components of stock solutions, buffers, and reagents. Dilute stock solutions to the appropriate concentrations.**

*Control overlay solution (6 ml required for each recombinant plaque analyzed)*

10 mM  $\text{MgSO}_4$   
0.5x LB medium

For an LB medium recipe, please see Appendix 2. After autoclaving the 0.5x medium, supplement it with 1 M  $\text{MgSO}_4$  to bring its final concentration to 10 mM. For each 150-mm agar plate, 6 ml of IPTG overlay solution is required.

*IPTG overlay solution (12 ml required for each recombinant plaque analyzed)*

0.5x LB medium  
5 mM IPTG  
10 mM  $\text{MgSO}_4$

For an LB medium recipe, please see Appendix 2. After autoclaving the 0.5x medium, supplement it with 1 M IPTG (2.38 g of IPTG in a final volume of 10 ml of sterile  $\text{H}_2\text{O}$ ) and 1 M  $\text{MgSO}_4$  (24.6 g of  $\text{MgSO}_4 \cdot 7\text{H}_2\text{O}$  in a final volume of 100 ml of sterile  $\text{H}_2\text{O}$ ) to bring their final concentrations to 5 and 10 mM, respectively. For each 150-mm agar plate, 12 ml of IPTG overlay solution is required.

$\text{MgSO}_4 \cdot 7\text{H}_2\text{O}$  (1 M)

SM

## Media

*LB agar plates (150 mm)*

Freshly poured plates that have been equilibrated to room temperature give the best results.

*LB medium containing 50 µg/ml ampicillin*

*LB top agarose containing 10 mM MgSO<sub>4</sub> and 50 µg/ml ampicillin*

## Centrifuges and Rotors

*Sorvall SS-34 rotor or equivalent*

## Special Equipment

*Air incubator preset to 4°C*

## Vectors and Bacterial Strains

*Bacteriophage λgt11 recombinant*

Prepare a stock of recombinant bacteriophage λ of known titer by soaking an individual plaque in ~100 µl of SM for at least 2 hours at room temperature or by preparing a plate lysate (please see Chapter 2, Protocol 3).

*E. coli strain Y1090hsdR*

This strain is available from the ATCC ([www.atcc.org](http://www.atcc.org)) and is maintained on LB agar plates containing 50 µg/ml ampicillin. The strain carries a mutation in the *lon* gene, which encodes an ATP-dependent protease. Fusion proteins expressed in this strain are often more stable than those expressed in strains lacking this mutation.

## METHOD

---

1. Inoculate 50 ml of LB medium containing 50 µg/ml ampicillin with a single colony of *E. coli* Y1090hsdR. Grow the culture overnight at 37°C with moderate agitation (250 cycles/minute in a rotary shaker).
2. Transfer the culture to a centrifuge tube, and centrifuge the cells at 4000g (5800 rpm in a Sorvall SS-34 rotor) for 10 minutes at room temperature.
3. Discard the supernatant, and resuspend the cell pellet in 20 ml of 10 mM MgSO<sub>4</sub>. Measure the OD<sub>600</sub> of a 1/100 dilution of the resuspended cells and prepare a plating stock by diluting the resuspended cells to a final concentration of 2.0 OD<sub>600</sub>/ml with 10 mM MgSO<sub>4</sub>.
4. Transfer three 0.2-ml aliquots of the plating stock of *E. coli* Y1090hsdR to fresh tubes. To two of the tubes, add 2 × 10<sup>5</sup> to 5 × 10<sup>6</sup> pfu of the recombinant bacteriophage λgt11 stock. The third tube serves as an uninfected control. Incubate the tubes for 20 minutes at 37°C to allow the virus to attach to the cells.
5. Add 7.5 ml of molten LB top agarose containing 10 mM MgSO<sub>4</sub> and 50 µg/ml ampicillin to one of the tubes. Mix the contents, and immediately pour the top agarose onto a 150-mm LB agar plate.
6. Repeat Step 5 with each of the remaining tubes.
7. Incubate the agar plates for 4 hours at 42°C.
8. Remove the plates from the incubator. Add 6 ml of control overlay solution to one of the infected plates. Add 12 ml of IPTG overlay solution to the two remaining plates.
9. Return the plates to the 42°C incubator for 3–5 hours.



10. Remove the plates from the incubator and transfer the overlay solutions into individual sterile tubes.

The fusion protein is released from infected cells at the point of lysis and diffuses into the overlay solution. Most of the bacterial debris remains in the agarose and does not contaminate the overlay solution.

As much as 200 µg of fusion protein can be produced per 150-mm plate. According to Huang and Jong (1994), the induction process can be repeated as many as five times on each plate, although maximum expression is obtained in the first two inductions. Repeat inductions are carried out by removing the protein-infused overlay solution, allowing the plate to recover for 1 hour at 37°C, followed by addition of fresh overlay solution.

In a variation of this protocol (Lillibrige and Philipp 1993), the recombinant phage expressing the desired fusion protein is used to form a large "maxiplate" on a lawn of *E. coli*. The plaque and underlying agar are cored from the plate, dounced in a homogenizer, and resuspended in 2× SDS-loading buffer for polyacrylamide gel electrophoresis and immunoblotting. Starting with a plaque, their procedure requires ~6.5 hours to reach the stage of gel electrophoresis.

11. Detect the fusion protein in the overlay solution by immunoblotting or by DNA-binding assays if the original phage was isolated as described in Protocol 6.

No immunological reactivity or DNA-binding activity should be detected in the overlay solution derived from the uninfected culture or in the overlay solution from which IPTG was omitted.

For assays involving the detection of enzyme activity, overlay solutions can be dialyzed against an appropriate buffer before analysis.

12. Purify the β-galactosidase fusion protein from the overlay solution by affinity chromatography using commercially available kits (e.g., Promega ProtoSorb), or as described in Chapter 15, Protocol 1. Dialyze the overlay solution before purification of the protein to remove IPTG.

# Protocol 9

---

## Preparation of Lysates Containing Fusion Proteins Encoded by Bacteriophage $\lambda$ : Lytic Infections in Liquid Medium

**T**HIS RAPID METHOD IS USED TO SCREEN BACTERIOPHAGE  $\lambda$ GT11 RECOMBINANTS for the production of immunodetectable fusion proteins. However, with some effort (i.e., optimization of the multiplicity of infection ratio, inactivation of the bacteriophage  $\lambda$ cI gene at 42°C, and harvesting just before lysis), the method can be used to produce preparative amounts of a fusion protein (Runge 1992).

For an assessment of the merits of expressing protein fusions in lytic versus lysogenic cultures, and in liquid versus solid medium, please see the introductions to Protocols 7 and 8.

### MATERIALS

---

**CAUTION:** Please see Appendix 12 for appropriate handling of materials marked with <!.>.

#### Buffers and Solutions

Please see Appendix 1 for components of stock solutions, buffers, and reagents. Dilute stock solutions to the appropriate concentrations.

*Cell lysis buffer (100  $\mu$ l required for each plaque analyzed)*

- 50 mM Tris-Cl (pH 6.8)
- 100 mM dithiothreitol
- 2% (w/v) SDS
- 0.1% (w/v) bromophenol blue
- 10% (v/v) glycerol

*IPTG (1 M) (70  $\mu$ l required for each plaque analyzed)*

*MgSO<sub>4</sub>·7H<sub>2</sub>O (1 M)*

*Phenylmethylsulfonyl fluoride (PMSF) (100 mM) <!.>*

*SM*

Discard each aliquot after use to minimize contamination.

#### Gels

*SDS-polyacrylamide gel <!.>*

Please see Step 12.

## Media

LB medium containing 50 µg/ml ampicillin

## Centrifuges and Rotors

Sorvall SS-34 rotor or equivalent

## Special Equipment

Boiling-water bath

Liquid nitrogen <math>\langle ! \rangle</math>

## Vectors and Bacterial Strains

Bacteriophage  $\lambda$ gt11 recombinant

Prepare stocks of bacteriophage  $\lambda$  recombinants by soaking individual plaques in ~1 ml of SM for at least 2 hours at room temperature or by preparing a plate lysate (please see Chapter 2, Protocol 3).

*E. coli* strain Y1090hsdR

This strain is available from the ATCC ([www.atcc.org](http://www.atcc.org)). For information on *E. coli* strain Y1090, please see the information panel on **PLASMID AND BACTERIOPHAGE  $\lambda$  EXPRESSION VECTORS**.

## METHOD

---

1. Inoculate 50 ml of LB medium containing 50 µg/ml ampicillin with a single colony of *E. coli* Y1090hsdR. Grow the culture overnight at 37°C with moderate agitation (250 cycles/minute in a rotary shaker).
2. Transfer the culture to a centrifuge tube, and centrifuge the cells at 4000g (5800 rpm in a Sorvall SS-34 rotor) for 10 minutes at room temperature.
3. Discard the supernatant, and resuspend the cell pellet in 25 ml of 10 mM MgSO<sub>4</sub>. Store the bacterial suspension on ice until required.
4. In sterile 15-ml tubes, mix 8 ml of LB containing 50 µg/ml ampicillin, 400 µl of bacterial suspension, and 100 µl of phage lysate.

Because the fusion protein is isolated from the infected cells themselves rather than from the lysate (as in Protocol 8), it is important to obtain a productive infection with the  $\lambda$ gt11 phage of interest while avoiding premature lysis of the culture. For this reason, low multiplicities of infection (~1 pfu per 16,000 cells) are used in the procedure.
5. Place the tubes in a 37°C shaking water bath for 2 hours.
6. Transfer a 1-ml aliquot of each culture of infected cells to a sterile microfuge tube. Store the tightly capped tubes in liquid nitrogen. Add 70 µl of 1 M IPTG to the remainder of the infected cultures and continue the incubation at 37°C.
7. At hourly intervals thereafter, withdraw 1-ml aliquots of each culture of infected cells to microfuge tubes. Store the tightly capped tubes in liquid nitrogen. Collect aliquots in this fashion for a period of 4 hours.
8. Incubate the remainder of the infected cultures for a further 12 hours at 37°C. Remove a final 1-ml sample from each culture. Place the tightly capped tubes in liquid nitrogen for 30 minutes.

9. Thaw all the samples and collect the infected bacteria by centrifugation at maximum speed for 1 minute at room temperature in a microfuge. Decant and discard the bacterial medium.
10. Add 100  $\mu$ l of cell lysis buffer to each tube and rapidly resuspend the cell pellets by vigorous vortexing.
11. Place the samples in a boiling-water bath for 3 minutes. Transfer the samples to room temperature, add 1  $\mu$ l of 100 mM PMSF, and mix the contents of the tubes by vortexing.
12. Analyze the samples directly by SDS-polyacrylamide gel electrophoresis and immunoblotting. Just before electrophoresis, spin the samples at maximum speed for 1 minute in a microfuge. Load a 25- $\mu$ l aliquot of the supernatant from this spin onto the SDS-polyacrylamide gel.

Alternatively, the samples may be stored at  $-70^{\circ}\text{C}$  before analysis.

The amount of the fusion protein of interest should increase progressively in the samples of cultures treated with IPTG for 1–4 hours. Thereafter, the amount of protein may increase, remain the same, or decrease depending on whether the infected cells lyse and release protein into the medium.

---

**PLASMID AND BACTERIOPHAGE  $\lambda$  EXPRESSION VECTORS**

---

Expression libraries can be constructed in plasmid or bacteriophage  $\lambda$  vectors that carry a strong, regulated prokaryotic promoter and a ribosome-binding site. A few vectors are available that express only the sequences of the foreign protein (please see Chapter 15 and Table A3-1 in Appendix 3). More commonly, however, the foreign DNA sequences are cloned into a restriction site that lies within the coding sequences of a prokaryotic or eukaryotic gene (or fragment of a gene) located immediately downstream from the prokaryotic promoter/ribosome-binding site. In many vectors, this gene is *E. coli lacZ*, which encodes  $\beta$ -galactosidase. If the foreign sequences are inserted in the correct orientation and reading frame, a fusion protein is produced that consists of  $\beta$ -galactosidase sequences linked to polypeptide sequences encoded by the cloned DNA. The fusion protein, which is synthesized upon induction of the *lac* promoter with isopropyl- $\beta$ -thiogalactoside, may retain or lose  $\beta$ -galactosidase activity or the ability to take part in  $\alpha$ -complementation (please see Chapter 1), depending on the nature of the foreign sequences and the site at which they are inserted. Insertion of foreign sequences into  $\beta$ -galactosidase, or into other proteins such as maltose-binding protein, thioredoxin, or the glutathione-S-transferase of *Schistosoma japonicum*, often enhances the stability of the fusion protein in the host bacterium (Kupper et al. 1981; Stanley 1983; di Guan et al. 1988; Smith and Johnson 1988; LaVallie et al. 1993).

Expression libraries constructed in bacteriophage  $\lambda$  and plasmid vectors differ from one another in one major respect. Libraries constructed in bacteriophage  $\lambda$  vectors are plated on a bacterial lawn, which is progressively lysed during the next few hours as a natural consequence of bacteriophage growth. The resulting debris is transferred to nitrocellulose filters and screened for the presence of immunoreactive material. By contrast, plasmid libraries are maintained as transformed bacterial colonies that must be lysed in situ on nitrocellulose filters before intracellular fusion proteins can be screened with antibodies or other ligands. Expression libraries constructed in plasmids therefore suffer from a significant disadvantage: the labor involved in generating the replicas of the library that are used for immunological screening. Usually, master copies of plasmid libraries are grown on nitrocellulose filters, and several replicas are then generated by transferring the colonies in situ to fresh nitrocellulose filters (please see Protocol 2). This is a laborious process that can be repeated only a few times before the colonies on the master filter become smeared beyond recognition. Colonies growing on the replica filters are lysed and screened with a labeled ligand specific for the gene product of interest. Clones that react with the labeled ligand are recovered from the master filter and analyzed further. Although these procedures are easy to accomplish when only a few clones are to be screened, they are logistically demanding when large libraries consisting of  $10^6$  or more colonies are to be screened. For most purposes, therefore, bacteriophage expression vectors are the vehicles of choice for immunological screening of large libraries.

The vast majority of cDNA expression libraries are constructed in bacteriophage  $\lambda$ gt11, its close relatives  $\lambda$ gt18-23,  $\lambda$ ZAP (or the  $\lambda$ ZAP Express or  $\lambda$ ZAPII derivatives),  $\lambda$ ZipLox, or  $\lambda$ ORF8. These bacteriophages carry one of two modified *E. coli lacZ* genes.  $\lambda$ gt11 and  $\lambda$ ORF8 contain a complete copy of the *lacZ* gene with a cloning site located 53 bp upstream of the translational termination codon. cDNAs inserted in the correct orientation and reading frame are expressed to yield fusion proteins whose amino termini consist of  $\beta$ -galactosidase sequences and whose carboxyl termini consist of foreign sequences. Vectors such as  $\lambda$ ZipLox and  $\lambda$ ZAP contain a fragment of the *lacZ* gene spanning the promoter-operator and the amino-terminal encoding region (Ullmann et al. 1967). cDNAs inserted into the polylinker are expressed as a fusion protein consisting of the amino-terminal 6 amino acids of  $\beta$ -galactosidase followed by carboxy-terminal foreign sequences. With both types of vectors, some of the foreign sequences display antigenic epitopes that can be detected using specific antibodies.

Bacteriophage  $\lambda$  vectors used for the construction of expression libraries usually ( $\lambda$ ORF8 is an exception) have a mutant copy of the  $\lambda$  repressor gene (*cls857*), which encodes a temperature-sensitive repressor protein, and they carry an amber mutation in the *S* (lysis) gene. At temperatures that inactivate the repressor (42°C), these bacteriophage form plaques on strains of *E. coli* (such as Y1090*hsdR*) that carry an amber suppressor (*supF*). Strain Y1090*hsdR* displays additional properties that are useful in immunological screening: It carries a plasmid (pMC9) that encodes the *lac* repressor, and it is deficient in the product of the *lon*

gene, an ATP-dependent endoprotease (for review, please see Gottesman and Maurizi 1992). The absence of a functional *lon* protease extends the half-life of many  $\beta$ -galactosidase fusion proteins. A related strain of *E. coli*, Y1089, in addition to the *lon* mutation, also carries a mutation in *hflA*, which dramatically increases the frequency of lysogenization by bacteriophage  $\lambda$ . In addition, because Y1089 lacks a suppressor tRNA gene, the amber mutation in the *S* gene (lysis gene) of  $\lambda$ gt11 is not suppressed, allowing large amounts of bacteriophage  $\lambda$ -encoded gene products (including *lacZ* fusion proteins) to accumulate to high levels within an induced cell. For further details of the properties of  $\lambda$ gt11,  $\lambda$ gt18-23,  $\lambda$ ZAP,  $\lambda$ ZipLox, and  $\lambda$ ORF8, please see the introduction to Chapter 11 and Appendix 3.

Libraries of bacteriophage  $\lambda$  established as lysogens in *E. coli* host strain Y1090 offer potential advantages for screening of expression libraries:  $\lambda$  genomes inherited as part of the host-cell chromosome may be more stable genetically than genomes propagated by lytic infection, and the repression of synthesis of potentially toxic fusion proteins may be more complete in cells containing only one integrated copy of the recombinant genome than in lytically infected cells that rapidly accumulate many hundreds of copies of the fusion gene. Expression of fusion protein in a lysogenic colony can be as much as 20 times higher than the 0.25 fmole of target protein typically expressed in a bacteriophage plaque (Lacombe et al. 1987). Despite these apparent advantages, most libraries constructed in  $\lambda$ gt11 are no longer propagated as lysogens nor screened after induction because some recombinants are unable to form stable lysogens (Huynh et al. 1985). The increased amounts of fusion protein synthesized in induced lysogens are rarely of practical advantage since imprints of conventional bacteriophage  $\lambda$  plaques contain ample quantities of material for detection by antisera of high specificity and reasonable titer. Screening of lysogens may, however, offer some advantages when using proteins such as calmodulin as probes or when using small ligands (e.g., cAMP) with a low affinity for the target protein. The high concentration of target protein in an induced lysogenic colony may significantly shift the binding equilibrium in favor of complex formation between a ligand and its target and hence raise the intensity of the signal to the point where it becomes detectable (Mutzel et al. 1990; Mutzel 1994).

Although lysogens are no longer used for screening entire bacteriophage  $\lambda$  libraries with immunological probes or double-stranded oligonucleotide probes, they are routinely used to analyze the properties of fusion proteins encoded by individual bacteriophage recombinants. The bacteriophages recovered from an individual plaque are used to establish lysogenic derivatives of *E. coli* strain Y1090 *hsdR* or Y1089 *hflA*, which can be induced to synthesize fusion proteins in quantities sufficient for biochemical analysis (please see Protocol 7).

## Genomic DNA and cDNA Expression Libraries

Two types of expression libraries can be constructed in plasmid and bacteriophage  $\lambda$  expression vectors: cDNA and genomic DNA libraries. For prokaryotic organisms, whose genomes contain few introns, there is little to be gained by constructing cDNA libraries in these vectors. Instead, randomly sheared genomic DNA can be used to create a library (for details, please see Chapter 11) in which all coding sequences are proportionally represented (e.g., please see Young et al. 1985). The optimal average length of the sheared fragments of DNA used to construct libraries of this kind depends on the size of the gene of interest: The smaller the gene, the smaller the genomic DNA fragments. Ideally, the size of the fragments should be approximately one-half the predicted size of the gene. This size range reduces the chance that the coding sequences of the gene of interest will be preceded by upstream termination sequences.

A similar strategy can be used with eukaryotic organisms such as yeasts, whose genomes are comparatively small and consist predominantly of coding sequences. The probability ( $P$ ) of creating a recombinant containing the sequences of the gene of interest in the correct reading frame and orientation for expression is:

$$P = \frac{\text{size of the coding region of the gene of interest (in kb)}}{\text{size of genome (in kb)} \times 6}$$

The factor of 6 takes into account the fact that a given DNA fragment can be inserted into the vector in two possible orientations and that only one of the three potential reading frames is correct for expression. The

proportion of clones expressing the particular fusion protein is then  $1:1/P$ . For example, in a genomic DNA expression library, the proportion of recombinants capable of expressing a fusion protein encoded by a gene whose coding region is 1.5 kb in length is predicted to be:

Organism	Genome size (kb)	Proportion
<i>E. coli</i>	$4.0 \times 10^3$	$1:1.6 \times 10^4$
Yeast	$1.4 \times 10^4$	$1:5.6 \times 10^4$
<i>Drosophila</i>	$1.8 \times 10^5$	$1:7.2 \times 10^5$

In theory, these frequencies will be attained only if the cloned genomic DNA fragments are considerably smaller (<50%) than the size of the coding sequence of interest. In practice, however, the frequency of positive clones is somewhat higher than expected. Although the reasons for this outcome are not understood, a possible clue comes from the observation that a high proportion of clones isolated from genomic DNA expression libraries by immunological screening do not synthesize fusion proteins (Goto and Wang 1984; Ozkaynak et al. 1984; Snyder et al. 1986). Because expression of these cloned genes is dependent on transcription from the *lacZ* promoter, it seems likely that the clones carry out-of-frame insertions and that translation of the foreign sequences is initiated at an internal methionine codon. More rarely, the foreign sequences may carry signals that can direct transcription and translation in *E. coli*.

As the size of eukaryotic genomes increases, the fraction that is occupied by coding sequences shrinks dramatically, and the average length of individual exons decreases to ~200 bp (Go 1983). The idea of screening genomic DNA expression libraries then becomes much less attractive. In the case of the mammalian genome ( $3 \times 10^9$  bp), reconstruction experiments suggest that it would be necessary to screen a library of at least  $10^7$  clones (average size 200–300 bp) to detect a recombinant expressing a particular epitope (Rüther et al. 1982). Even then, only epitopes encoded by DNA sequences contained within a single exon would be detected. The use of cDNA libraries solves these problems by consolidating the coding sequences of individual genes into single clones and eliminating the nonproductive screening of clones that consist of intron and repetitive sequences.

Mammalian cDNA libraries used for immunological screening usually have a complexity of at least  $10^6$  independent recombinants. In libraries constructed by nondirectional cloning, only one recombinant in six will carry an insert in the correct orientation and frame for expression. However, in libraries established by directional cloning, the proportion of useful clones rises to one in three. Most directionally cloned libraries are constructed by random priming of cDNA synthesis rather than by oligo(dT) priming. Random-primed libraries contain a higher proportion of sequences that lie toward the 5' region of the mRNA and therefore would be expected to express epitopes that map to the amino-terminal sequences of the protein, whereas expression libraries generated by oligo(dT) priming are likely to be enriched for epitopes located in the carboxy-terminal regions of the target protein. To maximize the chance of detecting a clone by immunological probes, many investigators screen a composite library containing a representative mixture of cDNA clones generated by each method of priming.

---

## USING ANTIBODIES IN IMMUNOLOGICAL SCREENING

---

### Choosing the Antibody

Ideally, an antibody used for screening of expression libraries should be polyclonal, absolutely specific for conformation-independent epitopes that are displayed on both native and denatured forms of the protein, of high titer, and of the IgG class. This combination of properties is rarely found in a single antiserum, and it is often necessary to screen expression libraries with preparations of antibodies that are far from ideal. To determine whether the available batches of antisera are suitable as probes, serial dilutions of several independent antisera should be tested for the following properties:

- **Reactivity with the protein of interest on a western blot.** Denatured proteins transferred from an SDS-polyacrylamide gel are likely to display many of the same epitopes as the cognate fusion protein synthesized in bacteria. The foreign polypeptide sequences of most fusion proteins are unlikely to fold into completely native structures and, after transfer to a nitrocellulose filter, may undergo further denaturation. Antisera that fail to detect the protein of interest on a western blot are probably specific for epitopes displayed only on the native protein and therefore may be unsuitable as probes for expression libraries.
- **Specific immunoprecipitation of a polypeptide of the predicted size from *in vitro* translation reactions primed with the same mRNA used to construct the expression library.** An antiserum reacting strongly in this test must be directed primarily against epitopes that are displayed on unmodified, and probably unfolded, proteins. Clearly, antisera that recognize oligosaccharides or other modifying groups found on eukaryotic proteins are of no value for screening prokaryotic expression libraries.
- **Production of weak or undetectable signals when reacted with bacteria expressing the sequences of the vector alone.** Antisera should be tested by screening two nitrocellulose filters, one containing imprints of nonrecombinant plaques or colonies formed by the vector alone and the other containing imprints of a small fraction (e.g., 1–5000 plaques or colonies) of the expression library that is to be screened. A series of dilutions containing known amounts of the native and denatured (boiled) antigen (20 pg to 100 ng) of interest are spotted onto a separate filter. The three filters are then cut into sections, which are screened with different dilutions of antiserum. The aim is to find a dilution that displays a high level of specific reactivity with the antigen but does not react nonspecifically with prokaryotic proteins. Typically, the range of dilutions used in this test is 1:200–1:5000 for polyclonal antisera, IgG fractions, ascitic fluids, and affinity-purified antisera and 1:10–1:100 for supernatant fluids from cloned hybridomas grown *in vitro*. Ideally, the antibody should be capable of detecting as little as 50–100 pg of antigen in an area the size of a small bacterial colony. The amount of antigen present in colonies and plaques expressing fusion proteins varies widely depending on the toxicity of the fusion protein, its rate of degradation, and its physical state. However, an antiserum capable of detecting as little as 50–100 pg of denatured antigen should allow all but the most labile of fusion proteins to be recognized.

Both polyclonal antisera and monoclonal antibodies can meet the above criteria, and both have been used successfully to identify recombinants that express cloned sequences of interest. Each has different advantages. Polyclonal antisera are usually able to react with several different epitopes, which may be encoded by different regions of the gene of interest. Recombinants carrying fragments of this gene may therefore be detected by polyclonal antisera. By contrast, monoclonal antibodies, which by definition are able to react with only one epitope, may detect only a particular subset of the recombinants that express sequences of the gene of interest. However, monoclonal antibodies generally show much lower levels of background reactivity with *E. coli* components than do polyclonal antisera. The best reagents for immunological screening are therefore pools of monoclonal antibodies directed against different epitopes on the protein of interest or high-titer polyclonal antisera that do not react with host components. Before screening an expression library, it is essential to carry out a series of western blots or to optimize the conditions for binding the antibody to its target protein. The goal is to ascertain the following:

- A dilution of the antibody that generates a strong signal with the target protein and a low level of background against other proteins present in the bacterial lysate.
- The optimal time and temperature of incubation.
- Washing conditions that will discriminate between antibody molecules bound to their target protein and antibodies bound nonspecifically to, for example, the nitrocellulose membrane.



If, as is sometimes the case, the antiserum reacts strongly with components of lysates of bacteriophage-infected cells, it must be purified before being used to screen an expression library. For further information, please see Purification of Antisera below.

### Purification of Antisera

When the antisera to be used for screening react with only one protein of the expected molecular weight on a western blot, further antigen-specific purification is not necessary. However, if the antibodies that react with the antigen of interest are of the IgG class, they may be easily purified and concentrated by affinity chromatography on protein A-Sepharose columns (Goudswaard et al. 1978). Preparations of IgG used for immunological screening usually give lower backgrounds than whole sera.

Antisera that react with several different proteins usually have been raised against impure antigen and are therefore likely to react with recombinant clones other than those specifying the protein of interest. In this case, the antibody should be purified by affinity chromatography on columns of the immobilized antigen. Note that affinity purification must be carried out with an independent preparation of antigen free of the contaminants, which may be difficult to obtain. In this case, there are two options. First, the library may be screened with the available polyclonal antisera; immunoreactive clones must then be analyzed by a test that can distinguish unambiguously between false and true positives. Alternatively, impure preparations of antigen may be used to generate clonal lines of hybridomas that secrete monoclonal antibodies specific for the protein of interest.

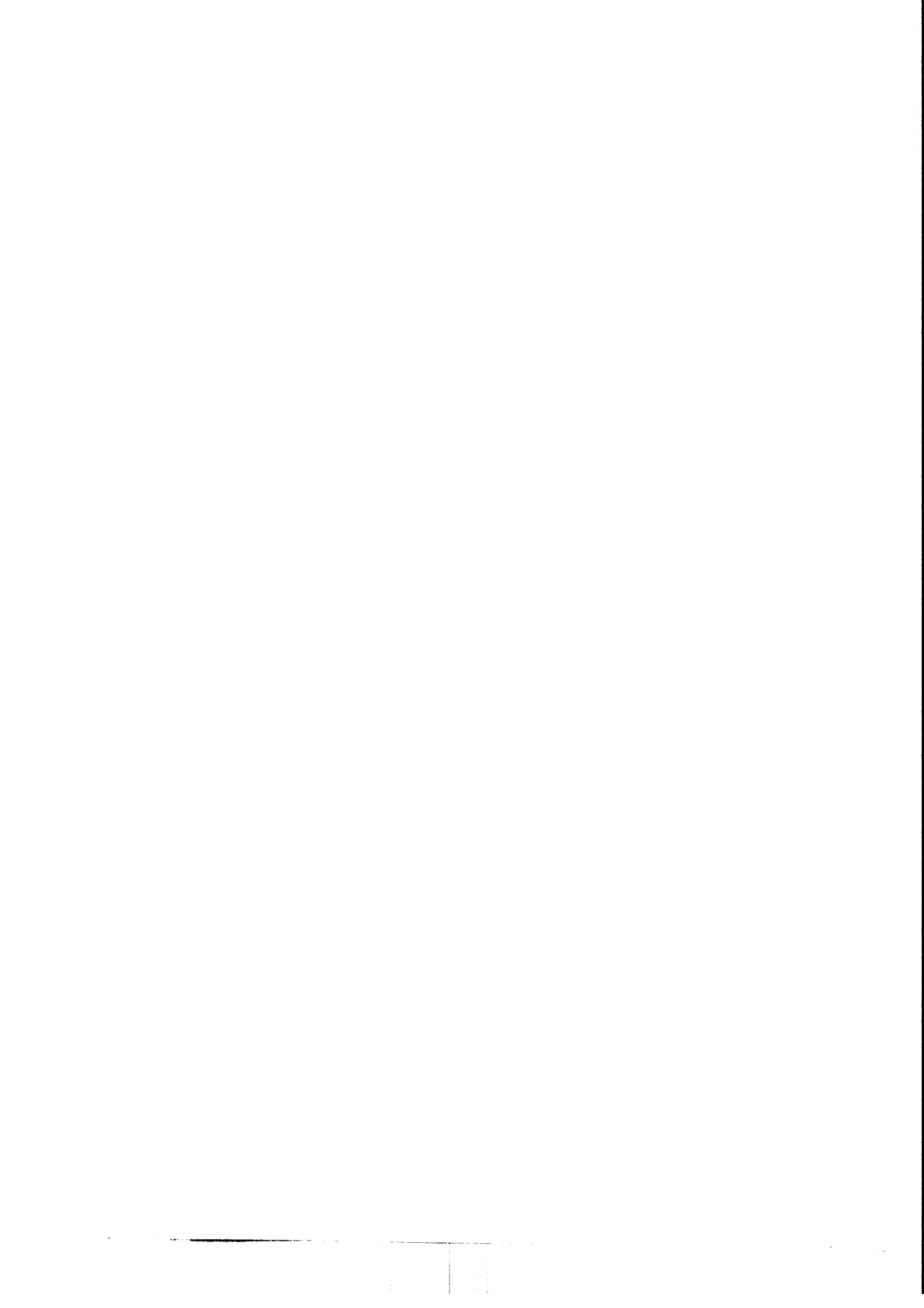
Components in polyclonal antisera or preparations of IgG that react with antigens produced by *E. coli* may be removed by immunoabsorption, for example, by incubating the diluted antiserum with nitrocellulose filters coated with lysed bacterial colonies or the debris of nonrecombinant plaques (pseudoscreening; please see Protocol 3 of this chapter). This process can be repeated several times, until all of the anti-*E. coli* antibodies have been removed. Alternatively, the diluted antiserum can be mixed with an extract of *E. coli* made by freezing-thawing and sonication (please see Protocol 4 of this chapter). The absorbed diluted antiserum can then be used to probe expression libraries without further treatment. The most effective procedure is to expose undiluted antiserum or purified IgG to lysates of *E. coli* that have been immobilized on cyanogen-bromide-activated Sepharose 4B as described by de Wet et al. (1984) (please see Protocol 5 of this chapter).

Several manufacturers of kits used for immunological screening provide lysates of bacterial cultures infected with bacteriophage  $\lambda$  vectors. These lysates can be used to check by western blotting whether an antibody directed against the target protein also reacts with components specified by the bacteriophage vector and/or its host.

## REFERENCES

- Alter J.M. and Patrie W.J. 1990. Isolation of  $\lambda$ gt11 clones directly from immunochemically screened filters. *BioTechniques* **9**: 564–565.
- Amann E., Brosius J., and Ptashne M. 1983. Vectors bearing a hybrid *trp-lac* promoter useful for regulated expression of cloned genes in *Escherichia coli*. *Gene* **25**: 167–178.
- Bagga J.S. and Wilusz J. 1999. Northwestern screening of expression libraries. *Methods Mol. Biol.* **118**: 245–256.
- Blake M.S., Johnston K.H., Russell-Jones G.J., and Gotschlich E.C. 1984. A rapid, sensitive method for detection of alkaline phosphatase-conjugated anti-antibody on Western blots. *Anal. Biochem.* **136**: 175–179.
- Blancar M.A. and Rutter W.J. 1992. Interaction cloning: Identification of a helix-loop-helix zipper protein that interacts with c-Fos. *Science* **256**: 1014–1018.
- Chao S., Chao L., and Chao J. 1989. Enhanced specificity in immunoscreening of expression cDNA clones using radiolabeled antigen overlay. *BioTechniques* **7**: 68–72.
- Clerc R.G., Corcoran L.M., LeBowitz J.H., Baltimore D., and Sharp P.A. 1988. The B-cell-specific Oct-2 protein contains POU box- and homeo box-type domains. *Genes Dev.* **2**: 1570–1581.
- de Wet J.R., Fukushima H., Dewji N.N., Wilcox E., O'Brien J.S., and Helinski D.R. 1984. Chromogenic immunodetection of human serum albumin and  $\alpha$ -L-fucosidase clones in a human hepatoma cDNA expression library. *DNA* **3**: 437–447.
- di Guan C., Li P., Riggs P.D., and Inouye H. 1988. Vectors that facilitate the expression and purification of foreign peptides in *Escherichia coli* by fusion to maltose-binding protein. *Gene* **67**: 21–30.
- Earnshaw W.C. and Rothfield N. 1985. Identification of a family of human centromere proteins using autoimmune sera from patients with scleroderma. *Chromosoma* **91**: 313–321.
- French B.T., Maul H.M., and Maul G.G. 1986. Screening cDNA expression libraries with monoclonal and polyclonal antibodies using an amplified biotin-avidin-peroxidase technique. *Anal. Biochem.* **156**: 417–423.
- Gething M.J. and Sambrook J. 1983. Expression of cloned influenza virus genes. In *Genetics of influenza viruses* (ed. P. Palese and D.W. Kingsbury), pp. 169–191. Springer-Verlag, Vienna.
- Geysen H.M., Tainer J.A., Rodda S.J., Mason T.J., Alexander H., Getzoff E.D., and Lerner R.A. 1987. Chemistry of antibody binding to a protein. *Science* **235**: 1184–1190.
- Go M. 1983. Modular structural units, exons, and function in chicken lysozyme. *Proc. Natl. Acad. Sci.* **80**: 1964–1968.
- Goto T. and Wang J.C. 1984. Yeast DNA topoisomerase II is encoded by a single-copy, essential gene. *Cell* **36**: 1073–1080.
- Gottesman S. and Maurizi M.R. 1992. Regulation by proteolysis: Energy-dependent proteases and their targets. *Microbiol. Rev.* **56**: 592–621.
- Goudswaard J., van der Donk J.A., Noordzij A., van Dam R.H., and Vaerman J.P. 1978. Protein A reactivity of various mammalian immunoglobulins. *Scand. J. Immunol.* **8**: 21–28.
- Harlow E. and Lane D. 1999. *Using antibodies: A laboratory manual*. Cold Spring Harbor Laboratory Press, Cold Spring Harbor, New York.
- Hawkes R. 1986. The dot immunobinding assay. *Methods Enzymol.* **121**: 484–491.
- Hawkes R., Niday E., and Gordon J. 1982. A dot-immunobinding assay for monoclonal and other antibodies. *Anal. Biochem.* **119**: 142–147.
- Helfman D.M. and Hughes S.H. 1987. Use of antibodies to screen cDNA expression libraries prepared in plasmid vectors. *Methods Enzymol.* **152**: 451–457.
- Helfman D.M., Feramisco J.R., Fiddes J.C., Thomas G.P., and Hughes S.H. 1983. Identification of clones that encode chicken tropomyosin by direct immunological screening of a cDNA expression library. *Proc. Natl. Acad. Sci.* **80**: 31–35.
- Huang S.H. and Jong A. 1994. Efficient induction and preparation of fusion proteins from recombinant phage  $\lambda$ gt11 clones. *Trends Genet.* **10**: 183.
- Huang S.H., Tomich J.M., Wu H., Jong A., and Holcenberg J. 1989. Human deoxycytidine kinase. Sequence of cDNA clones and analysis of expression in cell lines with and without enzyme activity. *J. Biol. Chem.* **264**: 14762–14768.
- Hurst H.C. 1997. Immunological screening of  $\lambda$ -phage cDNA expression libraries. *Methods Mol. Biol.* **69**: 155–159.
- Huynh T.V., Young R.A., and Davis R.W. 1985. Constructing and screening cDNA libraries in  $\lambda$ gt10 and  $\lambda$ gt11. In *DNA cloning: A practical approach* (ed. D.M. Glover), vol. 1, pp. 49–78. IRL Press, Oxford, United Kingdom.
- Johnson L.M., Snyder M., Chang L.M., Davis R.W., and Campbell J.L. 1985. Isolation of the gene encoding yeast DNA polymerase I. *Cell* **43**: 369–377.
- Johnstone A. and Thorpe R. 1982. *Immunochemistry in practice*, 1st edition. Blackwell, Oxford, United Kingdom.
- Kaufman D.L., McGinnis J.F., Krieger N.R., and Tobin A.J. 1986. Brain glutamate decarboxylase cloned in  $\lambda$ gt-11: Fusion protein produces  $\gamma$ -aminobutyric acid. *Science* **232**: 1138–1140.
- Kemp D.J. and Cowman A.F. 1981. Detection of expressed polypeptides by direct immunoassay of colonies. *Methods Enzymol.* **79**: 622–630.
- Knecht D.A. and Dimond R.L. 1984. Visualization of antigenic proteins on Western blots. *Anal. Biochem.* **136**: 180–184.
- Kornbluth S., Paulson K.E., and Hanafusa H. 1988. Novel tyrosine kinase identified by phosphotyrosine antibody screening of cDNA libraries. *Mol. Cell. Biol.* **8**: 5541–5544.
- Kupper H., Keller W., Kurz C., Forss S., Schaller H., Franze R., Strohmaier K., Marquardt O., Zaslavsky V.G., and Hofschneider P.H. 1981. Cloning of cDNA of major antigen of foot and mouth disease virus and expression in *E. coli*. *Nature* **289**: 555–559.
- Lacombe M.L., Ladant D., Mutzel R., and Veron M. 1987. Gene isolation by direct in situ cAMP binding. *Gene* **58**: 29–36.
- LaVallie E.R., DiBlasio E.A., Kovacic S., Grant K.L., Schendel P.F., and McCoy J.M. 1993. A thioredoxin gene fusion expression system that circumvents inclusion body formation in the *E. coli* cytoplasm. *Bio/Technology* **11**: 187–193.
- Lenz J., Okenquist S.A., LoSardo J.E., Hamilton K.K., and Doetsch P.W. 1990. Identification of a mammalian nuclear factor and human cDNA-encoded proteins that recognize DNA containing apurinic sites. *Proc. Natl. Acad. Sci.* **87**: 3396–3400.
- Lieb M. 1979. Heat-sensitive lambda repressors retain partial activity during bacteriophage induction. *J. Virol.* **32**: 162–166.
- Lillibridge C.D. and Philipp M.T. 1993. Swift identification of recombinant proteins from  $\lambda$ -phage libraries without resort-

- ing to liquid cultures or lysogens. *BioTechniques* **15**: 812–814.
- Lindberg R.A., Thompson D.P., and Hunter T. 1988. Identification of cDNA clones that code for protein-tyrosine kinases by screening expression libraries with antibodies against phosphotyrosine. *Oncogene* **3**: 629–633.
- Mandal N.C. and Lieb M. 1976. Heat-sensitive DNA-binding activity of the *cl* product of bacteriophage lambda. *Mol. Gen. Genet.* **146**: 299–302.
- McGadey J. 1970. A tetrazolium method for non-specific alkaline phosphatase. *Histochemie* **23**: 180–184.
- Mierendorf R.C., Percy C., and Young R.A. 1987. Gene isolation by screening  $\lambda$ gt11 libraries with antibodies. *Methods Enzymol.* **152**: 458–469.
- Müller M.M., Ruppert S., Schaffner W., and Matthias P. 1988. A cloned octamer transcription factor stimulates transcription from lymphoid-specific promoters in non-B cells. *Nature* **336**: 544–551.
- Mutzel R. 1994. Preparation and ligand screening of a  $\lambda$ gt11 lysogen library. *Methods Mol. Biol.* **31**: 397–407.
- Mutzel R., Baeuerle A., Jung S., and Dammann H. 1990. Prophage lambda libraries for isolating cDNA clones by functional screening. *Gene* **96**: 205–211.
- Ozkaynak E., Finley D., and Varshavsky A. 1984. The yeast ubiquitin gene: Head-to-tail repeats encoding a polyubiquitin precursor protein. *Nature* **312**: 663–666.
- Qian Z. and Wilusz J. 1993. Cloning of a cDNA encoding an RNA binding protein by screening expression libraries using a northwestern strategy. *Anal. Biochem.* **212**: 547–554.
- Runge S.W. 1992. Rapid analysis of  $\lambda$ gt11 fusion proteins without subcloning or lysogen induction. *BioTechniques* **12**: 630–631.
- Rüther U. and Müller-Hill B. 1983. Easy identification of cDNA clones. *EMBO J.* **2**: 1791–1794.
- Rüther U., Koenen M., Sippel A.E., and Müller-Hill B. 1982. Exon cloning: Immunoenzymatic identification of exons of the chicken lysozyme gene. *Proc. Natl. Acad. Sci.* **79**: 6852–6855.
- Schleif R. 1988. DNA binding by proteins. *Science* **241**: 1182–1187.
- Sikela J.M. and Hahn W.E. 1987. Screening an expression library with a ligand probe: Isolation and sequence of a cDNA corresponding to a brain calmodulin-binding protein. *Proc. Natl. Acad. Sci.* **84**: 3038–3042.
- Singh H. 1993. Specific recognition site probes for isolating genes encoding DNA-binding proteins. *Methods Enzymol.* **218**: 551–567.
- Singh H., Clerc R.G., and LeBowitz J.H. 1989. Molecular cloning of sequence-specific DNA binding proteins using recognition site probes. *BioTechniques* **7**: 252–261.
- Singh H., LeBowitz J.H., Baldwin A.S.J., and Sharp P.A. 1988. Molecular cloning of an enhancer binding protein: Isolation by screening of an expression library with a recognition site DNA. *Cell* **52**: 415–423.
- Skolnik E.Y., Margolis B., Mohammadi M., Lowenstein E., Fischer R., Drepps A., Ullrich A., and Schlessinger J. 1991. Cloning of P13 kinase-associated p85 utilizing a novel method for expression/cloning of target proteins for receptor tyrosine kinases. *Cell* **65**: 83–90.
- Smith D.B. and Johnson K.S. 1988. Single-step purification of polypeptides expressed in *Escherichia coli* as fusions with glutathione S-transferase. *Gene* **67**: 31–40.
- Snyder M., Elledge S., and Davis R.W. 1986. Rapid mapping of antigenic coding regions and constructing insertion mutations in yeast genes by mini-Tn10 “transposon” mutagenesis. *Proc. Natl. Acad. Sci.* **83**: 730–734.
- Snyder M., Elledge S., Sweetser D., Young R.A., and Davis R.W. 1987.  $\lambda$ gt 11: Gene isolation with antibody probes and other applications. *Methods Enzymol.* **154**: 107–128.
- Stanley K.K. 1983. Solubilization and immune-detection of  $\beta$ -galactosidase hybrid proteins carrying foreign antigenic determinants. *Nucleic Acids Res.* **11**: 4077–4092.
- Stanley K.K. and Luzio J.P. 1984. Construction of a new family of high efficiency bacterial expression vectors: Identification of cDNA clones coding for human liver proteins. *EMBO J.* **3**: 1429–1434.
- Stark M.J. 1987. Multicopy expression vectors carrying the *lac* repressor gene for regulated high-level expression of genes in *Escherichia coli*. *Gene* **51**: 255–267.
- Staudt L.M., Clerc R.G., Singh H., LeBowitz J.H., Sharp P.A., and Baltimore D. 1988. Cloning of a lymphoid-specific cDNA encoding a protein binding the regulatory octamer DNA motif. *Science* **241**: 577–580.
- Sussman R. and Jacob F. 1962. Sur un système de repression thermosensible chez le bacteriophage d'*Escherichia coli*. *C.R. Acad. Sci.* **254**: 1517–1519.
- Towbin H. and Gordon J. 1984. Immunoblotting and dot immunobinding — Current status and outlook. *J. Immunol. Methods* **72**: 313–340.
- Towbin H., Staehelin T., and Gordon J. 1979. Electrophoretic transfer of proteins from polyacrylamide gels to nitrocellulose sheets: Procedure and some applications. *Proc. Natl. Acad. Sci.* **76**: 4350–4354.
- Ullmann A., Jacob F., and Monod J. 1967. Characterization by *in vitro* complementation of a peptide corresponding to an operator-proximal segment of the  $\beta$ -galactosidase structural gene of *Escherichia coli*. *J. Mol. Biol.* **24**: 339–343.
- Vinson C.R., LaMarco K.L., Johnson P.F., Landschulz W.H., and McKnight S.L. 1988. In situ detection of sequence-specific DNA binding activity specified by a recombinant bacteriophage. *Genes Dev.* **2**: 801–806.
- Webster P.J. and Macdonald P.M. 1999. Screening expression libraries with solution-based assay. *Methods Mol. Biol.* **118**: 257–264.
- Young R.A. and Davis R.W. 1983a. Efficient isolation of genes by using antibody probes. *Proc. Natl. Acad. Sci.* **80**: 1194–1198.
- . 1983b. Yeast RNA polymerase II genes: Isolation with antibody probes. *Science* **222**: 778–782.
- . 1991. Gene isolation with  $\lambda$ gt11 system. *Methods Enzymol.* **194**: 230–238.
- Young R.A., Bloom B.R., Grosskinsky C.M., Ivanyi J., Thomas D., and Davis R.W. 1985. Dissection of *Mycobacterium tuberculosis* antigens using recombinant DNA. *Proc. Natl. Acad. Sci.* **82**: 2583–2587.



# Index

We shall not cease from exploration  
And the end of all our exploring  
Will be to arrive where we started  
And know the place for the first time.

T.S. ELIOT

- Aat*II cleavage at end of DNA fragments, A6.4  
ABLE C, 1.15  
ABLE K, 1.15  
ABTS. *See* 2,2'-azino-di(3-ethylbenzthiazoline-6-sulphonic acid)  
*Acc*65 cleavage at end of DNA fragments, A6.4  
*Acl*I cleavage of 7-deaza-dGTP modified DNA, 8.60  
*Acl*III, A4.7  
Acetic acid  
  for polyacrylamide gel fixation, 5.49–5.50, 12.90–12.92  
  recipes, A1.6  
Acetonitrile, 10.28–10.29, 10.42, 10.49, 18.68  
Acetyl-CoA, 17.95  
  CAT, 17.36–17.41  
  luciferase and, A9.22  
Acid citrate dextrose solution B (ACD), 6.8–6.9  
Acid-hydrolyzed casein (AHC) medium, 4.65  
Acid phenol-guanidinium thiocyanate-chloroform extraction, 7.4–7.8  
Acids and bases, general, A1.6  
Acridine orange and glyoxylated RNA staining, 7.27  
Acridinium esters, chemiluminescence from, A9.17–A9.18  
Acrylamide, 12.74–12.75, A8.40–A8.43. *See also* Polyacrylamide; Polyacrylamide gel electrophoresis  
  recipe, A1.25  
  solutions for denaturing gels, table of, 12.78  
  solutions for denaturing polyacrylamide gels containing formamide, table of, 12.82  
  storage, 12.75  
Acrylamide gel elution buffer, 5.51–5.52  
Acrylease, 5.44, 12.75  
Actinomycin C<sub>1</sub>, A2.7  
Actinomycin D, 11.38, A1.15  
  mechanism of action, 7.88, A2.7  
  overview, 7.88  
  in primer extension mix, 7.77  
  self-priming, inhibition of, 11.46  
  structure of, 7.88  
Activation domain fusion plasmids, 18.20  
ADA. *See* Adenosine deaminase  
Adamantyl 1,2-dioxetane phosphate (AMPPD), 9.79, A9.39–A9.40, A9.42–A9.44  
  kinetics of chemiluminescence, A9.44  
Adaptors  
  attaching to protruding termini, 1.88–1.89  
  cDNA cloning, 11.20–11.21, 11.51–11.55  
  in direct selection of cDNAs protocol, 11.102  
  directional cloning, 1.84  
  overview, 1.160  
  table of sequences, 1.161  
*ade* gene, 4.2, 4.59–4.60, 18.22  
Adenine, A6.6  
  methylation of, 11.48, 13.87–13.88, A4.3–A4.4  
  nitrous oxide modification of, 13.78  
  related compounds (Table A6-5), A6.6  
  structure, A6.6  
  in YAC vector growth, 4.65  
Adenosine deaminase (ADA), 16.47  
Adenosine diphosphate (ADP), A1.25  
Adenosine triphosphate (ATP), A1.25  
  dATP inhibition of T4 DNA ligase, 1.85  
  luciferase and, 17.44–17.45, 17.47, A9.22  
ADP. *See* Adenosine diphosphate  
Adsorption, viral, 2.4  
*Aequorea victoria*, 18.69, A9.24. *See also* Green fluorescent protein  
Aequorin, 17.84, 17.89, A9.24  
Affinity chromatography. *See also* Chromatography  
  antisera purification, 14.51  
  biotin:avidin, 11.11  
  of *E. coli* lysate for cross-reactive antibody removal, 14.28–14.30  
  epitope tagging and, 17.91  
  fusion protein purification, 14.40, 14.43, 15.4–15.5  
    on amylose resin, 15.40–15.43  
    on glutathione agarose, 15.36–15.39  
    of maltose-binding proteins, 15.40–15.43  
  histidine-tagged protein purification, 15.44–15.48  
  metal chelate, 15.44–15.48  
  removal of cross-reactive antibodies, 14.28–14.30  
Affinity purification using magnetic beads, 11.118–11.120  
*Afl*II cleavage at end of DNA fragments, A6.4  
Agar, media containing, A2.5  
Agarase, 5.33–5.35, 5.83–5.88, A4.51  
Agarose. *See also* Agarose gel electrophoresis  
  blocks/plugs  
    λ concatamer ligation in, 5.72–5.73  
    lysis of cells in, 5.61, 5.64–5.65, 5.67  
    for pulsed-field gel electrophoresis, 5.59, 5.61–5.70  
  restriction endonuclease digestion of DNA in, 5.68–5.70  
  storage of, 5.64, 5.67  
  composition of, 5.4  
  electroendo-osmosis (EEO), 5.7  
  low-melting-temperature, 5.6, 5.7  
    DNA recovery from, 5.29–5.35  
    pulsed-field gel electrophoresis gels, 5.83–5.88  
  DNA size selection in shotgun sequencing protocol, 12.18  
  λ concatamer ligation in, 5.72–5.73  
  ligation in, 1.103–1.104, 5.29  
  migration rate through, 5.31  
  properties of, 5.6  
  pulsed-field gel electrophoresis, 5.61–5.67, 5.83–5.88  
  radiolabeling DNA in gel slices, 9.9  
  resolution of, 5.6  
  restriction endonuclease digestion in agarose plugs, 5.68–5.70  
  media containing, A2.5  
  types of, 5.6  
Agarose gel electrophoresis. *See also* Pulsed-field gel electrophoresis  
  alkaline, 5.36–5.39  
  autoradiography, 5.39  
  method, 5.38  
  Southern hybridization, 5.38  
  uses for, 5.36  
  analysis of linker/adaptor attachment to cDNA, 11.55  
  analysis of methylation of cDNA, 11.50  
  band-stab PCR of samples from gel, 8.71  
  cDNA fractionation, 11.9  
  denaturing, 7.21–7.23, 7.27–7.34  
  DNA content of λ stock and lysates, assaying, 2.45–2.46  
  DNA detection, 5.14–5.17  
    ethidium bromide staining, 5.14–5.15  
    photography, 5.16–5.17  
    SYBR Gold staining, 5.15–5.16  
  DNA recovery, 1.91, 5.18  
    anion-exchange chromatography, 5.26–5.28  
    DEAE cellulose membranes, electrophoresis onto, 5.18–5.22  
    dialysis bags, electroelution into, 5.23–5.25  
    low-melting temperature agarose  
      agarase, 5.33–5.35  
      glass bead use, 5.32  
      organic extraction, 5.29–5.31  
    problems associated with, 5.18  
  DNA size selection in shotgun sequencing protocol, 12.18  
  DNA transfer from  
    capillary transfer  
      downward, 6.35  
      upward, 6.34–6.35  
    electrophoretic transfer, 6.36  
    simultaneous transfer to two filters, 6.35–6.36  
    vacuum transfer, 6.37  
  electrophoresis buffers. *See also* Electrophoresis buffers  
    effect on DNA migration, 5.7–5.8  
    gel preparation, 5.10  
    recipes, 5.8  
  ethidium bromide staining, A9.3–A9.4  
  gel-loading buffers, 5.9  
  history of, 5.3  
  λ arm purification, 2.71  
  large DNA molecules, difficulty entering the gel, 6.15  
  markers, radiolabeled size, 9.54  
  method, 5.10–5.13  
    comb placement, 5.11  
    gel preparation, 5.10  
    loading gel, 5.12–5.13  
    pouring gel, 5.11–5.13  
    well capacity, 5.12–5.13  
  methylene blue staining, A9.5  
  migration rate  
    DNA from alkaline lysis preparations, 1.40  
    DNA from boiled lysis preparations, 1.45, 1.49  
    DNA from toothpick minipreparations, 1.53  
  ethidium bromide and, 1.53  
  factors determining, 5.4–5.8  
    agarose concentration, 5.5  
    agarose type, 5.6–5.7  
    conformation of DNA, 5.5  
    electrophoresis buffer, 5.7–5.8  
    ethidium bromide presence, 5.5

## 1.2 Index

- Agarose gel electrophoresis (*continued*)  
size of DNA, 5.4  
voltage applied, 5.5–5.6  
minigels, 5.13  
mRNA fractionation for cDNA preparation, 11.9  
partial digestion products, separating, 2.78  
polyacrylamide gels compared, 5.2, 5.40  
pulsed-field gel electrophoresis  
overview of, 5.2–5.3  
resolution, 5.3  
for quantitating DNA, A8.24  
reptation, 5.2  
resolution, 5.2, 5.6, 5.12  
RNA separation  
equalizing RNA amounts, 7.22–7.23  
formaldehyde-containing gels, 7.31–7.34  
glyoxylated RNA, 7.27–7.30  
markers used for, 7.23, 7.29  
overview, 7.21–7.22  
pseudomessages as standards, 7.23  
tracking dyes, 7.23  
RNA transfer to membranes, 7.35–7.41  
Southern hybridization, 1.28  
standards, DNA size, 5.10  
storage of gels, 6.43  
Agel cleavage at end of DNA fragments, A6.4  
A gene/protein,  $\lambda$ , 2.14–2.15  
Air bubbles in polyacrylamide gels, 12.79  
Ala-64 subtilisin, 15.8  
Alanine  
codon usage, A7.3  
nomenclature, A7.7  
properties, table of, A7.8  
Alanine-scanning mutagenesis, 13.3, 13.81  
Alkaline agarose gel electrophoresis, 5.36–5.39. *See also* Agarose gel electrophoresis  
autoradiography, 5.39  
buffer, A1.17  
method, 5.38  
Southern hybridization, 5.38  
uses of, 5.36  
Alkaline gel-loading buffer, A1.18  
Alkaline lysis  
BAC DNA purification protocols, 4.53–4.57  
in Pl/PAC DNA purification protocols, 4.41–4.43  
plasmid DNA protocols, 1.19  
maxipreparation protocol, 1.38–1.41  
midipreparation protocol, 1.35–1.37  
minipreparation protocol, 1.32–1.34  
overview, 1.31  
troubleshooting, 1.41–1.42  
yield, 1.41  
Alkaline lysis solutions I, II, and III, 1.32–1.33, 1.35–1.36, 1.38, 1.40, 3.24–3.25  
in plasmid DNA purification by precipitation with PEG, 12.31  
recipes, A1.16  
Alkaline phosphatase, A8.55  
antibody conjugates, A9.34  
calculating amount of 5' ends in a DNA sample, 9.63  
chemiluminescent enzyme assay, A9.19  
dephosphorylation  
of M13 vector DNA, 12.24  
of plasmid DNA, 1.93–1.97  
digoxigenin-specific antibodies coupled to, A9.39–A9.40  
in end-labeling, 9.55  
inactivation, 1.96, 9.62, 9.64, 9.93  
 $\lambda$  vector DNA, treatment of, 2.68–2.70  
in M13 vectors, 3.34, 3.36  
overview, 9.92–9.93, A4.37  
properties of, 9.92–9.93  
protocol, 9.62–9.65  
purification of dephosphorylated DNA, 9.64  
as reporter enzyme, 9.92, 17.31  
for biotin, 9.76  
chemiluminescence, 9.79  
colorimetric assays, 9.78  
for digoxigenin, 9.77  
direct detection, 9.80  
for fluorescein, 9.77  
fluorescent assays, 9.79  
in screening expression libraries, 14.3  
chemiluminescent, 14.11, 14.21  
chromogenic, 14.9–14.10, 14.20  
self-ligation, prevention of, 9.92  
substrates  
AMPDP, A9.39, A9.42–A9.44  
BCIP/NPT, A9.39–A9.40  
D-luciferin-O-phosphate, A9.42  
p-nitrophenyl phosphate, A9.41–A9.42  
use in cosmid vector cloning, 4.15, 4.19, 4.20–4.21  
Alkaline phosphatase promoter (PhoA) for expression of cloned genes in *E. coli*, 15.30–15.35  
large-scale expression, 15.34  
materials for, 15.31–15.32  
optimization, 15.33  
overview, 15.30  
protocol, 15.32–15.34  
subcellular localization of fusion proteins, 15.35  
Alkaline transfer buffer, 6.40, 6.44, 6.46, A1.12  
Allele-specific oligonucleotides (ASO), 13.91, 13.95  
Allyl alcohol, 12.70–12.71  
 $\alpha$ -amanitin, 17.29  
 $\alpha$ -complementation, 1.149–1.150  
in BAC vectors, 4.3  
in  $\lambda$  vectors, 11.22, 11.25  
in M13, 3.8, 3.10, 3.33  
in pMAL vectors, 15.40  
problems with, 1.27, 1.150  
in protein-protein interaction assays, 18.127  
protocol, 1.123–1.125  
in pUC vectors, 1.10, 3.9  
 $\alpha$ -galactosidase (MEL1), 18.14  
 $\alpha$ -thrombin, 15.8  
Altered sites II in vitro mutagenesis system, 13.89  
*Alteromonas espejana*, 13.62, 13.71–13.72, A4.43  
*AluI* cleavage of 7-deaza-dGTP-modified DNA, 8.60  
*AluI* methylase, A4.7  
AMAD. *See* Another MicroArray database  
Amber mutation, A7.5  
in  $\lambda$  S gene, 2.15  
in M13 vectors, 3.11–3.13  
*supE* mutation, 3.11–3.13  
Amber suppressors, A7.5–A7.6  
Amberlite XAD-16, A8.28  
Ambion, 1.64  
Amidine, 16.11  
Amine-coupling kit, 18.104  
Amino acids  
codon usage, A7.2–A7.4  
hydrophobicity/hydrophilicity scales, A9.31  
nomenclature, table of, A7.7  
overview, A7.6  
properties, table of, A7.8–A7.9  
side chain properties, A7.7  
Venn diagram of, A7.6  
*N*-(4-aminobutyl)-*N*-ethylisoluminol (ABEI), A9.18  
Aminoformamide hydrochloride. *See* Guanidinium chloride  
Aminoglycoside phosphotransferase, 16.47–16.48  
Aminophosphotransferases (APHs), 1.145  
Aminopterin, 16.47, 16.48  
Ammonium acetate  
in ethanol precipitation of nucleic acids, A8.12  
in ethanol precipitation of oligonucleotides, 10.20–10.21  
recipe, A1.25  
Ammonium hydroxide, A1.6  
Ammonium ion inhibition of T4 polynucleotide kinase, A4.35  
Ammonium persulfate, 5.41–5.43, 7.58, 12.75, 12.78, 12.82, 13.53–13.54, A1.25, A8.42  
Ammonium sulfate, 8.9, 11.43, 11.45  
in long PCR buffer, 8.78  
in PCR lysis solution, 6.22  
*ampC*, 15.26  
Amphotericin, A2.7  
Ampicillin, 1.9  
mechanism of resistance to, 1.148  
modes of action, 148, A2.7  
properties, 1.148  
satellite colonies, 1.148  
selecting transformants, 1.110, 1.115, 1.118  
stock/working solutions, A2.6  
Ampicillin resistance gene (*amp<sup>r</sup>*) gene, 1.9  
in activation domain fusion plasmids, 18.20  
in LexA fusion plasmids, 18.19  
in pMC9, 14.6  
in two-hybrid system of reporter plasmids, 18.12  
Amplification  
of bacteriophage, in situ, 2.95  
of cDNA libraries, 11.64–11.66  
of cosmid libraries  
on filters, 4.31–4.32  
in liquid culture, 4.28–4.30  
on plates, 4.34  
of genomic libraries, 2.87–2.89  
for hybridization procedures, 1.128, 1.131  
of plasmids  
chloramphenicol and, 1.4, 1.39, 1.48, 1.56, 1.128, 1.131, 1.143  
runaway plasmid vectors, 1.13  
Amplification buffer, A1.9  
Amplification refractory mutation system (ARMS), 13.91, 13.96  
Amplify scintillant, A9.12  
AmpliTag DNA polymerase. *See also* Taq DNA polymerase  
AmpliTag Gold, 8.110  
CS DNA polymerase, 12.54  
in cycle sequencing reactions, 12.46–12.47  
structure of, 12.47  
FS DNA polymerase  
in cycle sequencing reactions, 12.46–12.47  
in DNA sequencing  
automated, 12.98  
dye-primer sequencing, 12.96  
dye-terminator systems, 12.96–12.97  
structure of, 12.47  
properties, table of compared, A4.11  
Ampliwax PCR Gems, 8.110  
AMPDP. *See* Adamantyl 1,2-dioxetane phosphate  
*amp<sup>r</sup>*. *See* Ampicillin resistance gene (*amp<sup>r</sup>*) gene  
Amylose agarose, affinity chromatography use of, 15.40–15.43  
Analytical ultracentrifugation, 18.96  
Anion-exchange chromatography, DNA purification by, 5.26–5.28  
Annealing buffer in nuclease S1 mapping of RNA, 7.55, 7.58  
Annealing reactions  
CTAB and, 6.62  
in PCR, 8.8–8.9  
in primer extension assays, 7.76, 7.79  
in ribonuclease protection assay protocol, 7.73  
in S1 protection assays, 7.51  
Annealing temperature  
in inverse PCR, 8.85  
in long PCR, 8.80  
in touchdown PCR, 8.112  
Another MicroArray database (AMAD), A10.15  
Antibiotics. *See also* specific antibiotics  
modes of action, table of, A2.7

- for protein expression optimization, 15.19  
as selectable markers, 1.8–1.9  
stock/working solutions, A2.6
- Antibodies**, A9.25–A9.34  
antipeptide, A9.30–A9.33  
applications, A9.25  
coimmunoprecipitation, 18.60–18.68  
conjugated, A9.33–A9.34  
  biotinylated, A9.33  
  enzyme, A9.34  
  fluorochrome, A9.33  
Cy3 labeling, 18.82–18.83  
digoxigenin-specific, A9.40  
epitope tagging, 1.14, 17.32, 17.90–17.93  
Fab fragment generation and purification, 18.81–18.82  
GFP, 17.89  
immunological assays, A9.27–A9.30  
  immunoblotting, A8.54–A8.55  
  immunoprecipitation, A9.29  
  RIA, A9.29–A9.30  
  western blotting, A9.28  
immunological screening  
  antibody choice for, 14.50–14.51  
  polyclonal vs. monoclonal, 14.50  
  purification, 14.51  
phage display of, 18.122  
probes for screening expression libraries, 14.1–14.2  
protein microarrays, A10.18  
purification of, A9.25–A9.27  
radiolabeling, A9.30  
removal of cross-reactive  
  affinity chromatography, 14.28–14.30  
  incubation with *E. coli* lysate, 14.26–14.27  
  pseudoscreening, 14.23–14.25  
in SPR spectroscopy of protein interactions, 18.103–18.114  
use in supershift assays, 17.17
- Antipain dihydrochloride, A5.1  
Antipeptide antibodies, A9.30–A9.33  
Antipporter proteins, 1.26, 1.146  
Antisense primer, 8.46–8.48, 8.50, 8.52, 8.56–8.57, 8.61, 8.63, 8.69, 8.90–8.92  
Antitermination factors in  $\lambda$ , 2.6–2.8, 2.11  
Antithrombin III, A5.1
- Apal**  
cleavage at end of DNA fragments, A6.4  
fragment size created by, table of, A4.8  
site frequency in human genome, 4.16, A6.3
- APHs. *See* Aminophosphotransferases  
APMSE, A5.1  
Aprotinin, 18.67, A5.1  
  in cell resuspension buffer, 17.6  
  as protease inhibitor, 15.19  
Aptamers, peptide, 18.8  
Apurinic DNA, screening expression libraries, 14.2
- Arabidopsis**  
database, A11.20  
genomic resources for microarrays, A10.6
- Arginine**  
for affinity purification of fusion proteins, 15.6  
codon usage, A7.3  
nomenclature, A7.7  
properties, table of, A7.8
- ARMS. *See* Amplification refractory mutation system
- Arrayed libraries, 4.8  
  BAC, 4.50  
  differential screening, 9.90  
  PI, 4.39  
  YAC, 4.61
- Arrays. *See* DNA array technology  
ArrayVision image analysis program, A10.13
- AscI**  
cleavage at end of DNA fragments, A6.4  
fragment size created by, table of, A4.8  
genomic DNA mapping, 5.68–5.69  
site frequency in human genome, 4.16, A6.3
- AscI**, A4.9  
Asialofetuin, for protein stability, 17.16  
Asparagine  
  codon usage, A7.3  
  nomenclature, A7.7  
  properties, table of, A7.8
- Aspartic acid**  
cleavage by formic acid, 15.6, 15.8  
codon usage, A7.3  
nomenclature, A7.7  
properties, table of, A7.8
- Aspergillus oryzae**, A4.46  
Aspiration of supernatants, 1.33, 1.36, 1.45  
Assembly of bacteriophage particles,  $\lambda$ , 2.14–2.15  
ASSET (Aligned Segment Statistical Evaluation Tool) program, A11.9
- AstilI**, A4.7  
Atlas cDNA arrays, A10.9  
ATP. *See* Adenosine triphosphate  
*att* sites,  $\lambda$ , 2.16, 2.18  
AU epitopes, 17.93  
Authorin program, A11.3  
**Autographa californica** nuclear polyhedrosis (AcNPV or AcMNPV), 17.81–17.83  
Autonomously replicating sequence (ARS), 4.2–4.3, 4.60
- Autoradiography**, A9.9–A9.15  
of alkaline agarose gels, 5.39  
chemical DNA sequencing gels and, 12.61–12.62, 12.74, 12.90–12.91  
chemiluminescent, 14.11–14.12, 14.21–14.22  
in coimmunoprecipitation protocol, 18.62–18.63  
DNase I footprinting, 17.76  
fluorography, A9.12  
imaging, A9.9–A9.10  
intensifying screen, A9.11  
isotopes used  
  decay data, A9.15  
  particle spectra, A9.9–A9.10  
  sensitivity of detection, A9.13  
  mutation detection with SSCP, 13.52, 13.55  
  phosphorimaging, A9.11–A9.14  
  phosphorimaging devices, A9.14  
  polyacrylamide gels, DNA detection in, 5.49  
  preflashing, A9.11–A9.12  
  reading an autoradiograph, 12.113  
  setting up autoradiographs, A9.13–A9.14
- AvaiI** in phosphorothioate incorporation mutagenesis, 13.86  
**Avian myeloblastosis virus (AMV)**, 11.109. *See also* Reverse transcriptase  
  reverse transcriptase, A4.24–A4.25  
  RNA-dependent DNA polymerase, 8.48  
  RNase H activity, 11.109
- Avidin**, 11.115–11.117, A9.45  
**Avidin-biotin (ABC) assay**, A9.33  
**AvrII**  
cleavage at end of DNA fragments, A6.4  
fragment size created by, table of, A4.8  
site frequency in human genome, 4.16, A6.3  
2,2'-azino-di(3-ethylbenzthiazoline-6-sulphonic acid) (ABTS), A9.35
- BAC. See** Bacterial artificial chromosomes  
**Bacillus subtilis**  
  expression in, 15.55  
  genomic resources for microarrays, A10.6  
**Bacterial alkaline phosphatase (BAP)**, 9.92–9.93, A4.37  
**Bacterial artificial chromosomes (BACs)**, 4.48–4.57  
  advantages of, 4.48  
   $\alpha$ -complementation in, 4.3  
  CIT Human BAC Library, 4.9  
  clone size, 4.3–4.4  
  copy number, 4.48  
  DNA purification  
    from large-scale cultures, 4.55–4.57  
    from small-scale cultures, 4.53–4.54  
  electroporation, 4.49, 4.52  
  genomic libraries  
    arrayed libraries, 4.8  
    choosing for construction of, 4.7–4.10  
    construction, 4.49–4.50  
    RPCI-11 Human BAC Library, 4.9  
    screening, 4.50–4.51  
  low-copy-number replicons, 1.3  
  overview, 4.2–4.4  
  size of inserts, 4.49  
  storage, 4.51  
  vectors, A3.5  
**Bacterial colonies**, screening by PCR, 8.74–8.75  
**Bacterial cultures**  
  receiving in the laboratory, 1.29  
  storage of, A8.5  
**Bacterial strains. See** *Escherichia coli* strains  
**Bacteriophage**  
   $\phi$ 1. *See*  $\phi$ 1 bacteriophage  
   $\phi$ X174. *See*  $\phi$ X174 bacteriophage  
   $\lambda$ . *See*  $\lambda$  bacteriophage  
  M13. *See* M13 bacteriophage  
  P1. *See* P1 bacteriophage  
  SP6. *See* SP6 bacteriophage  
  T3. *See* T3 bacteriophage  
  T4 DNA ligase buffer, A1.9  
  T4 DNA polymerase buffer, A1.10  
  T4 DNA polymerase repair buffer, 11.53  
  T4 polynucleotide kinase buffer, A1.10  
  T7. *See* T7 bacteriophage  
**Bacteriophages. See also specific bacteriophages**  
  CsCl density gradients purification of, 1.155  
  filamentous, 3.1–3.7  
  historical perspective, 2.109  
  male-specific, 3.2  
  origin of replication, 1.11  
  phagemids, 1.11  
  promoters, 1.11–1.12, 9.31. *See also* Promoters; *specific promoters*  
**Baculovirus**, 17.81–17.84  
  expression systems  
    commercial, 17.84  
    drawbacks of, 17.83  
  vectors, 17.83  
  gene expression in, 17.82  
  history, 17.81  
  host interactions, 17.81–17.82  
  as pesticides, 17.81  
  vectors, 17.83  
**Baking hybridization membranes**, 6.46  
BAL 31 buffer, A1.10  
BAL 31 nuclease, 13.2  
  activities of, 13.68  
  endonuclease activity, A4.44–A4.45  
  exonuclease activity, A4.44–A4.45  
  assaying activity of, 13.64–13.65  
  checking progress of digestion, 13.71  
  deletion mutant sets, generation of bidirectional, 13.62–13.67  
  materials for, 13.62–13.63  
  protocol, 13.63–13.67  
  fast and slow forms, A4.44  
  heat inactivation of, 13.65  
  history of, 13.71–13.72  
  inhibition by EGTA, 13.64  
  overview, 13.68–13.72, A4.43–A4.45  
  properties of, 13.68–13.71  
  storage, A4.44  
  unidirectional mutations, generation of, 13.68, 13.70  
  uses, list of, A4.43

- Bam*HI  
7-deaza-dGTP modified DNA, cleavage of, 8.60  
cleavage at end of DNA fragments, A6.4  
*dam* methylation and, 13.87, A4.3  
directional cloning use of, 1.84  
fragment size created by, table of, A4.8  
linker sequences, 1.99  
methylase, A4.7  
site frequency in human genome, 4.16, A6.3  
in USE, 13.85
- Band-stab PCR of samples from gel, 8.71  
BankIt program, A11.3  
BAP. See Bacterial alkaline phosphatase  
Barcode chip, A10.19  
Barnase in positive selection vectors, 1.12  
Base-excision repair, exonuclease III and, 13.73  
Batch chromatography, selection of poly(A)<sup>+</sup> RNA by, 7.18–7.19
- BAX* gene, 17.72  
Bayes Block Aligner program, A11.4–A11.5  
Baylor College of Medicine Search Launcher, A11.2  
BB4 *E. coli* strain, 2.29, 11.23–11.25, 11.60–11.62, 11.66, 14.6, A3.6  
BCIP 5-bromo-4-chloro-3-indolyl phosphate), 9.78, 14.9–14.10, 14.20, A9.39–A9.42  
*Bcl*I, 13.87, A4.3, A4.9  
BEAUTY (BLAST Enhanced Alignment Utility) program, A11.17  
Beckman Coulter Multimek, A10.5  
Benzamide as protease inhibitor, 15.19  
BES-N,N-bis[2-hydroxyethyl]-2-aminoethanesulfonic acid), 16.19  
BES-buffered saline (BBS), 16.19–16.20  
Bestatin, A5.1  
 $\beta$ -actin, normalizing RNA samples against, 7.22  
 $\beta$ -galactosidase, 17.97–17.99. See also Fusion proteins; *lacZ*  
 $\alpha$ -complementation, 1.26–1.27, 1.123, 1.125, 1.149–1.150  
antibody conjugates, A9.34  
assay of activity by chloroform overlay assay, 18.28  
chemiluminescent enzyme assay, A9.19  
fusion proteins, 15.26  
affinity purification of fusion proteins, 15.6  
disadvantages, 15.58  
inclusion bodies, 15.58  
vectors for, 15.59  
histochemical stains, 17.98–17.99  
immunohistochemical staining of cell monolayers for, 16.13  
ONPG substrate, 17.50–17.51  
in protein-protein interaction assays, 18.127  
quantitative assays  
MUG hydrolysis, 17.98  
ONPG hydrolysis, 17.97–17.98  
reaction catalyzed by, 17.98–17.99  
reporter assays, 17.48–17.51  
as digoxigenin reporter enzyme, 9.77  
endogenous mammalian  $\beta$ -galactosidase activity, 17.48  
materials for, 17.50  
method, 17.51  
normalizing reporter enzyme activity to  $\beta$ -galactosidase activity, 17.48, 17.51  
overview, 17.48–17.49  
p $\beta$ -gal reporter vectors, 17.49  
substrates for  $\beta$ -galactosidase, 17.51  
substrates, 17.50  
as transfection control (reporter gene), 16.4, 16.12–16.13  
vectors containing. See also specific vectors  
Bluescript plasmid, 1.27  
expression vectors, 14.47–14.48  
 $\lambda$  vectors, 2.30, 11.22, 11.25  
pGEM, 1.27  
pMAL vectors, 15.40  
pUC vectors, 1.10  
X-gal, 1.149  
 $\beta$ -glucuronidase, 16.42, 18.14  
 $\beta$ -glucuronidase lysis solution, 18.46  
 $\beta$ -lactamase  
mechanism of action, 1.148  
satellite colonies and, 1.110, 1.115, 1.118  
 $\beta$ -mercaptoacetic acid, 15.44  
 $\beta$ -mercaptoethanol, 15.44  
 $\beta$ -nicotinamide adenine dinucleotide ( $\beta$ -NAD), 11.43, 11.45
- Bgl*II  
fragment size created by, table of, A4.8  
linker sequences, 1.99  
site frequency in human genome, 4.16, A6.3
- Bgl*III  
cleavage at end of DNA fragments, A6.4  
*dam* methylation and, 13.87, A4.3  
directional cloning use of, 1.84  
fragment size created by, table of, A4.8  
site frequency in human genome, 4.16, A6.3  
in USE, 13.85
- BHB2688 *E. coli* strain  
genotype, A3.6  
 $\lambda$  vector propagation, 2.29
- BHB2690 *E. coli* strain  
genotype, A3.6  
 $\lambda$  vector propagation, 2.29
- BIAcore, 18.96–18.114  
BIAevaluation software, 18.97, 18.101–18.102, 18.112  
BIAsimulation software, 18.98  
chips, 18.98–18.100  
components of, 18.97  
Interaction Wizard, 18.108  
protocol design, 18.102–18.114  
sensorgrams, 18.100–18.101, 18.112–18.114  
writing methods with BIAcore Method Definition Language, 18.108  
BIAevaluation software, 18.97, 18.101–18.102, 18.112  
BIAsimulation software, 18.98  
Bidirectional dideoxy fingerprinting (Bi-ddF), 13.91, 13.94  
BigDye terminators, 12.96–12.99  
Binary expression system, 9.88  
Binding buffer, 14.33, 15.45  
BioChip Arrayer, A10.16  
BioChip Imager, A10.11  
Bioelectric chips, A10.19  
Bio-Gel HTP, A8.33  
Bio-Gel P-60, 10.26, A8.29–A8.30  
*bio* gene,  $\lambda$  transduction of, 2.18  
Bioinformatics, A10.15, A11.1–A11.23  
databases, A11.20–A11.21  
DNA, A11.20–A11.21  
microarray, A10.15  
protein, A11.22–A11.23  
RNA, A11.21–A11.22  
database similarity search software (Table A11-2), A11.18–A11.19  
software (Table A11-1), A11.3–A11.7  
DNA, A11.3–A11.14  
genes, exons and introns, A11.10–A11.12  
motifs and patterns, A11.8–A11.10  
promoters, transcription-factor-binding sites, A11.12–A11.13  
regulatory sites, miscellaneous, A11.14  
scoring matrices, A11.5  
sequence alignment, A11.3–A11.8  
sequence submission, A11.3  
protein, A11.16–A11.17  
motifs, patterns, and profiles, A11.16–A11.17  
sequence alignment, A11.16  
RNA, A11.14–A11.15  
RNA-specifying genes, motifs, A11.15  
secondary structure, A11.14–A11.15  
Web site resources, A11.2
- Biologic PDS-1000/He Particle Delivery System, 16.39  
Biologics, 16.3, 16.37–16.41  
materials for, 16.38–16.39  
method, 16.39–16.41  
particle types, 16.37  
variables, 16.37  
Bioluminescence, A9.21–A9.24  
bacterial luciferase, A9.23–A9.24  
firefly luciferase, A9.21–A9.23  
assays for, A9.22–A9.23  
properties of, A9.21–A9.22  
as reporter molecule, A9.23  
GFP, A9.24  
Bioluminescent resonance energy transfer (BRET), 17.87–17.89  
Biomolecular Structure and Modeling group at the University College, London, A11.22  
BioRobot (Qiagen), A10.5  
Biotin, 9.76–9.79, A9.45  
bridged avidin-biotin (BRAB) assay, A9.33  
CARD protocol and, A9.19  
derivatives, 11.116  
labeling  
antibodies, A9.33  
in cycle DNA sequencing, 12.52  
direct selection of cDNAs protocol, 11.98–1.99, 11.102, 11.106  
enzymatic labeling, 9.77–9.78  
GST, 18.50  
of nucleic acids, 11.116–11.117  
photolabeling, 9.78  
probes, for in situ hybridization, 9.35  
of proteins, 11.115–11.117  
in subtractive hybridization, 9.91  
overview, 11.115  
structure of, 11.116, A9.45  
in SPR spectroscopy, 18.99  
Biotin:avidin affinity chromatography, 11.11  
Bisacrylamide, 12.74–12.75, A8.40–A8.41. See also Polyacrylamide gel electrophoresis  
storage, 12.75  
Bis-Tris, 7.28  
Bis-Tris-Cl, 5.33  
Bisulfite, mutagenesis from, 13.78  
BL21 *E. coli* strain, 15.21–15.23, A3.6  
*bla* gene, 1.148  
BLAST (Basic Alignment Search Tool) program, A11.3, A11.18  
BLAST2 (Gapped-BLAST) program, A11.18–A11.19  
BLAST-Genome Sequences program, A11.19  
Bleomycin modes of action, A2.7  
BLIMPS-BLOCKS Improved Searcher program, A11.9  
Blocking agents, A1.14–A1.16, A8.54  
for nucleic acid hybridization, A1.14–A1.15  
for western blotting, A1.16  
Blocking buffer, 14.4, 14.9, 14.15, 14.23, 14.26, A1.12  
BLOCKS server program, A11.9  
Blood cells  
buffy coat removal by aspiration, 6.9  
collection of cells  
from freshly drawn blood, 6.8–6.9  
from frozen blood, 6.9  
lysis of, 6.8–6.9  
BLOSUM scoring matrices program, A11.5  
BLOTTO (Bovine Lacto Transfer Technique Optimizer)  
in northern hybridization, 7.45  
for protein stability, 17.16  
recipe, A1.15



- in Southern hybridization, 1.139, 6.56, A1.14–A1.15
- Bluescript vectors. *See* pBluescript vectors
- Blunt-ended DNA
- addition of synthetic linkers to, 1.98–1.102
  - cloning, 1.22–1.24
    - of PCR products, 8.32–8.34
    - into plasmid vectors, 1.90–1.92
  - creation with T4 DNA polymerase, A4.19
  - end-labeling with Klenow, 9.52–9.53, 9.55–9.56
  - generation by mung bean nuclease, 7.87
  - ligation with T4 DNA ligase, A4.31–A4.32
  - linker/adaptor ligation, 11.51–11.52
  - phosphorylation of, 9.70–9.72
  - radiolabeling using Klenow, 12.101
- BMH71-18 *E. coli* strain, 13.29
- BNN93 *E. coli* strain
- genotype, A3.6
  - $\lambda$  vector propagation, 2.28
- BNN102 *E. coli* strain, 4.83–4.84, 11.59–11.60, 11.62, 11.64–11.65
- genotype, A3.6
  - $\lambda$  vector propagation, 2.28
- Boiling lysis plasmid DNA protocols
- large-scale, 1.47–1.50
  - overview, 1.43
  - small-scale, 1.44–1.46
  - yield, 1.50
- Bolton-Hunter reagent, A9.30
- Bombyx mori* nuclear polyhedrosis virus (BmNPV), 17.81
- bom* region, 1.146
- Bovine growth hormone (BGH) poly(A) signal, 17.72
- Bovine Lacto Transfer Technique Optimizer. *See* BIOTTO
- Bovine milk casein for protein stability, 17.16
- Bovine serum albumin (BSA)
- as blocking agent, A8.54
  - in long PCR buffer, 8.78
  - in PCR, 8.23
  - for protein stability, 17.16
  - SDS absorption by, 6.25
- Bovine submaxillary mucin (type1) for protein stability, 17.16
- BPTF electrophoresis buffer, 7.28–7.29, A1.17
- BRAB. *See* Bridged avidin-biotin assay
- BRET. *See* Bioluminescent resonance energy transfer
- Bridged avidin-biotin (BRAB) assay, A9.33
- Brilliant Blue. *See* Coomassie Brilliant Blue
- BRITE database, A10.15
- 5-Bromo-4-chloro-3-indolyl phosphate. *See* BCIP
- 5-Bromo-4-chloro-3-indolyl- $\beta$ -D-galactoside. *See* X-gal
- Bromocresol green in alkaline agarose gel electrophoresis, 5.36
- 5-Bromodeoxyuridine (BrdU), 9.76, 16.47
- Bromophenol blue, 5.36
- in agarose gel electrophoresis gel-loading buffers, 1.53, 5.9
  - in denaturing agarose gels, 7.23
  - in formaldehyde gel-loading buffer, 7.32
  - in formamide buffers, 7.77, 17.6
  - inhibition of PCR by, 8.13
  - migration rate through polyacrylamide gels, 12.89
  - oligonucleotide size and comigration in polyacrylamide, 10.15
  - polyacrylamide gel electrophoresis, 5.42, 7.57
  - recipe, A1.18
  - in RNA gel-loading buffer, 7.68
  - in SDS gel-loading buffer, A8.42
  - sucrose solution, 17.14, A1.19
  - Taq* polymerase inhibition by, 1.53
- BSA. *See* Bovine serum albumin
- BSC-1 cell lines, 16.27
- Bst*WI cleavage at end of DNA fragments, A6.4
- Bsp*EI cleavage at end of DNA fragments, A6.4
- Bsp*MII methylation, A4.7
- Bsr*GI cleavage at end of DNA fragments, A6.4
- Bss*HII
- cleavage at end of DNA fragments, A6.4
  - fragment size created by, table of, A4.8
  - genomic DNA mapping, 5.60, 5.69
  - site frequency in human genome, 4.16, A6.3
- Bst* DNA polymerase, 8.10, A4.23
- Bst*BI, 5.69
- Bst*EII, A4.9
- Bst*NI, A4.9
- Bst*XI in exon amplification protocol, 11.79, 11.82, 11.89, 11.92
- Bsu*36I in end-labeling, selective, 9.52
- Btag, epitope tagging, 17.93
- Buffers, A1.2–A1.22. *See also specific buffer types and uses; specific buffers*
- electrophoresis, 5.7–5.8, A1.17–A1.18
  - enzyme dilution, A1.9
  - enzyme reaction, A1.9–A1.12
  - extraction/lysis buffers, A1.16
  - gel-loading, 5.9, A1.18–A1.20
  - hybridization buffers, A1.12–A1.13
  - pH, A1.7–A1.8
  - phosphate, A1.5
  - properties of good buffers, A1.3–A1.4
  - restriction
    - DNA migration in agarose, effect on, 5.10
    - sequential use of, 1.86
    - Tris, A1.2–A1.3
- Buffy coat, removal by aspiration, 6.9
- Butanol, 12.70–12.71
- concentrating nucleic acids by extraction with, A8.18
  - for removal of ethidium bromide from DNA, 1.73, 1.151, A8.27
- <sup>14</sup>C
- particle spectra, A9.10
  - sensitivity of autoradiographic methods for detection, A9.13
- C600 *E. coli* strain, 11.59–11.60, 11.62, 11.65, 15.32
- genotype, A3.6
  - $\lambda$  vector propagation, 2.28
- Caenorhabditis elegans*
- genomic resources for microarrays, A10.6
  - protein interaction mapping, 18.124
- Caging, 17.13
- Cairns, 1.6, 2.11, 3.2
- Calcium (Ca<sup>2+</sup> ions and exonuclease III, 13.73
- Calcium chloride (CaCl<sub>2</sub>), A1.25
- in  $\lambda$  stock preparation, 2.35, 2.37, 2.39
  - preparation and transformation of competent *E. coli* using, 1.116–1.118
  - in transfection of eukaryotic cells, 16.16, 16.19–16.20, 16.23
- Calcium-phosphate-mediated transfection, 16.3, 16.14–16.26, 16.52–16.53
- of adherent cells, 16.25
  - of cells growing in suspension, 16.26
  - chloroquine treatment, 16.14, 16.17, 16.52
  - cotransformation, 16.24
  - efficiency, factors affecting, 16.52
  - with genomic DNA, 16.21–16.24
  - glycerol shock, 16.14, 16.17, 16.52
  - high efficiency, 16.19
  - mutation prevalence, 16.53
  - with plasmid DNA, 16.14–16.20
  - sodium butyrate, 16.14, 16.17–16.18
- Calcium phosphate transfection
- Escort, 16.5
  - Kit, 16.5
  - System, 16.5
- Calcium tungstate intensifying screens, A9.11
- Cal intestinal alkaline phosphatase (CIP), 1.95–1.96, 2.69, 9.62–9.64, 9.92–9.93, A4.37. *See also* Alkaline phosphatase
- in cosmid library construction protocol, 4.17–4.21
  - dephosphorylation of M13 vector DNA, 12.24
  - inactivation of, 1.96, 9.64, 9.93
  - properties of, 9.93
  - RNA dephosphorylation, 9.65
- Call* *dam* methylation and, 13.87
- Calpain inhibitor I and II, A5.1
- CalPhos Mammalian Kit, 16.5
- cAMP, 3'-5', 2.7
- cAMP-dependent protein kinase, 18.49, 18.51
- cAMP response element-binding protein (CREB), 18.11
- Candida albicans*, genomic resources for microarrays, A10.6
- CAP, 15.57, 17.80, 18.127
- Capillary transfer of DNA from agarose gels to solid supports
- depurination/hydrolysis, 6.34–6.35
  - downward transfer, 6.35–6.36, 7.26, 7.40–7.41
  - northern hybridization, 7.25–7.26, 7.36, 7.38–7.41
  - protocols for, 6.39–6.49
  - transfer to two membranes, 6.35–6.36, 6.47–6.49
  - upward transfer, 6.34–6.35, 7.25–7.26, 7.36, 7.38–7.39
- Capped RNAs, 9.88
- Carbenicillin, 1.148
- modes of action, A2.7
  - stock/working solutions, A2.6
- Carbodiimide, 13.95
- Carbonic anhydrase II and affinity purification of fusion proteins, 15.6
- CARD. *See* Catalyzed reporter deposition protocol
- Carrier RNA, 5.20, 7.69
- Cassette mutagenesis, 13.79
- CAT. *See* Chloramphenicol acetyltransferase
- cat* gene, 1.144
- CAT reaction mixtures, 17.36, 17.40–17.41
- Catalyzed reporter deposition protocol, A9.19
- CATH database, A11.22
- Cathepsin B, 16.52–16.53
- ccdB* gene in positive selection vectors, 1.12
- CCD cameras, 5.15–5.16, 18.76, 18.91–18.92, 18.94
- CCM. *See* Chemical cleavage of mismatched bases
- CDI modification, 13.95
- cDNA. *See also* cDNA cloning; cDNA libraries; cDNA synthesis
- adaptor use, 1.160
  - blunt-end ligation of, 11.51–11.52
  - clone analysis by PCR, 2.105
  - differentially expressed, isolating, 9.89–9.91
  - differential screening, 9.89–9.90
  - plus/minus screening, 9.89–9.90
  - random sampling, 9.89
  - subtractive screening, 9.90–9.91
- E. coli* DNA ligase use, 1.159
- end modification of cloned, 8.42
  - expression library construction, 14.48–14.49
  - full-length clones, low-yield of, 8.60
  - length, measurement by alkaline agarose gel electrophoresis, 5.36
  - linker use with, 1.99–1.100
  - methylation of, 11.48–11.50
  - microarray analysis, A10.3–A10.6, A10.9–A10.10, A10.14
- PCR techniques
- amplification of 3' ends, 8.61–8.65
  - amplification of 5' ends, 8.54–8.60
  - characterization of cloned segments in prokaryotic vectors, 8.72–8.76
  - differential display-PCR, 8.96–8.106

## 1.6 Index

- cDNA (continued)
    - end modification, 8.42
    - long PCR, 8.77
    - mixed oligonucleotide-primed amplification, 8.66–8.71
    - RT-PCR, 8.46–8.53
    - in primer extension assays, 7.75–7.76
    - probe construction
      - subtracted
        - by random extension, 9.46–9.50
        - using oligo(dT) primers, 9.41–9.45
        - using oligo(dT) primers, 9.41–9.45
        - using random primers, 9.38–9.40
      - tailing reaction, 8.58–8.59
  - cDNA cloning. *See also* cDNA libraries, construction
  - fidelity of, 11.5
  - history of methods to synthesize and clone, 11.3–11.5
  - linkers and adaptors, 11.20–11.21
  - methylation, 11.21
  - mRNA preparation for
    - enrichment methods, 11.8–11.11
      - fractionation of cDNA, 11.9–11.10
      - fractionation of mRNA, 11.9
      - number of clones needed for library, 11.8
      - overview, 11.8–11.9
      - polysome purification, 11.10
      - subtractive cloning, 11.10–11.11
    - integrity of mRNA, 11.7–11.8, 11.39, 11.42
    - source of mRNA, 11.6–11.7
  - PCR error rate, 11.5
  - screening. *See* cDNA libraries, screening strategies for, 11.5, 11.6
  - vectors, 11.21–11.26
    - $\lambda$ gt10/ $\lambda$ gt11, 11.25, 11.27
    - $\lambda$ ZAP, 11.22
    - $\lambda$ ZAP Express, 11.22–11.25
    - $\lambda$ ZAPII, 11.22–11.23
    - $\lambda$ ZipLox, 11.25–11.26
    - plasmids, 11.25
- cDNA libraries, 11.1–11.124. *See also* Expression libraries, screening
  - amplification, 11.64–11.66
    - in  $\lambda$ gt10, 11.64–11.65
    - in  $\lambda$ gt11,  $\lambda$ ZAP,  $\lambda$ ZipLox, 11.65–11.66
  - arrayed libraries, 4.8
  - construction
    - cDNA synthesis, 11.11–11.20
      - first-strand, 11.11–11.14, 11.38–11.42
      - second-strand, 11.14–11.20, 11.43–11.47
    - enrichment methods, 11.8–11.11
    - eukaryotic expression, 11.68–11.73
      - controls, 11.70
      - factors influencing success, 11.69–11.70
      - host/vector systems, 11.69
      - options, 11.68
      - vector systems for, 11.72
    - fractionation of cDNA, 11.56–11.58
    - kits for, 11.107–11.108
    - ligation of cDNA into plasmid vector, 11.63
    - ligation of cDNA to  $\lambda$  arms, 11.59–11.61
    - linkers and adaptors, 11.20–11.21, 11.51–11.55
    - methylation of cDNA, 11.48–11.50
    - polishing cDNA termini, 11.43, 11.45, 11.54
    - from small numbers of cells, 11.112
    - subtractive cloning, 11.10–11.11
    - troubleshooting, 11.64
    - vectors for, 11.21–11.26
  - custom-made, 11.107
  - differential screening, 9.89–9.90
  - direct selection, 11.98–11.106
    - amplification, 11.104–11.105
    - biotin labeling, 11.102
    - blocking repetitive sequences, 11.103, 11.105–11.106
    - linkered pool preparations, 11.102
    - materials for, 11.100–11.101
    - overview, 11.98–11.100
    - primary selection, 11.105
    - secondary selection, 11.105
    - streptavidin bead preparation, 11.103
    - troubleshooting, 11.106
  - eukaryotic expression, 11.68–11.78
    - exon trapping/amplification, 11.79–11.97
    - flow chart for construction and screening, 11.2
    - in  $\lambda$  vectors, 2.23
    - number of clones needed, calculating, 11.8
    - oligonucleotide probes for
      - degenerate pools, 10.5–10.6
      - length of, 10.4
    - screening, 11.26–11.34
      - by binding to specific ligands, 11.32–11.33
      - double-stranded DNA probes, 11.33
      - immunoglobulin probes, 11.32–11.33
    - direct selection of cDNAs, 11.35, 11.98–11.106
    - eukaryotic expression, 11.74–11.78
      - controls, 11.74–11.75
      - protocols, 11.76–11.78
      - screening pools, 11.74
    - exon trapping, 11.35
      - by expression, 11.33–11.34
      - by hybridization, 11.27–11.32
        - homologous probes, 11.27
        - similar sequence probes, 11.28–11.29
        - subtracted cDNA probes, 11.29–11.31
        - synthetic oligonucleotide probes, 11.31–11.32
      - total cDNA probes, 11.29
      - zoo blots, 11.28
    - by PCR, 11.32
    - for protein-protein interactions, 18.30–18.48
    - by subtracted cDNA probes, 9.46, 9.90–9.91
    - validation of clones selected, 11.34
  - validation of clones, 11.34
- cDNA synthesis
  - in exon trapping/amplification protocol, 11.91–11.92
  - first-strand, 11.11–11.14, 11.38–11.42
    - methods, table of, 11.15
    - optimizing, 11.38, 11.42
    - primers for, 11.12–11.15, 11.39
      - oligo(dT), 11.12–11.13, 11.15, 11.39
      - random primers, 11.12–11.15, 11.39
    - protocol, 11.38–11.41
    - reverse transcriptase choice, 11.11–11.12, 11.38
    - troubleshooting, 11.42
    - yield, calculating, 11.41–11.42
  - kits for, 11.71, 11.107–11.108
  - Klenow fragment use, A4.15
  - reverse transcriptase, A4.25–A4.26
  - second-strand, 11.14–11.20, 11.43–11.47
    - oligonucleotide-primed, 11.17–11.20
    - optimizing, 11.46
    - protocol, 11.43–11.47
    - replacement synthesis, 11.16–11.17
    - self-primed, 11.14, 11.46
    - troubleshooting, 11.46
    - yield, calculating, 11.45
- CDP-*Star*, 9.79, A9.44
- CE6, bacteriophage, 15.20
- Cell fixative, 16.13
- Cell homogenization buffer, 17.4
- Cell lysis buffer, 15.35, 15.41, 15.50
  - for reporter assays, 17.44–17.45
- Cell numbers, estimation of
  - hemocytometer counting, A8.6–A8.7
  - viability staining, A8.7–A8.8
- Cell resuspension buffer, 17.6
- Cell walls
  - digestion of yeast, 4.60, 5.66–5.67
  - inhibition of restriction enzymes by components of, 1.33, 1.36, 1.42, 3.24
- Cell wash buffer, 5.65
- CellFECTIN, 16.5, 16.11
- CellPect Transfection Kit, 16.5
- Cellulose. *See also* DEAE-cellulose
  - affinity purification of fusion proteins, 15.6
  - oligo(dT), 7.14
- CEN4 (centromeric sequence), 4.60
- Centricon concentrator, 8.27–8.29, 8.58, 8.68, 12.106, 18.81–18.82
- Centrifugation
  - nomogram for conversion of rotor speed to relative centrifugal force, A8.39
  - rotors, table of commonly used, A8.39
- CEPH Mega YAC Library, 4.9
- cer region, 1.146
- Cerenkov counting, 9.69, 9.71, 9.75, 10.27, 11.58, 12.66, A8.25
- CES200 *E. coli* strain genotype, A3.6
- CES201 *E. coli* strain genotype, A3.6
- Cesium chloride (CsCl)
  - removal from bacteriophage suspensions, 2.57–2.58
  - removal from DNA, 1.73–1.75
- Cesium chloride (CsCl) density gradients
  - bacteriophage purification, 1.155
  - DNA form and density, 1.18
  - double-stranded DNAs, 1.154
  - ethidium bromide, 1.151
  - $\lambda$  particle purification, 2.47–2.51
    - collection of particles, 2.50
    - equilibrium gradient, 2.49, 2.51
    - step gradient, 2.48–2.49
  - properties of CsCl solutions, 1.155–1.156
  - purification of closed circular DNA
    - contamination by DNA/RNA fragments, 1.65
    - continuous gradients, 1.67–1.68
    - discontinuous gradients, 1.69–1.71
    - DNA collection from, 1.67–1.68, 1.71
    - rebanding, 1.68
  - RNA, 1.155, 7.4
  - single-stranded DNAs, 1.155
- Cetyltrimethylammonium bromide (CTAB), 6.61–6.62
  - DNA precipitation by, 6.62
  - in hybridization solutions, 6.61–6.62
  - polysaccharide removal, 2.105
  - for solubilization of inclusion bodies, 15.54
  - structure of, 6.62
- Cetylpyridinium bromide (CPB), 10.22–10.24
- CFLP PowerScan mutation detection system, 13.89
- Cfr61* methylase, A4.7
- Cfr91*, A4.7
- Chameleon Double-stranded Site-directed Mutagenesis Kit, 13.27, 13.89
- Chaotropic agents, 15.60. *See also specific agents*
  - DNA binding to silica, 1.63
  - for solubilization of proteins from pellets, 15.11
- Chaperones, 1.4
- Charged couple device (CCD)-based image detection systems, 5.15–5.16, 18.76, 18.91–18.92, 18.94
- Charon vectors, 2.12, 2.22, A3.3
- CHEF. *See* Contour-clamped homogeneous electric field
- Chemical cleavage of mismatched bases (CCM), 13.91, 13.95
- Chemical mutagenesis, 13.78–13.79
- Chemiluminescence, A8.55, A9.16–A9.20
  - alkaline phosphatase and, A9.40
  - AMPPD and, A9.42–A9.44
  - applications, table of, A9.18
  - assays for immunoassay and nucleic acid hybridization labels, table of, A9.17

- digoxigenin-labeled probes, A9.39–A9.40  
enzyme assays, A9.19–A9.20  
  alkaline phosphatase, A9.19  
   $\beta$ -galactosidase, A9.19  
  glucose oxidase, A9.20  
  horseradish peroxidase, A9.19  
  xanthine oxidase, A9.19  
horseradish peroxidase and, A9.35–A9.37  
labels, A9.17–A9.19  
luminometers, A9.20  
markers, 1.140, 2.98–2.99  
overview, A9.16–A9.17  
reactions, A9.16  
screening of expression libraries  
  in  $\lambda$  vectors, 14.11–14.12  
  in plasmid vectors, 14.21–14.22
- Chi ( $\chi$ ) site  
*E. coli*, 2.13  
 $\lambda$ , 2.13, 2.22
- ChIP (Chromatin immunoprecipitation), A10.18
- Chloramine T (*N*-chlorobenzenesulfonamide), 14.5, 14.16, A9.30
- Chloramphenicol. *See also* Chloramphenicol acetyltransferase  
*dam* strains and, 13.88  
mechanism of resistance to, 1.144  
modes of action, A2.7  
plasmid copy number amplification, 1.4, 1.39, 1.48, 1.56, 1.128, 1.131, 1.143  
properties and mode of action, 1.143–1.144  
for protein expression optimization, 15.19  
relaxed plasmid replication, 1.4  
resistance, 17.94  
stock/working solutions, A2.6  
structure of, 1.143
- Chloramphenicol acetyltransferase (CAT), 17.94–17.95  
affinity purification of fusion proteins, 15.6  
expression in mammalian cells, 17.95  
reaction catalyzed by, 17.94  
as reporter gene, 17.30–17.41, 17.95  
  aberrant transcription, 17.34  
  controls, 17.34  
  measurement  
    by diffusion of reaction products into scintillation fluid, 17.41  
    by extraction with organic solvents, 17.40  
    by thin-layer chromatography, 17.36–17.39  
  normalizing CAT activity to  $\beta$ -galactosidase activity, 17.48–17.49, 17.51  
  overview, 17.33–17.34  
  pCAT3 vectors, 17.35  
  quantitative assays, 17.95  
  as transfection-positive control, 16.4
- Chloramphenicol resistance gene ( $Cm^R$ )  
  in activation domain fusion plasmids, 18.20  
  in LexA fusion plasmids, 18.19  
  in two-hybrid system of reporter plasmids, 18.12
- Chloroform, 1.34. *See also* Phenol:chloroform extraction  
extraction  
  in hydroxyl radical footprinting protocol, 17.12  
  mineral oil removal from PCRs, 8.22  
  in oligonucleotide purification, 10.27  
  in transcriptional run-on assay protocol, 17.28  
for  $\lambda$  cDNA storage, 11.64  
for  $\lambda$  plaques storage, 2.32–2.33, 2.36  
overlay assay of  $\beta$ -galactosidase activity, 18.28
- +Chloro-1-naphthol, 14.10, 14.20–14.21
- Chlorophenol red  $\beta$ -D-galactopyranoside, 17.50
- Chloroquine, 16.14–16.15, 16.17, 16.52–16.53, 17.60, 17.62  
DEAE transfection, facilitation of, 16.28, 16.31  
chlortetracycline, 1.147, 17.52
- Chromatin immunoprecipitation (ChIP), A10.18
- Chromatography. *See also* Affinity chromatography; *specific resins*  
anion-exchange chromatography, DNA purification protocol, 5.26–5.28  
cDNA size fractionation through Sepharose CL-4B, 11.55–11.58  
ethidium bromide removal from DNA, 1.75–1.77, 1.151  
FPLC, 13.20  
gel-filtration, A8.29–A8.31  
  column chromatography, A8.29–A8.30  
  spun-column, A8.30–A8.31  
HPLC, 10.49, A8.35  
hydroxyapatite, 7.65, 9.90–9.91, 11.1, A8.32–A8.34  
in IgG radioiodination protocol, 14.5, 14.16  
immunoaffinity, 11.10  
liquid chromatography-tandem MS (LC-MS/MS), 18.66  
mRNA separation by  
  batch, 7.18–7.19  
  oligo(dT)-cellulose, 7.13–7.17  
  poly(U)-Sepharose, 7.15, 7.20  
oligonucleotide purification, 10.49  
  Sep-Pak  $C_{18}$  columns, 10.11, 10.13, 10.15–10.16, 10.28–10.29  
plasmid DNA purification, 1.19  
  overview of, 1.62–1.64  
  through Sephacryl S-1000, 1.80–1.81  
  resins, table of commercially available, 1.64  
thin-layer chromatography for CAT measurement, 17.36–17.39
- Chromogenic screening of expression libraries  
  in  $\lambda$  vectors, 14.9–14.11  
  in plasmid vectors, 14.20–14.21
- Chromosomal DNA. *See also* Genomic DNA  
denaturation in boiling lysis plasmid DNA protocols, 1.43  
migration in agarose gel electrophoresis, 5.5  
pulsed-field gel electrophoresis separation of, 5.3, 5.56, 5.59–5.60
- Chromosome walking  
  inverse PCR use, 8.81  
  overview, 4.8–4.10
- Church buffer, 4.26, A1.12  
  in northern hybridization, 7.45  
  in Southern hybridization, 6.56
- Chymostatin, A5.1
- Chymotrypsin, 18.64
- d gene  
   $\lambda$ , 2.3, 2.6, 2.8, 2.11, 2.17–2.18, 2.21, 2.23, 11.111.  
  *See also*  $\lambda$ , repressor  
  P1, 4.37  
  in pEX vectors, 14.14  
  thermosensitive mutants, 14.37
- CI protein,  $\lambda$ , 2.8, 2.10, 2.14, 2.17–2.18
- cII gene,  $\lambda$ , 2.6, 2.11, 2.17
- CII protein,  $\lambda$ , 2.7–2.8, 2.11
- cIII gene,  $\lambda$ , 2.6, 2.11, 2.17
- CIII protein,  $\lambda$ , 2.7, 2.11
- CIP. *See* Calf intestinal alkaline phosphatase
- Circular mutagenesis, 13.19–13.25  
  materials, 13.21–13.22  
  polymerase choice, 13.20–13.21  
  primer design, 13.19–13.20  
  protocol, 13.22–13.25
- CIT Human BAC Library, 4.9
- Citric acid, A1.6
- cIts857* mutation, 2.23
- CJ236 *E. coli* strain, 13.12–13.13, A3.6
- C-la *E. coli* strain genotype, A3.6
- Cla*I, methylation, A4.3, A4.7
- ClearCut Miniprep Kit, 1.64
- CLONEAMP pAMP, 11.105
- CLONfectin reagent, 16.5, 16.11
- Cloning. *See also* cDNA cloning  
  by addition of linkers to blunt-ended target DNA, 1.98  
  in Cosmids  
    diagram of steps, 4.12  
    double *cos* site vectors, 4.11–4.14  
    ligation reactions, 4.15, 4.21–4.22  
    partial filling of 3' termini, 4.15  
    single *cos* site vectors, 4.11, 4.13  
  expression cloning  
    cDNA library construction, 11.68–11.73  
    controls for, 11.70  
    factors influencing success, 11.69–11.70  
    mammalian host/vector systems, 11.69  
    screening cDNA library, 11.74–11.78  
    vector systems for, 11.72  
  in M13 vectors  
    locations  
      gene X, 3.9–3.10  
      large intergenic region, 3.9  
      multiple cloning sites, table of, 3.14  
      small intergenic region, 3.9  
    materials, 3.35–3.36  
    methods  
      dephosphorylation of vector DNA, 3.34  
      forced (directional cloning), 3.34  
      ligation of insert into linearized vector, 3.34  
      protocol, 3.36–3.38  
      transformation reactions, 3.37–3.38  
  PCR products  
    blunt end, 8.30–8.34  
    difficulty of, 8.30  
    end modification, 8.42–8.45  
    genetic engineering with PCR, 8.42–8.45  
    overview, 8.30–8.31  
    polishing termini, 8.30, 8.32–8.34  
    restriction site addition and, 8.31, 8.37–8.41  
      clamp sequences and, 8.38–8.39  
      diagram of procedure, 8.38  
      primer design tips, 8.37–8.38  
      problems, 8.37  
      protocol, 8.39–8.41  
      troubleshooting, 8.41  
    into T vectors, 8.31, 8.35–8.36  
  in plasmid vectors  
    blunt-ended cloning, 1.22–1.24, 1.90–1.92  
    directional cloning, 1.21–1.22, 1.84–1.87  
    fragments with protruding ends, 1.20–1.21  
    overview, 1.19–1.20
- Closed circular DNA purification in CsCl gradients, 1.18  
  continuous, 1.65–1.68  
  discontinuous, 1.69–1.71
- Clostripain, 15.8
- clp*, 15.58
- CLUSTALW program, A11.6
- Cluster analysis program, A10.15
- CM selective medium, 18.18, 18.31, 18.40
- CMV promoter. *See* Cytomegalovirus promoter
- c-Myc protein, human, epitope tagging of, 17.92
- Code20 kit, 13.89
- Codon usage  
  changing codons by PCR, 8.44  
  database, A11.20  
  degenerate primer pools and, 8.67  
  evolution and, A7.2  
  genetic code table, A7.4  
  guessemmer design and, 10.7  
  in humans, table of, A7.3  
  optimization of expression and, 15.12
- Coenzyme R. *See* Biotin
- Cohesive termini. *See* Protruding termini
- Coimmunoprecipitation, 18.4, 18.60–18.68  
  cell lysis, 18.62, 18.65  
  controls, 18.63–18.66

- Coimmunoprecipitation (*continued*)  
 identification of proteins, 18.66  
 immunoprecipitation of cell lysate, 18.62–18.63  
 materials for, 18.67–18.68  
 method, 18.68  
 nonspecific interactions, reducing, 18.65–18.66  
 procedure, outline of, 18.61–18.62
- Coincidence circuit, scintillation counter, 17.46, A9.22
- colE1 replicon, 1.3–1.4  
 chloramphenicol amplification, 1.143  
 in cosmids, 4.5  
 DNA synthesis at, 1.5–1.7  
*E. coli* strain and copy number, 1.15  
*penB* gene and copy number suppression, 1.13  
 in pET vectors, 15.3  
 plasmid growth and replication, table of, 1.17
- Colicin B protein, epitope tagging of, 17.92
- Colicin E1 replicon. *See* colE1 replicon
- Colicin E3 in positive selection vectors, 1.12
- Collagenase, 15.8, 18.116
- Colloidal bags, 6.14–6.15
- Column-loading buffer for oligo(dT)-cellulose chromatography, 7.14–7.16
- Compactin, 11.6
- Competent cell preparation  
 chemical methods, 1.24–1.25  
 electrocompetent, 1.25–1.26, 1.119–1.121  
 frozen stocks, 1.109, 1.114–1.115  
 Hanahan method, 1.105–1.110  
 Inoue method, 1.112–1.115  
 using calcium chloride, 1.116–1.118
- Competition assays, 17.17
- Competitive oligonucleotide priming (COP), 13.91, 13.96
- Complementation. *See*  $\alpha$ -complementation
- Complete minimal (CM) recipe, A2.9
- Compressions in DNA sequencing gels, 12.109–12.110
- Concentrating nucleic acids, A8.12–A8.18  
 butanol, extraction with, A8.18  
 by dialysis on bed of sucrose, 6.15  
 ethanol precipitation, A8.12–A8.16  
 aspiration of supernatants, A8.15  
 carriers, A8.13  
 dissolving precipitates, A8.13, A8.15–A8.16  
 history of, A8.14  
 protocol for, A8.14–A8.15  
 of RNA, A8.16  
 salt solutions used with, A8.12  
 high-molecular-weight DNA samples, 6.15  
 lithium chloride precipitation of large RNAs, A8.16  
 microconcentrators, A8.16–A8.17
- Condensing reagents, 1.24, 1.152
- Conditional mutations, A7.5
- Conditionally lethal genes, 1.12
- Conjugated antibodies, A9.33–A9.34
- Conjugation, *traD*36 mutation, 3.10
- Consensus program, A11.14
- Constant denaturant gel electrophoresis (CDGE), 13.92
- Contact printing arrayer, A10.7
- Contour-clamped homogeneous electric field (CHEF), 5.57, 5.79–5.82  
 conditions for, 5.79–5.80  
 electrode configuration, 5.57  
 high-capacity vector insert size determination, 4.18  
 method, 5.81–5.82  
 pulse times, 5.79–5.80  
 resolution, 5.79
- Coomassie Brilliant Blue staining solution, A1.26, A8.46–A8.47
- Copy number  
 BAC, 4.48  
 cosmids, 4.26  
 PI and PAC vectors, 4.41  
 plasmid, 1.39, 1.48, 1.56, 1.128, 1.131  
 amplification, 1.4, 1.143  
 chloramphenicol and, 1.4, 1.143  
 control by RNAI, 1.6–1.7  
*E. coli* strains, related suppression of, 1.15  
 incompatibility of plasmids and, 1.7–1.8  
 low-copy-number vectors, 1.12–1.13  
 needs for low, 1.3  
 plasmid size and, 1.9  
 replicons and, 1.3–1.4  
 suppression by *penB*, 1.13
- Cordycepin, 9.55, 9.60–9.61, 12.73
- CorePromoter program, A11.12
- COS cells, 11.68, 11.75
- COS-1, 11.114
- COS-7 cells, 11.114  
 electroporation into, 11.85–11.86  
 mRNA harvesting from, 11.87–11.88
- overview, 11.114  
 transfection, 16.27, 16.29, 16.32
- cos* sites  
 in BAC vectors, 4.3  
 cosmids, 4.11, 4.30, 4.33  
 $\lambda$ , 2.2–2.3, 2.12, 2.14–2.15, 2.68  
 in vitro packaging and, 2.111, 11.113
- Cosmids, 4.11–4.34, A3.5  
 chimeric clones, reducing, 4.15–4.16  
 choosing for genomic library construction, 4.7–4.10  
 cloning in  
 diagram of steps, 4.12  
 double *cos* site vectors, 4.11–4.14  
 ligation reactions, 4.15, 4.21–4.22  
 partial filling of 3' termini, 4.15  
 single *cos* site vectors, 4.11, 4.13  
 copy number, 4.26  
 DNA purification, 4.22–4.23  
 genomic libraries  
 amplification  
 on filters, 4.31–4.32  
 in liquid culture, 4.28–4.30  
 on plates, 4.34  
 by rescuing DNA in transducing particles, 4.30  
 arm isolation, 4.19–4.20  
 arrayed libraries, 4.31  
 dephosphorylation of genomic DNA, 4.20–4.21  
 digestion of genomic DNA, 4.20  
 isolation and analysis, 4.22  
 ligation, 4.21–4.22  
 linearization/dephosphorylation, vector, 4.18–4.19  
 protocol for construction, 4.17–4.23  
 restriction map construction, 4.33  
 screening unamplified by hybridization, 4.24–4.27  
 storage, 4.11, 4.30, 4.32  
 overview, 4.4–4.5  
 packaging, 4.21–4.22, 4.30  
 restriction mapping recombinants, 4.33  
 size, 4.11  
 stability of cloned sequences, 4.10, 4.28  
 subcloning YAC DNAs into, 4.64  
 transforming *E. coli*, 4.25  
 in vitro transcription from bacteriophage promoters, 9.31
- Cotransformation, 16.24, 16.47
- Cotton bollworm virus, 17.81
- Coulter Multimek (Beckman), A10.5
- CPD-*Star*, A9.44
- CpG sequences, 5.60, 5.68–5.69
- Cre, 4.4, 4.82–4.85. *See also* Cre-*loxP* recombination system
- CREB. *See* cAMP response-element-binding protein
- Cre-*loxP* recombination system, 4.82–4.85  
 mechanism of action, 4.82–4.83  
 site-specific integration and excision of transgenes, 4.84–4.85  
 use in mammalian cells, 4.84–4.85  
 vectors containing Cre-*loxP* sites, 4.83–4.84  
 $\lambda$ ZipLox vector, 11.25–11.26  
 PI vectors, 4.4
- Cresol red, 1.53, A1.19
- cro* genes,  $\lambda$ , 2.6, 2.8–2.9, 14.14
- Cro protein, 2.6, 2.8, 2.10, 2.14, 2.18
- Cross-linking devices, 6.41, 6.46
- Crowding agents, 1.23–1.24, 1.152, 1.157–1.158, 3.49, 6.58
- crp* gene, 15.3
- CsCL. *See* Cesium chloride
- CSH18 *E. coli* strain  
 genotype, A3.6  
 $\lambda$  vector propagation, 2.29
- CSPD, A9.43–A9.44
- CspI* methylation, A4.7
- CTAB. *See* Cetyltrimethylammonium bromide
- CTAC for solubilization of inclusion bodies, 15.54
- Cul2, 18.60, 18.62, 18.64
- Cup horn sonicator, 12.16, A8.36
- CV-1 cell lines, 16.27
- Cvi*BIII methylase, A4.7
- Cvi*I restriction enzyme, 9.15, 12.11
- Cvi*QI, A4.9
- Cy3 dye, 18.69, 18.71–18.72, 18.78, 18.80, 18.82–18.83, 18.91, 18.93–18.95
- Cy5 dye, 18.80, 18.91
- cya*, *E. coli* gene, 2.7
- Cyalume Lightsticks, A9.17
- Cyanogen bromide, 15.6, 15.8, A9.26–A9.27
- Cycle DNA sequencing  
 advantages of, 12.51–12.52  
 with end-labeled primers, 12.51–12.55  
 with internal labeling, 12.60  
 reaction mixtures for, 12.53, 12.60  
 troubleshooting, 12.55
- Cycle-sequencing buffer, 12.53
- Cyclic coiled DNA  
 alkaline lysis plasmid DNA procedure, 1.40, 1.45, 1.49  
 boiling lysis plasmid DNA protocols, 1.45, 1.49
- Cyclophilin, normalizing RNA samples against, 7.22
- Cysteine  
 for affinity purification of fusion proteins, 15.6  
 codon usage, A7.3  
 nomenclature, A7.7  
 properties, table of, A7.8  
 in pulse-chase experiments, 15.18–15.19
- Cysteine-scanning mutagenesis, 13.3
- Cytochrome *c* for protein stability, 17.16
- CytoFectene Reagent, 16.5
- Cytomegalovirus (CMV) promoter, 11.68  
 for eukaryotic expression vectors, 11.72  
 in pTet-tTak, 17.57–17.58
- Cytosine, A6.7  
 bisulfite modification of, 13.78  
 codon usage and, A7.2  
 hydrazine cleavage of, 13.78  
 hydroxylamine modification of, 13.78, 13.95  
 methylation of, A4.3–A4.4  
 nitrous oxide modification of, 13.78  
 related compounds (Table A6-6), A6.7  
 structure, A6.7
- DabcyI, 8.95
- dam* methylase, 1.25, 13.87–13.88, A4.3, A4.7
- Database of transcribed sequences (DOTS), A10.15
- Database Similarity Search Software (Table A11-2), A11.18–A11.19
- Databases. *See also individual listings*  
 searching, 1.14  
 table of bioinformatics, A11.22–A11.24

- dbEST databank, A10.3  
DC: Cholesterol, 16.8, 16.11  
*dcm* methylase, 1.25, 12.113, A4.3–A4.4  
DDAB, 16.11  
DDBJ database, A11.20  
DdeI  
7-deaza-dGTP modified DNA, cleavage of, 8.60  
in end-labeling, selective, 9.52  
ddNTPs. *See* Dideoxynucleoside triphosphates  
DD-PCR. *See* Differential display-PCR  
DD-PCR reverse transcriptase buffer, 8.101  
DE3 *E. coli* strain  
genotype, A3.6  
DE52, 2.102–2.104, 2.107–2.108. *See also* DEAE-cellulose  
DE-81 filters, A8.26  
DEAE, 1.19  
high-salt elution buffer, 5.19  
low-salt elution buffer, 5.20  
DEAE-cellulose  
for DNA purification, 5.26–5.28  
DNA recovery from agarose gels, 5.18–5.22  
in  $\lambda$  DNA purification from plate lysates, 2.102  
DEAE Dextran Kit, 16.5  
DEAE-dextran-mediated transfection, 16.3, 16.27–16.32  
calcium phosphate method compared, 16.27  
cell viability, increasing, 16.32  
facilitators of, 16.28  
kits, 16.30  
materials for, 16.29–16.30  
mechanism of action, 16.27  
method, 16.30–16.31  
mutation prevalence, 16.28, 16.53  
variables, 16.27–16.28  
DEAE-Sephacel, 5.26–5.28, A8.31  
deArray image analysis program, A10.13  
7-Deaza-dGTP, 8.60, 12.52, 12.55, 12.58, 12.96  
in automated DNA sequencing protocols, 12.95  
in DNA sequencing protocols, 12.109–12.110  
overview of, 12.111  
Sequenase, use of, 12.105  
structure of, 12.111  
*DeepVent* DNA polymerase, 8.11, 8.85, A4.23  
Degenerate oligonucleotides, pools of, 10.5–10.6, 11.31  
*degP* mutation, 15.19  
Deletion mutants  
BAL 31 generation of bidirectional sets, 13.62–13.67  
exonuclease III generation of nested sets, 13.57–13.61, 13.74–13.75  
Denaturation  
DNA  
for DNA sequencing protocols, 12.26–12.30  
by formamide, 6.59–6.60  
in PCRs, 8.8  
probes, 7.43  
RNA, 7.21–7.22  
for dot and slot blotting, 7.46, 7.48–7.49  
formaldehyde, 7.31–7.33  
glyoxal, 7.27–7.29  
by heat, 8.51  
Denaturation solution, 10.38  
in guanidinium lysis, 7.5  
for neutral transfer, double-stranded DNA targets only, A1.12  
in Southern hybridization, 6.41, 6.43, 6.47  
Denaturing buffer  
CHEF gel, 5.80  
TAFE gel, 5.75  
Denaturing gradient gel electrophoresis (DGGE), 13.91–13.92  
mutation detection, 13.49  
SYBR Gold stain as alternative to, 5.15  
Denhardt's solution  
BLOTTO and, 1.139  
in hybridization solutions, 6.51–6.52, 10.35, 10.38  
recipe, A1.15  
in stripping solutions, 6.57  
Densitometric scanning, 7.47  
*deo'* gene, 3.16  
Deoxycholate, 15.10, 15.50  
2'-deoxycoformycin (dCF), 16.47  
Deoxynucleoside triphosphates (dNTPs), A1.26  
in PCRs, 8.5  
radiolabeled, 9.5. *See also* Radiolabeled probes  
stock solution preparation, 12.107, A1.26  
storage of, 8.5  
Deoxyribonuclease I (DNase I), A4.40–A4.42  
cleavage preferences, A4.41–A4.42  
ethidium bromide and, A4.41  
limiting activity of, A4.41  
RNase free, preparation of, A4.42  
uses, list of, A4.41  
DEPC. *See* Diethylpyrocarbonate  
Dephosphorylation, 9.92  
in cosmid vector cloning, 4.15, 4.19, 4.20–4.21  
of DNA fragments with alkaline phosphatase, 9.62–9.65  
efficiency, analysis of reaction, 4.19  
efficiency, monitoring, 2.70  
of  $\lambda$  vector DNA, 2.68–2.70  
of M13 vector DNA, 3.34, 3.36, 12.24  
of plasmid DNA, 1.93–1.97  
conditions for, 1.95  
diagram of, 1.94  
method, 1.95–1.97  
when to use, 1.93–1.94  
of RNA, 9.65  
Dephosphorylation buffer, 2.69  
for use with CIP, A1.10  
for use with SAP, A1.10  
Depurination of DNA  
during DNA transfer from agarose gel to filter, 6.34  
by piperidine, 12.61  
in Southern hybridization, 6.41, 6.43, 6.47  
Detection systems, A9.1–A9.49. *See also specific chemicals; specific methods*  
AMPPD, A9.42–A9.44  
antibodies, A9.25–A9.34  
antipeptide, A9.30–A9.33  
applications, A9.25  
conjugated, A9.33–A9.34  
biotinylated, A9.33  
enzyme, A9.34  
fluorochrome, A9.33  
immunological assays, A9.27–A9.30  
immunoprecipitation, A9.29  
solid-phase RIA, A9.29–A9.30  
western blotting, A9.28  
purification of, A9.25–A9.27  
radiolabeling, A9.30  
autoradiography, A9.9–A9.15  
fluorography, A9.12  
imaging, A9.9–A9.10  
intensifying screen, A9.11  
isotopes used  
decay data, A9.15  
particle spectra, A9.9–A9.10  
sensitivity of detection, A9.13  
phosphorimaging, A9.11–A9.14  
phosphorimaging devices, A9.14  
preflashing, A9.11–A9.12  
setting up autoradiographs, A9.13–A9.14  
BCIP, A9.41–A9.42  
bioluminescence, A9.21–A9.24  
bacterial luciferase, A9.23–A9.24  
firefly luciferase, A9.21–A9.23  
assays for, A9.22–A9.23  
properties of, A9.21–A9.22  
as reporter molecule, A9.23  
GFP, A9.24  
biotin, A9.45. *See also* Biotin  
chemiluminescence, A8.55, A9.16–A9.20  
alkaline phosphatase, A8.55  
AMPPD and, A9.42–A9.44  
applications, table of, A9.18  
assays for immunoassay and nucleic acid hybridization labels, table of, A9.17  
digoxygenin and, A9.39–A9.40  
enzyme assays, A9.19–A9.20  
alkaline phosphatase, A9.19  
 $\beta$ -galactosidase, A9.19  
glucose oxidase, A9.20  
horseradish peroxidase, A9.19  
xanthine oxidase, A9.19  
horseradish peroxidase, A8.55  
horseradish peroxidase/luminol, A9.35–A9.37  
labels, A9.17–A9.19  
luminometers, A9.20  
overview, A9.16–A9.17  
reactions, A9.16  
chromogenic, A8.55  
alkaline phosphatase, A8.55  
horseradish peroxidase, A8.55  
digoxygenin, A9.39–A9.40  
horseradish peroxidase, A9.35–A9.37  
immunoglobulin binding proteins  
protein A, A9.46–A9.48  
protein G, A9.46–A9.48  
protein L, A9.46, A9.47, A9.49  
staining nucleic acids, A9.3–A9.8  
ethidium bromide, A9.3–A9.4  
methylene blue, A9.4–A9.5  
silver staining, A9.5–A9.7  
SYBR dyes, A9.7–A9.8  
Dexamethasone, 18.11  
Dextran sulfate  
as crowding agent, 6.58  
in hybridization solutions, 6.58  
in northern hybridization, 7.45  
in Southern hybridization, 6.56  
DGGE. *See* Denaturing gradient gel electrophoresis  
DH1 *E. coli* strain, 1.14–1.15, 1.25, 1.115  
genotype, A3.6  
transformation by Hanahan method, 1.106  
DH5 *E. coli* strain, 1.25  
genotype, A3.6  
transformation by Hanahan method, 1.106  
DH5 $\alpha$  *E. coli* strain, 1.115  
genotype, A3.7  
for interaction trap library screening, 18.38, 18.43–18.44  
transformation by Hanahan method, 1.106  
DH5 $\alpha$ F' *E. coli* strain for M13 growth, 12.21, 12.23  
DH5 $\alpha$ MCR *E. coli* strain  
for cosmid stability, 4.28  
genotype, A3.7  
DH10B *E. coli* strain  
for BAC propagation, 4.49  
genotype, A3.7  
DH10B(ZIP) *E. coli* strain, 11.25  
DH11S *E. coli* strain  
genotype, A3.7  
M13 vectors and, 3.13, 3.16  
phagemids and, 3.42, 3.44, 3.46–3.47  
DH12S(ZIP) *E. coli* strain, 11.25  
DIALIGN program, A11.8  
Dialysis  
buffers, 2.56–2.57, 6.4, 6.13  
to concentrate DNA, 6.15  
drop dialysis, 4.44, A8.11  
electroelution into dialysis bags, 5.23–5.25  
to purify DNA, 6.15  
on sucrose bed, 6.15  
tubing, preparation of, A8.4

- 3,3'-Diaminobenzidine (DAB), A9.35  
 Dichlorodimethylsilane, 12.75, 12.112, A8.3  
 3,4-Dichloroisocoumarin, A5.1  
 Dichlororhodamine dyes, 12.96–12.97  
 Dideoxy fingerprinting (ddf), 13.49, 13.91, 13.94  
 Dideoxynucleoside triphosphates (ddNTPs), 12.4–12.5. *See also* DNA sequencing  
   DideoxyATP, 9.55, 9.60–9.61  
   incorporation rate by thermostable DNA polymerases, 12.45  
   stock solutions of, preparing, 12.107  
   terminator dye linkage to, 12.96  
 Diethylpyrocarbonate (DEPC), 7.84  
   glassware/plasticware treatment with, 7.82, 7.84  
   as probe of secondary structure of DNA and RNA, 7.84  
   problems using, 7.84  
   for RNase inactivation, 7.82–7.84  
   storage, 7.84  
   structure of, 7.84  
   treated water, 7.84  
 Differential display-PCR, 8.96–8.106  
 Differential screening, 9.89–9.90  
 Differentially expressed genes, isolating, 9.89–9.91  
   plus/minus screening, 9.89–9.90  
   random sampling, 9.89  
   subtractive screening, 9.90–9.91  
 Difromazan, 9.78  
 Digital Optical Chemistry (DOC) system, A10.17  
*Digitalis purpurea*, 9.77  
 Digoxigenin, 9.5, A9.36  
   labeled RNA probes, 9.35  
   labeling nucleic acids with, A9.38–A9.39  
   overview, A9.38  
   specific antibodies coupled to reporter enzymes, A9.40  
 Dihydrofolate reductase (*dhfr*) gene, 16.47, 16.49  
 Dimethylformamide, 14.9–14.10, 14.20, 18.80, 18.82, A9.42  
 Dimethylsulfate, 12.5, 12.61–12.65, 12.67  
 Dimethylsulfoxide (DMSO), A1.26  
   in column-loading buffers, 7.16  
   DEAE transfection, facilitation of, 16.28  
   in DNA sequencing reactions, 12.38, 12.109  
   for  $\lambda$  cDNA storage, 11.64  
   for  $\lambda$  storage, long-term, 2.36  
   in PCRs, 8.9, 8.23  
   in transfection with polybrene, 16.43–16.45  
   in transformation buffers, 1.105–1.106  
 Dinitrophenol, 9.76  
 Dioleoylphosphatidylethanolamine (DOPE), 16.5, 16.7–16.8, 16.50  
 Direct selection of cDNAs, 11.98–11.106  
   amplification, 11.104–11.105  
   biotin labeling, 11.102  
   blocking repetitive sequences, 11.103, 11.105–11.106  
   linked pool preparations, 11.102  
   materials for, 11.100–11.101  
   overview, 11.98–11.100  
   primary selection, 11.105  
   secondary selection, 11.105  
   streptavidin bead preparation, 11.103  
   troubleshooting, 11.106  
 Directional cloning, 1.21–1.22, 1.84–1.87  
   in M13 vectors, 3.34  
   priming cDNAs with an oligo(dT) adaptor, 11.13  
 DiscoverARRAY Gene Display, A10.9  
 DisplayPhage System, 18.120  
 Dithiothreitol (DTT)  
   in binding buffer, 14.33  
   in *in vitro* transcription reactions, 7.71  
   in primer extension assay protocol, 7.79  
   in random priming buffer, 9.6  
   in transformation buffers, 1.105–1.106  
 dITR. *See* Inosine  
 D-luciferin-O-phosphate, A9.42  
 DMRIE, 16.11  
 DMRIE-C, 16.11  
 DMS buffer, 12.63  
 DMS stop solution, 12.63  
 DMSO. *See* Dimethylsulfoxide  
 DNA. *See also* cDNA; Chromosomal DNA; Double-stranded DNA; Genomic DNA;  
   Mammalian cells, DNA isolation; Plasmid DNA; Single-stranded DNA  
   concentrating. *See* Concentrating nucleic acids concentration measurement  
     by fluorometry, 6.12  
     high-molecular-weight DNA, 6.11, 6.15  
     phenol contamination and, 6.11, 6.15  
     by spectrophotometry, 6.11, 6.15  
   denaturation. *See* Denaturation, DNA detection  
     in agarose gels  
       ethidium bromide staining, 5.14–5.15  
       photography, 5.16–5.17  
       SYBR Gold staining, 5.15–5.16  
     in polyacrylamide gels  
       by autoradiography, 5.49–5.50  
       photography, 5.48  
       by staining, 5.47–5.48  
   drying DNA pellets, 1.34, 1.37, 1.41  
   electrophoresis of. *See* Agarose gel electrophoresis; Polyacrylamide gel electrophoresis  
   ethidium bromide interaction with. *See* Ethidium bromide  
   fingerprinting and mapping YAC genomic inserts, 4.63  
   footprinting DNA, 17.75–17.78, A4.41  
   fragmentation. *See* Fragmentation of DNA; Hydrodynamic shearing  
   gyrase, 1.4, 2.3  
   high-molecular-weight. *See* Chromosomal DNA; Genomic DNA; Large DNA molecules  
   ligase. *See* DNA ligase  
   microarrays. *See* DNA array technology  
   mismatch repair, A4.3  
   polymerases. *See* DNA polymerase  
   precipitation by  
     CPB, 10.22–10.24  
     CTAB, 6.62  
     ethanol, 3.28–3.29, 6.17–6.18, 6.61, 10.20–10.21, A8.12–A8.16  
     isopropanol, 6.25, 6.30  
     PEG, 1.152, 1.154  
     spermidine, 9.34, 9.36  
   probes. *See* DNA probes; Radiolabeled probe preparation  
   purification. *See also* Plasmid DNA, preparation  
     from agarose gels, 5.18  
       anion-exchange chromatography, 5.26–5.28  
       DEAE cellulose membranes, electrophoresis onto, 5.18–5.22  
       dialysis bags, electroelution into, 5.23–5.25  
       problems associated with, 5.18  
     from agarose gels, low-melting temperature agarose  
       agarase, 5.33–5.35  
       glass bead use, 5.32  
       organic extraction, 5.29–5.31  
     BAC  
       from large-scale cultures, 4.55–4.57  
       from small-scale cultures, 4.53–4.54  
       bacteriophage  $\lambda$ , 2.56–2.60  
       cosmid vectors, 4.22–4.23  
       CTAB use in, 6.62  
     high-molecular-weight  
       by chromatography on Qiagen resin, 4.45  
       by drop dialysis, 4.44  
    $\lambda$  bacteriophage  
     from liquid cultures, 2.106–2.108  
     from plate lysates, 2.101–2.104  
   M13, 12.21–12.24  
     double-stranded (replicative form), 3.23–3.25  
     large-scale, 3.30–3.33  
     single-stranded, 3.26–3.29  
   PI and PAC, 4.42–4.45  
   simultaneous preparation with RNA and protein, 7.9–7.12  
   spooling, 6.61  
   YACs, 4.67–4.71  
   quantitation. *See* Quantitation of nucleic acids replication. *See also* Origin of replication;  
     Replicons  
     in  $\lambda$ , 2.11  
     in phagemids, 3.43  
   sequencing. *See* DNA sequencing  
   size markers. *See* Molecular-weight markers  
   synthesis of oligonucleotides, 10.1, 10.42–10.46  
 Ultraviolet (UV) radiation  
   damage to DNA by, 1.67, 1.151, 5.20, 5.24  
   fixation to membranes by, 1.135, 1.137, 2.94–2.95, 6.46, 7.36  
   vectors. *See* Vectors; *specific vectors*  
   vital statistics tables, A6.2–A6.10  
 DNA adenine methylase (*dam*). *See* *dam* methylase  
 DNA array technology, A10.1–A10.19  
   advantages/disadvantages of array systems, A10.10  
   applications, A10.2–A10.3  
     gene expression analysis, A10.2  
     genomic DNA changes, monitoring, A10.2–A10.3  
   choice of array system, A10.8, A10.10  
   coverslips for, A10.14  
   databases and analysis software, A10.14–A10.16  
   detection of hybridization signal, A10.11  
   emerging technologies, A10.16–10.19  
     barcode chip, A10.19  
     bioelectric chip, A10.19  
     bubble jet printing, A10.16  
     DOC system, A10.17  
     DNA-protein interactions, detection of, A10.18–A10.19  
     IBD mapping, A10.17–A10.18  
     piezoelectric printing, A10.16  
     primer extension, A10.17  
     protein microarrays, A10.18  
     resequencing, A10.17  
     tissue microarrays, A10.18  
   flowchart, experiment, A10.4  
   genomic resources for, A10.3–A10.6  
   guidelines for experiments, A10.13–A10.14  
   hybridization, A10.10  
   image analysis, A10.12–A10.13  
   process overview, A10.2  
   production of microarrays, A10.7–A10.8  
     commercial sources, 10.9, A10.7–A10.8  
     contact printing, A10.7  
     photolithography, A10.8  
     pin and ring, A10.8  
   robotics for high-throughput processing, 10.5  
   solid support substrates, 10.5–A10.7  
   steps, experimental, A10.3  
   surface chemistry, A10.5–A10.7  
 DNA-binding domains, 18.6–18.15  
 DNA-binding proteins  
   competition assays, 17.17  
   detection with one-and-a-half hybrid system, 18.125–18.126  
   gel retardation assays, 17.13–17.16, 17.78–17.80  
   materials for, 17.13  
   optimizing, 17.16

- poly(dI-dC) and, 17.14–17.15  
troubleshooting, 17.16  
identifying in bacteriophage  $\lambda$  expression libraries, 14.31–14.36  
mapping sites  
  by DNase I footprinting, 17.4–17.11  
  by hydroxyl radical footprinting, 17.12  
protection against *dam* methylation, 13.88  
supershift assays, 17.17
- DNA-dependent RNA polymerase, 1.4, 1.11
- DNA ligase. *See also* Ligation reactions  
bacteriophage T4, 1.157–1.158, 3.37, A4.31–A4.32  
  activity of, A4.31  
  blunt-end ligation, A4.32  
  cohesive termini/nick ligation, A4.32  
  linker/adaptor attachment to cDNA, 11.54  
  uses, list of, A4.31  
*E. coli*, 1.158–1.159, A4.33  
  in cDNA second-strand synthesis, 11.43, 11.45–11.46  
 $\lambda$ , 2.3  
  overview, 1.157  
  table of properties, 1.158  
  thermostable, 1.158  
  units of activity, 1.159
- DNA PAM (percent accepted mutation) program, A11.5
- DNA polymerase, A4.22–A4.23. *See also specific polymerases*  
for automated DNA sequencing, 12.96, 12.98  
bacteriophage T4, 11.43, 11.45, 11.54, 12.32, A4.18–A4.21, A4.22. *See also* Sequenase  
  3'-5' exonuclease activity, 8.30, 8.34–8.35, A4.18, A4.20  
  5'-3' exonuclease activity, A4.18, A4.20  
  5'-3' polymerase activity, A4.20  
  in blunt-end cloning of PCR products, 8.32–8.34  
  cDNA second-strand synthesis, 11.16  
  in end-labeling, 9.56–9.59  
  exchange reaction, A4.21  
  idling/turnover reaction, 9.57–9.58  
  in oligonucleotide-directed mutagenesis of single-stranded DNA, 13.15–13.17  
  polishing ends, 11.43, 11.45, 11.54, 12.17  
  properties, table of compared, A4.11  
  uses, list of, A4.18–A4.19  
bacteriophage T7, A4.22  
  in oligonucleotide-directed mutagenesis of single-stranded DNA, 13.15–13.16  
  overview of, 12.104  
  properties, table of compared, A4.11  
comparison, table of, A4.11  
*E. coli* DNA polymerase I, 1.4, 9.82–9.86, A4.12–A4.14. *See also* Klenow fragment  
  3'-5' exonuclease activity, A4.12, A4.14  
  5'-3' exonuclease activity, A4.12–A4.14  
  5'-3' polymerase activity, A4.12–A4.13  
  in cDNA second-strand synthesis, 11.14–11.16, 11.43–11.46  
digoxigenin labeling of nucleic acids, A9.38–A9.39  
DNase I contamination of, 9.13  
domains of, 9.82–9.83, 12.101  
end-labeling, A4.12  
error rate, 9.83  
exchange reaction, A4.14  
M13 replication, 3.5  
nick translation, 9.12–9.13, 9.85–9.86, A4.12  
proofreading, 9.82  
properties, table of compared, A4.11  
in random priming reactions, 9.5  
RNAII primer, 1.6  
RNase H activity, A4.12  
uses of, 9.85–9.86, A4.12
- Klenow fragment, 1.84–1.85, 4.15, A4.15–A4.17  
  3'-5' exonuclease activity, A4.17  
  5'-3' polymerase activity, A4.16  
  end labeling, 4.33, A4.15–A4.16  
  exchange reaction, A4.17  
  uses, list of, A4.15–A4.16  
overview, A4.10  
properties, table of, A4.11, A4.23  
reverse transcriptase (RNA-dependent DNA polymerase), A4.24–A4.26  
  5'-3' polymerase activity, A4.24  
  RNase H activity, A4.24–A4.25  
  uses, list of, A4.25–A4.26  
in RT-PCR, 8.46, 8.48, 8.51–8.52  
thermostable, 8.4, 8.6–8.8, 8.10–8.11, 8.18, A4.22–A4.23. *See also* PCR  
  3'-5' exonuclease activity, 8.30, 8.77  
  antibodies, 8.110  
  for cDNA second-strand synthesis, 11.14  
  cocktail mixtures of, 8.7, 8.77  
  digoxigenin labeling of nucleic acids, A9.38–A9.39  
  in DNA sequencing, 12.45–12.50  
  in hot start PCR, 8.110  
  in mutagenesis procedures  
    megaprimer PCR mutagenesis method, 13.33–13.34  
    misincorporation mutagenesis, 13.80  
    overlap extension method of mutagenesis, 13.37–13.39  
    plasmid template mutagenesis, 13.20–13.21  
  in SSCP protocol, 13.53  
  terminal transferase activity, template-independent, 8.30
- DNA polymerase III, 1.4
- DNA probes, radiolabeled  
  preparation  
    cDNA probes  
      subtracted, 9.41–9.50, 9.90–9.91  
      using oligo(dT) primer, 9.41–9.45  
      using random primers, 9.38–9.40  
  end-labeling  
    3' termini with cordycepin/dideoxy ATP, 9.60–9.61  
    3' termini with Klenow, 9.51–9.56  
    3' termini with T4 DNA polymerase, 9.57–9.59  
    5' termini, 9.55, 9.66–9.75  
    methods, table of, 9.55–9.56  
    with T4 polynucleotide kinase, 9.55, 9.66–9.75  
    with terminal transferase, 9.55–9.56, 9.60–9.61  
  nick translation, 9.4, 9.12–9.13  
  PCR, 9.14–9.18  
  random priming, 9.4–9.11  
  single-stranded probes from M13  
    of defined length, 9.19–9.24  
    of heterogeneous length, 9.25–9.28  
    overview, 9.19–9.20  
    premature termination, 9.24  
  for S1 nuclease mapping of RNA, 7.59
- DNA-protein interaction detection by array use, A10.18–A10.19
- DNA-RNA hybrid length, measurement by alkaline agarose gel electrophoresis, 5.36
- DNase. *See also* DNase I  
contamination  
  alkaline lysis plasmid DNA preparation, 1.42  
  TE as source, 1.42  
exonuclease VII, 7.86  
in RNA isolation protocols, 7.8, 7.12  
single-strand-specific, 7.86  
in washing solution for inclusion bodies, 15.10
- DNase I, A1.8  
  in *E. coli* lysate preparation for affinity chromatography, 14.29  
  footprinting, 14.32, 14.40, 17.4–17.11, A4.41  
  concentration of DNase I, 17.11  
  control reactions, 17.8  
  materials for, 17.4–17.7  
  nuclear extract preparation from  
    cultured cells, 17.9  
    small numbers of cultured cells, 17.9–17.10  
    tissue, 17.8–17.9  
  optimization, 17.11  
  overview, 17.75–17.76  
  specificity, 17.75  
  steps, diagram of, 17.5  
  troubleshooting, 17.11  
hypersensitivity mapping, 17.18–17.22  
  controls for, 17.22  
  limitations of, 17.22  
  materials for, 17.19–17.20  
  overview of, 17.18–17.19  
  protocol, 17.20–17.21  
  in  $\lambda$  DNA purification, 2.107  
  in nick translation, 9.12–9.13  
  in RNA probe construction, 9.31–9.34  
  in shotgun library generation, 12.10–12.11  
  titrating batches of, 9.13
- DNase I dilution buffer, 17.19, A1.9
- DNA sequencing, 12.1–12.114  
  asymmetric labeling, methods for, 12.72  
  automated, 12.94–12.100  
    capillary vs. slab systems, 12.94  
    current models available, 12.94  
    dye-primer sequencing, 12.96  
    dye-terminator systems, 12.96–12.97  
    genome sequencing strategy, 12.99–12.100  
    history, 12.94–12.95  
    optimizing reactions, 12.98–12.99  
    polymerases for, 12.98  
    templates for, 12.98–12.99  
  autoradiography  
    reading, 12.113  
  BAFLs (bands in all four lanes), 12.29  
  chemical method, 12.4–12.6, 12.61–12.73  
    advantages of, 12.63  
    chemical modifications used, 12.61  
    diagram of, 12.62  
    end-labeling for, 12.73  
    flow chart for, 12.65  
    materials for, 12.63–12.64  
    methods, 12.64–12.66, 12.70–12.73  
      end labeling, 12.73  
      examples, 12.72  
      rapid, 12.70–12.71  
    troubleshooting band aberrations, 12.67–12.69  
  compression in gels, 12.109–12.111  
  dideoxy-mediated chain termination, 12.3–12.4, 12.6–12.9  
  cycle sequencing, 12.51–12.55, 12.60  
    advantages of, 12.51–12.52  
    with end-labeled primers, 12.51–12.55  
    with internal labeling, 12.60  
    reaction mixtures for, 12.53, 12.60  
    troubleshooting, 12.55  
  denaturation of DNA for, 12.26–12.30  
  rapid protocol, 12.30  
  double-stranded templates, 12.26–12.31  
  amount needed, 12.27  
  denaturation protocols, 12.28–12.30  
  in DNA purification by PEG precipitation, 12.31  
  PCR-amplified, 12.106  
  troubleshooting, 12.29  
  using cycle sequencing, 12.51, 12.54  
  using Sequenase, 12.34  
  using *Taq* polymerase, 12.49  
  end-labeling, 12.8

- DNA sequencing (*continued*)  
 general principles, 12.6  
 internal radiolabeling, 12.8  
 kits, 12.9  
 primers, 12.6–12.7  
 problem sources, 12.8  
 single-stranded templates using  
 cycle sequencing, 12.51, 12.54  
 Klenow, 12.40–12.44  
 Sequenase, 12.32, 12.34  
*Taq* polymerase, 12.49  
 strategies, 12.7  
 templates, 12.7  
 preparing denatured, 12.26–12.31  
 troubleshooting problems with, 12.38–  
 12.39, 12.44, 12.56–12.58  
 troubleshooting, 12.56–12.59  
 using Klenow, 12.40–12.44, 12.102  
 materials for, 12.41–12.42  
 method, 12.42–12.43  
 reaction mixtures, table of, 12.41  
 troubleshooting, 12.44  
 using Sequenase, 12.32–12.39, 12.104–  
 12.105  
 annealing primer to template, 12.29  
 materials for, 12.33–12.35  
 protocol, 12.35–12.36  
 reaction mixtures, table of, 12.33  
 sequencing range, 12.37  
 steps involved, 12.32  
 troubleshooting, 12.38–12.39  
 using *Taq* DNA polymerase, 12.45–12.50  
 materials for, 12.48–12.49  
 method, 12.49–12.50  
 overview, 12.45–12.47  
 versions of *Taq* used, 12.46–12.47  
 dNTP/ddNTP stock solutions, preparation of,  
 12.107  
 exonuclease III use in, 13.72, 13.75  
 fluorescent labeling and, 9.80  
 glycerol in sequencing reactions, 12.108–12.109  
 history of, 12.3–12.4  
 Maxam and Gilbert technique, 12.3–12.6, 12.61–  
 12.73  
 microtiter plate use, 12.100  
 nucleoside analogs used as chain terminators in  
 (Table A6-11), A6.10  
 oligonucleotide primers, preparing stocks of,  
 12.103  
 PCR-amplified DNA, 12.106  
 plus and minus technique, 12.4  
 polyacrylamide gels, 12.66–12.69, 12.74–12.93  
 autoradiography, 12.90–12.93  
 compression of bands, troubleshooting,  
 12.83, 12.109–12.110  
 loading, 12.88  
 base order, 12.88  
 loading devices, 12.88  
 marker dye migration rate, 12.89  
 preparation of, 12.74–12.84  
 air bubbles, 12.79  
 electrolyte gradient gels, 12.83–12.84  
 formamide containing, 12.81–12.82  
 glass plates, 12.76–12.78  
 leaking gels, 12.80  
 materials for, 12.74–12.75  
 pouring gels, 12.78–12.80  
 reading, 12.90–12.93  
 resolution of, 12.85  
 running, 12.85–12.89  
 safety precautions, 12.86  
 temperature-monitoring strips, 12.86  
 troubleshooting band pattern aberrations,  
 12.67–12.69, 12.82  
 wedge gels, 12.83  
 purification of plasmid DNA for, 1.152  
 Sanger technique, 12.3–12.4, 12.6–12.9  
 shotgun sequencing, 12.10–12.25  
 diagram of strategy, 12.12  
 DNA purification, 12.21–12.24  
 DNA repair, phosphorylation, and size selec-  
 tion, 12.17–12.18  
 enzymatic cleavage, 12.10–12.11  
 fragmentation of target DNA, 12.10–12.11,  
 12.15–12.17  
 growth of recombinants in 96-tube format,  
 12.19–12.21  
 hydrodynamic shearing, 12.10  
 ligation to vector DNA, 12.18–12.19  
 materials for, 12.13  
 number of sequences needed for coverage, 12.20  
 self-ligation of target DNA, 12.15  
 test ligations, 12.18, 12.25  
 universal primers, 8.113–8.117  
 uses for, 12.3  
 DnD solution, 1.106, 1.109  
 dNTPs. *See* Deoxynucleoside triphosphates  
 Dodecyltrimethylammonium bromide (DTAB), 6.61  
 DOGS, 16.8–16.9, 16.11  
 DOPE. *See* Dioleoylphosphatidylethanolamine  
 DOSPA, 16.11  
 DOSPER, 16.11  
 Dot hybridization of purified RNA, 7.46–7.50  
 DOTAP, 16.5, 16.11  
 DOTMA, 16.11  
 Double interaction screen (DIS), 18.125  
 Double-stranded DNA  
 calculating amount of 5' ends in a sample, 9.63  
 chemical stability of, 6.3  
 concentration in solution (Table A6-4), A6.5  
 denaturing probes, 7.43  
 nomogram for, A6.13  
 probes, denaturing, 6.54  
 separation from single-stranded by hydroxyap-  
 atite chromatography, A8.32–A8.34  
 Dowex AG 50W-X8, A8.27  
 Dowex AG50 resin, 1.76, 1.151  
 Doxycycline, 17.52, 17.54–17.56, 17.59  
 DP50*supF* *E. coli* strain  
 genotype, A3.7  
 $\lambda$  vector propagation, 2.29  
*DpnI*, 13.19–13.25, 13.84, A4.5–A4.6  
*DraI*, A4.9  
 fragment size created by, table of, A4.8  
 site frequency in human genome, 4.16, A6.3  
 dRhodamine, 12.96–12.98  
 Drop dialysis, 4.44, A8.11  
 Drop-out media recipe, A2.9  
*Drosophila melanogaster*  
 ecdysone, 17.71  
 genomic resources for microarrays, A10.6  
 Drying DNA pellets, 1.34, 1.37, 1.41, 1.46  
 Drying SDS-polyacrylamide gels, A8.50–A8.51  
 DTAB. *See* Dodecyltrimethylammonium bromide  
 DTT. *See* Dithiothreitol  
 Dual Luciferase Reporter Assay System, A9.22  
 Dulbecco's modified Eagle's medium (DMEM),  
 11.85, 16.32, 17.61  
*dut* gene, 13.11–13.15, 13.84, 13.85  
 dUTPase, 13.85  
 Dye-primer sequencing, 12.96  
 Dye-terminator systems, 12.96–12.97  
 DyNAzyme, 8.7  
 DYNOMILL, 15.49  
*EagI*  
 cleavage at end of DNA fragments, A6.4  
 fragment size created by, table of, A4.8  
 genomic DNA mapping, 5.60, 5.69  
 methylation, A4.7  
 site frequency in human genome, 4.16, A6.3  
 EBC lysis buffer, 18.67–18.68  
 EBI-European Bioinformatics Institute, EMBL  
 Outstation, A11.2  
 Ecdysone receptor (EcR), 17.71, 17.73  
 Ecdysone-inducible mammalian expression system,  
 17.72  
*EcoK*, A4.4  
*E. coli* C, 11.113  
*E. coli* K, 11.113  
*E. coli* strains. *See* *Escherichia coli* strains  
*EcoO1091*, 9.52  
*EcoRI*  
 7-deaza-dGTP modified DNA, cleavage of, 8.60  
 in cDNA construction, 11.21, 11.48–11.52, 11.64  
 cleavage at end of DNA fragments, A6.4  
 fragment size created by, table of, A4.8  
 $\lambda$  vector construction, 2.19  
 linker sequences, 1.99  
 methylation of restriction site, 1.12, 1.99, 11.48–  
 11.50, A4.4  
 in positive selection vectors, 1.12  
 site frequency in human genome, 4.16, A6.3  
*EcoRI* methylase, 1.12, 11.48–11.50, A4.5, A4.7  
*EcoRI* methylase buffer, A1.10  
*EcoRII* methylase, A4.7  
*EcoRV*, A4.9, A6.4  
 ED8654 *E. coli* strain  
 genotype, A3.7  
 $\lambda$  vector propagation, 2.28  
 ED8767, *E. coli* strain  
 genotype, A3.7  
 ED8767 *E. coli* strain, 2.29  
 EDC (*N*-ethyl-*N'*-[dimethylaminopropyl]-carbodi-  
 imide), 18.104–18.105  
 Edman degradation, 18.62, 18.66, 18.68  
 EDTA, A1.26  
 as anticoagulant, 6.8  
 inhibition of PCR by, 8.13  
 as protease inhibitor, 15.19  
 in washing solution for inclusion bodies, 15.10  
 Effectene, 16.5  
 EGAD database, A10.15  
 EGTA, A1.26  
 inhibition of BAL 31, 13.64  
 as protease inhibitor, 15.19  
 EGY48, 18.22–18.23, 18.29, 18.44  
 EGY191, 18.22  
 Elastinal, A5.1  
 Electrical mobility of DNA, 12.114  
 Electroendo-osmosis (EEO), 5.7  
 Electrolyte gradient gels, 12.83–12.84, 12.87  
 Electrophoresis. *See* Agarose gel electrophoresis;  
 Alkaline agarose gel electrophoresis;  
 Contour-clamped homogenous electric  
 field; Denaturing gradient gel electro-  
 phoresis; Polyacrylamide gel electrophore-  
 sis; Pulsed-field gel electrophoresis; SDS-  
 polyacrylamide gel electrophoresis of pro-  
 teins; Transverse alternating field electro-  
 phoresis  
 Electrophoresis buffers  
 agarose gel preparation, 5.10  
 alkaline agarose gel electrophoresis, 5.37  
 BPTE, 7.28–7.29  
 CHEF gel, 5.80  
 DNA migration rate in agarose gels, effect on,  
 5.7–5.8  
 ethidium bromide in, 5.15  
 MOPS, 7.32  
 for polyacrylamide gel electrophoresis, 12.75,  
 12.84, 12.87  
 recipes, 5.8, A1.17–A1.18  
 in SSCP protocol, 13.52  
 TAFE gel, 5.75  
 taurine-containing, 12.108, 13.90  
 Tris-glycine, A8.42, A8.44  
 types, 5.8



- Electrophoretic transfer of DNA to nylon membranes, 6.36
- Electroporation  
 of BAC DNA, 4.3, 4.49, 4.52  
 DEAE-dextran enhancement of, 16.28  
 DNA size and, 1.26  
 electrical conditions required for, 16.55–16.56  
 of library into COS-7 cells, 11.85–11.86  
 of mammalian cells, 16.3, 16.33–16.36, 16.54–16.57  
 efficiency, factors influencing, 16.33–16.34, 16.57  
 materials for, 16.34–16.35  
 method, 16.35–16.36  
 marker-dependent transformation efficiency, 1.26  
 mechanism of, 16.54–16.55  
 in oligonucleotide-directed mutagenesis protocol, 13.18  
 optimizing, 16.57  
 overview, 1.25–1.26, 1.162  
 P1 clones, 4.4, 4.46–4.47  
 pulse parameters, 1.162  
 transformation of *E. coli* by, 16.54  
 cotransformants, 1.119, 1.122  
 plasmid size and, 1.119  
 protocol, 1.119–1.122  
 pulse characteristics, 1.122
- Eliminator dye removal system, A8.28
- Elution buffer  
 for oligo(dT)-cellulose chromatography, 7.14, 7.16  
 Qiagen, A1.20
- EMBL, 2.20–2.22
- EMBL database, A11.20
- EMBL3A vector, 2.64–2.65
- emotif (Exploring the Motif Universe) program, A11.9
- En<sup>h</sup>Hance scintillant, A9.12
- End modifications  
 by inverse PCR, 8.42  
 by PCR, 8.42–8.45
- endA*. See Endonucleases, endonuclease A
- End-labeling  
 3' termini with cordycepin or dideoxy ATP, 9.60–9.61  
 3' termini with Klenow, 9.51–9.56, 9.83–9.85, 12.101  
 materials for, 9.53  
 overview of, 9.51–9.53  
 protocol, 9.54  
 uses for, 9.51  
 3' termini with T4 DNA polymerase, 9.57–9.59  
 5' termini with T4 polynucleotide kinase, 9.55, 9.66–9.75  
 blunt/recessed 5' termini, 9.70–9.72  
 by exchange reaction, 9.73–9.75  
 protruding 5' termini, 9.66–9.69, 9.73–9.75  
 for chemical sequencing, 12.73  
 in cosmid vectors, 4.33  
 by DNA polymerase I, A4.12  
 in DNA sequencing, 12.8  
 cycle DNA sequencing, 12.51–12.55  
 with Klenow fragment, 9.51–9.56, 9.83–9.85, 12.101, A4.15–A4.16  
 methods, table of, 9.55–9.56  
 with poly(A) polymerase, 9.56, 9.61  
 probes in S1 protection assays, 7.54  
 RNA by RNA ligase, A4.30  
 with RNA ligase, 9.56, 9.61  
 with T4 DNA polymerase, 9.57–9.59, A4.18  
 with terminal transferase, 9.55–9.56, 9.60–9.61
- Endoacetyluramidase, bacteriophage T4, A4.51
- Endocytosis, internalization of DEAE-dextran/DNA complexes, 16.27
- Endolysin, bacteriophage  $\lambda$ , A4.51
- Endonucleases  
 endonuclease A  
 boiling lysis plasmid DNA protocols and, 1.18, 1.43, 1.46  
 TE as contamination source, 1.42  
 endonuclease IV, 12.3  
 restriction endonuclease. See Restriction enzymes
- End-rescue subcloning, 4.63
- Enhanced cyan fluorescent protein (ECFP), 18.71–18.72, 18.76, 18.91
- Enhanced green fluorescent protein (EGFP), 18.72, 18.76, 18.90–18.94
- Enhanced yellow fluorescent protein (EYFP), 18.72, 18.76, 18.91
- Enlightning scintillant, A9.12
- Entensify scintillant, A9.12
- Enterokinase, 15.8, 15.39–15.40, 15.43, 18.49
- Entrez, 1.14
- Enzyme stabilization by glycerol, 13.90
- Enzyme-free cloning. See Ligation-independent cloning
- Enzymes, A4.1–A4.52. See also specific classes of enzymes; specific enzymes  
 agarase, A4.51  
 alkaline phosphatases, A4.37  
 DNA polymerases, A4.10–A4.27  
 bacteriophage T4, A4.18–A4.21  
 3'-5' exonuclease activity, A4.18, A4.20  
 5'-3' polymerase activity, A4.20  
 exchange reaction, A4.21  
 uses, list of, A4.18–A4.19  
 bacteriophage T7, A4.22  
 comparison, table of, A4.11  
 DNA polymerase I, *E. coli*, A4.12–A4.14  
 3'-5' exonuclease activity, A4.12, A4.14  
 5'-3' exonuclease activity, A4.12, A4.14  
 5'-3' polymerase activity, A4.12–A4.13  
 end-labeling, A4.12  
 exchange reaction, A4.14  
 nick translation, A4.12  
 uses, list of, A4.12  
 Klenow fragment, A4.15–A4.17  
 3'-5' exonuclease activity, A4.17  
 5'-3' polymerase activity, A4.16  
 end-labeling, A4.15, A4.16  
 exchange reaction, A4.17  
 uses, list of, A4.15–A4.16  
 overview, A4.10  
 properties, table of compared, A4.11  
 reverse transcriptase (RNA-dependent DNA polymerase), A4.24–A4.26  
 5'-3' polymerase activity, A4.24  
 RNase H activity, A4.24–A4.25  
 uses, list of, A4.25–A4.26  
 terminal transferase, A4.27  
 thermostable, A4.22–A4.23  
 inhibitors, table of, A5.1  
 kinase, bacteriophage T4 polynucleotide, A4.30, A4.35–A4.36  
 exchange reaction, A4.30, A4.35–A4.36  
 forward reaction, A4.30, A4.35–A4.36  
 properties, table of, A4.30  
 ligases, A4.30–A4.34  
 bacteriophage T4 DNA ligase, A4.31–A4.32, A4.34  
 activity of, A4.31  
 blunt-end ligation, A4.32  
 cohesive termini/nick ligation, A4.32  
 uses, list of, A4.31  
*E. coli* DNA ligase, A4.33  
 thermostable DNA ligases, A4.34  
 lysozymes, A4.51  
 methylating, A4.3–A4.9. See also Methylation  
*dam* methyltransferase, A4.3  
*dcm* methyltransferase, A4.3–A4.4  
 nucleases, A4.38–A4.49  
 bacteriophage  $\lambda$  exonuclease, A4.49  
 BAL 31, A4.43–A4.45  
 DNase I, A4.40–A4.42  
 exonuclease III, A4.47–A4.48  
 mung bean, A4.47  
 RNase A, A4.39  
 RNase H, A4.38  
 RNase T1, A4.39  
 S1, A4.46  
 proteinase K, A4.50  
 RNA polymerases, A4.28–A4.29  
 topoisomerase I, A4.52  
 UDG, A4.51
- EPD (eukaryotic promoter database), A11.20
- Episomes, 1.3, 11.69. See also Plasmids
- Epitope tagging, 17.32, 17.90–17.93  
 applications, 17.91  
 examples, table of, 17.92–17.93  
 overview, 17.90  
 practical considerations, 17.90–17.91
- Epitope-tagged proteins, 1.14
- Eppendorf 5 Prime, 1.64
- Equilibration buffer, 5.86
- Equilibrium centrifugation, 1.18–1.19. See also Cesium chloride density gradients
- Escherichia coli*  
 chromosome size, 5.65  
 genomic resources for microarrays, A10.6  
 strains. See also specific strains  
 for the amplification of cDNA libraries in bacteriophage  $\lambda$  vectors, 11.66  
 choosing appropriate, 1.14–1.16  
 for inverted repeat sequences, 1.15  
 for methylated DNA propagation, 1.15–1.16  
 recombination mutations, 1.15  
 for toxic protein products, 1.15  
 heat lysis and, 1.17–1.18, 1.43  
 $\lambda$  propagation, 2.28–2.29, 11.62  
 for M13 vectors, 3.10–3.46  
 receiving in the laboratory, 1.29  
 table of, A3.6–A3.10  
 for in vitro packaging, 2.111
- EtBr Green Bag, A8.28
- Ethanol  
 NaCl/ethanol solution, 6.19–6.20  
 for washing glass plates for polyacrylamide gel electrophoresis, 12.77
- Ethanolamine, 18.104–18.105
- Ethanol precipitation, A8.12–A8.16  
 aspiration of supernatants, A8.15  
 carriers, A8.13  
 dissolving precipitates, A8.13, A8.15–A8.16  
 of DNA, 6.61  
 M13 RF DNA preparation, 3.25  
 M13 single-stranded DNA preparation, 3.28–3.29  
 in PCR product purification, 8.59  
 radiolabeled oligonucleotides, 10.20–10.21  
 for spooling of mammalian DNA, 6.17–6.18  
 history of, A8.14  
 protocol for, A8.14–A8.15  
 of RNA, 9.34–9.35, A8.16  
 salt solutions used with, A8.12
- Ethidium bromide, A1.26  
 agarose gel electrophoresis, 5.5, 5.11–5.15  
 binding to DNA, A9.3  
 breaks in DNA, single-stranded, 5.20  
 in CsCl gradients, 1.18, 1.151  
 continuous, 1.65–1.68  
 discontinuous, 1.69–1.71  
 decontamination, A8.27–A8.28  
 commercial kits for, A8.28  
 of concentrated solutions, A8.27–A8.28  
 of dilute solutions, A8.28  
 disposal of ethidium bromide, A8.27

- Ethidium bromide (*continued*)  
 dissociation from DNA, 1.151  
 DNase I and, A4.41  
 fluorescence, A9.3  
 in formaldehyde-containing agarose gels, 7.31–7.32  
 glyoxylated RNA, staining of, 7.27–7.28  
 intercalation into DNA, 1.18, 1.151, 5.14  
 migration in agarose gel electrophoresis, 5.13  
 overview, 1.150–1.151  
 photography, 5.16  
 polyacrylamide gel staining, 5.15, 5.47–5.48  
 quantitation of DNA, A8.19, A8.23–A8.24, A9.4  
   agarose plate method, A8.24  
   minigel method, A8.24  
   spot test, A8.19, A8.24  
 rate of DNA migration in agarose, effect on, 1.53, 5.5, 5.15  
 in real time PCR, 8.94  
 removal from DNA, 1.68, 1.151, A8.27  
   extraction with organic solvents, 1.72–1.77, 1.151  
   ion-exchange chromatography, 1.75–1.77, 1.151  
 resolution and, 5.15  
 RNA staining, 7.31–7.32  
 sensitivity of, 5.12  
 staining DNA in gels, A9.3–A9.4  
 structure of, 1.150, A9.3  
 as trypanocidal agent, 5.14, A9.3  
 versions of, improved, A9.4
- Ethyl acetate, 17.36, 17.38, 17.40
- N-ethylmaleimide, 13.3
- Eukaryotic DNA. *See* Genomic DNA; Mammalian cells, DNA isolation
- Eukaryotic expression libraries. *See also* Expression libraries  
 construction, 11.68–11.73  
 screening, 11.74–11.78
- European Bioinformatics Institute, A11.23
- ExGen 500, 16.5
- Exon amplification, 11.35, 11.79–11.97  
 analysis of clones, 11.95–11.97  
 electroporation of library into COS-7 cells, 11.85–11.86  
 flow chart of steps, 11.80  
 library construction, 11.81  
 mRNA, harvesting, 11.87–11.88  
 overview, 11.79–11.97  
 RT-PCR, 11.89–11.94  
   materials, 11.90–11.91  
   overview, 11.89  
   protocol, 11.91–11.94
- Exonuclease II buffer, A1.10
- Exonuclease III, 11.121, 13.2, A4.47–A4.48  
 3' exonuclease activity, A4.48  
 3' phosphatase activity, A4.48  
 activities of, 13.73  
 in linker-scanning mutagenesis, 13.75  
 making templates for dideoxysequencing with, 13.75  
 nested deletion mutant sets, generation of, 13.57–13.61, 13.74–13.75  
 overview, 13.72–13.75, A4.47–A4.48  
 in site-directed mutagenesis, A4.48  
 substrate specificity, 13.72  
 thionucleotide resistance to, 13.75  
 uses of, 13.74, A4.47–A4.48
- Exonuclease III buffer, 13.58
- Exonuclease V, 1.15, 2.11–2.13, 2.13
- Exonuclease VII, 7.86
- Exonuclease  $\lambda$ , A4.49
- Expand high-fidelity PCR system, 13.20
- Expand long-template PCR system, 8.7, 8.77
- EXPASY Molecular Biology Server-Expert Protein Analysis System, Swiss Institute of Bioinformatics, A11.2
- Export of proteins, 15.30, 15.34–15.35  
 maltose-binding fusion proteins, 15.40, 15.43
- Expressed sequence tags (ESTs), 9.89  
 GenBank, A10.3–A10.4  
 microarray technology and, A10.3–A10.4, A10.6
- Expression. *See also* Expression in *E. coli* of cloned genes; Expression in mammalian cells  
 analysis by microarray technology, A10.2  
 cloning  
   cDNA library construction, 11.68–11.73  
   controls for, 11.70  
   factors influencing success, 11.69–11.70  
   mammalian host/vector systems, 11.69  
   screening cDNA library, 11.74–11.78  
   vector systems for, 11.72  
   screening cDNA libraries by, 11.33–11.34  
 Expression array platform, A10.9  
 Expression in *E. coli* of cloned genes, 15.1–15.60  
 expression system choice, 15.2–15.3, 15.55–15.57  
 fusion proteins  
   cleavage, 15.6–15.8  
   chemical, 15.6–15.8  
   enzymatic, 15.7–15.8, 15.39–15.40, 15.43  
   purification  
     by affinity chromatography on amylose resin, 15.40–15.43  
     by affinity chromatography on glutathione agarose, 15.36–15.39  
     of histidine-tagged proteins, 15.44–15.48  
     from inclusion bodies, 15.49–15.54  
     of maltose-binding proteins, 15.40–15.43  
     by metal chelate affinity chromatography, 15.44–15.48  
   purification of, 15.4–15.5  
   solubility, 15.9–15.11, 15.39, 15.53–15.54  
   uses for, 15.4  
   vectors for creating, 15.5  
 inclusion bodies, 15.9–15.11, 15.49–15.54  
 optimization  
   codon usage, 15.12  
   of expression from inducible promoter, 15.16–15.19  
   growth conditions, 15.12, 15.16–15.17, 15.19, 15.23, 15.28  
   temperature effect on, 15.16–15.17, 15.25  
   translation initiation, 15.11–15.12  
 overview, 15.56–15.57  
 problem areas, 15.56–15.57  
 promoters, choosing, 15.3–15.4  
 solubility of proteins, 15.9–15.11, 15.39, 15.53–15.54  
 using alkaline phosphatase promoter (*phoA*), 15.30–15.35  
   large-scale expression, 15.34  
   materials for, 15.31–15.32  
   optimization, 15.33  
   overview, 15.30  
   protocol, 15.32–15.34  
   subcellular localization of fusion proteins, 15.35  
 using IPTG-inducible promoters, 15.3, 15.14–15.19  
   choices for, 15.3  
   large-scale expression, 15.17–15.18  
   materials for, 15.15  
   optimization, 15.16–15.19  
   overview, 15.14  
   protocol, 15.16–15.18  
   troubleshooting, 15.18–15.19  
 using  $\lambda$  *p<sub>L</sub>* promoter, 15.4, 15.25–15.29  
   large-scale expression, 15.29  
   materials for, 15.26–15.27  
   optimization, 15.28  
   overview, 15.25  
   protocol, 15.27–15.29  
 tryptophan-inducible expression, 15.26, 15.28–15.29  
 using T7 promoter, 15.3–15.4, 15.20–15.24  
 large-scale expression, 15.24  
 materials for, 15.22  
 optimization, 15.23–15.24  
 overview, 15.20–15.22  
 protocol, 15.23–15.24  
 regulation by lysozyme, 15.24  
 vectors, choosing, 15.3–15.5
- Expression in mammalian cells, 17.1–17.99  
 differential expression, 9.89
- DNA-binding proteins  
 competition assays, 17.17  
 gel retardation assays  
   materials for, 17.13  
   optimizing, 17.16  
   poly(dI-dC) and, 17.14–17.15  
   troubleshooting, 17.16  
 gel retardation assays for, 17.13–17.16, 17.78–17.80  
 mapping sites by  
   DNase I footprinting, 17.4–17.11  
   hydroxyl radical footprinting, 17.12  
   supershift assays, 17.17  
 DNase I footprinting, 17.4–17.11  
 control reactions, 17.8  
 materials for, 17.4–17.7  
 nuclear extract preparation from cultured cells, 17.9  
   small numbers of cultured cells, 17.9–17.10  
   tissue, 17.8–17.9  
 optimization, 17.11  
 steps, diagram of, 17.5  
 troubleshooting, 17.11  
 DNase-I-hypersensitivity sites, mapping, 17.18–17.22  
 controls for, 17.22  
 limitations of, 17.22  
 materials for, 17.19–17.20  
 overview of, 17.18–17.19  
 protocol, 17.20–17.21  
 hydroxyl radical footprinting protocol, 17.12  
 inducible systems  
   ecdysone, 17.71–17.74  
   tetracycline, 17.52–17.70  
 libraries, 11.68–11.69, 11.74–11.78. *See also* Expression libraries, screening  
 overview, 17.3  
 reporter assays, 17.30–17.51  
    $\beta$ -galactosidase, 17.48–17.51  
     endogenous mammalian  $\beta$ -galactosidase activity, 17.48  
     materials for, 17.50  
     method, 17.51  
     normalizing reporter enzyme activity to  $\beta$ -galactosidase activity, 17.48, 17.51  
     overview, 17.48–17.49  
   p $\beta$ -gal reporter vectors, 17.49  
   substrates for  $\beta$ -galactosidase, 17.51  
 chloramphenicol acetyltransferase, 17.30–17.41, 17.95  
 aberrant transcription, 17.34  
 controls, 17.34  
 measurement by diffusion of reaction products into scintillation fluid, 17.41  
 measurement by extraction with organic solvents, 17.40  
 measurement by thin-layer chromatography, 17.36–17.39  
 normalizing CAT activity to  $\beta$ -galactosidase activity, 17.48–17.49, 17.51  
 overview, 17.33–17.34  
 pCAT3 vectors, 17.35  
 quantitative assays, 17.95  
 genes used, 17.30–17.32

- GFP, 17.85–17.87  
 luciferase, 17.42–17.47, 17.96  
   advantages of, 17.42  
   luminometer measurements from 96-well plates, 17.47  
   materials for, 17.44  
   methods, 17.45–17.47  
   optimizing measurement, 17.45  
   pGL3 vectors, 17.43  
   scintillation counting protocol, 17.46  
 overview, 17.30–17.32  
 transfection controls, 17.32  
 transcriptional run-on assays, 17.23–17.29  
   materials for, 17.24–17.26  
   nuclei isolation, 17.26–17.27  
   from cultured cells, 17.26  
   from tissue, 17.27  
   overview of, 17.23–17.24  
   radiolabeling transcripts from cultured cell nuclei, 17.27  
   tissue nuclei, 17.27–17.28
- Expression libraries, screening, 14.1–14.51  
 antibody choice for, 14.50–14.51  
 antisera purification for, 14.51  
 complexity of library, 14.49  
 cross-reactive antibody removal  
   affinity chromatography, 14.28–14.30  
   incubation with *E. coli* lysate, 14.26–14.27  
   pseudoscreening, 14.23–14.25  
 DNA-binding protein identification, 14.31–14.36  
   filter preparation, 14.35–14.36  
   hybridization, 14.36  
   materials for, 14.32–14.34  
   overview, 14.31–14.32  
   probe preparation, 14.34–14.35  
 enzymatic vs. radiolabeled reagents, 14.3  
 by far western analysis, 18.48–18.50  
 genomic vs. cDNA libraries, 14.47–14.48  
 in  $\lambda$  vectors, 14.4–14.13, 14.47–14.49  
   bacteriophage recovery from stained filters, 14.11  
   chemiluminescent screening, 14.11–14.12  
   chromogenic screening, 14.9–14.11  
   detection of fusion protein-expressing plaques, 14.8–14.12  
   duplicate filter preparation, 14.8  
   expression induction on filters, 14.7–14.8  
   materials for, 14.4–14.6  
   plating bacteriophage, 14.7  
   radiochemical screening, 14.9  
   troubleshooting, 14.13  
   validation of clones, 14.12  
 lysate preparation from  $\lambda$  lysogens, 14.37–14.46  
   agar plate, 14.41–14.43  
   from colonies, 14.37–14.40  
   liquid culture, 14.44–14.46  
   overview, 14.37  
 in plasmid vectors, 14.14–14.22, 14.47–14.49  
   chemiluminescent screening, 14.21–14.22  
   chromogenic screening, 14.20–14.21  
   master plate/filter preparation, 14.17  
   materials for, 14.15–14.17  
   processing filters, 14.18  
   protein expressing clones, 14.19–14.22  
   radiochemical screening, 14.19  
   replica filter preparation, 14.17–14.18  
   validation of clones, 14.22  
   vector choice, 14.14  
 probability of recombinant existence, 14.48  
 probe types  
   antibody probes, 14.1–14.2  
   oligonucleotide probes, 14.2  
   specialized, 14.2  
 for protein interactions by two-hybrid system, 18.6  
 Expression systems, 15.55–15.57  
   *Bacillus subtilis*, 15.55  
   bacteriophage T7, A4.28  
   *E. coli*, 15.1–15.60. *See also* Expression in *E. coli*  
     of cloned genes  
   insect cells, culture, 15.55  
   mammalian cells. *See* Expression in mammalian cells  
   RNA polymerase use in, 9.88  
   *Saccharomyces cerevisiae*, 15.55  
   system selection, 15.55
- Expression vectors  
 $\lambda$ , 2.22–2.23, 4.83  
 luciferase, A9.23  
 overview, 1.13–1.14  
 phagemids, 3.43
- ExSite PCR-based site-directed mutagenesis kit, 13.89
- Extinction coefficients, 10.13–10.14, A8.20–A8.21
- Extraclean, 18.104–18.106
- Ex-Wax DNA extraction kit, 6.27
- f1 bacteriophage, 1.11  
 origin of replication, 11.22–11.24, 17.35, 17.49  
 sequences in  $\lambda$ ZAP vectors, 11.22
- f88-4, 18.118
- Factor X protease, 15.40, 15.43
- Factor Xa, 15.7–15.8, 15.39
- Far western analysis, 18.3  
 outline of, 18.49  
 protein-protein interactions, detecting, 18.48–18.54
- Farnesylated enhanced GFP (EGFP-F), 16.10
- Fast performance liquid chromatography (FPLC), 13.20
- FASTA program, A11.3, A11.19
- FASTS/TFASTS program, A11.19
- FASTX/FASTY program, A11.4
- fd bacteriophage, 3.2, 18.115, 18.117. *See also* M13 bacteriophage
- FeCl<sub>3</sub> in  $\lambda$  stock preparation, 2.35, 2.37
- Fe(II)-EDTA, 17.12, 17.76–17.77
- Fetuin for protein stability, 17.16
- F factors  
 BACs and, 4.2–4.3, 4.48  
 history of, 4.49  
*lacI<sup>H</sup>* allele on, 15.18  
 M13 and, 3.2, 3.8, 3.11, 3.17–3.18  
 maintaining, 3.17–3.18  
 overview, 4.49  
*par* genes, 4.3  
 positive selection strategies, 3.11–3.13
- FGENES program, A11.11–A11.12
- Fl protein,  $\lambda$ , 2.14
- Fibronectin, 18.60, 18.62, 18.64
- Ficoll 400  
 in DNase I footprinting protocol, 17.10  
 in gel retardation assay, 17.15
- Flu gene,  $\lambda$ , 2.14
- Filamentous bacteriophage, 18.115. *See also* f1 bacteriophage; M13 bacteriophage  
 biology overview, 3.2–3.7  
 discovery of, 3.2  
 phagemids, 3.42–3.49
- Filamentous phage display, 18.3, 18.115–18.122  
 affinity selection and purification of bacteriophages, 18.121  
 commercial display systems, 18.120–18.121  
 of foreign proteins, 18.121–18.122  
 interaction rescue, 18.122  
 of peptides, 18.116–18.121  
   constrained libraries, 18.120–18.121  
   construction of libraries, 18.117–18.119  
   random peptide libraries, 18.116–18.117  
 vectors used for, 18.115–18.116, 18.118
- Filling in, 1.84–4.85  
 double stranded cDNA, 11.20  
 with Klenow fragment, 9.83–9.84, 12.101, A4.5  
 with reverse transcriptase, A4.25  
 with T4 DNA polymerase, 9.57, A4.18
- Film, autoradiography and, A9.9–A9.14
- Filters. *See specific type of filter*
- Firefly luciferase gene. *See* Luciferase
- Fixative, cell, 16.13
- FK506, 18.11
- FKBP12, 18.11
- FLAG  
 affinity purification of fusion proteins, 15.4–15.6  
 epitope tagging, 17.92–17.93
- FlexiPrep, 1.64
- FLIM. *See* Fluorescence lifetime imaging microscopy
- FLIM. *See* Fluorescence lifetime imaging microscopy
- FliTrx Random Peptide Display Library, 18.120
- FLP recombinase, 4.85
- Fluorescein, A9.33. *See also* Fluorescent labeling
- Fluorescence lifetime imaging microscopy (FLIM)  
 FLIM-FRET analysis, 18.78–18.95  
   cell preparation for, 18.84–18.89  
   fixed cells, 18.87–18.88  
   microinjection of live cells, 18.88–18.89  
   transfection of plasmid DNA into live cells, 18.84–18.86  
   example experiments  
     on fixed cells, 18.94–18.95  
     on live cells, 18.93–18.94  
   flow diagram for, 18.79  
   image acquisition, 18.90–18.95  
   imaging protein phosphorylation with, 18.78  
   labeling proteins with fluorescent dyes for, 18.80–18.83  
   frequency domain, 18.74, 18.76–18.77  
   image processing, 18.75–18.78  
   single-frequency configuration, 18.76–18.77  
   time domain, 18.74
- Fluorescence resonance energy transfer (FRET), 17.87, 18.4, 18.69–18.95  
 detection methods, 18.72–18.74  
 donor quenching, 18.73  
 fluorescence lifetime, 18.73–18.74  
 photobleaching, acceptor, 18.73  
 steady-state fluorescence intensity measurements, 18.72–18.73  
 efficiency, 8.71, 18.74
- FLIM-FRET, 18.78–18.95  
 cell preparation for, 18.84–18.89  
 data acquisition, 18.90–18.95  
 flow diagram, 18.79  
 imaging protein phosphorylation with, 18.78  
 labeling proteins with fluorescent dyes for, 18.80–18.83  
 photophysical principles of, 18.70–18.72
- Fluorescent labeling  
 of oligonucleotide probes in real time PCR, 8.94–8.95  
 probes, 9.77–9.80  
   in microarray hybridization, A10.2, A10.11–A10.13  
 in sequencing, 12.63  
 in automated DNA sequencing, 12.94–12.96  
 in cycle DNA sequencing, 12.52
- Fluorochromes  
 excitation and emission wavelengths, A9.33  
 labeled antibodies, A9.33
- Fluorography, A9.12
- Fluorometers, 8.95
- Fluorometric quantitation of nucleic acids, 6.12, A8.22–A8.24  
 ethidium bromide use, A8.19, A8.23–A8.24  
 agarose plate method, A8.24  
 minigel method, A8.24  
 spot test, A8.19, A8.24  
 with Hoechst 33258, A8.19, A8.22–A8.23
- Fluorometry buffer, 6.12
- Fnu4H* in end-labeling, selective, 9.52

- FokI* methylase, A4.7
- Footprinting DNA, 17.75–17.78  
cleavage product selection, 17.77  
DNase I, 17.4–17.11, 17.75–17.76  
controls for, 17.8  
materials for, 17.4–17.7  
method, 17.8–17.10  
overview of, 17.75–17.76  
troubleshooting/optimizing, 17.11  
hydroxy radical, 17.12, 17.76  
in vivo, 17.77  
1,10 penanthroline-copper, 17.76–17.77
- Forced ligation. *See* Directional cloning
- Formaldehyde  
in agarose gels, 7.31–7.34  
in cell fixative, 16.13  
RNA denaturation, 7.31–7.33  
for dot/slot hybridization, 7.48  
in silver staining protocol, A9.5–A9.7
- Formaldehyde gel-loading buffer, A1.19
- Formamide, 1.138  
deionization of, A1.24  
for DNA isolation  
in  $\lambda$  DNA extraction, 2.59–2.60  
from mammalian cells, 6.13–6.15  
in DNA sequencing protocols, 12.109–12.110  
resolving compressions in sequencing gels, 6.59  
in gel-loading buffers, 7.7, 7.68, 10.12, 12.36, A1.19  
in northern hybridization, 7.45  
in PCR, 8.9  
in polyacrylamide sequencing gels, 12.81–12.82  
purity, assessing, 6.59  
in ribonuclease protection assay protocols, 7.67  
RNA denaturation, 6.59, 7.33  
RNA gel-loading buffer, 7.68  
RNA storage, 7.8  
in Southern hybridization, 6.56, 6.58–6.60  
stripping northern blots, 7.44  
stripping probes from filters, A9.38  
in tracking dye, 10.12
- Formamide denaturation buffer, 6.14
- Formamide dye mix, 17.6
- Formamide loading buffer, 7.77, 12.36, A1.19
- Formic acid, 12.70–12.71, A1.6  
cleavage of fusion proteins, 15.6, 15.8
- FP-CLC. *See* Fast performance liquid chromatography
- Fragmentation of DNA, A8.35–A8.38. *See also* Hydrodynamic shearing  
HPLC use for, A8.35  
methods, table of, A8.35  
nebulization, A8.37–A8.38  
sonication, A8.36–A8.37
- Fredd volume fluctuation, 16.55
- French press for cell lysis prior to affinity chromatography, 15.38, 15.46
- FRET. *See* Fluorescence resonance energy transfer
- Frozen storage buffer, 1.106, 1.108
- FspI*, 5.69
- FSSP (Fold classification based on Structure-Structure alignment of Proteins) database, A11.22
- ftz* gene, 18.125
- $\lambda$ USE vectors, 18.118
- Fusion proteins  
 $\beta$ -galactosidase, 17.97  
cleavage, 15.6–15.8  
chemical, 15.6–15.8  
enzymatic, 15.7–15.8, 15.39–15.40, 15.43  
epitope tagging, 17.90–17.93  
applications, 17.91  
examples, table of, 17.92–17.93  
overview, 17.90  
practical considerations, 17.90–17.91  
expression vectors, 1.13–1.14  
GFP, 17.87–17.89  
*lacZ* fusion, 15.57–15.59  
disadvantages, 15.58  
inclusion bodies, 15.58  
vectors for, 15.59  
lysate preparation from  $\lambda$  lysogens  
agar plates, 14.41–14.43  
from colonies, 14.37–14.40  
liquid culture, 14.44–14.46  
protein-protein interaction studies  
GST, 18.48–18.59  
two-hybrid system, 18.17–18.47  
purification, 15.4–15.5  
by affinity chromatography, 14.40  
on amylose resin, 15.40–15.43  
on glutathione agarose, 15.36–15.39  
metal chelate, 15.44–15.48  
of histidine-tagged proteins, 15.44–15.48  
from inclusion bodies, 15.49–15.54  
of maltose-binding proteins, 15.40–15.43  
screening expression libraries  
 $\lambda$  vectors, 14.31  
in  $\lambda$  vectors, 14.4–14.12  
in plasmid vectors, 14.14–14.15, 14.19–14.22  
solubility, 15.9–15.11, 15.39, 15.53–15.54  
subcellular localization of PhoA fusion proteins, 15.35  
uses for, 15.4  
vectors for creating, 15.5  
G418, 16.24, 16.48  
Gadolinium oxysulfide intensifying screens, A9.11  
GAL1, 18.24, 18.27, 18.30, 18.37  
GAL4, 18.14–18.15, 18.24  
Galactokinase in positive selection vectors, 1.12  
Galacto-Light, 17.50  
*gal* gene,  $\lambda$  transduction of, 2.18  
*gam*,  $\lambda$ , 2.11–2.13, 2.20, 2.22  
GATA-1 transcription factor in positive selection vectors, 1.12  
GC-Melt, 4.81, 8.9, 8.23  
GEF. *See* Guanyl nucleotide exchange factor
- Gel electrophoresis. *See* Agarose gel electrophoresis; Alkaline agarose gel electrophoresis; Contour-clamped homogeneous electric field; Denaturing gradient gel electrophoresis; Polyacrylamide gel electrophoresis; Pulsed-field gel electrophoresis; SDS-polyacrylamide gel electrophoresis of proteins; Transverse alternating field electrophoresis
- Gel equilibration buffer, 5.33
- Gel retardation assays, 11.68, 17.13–17.16, 17.78–17.80  
advantages of, 17.79  
carrier DNAs, 17.80  
competition assays, 17.17  
controls, 17.15  
materials for, 17.13  
measuring dissociation constants of protein-DNA complexes, 17.79  
mechanism of action, 17.80  
mobility of protein-DNA complex, 17.79–17.80  
optimizing, 17.16  
overview, 17.78–17.80  
poly(dI-dC) and, 17.14–17.15  
supershift assays, 17.17  
troubleshooting, 17.16
- Gel Slick, 12.75
- Gelatin, A1.27
- Gel-elution buffer, 7.55, 7.59–7.60
- Gel-fixing solution, 12.90
- Gel-loading buffers  
6x gel-loading buffers, 5.42, A1.18–A1.19  
agarose gel electrophoresis, 1.53, 5.9  
alkaline agarose gel electrophoresis, 5.37  
formaldehyde, 7.32, A1.19  
formamide, 7.7, 7.68, 10.12, 12.36, A1.19  
glycerol in, 13.90  
recipes, A1.18–A1.20  
RNA, 7.68, A1.19  
SDS, 15.15, 15.22, 15.26, 15.31, 15.35, 15.41, 15.50, 18.17, A1.20, A8.42  
GenBank, A10.3, A10.15, A11.20  
GenData AG image analysis program, A10.13  
Gene discovery and microarray technology, A10.3  
Gene expression. *See also* Expression in *E. coli* of cloned genes; Expression in mammalian cells; Expression libraries, screening; Expression systems; Northern hybridization  
analysis by microarray technology, A10.2  
differential display-PCR, 8.96–8.106  
measurement by reassociation kinetics, 7.65  
Gene gun. *See* Biolistics  
Gene Pulser II, 16.35  
GeneAmp 5700 System, 8.95  
Genecards database, A10.15  
GeneChip, A10.9  
Geneclean, 12.21  
GeneFilters microarrays, A10.9  
Genelight (GL) system, A9.22  
GeneMark program, A11.10  
GeneParser program, A11.11  
GenePix 4000, A10.11, A10.13  
GenePix image analysis software, A10.15  
GenePix Pro image analysis program, A10.13  
GENESCAN program, A11.11  
GeneSHUTTLE 20, 16.5  
GeneSHUTTLE 40, 16.5  
GENESIS sample processor (Tecan), A10.5  
GeneSpring, A10.15  
GeneTAC 1000, A10.11  
Genetic code table, A7.4  
Genetic engineering with PCR, 8.42–8.45  
Geneticin, A2.7  
Geneticin resistance in activation domain fusion plasmids, 18.20  
GeneTransfer HMG-1 Mixture, 16.5  
GeneTransfer HMG-2 Mixture, 16.5  
GeneView software, A10.9  
GenExplore image analysis program, A10.13  
GeniePrep, 1.64  
Genie program, A11.10  
Genome comparisons (Table A6-1), A6.2  
Genome sequencing strategy, 12.99–12.100  
GenomeInspector program, A11.13  
Genomic DNA  
breakage, 6.3  
CHEF gels, 5.79–5.82  
cloning specific fragments of, 2.80  
digestion by restriction enzymes in agarose plugs, 5.68–5.70, 5.78  
direct selection of cDNAs with, 11.98–11.106  
exon trapping/amplification, 11.79–11.97  
expression library construction, 14.48–14.49  
inverse PCR, 8.81  
isolation  
CTAB use, 6.62  
hydrodynamic shearing forces and, 6.3  
lysis of cells  
blood cells, 6.8–6.9  
in monolayers, 6.6  
in suspension, 6.7, 6.17  
in tissue samples, 6.7–6.8, 6.17  
from microtiter plates, 6.19–6.22  
from mouse tails, 6.23–6.27  
one-tube isolation, 6.26–6.27  
from paraffin blocks, 6.27  
without extraction by organic solvents, 6.26  
from paraffin blocks, 6.27  
for PCR use, 6.18, 6.22

- rapid protocol  
   for mammalian DNA, 6.28–6.30  
   for yeast DNA, 6.31–6.32  
 by spooling, 6.16–6.18  
 using formamide, 6.13–6.15  
 using proteinase K and phenol, 6.4–6.11  
   100–150-kb DNA size, 6.10–6.11  
   150–200-kb DNA size, 6.10  
 for microarray analysis, A10.3–A10.6  
 microarray technology for monitoring changes  
   in, A10.2–A10.3  
 partial digestion for cosmid library construction,  
   4.20  
 preparation for pulsed-field gel electrophoresis,  
   5.61–5.67  
 resolution by TAFE, 5.74–5.78  
 restriction digestion  
   completeness of, 6.40  
   for Southern analysis, 6.39–6.40, 6.42  
 Southern analysis. *See also* Southern hybridiza-  
   tion)  
   overview, 6.33  
   restriction digestion for, 6.39–6.40, 6.42  
   transfection of eukaryotic cells, calcium-phos-  
   phate-mediated, 16.21–16.24  
 Genomic footprinting, 12.63  
 Genomic libraries. *See also* Vectors, high-capacity  
   BAC  
   construction, 4.49–4.50  
   screening, 4.50–4.51  
   chromosome walking, 4.8–4.10  
   clone analysis by PCR, 2.105  
   construction  
     arrayed libraries, 4.8  
     chromosome walking, 4.8–4.10  
     overview, 4.6–4.7  
     vector choice, factors influencing, 4.7–4.10  
   cosmids, 4.11–4.34  
     amplification, 4.28–4.34  
     arrayed libraries, 4.31  
     overview, 4.11–4.16  
     protocol for construction, 4.17–4.23  
     stability of recombinants, 4.28  
     storage, 4.30, 4.32  
   DNA for. *See* Genomic DNA  
   gaps in coverage, 4.6–4.7  
   human, table of, 4.9  
   insert size, 2.77  
   in  $\lambda$   
     amplification, 2.87–2.89  
     ligation of  $\lambda$  arms to genomic DNA frag-  
     ments, 2.84–2.86  
     screening by hybridization  
       DNA transfer to filters, 2.90–2.95  
       protocol, 2.96–2.100  
   P1, 4.35–4.40  
   partial digestion of DNA for  
     pilot reactions, 2.76–2.79  
     preparative reactions, 2.80–2.83  
   probability calculations, 4.6  
   restriction site frequency in human genome,  
     4.16  
   vectorette PCR isolation of genomic ends, 4.74–  
     4.81  
   YAC  
     characterization, 4.61  
     construction, 4.60  
     mapping inserts, 4.63  
     rescuing termini of genomic DNAs, 4.63  
     screening, 4.61, 4.62  
     subcloning from, 4.64  
 Genomic mismatch scanning (GMS), A10.17–  
   A10.18  
 Genomics and mapping protein interactions,  
   18.123–18.124  
 GENSCAN program, A11.11  
 Gentamycin, A2.7  
 German Human Genome Project, A10.5  
 GFP. *See* Green fluorescent protein  
 GI724 *E. coli* strain, 15.26  
 Gibbs sampler (Gibbs Sampling Strategy for  
   Multiple Alignment) program, A11.10  
 Giemsa stain, 16.13  
 Gigapack III Gold, 11.114  
 Glass beads  
   acid-washed, 6.31–6.32  
   recovery of DNA from agarose gels using, 5.32  
   Glass plates for sequencing gels, 12.76–12.78  
   Glass powder resins for DNA purification, 5.26  
   Glass slides for microarray applications, A10.5  
   Glass-Max, 1.64  
   Glassmilk, 8.27  
   Glassware, preparation of, A8.3  
 Glucocorticoid receptor (GR), 17.71  
 Glucose oxidase  
   chemiluminescent enzyme assay, A9.20  
   as digoxigenin reporter enzyme, 9.77  
 Glu-Glu, epitope tagging, 17.93  
 Glutamic acid  
   codon usage, A7.3  
   nomenclature, A7.7  
   properties, table of, A7.8  
 Glutamine  
   codon usage, A7.3  
   nomenclature, A7.7  
 Glutaraldehyde  
   in cell fixative, 16.13  
   coupling peptides to carriers, A9.32  
   for silver staining PFGE gels, 5.77  
 Glutathione-agarose resin, 15.36–15.39,  
   18.51–18.52, 18.58–18.59  
 Glutathione elution buffer, 15.36, 15.38  
 Glutathione *S*-transferase (GST) fusion proteins,  
   14.47, 15.26, 15.36–15.39, 17.83  
   affinity purification of fusion proteins, 15.4,  
     15.6  
   as probes for protein-protein interactions,  
     18.48–18.59  
     anti-GST antibodies, 18.54  
     biotin-labeled, 18.50  
     far western analysis, 18.48–18.54  
     pull-down technique, 18.55–18.59  
     protein-protein interactions, 18.3  
     pull-down technique, 18.3, 18.48, 18.55–18.59  
     materials for, 18.57–18.58  
     method, 18.58–18.59  
     outline of, 18.56  
     troubleshooting, 18.59  
     soluble fusion protein production, 15.9  
 Glyceraldehyde-3-phosphate dehydrogenase  
   (GAPDH)  
   normalizing RNA samples against, 7.22  
   use as quality check on RNA gels, 7.30  
 Glycerol, 13.54, A1.27  
   in calcium-phosphate-mediated transfection,  
     16.14–16.15, 16.17, 16.52  
   DEAE transfection, facilitation of, 16.28  
   in DNA sequencing reactions, 12.38, 12.59,  
     12.108–12.109  
   in gel-loading buffers, 13.90  
   in PCRs, 8.9, 8.23, 8.78  
   in polyacrylamide gels, 13.90  
   for stabilization of enzymes, 13.90  
   for storage of bacterial cultures, 13.90, 17.24,  
     A8.5  
   structure of, 13.90  
   for transient expression and transformation of  
     mammalian cells, 13.90  
 Glycerol shock, 17.62–17.63  
 Glycerol step gradient for  $\lambda$  particle purification,  
   2.52–2.53, 13.90  
 Glycerol storage buffer, 17.24  
 Glycine  
   codon usage, A7.3  
   nomenclature, A7.7  
   properties, table of, A7.8  
 Glycogen as carrier in ethanol precipitation of  
   DNA, A8.13  
 Glyoxal  
   deionization of, A1.24  
   denaturation of RNA for electrophoresis,  
     7.27–7.29  
 GMS 418 Array Scanner, A10.11  
 Gobase for Mitochondrial Sequences database,  
   A11.21  
 Gold use in biolistics, 16.38–16.39  
 Good buffers, A1.3–A1.4  
 Gomori buffers, A1.5  
*gpt* gene, *E. coli*, 16.49  
 Gradient fractionating device, 2.81–2.82  
 Gradients. *See* Cesium chloride density gradients;  
   Glycerol step gradient; Sodium chloride,  
   density gradient for  $\lambda$  arm purification;  
   Sucrose gradients  
 Grail II (Gene Recognition and Analysis Internet  
   Link) program, A11.11  
 Green fluorescent protein (GFP), 17.84–17.89  
   antibodies, 17.89  
   cloning vectors, 18.84  
   fluorescence excitation and emission spectra,  
     17.86  
   FRET (fluorescence resonance energy transfer),  
     18.69–18.72, 18.76, 18.84–18.89  
   as fusion tag, 17.87–17.89  
   localization signals, fusion of organelle-specific,  
     18.69, 18.84  
   overview, A9.24  
   pd2EGFP vectors, 17.88  
   in protein interaction analysis, 18.69  
   as reporter, 17.31–17.32, 17.85–17.87  
   resources for use of, 17.89  
   source of, 17.84  
   structure and function, 17.84–17.85  
   as transfection positive control, 16.4, 16.10,  
     16.12  
   variants of, 18.71–18.72  
*groE* gene, 2.14  
 Growth hormone as reporter gene, 17.31  
 Grunstein-Hogness screening, 1.28, 1.127, 1.135  
 GST fusion proteins. *See* Glutathione-*S*-transferase  
   fusion proteins  
 Guanidine hydrochloride, 14.31–14.33  
   denaturing fusion proteins with, 15.7  
   inclusion body solubilization, 15.60  
   for solubilization of inclusion bodies, 15.54  
 Guanidine thiocyanate in denaturing agarose gels,  
   7.22  
 Guanidinium  
   chloride, 15.60  
   hydrochloride, structure of, 7.85  
   isothiocyanate, 7.85, 15.60  
   salts, overview of, 7.85  
   thiocyanate in RNA purification protocols, 7.4–7.8  
 Guanine, A6.8  
   carbodiimide modification, 13.95  
   nitrous oxide modification of, 13.78  
   related compounds (Table A6-7), A6.8  
   structure, A6.8  
 Guanyl nucleotide exchange factor (GEF), 18.126  
 Guessmers, 8.66–8.67, 10.6–10.9, 11.31  
   design, 10.7  
   hybridization conditions, 10.8  
   melting temperature, 10.8  
   mixtures of, 10.7–10.8  
   PCR compared, 10.9  
 Guide RNA (gRNA) database, A11.21  
 Gyrase. *See* DNA, gyrase  
 GYT medium, 1.120–1.121, A2.2

- H  
 decay data, A9.15  
 particle spectra, A9.10  
 sensitivity of autoradiographic methods for detection, A9.13  
 HABA (2-(4-hydroxyazobenzene) benzoic acid, 11.115  
*HaeII* methylase, A4.5  
*HaeIII* in rapid screen for interaction trap isolates, 18.47  
 Hairpin structures  
   nuclease S1 digestion of, 11.4, 11.16, 11.46  
   self-primed synthesis of cDNA and, 11.4, 11.17, 11.46  
 Hanahan method for preparation and transformation of competent *E. coli*, 1.105–1.110  
 HAT medium, 16.48  
 HB101 *E. coli* strain, 1.115  
   boiling lysis plasmid DNA protocols, 1.17–1.18, 1.43  
   cell-wall component shedding and DNA purification, 1.18, 1.115  
   endonuclease A contamination and DNA preparation, 1.18  
   in exon amplification protocols, 11.82–11.84  
   genotype, A3.7  
    $\lambda$  vector propagation, 2.29  
 HB2151 *E. coli* strain, 18.116  
 HCC. See Hexamminecobalt chloride  
 HCl (hydrochloric acid), A1.12, A.6  
 Heat shock genes, cellular, 15.25  
 Heat-sealable bags. See Seal-A-Meal bags  
 Helicase, 4.2  
*Helicobacter pylori*, genomic resources for microarrays, A10.6  
 Helper virus  
   phagemids and, 3.42–3.47  
   preparation of high-titer stock, 3.46  
   superinfection protocol, 3.47  
 Hemocytometer counting, A8.6–A8.7  
 Hemoglobin inhibition of PCR by, 8.13  
 Heparin  
   inhibition of PCR by, 8.13  
   in Southern hybridization, 6.56  
 HEPES  
   in BIAcore analysis solutions, 18.104–18.105, 18.108  
   in binding buffer, 14.33, 14.36  
   in cell resuspension buffer, 17.6  
   in DNase I dilution buffer, 17.19  
   in electrophoresis buffers, 13.56  
   in oligonucleotide labeling buffer, 9.10  
   in random primer buffer, 9.6, 9.47  
   in tissue homogenization buffer, 17.6, 17.25  
   in tissue resuspension buffer, 17.6  
 HEPES-buffered DMEM, 16.32  
 HEPES-buffered saline, 16.15–16.17, 16.22–16.23, 16.52  
 Herpes simplex type-1 (HSV-1) TetR fusion to VP16 protein, 17.54–17.55  
*HERV* repetitive elements, 11.95  
 Heteroduplex analysis (HA), 13.49, 13.51  
 Hexadecyltrimethyl ammonium bromide. See also Cetyltrimethylammonium bromide  
   polysaccharide removal, 2.105  
   for solubilization of inclusion bodies, 15.54  
 Hexamminecobalt chloride (HCC)  
   as condensing agent, 1.24, 1.152  
   in transformation buffers, 1.107–1.108  
*hfl* gene, *E. coli*, 2.21, 2.28, 11.59, 11.111, 14.48  
*HhaI* in site-directed mutagenesis protocol, 13.84  
*HhaI* methylase, A4.4, A4.7  
*HhaII* methylase, A4.7  
 High-molecular-weight DNA. See Chromosomal DNA; Genomic DNA; Large DNA molecules  
 High-performance liquid chromatography (HPLC)  
   hydrodynamic shearing of DNA, A8.35  
   oligonucleotide purification, 10.49  
*himA* gene, 2.16  
*himD* gene, 2.16  
*HincII*, 1.100, A4.9  
*HindIII*  
   7-deaza-dGTP modified DNA, cleavage of, 8.60  
   cleavage at end of DNA fragments, A6.4  
   fragment size created by, table of, A4.8  
   linker sequences, 1.99  
   site frequency in human genome, 4.16, A6.3  
   terminal/subterminal site cleavage, inefficient, 8.38  
*HinfI*  
   7-deaza-dGTP modified DNA, cleavage of, 8.60  
   in end-labeling, selective, 9.52  
 Hirudin, A5.1  
*his3*, 4.59, 18.11, 18.19, 18.22  
 His-6 epitope, 17.93. See also Histidine-tagged proteins  
 His-Bond Resin, 15.46  
 Histidine  
   for affinity purification of fusion proteins, 15.6  
   codon usage, A7.3  
   nomenclature, A7.7  
   properties, table of, A7.8  
 Histidine-tagged proteins, 17.83  
   elution by decreasing pH, 15.44–15.48  
   purification by affinity chromatography, 15.6, 15.44–15.48  
   in SPR spectroscopy, 18.99  
 Histochemical stain, 16.13  
    $\beta$ -galactosidase and, 17.98–17.99  
 Histone deacetylation, inhibition of, 16.17  
 HisTrap, 15.46  
 HIV. See Human immunodeficiency virus  
 HMMER program, A11.7  
 HMS174 *E. coli* strain, 15.23, A3.7  
 HNPP (2-hydroxy-3-naphthoic acid 2'-phenyl-anilide phosphate), 9.79  
 Hoechst 33258 fluorochrome, 6.12, A8.19, A8.22–A8.23  
 Holliday structure, 2.16  
 Homogenization of tissue, 6.7–6.8  
   for nuclear extract preparation, 17.8  
   for RNA isolation, 7.6–7.7  
   for transcriptional run-on assay, 17.27  
 Homopolymeric tailing, 11.110–11.111  
 Horseradish peroxidase (HRP)  
   antibody conjugates, A9.34  
   CARD (catalyzed reporter deposition) protocol and, A9.19  
   chemiluminescent assay, 9.79, A9.19  
   as digoxigenin reporter enzyme, 9.77  
   luminol probes and, A9.35–A9.37  
   overview, A9.35  
   as reporter enzyme, 9.77, 9.79  
   in screening expression libraries, 14.3, 14.20–14.21  
   chemiluminescent, 14.11, 14.21  
   chromogenic, 14.10–14.11  
   substrates, A9.35  
 Hot start PCR, 8.89  
 Hot tub DNA polymerase, 8.10  
   in megaprimer PCR mutagenesis method, 13.33  
   properties, table of, A4.23  
 HotWax Beads, 8.110  
 Housekeeping genes  
   as endogenous standards for quantitative PCR, 8.86–8.87  
   normalizing RNA samples against, 7.22  
*HpaI*, A4.9  
*HpaII* methylase, A4.7  
*HphI*  
   *dam* methylation and, 13.87  
   for T vector creation, 8.35  
*HphI* methylase, A4.7  
*HphII*, *dam* methylation and, A4.3  
 HPLC. See High-performance liquid chromatography  
 HPOL, epitope tagging, 17.93  
 HRP. See Horseradish peroxidase  
 HSB buffer, 17.24  
*hsdM*, 11.66, A4.4  
*hsdR*, 2.28–2.29, 11.23–11.24, 11.66, A4.4  
*hsdR4*, M13 vectors and, 3.10, 3.12  
*hsdR17*, M13 vectors and, 3.10, 3.12  
*hsdS*, 2.29, A4.4  
 HSSP (homology-derived secondary structure of proteins) database, A11.22  
 H-tetrazole, 10.42  
 Human Genome Project, 12.99, 18.66, A10.5  
 Human immunodeficiency virus (HIV)  
   GeneChip array, A10.9  
   Rev protein, 18.11  
 Human PAC library, 4.9  
 Hybond-C extra, 14.6, 14.24  
 Hybridization. See also Nitrocellulose membranes; Nylon membranes; Probes; Southern hybridization  
   bacteriophage  $\lambda$  recombinants, screening  
     DNA transfer to filters, 2.90–2.95  
     probe purity, 2.98  
     in situ amplification, 2.95  
   blocking agents for, A1.14–A1.16  
   cDNA screening, 11.27–11.32  
     homologous probes, 11.27  
     similar sequence probes, 11.28–11.29  
     subtracted cDNA probes, 11.29–11.31  
     synthetic oligonucleotide probes, 11.31–11.32  
     total cDNA probes, 11.29  
     zoo blots, 11.28  
   chemiluminescent labels in, A9.17–A9.18  
   Church buffer, 4.26  
   competitor DNA use, 4.26  
   cross-hybridization, reducing, 4.27  
   denaturation of DNA on filter, 2.94  
   direct selection of cDNAs protocol, 11.98–11.106  
   of DNA separated by CHEF, 5.82  
   of DNA separated by TAFE, 5.78  
   DNA transfer to filters, 2.90–2.95  
     rapid protocol, 2.95  
   expression library screening, 14.36  
   fixation of DNA to filter, 2.94–2.95  
   in formamide-containing buffers, 6.60  
   Grunstein-Hogness screening, 1.28  
   identifying recombinant plasmids by, 1.27–1.28  
   at low stringency, 6.58  
   making filters, 2.93  
   melting temperature and, 10.47–10.48  
   microarrays, A10.10–A10.12, A10.14  
   nonradioactive labeling and, 9.76–9.80  
   northern hybridization  
     background, 7.45  
     cDNA library screening, 11.38  
     fixation of RNA to membranes, 7.35–7.36, 7.39–7.40  
   at low stringency, 6.58  
   low-stringency, 7.43  
   membranes used for, 6.37  
   nonradioactive labeling and, 9.76, 9.80  
   overview of, 7.21–7.26  
   protocol, 7.42–7.44  
   quantitating RNA by, 7.66  
   ribonuclease protection assay compared, 7.63–7.65  
   RNA separation by size  
     electrophoresis of glyoxylated RNA, 7.27–7.30  
     equalizing RNA amounts in gels, 7.22–7.23  
     formaldehyde-agarose gels, 7.31–7.34

- markers used in gels, 7.23, 7.29  
 overview, 7.21–7.22  
 pseudomessages as standards, 7.23  
 RNA transfer to membranes, 7.25–7.26, 7.35–7.41  
   membranes used for, 7.23–7.25  
   protocols, 7.35–7.41  
   staining of RNA on membranes, 7.39  
   steps involved, list of, 7.21  
   stripping blots, 7.44  
   troubleshooting, 7.45  
 for nuclease S1 mapping of RNA, 7.59–7.60  
 oligonucleotide probes  
   degenerate pools, 10.5–10.6  
   hybridization temperature, 10.6  
   length of probes, 10.4–10.5  
   melting temperature, 10.2–10.4  
   reassociation kinetics, 7.65  
   repetitive elements in probes, 4.26–4.27  
 RNA  
   dot and slot, 7.46–7.50  
   intensity of signal, measuring, 7.47  
   normalization, 7.47  
   protocol, 7.48–7.50  
   sample application to membrane, 7.46  
   standards, 7.47  
   northern protocol, 7.42–7.44. *See also* Northern hybridization  
 screening  
   BAC libraries, 4.50–4.51  
   bacterial colonies  
     binding DNA to filters, 1.131, 1.135, 1.137  
     filter type, choosing, 1.126  
     intermediate numbers, 1.129–1.131  
     large numbers, 1.132–1.134  
     lysing colonies, 1.131, 1.135–1.137  
     with radiolabeled probe, 1.138–1.142  
     replica filters, 1.131, 1.134  
     small numbers, 1.126–1.128  
   M13 plaques by, 3.41  
   site-directed mutagenesis clones, 13.40–13.47  
   subtractive, 9.44–9.46, 9.49, 9.90–9.91  
   unamplified cosmid high-capacity, 4.24–4.27  
 in situ hybridization  
   nonradioactive labeling and, 9.76, 9.80  
   RNA probes for, 9.35  
   subtractive, 9.44–9.46, 9.49, 9.90–9.91  
   transcriptional run-on assays, 17.23–17.24, 17.28–17.29  
 Hybridization buffer, A1.12–A1.13  
   with formamide (for RNA), A1.13  
   without formamide (for RNA), A1.13  
   in nuclease S1 mapping of RNA, 7.56  
   rapid, 6.61–6.62  
   in ribonuclease protection assay protocols, 7.67  
 Hybridization chambers, 1.139–1.141, 2.97, A10.14  
 Hybridization solution, 6.51–6.52, 11.100, A1.13–A1.14  
 Hydra Work Station (Robbins), A10.5  
 Hydrazine  
   5-methylcytosine and, 12.68  
   in chemical sequencing protocols, 12.61–12.65  
   rapid methods, 12.71  
   mutagenesis from, 13.78  
   salt interference with, 12.73  
 Hydrazine stop solution, 12.63  
 Hydrochloric acid (HCl), A1.6, A1.12  
 Hydrodynamic shearing, 2.76, 6.10, 12.10–12.11.  
   *See also* Fragmentation of DNA  
 Hydrolink, 13.51, 13.53  
 Hydrophobicity scales, A9.31  
 HydroShear, A8.35  
 Hydroxy radical footprinting, 17.76  
 Hydroxyapatite chromatography, 7.65, 9.44, 9.90–9.91, 11.10, A8.32–A8.34  
 Hydroxylamine, 13.91, 13.95  
   for cleavage of fusion protein, 15.8  
   mutagenesis from, 13.78  
 2-hydroxy-3-naphthoic acid 2'-phenylamide phosphate (HNPP), 9.79  
 3-(*p*-hydroxyphenyl) propionic acid (HPPA), A9.35  
 Hydroxyquinoline, A8.9  
 Hygromycin, 16.49, 17.74, A2.7  
 Hygromycin-B phosphotransferase, 16.47, 16.49  
 Hypophosphorous acid, A8.27  
 Hypoxanthine, 8.68, 10.9, A6.10  
<sup>125</sup>I  
   decay data, A9.15  
   radiolabeling antibodies, A9.30  
   sensitivity of autoradiographic methods for detection, A9.13  
<sup>131</sup>I decay data, A9.15  
 Iasys, 18.96  
 IBIS Biosensor, 18.96  
 Identical-by-descent (IBD) mapping, A10.17–A10.18  
 IgG, radioiodination of, 14.5, 14.16  
 IGP (imidazoleglycerolphosphate), 4.59  
 ImaGene image analysis program, A10.13  
 Imidazole, 15.44–15.45, 15.47  
 Imidazole buffer, 9.74, 15.45, A4.35  
 Imidazoleglycerolphosphate (IGP), 4.59  
 Immunity vectors, 2.21  
 Immunoaffinity columns, 11.10. *See also* Affinity chromatography  
 Immunoassay. *See* Immunological screening  
 Immunoblotting, A8.52–A8.55  
   blocking agents, A8.54  
   membrane types, A8.53  
   probing and detection, A8.54–A8.55  
   staining proteins during, A8.54  
   transfer of proteins from gel to filter, A8.52–A8.53  
 Immunofluorescence and epitope tagging, 17.91  
 Immunoglobulin-binding proteins A, G, L, A9.46–A9.49  
 Immunoglobulins. *See* Antibodies  
 Immunohistochemical staining  
   for  $\beta$ -glucuronidase, 16.42  
   of cell monolayers for  $\beta$ -galactosidase, 16.13  
 Immunological screening. *See also* Expression libraries, screening  
   antibody choice, 14.50–14.51  
   antisera purification, 14.51  
   cDNA screening, 11.32–11.33  
   chemiluminescent labels in, A9.17–A9.18  
   cross-reactive antibody removal  
     affinity chromatography, 14.28–14.30  
     incubation with *E. coli* lysate, 14.26–14.27  
     pseudoscreening, 14.23–14.25  
   epitope tagging, 17.90–17.93  
   of expression libraries, 14.1–14.3  
   validation of clones isolated by, 14.12  
 Immunoprecipitation, A9.29  
   coimmunoprecipitation, 18.4  
   epitope tagging, 17.91  
   of polysomes, 11.10  
 Inclusion bodies, 15.9–15.11, 15.56, 15.58  
   isolation by centrifugation, 15.10  
   lysis of bacteria containing, 15.10  
   purification and washing, 15.51–15.52  
     Triton X-100 use, 15.51  
     urea use, 15.52  
   purification of proteins from, 15.49–15.54  
     cell lysis, 15.49  
     refolding of proteins, 15.53–15.54  
     refolding proteins from, 15.11  
     solubilization, 15.11, 15.52, 15.60  
     washing, 15.10  
 Inclusion-body solubilization buffer, 15.50  
 Incompatibility of plasmids, 1.7–1.8  
 India Ink, A8.54  
 Inducible expression systems  
   ecdysone, 17.71–17.74  
   tetracycline, 17.52–17.70  
 Induction medium, 15.12, 15.31  
 Influenza virus hemagglutinin, epitope tagging of, 17.92  
 Injection/transfection buffer, 5.86  
 Ink, radioactive, 1.140, 1.142, 2.97–2.98, A1.21  
 Inosinate (IMP) dehydrogenase, 16.49  
 Inosine, 8.68, 8.113, 10.9–10.10, 11.32  
   in DNA sequencing, 12.88, 12.95, 12.97, 12.109–12.110  
   Sequenase use of, 12.105  
   structure, A6–10  
 Inoue method for preparation and transformation of competent *E. coli*, 1.112–1.115  
 Insects  
   baculoviruses, 17.81–17.83  
   expression in cultured cells, 15.55  
 Insertion vectors,  $\lambda$ , 2.19, 2.21  
 Insertional inactivation, 1.10  
 In situ hybridization  
   nonradioactive labeling and, 9.76, 9.80  
   RNA probes for, 9.35  
 Integrase, 2.8, 2.16, 11.11  
 Integration host factor (IHF), 2.16  
 Integration of  $\lambda$ , 2.16  
 Intensifying screens, A9.11  
 Interacting sequence tags (ISTs), 18.124  
 Interaction rescue, 18.122  
 Interaction trap  
   genomic analysis, 18.123–18.124  
   library screening, 18.30–18.48  
      $\beta$ -galactosidase activity assay, 18.36–18.37  
     characterization of isolates, 18.45  
     confirmation of positive reactions, 18.38–18.45  
     flow chart for, 18.38  
     harvesting transformants, 18.33–18.34  
       by agitation, 18.34  
       by scraping, 18.34  
     interacting proteins, screening for, 18.35  
     materials for, 18.30–18.32  
     rapid screen of positive reactants, 18.46–18.48  
     transformation of library, 18.32–18.33  
     troubleshooting, 18.35, 18.37  
   related technologies, 18.125–18.127  
*int* gene, 2.3, 2.8, 2.21  
 Inverse PCR, 1.157, 4.74–4.75, 8.81–8.85  
   materials for, 8.82–8.83  
   method, 8.84–8.85  
   overview of, 8.81  
   restriction enzyme choice for, 8.81, 8.84–8.85  
   schematic representation of, 8.82  
   site-directed mutagenesis  
     deletion introduction, 8.42  
     end modification, 8.42  
   use of, 8.81  
 Inverted repeat sequences, lethality of, 1.15  
 Invitrogen, 1.84  
 In vitro mutagenesis, 12.102, 13.19–13.25. *See also* Mutagenesis, site-directed  
 In vitro packaging, 2.111, 11.113–11.114  
 In vitro transcription  
   capped RNAs, 9.88  
   of genomic fragments, 4.74  
   kits, 9.32  
   plasmid vectors for, 9.29–9.31  
   protruding 3' termini, 9.33–9.34, 9.36  
   RNA polymerases, 9.87–9.88  
   RNA probe synthesis, 9.29–9.37  
     materials for, 9.32–9.33  
     promoter addition by PCR, 9.36–9.37  
     protocol, 9.33–9.35  
   for RNase protection assay

- In vitro transcription (*continued*)  
 DNA template production, 7.70  
 protocol, 7.71  
 for in situ hybridization, 9.35  
 troubleshooting, 9.36  
 RNA purification, 9.34–9.35  
 uses of, 9.88
- Iodine, radiolabeling of, 14.5, 14.16
- Iodoacetate, A4.42, A5.1
- Iodogen (1,3,4,6-tetrachloro-3 $\alpha$ ,6 $\alpha$ -diphenylglycouracil), A9.30
- Iodosobenzoic acid 2-(2-nitrophenyl)-3-methyl-3-bromoindole-nine, 15.8
- Ion-exchange chromatography for removal of ethidium bromide from DNA by, 1.75–1.77
- IPLab MicroArray Suite for Macintosh, A10.15
- IPTG (isopropylthio- $\beta$ -D-galactoside), 1.124–1.125, A1.27  
 amplification of P1 vectors, 4.36, 4.42  
 direct addition to plates, 1.125  
 fusion protein induction, 14.38, 14.40–14.42, 14.45–14.46  
 for M13 vectors recognition, 3.8, 3.19  
 in screening of expression libraries  
 $\lambda$  vectors, 14.4, 14.7–14.8  
 plasmid vectors, 14.14, 14.18  
 use with M13 vectors, 3.38
- IPTG overlay solution, 14.41–14.42
- IPTG-inducible promoters  
 for expression of cloned genes in *E. coli*, 15.3, 15.14–15.19  
 choices for, 15.3  
 large-scale expression, 15.17–15.18  
 materials for, 15.15  
 optimization, 15.16–15.19  
 overview, 15.14  
 protocol, 15.16–15.18  
 troubleshooting, 15.18–15.19  
*tac* promoter, 15.3  
*trc* promoter, 15.3
- IR1, 3.42
- Iron response element (IRE), 18.11
- IRS, epitope tagging, 17.93
- Isosmyl alcohol  
 ethidium bromide extraction from DNA, 1.73  
 in phenol:chloroform:isosmyl alcohol extractions, 6.25, 6.27, 17.28, A1.23, A8.10
- Isoelectric focusing (IEF), 18.61
- Isogen, 7.10
- Isolation of DNA. *See* Genomic DNA, isolation; Mammalian cells, DNA isolation
- Isoleucine  
 codon usage, A7.3  
 nomenclature, A7.7  
 properties, table of, A7.9
- Isopropanol  
 DNA precipitation, 6.25, 6.30, A8.5  
 ethidium bromide extraction from DNA, 1.151, A8.27  
 RNA precipitation, 7.7, 7.12
- Isopropylthio- $\beta$ -D-galactoside. *See* IPTG
- Isoyonic centrifugation through CsCl gradients for  $\lambda$  particle purification, 2.47–2.51
- Isothermal titration calorimetry, 18.96
- ISTs (interacting sequence tags), 18.124
- Iterons, 1.8
- Jellyfish (*Aequorea victoria*), 17.89. *See also* Green fluorescent protein
- J* gene,  $\lambda$ , 2.4, 2.15
- JM101 *E. coli* strain  
 genotype, A3.7  
 M13 vectors and, 3.12
- JM103 *E. coli* strain, 1.115
- JM105 *E. coli* strain  
 genotype, A3.7  
 M13 vectors and, 3.12
- JM107 *E. coli* strain  
 genotype, A3.7  
 M13 vectors and, 3.12
- JM108 *E. coli* strain, 1.115  
 transformation by Hanahan method, 1.106
- JM109 *E. coli* strain, 1.115, 13.12–13.13  
 genotype, A3.7  
 M13 vectors and, 3.12  
 M13-100 vector use in, 3.10  
 phagemids and, 3.42
- JM110 *E. coli* strain  
 genotype, A3.7  
 M13 vectors and, 3.12
- K802 *E. coli* strain  
 genotype, A3.8  
 $\lambda$  vector propagation, 2.28
- Kanamycin, 1.9  
 in *dam*<sup>-</sup> strains and, 13.88  
 mechanism of resistance to, 1.145  
 modes of action, 1.145, A2.7  
 properties, 1.145  
 stock/working solutions, A2.6  
 structures of, 1.145
- Kanamycin resistance (Km<sup>R</sup>)(*kan*<sup>r</sup>), 1.9  
 in activation domain fusion plasmids, 18.20  
 in LexA fusion plasmids, 18.19  
 in P1 vectors, 4.4, 4.37  
 in two-hybrid system of reporter plasmids, 18.12
- KasI cleavage at end of DNA fragments, A6.4
- KC8 *E. coli* strain, 18.27, 18.43, A3.8
- KCl. *See* Potassium chloride
- Keisegelguhr, A9.32
- Keyhole limpet hemocyanin, A9.32
- Kid proteins, 17.56
- Kinase. *See* Polynucleotide kinase, bacteriophage T4
- Kinetic PCR. *See* Real time PCR
- Kissing complex, 1.5, 1.7
- Kits, plasmid purification, 1.62–1.64
- KK2186 *E. coli* strain  
 genotype, A3.8  
 M13 vectors and, 3.13
- Klenow buffer, 9.20, A1.10
- Klenow fragment, 1.84–1.85, 9.82–9.86, 12.101–12.102, A4.15–A4.17  
 5'-3' exonuclease activity, A4.17  
 5'-3' polymerase activity, A4.16  
 activity, measurement of, 12.102  
 in BAL 31 mutagenesis protocol, 13.65  
 in cDNA probe production, 9.46, 9.49–9.50  
 in cDNA second-strand synthesis, 11.14  
 digoxigenin labeling of nucleic acids, A9.38–A9.39  
 in DNA sequencing, 12.40–12.44  
 asymmetric labeling, 12.72  
 materials for, 12.41–12.42  
 method, 12.42–12.43  
 reaction mixtures, table of, 12.41  
 secondary structure problems, 12.44  
 troubleshooting, 12.44
- end labeling, A4.15–A4.16  
 for chemical sequencing of DNA, 12.73  
 in cosmid vectors, 4.33  
 modified nucleotide use in end-labeling, 9.53
- error rate, 9.83, 12.102
- exchange reaction, A4.17
- in exonuclease III mutagenesis protocol, 13.57, 13.61
- filling-in recessed 3' termini, 9.83–9.84, 12.101–12.102
- inactivation of, 9.23
- labeling 3' termini, 9.51–9.56, 9.83–9.85, 12.101
- labeling of oligonucleotides, 10.30–10.34  
 diagram of scheme, 10.31
- primers for, 10.31–10.33  
 protocol, 10.33–10.34  
 strand separation, 10.32
- labeling single-stranded DNA by random priming, 9.85
- in misincorporation mutagenesis, 13.80
- model of DNA bound to, 9.84
- modified nucleotide use in end-labeling, 9.53
- in oligonucleotide-directed mutagenesis of single-stranded DNA, 13.15–13.17
- partial filling of cosmid termini, 4.15
- polishing ends, 12.17
- in probe production for nuclease S1 mapping of RNA, 7.58
- properties, table of compared, A4.11
- in radiolabeling for gel retardation assays, 17.16
- in random priming reactions, 9.5, 9.7, 9.11
- replacement by other polymerases, 12.102
- Sequenase compared, 12.32
- single-stranded probe production, 9.19–9.23, 9.27  
 by primer extension, 9.85
- uses, list of, A4.15–A4.16
- in vitro mutagenesis and, 12.102
- Klentaq, 8.77–8.78, 8.85  
 in circular mutagenesis, 13.20  
 in cycle sequencing reactions, 12.46–12.47  
 structure of, 12.47
- Km<sup>R</sup>. *See* Kanamycin resistance
- Knock-out, gene, 1.15
- KOH/Methanol solution, A1.20
- Kox1, 17.56
- Kozak sequence, 17.96
- Kpn*I, A4.9  
 cleavage at end of DNA fragments, A6.4
- Keisegelguhr, A9.32
- KS promoter, primer sequence for, 8.117
- Kunkel method, 13.84
- KW251 *E. coli* strain  
 genotype, A3.8  
 $\lambda$  vector propagation, 2.28
- Kyoto Encyclopedia of Genes and Genomes (KEGG) database, A10.15
- L40, 18.22
- Labeled avidin-biotin (LAB) technique, A9.33
- Labeling. *See* DNA probes; Nonradioactive labeling; Radiolabeled probe preparation; RNA, probes
- Labeling buffer, 17.24
- lac* operon in M13, 3.8–3.10
- lac* promoter  
 for eukaryotic expression vectors, 11.72  
 for expression of cloned genes in *E. coli*, 15.3, 15.15–15.19  
 in pET expression vectors, 15.21  
 primer sequence for, 8.117  
*trp-lac* promoter, 15.3
- lac* repressor, 15.18, 15.57. *See also lac*<sup>R</sup>
- lac*<sup>R</sup>, 11.23–11.24, 11.66  
 in IPTG-inducible expression vectors, 15.15–15.16, 15.18  
 $\lambda$  propagation and, 2.28–2.29  
 in AZAP, 14.6  
 M13 vectors and, 3.10, 3.12–3.13  
 in plasmid expression vectors, 14.14  
 in pMAL vectors, 15.40
- lac-proAB* in M13 vectors, 3.10, 3.12–3.13
- lacZ*, 1.10, 1.27, 17.97. *See also*  $\beta$ -galactosidase  
 in BAC vectors, 4.3  
 $\alpha$ -complementation, 1.149–1.150  
 in expression vectors, 14.47–14.48  
 fusion proteins, 15.57–15.59  
 disadvantages, 15.58  
 inclusion bodies, 15.58  
 vectors for, 15.59  
 in  $\lambda$  vectors, 2.30, 11.22, 11.25  
 in  $\lambda$ gt11 vector, 11.111



- in M13, 3.8–3.10
- in pUC vectors, 3.9
- as screening marker in  $\lambda$  recombinants, 2.21
- Shine-Dalgarno sequence, 15.57
- in two-hybrid system of protein-protein interaction reporter plasmids, 18.17, 18.22, 18.24
- lacZ* $\Delta$ M15
  - $\lambda$  propagation and, 2.29
  - M13 vectors and, 3.10, 3.12–3.13
- Ladders. See Molecular-weight markers
- LALIGN program, A11.4
- LALIGN0 program, A11.4
- lamB* gene, 2.4, 11.62
  - glucose repression of, 2.35, 2.37
  - maltose induction of, 2.26
- lamB* receptor,  $\lambda$  adsorption to, 2.15
- $\lambda$ 2001, 2.20–2.22, A3.3
- $\lambda$  Annealing buffer, A1.20
- $\lambda$  bacteriophage, 2.1–2.111. See also Cosmids;  $\lambda$  vectors
  - arm purification by sucrose density gradient, 2.71–2.75
    - ligation first method, 2.73
    - materials, 2.72
    - method, 2.73–2.75
  - concatemers, 2.68, 2.70
  - concentration of doubled-stranded DNA in solution, A6.5
  - DNA extraction
    - DNA concentration, calculating, 2.58
    - from large-scale cultures
      - using formamide, 2.59–2.60
      - using proteinase K and SDS, 2.56–2.58
    - particle purification for, 2.54–2.55
  - DNA purification, 5.71–5.73
    - from liquid cultures, 2.106–2.108
    - miscellaneous methods, 2.104
    - from plate lysates, 2.101–2.104
    - polysaccharide removal by precipitation with CTAB, 2.105
  - exonuclease, 11.121, A4.49
  - expression vectors, 4.83
  - genomic organization, 2.3–2.4, 2.5
  - infection phases
    - late lytic
      - DNA packaging, 2.14–2.15
      - DNA replication, 2.11
      - lysis, 2.15
      - particles, assembly of, 2.14–2.15
      - recombinant systems, 2.11–2.13
      - transcription, late, 2.14
    - lysis/lysogeny crossroads, 2.7–2.11
    - lysogeny, 2.15–2.18
      - integration, 2.16
      - transcription of prophage genes, 2.17–2.18
    - temperature and, 2.4, 2.18
    - uncommitted phase
      - adsorption, 2.4
      - transcription, delayed early, 2.6–2.7
      - transcription, immediate early, 2.6
  - in vitro packaging, 11.113–11.114
  - libraries, screening by PCR, 8.76
  - map, physical and genomic, 2.5
  - molecular-weight marker ladder, 5.59
  - overview of, 2.2–2.3
  - P2 prophage restriction of growth, 2.20
  - plaques
    - $\beta$ -galactosidase screening, 2.31
    - macroplaques, 2.31
    - number per dish, table of, 2.92
    - picking, 2.32–2.33
    - screening by PCR, 8.74–8.75
    - size, 2.30
    - smearing, 2.30
    - storage, 2.33
      - long-term, 2.36
  - plating, 2.25–2.31
    - $\beta$ -galactosidase plaque-assay, 2.30
    - macroplaque protocol, 2.31
    - protocol
      - bacteria preparation, 2.26–2.27
      - infection of plating bacteria, 2.27–2.30
      - materials, 2.25–2.26
  - promoters, 2.5–2.8, 2.14, 2.17, 15.4, 15.25–15.29
  - propagation, *E. coli* strains for, 2.28–2.29
  - purification, particle
    - centrifugation through glycerol step gradient, 2.52–2.53
    - isopycnic centrifugation through CsCl gradient, 2.47–2.51
    - pelleting/centrifugation, 2.54–2.55
  - repressor, 2.8, 2.10–2.11, 2.14, 2.17–2.18, 2.21, 2.23
    - inactivation, 14.7
    - in positive selection vectors, 1.12
    - temperature-sensitive, 1.13, 14.37–14.38, 14.40, 14.47, 15.4, 15.25, 15.27–15.28
  - shotgun sequencing protocol, 12.10–12.22
  - specialized transduction, 2.17
  - stock preparation
    - DNA content, assaying by gel electrophoresis, 2.45–2.46
    - large-scale
      - infection at high multiplicity, 2.42
      - infection at low multiplicity, 2.40–2.42
      - liquid culture, small-scale, 2.38–2.39
      - plate lysis and elution, 2.34–2.36
      - plate lysis and scraping, 2.37
      - precipitation of particles, 2.43–2.44
      - yield, factors influencing, 2.35, 2.37
    - structure of, 2.3
    - terminase, 2.15, 4.5, 4.30
  - $\lambda$ cl1, 11.109
  - $\lambda$  DE3, 15.20–15.21
  - $\lambda$  EMBL vectors, A3.3
  - $\lambda$ DASH vector, 2.20–2.22, A3.3
  - $\lambda$ ExCell vector
    - in commercial kits for cDNA synthesis, 11.108
    - expression cloning, 11.72
  - $\lambda$ EXlox vector, 4.83
  - $\lambda$ FIX vector, 2.22, A3.3
  - $\lambda$ gt10 vector, 11.25, A3.3
    - amplification of libraries constructed in, 11.64–11.65
      - cDNA library construction in, 11.59–11.60
      - in commercial kits for cDNA synthesis, 11.108
      - overview, 11.111
      - plaque formation with, 11.62
      - primers for, 8.116
  - $\lambda$ gt11 vector, 2.22–2.23, 11.25, 11.27
    - amplification of libraries constructed in, 11.65–11.66
      - cDNA library construction in, 11.59
      - in commercial kits for cDNA synthesis, 11.108
      - E. coli* strain for amplification of cDNA libraries, 11.66
    - fusion protein expression in, 14.37, 14.39, 14.43, 14.45
    - immunological screening of libraries in, 14.2
    - overview, 11.111
    - plaque formation with, 11.62
    - primers for, 8.116
  - $\lambda$ gt11-23 vector, A3.3
  - $\lambda$ gt18-23 vector
    - cDNA library construction in, 11.59
    - E. coli* strain for amplification of cDNA libraries, 11.66
    - expression libraries and, 14.47–14.48
    - fusion protein expression in, 14.37
    - immunological screening of libraries in, 14.2
    - plaque formation with, 11.62
  - $\lambda$ gt18-23 vectors, 2.22–2.23
  - $\lambda$ gt20 vector, 11.66
  - $\lambda$ gt22 vector, 11.66
  - $\lambda$ ORF8 vector and expression libraries, 14.47–14.48
  - $\lambda$  p<sub>1</sub> promoter
    - for expression of cloned genes in *E. coli*, 15.4, 15.25–15.29
      - large-scale expression, 15.29
      - materials for, 15.26–15.27
      - optimization, 15.28
      - overview, 15.25
      - protocol, 15.27–15.29
      - tryptophan-inducible expression, 15.26, 15.28–15.29
    - vectors containing, 15.25
  - $\lambda$  p<sub>R</sub> promoter, 14.14
  - $\lambda$ Triplex2 in commercial kits for cDNA synthesis, 11.108
  - $\lambda$  vectors. See also specific vectors
    - amber mutations, A7.5
    - amplification of libraries constructed in, 11.64–11.66
    - cDNA cloning, 11.17–11.18, 11.21–11.26
      - $\lambda$ gt10/ $\lambda$ gt11, 11.25, 11.27
      - $\lambda$ ZAP, 11.22
      - $\lambda$ ZAP Express, 11.22–11.25
      - $\lambda$ ZAP II, 11.22–11.23
      - $\lambda$ ZipLox, 11.25–11.26
      - library construction, 11.59–11.61
    - choosing, 2.20
    - cloning in, flow chart for, 2.24
    - Cre-loxP in, 4.83
    - dephosphorylation of arms, 11.59
    - DNA preparation
      - alkaline phosphatase treatment, 2.68–2.70
      - arm purification, 2.71–2.75
      - cleaved with single restriction enzyme, 2.61–2.63
      - cleaved with two restriction enzyme, 2.64–2.67
      - digestion efficiency, monitoring, 2.66–2.67
    - E. coli* strain preferences for plating, 11.62
    - expression vectors, 2.12–2.23
      - immunological screening of libraries in, 14.2
    - immunity vectors, 2.21
    - insertion vectors, 2.19, 2.21
  - libraries
    - amplification, 2.87–2.89
    - construction, 2.20, 11.51–11.61
    - expression libraries, screening, 14.4–14.13, 14.47–14.49
      - bacteriophage recovery from filters, 14.11
      - chemiluminescent screening, 14.11–14.12
      - chromogenic screening, 14.9–14.11
      - for DNA-binding proteins, 14.31–14.36
      - duplicate filter preparation, 14.8
      - eukaryotic, 11.72–11.73, 11.76–11.78
      - expression induction on filters, 14.7–14.8
      - fusion protein production, 14.37–14.46
      - materials for, 14.4–14.6
      - plating bacteriophage, 14.7
      - protein-expressing plaques, 14.8–14.12
      - radiochemical screening, 14.9
      - troubleshooting, 14.13
      - validation of clones, 14.12
    - ligation of  $\lambda$  arms to insert fragments, 2.84–2.86
    - partial digestion of DNA for, 2.76–2.83
    - screening by PCR, 2.33, 8.76
  - markers for selection or screening, table of, 2.21
  - overview, 2.18–2.23
  - packaging, 2.63, 2.65, 2.67, 2.84–2.86, 2.110–2.111
    - amplification of genomic libraries, 2.87–2.89
    - cosmids, 4.21–4.22
    - direct screening, 2.87
    - efficiency, 2.67–2.68, 2.110

- λ* vectors (continued)
- preparation methods, 2.111
  - partial digestion of DNA for
    - pilot reaction, 2.76–2.79
    - preparative reaction, 2.80–2.83
  - primers for cloning in, 8.116
  - propagation, *E. coli* strains for, 2.28–2.29
  - recombinants
    - DNA minipreparation from liquid cultures, 2.106–2.107
    - DNA minipreparation from plate lysates, 2.101–2.104
    - PCR analysis, 2.105
  - replacement vectors, 2.19–2.22, 2.64–2.65
    - ligation of arms to genomic DNA fragments, 2.84–2.86
  - screening by hybridization
    - DNA transfer to filters, 2.90–2.95
    - hybridization protocol, 2.96–2.100
  - size of DNA inserted, 2.85
  - subcloning YAC DNAs into, 4.64
  - table of, A3.3
  - templates for DNA sequencing, 12.29
- λ*YES vectors, 4.83
- λ*ZAP vector, 2.101, 11.22
- amplification of libraries constructed in, 11.65–11.66
  - cDNA library construction in, 11.59
  - E. coli* strain for amplification of cDNA libraries, 11.66
  - expression libraries, 14.47–14.48
  - fusion protein expression in, 14.37, 14.47
  - immunological screening of libraries in, 14.2
  - plaque formation with, 11.62
- λ*ZAP-CMV vector
- in commercial kits for cDNA synthesis, 11.108
  - expression cloning, 11.72
- λ*ZAP Express vector, 11.22–11.25, A3.3
- E. coli* strain for amplification of cDNA libraries, 11.66
  - expression cloning, 11.72
  - expression libraries, 14.47–14.48
  - immunological screening of libraries in, 14.2
- λ*ZAPII vector, 11.22, 11.23
- E. coli* strain for amplification of cDNA libraries, 11.66
  - expression libraries and, 14.47–14.48
  - immunological screening of libraries in, 14.2
  - plaque formation with, 11.62
- λ*Ziplox vector, 2.101, 4.83, 11.25–11.26, A3.3
- amplification of libraries constructed in, 11.65–11.66
  - cDNA library construction in, 11.59
  - in commercial kits for cDNA synthesis, 11.108
  - E. coli* strain for amplification of cDNA libraries, 11.66
  - expression cloning, 11.72
  - expression libraries, 14.47–14.48
  - fusion protein expression in, 14.37, 14.47
  - plaque formation with, 11.62
- Langmuir-binding model, 18.112–18.113
- Lanthanum oxybromide intensifying screens, A9.11
- Large DNA molecules. *See also* Chromosomal DNA;
- Genomic DNA
  - CHEF gels, 5.79–5.82
  - cloning products and services, 4.86
  - concentration by dialysis on sucrose bed, 6.15
  - concentration measurement of, 6.11, 6.15
  - fragmentation by hydrodynamic shearing, 2.76, 6.3
- gel electrophoresis, difficulty entering the gel during, 6.15
- isolation from mammalian cells
  - by spooling, 6.16–6.18
  - using formamide, 6.13–6.15
  - using proteinase K and phenol, 6.4–6.11
- minimizing damage to, 2.110
- partial digestion for genomic libraries
  - checking, 2.79
  - methods, 2.76
  - pilot reactions, 2.76–2.79
  - preparative reactions, 2.80–2.83
- pulsed-field gel electrophoresis
  - recovery from gels, 5.83–5.88
  - separation by, 5.2, 5.55–5.56, 5.59–5.60
- recovery
  - from low-melting point agarose, 5.33–5.35
  - from pulsed-field gel electrophoresis gels, 5.83–5.88
  - spermine/spermidine use, 5.86
  - sucrose gradients, size fractionation through, 2.82–2.83
  - transfection of eukaryotic cells, calcium-phosphate-mediated, 16.21–16.24
- N*-lauroylsarcosine
  - for solubilization of glutathione *S*-transferase fusion proteins, 15.38–15.39
  - for solubilization of inclusion bodies, 15.54
- LB freezing buffer, A1.20, A2.6
- LB medium recipe, A2.2
- L buffer, 5.61, 5.64, 5.66–5.67
- Lck, 18.7
- LE392 *E. coli* strain, A7.5
- genotype, A3.8
  - λ* vector propagation, 2.28
- LEU2, 18.35, 18.37
- Leucine
  - codon usage, A7.3
  - nomenclature, A7.7
  - properties, table of, A7.9
- Leucine zipper, 11.33
- Leupeptin, 17.25, 18.67, A5.1
- Levan sucrose, 4.37
- LexA, 18.14
- bait-LexA fusion protein, 18.17–18.29
  - fusion plasmids, 18.18
- lexAop-lacA* reporter gene, 18.17
- lexAop-lacZ* reporter, 18.30, 18.32, 18.36
- lexAop-LEU2*, 18.17, 18.22, 18.36
- LFSTA program, A11.4
- LG90 *E. coli* strain genotype, A3.8
- l*-histidinol, 17.61, 17.63–17.67, 17.69
- Libraries. *See also* cDNA libraries; Expression libraries, screening; Genomic libraries; *λ* vectors, libraries
- arrayed libraries, 4.8, 4.39, 4.50, 4.61, 9.90
  - screening for related genes using MOPAC, 8.68
- LiCl. *See* Lithium chloride
- LIC-PCR. *See* Ligation-independent cloning
- lig* gene, 1.159
- Ligase, DNA, A4.30–A4.34. *See also* Ligation reactions
- bacteriophage T4, 1.157–1.158, 3.37, A4.31–A4.32, A4.34
  - activity of, A4.31
  - blunt-end ligation, A4.32
  - cohesive termini/nick ligation, A4.32
  - linker/adaptor attachment to cDNA, 11.54
  - uses, list of, A4.31
- E. coli*, 1.158–1.159, A4.33
- in cDNA second strand synthesis, 11.43, 11.45–11.46
- λ*, 2.3
- overview, 1.157
  - table of properties, 1.158
  - thermostable, 1.158, A4.34
  - units of activity, 1.159
- Ligase, T4 RNA ligase, 1.157
- Ligase amplification reaction, 1.157, 1.159
- Ligation buffer with polyethylene glycol, 5.71
- Ligation reactions
  - adaptor attachment to protruding termini, 1.89
  - in BAL 31 mutagenesis protocol, 13.66
- cDNA
  - into *λ* vectors, 11.61
  - linker/adaptor attachment to, 11.51–11.55
  - into plasmid vectors, 11.63
- in circular mutagenesis protocol, 13.24
- condensing and crowding agents, 1.23–1.24, 1.152, 1.157–1.159
- in cosmid vectors, 4.15, 4.21–4.22
- dephosphorylation of plasmid DNA and, 1.93
- in directional cloning procedures, 1.84–1.85, 1.87
- DNA fragments with blunt ends, 1.22–1.24, 1.90–1.92
- DNA fragments with protruding ends, 1.20–1.21
- in exonuclease III mutagenesis protocol, 13.61
- fragment ratios, 1.21
- inhibition
  - by agarose, 5.18, 5.29
  - by dATP, 1.85
  - by TBE buffer, 5.30
- in inverse PCR protocol, 8.84
- λ* arms to insert genomic DNA, 2.84–2.86
- linker addition to blunt-ended DNA, 1.99–1.102
- in low-melting-temperature agarose, 1.103–1.104, 5.29
- M13 vectors, 3.36–3.37
- oligonucleotide ligation assay (OLA), 13.96
- PCR product cloning
  - blunt-end cloning, 8.33–8.34
  - controls, inclusion of, 8.41
  - directional cloning, 8.40
  - T vector cloning, 8.36
- ratio of components, 1.90–1.91
- restriction enzyme inclusion into, 1.100
- in shotgun sequencing protocol, 12.15, 12.18–12.19, 12.25
- in USE mutagenesis, 13.28
- Ligation-independent cloning, 11.121–11.124
- LightCycler, 8.95
- Lightning Plus intensifying screens, A9.11
- Line elements, 11.95
- LINE (long interspersed nuclear element) sequences, 4.75
- Linear amplification DNA sequencing. *See* Cycle DNA sequencing
- Linear polyacrylamide as carrier in ethanol precipitation of DNA, A8.13
- Linker kinase buffer, A1.11
- Linkers. *See also* Adaptors
- addition to blunt-ended DNA, 1.98–1.102
  - cDNA cloning, 11.20–11.21, 11.51–11.55
  - checking reaction products, 1.102
  - in direct selection of cDNAs protocol, 11.102
  - ligation, 1.99–1.102
  - phosphorylation of, 1.99, 1.101
  - sequences, table of, 1.99
- Linker-scanning mutagenesis, 13.75–13.77
- LipofectAce, 16.5, 16.11
- Lipofectamine, 16.5, 16.11
- Lipofectin [*N*[(1-(2,3-dioleoyloxy)propyl)-*n,n,n*-trimethylammonium chloride (DOTMA)], 16.5, 16.7–16.8, 16.11–16.12
- Lipofection, 11.85, 16.3, 16.7–16.13
- chemistry of, 16.50
  - lipids used in, 16.8, 16.11, 16.51
  - materials for, 16.7–16.11
  - optimizing, 16.51
  - overview of, 16.50–16.51
  - protocol, 16.12–16.13
- Liposomes formation by sonication, 16.7
- LipoTaxi, 16.5
- Liquid chromatography-tandem MS (LC-MS/MS), 18.66
- Liquid Gold, 1.105
- Liquid media for *E. coli*, A2.2–A2.4

- Liquid nitrogen  
 for tissue preparation in RNA purification protocols, 7.10–7.11  
 in tissue sample homogenization, 6.7–6.8
- Lithium chloride (LiCl), 1.59, A1.27  
 in column-loading buffers, 7.16  
 in ethanol precipitation of nucleic acids, A8.12  
 precipitation of contaminating nucleic acid fragments, 1.59, 1.82–1.83  
 precipitation of large RNAs with, A8.16  
 in transcriptional run-on assay protocol, 17.28
- LMT elution buffer, 5.30
- Loading buffers. *See* Gel-loading buffers
- Locus Link database, A10.15
- lon*, 2.7, 11.66, 14.6, 14.39, 14.47–14.48, 15.19, 15.58
- Long PCR buffer, 8.78, 13.21
- Low-melting-temperature agarose. *See* Agarose, low-melting-temperature
- loxP*. *See also* Cre-*loxP* recombination system  
 in BAC vectors, 4.3  
 in  $\lambda$  vectors, 4.83  
 in P1 vectors, 4.4–4.5, 4.37, 4.82–4.83  
 sequence, 4.82–4.83
- luc* gene, 17.96
- Luciferase, 17.42–17.47, 17.96  
 bacterial, A9.23–A9.24  
 dual reporter assay system, 17.96  
 firefly, A9.21–A9.23  
 assays for, A9.22–A9.23  
 liquid scintillation spectroscopy, A9.22–A9.23  
 luminometry, A9.22  
 photographic/X-ray film, A9.23  
 properties of, A9.21–A9.22  
 as reporter molecule, A9.23  
 peroxisome targeting of, 17.96  
 reaction catalyzed by, 17.96  
 as reporter gene, 17.30–17.31, 17.42–17.47  
 advantages of, 17.42  
 luminometer measurements from 96-well plates, 17.47  
 materials for, 17.44  
 methods, 17.45–17.47  
 optimizing measurement, 17.45  
 pGL3 vectors, 17.43  
 scintillation counting protocol, 17.46  
 as transfection-positive control, 16.4
- Luciferase assay buffer, 17.44
- Lucigenin, structure of, A9.17
- Lumi-Gal, 17.50
- Lumigen-PPD, 9.79
- Luminol, 9.79, 14.11, 14.21  
 in enzyme assays, A9.19–A9.20  
 horseradish peroxidase and, A9.35–A9.37  
 as immunoassay label, A9.18  
 structure of, A9.16
- Luminometers, 17.42, 17.45–17.47  
 bioluminescence and, A9.21–A9.22  
 chemiluminescence and, A9.20
- luxA* gene, A9.23–A9.24
- luxB* gene, A9.23–A9.24
- LXI-Blue MRF<sup>+</sup> *E. coli* strain,  $\lambda$  vector propagation in, 2.28
- Lysine  
 codon usage, A7.3  
 properties, table of, A7.9
- Lysis buffers  
 Alkaline lysis solutions I, II and III, 1.32–1.33, 1.35–1.36, 1.38, 1.40, 3.24, 12.31, A1.16  
 for DNA isolation from mammalian cells grown in microtiter plates, 6.19  
 for DNase I hypersensitivity mapping, 17.19  
 extraction/lysis buffers, A1.16  
 in genomic DNA isolation from mouse tails, 6.24–6.26  
 for mammalian DNA isolation, 6.4, 6.6–6.7, 6.9
- PCR lysis solution, 6.22  
 for rapid isolation of mammalian DNA, 6.28–6.29  
 for rapid isolation of yeast DNA, 6.31–6.32  
 red blood cells, 6.28–6.29  
 in reporter assay protocols, 17.36, 17.38  
 in screening expression library protocol, 14.15–14.18  
 SNET, 6.24–6.25  
 in transcriptional run-on assay protocol, 17.24  
 yeast lysis buffer, 5.66
- Lysogen extraction buffer, 14.38
- Lysogeny  
 induction, 2.9  
 in  $\lambda$ , 2.3, 2.9–2.11, 2.15–2.18
- Lysozyme, A1.8, A4.51  
 for cell lysis prior to affinity chromatography, 15.38, 15.46  
 discovery of, 1.153  
 in *E. coli* lysate preparation for affinity chromatography, 14.29  
 inhibition of T7 RNA polymerase, 9.88, 15.21, 15.24  
 in M13 RF DNA preparation, 3.24  
 overview, 1.153  
 in plasmid DNA preparation protocols  
 alkaline lysis with SDS, 1.33, 1.36  
 boiling lysis, 1.43–1.45, 1.49  
 lysis with SDS, 1.57  
 in washing solution for inclusion bodies, 15.10
- Lyticase, 5.66–5.67, A1.8  
 yeast cell wall digestion, 4.60
- M9 medium recipe, A2.2
- M13 bacteriophage, 1.11, 3.1–3.49. *See also* M13 vectors  
 adsorption to sex pili, 3.5  
 DNA capacity of, 3.7  
 DNA preparation  
 double-stranded (replicative form), 3.23–3.25  
 large-scale, 3.30–3.33  
 single-stranded, 3.26–3.29  
 uracil-substituted DNA, 13.11–13.14  
 DNA purification, 12.21–12.23  
 blunt-ended, dephosphorylated DNA for shotgun cloning, 12.24  
 small numbers of single-stranded templates, 12.23  
 genetic map of, 3.3  
 growing in liquid culture, 3.20–3.22  
 morphogenesis, 3.5–3.6  
 phage display, 18.3  
 plaques  
 picking, 3.22, 12.21  
 type, 3.2, 3.17  
 plating, 3.17–3.19  
 precipitation with polyethylene glycol, 3.26–3.28  
 proteins encoded, 3.2–3.7  
 functions of, 3.4  
 replication, 3.2, 3.5–3.7  
 site-specific mutagenesis, 8.42  
 structural model of, 3.7  
 transcription, 3.5  
 uracil-substituted DNA, preparation of, 13.11–13.14
- M13 vectors, 3.8–3.16, A3.5  
 analysis of clones, 3.39–3.41  
 screening by hybridization, 3.41  
 size analysis by electrophoresis, 3.39–3.41  
 bacterial host for, 3.10–3.16  
 cloning problems, strain-dependent, 3.11, 3.16  
 F plasmid, maintaining, 3.11  
 markers, 3.10–3.11  
 strain, choosing and maintaining, 3.11–3.16  
 table of, 3.12–3.13
- cloning  
 locations  
 gene X, 3.9–3.10  
 large intergenic region, 3.9  
 multiple cloning sites, table of, 3.14  
 small intergenic region, 3.9  
 materials, 3.35–3.36  
 methods  
 dephosphorylation of vector DNA, 3.34  
 forced (directional cloning), 3.34  
 ligation of insert into linearized vector, 3.34  
 protocol, 3.36–3.38  
 transformation reactions, 3.37–3.38  
 deletions and rearrangements, limiting, 3.33–3.34, 3.49  
 growth times, 3.49  
 history of, 3.8  
 insert size, 3.33  
 nested deletion mutant set creating, 13.57, 13.59–13.61  
 oligonucleotide-directed mutagenesis protocol, 13.15–13.18  
 overview, 3.8–3.10  
 phagemids, 3.42–3.49  
 primers for cloning sites in, 8.115  
 screening clones for site-directed mutagenesis, 13.40–13.46  
 in shotgun sequencing protocol, 12.19–12.25  
 dephosphorylated, blunt-ended DNA preparation, 12.24  
 DNA purification, 12.21–12.24  
 growth in 96-tube format, 12.19–12.21  
 single numbers of templates, preparing, 12.23  
 test ligations, 12.25  
 subcloning YAC DNAs into, 4.64
- M13-100 vector, 3.9–3.10
- M13K07 vector, 3.42, 3.44–3.47, 18.116
- M13KE vector, 18.118, 18.120
- M13mp series vectors, 3.8–3.9, 3.14
- M5219 *E. coli* strain, 15.4, 15.25, 15.27, A3.8
- MACAW (Multiple Alignment construction and Analysis Workbench) program, A11.7
- Macroplagues,  $\lambda$ , 2.31
- MaeI* cleavage of 7-deaza-dGTP modified DNA, 8.60
- Magic Minipreps, 12.27
- Magnesium chloride  
 MgCl<sub>2</sub>·6H<sub>2</sub>O solution, A1.27  
 MgCl<sub>2</sub>·CaCl<sub>2</sub> solution, A1.21  
 in Sequenase reaction buffer, 12.33
- Magnesium ions  
 DNase I and, 17.6, 17.10–17.11, 17.75, A4.40–A4.41  
 exonuclease III and, 13.73  
 inhibition of *EcoRI* methylase by, 11.48  
 in M13 growth media, 12.21, 12.23  
 in PCRs, 8.5–8.6, 8.21, 8.110  
 PEG stimulation of DNA ligation and, 1.152
- Magnesium sulfate (MgSO<sub>4</sub>), A1.27
- Magnetic beads  
 overview, 11.118–11.120  
 streptavidin-coated, 7.20  
 uses for, table of, 11.120
- MalE, 15.7, 15.40  
 affinity purification of fusion proteins, 15.4  
 soluble fusion protein production, 15.9
- Maltoporin,  $\lambda$  adsorption to, 2.4
- Maltose, A1.27, A2.8  
 induction of *lamB* gene, 11.62  
 for  $\lambda$  growth, 2.26  
 in  $\lambda$  media, 11.62
- Maltose-binding fusion proteins, 14.47, 15.26  
 affinity chromatography purification, 15.6, 15.40–15.43

- Mammalian cells. *See also* COS cells  
 codon usage, 10.7  
 Cre-*loxP* site-specific integration/excision of transgenes, 4.84–4.85  
 DNA isolation  
   concentration measurement  
     by fluorometry, 6.12  
     by spectrophotometry, 6.11, 6.15  
   from microtiter plate cultures, 6.19–6.22  
   from mouse tails  
     harvesting of tails, 6.24  
     one-tube isolation, 6.26–6.27  
   from paraffin blocks, 6.27  
   protocol, 6.23–6.25  
   sample storage, 6.24  
   without extraction by organic solvents, 6.26  
   from paraffin blocks, 6.27  
   for pulsed-field gel electrophoresis, 5.61–5.64  
   rapid isolation protocol, 6.28–6.30  
   by spooling, 6.16–6.18  
   using formamide, 6.13–6.15  
   using proteinase K and phenol, 6.4–6.11  
     100–150-kb DNA size, 6.10, 6.11  
     150–200-kb DNA size, 6.10–6.11  
     lysis of blood cells, 6.8–6.9  
     lysis of monolayer cells, 6.6  
     lysis of suspension cells, 6.7  
     lysis of tissue samples, 6.7–6.8  
 expression in. *See* Expression in mammalian cells  
 glycerol and efficiency of transient expression and transformation, 13.90  
 nuclear extract preparation from, 17.8–17.10, 17.26–17.27  
 RNA isolation from, 7.7, 7.11  
   poly(A)<sup>+</sup> selection by batch chromatography, 7.18–7.19  
   poly(A)<sup>+</sup> selection by oligo(dT) chromatography, 7.13–7.17  
 transfection, 16.1–16.57  
   biolistics, 16.3, 16.37–16.41  
     materials for, 16.38–16.39  
     method, 16.39–16.41  
     particle types, 16.37  
     variables, 16.37  
   calcium-phosphate-mediated, 16.3, 16.14–16.26, 16.52–16.53  
   of adherent cells, 16.25  
   of cells growing in suspension, 16.26  
   chloroquine treatment, 16.14, 16.17, 16.52  
   cotransformation, 16.24  
   efficiency, factors affecting, 16.52  
   with genomic DNA, 16.21–16.24  
   glycerol shock, 16.14, 16.17, 16.52  
   high efficiency, 16.19  
   mutation prevalence, 16.53  
   with plasmid DNA, 16.14–16.20  
   sodium butyrate, 16.14, 16.17–16.18  
 cell line variation, 16.57  
 controls, 16.4–16.5  
   for stable expression, 16.4–16.5  
   for transient expression, 16.4  
 cotransformation, 16.24, 16.47  
 by DEAE-dextran, 16.3, 16.27–16.32  
   calcium phosphate method compared, 16.27  
   cell viability, increasing, 16.32  
   facilitators of, 16.28  
   kits, 16.30  
   materials for, 16.29–16.30  
   mechanism of action, 16.27  
   method, 16.30–16.31  
   mutation prevalence, 16.28, 16.53  
   variables, 16.27–16.28  
 electroporation, 16.3, 16.33–16.36, 16.54–16.57  
   efficiency, factors influencing, 16.33–16.34, 16.57  
   materials for, 16.34–16.35  
   method, 16.35–16.36  
   by lipofection, 16.3, 16.7–16.13  
     chemistry of, 16.50  
     lipids used in, 16.8, 16.11, 16.51  
     materials for, 16.7–16.11  
     optimizing, 16.51  
     overview of, 16.50–16.51  
     protocol, 16.12–16.13  
   methods, summary of, 16.3  
   polybrene, 16.3, 16.43–16.46  
   stable, selective agents for, 16.48–16.49  
   tetracycline regulation of inducible gene expression and, 17.60–17.70  
   transient vs. stable, 16.2  
   transformation by YACs, 4.63–4.64  
   trypsinization, 16.12  
   vector systems for, 11.72  
 Mammalian Transfection Kit Primary ENHANCER Reagent, 16.5  
 Mammalian vectors, A3.3–A3.4  
 Manganese chloride (MnCl<sub>2</sub>) in Sequenase reaction buffer, 12.43  
 Manganese ions  
   DNase I and, A4.40–A4.41  
   exonuclease III and, 13.73  
 Mannose phosphotransferase, 2.4  
 Mapping  
   DNase I hypersensitivity sites, 17.18–17.22  
   identical-by-descent (IBD), A10.17–A10.18  
   influence of methylation on DNA mapping, A4.6–A4.9  
   mutations with RNase A, A4.39  
   protein-binding sites on DNA  
     by DNase I footprinting, 17.4–17.11  
     by hydroxyl radical footprinting, 17.12  
 MAR-Finder program, A11.13  
 Markers  
   chemiluminescent, 1.140, 2.98–2.99  
   migration rate of dyes through polyacrylamide gels, 12.89  
   molecular-weight. *See* Molecular-weight markers  
 Mass map, 18.66  
 Mass spectrometry, 18.3, 18.62, 18.66  
 MAST (Motif Alignment and Search Tool) program, A11.9–A11.10  
 MAT $\alpha$ , 18.22  
 Matrix-assisted laser desorption-time of flight (MALDI-TOF) mass spectrometry, 18.66  
 Maxam-Gilbert sequencing. *See* DNA sequencing, chemical method  
 MAXIscript, 9.32  
 MBM7014.5 *E. coli* strain  
   genotype, A3.8  
    $\lambda$  vector propagation, 2.28  
 MboI  
   *dam* methylation and, 13.87, A4.3  
   genomic DNA digestion, 4.11, 4.15, 4.20  
 MboI methylase, A4.7  
 MboII, A4.9  
   *dam* methylation and, 13.87, A4.3  
   methylase, A4.7  
   for T vector creation, 8.35  
 MBS Mammalian transfection kit, 16.5  
 MC1061 *E. coli* strain, 1.118  
   genotype, A3.8  
    $\lambda$  vector propagation, 2.28  
   transformation by Hanahan method, 1.106  
*mcr* restriction system, 11.21, 11.48  
 in vitro  $\lambda$  packaging and, 2.111, 11.113  
*mcrA*, 1.15, A4.4–A4.5  
    $\lambda$  propagation and, 2.28  
   M13 vectors and, 3.11, 3.13  
*mcrB*, A4.4  
    $\lambda$  propagation and, 2.28–2.29  
 MDE (mutation detection enhancement), 13.51, 13.53, 13.56  
 Media, A2.1–A2.2. *See also specific media; specific protocols*  
   agar/agarose containing, A2.5  
   antibiotics, A2.6–A2.7  
   bacteriophage  $\lambda$ -related, A2.8  
   liquid media for *E. coli*, A2.2–A2.4  
   storage, A2.6  
   yeast propagation and selection, A2.9–A2.11  
 Medline, 1.14  
 Megaprimer method of mutagenesis, 13.8–13.10, 13.31–13.35  
 MEGAscript, 9.32  
 Melting temperature  
   calculating, 10.2–10.4, 10.47–10.48  
   guessmers and, 10.8  
   inosine and, 10.9–10.10  
   of megaprimers in mutagenesis protocol, 13.31–13.32  
   in quaternary alkylammonium salts, 10.6  
 Membrane Expression arrays, A10.9  
 MEME (Multiple Expectation Maximization for Motif Elicitation) program, A11.8–A11.9  
 MERMAID, 10.49  
 MES (2-[*N*-morpholino]ethane-sulfonic acid), 1.105, 1.107  
 Metal chelate affinity chromatography, 15.44–15.48  
 Metallothionein promoter, 16.5  
 Methanol  
   methanol/KOH solution, A1.20  
   for polyacrylamide gel fixation, 12.90–12.92  
 Methionine  
   cleavage by cyanogen bromide, 15.6, 15.8  
   codon usage, A7.3  
   nomenclature, A7.7  
   properties, table of, A7.9  
   in pulse-chase experiments, 15.18–15.19  
 Methotrexate (MTX), 16.47, 16.49, A2.7  
 Methylated DNA, *E. coli* strains for propagation of, 1.15–1.16  
 Methylation, 11.21, A4.3–A4.9  
   of cDNA, 11.48–11.50  
   5' methyldeoxycytosine incorporation, 11.48  
   *EcoRI*, 11.48–11.50  
   in chemical sequencing protocol, 12.61–12.65  
   *dam* methyltransferase, A4.3  
   *dcm* methyltransferase, A4.3–A4.4  
   by dimethylsulfate, 12.5  
   DNA mapping, influence on, A4.6–A4.9  
   linker use and, 1.99  
   restriction site modification, A4.5–A4.9  
   restriction/modification systems, type I and type II, A4.4  
 Methylation interference assays, 12.63  
 Methylene blue, A9.4–A9.5  
   polyacrylamide gel staining, 5.47–5.48  
   staining of RNA on nylon membranes, 7.39  
 Methylmercuric hydroxide, 7.21–7.22, 11.9  
 4-Methylumbelliferyl- $\beta$ -D-galactoside (MUG), 17.50, 17.97–17.98  
 Met-MEME program, A11.9  
 5-Methylcytosine, 12.68, A4.4  
 MFOLD program, A11.14–A11.15  
 Mg<sup>2+</sup>. *See* Magnesium ions  
 Microarray, DNA. *See* DNA array technology  
 MicroArray Suite image analysis program, A10.13  
 Microconcentrator, 8.27–8.29, 8.58, 8.68, 12.106, A8.16–A8.17  
 Microcon concentrators, 8.27, 12.106, A8.16–A8.17  
 Microinjection of live cells, 18.88–18.89  
 MicroMax arrays, A10.9  
 Microscopy. *See* Fluorescence lifetime imaging microscopy  
 Microspheres. *See* Magnetic beads

- Microtiter plates  
 DNA isolation from mammalian cells grown in, 6.19–6.22  
 use in DNA sequencing protocols, 12.100
- Milk as blocking agent, A8.54
- Mineral oil  
 addition to PCRs, 8.22  
 removal from PCRs by chloroform extraction, 8.22
- Minigels, agarose, 5.13
- Minimal (M9) agar plates for M13 plating, 3.17–3.18
- Minimal medium for bacteria, 18.40
- MisMatch Detect II, 13.93
- Mismatch repair system, 13.88, 13.94
- Mitomycin C  
 induction of  $\lambda$  lysogen, 15.25  
 modes of action, A2.7
- Mixed oligonucleotide-primed amplification of cDNA (MOPAC), 8.66–8.71  
 analysis, 8.70–8.71  
 band-stab PCR and, 8.71  
 DNA template for, 8.68–8.70  
 materials for, 8.69  
 method, 8.70–8.71  
 primer design rules, 8.67–8.68  
 screening for related genes, 8.68  
 variations in protocol, 8.67
- MuI*  
 cleavage at end of DNA fragments, A6.4  
 genomic DNA mapping, 5.69  
 methylation, A4.7
- MLV (murine leukemia virus). *See* Moloney murine leukemia virus reverse transcriptase
- MM294 *E. coli* strain, 1.14–1.15, 1.25  
 genotype, A3.8  
 $\lambda$  vector propagation, 2.28  
 transformation by Hanahan method, 1.106
- Mn<sup>2+</sup> ions. *See* Manganese ions
- mob*, 1.146
- Mobility of DNA, electrical, 12.114
- Modeling, molecular, 18.3
- Modrich-Lehman unit of ligase activity, 1.159
- Molecular modeling, 18.3
- Molecular modeling database (MMDDB), A11.22
- Molecular-weight markers, 5.10, 7.23, A6.4  
 $\lambda$  DNA concatamers, 5.59, 5.71–5.73  
 migration rate of dyes through polyacrylamide gels, 12.89  
 for pulsed-field gel electrophoresis, 5.59–5.60, 5.71–5.73  
 for RNA gels, 5.59–5.60, 5.71–5.73
- Moloney murine leukemia virus (Mo-MLV) reverse transcriptase, 11.109–11.110, A4.24–A4.25  
 in commercial kits for cDNA synthesis, 11.108  
 inhibition by sodium pyrophosphate, 11.46  
 RNA-dependent DNA polymerase, 8.48  
 RNase H<sup>+</sup>, 11.38
- Mo-MLV. *See* Moloney murine leukemia virus reverse transcriptase
- Monoclonal antibodies in immunological probes, 11.33
- Monolayer cultures, lysis of cells growing in, 6.6
- Monophasic lysis reagents, 7.10–7.12
- MOPAC. *See* Mixed oligonucleotide-primed amplification of cDNA
- MOPS electrophoresis buffer, 7.32, A1.18
- MOPS salts, 15.31
- Mouse mammary tumor virus long terminal repeat promoter, 16.5
- Mouse tails, genomic DNA isolation from  
 harvesting of tails, 6.24  
 one-tube isolation, 6.26–6.27  
 from paraffin blocks, 6.27  
 protocol, 6.23–6.25  
 sample storage, 6.24  
 without extraction by organic solvents, 6.26
- Mouse-tail lysis buffer, 6.26
- Mowiol mounting medium, 18.87–18.88
- mp18/mp19, 8.115
- mRNA. *See also* Expression in mammalian cells; RNA  
 3'-RACE procedure and, 8.61  
 5'-RACE procedure and, 8.54–8.55, 8.58  
 cDNA cloning. *See* cDNA cloning  
 cDNA library construction  
 expression library, 11.70  
 from small numbers of cells, 11.112  
 cDNA preparation, 11.39–11.42  
 enrichment methods, 11.8–11.11  
 fractionation of cDNA, 11.9–11.10  
 fractionation of mRNA, 11.9  
 number of clones needed for library, 11.8  
 overview, 11.8–11.9  
 polysome purification, 11.10  
 subtractive cloning, 11.10–11.11  
 integrity of mRNA, 11.7–11.8, 11.39, 11.42  
 source of mRNA, 11.6–11.7  
 differential display-PCR, 8.96–8.106  
 differential expression, screening for, 9.89–9.91  
 eukaryotic  
 concentration, measurement  
 northern blots, 7.66  
 quantitative RT-PCR, 7.66  
 reassociation kinetics, 7.65–7.66  
 ribonuclease protection, 7.66  
 mapping  
 mung bean nuclease, 7.55  
 nuclease S1, 7.51–7.62  
 primer extension, 7.75–7.81  
 ribonuclease protection assays, 7.63–7.74  
 northern hybridization. *See* Northern hybridization  
 overview, 7.2  
 purification  
 acid phenol-guanidinium thiocyanate-chloroform extraction, 7.4–7.8  
 poly(A) selection by patch chromatography, 7.18–7.19  
 poly(A) selection by oligo(dT)-cellulose chromatography, 7.13–7.17  
 poly(A) selection by poly(U)-Sepharose chromatography, 7.15, 7.20  
 poly(A) selection by streptavidin-coated beads, 7.20  
 simultaneous preparation with DNA and protein, 7.9–7.12  
 RNases and, 7.2  
 isolation from COS-7 cells, 11.87–11.88  
 mapping  
 3'-RACE, 8.61–8.62  
 5'-RACE, 8.54–8.55  
 for microarray hybridization, A10.10, A10.13–A10.14  
 reverse transcription by RT-PCR, 8.46–8.53  
 screening with subtracted cDNA probes, 11.29–11.31  
 splicing, 18.123–18.124  
 stability and G+C content, A7.2
- mrr*, 1.15–1.16, A4.4  
 in vitro  $\lambda$  packaging and, 2.111, 11.113  
 M13 vectors and, 3.11, 3.13
- MS2 phage, 18.11
- MSA program, A11.6
- Mse*I, A4.9
- Msp*I in site-directed mutagenesis protocol, 13.84
- Msp*I methylase, A4.5, A4.7
- MTX. *See* Methotrexate
- MultAlin program, A11.8
- Multichannel pipettor, 6.20
- Multiplex PCR, 8.5, 8.107  
 nonspecific amplification, 8.107  
 optimizing, 8.107
- MultipROBE II (Packard), A10.5
- Mung bean nuclease, 7.55, 7.86, A4.47  
 in exonuclease III mutagenesis protocol, 13.57, 13.74–13.75  
 overview of, 7.87
- Mun*I cleavage at end of DNA fragments, A6.4
- Munich 13. *See* M13
- Muristerone A, 17.71
- Muta-gene in vitro mutagenesis kit, 13.89
- Mutagenesis  
 alanine-scanning, 13.81  
 BAL 31 use, 13.62–13.67  
 bisulfite-mediated, A4.41  
 cassette, 13.79  
 chemical, 13.78–13.79  
 circular, 13.19–13.25  
 of coding sequences, 13.2–13.4  
 oligonucleotide-directed, 13.3–13.7  
 saturation mutagenesis, 13.2–13.3  
 scanning mutagenesis, 13.3  
 deletion mutants  
 bidirectional sets, 13.62–13.67  
 nested sets, 13.57–13.61, 13.74–13.75  
 exonuclease III use, 13.57–13.61  
 in vitro, 12.102, 13.19–13.25  
 kits for, 13.89  
 Kunkel method, 13.84  
 linker-scanning, 13.75–13.77  
 misincorporation, 13.80  
 oligonucleotide-directed  
 elimination of unique restriction site, 13.26–13.30  
 oligonucleotide design guidelines, 13.82  
 overview of, 13.3–13.7  
 design, 13.4  
 diagram of scheme, 13.5  
 history of, 13.4–13.7  
 methods of, 13.4  
 steps in, 13.6  
 random mutations using spiked primers, 13.80  
 selection of mutants with *Dpn*I, 13.19–13.25, 13.84–13.85  
 of single-stranded DNA, 13.15–13.18  
 troubleshooting, 13.18  
 uracil-substituted DNA preparation, 13.11–13.14  
 USE mutagenesis, 13.26–13.30, 13.85  
 PCR-mediated, 13.7–13.10  
 random, 13.78–13.80  
 cassette mutagenesis, 13.79  
 chemical mutagenesis, 13.78–13.79  
 misincorporation mutagenesis, 13.80  
 with spiked oligonucleotide primers, 13.80  
 of regulatory regions, 13.2  
 screening by  
 conformational polymorphism and heteroduplex analysis, 13.49–13.56  
 hybridization to radiolabeled probe, 13.40–13.47  
 PCR, 13.48  
 site-directed  
 alanine-scanning mutagenesis, 13.81  
 codon usage, changing, 15.12  
 commercial kits for, 13.89  
 inverse PCR, deletion introduction by, 8.42  
 Kunkel method, 13.84  
 M13, 8.42  
 mutagenic oligonucleotide for, 13.82–13.83  
 oligonucleotide-directed, 13.3–13.7, 13.11–13.30, 13.84–13.85  
 PCR end modification protocol, 8.42–8.45  
 PCR-mediated

- Mutagenesis (*continued*)
- megaprimer method, 13.8–13.10, 13.31–13.35
  - overlap extension, 13.8, 13.36–13.39
  - overview, 13.7–13.10
  - polymerase choice for, 13.20–13.21
  - restriction site creation/removal, 13.82–13.83, 13.85
  - screening
    - by conformational polymorphism and heteroduplex analysis, 13.49–13.56
    - by hybridization to radiolabeled probe, 13.40–13.46
    - by PCR, 13.48
    - phagemid-containing colonies by hybridization, 13.47
  - selection *in vitro*, 13.84–13.87
    - DpnI* destruction of parentals, 13.19–13.25, 13.84
    - phosphorothioate analog incorporation, 13.86–13.87
    - unique restriction site elimination, 13.26–13.30, 13.85
    - uracil-DNA glycosylate destruction of parentals, 13.84–13.85
  - selection *in vivo*, 13.87
- Mutagenesis buffer, 13.21
- Mutan-Express Km Kit, 13.89
- Mutation detection, 13.91–13.96
- allele-specific oligonucleotides (ASO), 13.91, 13.95
  - amplification refractory mutation system (ARMS), 13.91, 13.96
  - arrays, mutation detection, A10.3
  - bidirectional dideoxy fingerprinting (Bi-ddF), 13.91, 13.94
  - CDI modification, 13.95
  - chemical cleavage of mismatched bases (CCM), 13.91, 13.95
  - competitive oligonucleotide priming (COP), 13.91, 13.96
  - denaturing gradient gel electrophoresis (DGGE), 13.91, 13.92
  - dideoxy fingerprinting (ddF), 13.91, 13.94
  - with DNA mismatch repair enzymes, 13.94
  - oligonucleotide ligation assay (OLA), 13.91, 13.96
  - primer extension, 13.91, 13.96
  - protein truncation test (PTT), 13.92
  - with resolvases, 13.94
  - restriction endonuclease fingerprinting (REF), 13.91, 13.94
  - RFLP/PCR, 13.91, 13.95
  - scanning vs. specific methods, 13.91
  - single-stranded conformational polymorphism (SSCP), 13.91, 13.93
- Mutation detection enhancement. *See* MDE
- Mutations
- amber, A7.5
  - conditional, A7.5
  - temperature-sensitive, A7.5
- mutS*, 13.29–13.30, 13.85, 13.87
- mutY*, 13.94
- MV1184 *E. coli* strain, 13.47
- genotype, A3.8
  - M13 vectors and, 3.13
  - phagemids and, 3.42, 3.44, 3.46
- MV1190 *E. coli* strain
- genotype, A3.8
  - phagemids and, 3.46
- MV1193 *E. coli* strain genotype, A3.8
- MV1304 *E. coli* strain, phagemids and, 3.46
- MvaI* methylase, A4.7
- Mycophenolic acid, 16.49
- MZ-1 *E. coli* strain genotype, A3.8
- MZEF (Michael Zhang's exon finder) program, A11.12
- NaCl. *See* Sodium chloride
- NaeI*
- fragment size created by, table of, A4.8
  - methylation, A4.7
  - site frequency in human genome, 4.16, A6.3
- Nalidixic acid induction of  $\lambda$  lysogen, 15.25
- Nanogenchips, A10.19
- NaOH. *See* Sodium hydroxide
- NarI*
- fragment size created by, table of, A4.8
  - methylation, A4.7
  - site frequency in human genome, 4.16, A6.3
- NA stop/storage buffer, 9.6, 9.9
- National Center for Biotechnology Information (NCBI), A11.2, A11.22
- NBT. *See* Nitroblue tetrazolium
- NciI* in phosphorothioate incorporation mutagenesis, 13.86
- NcoI*
- cleavage at end of DNA fragments, A6.4
  - linker sequences, 1.99
- NdeI*, 1.99, A4.9
- NdeII*, A4.9
- Nebulization of DNA, 12.11, 12.14, 12.16–12.17, A8.37–A8.38
- calibration of nebulizer, A8.37–A8.38
- NENSorb, 10.49
- Neomycin, 17.74, A2.7
- Neomycin resistance marker in YACs, 4.64
- Nested deletion mutant, generating with exonuclease III, 13.57–13.61, 13.74–13.75
- NetGene program, A11.11
- NETN, 18.67–18.68
- Neutralization buffer/solution, 10.38
- for alkaline agarose gels, 5.37
  - for alkaline transfer of DNA to nylon membranes, A1.13
  - for neutral transfer, double-stranded DNA targets only, A1.13
  - in Southern hybridization, 6.41, 6.43
  - for transfer of DNA to uncharged membranes, A1.13
- NF-1 nuclear factor, 17.8, 17.11
- nflA*, *E. coli* gene, 2.7
- nflB*, *E. coli* gene, 2.7
- N* gene,  $\lambda$ , 2.6–2.9, 15.25
- NgoI* IV cleavage at end of DNA fragments, A6.4
- NheI*
- cleavage at end of DNA fragments, A6.4
  - fragment size created by, table of, A4.8
  - linker sequences, 1.99
  - site frequency in human genome, 4.16, A6.3
- NHS (*N*-hydroxysuccinimide), 18.104–18.105
- $\text{Ni}^{2+}$  absorption chromatography, 15.44–15.48
- elution with imidazole, 15.47
  - generation of resin, 15.48
- nic* site, 1.146
- Nick translation
- biotin labeling of genomic clones, 11.102
  - digoxigenin labeling of nucleic acids, A9.38–A9.39
  - DNA polymerase and, 9.85–9.86
  - history of, 9.12
  - kits, 9.13
  - optimizing reactions, 9.13
  - procedure, 9.12–9.13
  - random priming compared, 9.4
  - using *E. coli* DNA polymerase, A4.12
- Nick translation buffer, 11.100
- NIH-3T3 cells, 17.60–17.67
- nin* (*N*-independent) mutants,  $\lambda$ , 2.7
- Nitric acid, A1.6
- Nitrotriacetate (NTA)- $\text{Ni}^{2+}$ -agarose, 15.46
- Nitroblue tetrazolium (NBT), 9.78, 14.9–14.10, 14.20, A9.39–A9.42
- Nitrocellulose membranes, 1.28. *See also*
- Hybridization
- amplification of bacteriophages on, 2.95
  - amplification of cosmid libraries, 4.31–4.32
  - baking, 2.94, 6.46
  - colorimetric detection of nonradioactive probes on, 9.78
  - denaturing DNA on, 2.94
  - disadvantages of, 6.37–6.38
  - DNA transfer. *See also* Southern hybridization, DNA transfer methods
  - electrophoretic, 6.36
  - from plaques to filters, 2.91, 2.93–2.95
  - vacuum transfer, 6.37
  - fixing DNA to, 2.94–2.95
  - gluing to 3MM paper, 2.99
  - for immunological screening, 11.32, 14.6–14.13, 14.17–14.22, A8.53
  - in  $\lambda$  library screening by PCR protocol, 8.76
  - lysis of colonies and binding of DNA, 1.136
  - for microarray applications, A10.6–A10.7
  - in northern hybridization, 7.23–7.24
  - nylon filters compared, 2.91
  - probe removal from, in Southern hybridizations, 6.57
  - properties of, 6.38
  - reagents for detection of antibody-antigen complex, 14.3
  - RNA binding to, 6.37
  - screening
    - bacterial colonies by hybridization, 1.126–1.134
    - bacterial DNA with radiolabeled probe, 1.138–1.142
    - cosmid libraries by hybridization, 4.24–4.27
    - expression libraries by labeled probes, 14.31–14.36
    - storage of, 6.37–6.38
    - in transcriptional run-on assay hybridizations, 17.28–17.29
    - wetting, 6.44, 6.49
  - p*-nitrophenyl phosphate, A9.41–A9.42
  - Nitrosomethylurea use in M13 vector creation, 3.8
  - Nitrous acid, mutagenesis from, 13.78
  - NM519 *E. coli* strain
    - genotype, A3.8
    - $\lambda$  vector propagation, 2.28
  - NM522 *E. coli* strain
    - genotype, A3.9
    - $\lambda$  vector propagation, 2.29
    - M13 vectors and, 3.13
  - NM531 *E. coli* strain
    - genotype, A3.9
    - $\lambda$  vector propagation, 2.28
  - NM538 *E. coli* strain
    - genotype, A3.9
    - $\lambda$  vector propagation, 2.28
  - NM539 *E. coli* strain
    - genotype, A3.9
    - $\lambda$  vector propagation, 2.29
  - NM554 *E. coli* strain
    - for cosmid stability, 4.28
    - genotype, A3.9
  - N*-methylimidazole (NMI), 10.42
  - NNPP (promoter prediction by neural network) program, A11.12
- Nonidet P-40
- in cell lysis buffers, 17.36
  - in coimmunoprecipitation solutions, 18.67
  - in DNA sequencing reactions, 12.38, 12.55
  - in homogenization buffer, 17.9, 17.26
  - in PCR lysis solution, 6.22
  - in supershift assays, 17.17
- Nonisotopic RNase cleavage assay (NIRCA), 13.93
- Nonradioactive labeling, 9.76–9.81
- biotin, 9.76–9.79
  - detection after hybridization, 9.78–9.80

- chemiluminescence, 9.79–9.80  
 colorimetric assays, 9.78–9.79  
 fluorescent assays, 9.79  
 digoxigenin, 9.77  
 enzymatic methods, 9.77–9.78  
 fluorescein, 9.77  
 indirect detection systems, 9.76  
 photolabeling, 9.78  
 switching to, 9.80–9.81
- Northern hybridization  
 background, 7.45  
 cDNA library screening, 11.38  
 at low stringency, 6.58  
 low-stringency, 7.43  
 membranes used for, 6.37  
 nonradioactive labeling and, 9.76, 9.80  
 overview of, 7.21–7.26  
 protocol, 7.42–7.44  
 quantitating RNA by, 7.66  
 ribonuclease protection assay compared, 7.63–7.65  
 RNA fixation to membranes, 7.35–7.36, 7.39–7.40  
 RNA separation by size  
 electrophoresis of glyoxylated RNA, 7.27–7.30  
 equalizing RNA amounts in gels, 7.22–7.23  
 formaldehyde-agarose gels, 7.31–7.34  
 markers used in gels, 7.23, 7.29  
 overview, 7.21–7.22  
 pseudomessages as standards, 7.23  
 RNA transfer to membranes, 7.25–7.26, 7.35–7.41  
 membranes used for, 7.23–7.25  
 protocols, 7.35–7.41  
 staining of RNA on membranes, 7.39  
 steps involved, list of, 7.21  
 stripping blots, 7.44  
 troubleshooting, 7.45
- NotI*  
 cDNA linkers and adaptors and, 11.20, 11.51, 11.64  
 in cDNA synthesis kits, 11.71  
 cleavage at end of DNA fragments, 8.38, A6.4  
 fragment size created by, table of, A4.8  
 genomic DNA mapping, 5.60, 5.68–5.69  
 linker sequences, 1.99  
 methylation, A4.7  
 site frequency in human genome, 4.16, A6.3
- Novobiocin, A2.7
- NruI*  
 genomic DNA mapping, 5.69  
 methylation, A4.7
- NS3516 *E. coli* strain genotype, A3.9  
 NS3529 *E. coli* strain genotype, A3.9
- NsiI* cleavage at end of DNA fragments, A6.4
- NTA-Ni<sup>2+</sup>-agarose, 15.46  
 regeneration of, 15.48
- Nu1* gene,  $\lambda$ , 2.4, 2.15  
*Nu1* protein,  $\lambda$ , 2.14
- Nuclear extracts  
 preparation from cultured cells, 17.9–17.10  
 preparation from tissues, 17.8–17.9
- Nuclear polyhedrosis viruses (NPVs), 17.81
- Nuclear run-on assays, 17.23. *See also* Transcriptional run-on assays
- Nuclease S1, A4.46  
 digestion buffer, 7.56, 7.60, A1.11  
 digestion of hairpins, 11.46  
 in exonuclease III mutagenesis protocol, 13.57, 13.59–13.61, 13.74–13.75  
 exonuclease VII results compared, 7.86  
 hairpin digestion, 11.4, 11.16  
 inactivation, 13.61  
 mapping of RNA, 7.51–7.62  
 5' and 3' mRNA termini, 7.53  
 artifacts, 7.54–7.55  
 diagrams of, 7.52–7.53  
 digestion conditions, 7.61  
 probes, 7.51–7.55  
 protocol, 7.55–7.62  
 analysis by gel electrophoresis, 7.61–7.62  
 digestion of DNA-RNA hybrids, 7.60–7.61  
 dissolving nucleic acid pellets, 7.60  
 hybridization of probe and test RNA, 7.59, 7.60  
 materials for, 7.55–7.57  
 probe preparation, 7.58–7.59  
 probe purification by gel electrophoresis, 7.59–7.60  
 troubleshooting, 7.55  
 overview of, 7.86  
 ribonuclease protection assay compared, 7.65  
 source of, 7.86  
 stop mixture, 7.56, 13.58
- Nucleases, A4.38–A4.49. *See also* BAL 31 nuclease; Exonuclease III; Nuclease S1  
 bacteriophage  $\lambda$  exonuclease, A4.49  
 BAL 31, A4.43–A4.45  
 DNase I, A4.40–A4.42  
 exonuclease III, A4.47–A4.48  
 mung bean, A4.47  
 RNase A, A4.39  
 RNase H, A4.38  
 RNase T1, A4.39  
 S1, A4.46
- Nuclei  
 harvesting for DNase I hypersensitivity mapping, 17.20–17.21  
 isolation  
 from cultured cells, 17.26  
 from tissue, 17.27  
 radiolabeling transcription, 17.27–17.28  
 Nuclei wash buffer, 17.25
- Nucleic acid database and structure resource, A11.21
- Nucleic acid fragment removal  
 by centrifugation through NaCl, 1.78–1.79  
 by chromatography, 1.80–1.81  
 by precipitation with LiCl, 1.82–1.83
- Nucleobond AX, 1.64
- Nucleoside analogs used as chain terminators in DNA sequencing (Table A6-11), A6.10
- Nucleosomes, DNase I hypersensitivity sites and, 17.18
- NusA, 2.7, 2.14  
 NusB, 2.7  
 NusG, 2.7  
*nut* site,  $\lambda$ , 2.7
- Nylon membranes. *See also* Hybridization  
 advantages of, 6.38  
 amplification of cosmid libraries, 4.31–4.32  
 baking, 7.35–7.36, 7.39–7.40  
 biotinylated probe adherence to, 9.76  
 brand differences, 2.91  
 charged vs. neutral, 7.37, 7.39  
 chemiluminescent assays, 9.79, A9.19, A9.43–A9.44  
 colorimetric detection of nonradioactive probes on, 9.78  
 denaturing DNA on, 2.94  
 dot and slot blotting of RNA, 7.46–7.50  
 intensity of signal, measuring, 7.47  
 sample application, 7.46  
 fixing DNA to, 2.94–2.95, 6.46  
 fixing RNA to, 7.36, 7.39–7.40  
 gluing to 3MM paper, 2.99  
 history of, 7.24  
 hybridization at high temperatures, 1.141  
 for immunoblotting, A8.53  
 lysis of colonies and binding of DNA, 1.131, 1.136  
 neutral vs. charged, 6.38, 7.25, 7.35  
 nitrocellulose compared, 2.91  
 northern hybridization, 7.24–7.25, 7.35–7.41  
 fixation of RNA, 7.35–7.36, 7.39–7.40  
 transfer to charged membranes at alkaline pH, 7.35  
 transfer to neutral membranes, 7.35–7.36  
 properties of, 6.38, 7.25  
 screening bacterial colonies by hybridization, 1.126–1.134  
 screening cosmid libraries by hybridization, 4.24–4.27
- Southern hybridization  
 fixation of DNA to membrane, 6.45–6.46  
 probe removal from, 6.57  
 transfer protocol, 6.43–6.45, 6.49  
 stripping, A9.38, A9.42  
 transfer of DNA to. *See also* Southern hybridization, DNA transfer methods  
 electrophoretic, 6.36  
 from plaques to filters, 2.91, 2.93–2.95  
 vacuum, 6.37
- UV irradiation fixation of nucleic acids, 6.46, 7.36, 7.39–7.40  
 wetting, 7.38, 7.41
- NZCYM medium, 11.62, A2.3  
 NZM medium recipe, A2.3  
 NZYM medium recipe, A2.3
- o*-dianisidine, 14.3, A9.34
- OFAGE (orthogonal field agarose gel electrophoresis), 5.55. *See also* Pulsed-field gel electrophoresis
- O gene,  $\lambda$ , 2.6, 2.8–2.9, 2.11
- Oligo(dT) primers  
 in cDNA probe production, 9.42–9.43  
 for cDNA synthesis, 11.12–11.13, 11.15, 11.39  
 linked to plasmid, 11.12
- Oligo(dT)-cellulose, 7.13–7.17, 7.19–7.20
- Oligonucleotide  
 elution buffer, 10.12  
 hybridization solution, 10.35, 13.41  
 labeling buffer, 9.10  
 ligation assay (OLA), 13.91, 13.96  
 prehybridization solution, 10.35, 10.38, 13.41  
 purification cartridges (OPCs), 10.49
- Oligonucleotide-directed mutagenesis  
 efficiency of, 13.83  
 elimination of unique restriction site, 13.26–13.30  
 oligonucleotide design, guidelines for, 13.82–13.83  
 overview of, 13.3–13.7  
 design, 13.4  
 diagram of scheme, 13.5  
 history of, 13.4–13.7  
 methods of, 13.4  
 steps in, 13.6  
 phosphorothioate incorporation, 13.86–13.87  
 random mutations using spiked primers, 13.80  
 selection of mutants with *DpnI*, 13.19–13.25, 13.84–13.85  
 of single-stranded DNA, 13.15–13.18  
 troubleshooting, 13.18  
 uracil-substituted DNA preparation, 13.11–13.14
- USE mutagenesis, 13.26–13.30, 13.85
- Oligonucleotide primers. *See also* Oligonucleotide-directed mutagenesis  
 cDNA probe construction  
 oligo(dT) primer, 9.42–9.43, 9.47  
 random primers, 9.39–9.40, 9.48–9.49  
 for cDNA synthesis, 11.12–11.15, 11.39  
 oligo(dT), 11.12–11.13, 11.15  
 random, 11.12–11.15  
 second-strand, 11.17–11.20  
 commonly used (Table A6-12), A6.11  
 converting molarities to units of weight, 12.103

- Oligonucleotide primers (*continued*)  
 design, computer program for, 13.83  
 for DNA sequencing, 12.6–12.7, 12.27–12.28, 12.35, 12.41–12.42, 12.48–12.49, 12.52–12.55, 12.60  
 dye primers, 12.96  
 energy transfer (ET) primers, 12.96  
 stock solution preparation, 12.103  
 in exon trapping/amplification protocol, 11.90–11.93, 11.96  
 gel purification, need for, 12.103  
 molecular-weight calculation, formula for, 8.20, 8.50  
 oligonucleotide-directed mutagenesis, 13.4, 13.6–13.10, 13.16–13.17, 13.19–13.20, 13.26–13.30  
 in PCR, 8.4–8.5, 8.18  
 3'-RACE, 8.61–8.65  
 5'-RACE, 8.54–8.60  
 annealing conditions, 8.8–8.9  
 concentration of, 8.5  
 degenerate pools, 8.66–8.71, 8.113  
 design, 8.13–8.16  
 differential display-PCR, 8.96, 8.99–8.101, 8.103, 8.105  
 extension of primers, 8.9  
 guessmers, 8.66–8.67  
 inosine use in degenerate pools, 8.113  
 inverse PCR, 8.81–8.85  
 ligation-independent cloning, 11.121–11.124  
 linker-scanning mutagenesis, 13.76–13.77  
 long PCR, 8.79  
 MOPAC, 8.66–8.71  
 multiplex PCR, 8.5, 8.107  
 purification of, 8.5, 8.18  
 quantitative PCR, 8.90–8.92  
 restriction site addition to 5' termini, 8.31, 8.37–8.39  
 universal, 8.113–8.117  
 PCR-mediated mutagenesis, 13.31–13.34, 13.36–13.39  
 in primer extension assays, 7.75–7.76, 7.78–7.79  
 promoters of RNA polymerases, adding to DNA fragments, 9.37  
 purification, 7.76  
 in radiolabeled probe production  
 PCR, 9.15–9.18  
 random priming, 9.5–9.7, 9.10  
 single-stranded probes from M13, 9.19–9.22, 9.26  
 removal by ultrafiltration, 8.27–8.29  
 for reverse transcriptase use, A4.25–A4.26  
 for RT-PCR, 8.46–8.48  
 oligo(dT), 8.46–8.48  
 random hexamers, 8.47–8.48  
 spiked, 13.80  
 universal primers, 8.113–8.117  
 for  $\lambda$ gt10/ $\lambda$ gt11, 8.116  
 for M13 vectors, 8.115  
 for pBR322, 8.114  
 for pUC vectors, 8.115  
 transcription promoter primers, 8.117
- Oligonucleotide probes, 10.1–10.49  
 biotin labeling, 11.117  
 cDNA screening with, 11.31–11.32  
 degenerate pools, 11.31  
 guessmers, 11.31  
 universal bases, 11.32  
 in competition assays, 17.17  
 degenerate pools, 10.5–10.6  
 extinction coefficient, calculating, 10.13–10.14  
 guessmers, 10.6–10.9  
 design, 10.7  
 hybridization conditions, 10.8  
 melting temperature, 10.8  
 mixtures of, 10.7–10.8  
 PCR compared, 10.9  
 labeling with Klenow fragment, 10.30–10.34  
 length of, 10.4–10.5  
 melting temperatures, 10.2–10.4, 10.6, 10.8, 10.47–10.48  
 empirical measurement, 10.38–10.41  
 double-stranded DNA, 10.40–10.41  
 single-stranded DNA, 10.40  
 in TMACI buffers, 10.36  
 phosphorylation of 5' termini, 10.17–10.19  
 efficiency of transfer, measuring, 10.19  
 materials, 10.17–10.18  
 protocol, 10.18–10.19  
 purification  
 chromatography, 10.49  
 HPLC, 10.49  
 polyacrylamide gel electrophoresis, 10.11–10.16  
 detection in gels, 10.16  
 eluting DNA, 10.15  
 materials, 10.12–10.13  
 protocol, 10.13–10.16  
 Sep-Pak C<sub>18</sub>, 10.15–10.16  
 by polyacrylamide gel electrophoresis, 10.48–10.49  
 resolution, 10.14, 10.33, 10.49  
 precipitation with CPB, 10.22–10.24  
 precipitation with ethanol, 10.20–10.21  
 purification cartridges, 10.49  
 reversed-phase chromatography, 10.11, 10.15–10.16, 10.49  
 Sep-Pak C<sub>18</sub> chromatography, 10.28–10.29  
 size-exclusion chromatography, 10.25–10.27  
 of tritylated, 10.49  
 quantifying by OD, 10.13  
 quaternary alkylammonium salts, 10.6, 10.35–10.37  
 screening expression libraries, 14.2, 14.31–14.36  
 synthesis, 10.1, 10.42–10.46  
 monitoring, 10.42  
 phosphodiester method, 10.42  
 phosphoramidite chemistry, 10.42  
 protecting groups, table of, 10.43  
 steps involved, diagrams of, 10.44–10.45  
 yield estimates, table of, 10.46  
 universal bases, 10.9–10.10  
 uses for, 10.2
- Oligonucleotides. *See also* Adaptors; Linkers; Oligonucleotide primers; Oligonucleotide probes; Oligonucleotide-directed mutagenesis  
 molecular conversions for (Table A6-13), A6.11  
 purification from polyacrylamide gels by crush and soak method, 5.51  
 spectrophotometry, A8.20, A8.21
- OMPF protein, 17.53  
*ompT* mutation, 15.19  
 1089 *E. coli* strain, fusion protein preparation in, 14.41
- ONPG (*o*-nitrophenyl- $\beta$ -D-galactopyranoside), 17.50–17.51, 17.97–17.98
- OOTFD (Object-Oriented Transcription Factor Database), A11.20
- O*-phenylenediamine dihydrochloride (OPD), A9.35
- Oregon Green, 8.94–8.95, 18.80, 18.90, A9.33
- oriC*, 13.88, A4.3
- Origin of replication, 1.3, 1.4. *See also* Replicons  
*dam* methylation and, 13.88  
*f1*, 17.35, 17.49  
 locating by linker-scanning mutagenesis, 13.75  
*oriC*, 13.88, A4.3  
 in p $\beta$ -gal vectors, 17.49  
 in pCAT3 vectors, 17.35  
 polyomavirus, 11.69  
 from single-stranded bacteriophages, 1.11  
 SV40, 11.69, 11.114, 17.49  
 yeast artificial chromosome, 4.2
- Origin of transfer (*oriT*), 1.146
- oriS* in BACs, 4.48
- Osmium tetroxide, 13.91, 13.95
- Osmotic shock for release of proteins from periplasmic space, 15.40, 15.43
- Ovens, hybridization, 6.51
- Overhangs, DNA. *See* Protruding termini
- Overlap extension mutagenesis, 13.8, 13.36–13.39
- <sup>32</sup>P  
 chemiluminescence compared, A9.16  
 decay data, A9.15  
 in far western screens, 18.48  
 particle spectra, A9.9–A9.10  
 sensitivity of autoradiographic methods for detection, A9.13
- <sup>33</sup>P  
 decay data, A9.15  
 particle spectra, A9.9–A9.10  
 sensitivity of autoradiographic methods for detection, A9.13
- P1 artificial chromosomes (PACs), 4.4  
 advantages/disadvantages, 4.40  
 choosing for genomic library construction, 4.7–4.10  
 4.10  
 DNA purification, 4.42–4.45  
 Human PAC Library, 4.9  
 overview, 4.40  
 vectors, A3.5
- P1 bacteriophage  
 Cre-*loxP* system, 4.82–4.83  
 history of, 4.35  
 life cycle of, 4.36
- P1 bacteriophage vectors, 4.35–4.47, A3.5  
 advantages/disadvantages, 4.40  
 amplification, 4.36, 4.42  
 arrayed libraries, 4.8  
 cloning into vectors, 4.37–4.39  
 design of vectors, 4.35–4.37  
 DNA preparation/purification, 4.42–4.45  
 by chromatography, 4.45  
 by drop dialysis, 4.44  
 protocol, 4.42–4.43  
 electroporation, 4.46–4.47  
 genomic libraries  
 arrayed, 4.39  
 choosing for construction of, 4.7–4.10  
 screening, 4.39–4.40  
 overview, 4.4  
 packaging, 4.7, 4.37, 4.82  
 transduction, 4.46
- P2 prophage, restriction of  $\lambda$  growth, 2.20
- P3 buffer (Qiagen), A1.21
- p15A replicon, 1.4
- p53 GeneChip array, 10.9
- P450 GeneChip array, A10.9
- PAC. *See* P1 artificial chromosomes (PACs)
- pacA* gene, 4.37
- PacI*  
 cleavage at end of DNA fragments, A6.4  
 fragment size created by, table of, A4.8  
 genomic DNA mapping, 5.68–5.69  
 site frequency in human genome, 4.16, A6.3
- Packaging  
 cosmids, 4.21–4.22, 4.30  
 in vitro packaging, 2.111, 11.113–11.114  
 $\lambda$  vectors, 2.63, 2.65, 2.67, 2.84–2.89, 2.110–2.111  
 P1 bacteriophage vectors, 4.7, 4.37, 4.82
- Packard MultiPROBE II, A10.5
- pACYC, 1.1.4, A3.2
- pAd10*sacBII*, 4.4, A3.5  
 concentration of doubled-stranded DNA in solution, A6.5  
 features of, 4.37–4.38  
 library generation in, 4.38



- PAC vector derived from, 4.40  
 PAGE. *See* Polyacrylamide gel electrophoresis  
 Pak1 kinase, 18.13  
 Pam3, A7.5  
 p-aminophenyl- $\beta$ -D-thio-galactoside (APTG) (TPEG), 15.6, 15.58, 17.97  
 pAMP), 11.122–11.123  
 pAMP10, 11.122  
 Pancreatic DNase I. *See* DNase I  
 Pancreatic RNase. *See* RNase  
 Panning, 11.68–11.69  
 Papain, 18.80–18.81  
 par. 1.8, 1.13, 1.146, 4.2, 4.37  
 parA in bacterial artificial chromosome, 4.2–4.3, 4.48  
 Paraffin blocks, DNA extraction from, 6.27  
 Paraformaldehyde (4%) fixative solution, 18.87  
 Paramagnetic beads, 9.91, 11.98–11.99, 11.103  
 parB in bacterial artificial chromosome, 4.2–4.3, 4.48  
 parC in bacterial artificial chromosome, 4.2–4.3  
 Partek Pro 2000 image analysis program, A10.13  
 Partitioning. *See also par*  
   in BACs, 4.48  
   low-copy-number plasmids, 1.13  
 pAS1, 15.4, 15.25  
 pAT53, 1.9  
 Pathways analysis software package, A10.9  
 pAX vectors for LacZ fusion protein expression, 15.59  
 pB6B15.23, 11.109  
 pB42AD, 18.20, A3.4  
 pBAce, 15.5, 15.32  
 pBAce3.6, 4.9  
 pBC KS +/-, A3.2  
 pBeloBACII, 4.3, A3.5, A6.5  
 p $\beta$ -gal vectors, 3.15, 17.49, A3.3  
 pBK-CMV, 11.24, A3.3  
 pBluescript vectors, 1.11, 11.92, 11.94, A3.2  
    $\beta$ -galactosidase gene, 1.27  
   in commercial kits for cDNA synthesis, 11.108  
   in exon trapping protocol, 11.89, 11.92, 11.94  
   for fusion protein construction, 15.5  
   KS (+/-), 3.15, 3.42, 3.44  
   for LacZ fusion protein expression, 15.59  
   in ribonuclease protection assay protocol, 7.69  
   SK (+/-), 3.15, 3.42, 3.44  
   SK (-) phagemid in  $\lambda$ ZAP11, 11.23  
   in USE mutagenesis, 13.30  
 pBR313, 1.9, A3.2  
 pBR322, 1.9–1.10, A3.2  
   cDNA cloning, 11.19  
   concentration of doubled-stranded DNA in solution, A6.5  
   electroporation of, 1.26  
   mobilization, 1.146  
   overview, 1.146  
   plasmid growth and replication, 1.17  
   primers for cloning sites in, 8.114  
   replicon in, 1.14  
 pBR327, A3.2  
 pBS. *See* pBluescript vectors  
 pCANTAB 5, 18.120  
 pCAT3 vectors, 17.35, A3.3  
 pcDNA3.1, 11.25, 11.30, 11.63, 11.72, A3.3  
 pcDNA4, 11.72  
 pCGB42/p2GB42, 18.20  
 pCGLex/p2GLex, 18.19  
 pCI-Neo, 17.61, 17.66  
 pCMV vectors, A3.3  
   pCMV-Script, 11.25, 11.29, 11.63, 11.72, A3.3  
   pCMV-SPORT in commercial kits for cDNA synthesis, 11.108  
   pCMV-SPORT- $\beta$ -gal, 16.10, A3.4  
 pcnB gene, 1.13  
 pCOMB3H, 18.118  
 pCOMB8, 18.118  
 pCQV2, 15.25  
 PCR. *See* Polymerase chain reaction  
 PCR lysis solution, 6.22  
 PCR Primer Design program, 13.89  
 pCR2.1, 3.15  
 pCR1000, A3.2  
 pCRII, 8.35  
 pCR-ScriptSK(+), 1.100, 8.35  
 pCYPAC1, 4.5, 4.9, A3.5  
   concentration of doubled-stranded DNA in solution, A6.5  
   human genomic library, 4.39  
 pd2EGFP vectors, 17.88, A3.4  
 PDB (Protein Data Bank), A11.23  
 pDisplay, 18.120  
 pDisplay Expression Vector, 18.120  
 PE1 buffer, 13.15  
 PE2 buffer, 13.15  
 Pefabloc, 15.41, A5.1  
 PEG. *See* Polyethylene glycol  
 pEG202, 18.19, 18.24, A3.4  
 pEG202L, 18.19  
 pEGFP-F, 16.10  
 pEMBI, 3.42–3.43  
 1,10-Pentanthroline-copper, 17.76–17.77  
 Penicillins, 1.148, A2.7  
 Pepstatin, 15.19, 17.25, A5.1  
 Peptide aptamers, 18.8  
 Peptides  
   antibodies against, A9.30–A9.33  
   coupling to carriers, A9.32  
   libraries, 18.116–18.121  
   constrained, 18.120–18.121  
   construction of, 18.117–18.119  
   random, 18.116–18.117  
   phage display of, 18.116–18.121  
 Peptidoglycan, 1.148  
*Peptostreptococcus magnus*, A9.49  
 Perchloric acid, A1.6, A8.10  
 PerFect Lipid Transfection Kit, 16.5, 16.7  
 Perfect Match, 4.81, 8.9  
 PerfectPrep, 1.64, 12.27  
 Periodic Table of Elements, A1.29  
 Periplasmic space  
   export of foreign proteins to, 15.30, 15.34–15.35  
   export of maltose-binding fusion proteins to, 15.40, 15.43  
   release of fusion proteins by osmotic shock, 15.40, 15.43  
 Peroxidase. *See* Horseradish peroxidase  
 Peroxisome, 17.96  
 pET vectors, 1.12, 15.3, 15.5, 15.20–15.24, A3.2  
 pET-3 vector, 15.20–15.21  
 pEX vectors  
   expression libraries, 14.14  
   for LacZ fusion protein expression, 15.59  
 Pfam program, A11.16–A11.17  
 PFGE. *See* Pulsed-field gel electrophoresis  
 pFliTrx, 18.120  
 PfScan (ProfileScan) program, A11.16  
 Pfu DNA polymerase, 8.7, 8.11, 8.30, 8.77–8.78, 8.85  
   3'-5' exonuclease activity, 8.30, 8.35  
   in circular mutagenesis, 13.20–13.23  
   in overlap extension method of mutagenesis, 13.37  
   polishing cDNA termini, 11.43  
   properties, table of, A4.23  
 pGEM vectors, 1.11, A3.2  
    $\beta$ -galactosidase gene, 1.27  
   for fusion protein construction, 15.5  
 pGEM-3Z, 15.14, A3.2  
 pGEM-11Zf(-), A9.23  
 pGEM\_luc, A9.23  
 pGEM-T, 8.35, A3.2  
 pGEMZ for LacZ fusion protein expression, 15.59  
 pGEMZF, 3.42, 3.44, A3.2  
   in ribonuclease protection assay protocol, 7.69  
 P gene,  $\lambda$ , 2.6, 2.8–2.9, 2.11  
 pGEX vectors, 15.43, A3.2  
   for fusion protein construction, 15.5  
 pGEX-1, 15.15  
 pGEX2T, 15.8  
 pGEX3X, 15.8  
 pGilda, 18.19–18.20, 18.27, A3.4  
 pGL vectors, 17.96  
 pGL2, 3.15  
 pGL3, 17.43, A3.4  
 pNG1, 18.12  
 Phage display, 18.3  
 Phage Display System/Service, 18.120  
 Phagefinder Immunoscreening Kit, 14.25  
 Phagemid display system, 18.115–18.116  
 Phagemids, 1.11  
   advantages of, 3.43  
   DNA preparation, single-stranded, 3.42–3.49  
   growth time and, 3.49  
   materials, 3.45–3.46  
   protocol method, 3.46–3.48  
   yield estimation by gel electrophoresis, 3.48  
 helper viruses, 3.42–3.47  
   preparation of high-titer stock, 3.46  
   protocol for superinfection, 3.47  
 M13, 3.3, 3.5  
 nested deletion mutant set creating, 13.57, 13.59–13.61  
 oligonucleotide-directed mutagenesis, 13.18  
 replication, 3.43  
 screening for site-directed mutagenesis by hybridization to radiolabeled probes, 13.47  
 table of, 3.42  
 uracil-substituted single-stranded DNA, preparation of, 13.12–13.13  
 uses for, 3.43  
 Phagescript SK, A3.5  
 Phase-Lock Gel, 3.28  
 Ph.D. Phage Display Peptide Library Kits, 18.120  
 Phenol, A1.23  
   in DNA isolation from mammalian cells, 6.5, 6.9–6.10, 6.22  
   equilibration of, A1.23  
   inhibition of PCR by, 8.13  
 pH, 6.5  
 spectrophotometry of DNA contaminated with, 6.11, 6.15  
 Phenol:chloroform extraction  
   of agarase, 5.85  
   in DEAE-cellulose membrane recovery of DNA, 5.22  
   in dephosphorylation procedures, 1.96  
   in DNA recovery from polyacrylamide gels, 5.53  
   of DNase contaminants, 1.42  
   in DNase I footprinting protocol, 17.10  
   in DNase I hypersensitivity mapping protocol, 17.21  
   ethidium bromide removal from DNA preps, 1.74, 1.77  
   in hydroxyl radical footprinting protocol, 17.12  
   in  $\lambda$  DNA preparation, 2.58, 2.70  
   of ligated DNA, 1.102  
 M13 RF DNA purification, 3.25  
   of nuclease S1 digestion reactions, 7.61  
   in oligonucleotide purification, 10.27  
   overview of procedure, A8.9–A8.10  
   in PCR products, purification protocol, 8.26  
 plasmid DNA protocols  
   alkaline lysis with SDS, 1.34, 1.37, 1.42  
   boiling lysis, 1.46  
   lysis with SDS, 1.57

- Phenol:chloroform extraction (*continued*)  
 in polyethylene glycol DNA purification procedure, 1.59, 1.61  
 in primer extension assay protocol, 7.80  
 in RNA purification, 7.4  
 for RNase removal, 9.33  
 in yeast DNA purification protocols, 4.68–4.69
- Phenol:chloroform:isoamyl alcohol extraction, A1.23, A8.10  
 in genomic DNA isolation from mouse tails, 6.25, 6.27  
 in transcriptional run-on assay protocol, 17.28
- Phenol extraction  
 in bacteriophage DNA isolation, 12.23  
 in  $\lambda$  DNA preparation, 2.58  
 in M13 DNA preparation, 3.28  
 silicone lubricant for phase separation, 3.28
- Phenylalanine  
 for affinity purification of fusion proteins, 15.6  
 codon usage, A7.3  
 nomenclature, A7.7  
 properties, table of, A7.9
- Phenylmethylsulfonyl fluoride (PMSF), 5.62, 5.78, 14.44, 14.46, 15.41–15.42, 15.52, A5.1  
 in cell/tissue homogenization buffer, 17.4, 17.25  
 in cell/tissue resuspension buffer, 17.6  
 as protease inhibitor, 15.19
- Phenyl-Superose, 15.6
- PHI-BLAST (Position Hit Initiated BLAST) program, A11.18
- oX174 bacteriophage, 1.12, 3.8, A3.3  
 oligonucleotide-directed mutagenesis and, 13.6  
 sequencing of, 12.4  
 shotgun sequencing protocol, 12.10–12.22
- phoA*. See Alkaline phosphatase promoter
- phoR*, 15.32
- Phosphatase. See Alkaline phosphatase
- Phosphate buffers, A1.5
- Phosphate buffers, Gomori, A1.5
- Phosphate-buffered saline (PBS), A1.7
- Phosphate-SDS washing solution, 6.51–6.52
- Phosphatidylethanolamine (DOPE), 16.5, 16.7–16.8, 16.50
- Phosphoric acid, A1.6
- Phosphorothioate analogs, 13.86–13.87
- Phosphorylation. See also Polynucleotide kinase, bacteriophage T4  
 of 5 termini, 10.17–10.19  
 blunt/recessed, 9.70–9.72  
 protruding, 9.66–9.67, 9.73–9.75  
 of adaptors, 1.88–1.89, 11.55  
 by exchange reaction, 9.73–9.75  
 imaging protein phosphorylation with FLIM-FRET, 18.78  
 imidazole buffers and, 9.73–9.74  
 of linkers, 1.99, 1.101, 11.55  
 of oligonucleotide probes, 7.78  
 polyethylene glycol enhancement of, 9.70–9.71  
 radiolabeling oligonucleotides, 13.42–13.43  
 in shotgun sequencing protocol, 12.18  
 of Thr-250, 18.78, 18.80, 18.88, 18.93–18.94  
 of tyrosine, 14.2
- Phosphotyrosine residues, antibodies specific for, 14.2
- Photinus pyralis*, 17.96, A9.21
- Photobiotin, 9.78, 11.116
- Photobleaching, 18.73, 18.92
- Photography of DNA in gels, 5.16–5.17  
 CCD (charged couple device) imaging systems, 5.15–5.16  
 Polaroid, 5.15–5.17  
 polyacrylamide gels, 5.48
- Photolabeling, 9.78
- Photolithography, A10.8
- pHCB vectors, 15.4, 15.25
- pHvbLex/Zeo, 18.19
- picoBlue Immunoscreening Kit, 14.25
- Piezoelectric printing of microarrays, A10.16
- Pili, F, 4.49
- PIMA (Pattern-induced Multiple Alignment) program, A11.6–A11.7
- pIND(SP1)/V5-His A, 17.72, A3.4
- Piperidine  
 in chemical sequencing protocols, 12.61–12.65, 12.67, 12.71  
 rapid methods, 12.71  
 removal of, 12.62, 12.66  
 cleavage of CDI-modified bases, 13.95
- PIPES (piperazine-1,4-bis[2-ethanesulfonic acid]), 7.28  
 in nuclease S1 mapping of RNA, 7.56  
 in ribonuclease protection assay protocols, 7.67
- Pipetting devices, automatic  
 in PCR protocols, 8.19  
 as RNase source, 7.82
- pJB8, 4.13, A3.5
- pJG-4, A3.4
- pJG4-5, 18.20, 18.30, 18.43
- pJG4-5I, 18.20
- pJK101, 18.12, 18.23, 18.25, A3.5
- pJK103, 18.12
- pJK202, 18.19, 18.27
- PK buffer, 18.51, 18.52
- pKC30, 15.4, 15.25
- pKK223-3, 15.3, 15.15
- pKN402 replicon, 1.4
- PLACE (plant *cis*-acting regulatory elements) database, A11.20
- Placental RNase inhibitor, 8.49
- PLALIGN program, A11.4
- PlantCARE (plant *cis*-acting regulatory elements) database, A11.20
- Plaques, viral  
 $\lambda$  bacteriophage  
 $\beta$ -galactosidase screening, 2.30  
 macroplaques, 2.31  
 plating protocols, 2.25–2.31  
 size, 2.30  
 smearing, 2.30  
 M13 bacteriophage, 3.17  
 picking, 3.22  
 type, 3.2, 3.17  
 overview of, 2.25  
 purification, 13.45
- Plasmid DNA  
 dephosphorylation, 1.93–1.97  
 electroporation of *E. coli* and, 1.119–1.122  
 ligation in low-melting-temperature agarose, 1.103–1.104  
 linker addition to blunt-ended DNA, 1.98–1.102  
 preparation  
 alkaline lysis with SDS, 1.19  
 maxipreparation protocol, 1.38–1.41  
 midipreparation protocol, 1.35–1.37  
 minipreparation protocol, 1.32–1.34  
 overview, 1.31  
 troubleshooting, 1.41, 1.42  
 yield, 1.41  
 boiling lysis  
 large-scale, 1.47–1.50  
 overview, 1.43  
 small-scale, 1.44–1.46  
 yield, 1.50  
 for DNA sequencing templates, 12.26–12.31  
 denaturation, 12.26–12.30  
 PEG precipitation, 12.31  
 purification, 1.18–1.19  
 chromatography, 1.62–1.64  
 commercial resins, table of, 1.64  
 Sephacryl S-1000 columns, 1.80–1.81  
 size limitations, 1.63  
 CsCl removal, 1.73–1.75
- CsCl-ethidium bromide gradients, 1.18  
 contamination by DNA/RNA fragments, 1.65  
 continuous gradients, 1.65–1.68  
 discontinuous gradients, 1.69–1.78  
 DNA collection from, 1.67–1.68, 1.71  
 rebanding, 1.68  
 ethidium bromide removal  
 extraction with organic solvents, 1.72–1.74  
 ion-exchange chromatography, 1.75–1.77  
 kits, 1.19  
 low-melting-temperature agarose, 5.7  
 nucleic acid fragment removal  
 centrifugation through NaCl, 1.78–1.79  
 chromatography, 1.80–1.81  
 precipitation with LiCl, 1.82–1.83  
 precipitation with PEG, 1.19, 1.59–1.61, 1.152, 12.31  
 steps, 1.16–1.19  
 growth of bacterial culture, 1.16  
 harvesting and lysis of culture, 1.16–1.18  
 purification, 1.18–1.19  
 receiving in the laboratory, 1.29  
 transfection of eukaryotic cells, calcium-phosphate-mediated, 16.14–16.20  
 high efficiency, 16.20  
 materials for, 16.15–16.16  
 method, 16.16–16.19  
 variables affecting, 16.20  
 transformation. See Transformation
- Plasmids. See also Plasmid DNA; Plasmid vectors  
 amplification, 1.4, 1.13, 1.39, 1.48, 1.56, 1.128, 1.131, 1.143  
 copy number, 1.3–1.4, 1.6–1.9  
 chloramphenicol amplification, 1.4, 1.39, 1.48, 1.56, 1.128, 1.131, 1.143  
*E. coli* strains-related suppression, 1.15  
 low-copy-number vectors, 1.12–1.13  
 suppression by *pcnB*, 1.13  
 incompatibility, 1.7–1.8  
 mobilization, 1.146  
 overview, 1.2–1.3  
 partitioning, 1.146  
 replication, 1.4–1.7  
 diagram of, 1.5  
 incompatibility of plasmids, 1.7–1.8  
 initiation of DNA synthesis, 1.5–1.6  
 inverted repeat lethality, 1.15  
 regulation by RNAI, 1.6–1.7  
 relaxed, 1.4, 1.17  
 runaway, 1.13  
 stringent, 1.4, 1.17  
 replicons, 1.3–1.4, 1.17. See also Replicons  
 size, 1.9  
 stability regions, 1.146
- Plasmid vectors  
 adaptor attachment to protruding termini, 1.88–1.89  
 with bacteriophage origin of replication, 1.11  
 with bacteriophage promoters, 1.11–1.12  
 blunt-ended cloning, 1.90–1.92  
 cDNA library construction, 11.63  
 directional cloning, 1.84–1.87  
 eukaryotic expression libraries, 11.72–11.73, 11.76–11.77  
 expression libraries, screening, 14.14–14.22, 14.47–14.49  
 chemiluminescent screening, 14.21–14.22  
 chromogenic screening, 14.20–14.21  
 master plate/filter preparation, 14.17  
 materials for, 14.15–14.17  
 processing filters, 14.18  
 protein expressing clones, 14.19–14.22  
 radiochemical screening, 14.19  
 replica filter preparation, 14.17–14.18  
 validation of clones, 14.22

- vector choice, 14.14
- expression vectors, 1.13–1.14
- finding appropriate, 1.14–1.16
- history of
  - 1973–1978, 1.9
  - 1978–1983, 1.9–1.10
  - 1983–present, 1.11–1.14
- immunological screening of libraries in, 14.2
- in vitro mutagenesis, 13.19–13.25
- for in vitro transcription, 9.29–9.31
- low-copy-number, 1.12–1.13
- nested deletion mutant set creating, 13.57, 13.59–13.61
- positive selection, 1.12
- runaway replication, 1.13
- selectable markers, 1.8–1.9
- table of, A3.2–A3.3
- USE mutagenesis, 13.26–13.30
- Plasmoon, 18.96
- Plasticware, preparation of, A8.3
- Platinum *Taq* Polymerase, 8.110
- pLexAop-lucU, 18.12
- Plus and minus sequencing technique, 12.4
- Plus/minus screening, 9.89–9.90
- pLysE, 15.21, 15.24
- pLysS, 15.21, 15.24
- PM2, bacteriophage, 13.71–13.72
- pMAL vectors, 15.15, A3.2
  - for fusion protein construction, 15.5
  - pMAL2, 15.7
  - pMAL-c2, 15.8, 15.40
  - pMAL-p2, 15.8, 15.40
- pMB1, A3.2
  - plasmid growth and replication, table of, 1.17
  - replicon, 1.3–1.4
- pMC9, 11.62, 11.66, 14.6, 14.47
- pMC128, 1.15
- PmeI*
  - cleavage at end of DNA fragments, A6.4
  - fragment size created by, table of, A4.8
  - genomic DNA mapping, 5.68–5.69
  - site frequency in human genome, 4.16, A6.3
- pMEX, 15.15
- pMOB45, 1.1.4, A3.2
- pMR100 for LacZ fusion protein expression, 15.59
- PMSF. *See* Phenylmethylsulfonyl fluoride
- pMW101–104, 18.19–18.20, 18.23–18.24
- pMW107–110, 18.12
- pMW111, 18.12, A3.5
- pMW112, 18.12, 18.23–18.25, 18.29, 18.44, A3.5
- pNB42 series, 18.20
- pNlexA, 18.19
- Point mutation detection by ligase amplification reaction, 1.157, 1.159
- Point-sink system of shearing DNA, A8.35
- polA* gene, *E. coli*, 9.82
- Pol I. *See* DNA polymerase, *E. coli* DNA polymerase I
- Pol3scan program, A11.14
- Polishing ends
  - of amplified DNA, 8.30, 8.32–8.34
  - in DNA sequencing protocols, 12.17
  - with Klenow, 12.17
  - with T4 DNA polymerase, 12.17
- Poly(A) polymerase, 1.13, 9.56
- Poly(A) RNA
  - cDNA library construction, 11.39
  - cDNA probe generation from, 9.38–9.40, 9.43, 9.48
  - in hybridization solutions, 6.51–6.52
  - integrity, checking, 11.39, 11.42
  - in northern hybridization, 7.45
  - in primer extension assays, 7.76
  - selection
    - by batch chromatography, 7.18–7.19
    - by oligo(dT)-cellulose chromatography, 7.13–7.17
  - on poly(U)-coated filters, 7.20
  - by poly(U)-Sepharose chromatography, 7.20
  - by streptavidin-coated beads, 7.20
  - in Southern hybridization, 6.56
- Polyacrylamide
  - chemical structure of, A8.41
  - cross-linking, 5.41–5.42
  - structure of, 5.41
- Polyacrylamide gel electrophoresis. *See also* SDS-polyacrylamide gel electrophoresis of proteins
  - agarose gels compared, 5.2, 5.40
  - analysis of protein expression in transfected cells, 17.69
  - band-stab PCR of samples from gel, 8.71
  - caging, 17.13
  - in coimmunoprecipitation protocol, 18.61, 18.65, 18.68
  - denaturing, 5.40
  - DGGE (denaturing gradient gel electrophoresis), 13.91–13.92
  - DNA detection
    - autoradiography, 5.49–5.50
    - silver staining, 5.77
    - staining, 5.47–5.48
  - DNA fragment size resolution, percentage gel for, 7.56
  - DNA recovery
    - by crush and soak method, 5.51–5.54
    - by electroelution into dialysis bags, 5.23–5.25
  - DNA sequencing, 12.66–12.69, 12.74–12.93
    - autoradiography, 12.90–12.93
    - compression of bands, troubleshooting, 12.83, 12.109–12.110
    - loading, 12.88
      - base order, 12.88
      - loading devices, 12.88
    - marker dye migration rate, 12.89
    - preparation of, 12.74–12.84
      - air bubbles, 12.79
      - electrolyte gradient gels, 12.83–12.84
      - formamide containing, 12.81–12.82
      - glass plates, 12.76–12.78
      - leaking gels, 12.80
      - materials for, 12.74–12.75
      - pouring gels, 12.78–12.80
    - reading, 12.90–12.93
    - resolution of, 12.85
    - running, 12.85–12.89
    - safety precautions, 12.86
    - temperature-monitoring strips, 12.86
    - troubleshooting band pattern aberrations, 12.67–12.69, 12.82
    - wedge gels, 12.83
  - in DNase I footprinting protocol, 17.5, 17.10
  - DNA size selection in shotgun sequencing protocol, 12.18
  - drying gels, 5.50, 12.92
  - far western analysis of protein-protein interactions, 18.49–18.50
  - fixing gels, 5.49–5.50, 12.90–12.92
  - formamide in sequencing gels, 6.59
  - gel retardation assays, 17.13–17.17, 17.80
  - gel-loading buffers, 5.42
  - glass plates for, 12.76
  - in GST fusion protein pulldown technique, 18.55, 18.56, 18.59
  - glycerol and, 13.90
  - IEF and, 18.61
  - markers
    - migration rate of dyes, 7.57, 12.89
    - radiolabeled size, 9.54
  - method, nondenaturing, 5.44, 5.46
  - apparatus assembly, 5.44
  - bubbles, removal of, 5.45
  - casting gel, 5.45
  - de-aeration of acrylamide solution, 5.44
  - loading samples, 5.46
  - storage of gels, 5.45
  - nondenaturing, 5.40–5.46
  - in nuclease S1 mapping of RNA, 7.56–7.59
  - oligonucleotide purification, 10.11–10.16, 10.48
  - detection in gels, 10.16
  - eluting DNA, 10.15
  - materials for, 10.12–10.13
  - protocol, 10.13–10.16
  - in primer extension assay protocol, 7.77, 7.80–7.81
  - for protein separation, 15.17, 15.24, 15.29, 15.33
  - resolution, 5.40, 5.42
  - in ribonuclease protection assay
    - analysis of RNase-resistant hybrids, 7.73–7.74
    - purification of riboprobes, 7.71–7.72
    - size standards, 7.73–7.74
  - RNA purification, 9.35
  - silver staining DNA, A9.6–A9.7
  - single-strand conformation polymorphism and, 13.51, 13.54–13.55
  - spacers for, 12.76
  - tape, gel-sealing, 12.76, 12.78
  - temperature-monitoring strips, 5.43, 5.46
  - western blotting and, A9.28
- polyadq program, A11.14
- Polybrene, DNA transfection using, 16.3, 16.43–16.46
- Polycloning sites, 1.10
- Poly(dI-dC), 17.14–17.15
- Polyethylene glycol (PEG)
  - DNA purification, 12.31
  - $\lambda$  particles, precipitation of, 2.43–2.44
  - in ligation reactions, 1.152, 1.154
  - for M13 concentration, 3.26–3.28
  - PEG 8000, A1.28
    - as crowding agent, 1.23
    - phosphorylation reaction enhancement, 9.70–9.71
    - in shotgun sequencing protocol, 12.18
    - in virus particle precipitation, 12.23
  - PEG-MgCl<sub>2</sub> solution, A1.21
  - plasmid DNA purification by PEG precipitation, 1.19, 1.152, 1.159–1.161
  - in protoplast fusion, 1.154
  - structure of, 1.154, 3.49
  - uses of, overview, 1.154, 3.49
- Polyethylene imine for facilitation of DEAE transfection, 16.28
- Polyhedral inclusion bodies (PIBs), 17.81
- Polyhistidine-tagged proteins. *See* Histidine-tagged proteins
- Polylinkers in vectors. *See* Linkers; *specific vectors*
- Poly-L-lysine, 18.85, A10.5
- Polymerase, DNA. *See* DNA polymerase
- Polymerase chain reaction (PCR)
  - amplification of specific alleles, 13.48
  - analysis of
    - $\lambda$  recombinants, 2.33, 2.105
    - products, 8.44, 8.52, 8.58, 8.60, 8.65, 8.70–8.71, 8.75, 8.80, 8.85, 8.92–8.93
    - yeast colonies, 4.72–4.73
- Band-stab, 8.71
- cDNA amplification
  - of 3' ends, 8.61–8.65
    - amplification, 8.64–8.65
    - materials for, 8.61–8.63
    - reverse transcription, 8.64
  - of 5' ends, 8.54–8.60
    - amplification, 8.59–8.60
    - full-length clones, yield of, 8.59
    - materials for, 8.56–8.57
    - reverse transcription, 8.57–8.58
    - tailing reaction, 8.58–8.59
  - mixed oligonucleotide-primed, 8.66–8.71

- Polymerase chain reaction (*continued*)
- analysis, 8.70–8.71
  - band-stab PCR and, 8.71
  - DNA template, 8.68–8.70
  - guessmers, 8.66–8.67
  - materials for, 8.69
  - method, 8.70–8.71
  - primer design rules, 8.67–8.68
  - variations in protocol, 8.67
  - RT-PCR, 8.46–8.53
  - cDNA characterization, rapid, 8.72–8.76
    - screening individual colonies or plaques, 8.74–8.75
      - method, 8.74–8.75
      - troubleshooting, 8.75
    - yeast colonies, 8.75
  - screening  $\lambda$  libraries, 8.76
  - cloning products
    - blunt end, 8.30–8.34
    - difficulty of, 8.30
    - end modification, 8.42–8.45
    - genetic engineering with PCR, 8.42–8.45
    - overview, 8.30–8.31
    - polishing termini, 8.30, 8.32–8.34
    - restriction site addition and, 8.31, 8.37–8.41
      - clamp sequences and, 8.38–8.39
      - diagram of procedure, 8.38
      - primer design tips, 8.37–8.38
      - problems, 8.37
      - protocol, 8.39–8.41
      - troubleshooting, 8.41
    - into T vectors, 8.31, 8.35–8.36
  - codon usage, changing, 15.12
  - components of
    - essential, 8.4–8.6
    - optional, 8.9
  - contamination in, 8.16–8.17
  - cycles, number required, 8.9, 8.12
  - detection of defined mutants, 13.48
  - diagram of amplification sequence, 8.19
  - differential display, 8.96–8.106
    - advantages of, 8.96
    - kits, 8.102
    - materials for, 8.101–8.102
    - method, 8.102–8.105
    - primers, 8.96
      - anchored, 8.99–8.100
      - arbitrary, 8.100
    - problems with, 8.96–8.99
    - schematic representation of, 8.97
    - tips for success, 8.106
  - digoxigenin labeling of nucleic acids, A9.38–A9.39
  - in direct selection of cDNA protocol, 11.98–11.100
  - DNA polymerase, thermostable, 8.4, 8.6–8.8
    - 3'-5' exonuclease activity, 8.30
    - cocktail mixtures of, 8.7, 8.77
    - inactivation, 8.25, 8.29
    - obstructions to, 8.7
    - properties and applications, table of, 8.10–8.11
    - terminal transferase activity, 8.30
  - DNA preparation for
    - mammalian, 6.3, 6.16, 6.19–6.23, 6.27–6.28
    - yeast, 6.31
  - in DNA sequencing
    - with end-labeled primers, 12.51–12.55
    - with internal labeling, 12.60
  - efficiency calculations, 8.12
  - in end-labeling for chemical sequencing of DNA, 12.73
  - GC-Melt, 4.81
  - history of, 8.2–8.4
  - hot start, 4.81, 8.110
  - inhibition of, 8.13
    - by SYBR Gold dye, A9.8
    - inosine use in, 8.113
    - interaction trap positives, rapid screen for, 18.46–18.47
    - inverse PCR, 1.157, 4.74–4.75, 8.81–8.85
      - materials for, 8.82–8.83
      - method, 8.84–8.85
      - overview of, 8.81
      - restriction enzyme choice for, 8.81, 8.84–8.85
      - schematic representation of, 8.82
      - use of, 8.81
    - Klenow use in, A4.16
    - $\lambda$  recombinant analysis, 2.33, 2.105
    - ligation-independent cloning (LIC-PCR), 11.121–11.124
    - locating by linker-scanning mutagenesis, 13.76–13.77
    - long PCR, 8.77–8.80
      - method, 8.79–8.80
      - overview of, 8.77
      - primers, 8.79
      - template DNA, 8.78–8.79
    - melting temperature calculation, 8.15–8.16
    - multiplex, 8.107
    - mutagenesis, random (misincorporation mutagenesis), 13.80
    - mutation detection techniques and, 13.91–13.96
    - Perfect-Match, adding, 4.81
    - primer elimination by exonuclease VII, 7.86
    - primers, 8.4–8.5. *See also specific applications*
      - base composition, 8.14
      - concentration of, 8.5
      - design for basic PCR, 8.13–8.16
        - computer assisted, 8.15
        - melting temperature, 8.14–8.16
        - restriction sites, adding, 8.14, 8.37–8.38
      - factors influencing efficiency, 8.14
      - length, 8.14, 8.18
      - nested, 4.81
      - purification of, 8.5
      - repetitive or random primer use, 4.75
      - selecting primers, 8.13–8.15
      - specificity, 8.13
      - universal primers, 8.113–8.117
        - for  $\lambda$ gt10/ $\lambda$ gt11, 8.116
        - for M13 vectors, 8.115
        - for pBR322, 8.114
        - for pUC vectors, 8.115
      - transcription promoter primers, 8.117
  - programming
    - annealing, 8.8–8.9
    - denaturation, 8.8
    - extension of primers, 8.9
    - number of cycles, 8.9
  - promoter for RNA polymerases, addition to
    - DNA fragments, 9.36–9.37
    - amplification conditions, 9.36
    - primer design, 9.36
  - protocol, basic, 8.18–8.24
    - bystander DNA, 8.21
    - controls, 8.21
    - materials for, 8.18–8.21
    - method, 8.21–8.22
    - optimization, 8.23
    - troubleshooting, 8.23–8.24
  - purification of products
    - for cloning, 8.25–8.26
    - methods for, 8.27
    - ultrafiltration for oligonucleotide and dNTP removal, 8.27–8.29
  - quantitative PCR, 8.86–8.95
    - amplification, 8.92
    - cDNA preparation, 8.91
    - detection and quantification of products, 8.92–8.93
    - materials for, 8.90–8.91
    - overview of, 8.86–8.89
    - real time PCR, 8.89, 8.94–8.95
    - reference template preparation, 8.91
    - references, externally added, 8.87–8.89, 8.91–8.93
    - semiquantitative methods, 8.89
    - standards, endogenous, 8.86–8.87
  - radiolabeling of DNA probes, 9.14–9.18
    - advantages of, 9.14
    - asymmetric probe production, 9.14, 9.18
    - methods used, 9.14–9.15
    - protocol for, 9.15–9.17
  - real time PCR, 8.89, 8.94–8.95
  - rescuing termini of YAC genomic inserts, 4.63
  - restriction enzyme digestion efficiency, use in monitoring, 2.66
  - RT-PCR, 8.46–8.53
    - controls/standards, 8.48–8.49, 8.51–8.52
    - enzymes, reverse transcriptase
      - inactivation of, 8.52
      - types used, 8.48
    - materials for, 8.49–8.51
    - method, 8.51–8.53
    - primers for, 8.46–8.48
    - troubleshooting, 8.53, 8.60
  - sequencing of PCR-amplified DNA, 12.106
  - single-site, 4.76–4.80
  - single-stranded radiolabeled probe production, 7.54
  - site-directed mutagenesis, 8.42–8.45, 13.7–13.10
    - megaprimer method, 13.8–13.10, 13.31–13.35
    - overlap extension, 13.8, 13.36–13.39
  - synthetic oligonucleotide cassette use, 4.76. *See also* Vectors PCR
  - TAIL, 4.75
  - temperature ramping protocol, 8.70
  - template DNA concentration, 8.6, 8.20
  - template production for in vitro transcription, 7.70
  - theory, 8.12
  - touchdown, 8.112
  - vectorette PCR, 4.74–4.81
  - in vitro mutagenesis, 13.23–13.24
- Polymerase dilution buffer, A1.9
- Poly nucleotide kinase, bacteriophage T4, A4.30, A4.35–A4.36
- 3' phosphatase activity of, 9.55
  - 5' termini, phosphorylation of blunt/recessed, 9.70–9.72
  - 5' termini, phosphorylation of oligonucleotide probe, 10.17–10.19
  - 5' termini, phosphorylation of protruding, 9.66–9.69, 9.73–9.75
  - adaptor phosphorylation, 1.88–1.89, 11.55
  - in circular mutagenesis protocol, 13.24
  - DNA purification for, A4.35
  - end concentration, A4.36
  - end labeling, 9.55
    - for DNA sequencing, 12.8, 12.73
  - exchange reaction, 9.67, 9.73–9.75
  - forward reaction, 9.67–9.72
  - inactivation, 10.19
  - inhibition by ammonium ions, 9.65, A4.35
  - linkers/adaptors for cDNA, phosphorylation of, 11.55
  - oligonucleotide probes, phosphorylation of, 7.78
  - oligonucleotide-directed mutagenesis of single-stranded DNA, phosphorylation of primers in, 13.15–13.16
  - in probe production for primer extension assay, 7.78
  - radiolabeling oligonucleotides, 13.42–13.43
  - in S1 mapping of RNA, 7.56, 7.58
- Polyomavirus origin of replication, 11.68
- Polysomes, immunological purification of, 11.10
- Poly(U)-Sephadex, 7.15, 7.20

- Polyvinylbenzylbenzyltrimethylammonium chloride, A9.19
- Polyvinylidene fluoride (PVDF), 9.78, A8.53
- Ponasterone A, 17.71–17.74
- Ponceau S, A9.28
- Positive selection, 1.12, 1.26–1.27
- Positive-displacement pipette use in PCR protocols, 8.19
- Potassium acetate solution, 6.28–6.29, A1.28
- Potassium chloride (KCl), A1.27  
in long PCR buffer, 8.78  
in PCRs, 8.6, 8.21
- Potassium ferrocyanide ( $K_4Fe(CN)_6$ )  
in histochemical stain, 16.13  
in X-GlcA solution, 16.42
- Potassium glutamate in PCR, 8.9
- Potassium hydroxide (KOH), A1.6, A1.20
- Potassium phosphate buffer, A1.5
- PowerBLAST program, A11.16
- pPCR-Script Direct, A3.2
- pPGKpuro, 17.66
- pPLC vectors, 15.4, 15.25
- PPO (2,5-diphenyloxazole) scintillant, A9.12
- pPROEX-1, 15.8
- PPSEARCH program, A11.17
- pPUR, 17.66
- pRB1840, 18.12
- Preflashing films, A9.11–A9.12
- Prehybridization solution  
for dot, slot, and northern hybridization, A1.13  
for northern hybridization, 7.42–7.43
- Prehybridization/hybridization solution  
for hybridization in aqueous buffer, A1.13  
for hybridization in formamide buffers, A1.13  
for hybridization in phosphate-SDS buffer, A1.14  
for plaque/colony lifts, A1.13  
for transcriptional run-on assay protocol, 17.25
- pRFHM1, 18.19, 18.23–18.25, 18.44, A3.4
- Prime Inhibitor, 7.68, 7.77, 7.83, 9.38
- Primer extension, 7.75–7.81  
analysis of products, 7.80–7.81  
hybridization and extension of primer, 7.79–7.80  
mapping regulatory sequences, 17.33  
markers for gel electrophoresis, 7.76  
materials for, 7.76–7.78  
on microarrays, A10.17  
for mutant detection, 13.91, 13.96  
optimizing reactions, 7.76  
overview, 7.75  
probe preparation, 7.78–7.79  
purification of products, 7.80  
sequencing, 7.79
- Primer extension mix, 7.77
- Primer Generator computer program, 13.83
- Primer-adaptors in cDNA synthesis, 11.12–11.13, 11.15, 11.17–11.19, 11.39
- Prism system, 8.95
- pRM1/pRM9, 15.25
- proAB*, 11.23–11.24  
 $\lambda$  propagation and, 2.28–2.29  
M13 vectors and, 3.10, 3.12–3.13
- Probes. *See also* DNA probes; Nonradioactive labeling; Radiolabeled probe preparation; RNA probes  
AMPPD detection, A9.43  
for cDNA screening, 11.27–11.32  
digoxigenin containing, A9.38–A9.40  
for far western analysis of protein-protein interactions, 18.48–18.53  
in GST fusion protein pulldown protocol, 18.55–18.58  
horseradish peroxidase containing, A9.35–A9.36  
immunoblotting, A8.54–A8.55
- Probe synthesis buffer, 9.25
- ProBond, 15.46
- Prodom database, A11.22
- Profection, 16.5, 16.30
- Proline  
cleavage by formic acid, 15.6, 15.8  
codon usage, A7.3  
nomenclature, A7.7  
properties, table of, A7.9  
prototrophs, 3.10–3.11
- Promoter-bashing experiments, 17.30
- Promoters. *See also* Regulatory elements of genes; SP6 bacteriophage, promoter; SV40 promoter; T3 bacteriophage, promoter; T7 bacteriophage, promoter  
bacteriophage promoters in plasmid vectors, 1.11–1.12  
of baculoviruses, 17.82  
for expression of cloned genes in *E. coli*  
choosing a promoter, 15.3–15.4  
IPTG-inducible, 15.3, 15.14–15.19  
 $\lambda$  p<sub>L</sub>, 15.4, 15.25–15.29  
*phoA*, 15.30–15.35  
T7, 15.3–15.4, 15.20–15.24  
in vitro transcription, 9.29–9.37  
 $\lambda$ , 2.5–2.8, 2.14, 2.17, 15.4, 15.25–15.29  
locating by linker-scanning mutagenesis, 13.75  
in low-copy-number plasmid vectors, 1.12  
mapping with primer extension, 17.33  
in plasmid expression vectors, 1.13–1.14  
reporter assays, 17.30–17.51
- Pronase, A4.50
- Prophage,  $\lambda$   
integration, 2.16  
transcription, 2.17–2.18
- PROSITE program, A11.17
- Protease inhibitors  
for optimization of protein expression, 15.19  
table of, A5.1
- Proteases  
cellular heat shock genes, 15.25  
for cleavage of fusion proteins, 15.7–15.8, 15.39–15.40, 15.43  
cleavage site analysis using substrate phages, 18.116
- Protection assays  
nuclease S1, 7.51–7.62  
ribonuclease, 7.63–7.74
- Protein A, 18.81, A9.46–A9.47  
affinity purification of fusion proteins, 15.4, 15.6  
in antibody purification, 14.5, 14.16, 14.51, 18.81, A9.25–A9.26  
applications of, A9.48  
radiolabeled, 14.9, 14.19
- Protein A–Sepharose columns, 11.10, 14.5, 14.16, 14.51, 18.81
- Protein G, 18.81, A9.46–A9.48
- Protein inhibitors of RNases, 7.68, 7.71, 7.77, 7.79, 7.83
- Protein kinase A, 18.49, 18.51
- Protein kinase C $\alpha$  (PKC $\alpha$ ), 18.78, 18.88, 18.93–18.95
- Protein L, A9.46–A9.47, A9.49
- Protein microarrays, A10.18
- Protein Refolding Kit, 15.53
- Protein truncation test (PTT), 13.92
- Proteinase K, 5.78, A1.8  
for alkaline phosphatase inactivation, 2.70, 9.64, 12.24  
in cDNA first-strand synthesis protocol, 11.42  
in DNA isolation from mammalian cells, 6.5, 6.9–6.10, 6.22, 6.28–6.29  
in DNase I hypersensitivity mapping, 17.20–17.21  
in genomic DNA isolation from mouse tails, 6.24–6.26  
inactivation of, 8.26  
inhibition of PCR by, 8.13
- in  $\lambda$  DNA extraction, 2.56–2.58  
for lysis of cells in agarose plugs, 5.62, 5.64, 5.67  
overview of, A4.50  
in PCR lysis solution, 6.22  
in PCR product purification protocol, 8.26  
for restriction enzyme inactivation, 12.24  
in ribonuclease protection assay protocol, 7.73  
for RNase removal, 9.33  
stripping probes from filter and, A9.38  
in transcriptional run-on assay protocol, 17.28
- Proteinase K buffer, A1.11
- Protein-protein interactions, 18.1–18.127  
coimmunoprecipitation, 18.60–18.68  
cell lysis, 18.62, 18.65  
controls, 18.63–18.66  
identification of proteins, 18.66  
immunoprecipitation of cell lysate, 18.62–18.63  
materials for, 18.67–18.68  
method, 18.68  
nonspecific interactions, reducing, 18.65–18.66  
procedure, outline of, 18.61–18.62  
far western analysis, 18.48–18.54  
anti-GST antibodies, 18.54  
materials for, 18.50–18.51  
method, 18.52–18.53  
refolding membrane-bound proteins, 18.53  
troubleshooting, 18.53
- filamentous phage display, 18.115–18.122  
affinity selection and purification of bacteriophages, 18.121  
commercial display systems, 18.120–18.121  
for foreign proteins, 18.121–18.122  
interaction rescue, 18.122  
of peptides, 18.116–18.121  
constrained libraries, 18.120–18.121  
construction of libraries, 18.117–18.119  
random peptide libraries, 18.116–18.117  
vectors used for, 18.115–18.116, 18.118
- FRET, 18.69–18.95  
detection methods, 18.72–18.74  
donor quenching, 18.73  
photobleaching, acceptor, 18.73  
steady-state fluorescence intensity measurements, 18.72–18.73
- FLIM-FRET, 18.78–18.95  
cell preparation for, 18.84–18.89  
data acquisition, 18.90–18.95  
flow diagram, 18.79  
imaging protein phosphorylation with, 18.78  
labeling proteins with fluorescent dyes for, 18.80–18.83  
fluorescence lifetime, 18.73–18.74  
photophysical principles of, 18.70–18.72
- GST fusion proteins  
far western analysis, 18.48–18.54  
pulldown technique, 18.55–18.59  
materials for, 18.57–18.58  
method, 18.58–18.59  
outline of, 18.56  
troubleshooting, 18.59
- mass spectrometry, 18.3  
molecular modeling, 18.3  
overview, 18.2–18.5  
questions posed by, 18.2
- Ras recruitment system (RRS), 18.127
- Sos recruitment system (SRS), 18.126–18.127
- strategies for studying, overview of, 18.3–18.4
- surface plasmon resonance (SPR), 18.96–18.114  
concentration measurement, 18.102  
data collection, 18.100–18.101  
instruments of, 18.96  
kinetic measurements, 18.101–18.102  
overview, 18.97–18.98

- Protein-protein interactions (*continued*)  
 protocol, 18.103–18.114  
 capture surface preparation, 18.105  
 data analysis, 18.112–18.114  
 design, 18.103  
 kinetic analysis, 18.108–18.114  
 test binding, 18.106–18.107  
 schematic of, 18.97  
 sensor chips, 18.98–18.100  
 regeneration of surface, 18.100  
 two-hybrid system, 18.3–18.4, 18.6–18.47  
 bait, dual, 18.11–18.13  
 bait and hook, 18.10–18.11  
 baits, modified, 18.6–18.8  
 baits, troubleshooting, 18.27  
 diagram of, 18.7  
 false positives, 18.14–18.15  
 flow chart, 18.16  
 genomic analysis, 18.123–18.124  
 interaction trap. *See* Interaction trap  
 modifications of, 18.14–18.15  
 non-yeast, 18.127  
 peptide-protein interactions, 18.8–18.9  
 protocol  
 baits, troubleshooting/modification of, 18.27  
 expression of bait protein, detecting, 18.26  
 flow chart, 18.16  
 rapid screen for interaction trap positives, 18.46–18.47  
 replica technique, 18.29  
 repression assay for DNA-binding, 18.23–18.25  
 Stage 1: Bait-LexA fusion protein characterization, 18.17–18.29  
 Stage 2: Interactor selection, 18.30–18.37  
 Stage 3: Second confirmation of positive interactions, 18.38–18.47  
 reverse two-hybrid system, 18.11–18.12  
 RNA polymerase-III-based, 18.15  
 swapped system, 18.15  
 ternary complexes, 18.9–18.10  
 vectors, 18.14, 18.19–18.20, 18.22  
 activation domain fusion plasmids, 18.20  
 LexA fusion plasmids, 18.19  
 reporter plasmids, 18.22  
 yeast CM selective media requirements, 18.21, 18.32, 18.40  
 yeast strains for selection, 18.22  
 ubiquitin-based split-protein sensor (USPS), 18.125–18.126
- Proteins. *See also* Fusion proteins; Protein-protein interactions  
 absorbance of, A8.21  
 biotinylation of, 11.115–11.117  
 chaotropic agent, denaturation of, 15.60  
 databases, bioinformatics, A11.22–A11.23  
 DNA interactions, 18.125  
 identification, 18.66  
 immunoblotting, A8.52–A8.55  
 mass maps, 18.66  
 molar conversion table, A7.7  
 refolding of membrane-bound, 18.53  
 refolding solubilized proteins from inclusion bodies, 15.53–15.54  
 software, bioinformatics, A11.16–A11.17  
 western blotting, A9.28
- Proteolytic enzymes, A4.50  
 Protomap database, A11.22  
 Protoplast fusion, 1.154  
 Protruding termini  
 adaptor attachment to, 1.88–1.89  
 cloning DNA fragments with, 1.20–1.21  
 phosphorylation of, 9.66–9.69
- PRPP progressive global alignment program, A11.8  
 pRS303, 304, 305, 306, A3.4  
 pRS313, 314, 315, 316, A3.5  
 pRS323, 324, 325, 326, A3.5  
 pRSA101, 3.42  
 PRSS program, A11.4  
 pRT601, 11.109  
 pSC101, A3.2  
 incompatibility locus, 1.8  
 plasmid growth and replication, table of, 1.17  
 replicon in, 1.1.4, 1.4  
 pSE280, A3.2  
 Pseudobase database, A11.21  
 Pseudoscreening protocol, 14.23–14.24  
 pSGR3, 13.73  
 pSH17-4, 18.19, 18.23–18.25, 18.28, A3.4  
 pSH18-34, 18.12, 18.24, A3.5  
 PSI-BLAST (position-specific BLAST) program, A11.18  
 pSK vectors for fusion protein construction, 15.5  
 pSKAN, 18.120  
 pSP18/19, A3.2  
 pSPL1, 11.79  
 pSPL3, 11.79, 11.81–11.85, 11.89, A3.4  
 pSPORT1, 11.25, 11.28, 11.63, A3.2  
 in commercial kits for cDNA synthesis, 11.108  
 expression cloning, 11.72  
 pSR1 recombinase, 4.85  
*PstI*  
 7-deaza-dGTP modified DNA, cleavage of, 8.60  
 cleavage at end of DNA fragments, A6.4  
 homopolymeric tailing reactions and, 11.110–11.111  
 linker sequences, 1.99  
 pSV2CAT, 17.95  
 pSV2-His, 17.61–17.63, 17.65  
 pSV2neo, 16.48  
 pSV3neo, 16.48  
 pSVOCAT, 17.95  
 pTA1529, 15.5, 15.32  
 PTEN phosphatase, 17.72  
 pTet-Splice, 17.57–17.58, 17.61, 17.66, 17.70, A3.4  
 pTet-tTak, 17.57–17.58, 17.60–17.62, 17.65, 17.70, A3.4  
 pTK-HYG, 17.61, 17.66  
 pTrec99A, 15.15  
 pTrx, 15.5, A3.2  
 pTrxFus, 15.4–15.5, 15.25, A3.2  
*ptsM* gene, 2.4  
 pTZ18, A3.2  
 PubMed, 1.14, A10.15  
 pUC vectors, 1.9–2.0, A3.2  
 $\alpha$ -complementation, 1.10, 3.9  
 $\beta$ -galactosidase gene, 1.10, 1.27  
 copy number, 1.6  
 expression libraries, 14.14  
 for fusion protein construction, 15.5  
*lacZ* fragments in, 1.10, 3.9  
 for LacZ fusion protein expression, 15.59  
 M13 and, 3.9, 3.14  
 multiple cloning sites, table of, 3.14  
 plasmid growth and replication, 1.17  
 primers for cloning sites in, 8.115  
 replicon in, 1.4, 1.6  
 pUC17, A3.2  
 pUC18, 8.115, 11.111, A6.5  
 pUC19, 8.115, A3.3, A6.5  
 pUC118/119, 3.42, 13.18  
 pUHC13-3, 17.66, 17.70  
 pUK vectors for LacZ fusion protein expression, 15.59  
 Pulse-chase experiments, 15.18–15.19  
 Pulsed-field gel electrophoresis (PFGE)  
 apparatus types, 5.56–5.57  
 CHEF, 5.57, 5.79–5.82  
 conditions for, 5.79–5.80  
 electrode configuration, 5.57  
 method, 5.81–5.82  
 pulse times, 5.79–5.80  
 resolution, 5.79  
 DNA preparation for  
 from mammalian cells/tissues, 5.61–5.64  
 overview, 5.59  
 RE digestion in agarose plugs, 5.68–5.70  
 from yeast, 5.65–5.67  
 DNA recovery  
 direct retrieval, 5.83–5.85  
 following DNA concentration, 5.86–5.88  
 high-capacity vector insert size determination, 4.18  
 molecular-weight markers, 5.59–5.60, 5.71–5.73  
 overview, 5.2–5.3, 5.55–5.56  
 resolution, 5.3  
 factors affecting, 5.57–5.58  
 field angle, 5.59  
 pulse time, 5.58, 5.74–5.75, 5.79–5.80  
 temperature, 5.59  
 voltage, 5.58–5.59  
 restriction enzyme use with, 5.60, 5.68–5.70  
 TAFE, 5.56–5.57, 5.74–5.78  
 electrode configuration, 5.57  
 method, 5.76–5.78  
 pulse times, 5.74–5.75  
 resolution, 5.74  
 silver staining, 5.77  
 Southern blots, 5.77–5.78  
 theory overview, 5.55–5.56  
 pUR vectors for LacZ fusion protein expression, 15.59  
 Purification of plasmid DNA. *See* Plasmid DNA, purification  
 Purine molecules, numbering of atoms on, A6.5  
 Puromycin, 16.49, 17.65–17.67, 17.69, A2.7  
 Puromycin-*N*-acetyl transferase, 16.47, 16.49  
 Putrescine, 4.21  
 PVDF membranes  
 colorimetric detection of nonradioactive probes on, 9.78  
 for immunoblotting, A8.53  
 pVgRXR, 17.74, A3.4  
 pVHL protein, 18.60, 18.62, 18.64–18.65  
*PvuI* methylation, 13.87, A4.3, A4.7  
*PvuII*  
 in pSPL3, 11.84  
 in USE, 13.85  
*PvuII* methylase, A4.7  
*Pwo* DNA polymerase, 8.11, 8.30  
 in circular mutagenesis, 13.20, 13.21  
 in overlap extension method of mutagenesis, 13.37  
 properties, table of, A4.23  
 pXf3, 1.9, A3.3  
 pYAC4, 4.59, 4.63, 4.76, A.65  
 pYD1, 18.120  
 pYD1 Yeast Display Vector Kit, 18.120  
 pYESTrp, 18.20  
 Pyridopyridazines, A9.18  
 Pyrimidine molecules, numbering of atoms on, A6.5  
 Pyrimidine tract analysis, 12.3  
 Pyrophosphatase, 9.88  
 in DNA sequencing protocols, 12.34–12.36, 12.39  
 dUTPase, 13.85  
 Pyrophosphate  
 in automated DNA sequencing protocols, 12.95  
 luciferase and, A9.22  
 Pyroxylin, 6.14  
 pZLL1, 11.25, A3.3
- Q358 and Q359 *E. coli* strain  
 genotype, A3.9  
 $\lambda$  vector propagation, 2.28–2.29  
 QAE (diethyl[2-hydroxy-propyl]aminoethyl), 1.19  
 QBT buffer (Qiagen), A1.21

- Q gene,  $\lambda$ , 2.8–2.9, 2.12, 2.14  
 Qiagen BioRobot, A10.5  
 Qiagen resins. DNA purification on, 4.45  
 QIAprep, 1.64, 8.27  
 QIAprep Turbo miniprep, 12.27  
 QIAquick, 8.26  
 Quantitation of nucleic acids, A8.19–A8.24  
   fluorometry, A8.22–A8.24  
     ethidium bromide use, A8.19, A8.23–A8.24  
     agarose plate method, A8.24  
     minigel method, A8.24  
     spot test, A8.19, A8.24  
     with Hoechst 33258, A8.19, A8.22–A8.23  
   methods, summary of (Table 8-4), A8.19  
   spectrophotometry, A8.20–A8.21  
 Quaternary alkylammonium salts, 10.6  
 Quaternary ammonium salts, 10.35–10.37  
 Quik Change site-directed mutagenesis kit, 13.21, 13.89  
*quit* site,  $\lambda$ , 2.14
- R1 replicon, 1.12–1.13  
 R6K, A3.3  
 R408, 3.42, 3.44  
 R594 *E. coli* strain  
   genotype, A3.9  
    $\lambda$  vector propagation, 2.28  
 3'-RACE and 5'-RACE. *See* Rapid amplification of cDNA ends (RACE)  
 Radioactive ink, 1.142, 2.97–2.98, A1.21  
 Radioactivity, measuring  
   adsorption to DE-81 filters, A8.26  
   precipitation of nucleic acids with TCA, A8.25–A8.26  
   specific activity, calculating, A8.26  
 Radioimmunoassay (RIA), A9.29  
 Radiolabeled probe preparation, 9.1–9.93  
   asymmetric probes, 9.14, 9.18  
   cDNA probes  
     subtracted, 9.90–9.91  
       by random extension, 9.46–9.50  
       using oligo(dT) primer, 9.41–9.45  
       using oligo(dT) primer, 9.41–9.45  
       using random oligonucleotide primers, 9.38–9.40  
   dephosphorylation of DNA fragments with alkaline phosphatase, 9.62–9.65  
   end-labeling  
     3' termini with cordycepin or dideoxyATP, 9.60–9.61  
     3' termini with Klenow, 9.51–9.56, 9.83–9.85  
       materials for, 9.53  
       overview of, 9.51–9.53  
       protocol, 9.54  
       uses for, 9.51  
     3' termini with T4 DNA polymerase, 9.57–9.59  
     5' termini with T4 polynucleotide kinase, 9.55, 9.66–9.75  
       blunt/recessed 5' termini, 9.70–9.72  
       by exchange reaction, 9.73–9.75  
       protruding 5' termini, 9.66–9.69, 9.73–9.75  
   methods, table of, 9.55–9.56  
   with poly(A) polymerase, 9.56, 9.61  
   with RNA ligase, 9.56, 9.61  
   with terminal transferase, 9.55–9.56, 9.60–9.61  
   with Klenow fragment, 10.30–10.34  
   methods of radiolabeling, table of, 9.3  
 PCR, 9.14–9.18  
   advantages of, 9.14  
   asymmetric probe production, 9.14, 9.18  
   methods used, 9.14–9.15  
   protocol, 9.15–9.17  
 random priming  
   components of reactions, 9.5–9.6  
   DNA polymerase, 9.5  
   primers, 9.5–9.6  
   radiolabel, 9.5  
   template DNA, 9.6  
   in melted agarose, 9.9–9.11  
   nick translation compared, 9.4  
   protocols, 9.6–9.11  
 RNA probes  
   in vitro transcription, 9.29–9.37  
   materials for, 9.32–9.33  
   PCR, promoter addition, 9.36–9.37  
   plasmid vectors, 9.29–9.31  
   protocol, 9.33–9.35  
   in situ hybridization, 9.35  
   troubleshooting, 9.36  
 single-stranded DNA from M13  
   defined length, 9.19–9.24  
   heterogeneous length, 9.25–9.28  
   premature termination, 9.24  
 Radiolabeled probes. *See also* Hybridization;  
   Radiolabeled probe preparation  
   calculation of the specific activity of, A8.26  
   denaturation of, 1.140–1.141  
   denaturing double-stranded, 2.98, 6.54  
   DNase I footprinting protocol, 17.5, 17.7  
   in DNase I hypersensitivity mapping protocol, 17.21  
   in dot/slot hybridization, 7.48, 7.50  
   end-labeled, 7.54  
   in gel retardation assays, 17.13–17.16  
   northern hybridization, 7.43–7.44  
     low stringency, 7.43  
     stripping probes, 7.44  
   oligonucleotide purification by  
     precipitation with CPB, 10.22–10.24  
     precipitation with ethanol, 10.20–10.21  
     Sep-Pak C<sub>18</sub> chromatography, 10.28–10.29  
     size-exclusion chromatography, 10.25–10.27  
   phosphorylation of 5' termini of oligonucleotides, 10.17–10.19  
   purification, 6.56, 7.45  
   purity, 2.98  
   reuse of, 1.141  
   RNA probes, 6.58, 7.54  
     ribonuclease protection assays, 7.63–7.74  
   S1 protection assays, 7.51–7.62  
   screening bacterial DNA on filters, 1.138–1.142  
   screening clones for site-directed mutagenesis, 13.40–13.47  
   screening expression libraries, 14.3, 14.31–14.36  
   screening M13 plaques with, 3.41  
   single-stranded DNA probes, 6.58  
 Southern hybridization  
   low-stringency hybridization, 6.58  
   nonradioactive probes, 6.50  
   overview, 6.50  
   protocol, 6.51–6.55  
     hybridization, 6.54  
     prehybridization, 6.53–6.54  
     washing, 6.54–6.55  
   sensitivity, 6.50  
   stripping from membranes, 6.57  
 Radiolabeling. *See also* Radiolabeled probe preparation  
 antibody, A9.30  
   IgG, radioiodination of, 14.5, 14.16  
   for screening expression libraries, 14.3, 14.5, 14.16  
 CAT reporter assay, 17.36, 17.38–17.41  
 in coimmunoprecipitation protocol, 18.62  
 for DNA sequencing, 12.36, 12.43, 12.49–12.54, 12.60  
   asymmetric labeling, 12.72  
   chemical, 12.64  
   end-labeling by PCR, 12.73  
 in DNase I footprinting protocol, 17.5, 17.7  
   end labeling, 4.33, 12.73  
   for far western analysis of protein-protein interactions, 18.49, 18.52  
   in gel retardation assays, 17.13–17.15  
   with Klenow fragment, 12.101–12.102, A4.15  
   of oligonucleotides by phosphorylation, 13.42–13.43  
   pulse-chase experiments, 15.18–15.19  
   in restriction enzyme digestion efficiency monitoring, 2.66  
   RNA by RNA ligase, A4.30  
   with T4 DNA polymerase, A4.18–A4.19  
   with T4 DNA polynucleotide kinase, A4.35  
   with terminal transferase, A4.27  
   for transcriptional run-on assays, 17.23–17.24, 17.27–17.28  
 RAG1/RAG2 (recombination activating genes), 17.56  
 RainX, 12.75  
 Random priming buffer, 9.6, 9.47  
 Random priming in digoxigenin labeling of nucleic acids, A9.38–A9.39  
 Rapid amplification of cDNA ends (RACE), 18.14  
   3'-RACE, 8.61–8.65  
   5'-RACE, 8.54–8.60  
 Ras recruitment system (RRS), 18.125–18.126  
 Rat, genomic resources for microarrays, A10.6  
 RB791 *E. coli* strain, A3.9  
 rBst DNA polymerase, A4.23  
 Real time PCR, 8.89, 8.94–8.95  
   advantages/disadvantages, 8.95  
   fluorometric detection, 8.94  
   instruments for, 8.95  
   TaqMan method, 8.95  
 Reassociation kinetics, 7.65–7.66  
 REBASE (restriction enzyme database), 1.16, 13.88, A4.3–A4.4, A4.9  
 recA gene, 1.15, 2.28–2.29  
 RecA protein  
   chi site and, 2.13  
    $\lambda$  CI protein cleavage, 2.8, 2.18  
 recA1, M13 vectors and, 3.11–3.13  
 recB, 1.15, 2.11, 2.13, 2.28  
 recC, 2.11, 2.28  
 recD, 2.11, 2.13, 2.28  
 RecF, 1.15  
 RecJ, 1.15  
 RecO, 1.15  
 Recombinant phage antibody system, 18.120  
 Recombination  
   chi sites and, 2.13  
   Cre-loxP recombination system, 4.82–4.85, 11.25–11.26  
   in  $\lambda$ -infected cells, 2.11–2.13  
   M13 vectors and, 3.11–3.13, 3.16  
 Recombination activating genes (RAG1/RAG2), 17.56  
 RecQ, 1.15  
 red,  $\lambda$ , 2.11, 2.20, 2.22  
 Red blood cell lysis buffer, 5.62, 6.28–6.29  
 REF select program, 13.94  
 Regulatory elements of genes. *See also* Promoters  
   detection by transcriptional run-on assays, 17.23  
   gel retardation assays for DNA-binding proteins, 17.13–17.17  
   identification by linker-scanning mutagenesis, 13.75–13.77  
   mapping by DNase I footprinting, 17.18–17.22  
   mapping by DNase I hypersensitivity sites, 17.18–17.22  
   mapping by hydroxyl radical footprinting, 17.12  
   reporter assays, 17.30–17.51  
      $\beta$ -galactosidase, 17.48–17.51  
     CAT, 17.33–17.41  
     luciferase, 17.42–17.47  
   overview, 17.30–17.32

- Renilla reniformis*, 17.89, 17.96, A9.22  
 Remin, 13.8  
 repA gene in runaway plasmid vectors, 1.13  
 RepA protein, 1.4, 1.8  
 repE in bacterial artificial chromosome, 4.2, 4.48  
 Repelcote, 12.75  
 Repetitive DNA sequences, amplification of, 8.106  
 Replacement vectors,  $\lambda$ , 2.19, 2.22, 2.64–2.65  
 Replication, DNA  
   chromosomal, chloramphenicol blockage of, 1.143  
   plasmid, 1.4–1.7  
     diagram of, 1.5  
     incompatibility of plasmids, 1.7–1.8  
     initiation of DNA synthesis, 1.5–1.6  
     inverted repeat lethality, 1.15  
     regulation by RNAI, 1.6–1.7  
     relaxed, 1.4, 1.17  
     runaway, 1.13  
     stringent, 1.4, 1.17  
 Replication, M13, 3.2, 3.5–3.7  
 Replicative form (RF), M13, 3.2, 3.5–3.6, 3.23–3.25  
 Replicons  
   ARS, 4.2–4.3, 4.60  
   chloramphenicol amplification and, 1.143–1.144  
   colE1, 1.3–1.4, 1.13, 1.15, 1.17, 1.143, 4.2, 4.5, 11.22–11.24, 15.3  
   F, 4.2–4.3  
   fl, 11.22–11.24  
   in high-capacity vectors, 4.4  
   incompatibility of plasmids, 1.7–1.8  
   low-copy-number plasmid vectors, 1.12  
   P1, 4.4, 4.37  
   plasmid copy number and, 1.3–1.4, 1.12  
   SV40, 4.5  
   table of, 1.4  
 Reporter assays, 17.30–17.51  
    $\beta$ -galactosidase, 17.48–17.51  
   CAT, 17.33–17.41, 17.95  
   GFP, 17.85–17.87  
   luciferase, 17.42–17.47, 17.96, A9.21, A9.23  
   overview, 17.30–17.32  
 Reptation, 5.2, 5.36, 12.114  
 Rescue buffer, 18.39  
 Resequencing, A10.17  
 Resins, 1.62–1.64. *See also* Chromatography  
   for DNA purification, 1.63–1.64, 5.26  
   ion-exchange, formamide deionization, 6.59  
   oligonucleotide purification, 10.49  
   table of commercially available, 1.64  
 Resolvases, 13.91, 13.94  
 Resolver program, A10.15  
 Restriction digestion of DNA for Southern analysis, 6.39–6.40, 6.42  
 Restriction endonuclease fingerprinting (REF), 13.91, 13.94  
 Restriction enzymes. *See also* Restriction sites; *specific enzymes*  
   in adaptor use, 1.89  
   adenine methylation and, 13.87–13.88  
   agarose plugs, DNA digestion, 5.68–5.70, 5.78  
   boiling lysis plasmid DNA preparations and, 1.18, 1.43  
   cleavage near ends of DNA fragments, 1.86, 8.31, 8.37–8.38, A6.4  
   cyclic coiled DNA resistance to cleavage, 1.40, 1.45, 1.49  
   digestion efficiency, monitoring, 2.66–2.67  
   DNA resistance to cleavage  
     alkaline lysis preparations, 1.33, 1.36, 1.42  
     boiled lysis preparations, 1.45, 1.49  
   in exonuclease III mutagenesis protocol, 13.57–13.59  
   fragment size created by, table of, A4.8  
   genomic DNA mapping, 5.68–5.69  
   inhibition by agarose, 5.18, 5.29  
   inhibition by cell wall components, 1.33, 1.36, 1.42, 3.24  
   inverse PCR and, 8.81–8.83  
   ligation reactions, inclusion into, 1.100  
   linker sequences for, 1.99  
   partial digestion of eukaryotic DNA for genomic libraries, 2.76–2.83  
   pulsed-field gel electrophoresis, use with, 5.60, 5.68–5.70  
   use in BAL 31 mutagenesis protocol, 13.63, 13.66  
 Restriction enzyme buffers, effect on DNA migration in agarose, 5.10  
 Restriction mapping  
   BAL 31 nuclease use for, 13.68  
   of cosmid/genomic DNA recombinants, 4.33  
   YAC genomic inserts, 4.63  
 Restriction mutations, M13, 3.10–3.13  
 Restriction sites  
   addition to 5' termini of PCR primers, 8.31, 8.37–8.39  
   clamp sequences, 8.38–8.39  
   enzyme choice, 8.37–8.38  
   frequency in human genome, 4.16, A6.3  
   in linkers/adaptors, 1.98–1.100, 11.20–11.21, 11.48–11.52, 11.64  
   methylation of, A4.5–A4.9  
     *dam* methyltransferase, A4.3  
     isochizomer pairs, table of, A4.6  
     mutagenesis to create/remove, 13.83  
   removal by USE mutagenesis, 13.26–13.30, 13.85  
 Restriction/modification systems, A4.4. *See also* Methylation  
 Retinoid X receptor (RXR), 17.71, 17.73  
 Rev response element (RRE), 18.11  
 Reverse transcriptase, 8.48, 8.51–8.52, A4.24–A4.26  
   in 3'-RACE protocol, 8.61–8.62, 8.64  
   5'-3' polymerase activity, A4.24  
   in 5'-RACE protocol, 8.54–8.58, 8.60  
 ALV, 11.11  
 AMV, 8.48, 11.38, 11.109  
 cDNA first strand synthesis, 11.38–11.42  
 in cDNA probe construction, 9.39–9.40, 9.42–9.43, 9.47–9.48  
 controls for activity variation, 9.40, 9.43, 9.48  
 in differential display-PCR, 8.97, 8.101, 8.103  
 digoxigenin labeling of nucleic acids, A9.39  
 in exon trapping/amplification protocol, 11.89–11.91  
 inactivation, 8.52, 8.103  
 Mo-MLV, 8.48, 9.39, 9.42, 9.47, 11.11, 11.38, 11.40, 11.41, 11.109–11.110  
 in primer extension assays, 7.75, 7.77, 7.79  
 properties, table of compared, A4.11  
 in quantitative RT-PCR, 8.91  
 RNase activity, 11.11–11.12, A4.24–A4.25  
*Tth* DNA polymerase, 8.48  
 types of, 11.11–11.12  
 uses, list of, A4.25–A4.26  
 Reverse transcriptase buffer, A1.11  
 Reverse transcriptase-PCR. *See* RT-PCR  
 Reversed-phase chromatography, 10.11, 10.15–10.16  
   for DNA purification, 5.26  
   oligonucleotide purification, 10.49  
*rexA* gene,  $\lambda$ , 2.3, 2.17  
*rexB* gene,  $\lambda$ , 2.3, 2.17  
 RF6333, *E. coli*, 15.19  
 RFY206, 18.22  
*R* gene,  $\lambda$ , 2.15–2.16  
 Rhodamine, 12.96–12.98, A9.33  
 Rhodium, 17.77  
 Ribonuclease. *See* RNase  
 Ribonuclease protection assays, 7.63–7.74  
   diagram of, 7.64  
   northern hybridization compared, 7.63–7.65  
   protocol  
   analysis by gel electrophoresis, 7.73–7.74  
   digestion of hybrids, 7.73  
   dissolving nucleic acid pellets, 7.72  
   hybridization, 7.72–7.73  
   materials for, 7.67–7.68  
   probe preparation, 7.70–7.72  
   quantification of RNA in samples, 7.63, 7.65–7.66  
   S1 protection assay compared, 7.65  
   sensitivity of, 7.63–7.65  
 Riboprobe Gemini Systems, 9.32  
 Ribosomal protein S10, 2.7  
 Ribosomal RNA mutation databases, A11.21  
 Ribosome-binding site, 15.11–15.12, 15.18  
 Rifampicin  
   inhibition of bacteriophage T7 RNA polymerase, 15.20  
   modes of action, A2.7  
 RNA  
   5' cap, 9.88  
   concentrating. *See* Concentrating nucleic acids  
   concentration determination by spectrophotometry, 7.8, 7.16  
   CsCl density gradients, 1.155  
   databases, bioinformatics, A11.21–A11.22  
   denaturation  
   with formamide, 6.59  
   by heat, 8.51  
   dephosphorylation, 9.65  
   electrophoresis, agarose gel, 7.21–7.23, 7.27–7.34  
   equalizing RNA amounts in, 7.22–7.23  
   formaldehyde-containing gels, 7.31–7.34  
   glyoxylated RNA, 7.27–7.30  
   integrity of RNA, checking methods, 7.30  
   markers for, 7.23, 7.29  
   end-labeling  
   3' termini, 9.56  
   5' termini, 9.55  
   hybridization  
   dot and slot, 7.46–7.50  
   northern protocol. *See* Northern hybridization  
   LiCl precipitation of, 1.59  
   mapping  
   mung bean nuclease, 7.55  
   nuclease S1, 7.51–7.62  
   primer extension, 7.75–7.81  
   ribonuclease protection assays, 7.63–7.74  
   polymerase (*see* RNA polymerase)  
   precipitation with LiCl, 1.59, 1.82–1.83  
   probes, 7.54  
   for in situ hybridization, 9.35  
   purification of, 7.54  
   ribonuclease protection assays, 7.63–7.74  
   screening expression libraries, 14.2  
   synthesis of single-stranded probes by in vitro transcription, 9.29–9.37  
   protein interaction, studying with bait and hook strategy, 18.10–18.11  
   purification  
   acid phenol-guanidinium thiocyanate-chloroform extraction, 7.4–7.8  
   DNA contamination, 7.8, 7.12  
   ethanol precipitation, 9.34–9.35  
   gel electrophoresis, 9.35  
   isopropanol precipitation, 7.7, 7.12  
   poly(A)<sup>+</sup> RNA selection by batch chromatography, 7.18–7.19  
   poly(A)<sup>+</sup> RNA selection by oligo(dT)-cellulose chromatography, 7.13–7.17  
   simultaneous preparation with DNA and protein, 7.9–7.12  
   spun-column chromatography, 9.35  
   quantitation. *See* Quantitation of nucleic acids  
   RNAI  
   decay due to *pctB* gene, 1.13



- degradation, 1.7  
 regulation of replication, 1.6–1.8  
 Rom binding, 1.7  
 RNAll, 1.4–1.7  
   mutation in pUC plasmid family, 1.6  
   priming of DNA synthesis at *colE1* origins, 1.5–1.6  
   RNAI interaction, 1.6–1.7  
   RNase H transcript processing of, 1.6  
   Rom binding, 1.7  
 software, bioinformatics, A11.14–A11.15  
 staining  
   ethidium bromide binding, 1.151  
   of glyoxylated RNA, 7.27–7.28  
   with methylene blue, 7.39, A9.4  
   with SYBR dyes, A9.7–A9.8  
 standards, 7.23  
 storage of, 7.8  
 types, 7.2  
 yeast carrier tRNA, 5.20  
 RNA denaturation solution, 7.48  
 RNA gel-loading buffer, 7.68, A1.19  
 RNA ligase, bacteriophage T4, 1.157, 9.56, A4.34  
 RNA modification database, A11.21  
 RNA polymerase, A4.28–A4.29  
   bacteriophage T3, A4.28–A4.29  
   bacteriophage T7, A4.28–A4.29  
     inhibition by lysozyme, 15.21, 15.24  
     inhibition by rifampicin, 15.20  
   digoxigenin labeling of nucleic acids, A9.38–A9.39  
   DNA-dependent, 1.4  
   *E. coli*, 9.87  
     in  $\lambda$ , 2.10–2.11  
     M13 replication, 3.5  
   in vitro transcription, 9.30–9.32, 9.34, 9.36–9.37, 9.87–9.88  
    $\lambda$ , 2.6, 2.7, 2.8  
   nuclear run-on assays, 17.23  
   promoter addition to DNA fragment by PCR, 9.36–9.37  
     amplification conditions, 9.36  
     primer design, 9.36  
   promoter sequences recognized by bacteriophage-encoded, 7.87  
   in ribonuclease protection assay protocol, 7.68, 7.71  
   RNA polymerase III in two-hybrid system for protein-protein interaction study, 18.15  
   transcription terminator signal  
     overcoming, 9.36  
     recognition, 9.36  
 RNA precipitation solution, 7.10  
 RNA secondary structures database, A11.21  
 RNA World database, A11.21  
 RNase, 7.2, A1.8  
   in BLOTTO, 1.139  
   cleavage of mismatches in RNA:RNA heteroduplexes, 13.93  
   contamination  
     preventive measures, 7.82  
     sources of, 7.82  
   in vitro transcription, 9.36  
   in CsCl-ethidium bromide gradients, 1.67  
   formamide protection of RNA, 7.8  
   inactivation of, 7.4  
   inhibitors of  
     DEPC, 7.82–7.84  
     placental, 8.49  
     protein, 7.68, 7.71, 7.77, 7.79, 7.83, 11.39  
     RNasin, 17.25  
     vanadyl ribonucleoside complexes, 7.83  
   in lysis buffer, 6.4–6.5  
   nucleic acid contaminant removal, 1.79  
   removal by phenol:chloroform extraction, 9.33  
   removal by proteinase K, 9.33  
     in yeast DNA purification protocols, 4.69, 4.71  
   RNase A, 1.59, A4.39  
     in alkaline lysis with SDS protocols, 1.34–1.35, 1.38  
     cleavage of mismatches in RNA:RNA heteroduplexes, 13.93  
     cleavage preferences, 7.67  
     DNase free, preparation of, A4.39  
     in ribonuclease protection assays, 7.66–7.68  
     in transcriptional run-on assay protocol, 17.29  
   RNase digestion mixture, 7.68, 7.73  
   RNase E, 1.7  
   RNase H, 1.4, 7.77, 8.48, 11.43  
     activity of exonuclease III, 13.73  
     in ALV reverse transcriptase, 11.11  
     buffer, A1.11  
     in cDNA second-strand synthesis, 11.14–11.17, 11.43–11.46  
     in DNA polymerase I, A4.12  
     functions of, 8.111  
     overview of, A4.38  
     in reverse transcriptases, 11.11–11.12, 11.109–11.110, A4.24–A4.25  
     RNAll transcript processing, 1.6  
   RNase I, 7.67, 13.93  
   RNase III, *E. coli*, 2.6  
   RNase ONE, 7.67  
   RNase P (polymerase III) promoter, 18.11  
   RNase T1, A4.39  
     cleavage of mismatches in RNA:RNA heteroduplexes, 13.93  
     cleavage preferences, 7.67  
     in ribonuclease protection assays, 7.66–7.68  
     in transcriptional run-on assay protocol, 17.29  
   RNase T2, 7.67  
   RNaseOUT, 9.38  
   RNasin, 7.68, 7.77, 7.83, 9.38, 17.25  
   RNA-Stat-60, 7.10  
   Robbins Hydra Work Station, A10.5  
   Robotics for high-throughput processing, A10.5  
   Roller bottle hybridization chamber, 6.51, 6.53–6.54  
   Rolling circle replication  
      $\lambda$ , 2.11–2.12  
     in phagemids, 3.43  
   Rom (RNAI modulator), 1.5, 1.7  
   Rop (repressor of primer), 1.5, 1.7  
   Rotors, table of commonly used, A8.39  
   RPCI-11 Human BAC Library, 4.9  
   R-phycoerythrin, A9.33  
   RR1 *E. coli* strain, A3.9  
   rRNA database, A11.21  
   *RsaI*, A4.9  
   *RsrI* site frequency in human genome, 4.16, A6.3  
   *RsrII*  
     fragment size created by, table of, A4.8  
     genomic DNA mapping, 5.69  
     methylation, A4.7  
   RT-PCR (reverse transcriptase-PCR), 8.46–8.53  
     advantages/disadvantages, 11.15  
     controls/standards, 8.48–8.49, 8.51–8.52  
     differential display-PCR, 8.97  
     enzymes, reverse transcriptase  
       inactivation of, 8.52  
       types used, 8.48  
     in exon trapping/amplification protocol, 11.89–11.94  
     full-length clones, low-yield of, 8.60  
     materials for, 8.49–8.51  
     measuring multiple gene products by, 8.89  
     method, 8.51–8.53  
     primers for, 8.46–8.48  
     quantitating RNA by, 7.66  
     quantitative, 8.88–8.91  
     reference templates, 8.88–8.89  
     troubleshooting, 8.53, 8.60  
   *rTh* DNA polymerase  
     in circular mutagenesis, 13.20  
     in overlap extension method of mutagenesis, 13.37  
     properties, table of, A4.23  
   Runaway plasmid replication, 1.13  
   Rz gene,  $\lambda$ , 2.15–2.16  
   <sup>35</sup>S  
     decay data, A9.15  
     particle spectra, A9.9–A9.10  
     sensitivity of autoradiographic methods for detection, A9.13  
   5S rRNA data bank, A11.21  
   S1 nuclease. *See* Nuclease S1  
   *sacB* gene, 4.4–4.5, 4.37  
   *Saccharomyces cerevisiae*, 4.58–4.60. *See also* Yeast artificial chromosomes  
     chromosome separation by pulsed-field gel electrophoresis, 5.56  
     chromosome sizes, 5.60, 5.65  
     expression in, 15.55  
     FLP recombinase, 4.85  
     genome size, 4.64  
     protein interactions in, mapping, 18.123–18.124  
     protein-protein interactions, studying, 18.4, 18.6  
     Sos recruitment system (SRS), 18.125–18.126  
   *SacI*  
     cleavage at end of DNA fragments, A6.4  
     fragment size created by, table of, A4.8  
     linker sequences, 1.99  
     site frequency in human genome, 4.16, A6.3  
   *SacII*  
     fragment size created by, table of, A4.8  
     site frequency in human genome, 4.16, A6.3  
   *S*-adenosylmethionine (SAM), 1.99, 11.48–11.49, A4.3  
   SAGA (Sequence Alignment by Genetic Algorithm) program, A11.7–A11.8  
   *Sall*  
     7-deaza-dGTP modified DNA, cleavage of, 8.60  
     cDNA linkers and adaptors and, 11.20, 11.51, 11.64  
     in cDNA synthesis kits, 11.71  
     cleavage at end of DNA fragments, A6.4  
     fragment size created by, table of, A4.8  
     genomic DNA mapping, 5.69  
     in homopolymeric tailing protocols, 11.111  
     linker sequences, 1.99  
     methylation, A4.7  
     site frequency in human genome, 4.16, A6.3  
     terminal/subterminal site cleavage, inefficient, 8.38  
   Salmon sperm DNA  
     in chemical sequencing protocols, 12.64  
     in hybridization/prehybridization solutions, 6.52–6.53, 6.56, 7.45, 10.35, 10.38  
     as transfection control, 16.4  
   SAM. *See* *S*-adenosylmethionine (SAM)  
   SAM (Sequence Alignment and Modeling System) program, A11.7  
   SAP. *See* Shrimp alkaline phosphatase  
   Sarkosyl for lysis of cells in agarose plugs, 5.62, 5.64, 5.67  
   Satellite colonies, 1.110, 1.115, 1.118, 1.148  
   Saturation mutagenesis, 13.2–13.3  
   *Sau3AI*  
     7-deaza-dGTP modified DNA, cleavage of, 8.60  
     *dam* methylation and, 13.87, A4.3  
     genomic DNA digestion, 4.11, 4.36  
     in site-directed mutagenesis protocol, 13.84  
   *sbcA*, 2.13, 2.28  
   *sbcB*, 1.15, 2.13  
   *SbfI* site frequency in human genome, 4.16, A6.3  
   ScanAlyze image analysis program, A10.5, A10.13  
   ScanArray 5000, A10.11

- Scanning mutagenesis, 13.3  
 ScanProsite program, A11.17  
*Scel*, 17.83  
 Schiff bases and formaldehyde, 7.31  
*Schizosaccharomyces pombe*, chromosome sizes of, 5.60, 5.65  
 Schlieren line, 12.79  
 Scintillation counting, 7.47, A8.25  
   CAT reporter assay, 17.39–17.41  
   coincidence circuit, 17.46, A9.22  
   luciferase assay, 17.46, A9.22–A9.23  
 SCOP (Structural Classification of Proteins) database, A11.22  
 Screening. *See also* Expression libraries, screening; Hybridization; Immunological screening  
   bacterial colonies  
      $\alpha$ -complementation, 1.123–1.125  
     by hybridization  
       filter types, choosing, 1.126  
       intermediate numbers, 1.129–1.131  
       large numbers, 1.132–1.134  
       small numbers, 1.126–1.128  
     using X-gal and IPTG, 1.123–1.125  
   cDNA libraries, 11.26–11.34, 11.74–11.78  
    $\lambda$  recombinants, 2.21  
   by PCR  
     bacterial colonies, 8.74–8.75  
      $\lambda$  libraries, 8.76  
      $\lambda$  plaques, 8.74–8.75  
     yeast colonies, 8.75  
   for recombinant plasmids, 1.26–1.28  
      $\alpha$ -complementation, 1.27, 1.150  
     by hybridization, 1.27–1.28  
     overview, 1.26–1.27  
   transformants by insertional inactivation, 1.10  
   YAC recombinants, 4.60  
 Screening buffer, 14.33  
 Sculptor IVM Mutagenesis kit, 13.89  
 SDS, A1.28  
   in acrylamide gel elution buffer, 5.52  
   alkaline phosphatase inactivation, 1.96  
   bovine serum albumin absorption of, 6.25  
   in dot/slot hybridization, 7.48, 7.50  
   in elution buffers, 7.14  
   for inactivation of alkaline phosphatase, 9.64  
   in  $\lambda$  DNA extraction, 2.58  
   in mouse-tail lysis buffers, 6.26  
   in northern hybridization protocols, 7.42–7.44  
   in phosphate-SDS washing solution, 6.51–6.52  
   plasmid DNA protocols  
     alkaline lysis, 1.31–1.42  
     gentle method, 1.55–1.58  
   in ribonuclease protection assay protocol, 7.73  
   in SSCP protocol, 13.56  
   in SNET lysis buffer, 6.24–6.25  
   for solubilization of GST fusion proteins, 15.38–15.39  
   for solubilization of inclusion bodies, 15.54  
   in Southern hybridization wash solutions, 6.55  
   in yeast DNA preparation protocols, 4.68–4.71  
 SDS buffer, 17.20  
 SDS gel-loading buffer, 15.15, 15.22, 15.26, 15.31, 15.35, 15.41, 15.50, 18.17, A1.20, A8.42  
 SDS-EDTA dye mix, A1.20  
 SDS-polyacrylamide gel electrophoresis of proteins, A8.40–A8.51. *See also* Polyacrylamide gel electrophoresis  
   discontinuous buffer system, A8.40  
   drying gels, A8.50–A8.51  
   overview, A8.40  
   protocol  
     materials, A8.42–A8.44  
     pouring gels, A8.44–A8.45  
     resolving gel components, table of, A8.43  
     running gels, A8.45  
     sample preparation, A8.45  
     stacking gel components, table of, A8.43  
     reagents, A8.41–A8.42  
     separation range, table of, A8.42  
     staining gels, A8.46–A8.49  
       with Coomassie Brilliant Blue, A8.46–A8.47  
       during immunoblotting, A8.54  
       with silver salts, A8.46–A8.49  
     transfer of proteins from gel to filters for immunoblotting, A8.52–A8.53  
 Seal-A-Meal bags, 1.139, 2.97, 6.51, 6.53–6.54  
 Searching databases, 1.14  
 Secreted foreign proteins, expression of, 15.30–15.35  
 Selectable markers  
   inactivation as screening tool, 1.10  
   for  $\lambda$  recombinants, 2.21  
   uses of, 1.8–1.9  
 Selection. *See also* Antibiotics; *specific protocols*  
   conditionally lethal genes, 1.12  
   direct selection of cDNAs, 11.98–11.106  
   of mutants in vitro  
     *DpnI* destruction of parentals, 13.19–13.25, 13.84  
     phosphorothioate analog incorporation, 13.86–13.87  
     unique restriction site elimination, 13.26–13.30, 13.85  
     uracil-DNA glycosylase destruction of parentals, 13.84–13.85  
   of mutants in vivo, 13.87  
   positive selection vectors, 1.12  
 Sephacryl equilibration buffer, A1.21  
 Sephacryl S-400 in DNA purification for DNA sequencing, 12.106  
 Sephacryl S-1000, nucleic acid fragment contaminants, removal of, 1.80–1.81  
 Sephadex  
   G-15 for oligonucleotide purification, 10.26  
   G-25 in IgG radioiodination protocol, 14.5, 14.16  
   G-50, A8.29–A8.30  
     in cDNA probe production, 9.44–9.45, 9.49–9.50  
     in cDNA synthesis protocols, 11.44, 11.47, 11.54  
     for radiolabeled probe purification, 9.69, 9.71, 9.75  
     RNA purification, 9.35  
   poly(U), 7.15, 7.20  
   preparation of, A8.29  
 Sepharose  
   4B for antisera purification, 14.30, 14.51  
   affinity purification of fusion proteins, 15.6  
   CL-4B, A8.31, A9.26  
     cDNA size fractionation, 11.55–11.58  
     in dephosphorylated DNA purification, 9.65  
   CL-6B for DNA purification for DNA sequencing, 12.106  
 Sep-Pak  $C_{18}$  chromatography, 10.11, 10.13, 10.15–10.16, 10.28–10.29  
 Sequenase, 12.9  
   activity of, 12.104  
   DNA sequencing  
     annealing primers to templates, 12.29  
     automated, 12.98  
     dye-primer sequencing, 12.96  
     materials for, 12.33–12.35  
     protocol, 12.35–12.36  
     pyrophosphatase use with, 12.34–12.36, 12.39  
     reaction mixtures, table of, 12.33  
     sequencing range, modifying, 12.37  
     steps involved, 12.32  
     troubleshooting, 12.38–12.39  
   inosine and, 12.110  
   Klenow compared, 12.32  
   in oligonucleotide-directed mutagenesis of single-stranded DNA, 13.15–13.17  
   overview of, 12.104–12.105  
   properties, table of compared, A4.11  
   versions of, 9.5, 12.104  
 Sequenase dilution buffer, 12.33, A1.9  
 Sequenase reaction buffer, 12.33–12.34  
 Sequencing. *See* DNA sequencing  
 Sequencing by hybridization (SBH), A10.17  
 Sequencing gels, resolving compressions in, 6.59  
 Sequin program, A11.3  
 SequiTherm, 12.46  
 Serine  
   codon usage, A7.3  
   nomenclature, A7.7  
   properties, table of, A7.9  
 Serum separation tubes (SST) for isolation of DNA from mouse tails, 6.26  
 71/18 *E. coli* strain  
   genotype, A3.6  
   M13 vectors and, 3.13  
   phagemids and, 3.42  
 Sex pili, M13 adsorption to, 3.5  
*SfiI*  
   fragment size created by, table of, A4.8  
   genomic DNA mapping, 5.68–5.69  
   site frequency in human genome, 4.16, A6.3  
*S* gene,  $\lambda$ , 2.15–2.16  
*SgrAI*  
   fragment size created by, table of, A4.8  
   site frequency in human genome, 4.16, A6.3  
 Shine-Dalgarno sequence  
   fortuitous, formation of, 15.12  
   *lacZ*, 15.57  
   in plasmid expression vectors, 1.13  
   translation efficiency and, 15.11–15.12, 15.18  
 Shotgun sequencing, 12.10–12.25  
   diagram of strategy, 12.12  
   DNA purification, 12.21–12.24  
   DNA repair, phosphorylation, and size selection, 12.17–12.18  
   enzymatic cleavage, 12.10–12.11  
   fragmentation of target DNA, 12.10–12.11, 12.15–12.17  
   growth of recombinants in 96-tube format, 12.19–12.21  
   hydrodynamic shearing, 12.10  
   ligation to vector DNA, 12.18–12.19  
   materials for, 12.13  
   number of sequences needed for coverage, 12.20  
   self-ligation of target DNA, 12.15  
   test ligations, 12.18, 12.25  
 Shrimp alkaline phosphatase (SAP), 1.95–1.96, 9.62–9.65, 9.92–9.93, A4.37  
   inactivation of, 1.96, 9.62, 9.64, 9.93  
   properties of, 9.93  
   RNA dephosphorylation, 9.65  
 sib-selection, 11.68–11.69  
 Sigmacote, 5.44, 12.75  
 Signal peptidase, 15.30  
 Silanizing solution, 12.75, 12.77, 12.112  
 Silica resins for DNA purification, 1.63, 5.26  
 Siliconizing fluid, 5.44  
 Siliconizing glassware, plasticware, and glass wool, A8.3  
 Silver emulsions, A9.9  
 Silver nitrate, 5.77, A8.48–A8.49  
 Silver staining, A9.5–A9.7  
   PFGE gels, 5.77  
   SDS-polyacrylamide gels, A8.46–A8.48  
 SilverSequence DNA Sequencing Kit, A9.6  
 SIM program, A11.5  
 Single nucleotide polymorphisms (SNPs), A10.3, A10.17  
 Single-strand-binding proteins in automated DNA sequencing protocols, 12.95

- Single-stranded conformation polymorphism (SSCP), 13.49–13.56, 13.91, 13.93  
 advantages/disadvantages, 13.52  
 amplification, 13.51, 13.53–13.54  
 denaturation, 13.51, 13.54  
 detection of mutants, 13.52, 13.55, 13.91, 13.93  
 dideoxy fingerprinting compared, 13.94  
 electrophoresis, 13.51, 13.55  
 materials, 13.52–13.53  
 mutation detection, 13.49  
 protocol, 13.53–13.55  
 restriction enzyme digestion and, 13.54–13.55  
 schematic diagram, 13.50  
 SYBR Gold stain as alternative to, 5.15  
 troubleshooting, 13.56
- Single-stranded DNA. *See also* M13 bacteriophage  
 alkaline agarose gel electrophoresis, 5.36–5.37  
 binding to DEAE-cellulose membranes, 5.19  
 calculating amount of 5' ends in a sample, 9.63  
 chemical mutagenesis of, 13.79  
 denaturing polyacrylamide gels, 5.40  
 end-labeling, 9.55  
 ethidium bromide binding, 5.14–5.15  
 exonuclease VII digestion of, 7.86  
 M13 DNA, preparation of, 3.26–3.29  
 mung bean digestion of, 7.87  
 nomogram for, A6.12  
 nuclease S1 cleavage of, A4.46  
 oligonucleotide-directed mutagenesis, 13.15–13.18
- PCR  
 production of radiolabeled probes, 7.54  
 SSCP, 13.51, 13.53–13.54  
 phagemids, 3.42–3.49  
 precipitation of, 3.29  
 radiolabeled probe production from M13  
 of defined length, 9.19–9.24  
 of heterogeneous length, 9.25–9.28  
 premature termination, 9.24  
 separation from double-stranded by hydroxyapatite chromatography, A8.32–A8.34  
 sequencing using Klenow fragment, 12.40–12.44  
 SYBR Gold binding, 5.15  
 uracil-containing, preparation of, 13.11–13.14
- Single-stranded DNA-binding protein, 12.44
- Site-directed mutagenesis. *See* Mutagenesis, site-directed
- Size markers. *See* Molecular-weight markers
- Size-exclusion chromatography, oligonucleotide purification by, 10.25–10.27
- SK promoter, primer sequence for, 8.117
- Slot hybridization of purified RNA, 7.46–7.50
- SM, A1.21
- SM buffer recipe, A2.8
- SM plus gelatin, A1.21
- Smul*  
 7-deaza-dGTP modified DNA, cleavage of, 8.60  
 fragment size created by, table of, A4.8  
 genomic DNA mapping, 5.69  
 linker use of, 1.99, 1.100  
 site frequency in human genome, 4.16, A6.3
- Small RNA database, A11.21
- SMR10 *E. coli* strain  
 genotype, A3.9  
 $\lambda$  vector propagation, 2.29
- SNET solution, 6.24
- snoRNA program, A11.15, A11.21
- SNPs. *See* Single nucleotide polymorphisms
- SNR6* promoter, 18.15
- Soaking solution in northern hybridization protocols, 7.36–7.37
- SOB medium recipe, A2.3
- SOC medium recipe, A2.3
- Sodium acetate, 6.26–6.27, A1.28  
 in ethanol precipitation of nucleic acids, A8.12  
 in RNA isolation protocols, 7.5, 7.10
- Sodium  
 azide, 14.4, 14.15, 14.23–14.27  
 bicarbonate, A1.6  
 butyrate, 16.14–16.15, 16.17–16.18  
 in electroporation protocol, 16.36  
 in transfection, using polybrene protocol, 16.44–16.45  
 carbonate, A1.6  
 chloride (NaCl), A1.27  
 in chemical sequencing protocols, 12.61–12.65  
 density gradient for  $\lambda$  arm purification, 2.71  
 in ethanol precipitation of nucleic acids, A8.12  
 ethanol/NaCl solution, 6.19–6.20  
 in mouse-tail lysis buffers, 6.26  
 nucleic acid contaminant fragment removal, 1.78–1.79  
 for protein expression optimization, 15.19  
 in SNET lysis buffer, 6.24–6.25  
 in transfection with polybrene, 16.43  
 in virus particle precipitation, 12.23  
 dodecyl sulfate (SDS). *See* SDS  
 hydroxide (NaOH), A1.6, A1.27  
 in chemical sequencing protocols, 12.61–12.65, 12.70–12.71  
 for DNA denaturation, 12.28, 12.30  
 iodide solution, 5.32  
 metabisulfite, 14.5, 14.16  
 molybdate for protein stability, 17.16  
 nitrite, A8.27  
 phosphate buffer, A1.5  
 pyrophosphate, 6.56, 7.45  
 inhibition of murine reverse transcriptase, 11.46  
 self-priming, inhibition of, 11.46  
 salicylate scintillant, A9.12
- Software. *See also* Bioinformatics; *specific software programs*  
 microarray image analysis, A10.13  
 Solid-phase radioimmunoassay (RIA), A9.29  
 Solution D (denaturing solution), 7.5  
 Sonication, A8.36–A8.37  
 calibration of the sonicator, A8.36  
 for cell lysis prior to affinity chromatography, 15.38, 15.46  
 of DNA, 12.11, 12.14, 12.15–12.16  
 liposome formation by, 16.7  
 Sorbitol buffer, 4.70–4.71, A1.21  
 Sos recruitment system (SRS), 18.126–18.127  
 South African National Bioinformatics STACK database, A10.15
- Southern hybridization, 1.28  
 advances in, 6.33–6.34  
 alkaline agarose gel, 5.38  
 background, 6.56  
 cDNA library screening, 11.38  
 CHEF gels, 5.82  
 DNA fixation to membranes, 6.45–6.46  
 DNA transfer methods  
 capillary transfer  
 downward, 6.35  
 protocol for, 6.39–6.46  
 to two membranes, 6.35–6.36, 6.47–6.49  
 upward, 6.34–6.35  
 electrophoretic transfer, 6.36  
 fixation of DNA to membranes, 6.45–6.46  
 membranes used for, 6.37–6.38  
 vacuum transfer, 6.37  
 DNase I hypersensitivity mapping, 17.21–17.22  
 electrophoresis buffer choice for, 5.8  
 genomic DNA preparation for, 6.3, 6.16, 6.19–6.21, 6.23  
 hybridization chambers, 6.51, 6.53–6.54  
 at low stringency, 6.58  
 nonradioactive labeling and, 9.76–9.80
- overview of, 6.33–6.38  
 radiolabeled probes, use of  
 low-stringency hybridization, 6.58  
 nonradioactive probes, 6.50  
 overview, 6.50  
 protocol, 6.51–6.55  
 hybridization, 6.54  
 prehybridization, 6.53–6.54  
 washing, 6.54–6.55  
 sensitivity, 6.50  
 stripping from membranes, 6.57  
 for restriction mapping of recombinant cosmids, 4.33  
 TAFE gels, 5.77–5.78  
 troubleshooting, 6.56  
 of YAC clones, 4.63
- Southwestern blotting, 14.32–14.33, 14.36
- Sp1 nuclear factor, 17.8, 17.11, 17.17
- SP6 bacteriophage  
 promoter, 1.11  
 addition to DNA fragments by PCR, 9.37  
 for eukaryotic expression vectors, 11.72  
 in  $\lambda$ ZipLox vector, 11.25  
 in P1 vectors, 4.38  
 primer sequence for, 8.117  
 sequence, 7.87, 9.87  
 RNA polymerase, 9.87–9.88, A4.28–A4.29  
 Spacers for sequencing gels, 12.76–12.78  
 SPAD (Signaling pathway database), A10.15  
 Specialized transducing bacteriophages, 2.18  
 Spectrophotometry, A8.19, A8.20–A8.21  
 DNA concentration measurement, 6.11, 6.15  
 quantitative, A9.4  
 RNA concentration estimation by, 7.8, 7.16
- SpeI*, A4.9  
 cleavage at end of DNA fragments, A6.4  
 fragment size created by, table of, A4.8  
 linker sequences, 1.99  
 site frequency in human genome, 4.16, A6.3
- Spermidine, 5.86, A1.28  
 in biolistic transfection protocol, 16.38, 16.40  
 DNA precipitation by, 9.34, 9.36  
 inhibition of PCR by, 8.13  
 in tissue homogenization buffer, 17.6, 17.25  
 in transcription buffer, 7.68, 7.71, 9.32, 9.34
- Spermine, 5.86, 17.6, 17.25
- SphI*, A4.9  
 cleavage at end of DNA fragments, A6.4  
 fragment size created by, table of, A4.8  
 in homopolymeric tailing protocols, 11.111  
 site frequency in human genome, 4.16, A6.3
- Spi* marker, 2.20–2.22
- Spin dialysis, 8.27
- Spliceosome, 18.123
- Splinkerettes, 4.10, 4.76
- Spooling DNA, 6.16–6.18, 6.61
- Spotfire Net image analysis program, A10.13
- Spreeta chip, 18.96
- Spun column chromatography, A8.30–A8.31. *See also* Chromatography; *specific protocols; specific resins*
- SRB, 1.15
- SrfI*  
 fragment size created by, table of, A4.8  
 linker sequences, 1.99  
 site frequency in human genome, 4.16, A6.3
- SSC  
 in dot/slot hybridization, 7.48–7.50  
 in northern hybridization protocols, 7.36, 7.42–7.44  
 recipe, A1.14  
 in Southern hybridization protocols, 6.41, 6.44–6.47, 6.49, 6.51–6.52, 6.55–6.58
- SSCP. *See* Single-stranded conformation polymorphism
- SseI* fragment size created by, table of, A4.8

- S-Sepharose, 15.6  
 SSPE, A1.14  
   in hybridization/prehybridization solutions, 10.35, 10.38  
   in Southern hybridization protocols, 6.51, 6.57  
*Sspl*, A4.9  
   fragment size created by, table of, A4.8  
   site frequency in human genome, 4.16, A6.3  
*SsrII* and genomic DNA mapping, 5.60, 5.69  
 Stability region (*cer*), 1.146  
 Staining  
   glyoxylated RNA, 7.27  
   nucleic acids, A9.3–A9.8  
     ethidium bromide, A9.3–A9.4  
     methylene blue, A9.4–A9.5  
     silver staining, A9.5–A9.7  
     SYBR dyes, A9.7–A9.8  
   SDS-polyacrylamide gels for proteins with Coomassie Brilliant Blue, A8.46–A8.47  
   during immunoblotting, A8.54  
   with silver salts, A8.46–A8.49  
   viability staining, A8.7–A8.8  
 Standing wave acousto-optic modulator (SW-AOM), 18.76–18.77  
*Staphylococcus aureus*  
   genomic resources for microarrays, A10.6  
   protein A. *See* Protein A  
 Starburst dendrimers and facilitation of DEAE transfection, 16.28  
 STE, A1.22  
 Sterol regulatory element-binding proteins (SREBPs), 17.11  
 STES lysis solution, 6.31, 18.39  
 STET, A1.16  
 Sticky ends. *See* Protruding termini  
 Storage media, A2.6  
 Storage of bacterial cultures, A8.5  
 Storm system, A10.11  
 Strains of *E. coli*. *See* *Escherichia coli* strains  
 Strand-separation gel electrophoresis, 7.51–7.52  
 StrataScript, 7.77, 8.48, 9.39  
 StrataScript RT, 11.38  
 Streptavidin, 9.76, 9.78, A9.45  
   BLAcore chips, 18.99  
   in direct selection of cDNAs protocol, 11.98–11.99, 11.103  
   magnetic beads and, 7.20, 11.118–11.119  
 Streptavidin bead-binding buffer, 11.100  
*Streptomyces avidinii*, A9.45  
*Streptomyces hygroscopicus*, 16.49  
 Streptomycin  
   modes of action, A2.7  
   stock/working solutions, A2.6  
 Stripping solution, 6.57  
 Stromelysin, 18.116  
 Stuffer fragment,  $\lambda$ . *See*  $\lambda$  vectors, replacement vectors  
 Substance P epitope tagging of, 17.92  
 Subtilisin, 9.82, 12.101, 15.8, A4.15  
 Subtracted cDNA probes, 11.29–11.31  
 Subtractive cloning, 11.10–11.11  
 Subtractive screening, 9.90–9.91  
 Sucrose  
   dialysis on bed of, 6.15  
   dye solution, 17.14  
   gel-loading buffer, 2.77–2.78, 2.81, 6.41–6.42  
   for protein expression optimization, 15.19  
 Sucrose gradients  
   cDNA fractionation, 11.9  
    $\lambda$  arm purification, 2.71–2.75  
   mRNA fractionation for cDNA preparation, 11.9  
   preparing, 2.81–2.82  
   size fractionation of genomic DNA, 2.81–2.82  
 Sulfindocyanine (Cy) dyes, 18.80. *See also* Cy3 dye; Cy5 dye  
 Sulfosalicylic acid, A8.46  
 Sulfuric acid, A1.6  
*SUP4*, 4.3, 4.59–4.60  
*supB*, A7.6  
*supC*, A7.6  
*supD*, A7.6  
*supE*, 11.23–11.24, A7.5, A7.6  
    $\lambda$  propagation and, 2.28–2.29  
   M13 vectors and, 3.11–3.13  
 SuperCos-1, 4.5, 4.12, 4.14, 4.18–4.19, A3.5  
 SuperFect, 16.5  
 Superinfection  
   frozen cultures, using, 3.47  
   phagemids/helper virus, 3.47  
 Supernatants, aspiration of, 1.33, 1.36, 1.45  
 SuperScript, 8.48, 11.12, 11.38  
 SuperScript II, 9.39, 11.38, 11.108  
*supF*, 2.23, 2.28–2.29, 11.23–11.24, 11.66, 14.37, 14.47, A7.5–A7.6  
 Supplemented minimal medium (SMM), A2.9–A2.10  
 Suppressor tRNA gene, 4.3  
 SURE *E. coli* strains, 1.15, 1.25  
 Surface plasmon resonance (SPR), 18.4, 18.96–18.114  
   concentration measurement, 18.102  
   data collection, 18.100–18.101  
   instruments of, 18.96  
   kinetic measurements, 18.101–18.102  
   overview, 18.97–18.98  
   protocol, 18.103–18.114  
     capture surface preparation, 18.105  
     data analysis, 18.112–18.114  
     design, 18.103  
     kinetic analysis, 18.108–18.114  
     test binding, 18.106–18.107  
     schematic of, 18.97  
     sensor chips, 18.98–18.100  
     regeneration of surface, 18.100  
 SurfZAP, A3.3  
 Suspension cultures, lysis of mammalian cells in, 637  
 SV40  
   COS cells and, 11.114  
   intron and polyadenylation signal in pTet vectors, 17.58  
   origin of replication, 11.68, 11.114, 17.49  
   T antigen, epitope tagging of, 17.92  
 SV40 promoter  
   in p $\beta$ -gal reporter vectors, 17.49  
   in pCAT3 vectors, 17.35  
   in pd2EGFP vectors, 17.88  
   in pGL3 vectors, 17.43  
   in pSPL3, 11.82, 11.85, 11.89  
   in pSV2CAT vector, 17.95  
*Swal*  
   fragment size created by, table of, A4.8  
   site frequency in human genome, 4.16, A6.3  
 Swiss Blue. *See* Methylene blue  
 SWISS\_PROT, A10.15  
 SYBR dyes, overview, A9.7–A9.8  
 SYBR Gold, 1.53, A9.7–A9.8  
   in agarose gel electrophoresis, 5.11, 5.15–5.16  
   photography, 5.16–5.17  
   polyacrylamide gel staining, 5.47–5.48  
   in quantitation of DNA, A8.24  
   removal from gels, 5.15  
   resolution of, 5.15  
   sensitivity of, 5.12  
   staining solution recipe, A1.29  
 SYBR Green, A9.7–A9.8  
   in real time PCR, 8.94, 8.95  
 Sybron SIL G/UV254 TLC plates, 17.38  
 Synthetic dextrose minimal medium (SD), A2.10  
 Synthetic minimal (SM) recipe, A2.9  
 SYSTEMS database, A11.22  
 T vectors  
   cloning PCR products into, 8.31, 8.35–8.36  
   creating, 8.35  
   stability of 3' unpaired residues, 8.36  
 T2 *dam* methylase, A4.7  
 T3 bacteriophage  
   promoter, 1.11, 1.13  
     addition to DNA fragments by PCR, 9.37  
     in cosmid vectors, 4.5, 4.33  
     for eukaryotic expression vectors, 11.72  
     in  $\lambda$ ZAP vectors, 11.22  
     in  $\lambda$ ZipLox vector, 11.25  
     primer sequence for, 8.117  
     in ribonuclease protection assay protocol, 7.69  
     sequence, 7.87, 9.37, 9.87  
   RNA polymerase, 9.87–9.88  
 T4 bacteriophage  
   DNA ligase, 1.157–1.158, 3.37, A4.31–A4.32, A4.34  
     activity of, A4.31  
     blunt end ligation, A4.32  
     cohesive termini/nick ligation, A4.32  
     inactivation, 1.102  
     inhibition by dATP, 1.85  
     linker/adaptor attachment to cDNA, 11.54  
     uses, list of, A4.31  
   DNA polymerase  
     3'-5' exonuclease activity, 11.121  
     polynucleotide kinase. *See* Polynucleotide kinase, bacteriophage T4  
   RNA ligase, 1.157  
 T4 *dam* methylase, A4.7  
 T5A3 gene, 2.21  
 T7 bacteriophage  
   DNA polymerase in DNA sequencing  
     automated, 12.98  
     dye-primer sequencing, 12.96  
   promoter, 1.11–1.13, A4.28  
     addition to DNA fragments by PCR, 9.37  
     in cosmid vectors, 4.5, 4.33  
     for eukaryotic expression vectors, 11.72  
     for expression of cloned genes in *E. coli*, 15.3–15.4, 15.20–15.24  
     large-scale expression, 15.24  
     materials for, 15.22  
     optimization, 15.23–15.24  
     overview, 15.20–15.22  
     protocol, 15.23–15.24  
     regulation by lysozyme, 15.24  
   in  $\lambda$ ZAP vectors, 11.22  
   in  $\lambda$ ZipLox vector, 11.25  
   in M13-100 vector, 3.10  
   in P1 vectors, 4.38  
   primer sequence for, 8.117  
   in ribonuclease protection assay protocol, 7.69  
     sequence, 7.87, 9.37, 9.87  
     protein interaction network in, 18.123  
   RNA polymerase, 9.87–9.88  
     in binary expression systems, 9.88  
     lysozyme inhibition of, 9.88  
 T7-Tag, epitope tagging, 17.93  
*tac* promoter, 15.3, 15.40  
 TAE. *See* Tris-acetate-EDTA electrophoresis buffer  
 TAFE. *See* Transverse alternating field electrophoresis  
 TAFE gel electrophoresis buffer, A1.18  
 TAIL PCR, 4.75  
 Tailing reaction  
   in 5'-RACE procedure, 8.58–8.59  
   in cDNA cloning, 11.3–11.4, 11.15  
   digoxigenin labeling of nucleic acids, A9.38–A9.39  
   homopolymers, 11.110–11.111  
   terminal transferase and, 8.111  
 Talon, 15.46

- Tamra, 8.95
- TAP90 *E. coli* strain  
 genotype, A3.9  
 $\lambda$  vector propagation, 2.28
- Tape, gel-sealing, 12.76, 12.78
- Taq dilution buffer, 12.48, A1.9
- Taq DNA polymerase, 8.4, 8.6–8.7, 8.10, A4.22–A4.23. *See also* AmpliTaq DNA polymerase; DNA polymerase, thermostable  
 for cDNA second-strand synthesis, 11.14  
 in differential display-PCR, 8.98  
 digoxigenin labeling of nucleic acids, A9.38–A9.39  
 in DNA sequencing, 12.45–12.50  
 automated, 12.98  
 dye-primer sequencing, 12.96  
 materials for, 12.48–12.49  
 method, 12.49–12.50  
 overview, 12.45–12.47  
 reaction mixtures, table of, 12.48  
 steps involved, 12.47  
 version of Taq, 12.46–12.47  
 error rate, 8.108–8.109  
 in exon trapping, 11.91–11.93  
 heat tolerance of, 8.8  
 incorrect base incorporation, 8.77  
 inhibition by dyes, 1.53  
 in-house preparation, 8.108–8.109  
 inosine and, 12.109  
 in megaprimer PCR mutagenesis method, 13.33  
 in misincorporation mutagenesis, 13.80  
 overview of, 8.108–8.109  
 polymerization rate, 8.9  
 properties of, 8.10, 8.108, A4.11, A4.23  
 rapid screening of bacterial colonies or  $\lambda$  plaques by PCR, 8.74–8.75  
 in RT-PCR, 8.49  
 site-directed mutagenesis, oligonucleotide design for, 13.82  
 stability of, 8.25, 8.30, 8.108  
 Stoffel fragment, 8.109  
 storage, 8.19  
 temperature optimum, 8.9  
 terminal transferase activity, template-independent, 8.30, 8.35  
 variations in preparations of, 8.6
- Taq gene, 8.108–8.109
- TaqEXPRESS, 12.46
- TaqI, 13.87, A4.3, A4.9
- TaqI methylase, A4.5, A4.7
- TaqMan method of real time PCR, 8.95
- TaqPlus  
 in circular mutagenesis, 13.20  
 Long PCR System, 8.7, 8.77
- TaqStart, 8.110
- Taqenase  
 in cycle sequencing reactions, 12.46–12.47  
 structure of, 12.47
- tat gene, HIV, 11.82
- Taurine in electrophoresis buffers, 12.108, 13.90
- TBE. *See* Tris-borate-EDTA electrophoresis buffer
- Tbr DNA polymerase, 8.7, 8.10, A4.23
- TE (Tris EDTA) buffer, A1.7
- TEACI. *See* Tetraethylammonium chloride
- Tecan GENESIS sample processor, A10.5
- Telomeric repeat (TEL) sequences in YACs, 4.59
- TEMED (N,N,N',N'-tetramethylethylene diamine), 5.41, 5.43, 5.45, 12.75, 12.79, 12.82, 13.53–13.54, A8.42
- Temperate bacteriophages, 2.9. *See also*  $\lambda$ ; P1
- TEN buffer, A1.22
- Terminal deoxynucleotidyl transferase, A4.27  
 activity in DNA polymerases, 8.30, 8.35  
 in cDNA second-strand synthesis, 11.17  
 digoxigenin labeling of nucleic acids, A9.38–A9.39  
 in end-labeling, 9.55–9.56  
 for chemical sequencing of DNA, 12.73  
 homopolymeric tailing, 11.110  
 inactivation of, 8.59  
 in lymphocytes, 8.112  
 overview of, 8.111–8.112  
 5'-RACE protocol, 8.54–8.60  
 requirements of, 8.111
- Terminal transferase. *See* Terminal deoxynucleotidyl transferase
- Terminal transferase buffer, A1.11
- Terminal transferase (tailing) buffer, A1.11–A1.12
- Terminase,  $\lambda$ , 2.15, 4.5, 4.30
- Terrific Broth recipe, A2.4
- TES, A1.22
- TESS (Transcription Element Search System) program, A11.13
- TetA, 17.53
- tetO, 17.53–17.58
- tetP, 17.57
- TetR, 17.53–17.56, 18.11
- Tetracycline, 1.9  
 electroporation efficiency of tet-resistant transformants, 1.26  
 entry into cells, 17.53  
 mechanism of action, 17.53  
 mechanism of resistance to, 1.147  
 modes of action, A2.7  
 for protein expression optimization, 15.19  
 regulation of inducible gene expression, 17.52–17.70  
 autoregulatory system, 17.56, 17.70  
 reduced basal activity, 17.56–17.59  
 repression system, 17.54  
 reversed activator, 17.55–17.56  
 schematic representation of repression system, 17.54  
 Stage 1: Stable transfection of fibroblasts pTet-tTAK, 17.60–17.64  
 Stage 2: Stable transfection of inducible t-TA-expressing NIH-3T3 cells with tetracycline-regulated target genes, 17.65–17.69  
 Stage 3: Analysis of protein expression in transfected cells, 17.68–17.69  
 trans-activator, 17.54–17.55  
 in transiently transfected cells using the autoregulatory tTA system, 17.70  
 troubleshooting, 17.59  
 resistance, 17.53  
 selecting transformants, 1.110, 1.115, 1.118  
 structure of, 1.146, 17.52–17.53
- Tetracycline repressor (TetR), 17.53–17.56, 18.11
- Tetracycline resistance (tet<sup>r</sup>), 1.9, 1.147  
 in  $\lambda$ ZAP, 14.6  
 mechanism of resistance, 1.147  
 in positive selection vectors, 1.12
- Tetracycline-responsive element (TRE), 17.32
- Tetracycline stock/working solutions, A2.6
- Tetraethylammonium chloride (TEACI), 10.6, 10.35–10.37
- Tetrahymena, 4.59
- Tetramethylammonium chloride (TMACI), 8.9, 10.6, 10.35–10.37
- 3,3', 5,5'-tetramethylbenzidine (TMB), A9.35
- TEV (tobacco etch virus) protease, 15.8
- Texas Red, A9.33
- TFASTX/TFASTY program, A11.19
- TFBIND program, A11.13
- Tfi DNA polymerase, 8.10, A4.23
- Tfx, 16.5, 16.7, 16.11
- TG1 *E. coli* strain, 13.12–13.13  
 cell-wall component shedding and DNA purification, 1.18  
 genotype, A3.9  
 M13 vectors and, 3.12, 3.16
- TG2 *E. coli* strain  
 genotype, A3.9  
 M13 vectors and, 3.12
- M13 vectors and, 3.12  
 phagemids and, 3.44
- Thermal asymmetric interlaced (TAIL) PCR, 4.75
- Thermal cycle DNA sequencing. *See* Cycle DNA sequencing
- Thermal cycler, 8.19–8.22, 8.112. *See also* Polymerase Chain Reaction
- ThermoSequenase  
 in DNA sequencing  
 automated, 12.98  
 cycle sequencing reactions, 12.46–12.47  
 dye-primer sequencing, 12.96  
 inosine and, 12.110  
 structure of, 12.47
- Thermostable DNA polymerases. *See* DNA polymerase, thermostable; *specific polymerases*
- Thermus aquaticus*, 8.4, 8.6–8.7, A4.22. *See also* Taq DNA polymerase
- $\theta$  (Theta) structures, 1.6, 2.11–2.12, 3.2
- Thin-layer Chromatography (TLC) for CAT measurement in extracts from mammalian cells, 17.36–17.39
- Thionucleotides, resistance to exonuclease III, 13.75
- Thiopropyl-Sepharose, 15.6
- Thioredoxin, 14.47, 15.9, 15.26
- Thiourea, 17.12
- 3B3, epitope tagging, 17.93
- 3D-Ali database, A11.22
- Threonine  
 codon usage, A7.3  
 nomenclature, A7.7  
 properties, table of, A7.9
- Thrombin, 15.39–15.40, 15.43
- Thymidine, hydrazine cleavage of, 13.78
- Thymidine glycosylase, 13.94
- Thymidine kinase gene, 1.15, 16.47–16.48, 17.33
- Thymine, A6.9  
 carbodiimide modification, 13.95  
 osmium tetroxide modification of, 13.95  
 related compounds (Table A6-8), A6.9  
 structure, A6.9
- Thyroglobulin for protein stability, 17.16
- Thyroid receptor resource database, A11.21
- Thyroid-stimulating hormone (TSH), 18.104–18.114
- TIGR Gene Indices, A10.15
- TIGR Spotfinder image analysis program, A10.13
- TIMP-2, A5.1
- Tissue homogenization buffer, 17.6, 17.25
- Tissue microarrays, A10.18
- Tissue plasminogen activators, 18.116
- Tissue resuspension buffer, 17.6
- Tissues  
 DNA isolation  
 hemoglobin contamination, 6.7–6.8, 6.17–6.18  
 from mouse tails, 6.23–6.27  
 for pulsed-field gel electrophoresis, 5.61–5.64  
 homogenization of, 6.7–6.8  
 lysis of, 6.7–6.8, 6.17  
 nuclear extract preparation from, 17.8–17.9  
 RNA, DNA, and protein simultaneous preparation, 7.9–7.12  
 RNA isolation by acid phenol-guanidinium thiocyanate-chloroform extraction, 7.4–7.8
- TKM buffer, 11.87
- TLCK, A5.1
- Tli DNA polymerase, A4.23
- ThiVent DNA polymerase, 8.11
- TM buffer recipe, A2.8
- TMACI. *See* Tetramethylammonium chloride
- TMB. *See* 3,3', 5,5'-tetramethylbenzidine
- tmRNA database, A11.22
- TM-TPS, 16.11
- Tn9 transposon, 13.88

- IN1 buffer, 14.5, 14.8–14.9, 14.15, 14.18–14.19  
 IolA/IolR/IolQ proteins, 3.6  
 IolD and Oligonucleotide Calculator program, 13.89  
 Tomtec, Quadra, A10.5  
 Iotopick minipreparations of plasmid DNA, 1.51–1.54  
 Topoisomerase I (Topo I), 1.4, 2.16, A4.52  
 Tosyl-lysine-chloromethyl ketone as protease inhibitor, 15.19  
 Touchdown PCR, 8.112  
   in MOPAC protocol, 8.70  
   multiplex PCR, 8.107  
   quantitative PCR, 8.89  
 Toxic proteins  
   choosing appropriate strain of *E. coli*, 1.15  
   low-copy-number plasmid vectors, 1.12  
 TPCK, A5.1  
 TPE. See Tris-phosphate-EDTA electrophoresis buffer  
*trnA* gene, 4.49  
 Tracking dyes  
   in denaturing agarose gels, 7.23  
   in polyacrylamide gels, 7.57  
*trnD36*, 3.10, 3.12–3.13  
 Trn<sup>35</sup>S-label, 15.18  
 Transcription buffer, 7.68, 7.71, 9.32  
 Transcription factor E2F1, 18.11  
 Transcription factor GATA-1 in positive selection vectors, 1.12  
 Transcription factors, screening cDNA libraries for, 11.33  
 Transcriptional activation domain  
   activation domain fusion plasmids, 18.20  
   two-hybrid system and, 18.6, 18.14, 18.20, 18.36  
 Transcriptional run-on assays, 17.23–17.29  
   materials for, 17.24–17.26  
   nuclei isolation, 17.26–17.27  
   from cultured cells, 17.26  
   from tissue, 17.27  
   overview of, 17.23–17.24  
   radiolabeling transcripts  
     from cultured cell nuclei, 17.27  
     from tissue nuclei, 17.27–17.28  
 Transcriptional silencers (TTS), 17.56  
 Transduction of the P1 recombinant plasmid, 4.46  
 Transfac program, A11.12  
 Transfast transfection, 16.5  
 Transfectam, 16.5, 16.8–16.9, 16.11  
 Transfection, 16.1–16.57  
   biolistics, 16.3, 16.37–16.41  
     materials for, 16.38–16.39  
     method, 16.39–16.41  
     particle types, 16.37  
     variables, 16.37  
   calcium-phosphate-mediated, 16.3, 16.14–16.26, 16.52–16.53  
     of adherent, 16.25  
     of cells growing in suspension, 16.25  
     chloroquine treatment, 16.14, 16.17, 16.52  
     cotransformation, 16.24  
     efficiency, factors affecting, 16.52  
     with genomic DNA, 16.21–16.24  
     glycerol shock, 16.14, 16.17, 16.52  
     high efficiency, 16.19  
     mutation prevalence, 16.53  
     with plasmid DNA, 16.14–16.20  
     sodium butyrate, 16.14, 16.17–16.18  
   cell line variation, 16.57  
   controls, 16.4–16.5  
     for stable expression, 16.4–16.5  
     for transient expression, 16.4  
   cotransformation, 16.24, 16.47  
   by DEAE-dextran, 16.3, 16.27–16.32  
     calcium phosphate method compared, 16.27  
     cell viability, increasing, 16.32  
     facilitators of, 16.28  
     kits, 16.30  
     materials for, 16.29–16.30  
     mechanism of action, 16.27  
     method, 16.30–16.31  
     mutation prevalence, 16.28, 16.53  
     variables, 16.27–16.28  
   electroporation  
     efficiency, factors influencing, 16.33–16.34, 16.57  
     of mammalian cells, 16.3, 16.33–16.36, 16.54–16.57  
     materials for, 16.34–16.35  
     method, 16.35–16.36  
   for FLIM-FRET analysis, 18.84–18.86  
   by lipofection, 16.3, 16.7–16.13  
     chemistry of, 16.50  
     lipids used in, 16.8, 16.11, 16.51  
     materials for, 16.7–16.11  
     optimizing, 16.51  
     overview of, 16.50–16.51  
     protocol, 16.12–16.13  
     methods, summary of, 16.3  
     polybrene, 16.3, 16.43–16.46  
     stable, selective agents for, 16.48–16.49  
   tetracycline regulation of inducible gene expression and, 17.60–17.70  
   transient vs. stable, 16.2  
 Transfection Reagent Optimization System, 16.7  
 Transfection Reagent Selector Kit, 16.5  
 Transfer buffers  
   for alkaline transfer of RNA to charged membranes, 7.36, 7.38  
   in Southern hybridization, 6.40–6.41, 6.44, 6.46–6.47, 6.49  
 Transformation. See also Transfection  
   of blunt-ended fragment ligations, 1.92  
   cell density and, 1.108, 1.112, 1.114, 1.117, 1.120–1.121  
   cell preparation, 1.107–1.109, 1.113–1.114, 1.117–1.118  
   controls, 1.111  
   in directional cloning procedures, 1.87  
   DnD solution, 1.106, 1.109  
   by electroporation, 1.25–1.26, 1.119–1.122  
   freezing of competent cells, 1.114–1.115  
   frozen storage buffer, 1.106, 1.108  
   glassware cleanliness and efficiency of, 1.105–1.106  
   Hanahan method, 1.105–1.110  
   Inoue method, 1.112–1.115  
   in M13 cloning, 3.37–3.38  
   of mammalian cells by YACs, 4.63–4.64  
   overview, 1.24–1.26  
   plasmid size and efficiency, 1.9  
   of plasmids with inverted repeats, 1.15  
   strain of *E. coli*, choosing appropriate, 1.14–1.15  
   using calcium chloride, 1.116–1.118  
   yeast spheroplasts, 4.60  
 Transformation buffer, 1.106–1.107  
 Transformer kit, 13.27  
 Transformer site-directed mutagenesis kit, 13.89  
 Transition mutations, 13.78  
 Translation initiation, optimization of, 15.11–15.12  
 Translational coupling, 15.12  
 Transposons and kanamycin resistance, 1.145  
 Transverse alternating field electrophoresis (TAFE), 5.56–5.57, 5.74–5.78  
   electrode configuration, 5.57  
   high-capacity vector insert size determination, 4.18  
   method, 5.76–5.78  
   pulse times, 5.74–5.75  
   resolution, 5.74  
   silver staining, 5.77  
   Southern blots, 5.77–5.78  
*trc* promoter, 15.3  
 TreeView program, A10.15  
 TRI reagent, 7.10  
 Triazol reagent, 7.10  
 Trichloroacetic acid (TCA), A1.29  
   in oligonucleotide synthesis, 10.42, 10.49  
   polyacrylamide gel fixation, 7.56, 7.61–7.62, 7.68  
   precipitation of nucleic acids with, A8.25–A8.26  
 Trifluoroacetic acid, A9.32  
 Tris buffers  
   deficiencies of, A1.3  
   general, A1.2  
   preparation with various pH values, table of, A1.2  
 Tris-Cl, A1.7  
 Tris EDTA (TE) buffer, A1.7  
 Tris magnesium buffer (TM), A1.8  
 Tris-acetate-EDTA (TAE) electrophoresis buffer, 5.8, 5.76, A1.17  
 Tris-borate-EDTA (TBE) electrophoresis buffer, 5.8, 12.75, 12.84, 12.87  
   ligation reaction inhibition, 5.30  
   polyacrylamide gel electrophoresis, 5.43  
   for pulsed-field gel electrophoresis, 5.60  
   recipe, A1.17  
   in SSCP protocol, 13.52  
   for TAFE, 5.76  
 Tris-buffered saline (TBS), A1.8  
 Tris-buffered saline with dextrose (TBS-D), 16.29–16.31  
 Tris-glycine, A1.17  
 Tris-glycine electrophoresis buffer, A8.42–A8.43  
 Tris-phosphate-EDTA (TPE) electrophoresis buffer, 5.8, A1.17  
 Tris-SDS chromatography buffer, 10.25–10.26  
 Tris-sucrose, A1.22  
 Triton X-100  
   in cell lysis buffers, 17.36, 17.44–17.45  
   inclusion bodies recovery using, 15.51  
   luciferase and, A9.22  
   in preparation of fixed cells for FLIM-FRET analysis, 18.87  
   for solubilization of GST fusion proteins, 15.38–15.39  
   in supershift assays, 17.17  
   in washing solution for inclusion bodies, 15.10  
 Triton/SDS solution, 4.68, A1.22  
 tRNA carrier RNA, 7.69  
 tRNA genes, higher-plant mitochondria database, A11.21  
 tRNA suppressor, A7.5  
 tRNAscan-SE program, A11.15  
*trp* promoter, 15.3  
*TRP1*, 4.3, 4.60, 18.20, 18.22, 18.43  
*trpC* mutation, 18.43  
*trpE* gene, 11.109  
 TRRD (Transcriptional Regulatory Region Database), A11.20  
*trx* gene, *E. coli*, 12.104  
 Trypan blue dye, 17.20  
 Trypanosomes, 1.150, A9.3  
 Trypsin, 15.8, 16.12, 18.66–18.68, A1.8  
 Tryptophan  
   auxotrophy and YAC vectors, 4.60, 4.65  
   codon usage, A7.3  
   nomenclature, A7.7  
   properties, table of, A7.9  
 Tryptophan-inducible expression systems, 15.25–15.26, 15.28–15.29  
 TSSG program, A11.13  
 TSSW program, A11.13, A11.20  
 (TA (trans-Transcriptional Activator), 17.54–17.60, 17.64–17.65, 17.70  
*Tth* DNA polymerase, 8.10, 8.48  
   for cDNA second-strand synthesis, 11.14  
   in circular mutagenesis, 13.20

- in overlap extension method of mutagenesis, 13.37  
 properties, table of, A4.23  
*Tth*Hbl, A4.9  
*tTh*Start, 8.110  
*Tth* polymerase, 8.10  
 Tungsten in biolistics, 16.38–16.39  
 Tween-20  
 in blocking buffer, 14.4, 14.15, 14.23, 14.26  
 in DNA sequencing protocols, 12.55  
 in PCR lysis solution, 6.22  
 for solubilization of GST fusion proteins, 15.38–15.39  
 in supershift assays, 17.17  
 in TNT buffer, 14.5, 14.13  
 Two-hybrid system. *See* Protein-protein interactions, two-hybrid system  
 Tyrosine  
 codon usage, A7.3  
 Lck tyrosine kinase, 18.7  
 nomenclature, A7.7  
 phosphorylation, 14.2  
 properties, table of, A7.9  
 Tyrosine kinase, 18.7  
 Ubiquitin-based split-protein sensor (USPS)  
 method, 18.125–18.126  
 UDG system, 11.105  
*U* gene,  $\lambda$ , 2.15  
*U**Th* DNA polymerase, 8.10, A4.23  
 Ultraspiracle protein (USP), 17.71  
 Ultraviolet (UV) radiation  
 damage to DNA, 1.67, 1.151, 5.20, 5.24  
 DNA fixation to membranes by, 1.135, 1.137, 2.94–2.95, 6.46, 7.36  
 ethidium bromide fluorescence, 1.151  
 inactivation of contaminating DNA in PCRs, 8.16–8.17  
 oligonucleotide visualization in polyacrylamide gels, 10.16  
 photography of DNA in gels, 5.16–5.17  
 RNA fixation to nylon membranes by, 7.40  
*uvrC* gene, 1.15  
*uvrC*, 13.11–13.15, 13.77, 13.84–13.85  
 UniGene, 10.15, A10.4  
 Unique restriction site elimination (USE). *See* USE mutagenesis  
 Universal bases, 10.9–10.10, 11.32  
 Universal KGB (restriction endonuclease buffer), 8.32, A1.12  
 Universal primers, 8.113–8.117  
 for  $\lambda$ gt10/ $\lambda$ gt11, 8.116  
 for M13 vectors, 8.115  
 for pBR322, 8.114  
 for pUC vectors, 8.115  
 transcription promoter primers, 8.117  
 Uni-ZAP in commercial kits for cDNA synthesis, 11.108  
 URA3, 4.3, 4.60, 18.11–18.12, 18.22  
 Uracil, A6.9  
 auxotrophy and YAC vectors, 4.60, 4.65  
 related compounds (Table A6-9), A6.9  
 structure, A6.9  
 Uracil DNA glycosylase (UDG), 8.17, 11.121–11.123, 13.79, 13.84, A4.51  
 Uracil tryptophan drop-out medium, 4.65  
 Uracil-substituted DNA, preparation of M13, 13.11–13.14  
 Uranyl salts, 17.77  
 Urea  
 denaturing fusion proteins with, 15.7  
 in denaturing polyacrylamide gels, 7.58, 12.74, 12.78  
 inclusion bodies recovery using, 15.52  
 solubilization of, 12.78  
 for solubilization of inclusion bodies, 15.54  
 Urease antibody conjugates, A9.34  
 uRNA database, A11.22  
 USE mutagenesis, 13.26–13.30, 13.85, 13.89  
 UTP, digoxigenin coupled, A9.38  
 UV light. *See* Ultraviolet (UV) radiation  
*uvrC* gene, 1.15  
 V protein,  $\lambda$ , 2.15  
 V8 protease, 18.64  
 Vacuum aspiration, 6.10  
 Vacuum transfer of DNA to membranes, 6.37  
 Valine  
 codon usage, A7.3  
 nomenclature, A7.7  
 properties, table of, A7.9  
 Vanadyl ribonucleoside complexes, 7.83  
 VCSM13, 3.44, 18.116  
 Vector alignment search tool (VAST), A11.22  
 Vectorette PCR, 4.10, 4.74–4.81  
 protocol method, 4.78–4.81  
 rescuing termini of YAC genomic inserts, 4.63  
 scheme, diagram of, 4.77  
 splinkerettes, 4.76  
 Vectors. *See also* Cosmids; Expression vectors;  $\lambda$  vectors; M13 vectors; Plasmid vectors; Vectors, high-capacity; *specific vectors*  
 phagemids, 3.42–3.49  
 positive selection, 1.12  
 table of, A3.2–A3.5  
 $\lambda$ , A3.3  
 mammalian, A3.3–A3.4  
 plasmid/phagemid, A3.2–A3.3  
 shuttle vectors, A3.4–A3.5  
 yeast, A3.4  
 Vectors, high-capacity, 4.1–4.86. *See also specific vectors*  
 BACs, 4.2, 4.58–4.73  
 bacterial P1, 4.4, 4.35–4.47  
 cosmids, 4.4–4.5, 4.11–4.34  
 genomic library construction  
 arrayed libraries, 4.8  
 chromosome walking, 4.8–4.10  
 overview, 4.6–4.7  
 vector choice, factors influencing, 4.7–4.10  
 insert size measurement by pulsed-field gel electrophoresis, 4.18  
 large DNA fragment cloning products and services, 4.86  
 P1 artificial chromosomes, 4.4, 4.40–4.44  
 table of, 4.2  
 vectorette PCR isolation of genomic ends, 4.74–4.81  
 YACs, 4.2, 4.58–4.73  
*Vent* DNA polymerase, 8.85  
*VentR* DNA polymerase, 13.37  
 Vesicular stomatitis virus (VSV) G protein, epitope tagging, 17.93  
 Viability staining, A8.7–A8.8  
*Vibrio harveyi*, A9.21, A9.23  
 Vienna RNA package program, A11.15  
 Viroid and viroid-like RNA sequence database, A11.22  
 Virus. *See* Bacteriophages  
 Vitamin H. *See* Biotin  
 von Hippel-Lindau tumor suppressor protein (pVHL), 18.60, 18.62  
 Wallace Rule, 10.3  
 Wash buffer (Qiagen), A1.22  
 Wash solutions. *See specific protocols; specific solutions*  
 wconsensus program, A11.14  
 Webin program, A11.3  
 Wedge gels, 12.83  
 Weiss unit of ligase activity, 1.159  
 Western blotting, A9.28  
 in coimmunoprecipitation protocol, 18.63  
 epitope tagging, 17.91  
 ubiquitin-based split-protein sensor (USPS)  
 method, 18.125  
 Whatman 3MM CHR paper for polyacrylamide gel drying, 12.92  
 Whatman 541 filter papers for screening bacterial colonies by hybridization, 1.126  
 White blood cells, DNA isolation from, 5.63–5.64  
 WIT database, A10.15  
 Wizard, 1.64  
 Wizard PCR Preps Purification System, 8.26–8.27  
 WU-BLAST (Washington University BLAST) program, A11.19  
 Xanthine, structure of, A6–10  
 Xanthine monophosphate (XMP), 16.49  
 Xanthine oxidase  
 chemiluminescent enzyme assay, A9.19  
 as digoxigenin reporter enzyme, 9.77  
 Xanthine-guanine phosphoribosyltransferase, 16.47  
*Xba*I  
 7-deaza-dGTP modified DNA, cleavage of, 8.60  
 cleavage at end of DNA fragments, A6.4  
*dam* methylation and, 13.87, A4.3  
 fragment size created by, table of, A4.8  
 linker sequences, 1.99  
 site frequency in human genome, 4.16, A6.3  
 terminal/subterminal site cleavage, inefficient, 8.38  
*Xcm*I for T vector creation, 8.35  
*Xenopus* oocytes, 11.68, 11.75–11.76, 11.78  
 controls, experimental, 11.70  
 vector systems for, 11.72  
 X-gal, 1.27, 17.97, 17.99  
 $\alpha$ -complementation and, 1.150  
 direct addition to plates, 1.125  
 in histochemical stain, 16.13  
 history of, 1.150  
 in  $\lambda$  vector plaque-assay, 2.30  
 protocol for use in screening colonies, 1.123–1.125, 1.150  
 recipe, A1.29  
 in two-hybrid system of protein-protein interaction study, 18.24–18.25, 18.36–18.37  
 use in pUC vectors, 1.10  
 use with M13 vectors, 3.8, 3.19, 3.38  
 in yeast selective X-gal medium, 18.18, 18.31, 18.40  
 X-gal indicator plates for yeast, A2.10–A2.11  
 X-gal plates for lysed yeast cells on filters, A2.11  
 X-GlcA (5-bromo-4-chloro-3-indolyl- $\beta$ -D-glucuronide), 16.42  
*Xho*I  
 cDNA adaptors and, 11.51  
 cDNA protection against, 11.40  
 cleavage at end of DNA fragments, A6.4  
 fragment size created by, table of, A4.8  
 genomic DNA mapping, 5.69  
 linker sequences, 1.99  
 methylation, A4.7  
 regeneration of site, 1.100  
 site frequency in human genome, 4.16, A6.3  
 terminal/subterminal site cleavage, inefficient, 8.38  
*Xho*II, *dam* methylation and, 13.87, A4.3  
 XL1-Blue *E. coli* strain, 11.23–11.25, 11.61–11.62, 11.66, 14.6  
 genotype, A3.9–A3.10  
 $\lambda$  vector propagation, 2.29  
 for M13, 12.21, 12.23  
 M13 vectors and, 3.12, 3.16, 3.18  
 phagemids and, 3.42, 3.46  
 XL1-Blue MRF' *E. coli* strain, 11.25  
 in circular mutagenesis protocol, 13.25  
 genotype, A3.10  
 M13 vectors and, 3.13

- phagemids and, 3.42, 3.46
- XL1-Blue MRF<sup>+</sup> Kan strain, 3.18
- Xma*I, A4.7, A6.4
- Xmn*I, A4.9
- Xor*II, A4.7
- XS101 *E. coli* strain
  - M13 vectors and, 3.13
  - phagemids and, 3.42
- XS127 *E. coli* strain
  - genotype, A3.10
  - M13 vectors and, 3.12
  - phagemids and, 3.42
- xseA* gene, 7.86
- xseB* gene, 7.86
- xth* gene of *E. coli*, 13.73
- Xylene cyanol FF
  - in agarose gel electrophoresis gel-loading buffers, 1.53, 5.9
  - in denaturing agarose gels, 7.23
  - in formaldehyde gel-loading buffer, 7.32
  - in formamide dye mix, 7.77, 17.6
  - inhibition of PCR by, 8.13
  - migration rate through polyacrylamide gels, 12.89
  - oligonucleotide size and comigration in polyacrylamide, 10.15
  - polyacrylamide gel electrophoresis, 5.42, 7.57
  - in RNA gel-loading buffer, 7.68
  - in sucrose dye solution, 17.14
  - Taq* polymerase inhibition by, 1.53
- Y1089 *E. coli* strain, 15.19
  - for fusion protein expression, 14.39, 14.48
  - genotype, A3.10
- Y1090 *E. coli* strain, 15.19
- Y1090*hsdR* *E. coli* strain, 11.59–11.60, 11.62, 11.66, 14.6, 14.27
  - for fusion protein expression, 14.37, 14.39, 14.42, 14.45, 14.47–14.48
  - genotype, A3.10
  - $\lambda$  vector propagation, 2.28
- Y1090(ZL) *E. coli* strain, 11.61–11.62, 11.66
- YAC. See Yeast artificial chromosomes (YACs)
- YCp (yeast centromere plasmid), A3.5
- Yeast. See also *Saccharomyces cerevisiae*; Yeast artificial chromosomes
  - carrier tRNA, 5.20
  - DNA
    - isolation, rapid protocol, 6.31–6.32
    - preparation for pulsed-field gel electrophoresis, 5.65–5.67
  - gene expression patterns and microarray technology, A10.2
  - genomic resources for microarrays, A10.6
  - lysis buffer, 5.66
  - media, 4.65
  - media for the propagation and selection of, A2.9–A2.11
  - resuspension buffer, A1.22
  - screening colonies by PCR, 8.75
  - selective X-gal medium, 18.18, 18.31, 18.40
  - splice sites database, A11.20
  - tRNA as carrier in ethanol precipitation of DNA, A8.13
  - vectors, A3.4
- Yeast artificial chromosomes (YACs), 4.58–4.73, A3.4
  - arrayed libraries, 4.8
  - CEPH Mega YAC Library, 4.9
  - chimeric clones, 4.10, 4.62
  - detection of, 4.61
  - frequency of, 4.62
  - choosing for genomic library construction, 4.7–4.10
  - DNA preparation, 4.67–4.71
    - small-scale, 4.70–4.71
  - features of, 4.58–4.60
  - genomic libraries
    - characterization, 4.61
    - construction, 4.60
    - mapping inserts, 4.63
    - rescuing termini of genomic DNAs, 4.63
    - screening, 4.61–4.62
    - subcloning from, 4.64
  - growth of cultures from, 4.64–4.66
  - insert size, 4.61
  - instability and rearrangement, 4.61–4.62
  - overview, 4.2, 4.58
  - PCR analysis of yeast colonies, 4.72–4.73
  - preparation for pulsed-field gel electrophoresis, 5.65–5.67
  - problems with, 4.61–4.63
  - purification, 4.62–4.63
  - retrofitting with selectable marker, 4.63–4.64
  - screening recombinants, 4.60
  - stability of cloned sequences, 4.10
  - storage of yeast cultures, 4.66
  - subcloning inserts from, 4.64
  - transformation, 4.60, 4.63–4.64
- YEp (yeast episomal plasmid), A3.5
- YIp (yeast integrating plasmid), A3.4
- YK537 *E. coli* strain, 15.37, A3.10
- YPD medium, 4.65, 18.18, A2.11
- YRp (yeast replicating plasmid), A3.5
- YT medium recipe, A2.4
- Z gene,  $\lambda$ , 2.15
- ZAP Express vector, 2.23
- Zeo<sup>R</sup> (Zeocin), 17.74, 18.14, 18.19
- Zygosaccharomyces*, 4.85
- Zymolyase, 4.60, 5.66–5.67, 18.39, 18.41, A1.8



VOLUME 3

# Molecular Cloning

A LABORATORY MANUAL

THIRD EDITION



# Chapter 15

## Expression of Cloned Genes in *Escherichia coli*

### INTRODUCTION

### PROTOCOLS

- 1 Expression of Cloned Genes in *E. coli* Using IPTG-inducible Promoters 15.14
- 2 Expression of Cloned Genes in *E. coli* Using the Bacteriophage T7 Promoter 15.20
- 3 Expression of Cloned Genes in *E. coli* Using the Bacteriophage  $\lambda$   $p_L$  Promoter 15.25
- 4 Expression of Secreted Foreign Proteins Using the Alkaline Phosphatase Promoter (*phoA*) and Signal Sequence 15.30
  - Additional Protocol: Subcellular Localization of PhoA Fusion Proteins 15.35
- 5 Purification of Fusion Proteins by Affinity Chromatography on Glutathione Agarose 15.36
- 6 Purification of Maltose-binding Fusion Proteins by Affinity Chromatography on Amylose Resin 15.40
- 7 Purification of Histidine-tagged Proteins by Immobilized Ni<sup>2+</sup> Absorption Chromatography 15.44
  - Alternative Protocol: Elution of Polyhistidine-tagged Proteins from Metal Affinity Columns Using Decreasing pH 15.47
  - Additional Protocol: Regeneration of NTA-Ni<sup>2+</sup>-Agarose 15.48
- 8 Purification of Expressed Proteins from Inclusion Bodies 15.49
  - Additional Protocol: Refolding Solubilized Proteins Recovered from Inclusion Bodies 15.53

### INFORMATION PANELS

- |                                   |       |
|-----------------------------------|-------|
| Expression of Cloned Genes        | 15.55 |
| <i>E. coli</i> Expression Systems | 15.56 |
| LacZ Fusions                      | 15.57 |
| Chaotropic Agents                 | 15.60 |

**B**ECAUSE OF THE VAST FUND OF KNOWLEDGE ABOUT ITS GENETICS, biochemistry, and molecular biology, *Escherichia coli* is the system of first choice for expression of many heterologous proteins: Genetic manipulations are straightforward, cultures of *E. coli* are easily and inexpensively grown, and many foreign proteins are well-tolerated and may be expressed at high levels. During the past 20 years, several hundred recombinant proteins have been expressed in *E. coli* using one or another of the vector systems described in this chapter. However, *E. coli* is not always the host of choice. For example, proteins whose full biological activity requires posttranslational modification (e.g., glycosylation or cleavage at specific sites) may best be expressed in a eukaryotic host. It is therefore important before embarking on an expression project to assess the final goal and to determine which host-vector system may be most appropriate. These systems are reviewed in the information panel on **EXPRESSION OF CLONED GENES** at the end of this chapter.

## CHOOSING AN EXPRESSION SYSTEM

---

Factors that influence the choice of a system for expression of a particular protein in *E. coli* are listed below.

- **The size of the protein.** Small cytosolic proteins and polypeptides (<100 residues in length) are best expressed in *E. coli* as fusion proteins composed of carrier sequences linked by a standard peptide bond to the target protein (please see section on Fusion Proteins, p. 15.4). The carrier often stabilizes the protein of interest against intracellular degradation and provides a ligand-binding site that can be used for affinity purification. The target protein may frequently be recovered in an active form by including a proteolytic cleavage site at an appropriate location in the fusion protein.

Cytosolic proteins >100 residues in length are the most problematic proteins to express in either system. In *E. coli*, these proteins are often unstable or form insoluble inclusion bodies. In mammalian cells, problems can arise in distinguishing the foreign protein from its endogenous homolog.

- **The amount of protein needed.** If only small quantities of the target protein are required — for example, when screening a series of site-directed mutants for enzymatic activity — there is little point in trying to optimize production. Most of the standard expression plasmids can be used successfully if the enzyme can be assayed in crude extracts of *E. coli*. However, if purification of an active protein is necessary and/or if the protein is required in large quantities, it is usually necessary to explore several different host-vector systems and purification schemes before finding one that is workable on a large scale.
- **Whether active protein is required.** If the purpose of expressing the target protein is simply to obtain material for raising antibodies, there is no point in trying to obtain active protein. Instead, expression systems can be used that facilitate purification of the target protein, irrespective of its state of biological activity or denaturation. Here, the formation of inclusion bodies is a great advantage for isolating insoluble protein, as are tags that can be used during affinity purification of the target protein.

If the target protein is to be used in biochemical or cell biological studies, then maintaining or restoring protein function is important and ease of purification matters less. In some cases, direct expression vectors may be used to produce soluble, active proteins. In most cases, however, the expressed protein will be insoluble and must be purified from inclusion bodies, solubilized, and refolded into an active form.

When the expressed protein is to be used in structural studies, it is best to express the target as a soluble protein. It may be necessary to test expression in several different strains of *E. coli* to establish conditions that minimize misfolding in vivo, and to take great care to minimize denaturation in vitro to maintain the proper configuration of the protein (please see the panel on **ADDITIONAL PROTOCOL: REFOLDING SOLUBILIZED PROTEINS RECOVERED FROM INCLUSION BODIES** in Protocol 8).

## CHOOSING A PROMOTER AND VECTOR SYSTEM

The following categories of expression vectors, based on the type of promoter, are described in detail in the first series of protocols in this chapter (please also see the information panel on **E. COLI EXPRESSION SYSTEMS**).

### Expression Vectors Containing an IPTG-inducible Promoter (Protocol 1)

Several different vectors based on the *lac* operon are used for high-level expression of foreign proteins in *E. coli*, including:

- **The *trp-lac (tac)* promoter.** *tac* is a hybrid *trp-lac* promoter containing the -35 region of the *trp* promoter fused to the -10 region of the *lacUV5* promoter; it is regulated by the *lac* repressor and is independent of cAMP regulation mediated by the *crp* gene product (Amann et al. 1983; de Boer et al. 1983). A useful *tac* promoter expression plasmid (pKK223-3 [Brosius and Holy 1984]) is available from Pharmacia.
- **The *trp-lac (trc)* promoter.** *trc* is another version of the *lac* repressor-regulated hybrid *trp-lac* promoter containing the -35 region of the *trp* promoter fused to the -10 region of the *lacUV5* promoter (Amann and Brosius 1985). The only difference between the *trc* and *tac* promoters is the distance separating the -35 and -10 regions of the promoter. In the *trc* promoter, these two elements are separated by a consensus distance (17 bp), whereas in the *tac* promoter, they are separated by 16 bp. This difference has little or no effect on the expression levels of foreign proteins (Amann and Brosius 1985). The expression plasmid pTrc 99A, available from Pharmacia, carries the *trc* promoter.
- **The *lac* promoter.** Any general-purpose vector (pUC, pTZ, pSK, pBluescript, pGEM, etc.) designed for blue/white screening for clones containing inserts of foreign DNA can be used to express a foreign protein, usually as a fusion protein with amino acids encoded by the amino terminus of the *lacZ* gene and/or the polylinker sequence (for further details, please see the information panel on **LACZ FUSIONS**). Although the *lac* promoter is not as strong as the *tac* or *trc* promoters, the high copy number of most general-purpose vectors allows expression of foreign proteins at respectable levels. Maximum induction of the *lac* promoter requires the action of the cAMP activator protein (CAP, the *crp* gene product), which is most active when cells are grown in medium lacking glucose. Media that contain glucose as a carbon source should not be used to express genes cloned into these vectors.

### Expression Vectors Containing the Bacteriophage T7 Promoter (Protocol 2)

The pET series of vectors, originally developed by Studier et al. (1990) and since expanded, allow regulated expression of foreign genes by bacteriophage T7 RNA polymerase. These vectors typically carry the colicin E1 (*colE1*) replicon of pBR322 and confer resistance to ampicillin or kanamycin. Their multiple cloning sites allow an inserted coding sequence to be placed under

control of the "natural" promoter for T7 RNA polymerase (the  $\phi 10$  promoter), or under the control of the so-called "T7lac" promoter, a derivative of the natural promoter that has the *lac* operator (*lacO*) placed so that binding of the *lac* repressor blocks transcription initiation.

### Expression Vectors Containing the Bacteriophage $\lambda p_L$ Promoter (Protocol 3)

In vectors of this class, the bacteriophage  $\lambda p_L$  promoter is regulated by a temperature-sensitive repressor, *clts857*, which represses  $p_L$ -driven transcription at low temperatures but not at elevated temperatures.  $p_L$  vectors are particularly useful if the expressed gene product is toxic to *E. coli*. Several  $p_L$  vectors are commercially available including the pHUB series (Bernard and Helinski 1979), pPLc series (Remaut et al. 1981), pKC30 (Rao 1984), pAS1 (Rosenberg et al. 1983), pRM1/pRM9 (Mieschendahl et al. 1986), and pTrxFus (LaVallie et al. 1993). *E. coli* strains (e.g., M5219) harboring the *clts857* mutation must be used as hosts for expression vectors carrying the bacteriophage  $\lambda p_L$  promoter.

## FUSION PROTEINS

Gene fusions are created by joining together two or more open reading frames in a desired order. Expression of fused reading frames generates hybrid proteins in which the protein of interest is attached to the amino terminus or the carboxyl terminus of a carrier protein (Itakura et al. 1977; Goeddel et al. 1979; for review, please see Uhlén and Moks 1990; LaVallie and McCoy 1995). Fusion proteins have a vast array of potential uses.

- **Attaching target proteins to a domain** of known enzymatic function and/or antigenic composition may provide a convenient method to "tag" and isolate the target protein sequences.
- **Joining the target protein to topogenic signals** may allow the fusion protein to be directed to specific cellular compartments.
- **Adding "carrier" sequences** may protect the target protein from proteolysis in prokaryotic hosts.
- **Adding carrier sequences** may improve the solubility of the target protein and may prevent the formation of insoluble inclusion bodies (please see the following section on Dealing with Insoluble Proteins).

Table 15-1 contains a summary of vectors widely used for creation and expression of fusion proteins.

### Purification of Fusion Proteins

By fusing the polypeptide of interest to a carrier that has high affinity for a specific ligand, almost any fusion protein can be purified by affinity chromatography, often in a single step. More than 20 different fusion systems have been designed for, or adapted to, affinity purification. The primary features of a vector used for constructing a fusion protein are shown in Figure 15-1. Many of these fusion vectors are based on LacZ, but other carrier proteins that have been used successfully include *malE*, glutathione-S-transferase, and staphylococcal protein A. Recently, identification tags derived from well-characterized ligand-binding proteins have been partially supplanted by artificial tags that have no counterpart in the natural world. The best known of these are (1) a polyhistidine sequence that binds to columns carrying  $Zn^{2+}$  or  $Ni^{2+}$  (Smith et al. 1988) and (2) FLAG, a designer heptapeptide that is both hydrophilic and immunoreactive. The five carboxy-

**TABLE 15-1 Vectors for Construction of Fusion Proteins**

VECTOR SYSTEM	FUSION PARTNER <sup>a</sup>	COMMENTS	REFERENCE/SOURCE
pUC, pSK, pBluescript, pGEM	$\beta$ -galactosidase	Expression under control of the <i>lac</i> promoter-operator system (please see the information panel on <b>LACZ FUSIONS</b> ).	Stratagene ( <a href="http://www.stratagene.com">www.stratagene.com</a> ) Life Technologies ( <a href="http://www.lifetech.com">www.lifetech.com</a> )
pTA1529 or pBAce	alkaline phosphatase	PhoA signal sequence facilitates transport to periplasm.	Oka et al. (1985)
pGEX series	GST	IPTG-inducible promoter; available with cleavage sequences.	Smith and Johnson (1988) Pharmacia
pMAL series	MBP	IPTG-inducible promoter; MBP signal sequence facilitates export to periplasm.	di Guan et al. (1988); Maina et al. (1988) New England Biolabs ( <a href="http://www.neb.com">www.neb.com</a> )
pTrx, pTrxFus	Trx	IPTG-inducible promoter; available with enterokinase cleavage sequence.	LaVallie et al. (1993) Invitrogen ( <a href="http://www.invitrogen.com">www.invitrogen.com</a> )
pET series	poly-His tag, selected vectors also carry tags for GST, Trx, DsbA, and DsbC, CBD	T7 promoter (IPTG-inducible); available with sites for chemical, enzymatic cleavage.	Studier et al. (1990) Novagen ( <a href="http://www.novagen.com">www.novagen.com</a> ) Promega ( <a href="http://www.promega.com">www.promega.com</a> )

<sup>a</sup>(GST) Glutathione S-transferase; (MBP) maltose-binding protein; (Trx) thioredoxin; (DsbA and DsbC) disulfide bond formation (periplasmic localization); (CBD) cellulose-binding domain.

terminal amino acids of FLAG constitute a recognition site for the protease enterokinase, which can be used to remove the peptide from the target protein (Dykes et al. 1988; Hopp et al. 1988). Table 15-2 lists a number of fusion systems, each of which has been used successfully in several laboratories for affinity purification of different fusion proteins.

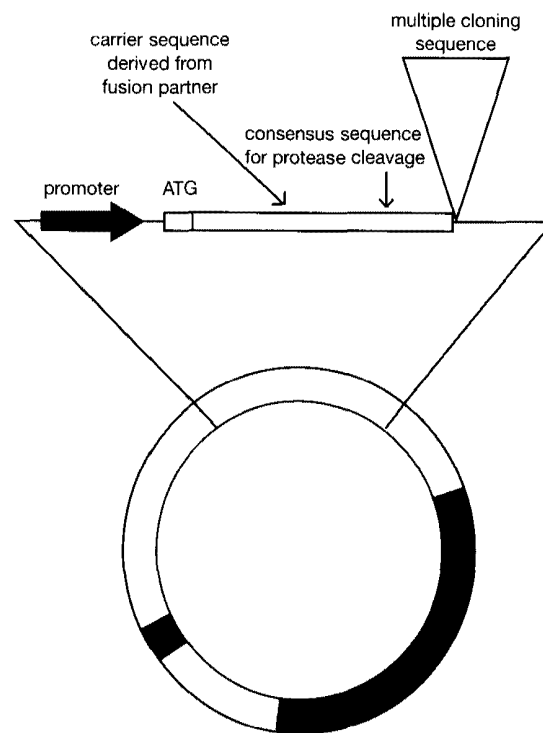
**FIGURE 15-1 Schematic of a Generic Fusion Vector**

TABLE 15-2 Affinity Purification of Fusion Proteins

CARRIER PROTEIN	AFFINITY LIGAND <sup>a</sup>	METHOD OF ELUTION	REFERENCES
$\beta$ -galactosidase	APTG TPEG	sodium borate (pH 10)	Germino et al. (1983); Ullmann (1984)
Protein A	IgG	0.5 M acetic acid	Nilsson et al. (1985a); Moks et al. (1987a,b); Nilsson and Abrahmsén (1990)
Glutathione-S-transferase	glutathione	reduced glutathione (5 mM)	Smith and Johnson (1988)
Maltose-binding protein	cross-linked amylose	maltose (10 mM)	di Guan et al. (1988); Maina et al. (1988)
Chloramphenicol acetyltransferase	<i>p</i> -aminochloramphenicol-Sepharose	chloramphenicol (5 mM)	Knott et al. (1988)
Carbonic anhydrase II	sulfonamide affinity resin	Tris-SO <sub>4</sub> (pH 6.8)	Van Hecke et al. (1993)
Cellulose-binding domain	cellulose	H <sub>2</sub> O	Ong et al. (1989a,b)
Poly(histidine)	immobilized Zn <sup>2+</sup> or Ni <sup>2+</sup>	acid gradient (pH 6.0 to pH 4.0) imidazole (up to 0.5 M)	Smith et al. (1988)
FLAG	antibody specific for FLAG	EDTA at neutral pH or glycine buffer at pH 3.0	Hopp et al. (1988)
Poly(arginine)	S-Sepharose	gradient of NaCl	Brewer and Sassenfeld (1985)
Poly(cysteine)	thiopropyl-Sepharose	mercaptoethanol or dithiothreitol	Persson et al. (1988)
Poly(phenylalanine)	phenyl-Superose	ethylene glycol	Persson et al. (1988)

<sup>a</sup>TPEG and APTG are acronyms for the same compound: *p*-aminophenyl- $\beta$ -D-thio-galactoside, which was first used for purification of  $\beta$ -galactosidase by Steers et al. (1971).

Fusion proteins produced in *E. coli* are often excellent immunogens that can be used to raise antisera against the target sequences. However, in many cases, the penalty for attaching a ligand-binding domain to the target sequences is loss of biological activity.

### Cleavage of Fusion Proteins

To obtain the polypeptide of interest in a native and biologically active form, it must be cleaved from the remainder of the fusion protein. Although both chemical and enzymatic methods have been developed to cleave peptide bonds at the joint between the sequences of the target protein and the carrier protein, efficient removal of the tag or carrier protein remains a major problem. Chemical methods are specific to a particular amino acid or small group of amino acids. For example, cyanogen bromide cleaves only at methionine residues, whereas formic acid cleaves only at proline residues that are preceded by aspartic acid residues (please see Table 15-3). If these potential sites are present in the joint region of the fusion protein and are absent from the target sequences, chemical cleavage can be used to release intact target sequences from fusion proteins.

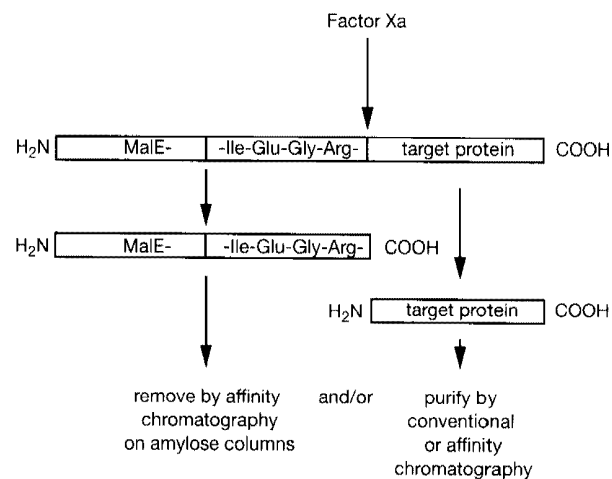
Cyanogen bromide, for example, has been used in the production of somatostatin (Itakura et al. 1977) and in the processing of  $\beta$ -galactosidase-insulin A chain fusion and  $\beta$ -galactosidase-insulin B chain fusion (Goeddel et al. 1979). In addition, the polylinker sequences of many expression plasmids contain a *Bam*HI site, 5'-NGGATCCN-3'. If this sequence of two codons (GAT and CCN), which encode the dipeptide AspPro, is in-frame with the fusion protein, then formic acid can be used to cleave the polypeptide (Table 15-3). In practice, however, chemical

cleavage is of limited use since most target proteins contain one or more potential cleavage sites. In addition, chemical cleavage is rarely as specific as it should be and is generally carried out under harsh reaction conditions that tend to denature the target protein. In most cases, therefore, the target protein is obtained in poor yield and in an inactive state.

Target proteins can sometimes be separated from the carrier sequences by enzymatic cleavage. This requires planning because the fusion protein must be designed so that it contains a specific proteolytic cleavage site at the joint between the target sequences and the carrier protein. This problem has been greatly ameliorated by the development of commercially available vectors containing a polycloning site downstream from the sequences coding for the carrier protein and a proteolytic cleavage site. For example, in the pMAL2 family of vectors, the coding sequence of interest is fused in-frame to the 3' end of a synthetic sequence encoding the four-amino-acid recognition site for Factor Xa (Ile-Asp/Glu-Gly-Arg) (Nagai and Thøgerson 1984; Nambiar et al. 1987). Upstream of this sequence is a segment of DNA encoding the *E. coli* MalE protein. Factor Xa cleaves the peptide bond that is carboxy-terminal to the arginine residue in the recognition site (see Figure 15-2).

By carefully choosing the restriction sites that will be used to insert the target sequences into the vector, it is possible to arrange that few, if any, foreign amino acids remain attached to the amino terminus of the target protein after cleavage. Similar strategies can be used with many of the other enzymatic cleavage systems listed in Table 15-3.

Although this method of purifying the sequences of the protein of interest from the fusion protein looks great on paper, it works cleanly only ~50% of the time. With many enzymes, the efficiency of the proteolytic cleavage reaction is poor unless the fusion protein has been denatured with 6 M guanidine hydrochloride or 8 M urea or after a "spacer" has been inserted on one or both sides of the cleavage site. In other cases, because the specificity of the protease is not absolute or because the enzyme used for cleavage is contaminated by other proteases, the protein of interest is cleaved internally at sites that are related to the recognition site (Nagai and Thøgerson 1984, 1987; Dykes et al. 1988; Lauritzen et al. 1991). Problems of this type can sometimes, but not always, be solved by changing proteases or by using vectors (e.g., those coding for glutathione reductase or thioredoxin fusions) that typically express fusion proteins in a soluble form rather than in an inclusion body.



**FIGURE 15-2 Cleavage of Fusion Proteins by Factor Xa**

Factor Xa cleaves the peptide bond that is carboxy-terminal to the arginine residue in the recognition site.



Because few direct comparisons of the efficiency of cleavage of specific proteins by different proteases have been published, it is impossible to recommend one system over another with confidence. However, in one comparative study, the TEV (tobacco etch virus) protease was far more efficient at cleaving glutathione-S-transferase- and maltose-binding protein fusions than Factor Xa. TEV protease also has advantages over other proteases: Cleavage at cryptic sites occurs rarely if at all; the enzyme is fully active in the presence of common inhibitors of proteases and works at low temperatures (4–30°C) (Polayes et al. 1994). Finally, the TEV protease is itself available (from Life Technologies) as a fusion protein carrying a polyhistidine tag. This simplifies removal of the protease after cleavage of the fusion protein. The chemical and enzymatic reactions that have been used to achieve specific cleavage of peptide bonds in fusion proteins are shown in Table 15-3.

**TABLE 15-3 Cleavage of Fusion Proteins**

METHOD OF CLEAVAGE	SEQUENCE AT CLEAVAGE SITE	NAME OF VECTOR(S)	REFERENCES
<b>Chemical</b>			
Cyanogen bromide and 70% formic acid	-Met↓		Itakura et al. (1977); Szoka et al. (1986)
Formic acid (70%) and heat	-Asp↓Pro-		Nilsson et al. (1985b); Szoka et al. (1986); Boutelje et al. (1990)
Hydroxylamine at pH 9 and heat	-Asn↓Gly-		Moks et al. (1987b); Forsberg et al. (1990); Canova-Davis et al. (1992); Edalji et al. (1992); King et al. (1992)
Iodosobenzoic acid 2-(2-nitrophenyl)-3-methyl-3-bromoindole-nine in 50% acetic acid (BNPS-skatole)	-Trp↓		Dykes et al. (1988); Knott et al. (1988); Villa et al. (1988)
<b>Enzymatic</b>			
Ala-64 subtilisin <sup>a</sup>	-Gly-Ala-His-Arg↓		Forsberg et al. (1991, 1992)
Clostripain	-Arg↓ and Lys-Arg↓		Bennett et al. (1984)
Collagenase	-Pro-Val↓Gly-Pro-		Germino and Bastia (1984); Lee and Ullrich (1984); Hiraoka et al. (1991); Chinery et al. (1993)
Enterokinase	-Asp-Asp-Asp-Asp-Lys↓		Dykes et al. (1988); Hopp et al. (1988); Su et al. (1992); Van Heeke et al. (1993)
Factor Xa	-Ile-Glu (or Asp)-Gly-Arg↓	pMal-c2 (cytosolic) pMal-p2 (periplasmic) pGEX3X (Pharmacia)	Nagai and Thogerson (1984, 1987); Lauritzen et al. (1991); Ohashi et al. (1991)
Renin	-Pro-Phe-His-Leu↓Leu-		Haffey et al. (1987)
α-Thrombin <sup>b</sup>	-Leu-Val-Pro-Arg↓Gly-Ser-	pGEX2T (Pharmacia)	Gearing et al. (1989)
Trypsin	-Arg↓ or -Lys↓		Shine et al. (1980); O'Hare et al. (1990); Wang et al. (1989)
TEV protease <sup>c</sup> (tobacco etch virus protease)	-Glu-Asn-Leu-Tyr-Phe-Gln↓Gly-	pPROEX-1 (Life Technologies)	Parks et al. (1994); Polayes et al. (1994)

<sup>a</sup>Ala-64 subtilisin is a site-directed mutant of subtilisin in which the catalytic His-64 is replaced by alanine (H164A). The mutant enzyme is very specific for substrates containing a histidine (Carter and Wells 1987).

<sup>b</sup>The optimum cleavage sites for α-thrombin are (1) P4-P3-Pro-Arg-P1'-P2', where P3 and P4 are hydrophobic amino acids and P1' and P2' are nonacidic amino acids, and (2) P2-Arg-P1', where P2 or P1' is Gly (Chang 1985).

<sup>c</sup>The Glu, Tyr, Gln, and Gly residues are required for cleavage (Carrington and Dougherty 1988; Dougherty et al. 1988; Dougherty and Parks 1989).

## DEALING WITH INSOLUBLE PROTEINS

Overexpression of foreign proteins from cloned genes in heterologous hosts, such as *E. coli*, often leads to the formation of insoluble intracellular aggregates of the expressed protein (Williams et al. 1982; Schoner et al. 1985; for reviews, please see Marston 1986; Kane and Hartley 1988; Mitraki and King 1989; Schein 1989, 1991; Marston and Hartley 1990; Georgiou and Valax 1996). These so-called inclusion bodies are readily isolated by low-speed centrifugation and usually consist of almost pure accretions of denatured forms of the foreign protein. Inclusion bodies appear as amorphous granules in electron micrographs and as bright refractile particles in cells examined under phase-contrast illumination. No surrounding membranes are visible. Morphologically similar structures are observed in bacteria that have incorporated amino acid analogs into their proteins (Prouty and Goldberg 1972; Prouty et al. 1975) or are expressing high levels of endogenous genes (Marston 1986; Schein 1989).

Whether a foreign protein expressed to high levels in *E. coli* remains soluble or will accumulate in inclusion bodies is unpredictable. "Global" properties of proteins such as size, overall hydrophobicity, and charge are poor prognostic indicators. The quaternary structure of the native protein is also an unreliable guide since both monomeric proteins and subunits from oligomeric proteins can readily form inclusion bodies. The available evidence suggests that inclusion bodies arise by the inappropriate aggregation of partially folded or misfolded polypeptides, rather than as a consequence of the insolubility or instability of the native protein (Mitraki and King 1989; Schein 1989; Jaenicke 1991; Chrnyk et al. 1993). Thus, formation of inclusion bodies is (1) enhanced when mutant genes encoding thermolabile folding intermediates are expressed in *E. coli* (Haase-Pettingell and King 1988) and (2) partially suppressed when *E. coli* producing large quantities of foreign proteins is grown at low temperature (Lin et al. 1987; Schein and Noteborn 1988; Pan et al. 1991; Derbyshire et al. 1993). Several groups have used site-directed mutagenesis in an attempt to identify regions, domains, or motifs that are involved in inclusion body formation by particular proteins (Wetzel et al. 1991; Chrnyk et al. 1993). Mutations affecting the formation of inclusion bodies map in all areas of the proteins and are found in  $\alpha$  helices, in both dynamically and statically disordered regions, in strands of  $\beta$  sheets, and in loops and turns. From these results, it seems that no single structural motif is responsible for the accumulation of folding intermediates and their aggregation into inclusion bodies. However, in one case — the polymerase domain of the Klenow fragment — problems of solubility were solved by two strategies: (1) reengineering the protein so as to remove both a solvent-exposed hydrophobic patch and a potentially unstructured region at the amino terminus of the protein (Derbyshire et al. 1993) and (2) changing the expression vector from one containing the  $\lambda p_L$  promoter to one containing the T7 promoter. Although the results of reengineering the protein are gratifyingly logical, it is impossible to understand why the expression system should dramatically influence the solubility of the protein product. As Derbyshire et al. (1993) point out, this result "emphasises the ignorance of the factors that influence protein overproduction and the need, in difficult cases...to test a range of expression systems, induction protocols and purification strategies."

As discussed earlier, a common strategy to avoid some of the problems associated with inclusion bodies and protein refolding is to express the protein of interest in a fusion system. In some cases, proteins that form inclusion bodies when expressed alone in *E. coli* are soluble when expressed as fusion proteins. The fusion partners of choice for production of soluble proteins are *Schistosoma* glutathione-S-transferase (Smith and Johnson 1988), *E. coli* maltose-binding protein (MalE) (Maina et al. 1988), and *E. coli* thioredoxin (*trxA*) (LaVallie et al. 1993; Sachdev and Chirgwin 1998). These systems have an additional advantage in that the fusion partner endows the foreign protein with specific biochemical properties that greatly simplify purification. For example, fusion proteins containing *E. coli* thioredoxin accumulate at zones of adhesion between

**TABLE 15-4 Lysis of Bacteria Containing Inclusion Bodies**

Sonication	Saito et al. (1987); Belder et al. (1988)
French Press	Goeddel et al. (1979); Schumacher et al. (1986)
Freeze-Thaw	Schein and Noteborn (1988)
Lysozyme	Goliger and Roberts (1987)

the inner and outer membranes of the bacterial envelope, from where they can be released by osmotic shock or freezing and thawing.

An alternative method to circumvent formation of inclusion bodies is to express the protein from a vector that contains a prokaryotic signal sequence. The newly synthesized protein is then delivered to the periplasmic space, where it may be soluble. This method works best with proteins that are normally translocated into the secretory pathway of eukaryotic cells. For example, BiP, the major chaperone of the eukaryotic endoplasmic reticulum, is completely insoluble when expressed in the cytoplasm of bacteria, but it can be recovered in a biologically active form when expressed from a prokaryotic secretion vector (Blond-Elguindi et al. 1993).

Despite their complex structure, inclusion bodies sometimes offer opportunities to extract foreign proteins in an active and pure form. The basic steps in this procedure are outlined in Figure 15-3 and in Protocol 8. The difficult steps in this scheme are clearly the efficient solubilization of partially denatured aggregates and subsequent folding of the polypeptide into a native form. Because every protein is unique, no universal set of conditions exists to accomplish these goals. However, during the past 20 years, successful protocols have been devised to refold a large number of individual proteins, and from these, a set of basic guidelines of the methods most likely to succeed has emerged. For excellent sources of general advice on all stages of purification and recovery of proteins from inclusion bodies, please see the review articles by Marston (1986) and Marston and Hartley (1990).

### Disruption of Bacteria Containing Inclusion Bodies

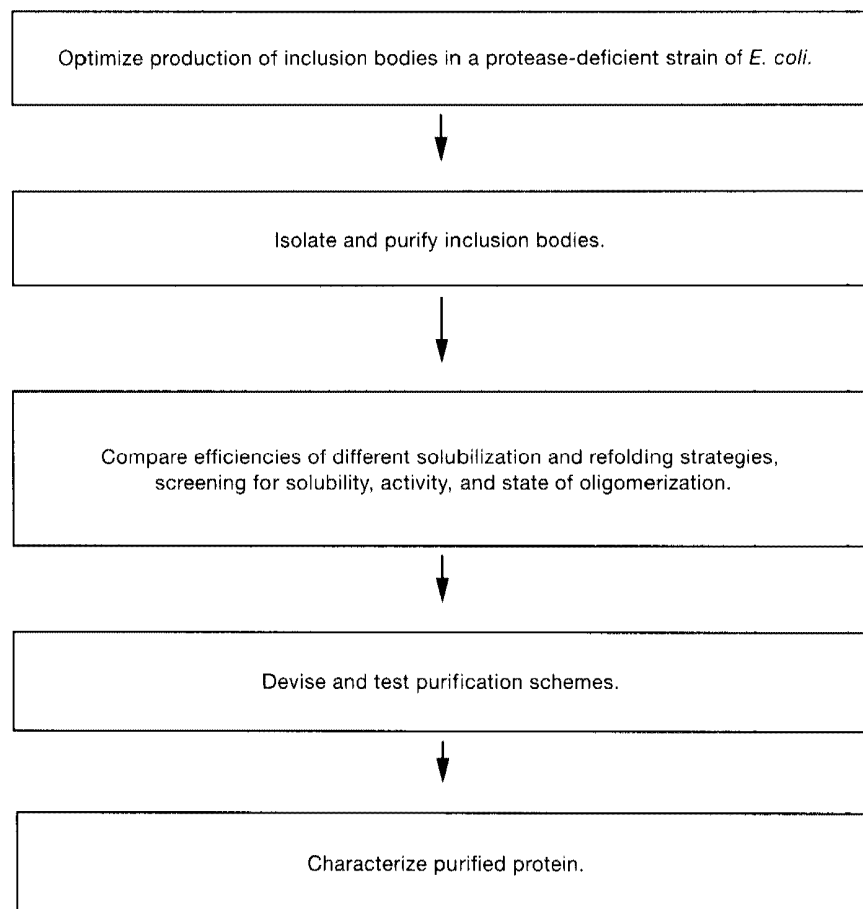
Lysis of bacteria containing inclusion bodies can generally be accomplished by standard methods, presented in Table 15-4. The choice among these methods is usually dictated by the range of equipment that is available and the previous experience of the investigator, rather than the properties of the protein under study. Whichever lysis method is chosen, it is very important to work quickly and to ensure that the temperature of the preparation does not exceed 4°C.

### Centrifugation and Washing

In most cases, inclusion bodies can be recovered from the bacterial lysate by low-speed centrifugation (10,000–20,000g at 4°C). Contaminating proteins and nucleic acids can be removed by washing the pellet with solutions containing EDTA, detergents, and/or DNase. After washing, the inclusion bodies should be suspended in refolding buffer lacking the solubilization agent. Typically, these buffers contain Tris-Cl (pH 7.2), NaCl (50 mM), EDTA (1–5 mM), and a cocktail of protease inhibitors (see Table 15-5). If the native protein contains no disulfide bonds, dithiothreitol (2 mM) should also be included.

**TABLE 15-5 Components of Washing Solutions for Inclusion Bodies**

Lysozyme	Marston (1986)
EDTA	Belder et al. (1988)
Deoxycholate or Triton X-100	Promega Booklet on <i>Proteins</i>
DNase	



**FIGURE 15-3** Flowchart: Purification of Protein from Inclusion Bodies

### Solubilization and Refolding

Solubilization of the protein from the pellet generally requires exposure to strong chaotropic agents, such as urea (6–8 M) or guanidinium chloride (5–8 M), to detergents, such as SDS, and sometimes nonphysiological pH (Marston 1986; Marston and Hartley 1990). For further details on these agents, please see the information panel on **CHAOTROPIC AGENTS**. Usually, the aggregated protein isolated from washed inclusion bodies is ~50–75% pure and consists of denatured monomeric and oligomeric forms held together by disulfide bonds (Light 1985). The solubilized protein is almost always devoid of biological activity, which can be restored only if the protein can adopt a native or near-native configuration *in vitro*. Methods for solubilizing and refolding aggregated proteins isolated from inclusion bodies are described in Protocol 8.

## OPTIMIZATION OF EXPRESSION OF FOREIGN PROTEINS IN *E. COLI*

### Optimization of Translation Efficiency: Initiation

Efficient initiation of translation requires a ribosome-binding site upstream of the initiation codon (Huttenhofer and Noller 1994). During translation initiation, the Shine-Dalgarno

sequence, 5–9 nucleotides in length, interacts with the 3' end of 16S RNA (Shine and Dalgarno 1974; Steitz and Jakes 1975; Steitz 1979). The distance between the Shine-Dalgarno sequence and the initiating ATG codon affects the translation efficiency. In vectors in which an open reading frame is inserted *downstream* from an initiating ATG, the distance between the Shine-Dalgarno sequence and the initiating codon will already have been optimized. However, if translation of the cloned open reading frame is initiated at its own ATG, then the initiating codon should be positioned 5–7 nucleotides downstream from the Shine-Dalgarno sequence (Ringquist et al. 1992).

The secondary structure of the translation initiation region also affects the efficiency of gene expression (de Smit and van Duin 1994a,b). In several cases, changing the sequences upstream and downstream from the Shine-Dalgarno sequence to reduce secondary structure has increased gene expression (e.g., please see Chen et al. 1994). Similarly, translational coupling, which involves placing the coding region of the gene of interest downstream from a translated sequence, has led to high-level expression of a number of genes (Makoff and Smallwood 1990; Rangwala et al. 1992).

## Codon Usage

The genetic code is redundant, using 61 codons to specify 20 amino acids. Only two amino acids (Met and Trp) are specified by a single codon, whereas the remaining 18 are each specified by multiple codons. The synonymous codons that specify a single amino acid are not used with equal frequency (Grantham et al. 1980a,b, 1981).

If the coding region contains a high level or a cluster of rare codons, removal of the rare codons by resynthesis of the gene or by mutagenesis can increase expression (Rangwala et al. 1992). Particular problems have been observed when the target sequence contains the rare codons AGA and AGG, since they also can form fortuitous Shine-Dalgarno sequences within the coding region (Ivanov et al. 1992).

The DNA sequence encoding the amino terminus of the foreign protein can dramatically influence expression levels (Barnes et al. 1991). For this reason, it is sometimes necessary to use the polymerase chain reaction (PCR) or site-directed mutagenesis (Chapter 13, Protocols 4–6) to change the DNA sequences of the first seven or eight codons of the expressed gene to those most frequently used in *E. coli* (Bennetzen and Hall 1982). Wherever possible, the (G+C) content of the 5' end of the target gene should be reduced to <40% by these procedures.

## Optimization of Growth Conditions

Irrespective of the expression system used, dramatic differences in expression levels are often realized in different media (Weickert et al. 1996). A standard medium such as LB can be used to establish the general parameters of expression, but optimum expression, however, is usually achieved only after modification of the growth conditions, which may include using a minimal salts medium such as M9 (please see Appendix 2), defined salts medium such as induction medium (Protocol 4), or rich media such as Terrific Broth, YT, or NZCYM (Appendix 2). For further information, please see the panel on **TROUBLESHOOTING AND OPTIMIZATION OF PROTEIN EXPRESSION FROM AN INDUCIBLE PROMOTER** at the end of Protocol 1.

## SUMMARY

---

This chapter describes methods for constructing and producing fusion proteins and intact nonfusion proteins in bacteria using a variety of different vectors. Nonfusion proteins can be produced in bacteria by placing a strong regulated promoter and an efficient ribosome-binding site upstream of the cloned gene. Fusion proteins can be made in large amounts, are easy to purify, and can be used to elicit a response in immunologic or biological assays.

Eukaryotic proteins expressed in bacterial systems may lack important processing or modification required for proper function. Expression systems based on the use of baculovirus vectors have proven to be tremendously useful for the faithful production of foreign proteins, fusion proteins, and simultaneous expression of two or more (up to four) proteins. For further details, please see the information panel on **BACULOVIRUSES AND BACULOVIRUS EXPRESSION SYSTEMS** in Chapter 17. Protocols for the use of the baculovirus expression system may be found in Spector et al. (1998; Chapter 66 of *Cells: A Laboratory Manual*).

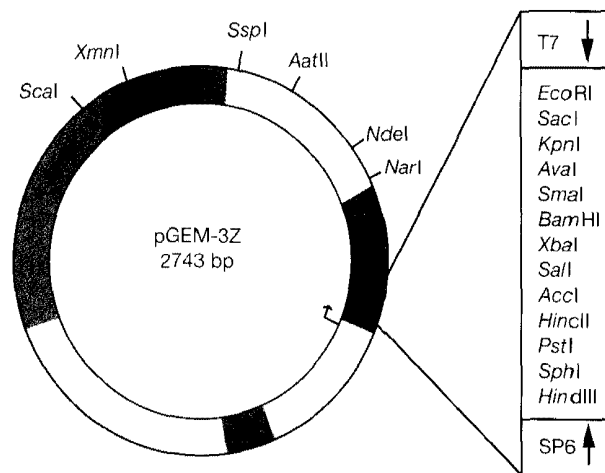
*Almost everything that distinguishes the modern world from earlier centuries is attributable to science, which achieved its most spectacular triumphs in the seventeenth century.*

Bertrand Russell, *History of Western Philosophy*

# Protocol 1

## Expression of Cloned Genes in *E. coli* Using IPTG-inducible Promoters

**P**LASMIDS CARRYING ISOPROPYL- $\beta$ -D-THIOGALACTOSIDE (IPTG)-inducible promoters are capable of expressing proteins at levels that exceed 30% of total mass of bacterial protein. These plasmids are well-suited for small-scale laboratory experiments, but the high cost of IPTG prevents their use for large-scale production of foreign proteins. Variables that influence the efficiency of expression of foreign proteins from these and other expression plasmids are discussed in the panel on **TROUBLESHOOTING AND OPTIMIZATION OF PROTEIN EXPRESSION FROM AN INDUCIBLE PROMOTER** at the end of this protocol.



**FIGURE 15-4 pGEM-3Z Vector**

The pGEM-3Z vector may be used for *in vitro* transcription and protein expression. The vector encodes the LacZ  $\alpha$  peptide preceded by *lac* operon sequences, the T7 and SP6 polymerase transcription initiation sequences flanking the multiple cloning site, and the  $\beta$ -lactamase-coding sequence that confers ampicillin resistance. (Modified, with permission, from Promega Corporation.)

## MATERIALS

---

**CAUTION:** Please see Appendix 12 for appropriate handling of materials marked with <!>.

### Buffers and Solutions

Please see Appendix 1 for components of stock solutions, buffers, and reagents. Dilute stock solutions to the appropriate concentrations.

*Coomassie Brilliant Blue stain or Silver stain*

Please see Appendix 8.

*IPTG (1 M)*

*1x SDS gel-loading buffer*

Store 1x SDS gel-loading buffer lacking dithiothreitol at room temperature. Add dithiothreitol from a 1 M stock just before the buffer is used in Step 10.

### Gels

*Polyacrylamide gel (10%) containing SDS <!>*

For the preparation of SDS-polyacrylamide gels used in the separation of proteins, please see Appendix 8.

### Nucleic Acids and Oligonucleotides

*Gene or cDNA fragment of interest*

### Media

*LB agar plates containing 50 µg/ml ampicillin*

*LB medium containing 50 µg/ml ampicillin*

### Centrifuges and Rotors

*Sorvall GSA rotor or equivalent*

### Special Equipment

*Boiling water bath*

*Shaking incubator*

### Additional Reagents

*Step 1 of this protocol requires the reagents listed in Chapter 8, Protocol 7.*

*Step 2 of this protocol requires the reagents listed in Chapter 1, Protocol 17 or 19.*

*Step 3 of this protocol requires the reagents listed in Chapter 1, Protocols 23–26.*

*Step 4 of this protocol requires the reagents listed in Chapter 12, Protocol 3.*

### Vectors and Bacterial Strains

*E. coli strain suitable for transformation and carrying either the  $lacI^q$  or  $lacI^{q1}$  allele*

Some IPTG-inducible expression vectors carry the  $lacI^q$  allele on the expression plasmid (e.g., pMAL and pGEX). These can be used in any laboratory strain of *E. coli* (e.g., JM101, DH5F', and TG1). For details, please see the panel on **TROUBLESHOOTING AND OPTIMIZATION OF PROTEIN EXPRESSION FROM AN INDUCIBLE PROMOTER** at the end of this protocol.

*IPTG-inducible expression vector*

Other examples include pGEM-3Z (Promega; please see Figure 15-4), pGEX-1 (Pharmacia), pKK223-3 (Pharmacia), pMEX (U.S. Biochemicals), pTrc 99A (Pharmacia), and pMAL (New England Biolabs).

*Positive control plasmid (e.g., an IPTG-inducible vector known to express a LacZ fusion protein of defined size)*



## METHOD

---

### Construction of a Strain of *E. coli* Containing the Recombinant Expression Vector

1. Modify by PCR (Chapter 8, Protocol 7), or isolate by restriction enzyme digestion, a fragment of DNA carrying 5'- and 3'-restriction enzyme sites compatible with sites in an IPTG-inducible expression vector.

Most IPTG-inducible expression vectors contain all of the controlling elements required for expression of foreign proteins. Use PCR to modify the ends of the cDNA/gene to be expressed so that no extraneous flanking sequences are included in the construct. Depending on the vector and preliminary results, other regulatory sequences can be added to the ends to facilitate expression (please see the panel on **TROUBLESHOOTING AND OPTIMIZATION OF PROTEIN EXPRESSION FROM AN INDUCIBLE PROMOTER** at the end of this protocol).

Constructs generated by PCR should be sequenced to ensure that no spurious mutations were introduced during the amplification reactions.

2. Ligate the DNA fragment containing the cDNA/gene of interest into the expression vector (Chapter 1, Protocol 17 or 19).
3. Transform an *E. coli* strain containing the *lacI<sup>H</sup>* allele with the recombinant plasmid. If the plasmid vector itself carries the *lacI* gene, then any appropriate strain of *E. coli* can be used. Plate aliquots of the transformation reaction on LB agar containing 50 µg/ml ampicillin. Incubate the cultures overnight at 37°C.  
As controls, transform the same strain of *E. coli* with a plasmid such as pGEX-1 (positive control) and an empty expression plasmid (negative control).
4. Screen transformants by colony hybridization and/or restriction enzyme analysis, oligonucleotide hybridization, or direct DNA sequence analysis (please see Chapter 12, Protocol 3) of plasmid minipreparations.

### Optimization of the Induction of Target Protein Expression

Many studies point to the importance of the rate of cell growth on foreign protein expression. For this reason, it is important to monitor the number of bacteria inoculated into the growth medium, the length of time cells are grown before induction, and the density to which cells are grown after induction. Overgrowth or too rapid growth can overload the bacterial synthetic apparatus and promote the formation of inclusion bodies.

5. Inoculate 1-ml cultures (LB medium containing 50 µg/ml ampicillin) with 1 or 2 colonies containing the empty expression vector, the positive control plasmid (pGEX-1), and the recombinant expression plasmid. Incubate the cultures overnight at the appropriate temperature (20–37°C).

Because *E. coli* grows about four times more slowly at room temperature than at 37°C, the cultures may not reach saturation during overnight (~16 hours) incubation at ~20°C. However, the slower rate of bacterial metabolism at lower temperature may prevent formation of inclusion bodies. Please see the discussion on Dealing with Insoluble Proteins in the chapter introduction.

6. Inoculate 5 ml of LB medium containing 50 µg/ml ampicillin with 50 µl of each overnight culture. Incubate the cultures for >2 hours at 20–37°C in a shaking incubator until cells reach mid-log growth ( $A_{550}$  of 0.5–1.0).
7. Transfer 1 ml of each uninduced culture (zero-time aliquot) to microfuge tubes. Immediately process the zero-time aliquots as described in Steps 9 and 10.

8. Induce the remainder of each culture by adding IPTG to a final concentration of 1 mM and continue incubation at 20–37°C with aeration (but please see the notes below concerning optimization of the IPTG concentration and the induction temperature).

The concentration of IPTG used to induce *lac* repressor-regulated promoters can dramatically influence expression. The suggested concentration of 1 mM IPTG is a starting point and is at the higher range of the scale. Establish the optimum concentration empirically by varying the IPTG concentration between 0.01 and 5.0 mM. With some proteins, it is important to induce transcription of the expression plasmid slowly (with low IPTG concentrations) so as not to overload the biosynthetic machinery of the bacterium.

Perhaps the most important variable in obtaining high-level expression in *E. coli* is the temperature at which the bacteria are grown before and during induction. It is crucial to carry out trial studies to determine the optimum temperature for expression of a foreign protein. The temperature range over which successful expression has been obtained is 15–42°C. The optimum temperature for expression can be quite narrow, spanning 2–4°C. The reason for the sometimes all or none effect of different temperatures on expression levels is not known, but it could be due to a large number of factors, singly or in combination. These factors include: the growth rate of the cells, intracellular folding of the expressed protein, availability of prosthetic groups (heme, flavin adenine dinucleotide, biotin, etc.), thermal denaturation of the foreign protein, overloading of the secretory or folding machinery of the cell, the activity of endogenous proteases or other lytic enzymes, activation of the SOS response system of the bacterium, or other variables. Because of these uncertainties, gedanken experiments concerning optimum growth temperatures are of little use. Trial and error must be used.

9. At various time points during the induction period (e.g., 1, 2, 4, and 6 hours), transfer 1 ml of each culture to a microfuge tube, measure the  $A_{550}$  in a spectrophotometer, and centrifuge the tubes at maximum speed for 1 minute at room temperature in a microfuge. Remove the supernatants by aspiration.
10. Resuspend each pellet in 100  $\mu$ l of 1x SDS gel-loading buffer, and heat the samples to 100°C for 3 minutes. Centrifuge the tubes at maximum speed for 1 minute at room temperature in a microfuge, and store them on ice until all of the samples are collected and ready to load on a gel.
11. Warm the samples to room temperature and load 0.15  $OD_{550}$  units (of original culture) or 40  $\mu$ g of each suspension on a 10% SDS-polyacrylamide gel.
12. Run the gel at 8–15 V/cm until the bromophenol blue reaches the bottom of the resolving gel.
13. Stain the gel with Coomassie Brilliant Blue or silver, or carry out an immunoblot to visualize the induced protein (please see Appendix 8).

In extracts of cells expressing the positive control protein, glutathione *S*-transferase (GST) (i.e., pGEX-1-containing cells), a 26-kD protein should be visible ~30 minutes after induction at 37°C. The amount of GST should increase throughout the induction period. In extracts of cells expressing the recombinant gene, a protein of the predicted molecular weight should be visible at some time point after induction. The kinetics of induction and the stability of the foreign protein may differ from those of the GST control.

## Large-scale Expression of the Target Protein

14. For large-scale expression and purification of the target protein, inoculate 50 ml of LB containing 50  $\mu$ g/ml ampicillin in a 250-ml flask with a colony of *E. coli* containing the recombinant construct. Incubate the culture overnight at 20–37°C.
15. Inoculate 450–500 ml of LB containing 50  $\mu$ g/ml ampicillin in a 2-liter flask with 5–50 ml of overnight culture of *E. coli*. Incubate with shaking at 20–37°C until the culture has reached the mid-log phase of growth ( $A_{550} = 0.5$ –1.0).

16. Induce expression of the target protein based on the optimal values of IPTG concentration, incubation time, and incubation temperature determined in the previous section.
17. After the induced cells have grown for the proper length of time, harvest the cells by centrifugation at 5000g (5500 rpm in a Sorvall GSA rotor) for 15 minutes at 4°C and proceed with a purification protocol:
  - Protocol 5 if the expressed protein is a fusion with glutathione *S*-transferase
  - Protocol 6 if the expressed protein is a fusion with maltose-binding protein
  - Protocol 7 if the expressed protein contains a polyhistidine tag

#### TROUBLESHOOTING AND OPTIMIZATION OF PROTEIN EXPRESSION FROM AN INDUCIBLE PROMOTER

- In addition to a strong bacterial promoter, an efficient ribosome-binding site is important for the expression of cloned DNA in *E. coli*. The ribosome-binding site includes an initiation codon (ATG) and a sequence 5–9 nucleotides in length located 3–11 nucleotides upstream of the initiation codon. This sequence, called the Shine-Dalgarno sequence, is complementary to the 3' terminus of *E. coli* 16S rRNA. Binding of the ribosome to mRNA is thought to be promoted by base pairing between the Shine-Dalgarno sequence in the mRNA and the sequence at the 3' terminus of the 16S rRNA (Shine and Dalgarno 1974; Steitz and Jakes 1975; Steitz 1979). Other sequences in the immediate 5'-untranslated region of the expressed gene may also contribute to expression levels (Gold 1988). (See also discussion on p. 15.12.)
- Placing sequences downstream from the inserted DNA that may stabilize the mRNA or improve the efficiency of translation (i.e., transcription terminators or RNase III sites) can also enhance expression (Panayotatos and Truong 1981; Studier and Moffatt 1986; Rosenberg et al. 1987).
- Use of an IPTG-inducible expression vector requires transformation of an *E. coli* strain that overexpresses the *lac* repressor. The *lac* repressor prevents transcription of foreign gene sequences in the absence of inducer. Since most IPTG-inducible expression plasmids are present at high copy number (30–600), excess repressor is needed to prevent titration of the protein and subsequent basal level (leaky) expression. The *lac<sup>q</sup>* allele, which overproduces the *lac* repressor by tenfold when present in single copy (Calos 1978), is most commonly used to overexpress this protein. However, if the foreign protein is especially toxic to *E. coli* and very low basal expression levels cannot be tolerated, or if a very high-copy-number plasmid vector is used (e.g., pUC-based plasmids), then a *lac<sup>q</sup>* gene should be cloned into the expression plasmid to ensure tight regulation. This precaution should also be considered when *E. coli* strains (e.g., JM101 and JM105) harboring the *lac<sup>q</sup>* allele on an F' sex factor are used. The F' sex factor is frequently lost (cured) from the bacterium with growth in rich medium, resulting in a gradual titration of the *lac* repressor and loss of regulation.
- Over and above the *lacI* requirement, the choice of which *E. coli* strain to use for the expression of a foreign protein must be made empirically. We strongly recommend transforming multiple common laboratory strains as well as a few more exotic strains to deduce the best *E. coli* host for a particular foreign protein. Although the known genotypes of some strains make them logical host choices (e.g., protease-deficient strains; please see below), there is usually no clear-cut reason why one strain fosters high-level expression of the protein of interest and another does not.
- The level of expression of the cloned gene may be low due to RNA instability, premature termination, inefficient initiation of translation, or protein instability. Protein instability is distinguished from the other potential problems by pulse-chase experiments. A culture of cells carrying the expression plasmid is grown to mid-log phase in M9 minimal media supplemented with 19 L-amino acids (minus methionine or cysteine) at 20 µg/ml, induced, and labeled for 10 minutes with 15 µCi/ml of [<sup>35</sup>S]methionine or [<sup>35</sup>S]cysteine (or Tran<sup>35</sup>S-Label [ICN Biochemicals], which contains both radiolabeled amino acids), followed by the addition of excess (1 mM)

(Continued on next page.)

unlabeled methionine or cysteine. Samples taken every 10 minutes from immediately before induction to 1 hour after induction are analyzed by electrophoresis through an SDS-polyacrylamide gel. The gel is dried and subjected to autoradiography to determine whether the protein is unstable. The genetics and biochemistry of protein turnover in *E. coli* are quite well understood (Golberg 1992; Maurizi 1992), and a number of protease-deficient strains are available (Gottesman 1990). The most commonly used strains are those that harbor mutations in the *lon* gene, which encodes the Lon (or La) protease, an ATP-dependent endoprotease. This protease, working in conjunction with several heat shock proteins, degrades unfolded and abnormal (foreign) proteins in *E. coli* (Gottesman and Maurizi 1992). Representative  $\Delta lon$  strains (Y1089 and Y1090) are available from The American Type Culture Collection (37196 and 37197, respectively) or from several commercial suppliers. A protease-deficient strain that has proven useful for both secreted and soluble proteins is *E. coli* RF6333, available from The American Type Culture Collection (ATCC # 55101). The RF6333 strain harbors *degP* and *ompT* mutations, which inactivate a periplasmic and an outer-membrane-localized protease, respectively. Increased yields of foreign protein in protease-deficient strains are a result of both decreased intracellular turnover and decreased proteolysis after cell lysis. Protease inhibitors (1 mM phenylmethylsulfonyl fluoride [PMSF], 1–5 mM EDTA, 1–5 mM EGTA, 1–20 mM benzamidine, 1–10  $\mu\text{g/ml}$  leupeptin, 5  $\mu\text{g/ml}$  pepstatin A, 1–10  $\mu\text{g/ml}$  aprotinin, 1–20 mM tosyl-lysine-chloromethyl ketone, etc.) in the growth medium and harvest buffers may increase yields.

- The use of mutant strains defective in termination of transcription (*rho*) or altered in RNA metabolism (*prp*, *ma*) may increase the amount of functional RNA transcribed from a foreign gene.
- Dramatic differences in expression levels are often realized in different media. LB medium can be used to establish the general parameters of expression as described above; however, for optimum expression, or in cases where no or very low expression is obtained in LB medium, other media should be tried. These include minimal salts medium such as M9, defined salts medium such as induction medium (Protocol 4), and other rich media such as Terrific Broth, YT, or NZCYM.
- As mentioned above, supplements to established media may enhance the expression of a given foreign protein. These supplements include NaCl at concentrations between 0.1 and 0.5 M (Jespers et al. 1991), non-metabolizable sugars such as sucrose (0.2–0.6 M) (Bowden and Georgiou 1990), cofactors (heme), and antibiotics. The use of antibiotics such as chloramphenicol (1  $\mu\text{g/ml}$  medium) and tetracycline (0.1  $\mu\text{g/ml}$ ) at sublethal concentrations is based on observations by Lee and Beckwith (1986), who noted that many suppressors of secretory pathway defects (*sec* mutants) mapped in genes encoding protein synthesis components. The net effect of these suppressor mutations was to decrease the overall rate of protein synthesis; in addition, low concentrations of antibiotics could mimic these effects in *E. coli*. When expressing a foreign protein, especially one destined for the membrane compartment of the cell, the decreased rate of protein synthesis in the presence of the antibiotic may prevent overloading of the secretion pathway. By the same token, soluble proteins may have greater access to chaperones and other molecules involved in formation of the native protein. Finally, the pH of the medium can affect expression of foreign proteins (Kopetzki et al. 1989). These authors noted a substantial increase in expression of the soluble protein  $\alpha$ -glucosidase when the pH of the LB medium was decreased below pH 5.5. Extremes in pH probably act to slow overall cell growth and thereby prevent overloading of bacterial expression/processing systems.

# Protocol 2

---

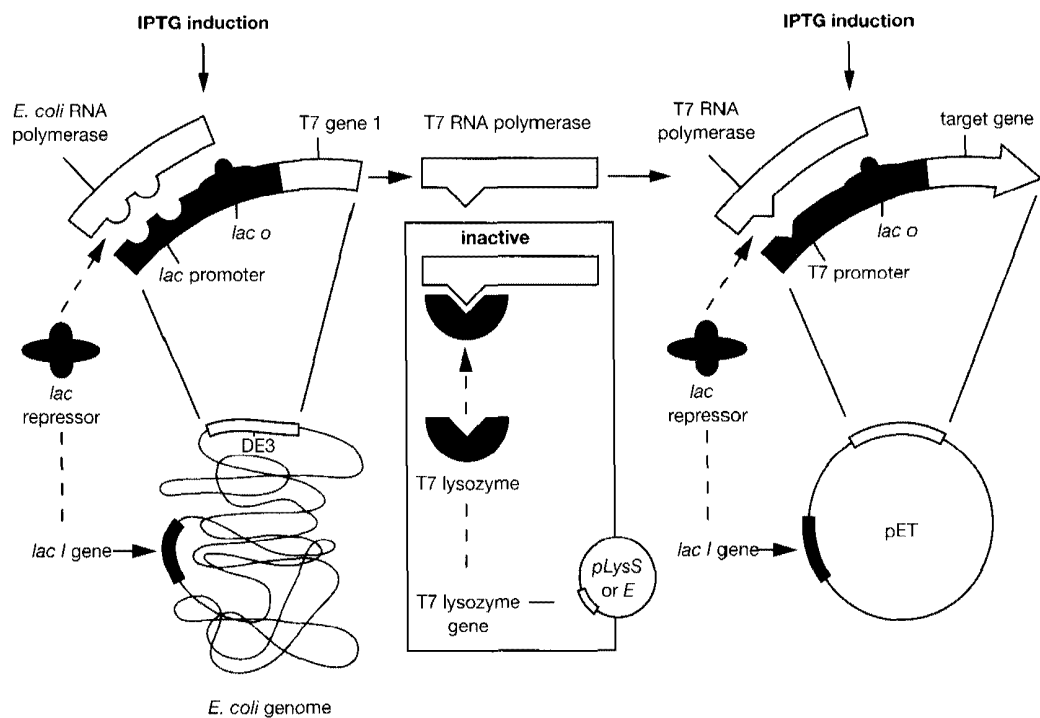
## Expression of Cloned Genes in *E. coli* Using the Bacteriophage T7 Promoter

**E**XPRESSION SYSTEMS USING THE BACTERIOPHAGE T7 PROMOTER, first developed by Tabor and Richardson (1985) and Studier and Moffatt (1986), employ transcription signals derived from the bacteriophage T7 genome. These systems have the following advantages.

- Bacteriophage T7 RNA polymerase, unlike *E. coli* RNA polymerase, is not inhibited by rifampicin. The antibiotic can therefore be used to extinguish transcription of host cell genes.
- The bacteriophage-encoded enzyme recognizes only bacteriophage T7 promoters, which are not present in the *E. coli* chromosomal DNA.
- Bacteriophage T7 RNA polymerase is a processive enzyme that will transcribe around a circular plasmid several times and may therefore transcribe genes that are not efficiently transcribed by *E. coli* RNA polymerase.

Two components are required for the bacteriophage T7 expression system (please see Figure 15-5). The first component is bacteriophage T7 RNA polymerase, which is the product of bacteriophage T7 gene 1. The polymerase can be provided by a cloned copy of the gene carried on an infecting bacteriophage  $\lambda$  vector, on a plasmid, or from a copy of the gene inserted into the *E. coli* chromosome (Tabor and Richardson 1985; Studier and Moffatt 1986). If the foreign protein is toxic to *E. coli*, the expression of bacteriophage T7 RNA polymerase must be curtailed during cell growth. This can be accomplished using the  $\lambda$  lysogen BL21(DE3), in which the bacteriophage T7 gene 1 is expressed under the control of the IPTG-inducible *lacUV5* promoter. Alternatively, gene 1 can be placed under control of a temperature-inducible promoter such as the bacteriophage  $\lambda$   $p_L$  sequence. In this situation, induction of the bacteriophage T7 RNA polymerase is accomplished by heat as described in Protocol 3. When attempting to express certain exquisitely toxic foreign gene products, it is necessary to use cells in which no bacteriophage T7 RNA polymerase is present until expression is induced. This goal is achieved by infecting the host cells (e.g., HMS174) harboring the expression plasmid with bacteriophage CE6 ( $\lambda$ Clts857 Sam7) carrying bacteriophage T7 gene 1 (Studier and Moffatt 1986).

The second component of the system is a plasmid vector equipped with a bacteriophage T7 promoter upstream of the gene to be expressed. The vector pET-3 is a derivative of pBR322 that carries the bacteriophage T7 gene 10 promoter ( $Pf_{10}$ ), a *Bam*HI cloning site, and the bacteriophage T7 transcription terminator (Tf) (Studier et al. 1990). Derivatives of pET-3 (e.g., pET-3a) have been constructed that include a bacteriophage T7 gene 10 translation start ( $S_{10}$ ) through



**FIGURE 15-5 Control Elements of the pET System**

Illustrated here are the host and vector elements that are available for control of T7 RNA polymerase levels and subsequent transcription of a target gene cloned in a pET vector. In  $\lambda$  DE3 lysogens, the T7 RNA polymerase gene is under control of the *lacUV5* promoter, which allows low levels of transcription in the uninduced state. For more stringent control of expression, hosts carrying either pLysS or pLysE are available. The pLys plasmids encode T7 lysozyme, a natural inhibitor of T7 RNA polymerase, and thus reduces its ability to transcribe target genes in uninduced cells. (Redrawn, with permission, from Novagen, Inc.)

codon 11. DNA can be inserted in each of the three translation reading frames at this codon to express fusion proteins. Commercially available antibodies (Novagen) directed against the gene 10 portion of the fusion protein can then be used to detect the expressed protein by immunoblotting. Other frequently used vectors:

- **Allow fusion to longer amino-terminal protein sequences**, which can stabilize shorter foreign polypeptides in *E. coli* (e.g., pET-3xa-c from Novagen).
- **Produce intact and secreted native proteins** by inserting sequences coding for foreign polypeptides at the *NdeI* site immediately preceding the ATG of gene 10 or by fusion to an amino-terminal periplasmic localization signal (pET-12a-c).
- **Generate proteins carrying a hexa-histidine sequence** that can be purified by affinity chromatography  $\text{Ni}^{2+}$  columns (e.g., pET-14b from Novagen).

In a lucid article describing the bacteriophage T7 promoter expression system, Studier et al. (1990) outline potential problems and solutions associated with the bacteriophage T7 system, discuss pros and cons of various bacterial strains, and describe the pET series of expression vectors. Because the T7 system expresses very high levels of the foreign gene/cDNA, the bacterial synthetic and processing apparatus can easily become overloaded. For this reason, methods that result in a slow induction or growth of cells often yield higher levels of foreign protein expression. The troubleshooting panel at the end of Protocol 1 provides further advice on these problems.

## MATERIALS

---

**CAUTION:** Please see Appendix 12 for appropriate handling of materials marked with <!>.

### Buffers and Solutions

Please see Appendix 1 for components of stock solutions, buffers, and reagents. Dilute stock solutions to the appropriate concentrations.

*Coomassie Brilliant Blue stain or Silver stain*

Please see Appendix 8.

*IPTG (1 M)*

*1x SDS gel-loading buffer*

Store 1x SDS gel-loading buffer lacking dithiothreitol at room temperature. Add dithiothreitol from a 1 M stock just before the buffer is used.

### Gels

*Polyacrylamide gel (10%) containing SDS <!>*

For the preparation of SDS-polyacrylamide gels used in the separation of proteins, please see Appendix 8.

### Nucleic Acids and Oligonucleotides

*Gene or cDNA fragment of interest*

### Media

*NZCYM agar plates containing 50 µg/ml ampicillin*

*NZCYM medium containing 50 µg/ml ampicillin*

### Centrifuges and Rotors

*Sorvall GSA rotor or equivalent*

### Special Equipment

*Boiling water bath*

### Additional Reagents

*Step 1 of this protocol requires the reagents listed in Chapter 8, Protocol 7.*

*Step 2 of this protocol requires the reagents listed in Chapter 1, Protocol 17 or 19.*

*Step 3 of this protocol requires the reagents listed in Chapter 1, Protocols 23–26.*

*Step 4 of this protocol requires the reagents listed in Chapter 12, Protocol 3.*

### Vectors and Bacterial Strains

*E. coli strains HMS174(DE3) or BL21(DE3)*

*pET vector or equivalent*

For the many variations of this plasmid series, please refer to the Novagen catalog (or Web Site at [www.novagen.com](http://www.novagen.com)).

*Positive control plasmid (e.g., carrying a bacteriophage T7 promoter that controls expression of a fusion protein of defined size)*

## METHOD

### Preparation of Bacteria Containing the Recombinant Expression Vector

1. Modify by PCR (Chapter 8, Protocol 7), or isolate by restriction enzyme digestion, a fragment of DNA carrying 5'- and 3'-restriction enzyme sites compatible with sites in a bacteriophage T7 promoter expression plasmid (e.g., pET vectors; Studier et al. 1990).  
 Constructs generated by PCR should be sequenced to ensure that no spurious mutations were introduced during the amplification reactions.  
 If necessary, position a strong ribosome-binding site upstream of the ATG of the cDNA/gene.
2. Ligate the DNA fragment containing the cDNA/gene of interest into the expression vector (Chapter 1, Protocol 17 or 19).
3. Transform *E. coli* strain BL21(DE3) or HMS174(DE3) with aliquots of the ligation reaction. Select for ampicillin-resistant transformants by plating aliquots of the transformation reaction on NZCYM agar plates containing 50 µg/ml ampicillin. Incubate the plates overnight at 37°C.  
 As a negative control, transform additional cells of the same strain of *E. coli* with an empty expression vector.
4. Screen the transformants by colony hybridization and/or restriction enzyme analysis, oligonucleotide hybridization, or direct DNA sequence analysis (please see Chapter 12, Protocol 3) of plasmid minipreparations.

### Optimization of the Induction of Target Protein Expression

Many studies point to the importance of the rate of cell growth on foreign protein expression. For this reason, it is important to monitor the number of bacteria inoculated into the growth medium, the length of time cells are grown before induction, and the density to which cells are grown after induction. Overgrowth or too rapid growth can overload the bacterial synthetic apparatus and promote formation of inclusion bodies.

5. Inoculate 1-ml cultures (NZCYM medium containing 50 µg/ml ampicillin) with a transformed colony containing positive control vectors, negative control vectors, and one containing the recombinant vector. Incubate the cultures overnight at 37°C to obtain a saturated culture.
6. Inoculate 5 ml of NZCYM medium containing 50 µg/ml ampicillin in a 50-ml flask with 50 µl of a saturated culture. Incubate the cultures for 2 hours at 37°C.
7. Transfer 1 ml of each culture (zero-time aliquot) to a microfuge tube. Immediately process the zero-time aliquots as described in Steps 9 and 10.
8. Induce the remainder of each culture by adding IPTG to a final concentration of 1.0 mM and continue incubation at 20–37°C with aeration.  
 Some vector systems express the bacteriophage T7 RNA polymerase from a heat-inducible promoter rather than from an IPTG-inducible promoter. For a discussion of factors that affect induction of protein expression, please see the note to Step 8 in Protocol 1.
9. At 0.5, 1, 2, and 3 hours after induction, transfer 1 ml of each culture to a microfuge tube, measure the  $A_{550}$  in a spectrophotometer, and centrifuge the tubes at maximum speed for 1 minute at room temperature in a microfuge. Remove the supernatants by aspiration.
10. Resuspend each pellet in 100 µl of 1X SDS gel-loading buffer, and heat the samples to 100°C for 3 minutes. Centrifuge the tubes at maximum speed for 1 minute at room temperature in a microfuge, and store them on ice until all of the samples are collected and ready to load on a gel.



11. Warm the samples to room temperature and load 0.15 OD<sub>550</sub> units (of original culture) or 40 µg of each suspension on a 10% SDS-polyacrylamide gel.
12. Run the gel at 8–15 V/cm until the bromophenol blue reaches the bottom of the resolving gel.
13. Stain the gel with Coomassie Brilliant Blue or silver, or carry out an immunoblot to visualize the induced protein (please see Appendix 8).

For cells expressing the vector alone, no difference in the protein pattern should be noted between untransformed *E. coli* cells and cells carrying the empty expression vector. For cells expressing the recombinant gene, a protein of the predicted molecular weight should be visible at some time point after induction.

### Large-scale Expression of the Target Protein

14. For large-scale expression and purification of the target protein, inoculate 50 ml of NZCYM containing 50 µg/ml ampicillin in a 250-ml flask with individual colonies of *E. coli* containing the recombinant and control plasmids. Incubate the cultures overnight at 37°C.
15. Inoculate 450–500 ml of NZCYM containing 50 µg/ml ampicillin in a 2-liter flask with 5–50 ml of overnight culture of *E. coli* containing the recombinant plasmid. Incubate the culture with shaking at 37°C until the culture has reached the mid-log phase of growth ( $A_{550} = 0.5–1.0$ ).
16. Induce expression of the target protein based on the optimal values of IPTG concentration, incubation time, and incubation temperature determined in the previous section.
17. After the induced cells have grown for the proper length of time, harvest the cells by centrifugation at 5000g (5500 rpm in a Sorvall GSA rotor) for 15 minutes at 4°C and proceed with a purification protocol:
  - Protocol 5 if the expressed protein is a fusion with glutathione S-transferase
  - Protocol 6 if the expressed protein is a fusion with maltose-binding protein
  - Protocol 7 if the expressed protein contains a polyhistidine tag

#### USING pLysS AND pLysE TO REGULATE BACTERIOPHAGE T7 RNA POLYMERASE ACTIVITY

Lysozyme encoded by bacteriophage T7, in addition to digesting peptidoglycan cell walls, has the ability to inhibit the virally encoded RNA polymerase. The former activity is not normally manifest in bacterial cells because the enzyme does not gain access to the cell wall. The latter activity can be used to inhibit the low level of RNA polymerase activity present in the uninduced state and therefore to stabilize plasmids that encode otherwise toxic foreign proteins.

The gene encoding bacteriophage T7 lysozyme is carried on two different plasmids termed pLysS and pLysE, which are compatible with the pET vectors and are commercially available (Novagen; please see Figure 15-5). Both plasmids encode resistance to chloramphenicol and are easily maintained by growth in the presence of 25 µg/ml of the antibiotic. Because of the arrangement of promoters on the plasmids, expression of lysozyme is low in cells carrying plasmid pLysS and high in cells carrying pLysE (Studier et al. 1990). Foreign genes encoding moderately toxic proteins are stable in the presence of pLysS, whereas genes encoding highly toxic proteins require pLysE for stability. Lysozyme expressed from these two plasmids increases the lag time between induction of the RNA polymerase and maximum expression of the foreign protein. This situation arises because enough RNA polymerase must be expressed to overcome inhibition by the lysozyme before the foreign gene can be transcribed.

The presence of the pLysS or pLysE plasmids and hence of viral lysozyme within an expressing *E. coli* cell can be exploited to facilitate lysis of cells at the time of harvest (please see Figure 15-5). Treatments that allow the intracellular lysozyme access to the cell wall lead to rapid cell lysis. Cells with these plasmids lyse spontaneously after resuspension in cell wash buffer and several cycles of freezing and thawing. Alternatively, lysis can be accomplished by resuspending the cells in wash buffer containing 0.1% (v/v) Triton X-100.

# Protocol 3

---

## Expression of Cloned Genes in *E. coli* Using the Bacteriophage $\lambda$ $p_L$ Promoter

**T**HE POWERFUL BACTERIOPHAGE  $\lambda$   $p_L$  PROMOTER IS REGULATED by a temperature-sensitive repressor, *cI*s857, which represses transcription at low, but not at elevated, temperatures. *E. coli* strains harboring the *cI*s857 gene must therefore be used as hosts with vectors carrying the  $\lambda$   $p_L$  promoter. The repressor gene is usually present on a defective  $\lambda$  prophage, which also encodes the  $\lambda$  N protein, an antagonist of transcription termination. The antitermination function of the N gene product can enhance expression by facilitating RNA polymerase readthrough of spurious termination sites within the foreign cDNA/gene. The  $p_L$  vectors therefore have two useful properties: They are efficiently repressed at low temperatures and they are floridly induced at high temperatures.

A potential drawback of  $p_L$  vectors is that the temperature shift induces not only the  $p_L$  promoter, but also the cellular heat shock genes, some of which encode proteases (Buell et al. 1985). A related problem is that heat induction may cause thermal denaturation of the expressed protein and subsequent formation of aggregates or inclusion bodies. These problems can be alleviated by using a lysogenic host carrying a bacteriophage  $\lambda$  *cI*<sup>+</sup> lysogen that can be induced with mitomycin C or nalidixic acid (Shatzman and Rosenberg 1987). Alternatively, problems can be avoided by using a *cI* gene whose expression is controlled by the tryptophan promoter/operator (Mieschendahl et al. 1986; LaVallie et al. 1993). The use of tryptophan-inducible systems, including a vector system that employs thioredoxin fusion proteins, is discussed in more detail in the panel on **TRYPTOPHAN-INDUCIBLE EXPRESSION SYSTEMS** on the following page.

Several different  $p_L$  vectors are available, including the pHUB series (Bernard and Helinski 1979), pPLc series (Remaut et al. 1981), pKC30 (Rao 1984), pAS1 (Rosenberg et al. 1983), pRM1/pRM9 (Mieschendahl et al. 1986), and pTrxFus (LaVallie et al. 1993). The transcription/translation signals in these vectors vary considerably, and the primers used during PCR to modify the cDNA/gene to be expressed must therefore be designed appropriately. Other vector systems that rely on the *cI*s857 repressor to regulate expression from the bacteriophage  $\lambda$   $p_R$  promoter and carry the repressor gene on the expression plasmid itself have been described previously (e.g., pCQV2; Queen 1983). These vectors are useful when complete shut off of the uninduced bacteriophage promoter is required. For a description of variables that affect the expression of foreign proteins in *E. coli*, please see the troubleshooting panel at the end of Protocol 1.

**TRYPTOPHAN-INDUCIBLE EXPRESSION SYSTEMS**

Mieschendahl et al. (1986) described a binary expression system consisting of a plasmid vector carrying a bacteriophage  $\lambda$   $p_L$  promoter and an integrated copy of a wild-type *cl* gene whose expression is inducible by tryptophan. When cells carrying the plasmid vector are propagated in medium containing low concentrations of tryptophan, the wild-type bacteriophage repressor is efficiently expressed, and foreign genes controlled by the  $p_L$  promoter are repressed. Addition of tryptophan to the medium suppresses synthesis of the *cl* gene product and leads to an induction of the powerful  $p_L$  promoter and efficient expression of the foreign protein.

Tryptophan-inducible systems have several advantages over temperature-inducible systems. First, growth and induction are carried out at 37°C, a temperature at which synthesis of heat shock proteins is not markedly induced. Second, induction with tryptophan is accomplished by supplementation of the medium, a simpler task than heat induction. Third, regulation is tighter because the wild-type *cl* repressor has a higher affinity for the  $p_L$  operator than the *cts857*-encoded protein. Finally, *E. coli* strain GI724 contains the *cl* gene linked to the *Salmonella typhimurium* *trp* promoter/operon integrated into the *ampC* locus of the bacterial chromosome. This genetic arrangement is more stable than other tryptophan-regulated *cl* genes that are present on the F' episome, and for this reason, GI724 is the host cell of choice.

LaVallie et al. (1993) have described a variation of the  $p_L$ -*cl* bacterial expression system in which the foreign protein of interest is expressed as a fusion protein with *E. coli* thioredoxin, a small (11.7 kD) cytoplasmic protein. This system combines a tryptophan-inducible *cl* gene, the bacteriophage  $\lambda$   $p_L$  promoter, and fusion protein technology. All of the advantages associated with the expression of a foreign molecule as a fusion protein accrue in this system, including reduced formation of insoluble inclusion bodies containing the foreign protein, enhanced stability of the product, the ability to purify the fusion protein by simple procedures, and proteolytic release of the foreign protein from the fusion partner. Other examples of fusion-protein-based expression systems are the glutathione *S*-transferase system, the  $\beta$ -galactosidase system, and the maltose-binding protein.

Purification of fusion proteins produced in this system takes advantage of two properties of thioredoxin: (1) a unique subcellular association within the expressing cell (at adhesion zones) that usually allows release of the fusion protein into the medium after osmotic shock or freeze/thawing and (2) an enhanced thermal stability that allows enrichment of the fusion protein by incubation of cell lysates at high temperature (LaVallie et al. 1993). The components of the thioredoxin fusion protein expression system are available from Invitrogen Corp.

**MATERIALS**

**CAUTION:** Please see Appendix 12 for appropriate handling of materials marked with <!>.

**Buffers and Solutions**

Please see Appendix 1 for components of stock solutions, buffers, and reagents. Dilute stock solutions to the appropriate concentrations.

*Coomassie Brilliant Blue stain or Silver stain*

Please see Appendix 8.

*1x SDS gel-loading buffer*

Store 1x SDS gel-loading buffer lacking dithiothreitol at room temperature. Add dithiothreitol from a 1 M stock just before the buffer is used.

*L-Tryptophan (10 mg/ml)*

**Gels**

*Polyacrylamide gel (10%) containing SDS <!>*

For preparation of SDS-polyacrylamide gels used in the separation of proteins, please see Appendix 8.

**Nucleic Acids and Oligonucleotides**

*Gene or cDNA fragment of interest*

## Media

*LB agar plates*

*LB medium*

Depending on the vector used, the LB medium and agar plates will require supplementation with various antibiotics.

*LB medium heated to 65°C*

Optional, please see Step 13.

*M9 minimal medium*

After sterilization, supplement this medium with 0.5% (w/v) glucose, 0.2% (w/v) casamino acids, and antibiotics as needed. This medium is used with tryptophan-inducible  $cI$ -gene-based  $p_L$  expression vectors.

## Centrifuges and Rotors

*Sorvall GSA rotor or equivalent*

## Special Equipment

*Boiling-water bath*

*Shaking incubators preset to 30°C and 40°C*

These incubators are required only if a temperature-sensitive allele of the bacteriophage  $\lambda$   $cI$  gene is used.

## Additional Reagents

*Step 1 of this protocol requires the reagents listed in Chapter 8, Protocol 7.*

*Step 2 of this protocol requires the reagents listed in Chapter 1, Protocol 17 or 19.*

*Step 3 of this protocol requires the reagents listed in Chapter 1, Protocols 23–26.*

*Step 4 of this protocol requires the reagents listed in Chapter 12, Protocol 3.*

## Vectors and Bacterial Strains

*E. coli harboring either the  $ts857$  allele or wild-type allele of the bacteriophage  $\lambda$   $cI$  gene*

In strain M5219, the  $cI_{ts857}$  allele is inducible by heat shock. Strain GI724 (ATCC 55151  $cI$  gene) harbors a tryptophan-inducible wild-type  $cI$  gene.

*$p_L$  Expression vector (e.g.,  $pHUB$ ,  $pPLc$ ,  $pKC30$ ,  $pAS1$ ,  $pCQV2$ ,  $pAL-781$ , and  $pTrxFus$ )*

*Positive control (e.g., a  $p_L$  expression vector encoding a fusion protein of defined size)*

## METHOD

---

### Preparation of Bacteria Containing the Recombinant Expression Vector

1. Modify by PCR (Chapter 8, Protocol 7), or isolate by restriction enzyme digestion, a fragment of DNA carrying 5'- and 3'-restriction enzyme sites compatible with sites in a  $p_L$  expression vector.  
If necessary, position a strong ribosome-binding site upstream of the initiating ATG of the cDNA/gene.  
Constructs generated by PCR should be sequenced to ensure that no spurious mutations were introduced during the amplification reactions.
2. Ligate the DNA fragment containing the cDNA/gene of interest into the expression vector (Chapter 1, Protocol 17 or 19).
3. Transform an *E. coli* strain containing the  $cI_{ts857}$  allele or wild-type  $cI$  gene with aliquots of the ligation reaction. Plate aliquots of the transformation reaction on LB medium containing the appropriate selective antibiotic (usually ampicillin at 50  $\mu$ g/ml), and incubate the cultures

overnight at 30°C (strains harboring the *clts857* allele) or at 37°C (strains harboring a tryptophan-inducible wild-type *cl* gene).

As a negative control, transform additional cells of the same strain of *E. coli* with the empty expression vector.

4. Screen the transformants by colony hybridization and/or restriction enzyme analysis, oligonucleotide hybridization, or direct DNA sequence analysis of plasmid minipreparations (please see Chapter 12, Protocol 3).

### Optimization of the Induction of Target Protein Expression

Many studies point to the importance of the rate of cell growth on foreign protein expression. For this reason, it is important to monitor the number of bacteria inoculated into the growth medium, the length of time cells are grown before induction, and the density to which cells are grown after induction. Overgrowth or too rapid growth can overload the bacterial synthetic apparatus and promote formation of inclusion bodies.

5. Determine the optimum conditions for the induction of target protein expression, which is driven by the down-regulation of the *cl* repressor protein, either by an increase in temperature or by the presence of tryptophan.

For a discussion of factors that affect induction, please see the note to Step 8 in Protocol 1.

#### WHEN USING A TEMPERATURE-INDUCIBLE SYSTEM

- a. Inoculate 1-ml cultures of LB medium containing the appropriate antibiotics with 1 or 2 colonies of *E. coli* (carrying the *clts857* allele) containing the empty expression vector, and 1 or 2 colonies containing the recombinant expression vector. Incubate the cultures overnight at 30°C.  
Include as positive control an expression vector encoding a protein of known size.
- b. Inoculate 10 ml of LB medium containing antibiotic in a 50-ml flask with 50  $\mu$ l of an overnight culture. Grow the culture to the mid-log phase of growth ( $A_{550} = 0.5-1.0$ ) at 30°C.
- c. Transfer 1 ml of each uninduced culture (zero-time aliquot) to microfuge tubes. Immediately process the zero-time aliquots as described in Steps 6 and 7.
- d. Induce the remainder of each culture by shifting the incubation temperature to 40°C. Proceed to Step 6.

Although 42–45°C is used elsewhere in this manual to inactivate the bacteriophage  $\lambda$  *clts857* gene product, 40°C is used here to reduce the induction of heat shock proteins and to allow growth of the cells to continue.

#### WHEN USING A TRYPTOPHAN-INDUCIBLE SYSTEM

- a. Inoculate 1-ml cultures of supplemented M9 medium with 1 or 2 colonies of *E. coli* (carrying the *cl* wild-type allele) containing the empty expression vector, and 1 or 2 colonies containing the recombinant expression vector. Incubate the cultures overnight at 37°C.  
Include as positive control an expression vector encoding a protein of known size.
- b. Inoculate 10 ml of supplemented M9 medium in a 50-ml flask with 50  $\mu$ l of the overnight cultures. Grow the cultures to the mid-log phase of growth ( $A_{550} = 0.5-1.0$ ) at 37°C.
- c. Transfer 1 ml of each uninduced culture (zero-time aliquot) to microfuge tubes. Immediately process the zero-time aliquots as described in Steps 6 and 7.

- d. Induce the remainder of each culture by adding tryptophan to a final concentration of 100  $\mu\text{g/ml}$  and continue incubation at 37°C.
6. At various time points during the induction period (e.g., 1, 2, 4, and 6 hours), transfer 1 ml of each culture to a microfuge tube, measure the  $A_{550}$  in a spectrophotometer, and centrifuge the tubes at maximum speed for 1 minute at room temperature in a microfuge. Remove the supernatants by aspiration.
7. Resuspend each pellet in 100  $\mu\text{l}$  of 1x SDS gel-loading buffer, and heat the samples to 100°C for 3 minutes. Centrifuge the tubes at maximum speed for 1 minute at room temperature in a microfuge and store them on ice until all of the samples are collected and ready to load on a gel.
8. Warm the samples to room temperature and load 0.15  $\text{OD}_{550}$  units (of original culture) or 40  $\mu\text{g}$  of each suspension on a 10% SDS-polyacrylamide gel.
9. Run the gel at 8–15 V/cm until the bromophenol blue reaches the bottom of the resolving gel.
10. Stain the gel with Coomassie Brilliant Blue or silver, or carry out an immunoblot to visualize the induced protein (please see Appendix 8).

For cells expressing the vector alone, no difference in the protein pattern should be noted between untransformed *E. coli* cells and cells carrying the empty expression vector. For cells expressing the recombinant gene, a protein of the predicted molecular weight should become visible at some time point after induction.

### Large-scale Expression of the Target Protein

11. For large-scale expression and purification of the target protein, inoculate 50 ml of LB containing antibiotic or supplemented M9 medium in a 250-ml flask with a colony of *E. coli* containing the recombinant construct. Incubate the cultures overnight at 30°C or at 37°C, respectively.
12. Inoculate 450 ml of LB plus antibiotic or supplemented M9 medium in a 2-liter flask with 50-ml overnight cultures of *E. coli* containing the recombinant plasmids. Incubate the cultures with agitation at 30°C or 37°C, respectively, until the cultures have reached the mid-log phase of growth ( $A_{550} = 0.5\text{--}1.0$ ). Induce the culture according to either Step 13 or 14, as appropriate.
13. Induce the *E. coli* culture carrying the *cIts857* allele by the addition of 500 ml of LB medium heated to 65°C. Incubate the culture at 40°C for the optimum time period determined in the previous section.
 

Alternatively, collect the bacterial cells by centrifugation at 12,000g (8600 rpm in a Sorvall GSA rotor) for 5 minutes at room temperature. Then resuspend the pellet in 500 ml of LB medium warmed to 40°C, and incubate the culture at 40°C for the optimum time period determined in Step 5.
14. Induce the *E. coli* culture carrying the *cI* allele by the addition of tryptophan to 100  $\mu\text{g/ml}$ . Incubate the culture at 37°C for the optimum time period determined in the previous section.
15. After the induced cells have grown for the proper length of time, harvest the cells by centrifugation at 5000g (5500 rpm in a Sorvall GSA rotor) for 15 minutes at 4°C and proceed with a purification protocol:
  - Protocol 5 if the expressed protein is a fusion with glutathione S-transferase
  - Protocol 6 if the expressed protein is a fusion with maltose-binding protein
  - Protocol 7 if the expressed protein contains a polyhistidine tag

# Protocol 4

---

## Expression of Secreted Foreign Proteins Using the Alkaline Phosphatase Promoter (*phoA*) and Signal Sequence

**F**OR SOME PROTEINS, EXPORT TO THE PERIPLASMIC SPACE HAS ADVANTAGES over conventional expression in the cytosol:

- Some proteins that are degraded by intracellular proteases are stable in the periplasm (Talmadge et al. 1980).
- Some proteins that are inactive when produced intracellularly are active when exported; secretion may allow them to be properly folded (Gray et al. 1985). The *phoA* system has been used to export human epidermal growth factor (hEGF) into the periplasm of *E. coli* (Oka et al. 1985). The exported hEGF contained the correctly processed amino terminus and normal biological activity, indicating that the three disulfide bonds of hEGF were correctly formed.
- Proteins are produced that do not have an amino-terminal methionine, since cleavage occurs between the signal peptide and the coding sequence.

The two major problems encountered in the export of foreign proteins are that yields are often low, and cleavage of the signal peptide may not occur or may occur at an inappropriate position (Yuan et al. 1990). These problems may sometimes be remedied by inserting spacer amino acids between the signal sequence cleavage site and the foreign protein or by using *E. coli* strains that overexpress one or more of the signal peptidase genes.

In this protocol, export is accomplished by fusing the coding sequence to DNA encoding the *phoA* signal peptide, which is cleaved by the bacterial signal peptidase as the protein is exported into the space between the inner and outer membranes of *E. coli*. The *phoA* gene encodes the alkaline phosphatase component (the same enzyme used to dephosphorylate nucleic acids) of the phosphate scavenging system of *E. coli* and is repressed under conditions of excess phosphate. However, as phosphate becomes limiting in the medium (i.e., as the bacterial culture enters the lag phase of growth), the genes in the *pho* operon are gradually induced to high levels. The consequences of this regulation for *phoA* expression purposes are twofold. First, a gradual build up of the foreign protein occurs in the cell, instead of the acute induction that occurs with other regulated promoter systems. The slower build up decreases the chance of overloading components of the bacterial expression system and the formation of inclusion bodies. Second, the gradual build up allows the expression of foreign polypeptides that might be toxic if induced to high levels over a short period of time.

**MATERIALS**

**CAUTION:** Please see Appendix 12 for appropriate handling of materials marked with <!>.

**Buffers and Solutions**

Please see Appendix 1 for components of stock solutions, buffers, and reagents. Dilute stock solutions to the appropriate concentrations.

*Coomassie Brilliant Blue stain or Silver stain*

Please see Appendix 8.

*Micronutrients (used in 10x MOPS salts)*

37 mg  $(\text{NH}_4)_6\text{Mo}_7\text{O}_{24}\cdot 4\text{H}_2\text{O}$

84 mg  $\text{CoCl}_2$

158 mg  $\text{MnCl}_2\cdot 4\text{H}_2\text{O}$

247 mg  $\text{H}_3\text{BO}_3$

25 mg  $\text{CuSO}_4$

18 mg  $\text{ZnSO}_4$

Dissolve in a final volume of 10 ml and sterilize by filtration. Store at 4°C.

*10x MOPS salts (used in induction medium)*

400 mM 3-(*N*-morpholino)propanesulfonic acid (pH 7.4) (MOPS) <!>

40 mM Tricine (pH 7.4)

0.1 mM  $\text{FeSO}_4\cdot 7\text{H}_2\text{O}$

95 mM  $\text{NH}_4\text{Cl}$

2.8 mM  $\text{K}_2\text{SO}_4$

5  $\mu\text{M}$   $\text{CaCl}_2\cdot 2\text{H}_2\text{O}$

5.3 mM  $\text{MgCl}_2\cdot 6\text{H}_2\text{O}$

0.5 M NaCl

Dissolve in a final volume of 1 liter, and sterilize by filtration. Add 10  $\mu\text{l}$  of micronutrients per liter before use.

*Neutral phosphate buffer (1 M) (used in induction medium)*

An equimolar mix of 1 M  $\text{Na}_2\text{HPO}_4$  and 1 M  $\text{NaH}_2\text{PO}_4$ .

*1x SDS gel-loading buffer*

Store 1x SDS gel-loading buffer lacking dithiothreitol at room temperature. Add dithiothreitol from a 1 M stock just before the buffer is used in Step 8.

**Gels***Polyacrylamide gel (10%) containing SDS <!>*

For the preparation of SDS-polyacrylamide gels used in the separation of proteins, please see Appendix 8.

**Nucleic Acids and Oligonucleotides***Gene or cDNA fragment of interest***Media***Induction medium*

1x MOPS salts (for recipe, please see Buffers and Solutions above)

0.2% (w/v) glucose

0.2% (w/v) casamino acids (vitamin assay quality; DIFCO)

20  $\mu\text{g}/\text{ml}$  adenine

0.5  $\mu\text{g}/\text{ml}$  thiamine

0.1 M neutral phosphate buffer (for recipe, please see Buffers and Solutions above)

Combine the ingredients to a final volume of 1 liter in  $\text{H}_2\text{O}$ . Sterilize by filtration and store at 4°C.

This low-phosphate medium, which is used to induce transcription of the *phoA* promoter, was originally developed as a minimal salts medium for isotopic labeling (Neidhardt et al. 1974). Although difficult to prepare, this medium consistently provides the highest level of induction.



*LB agar plates containing 50 µg/ml ampicillin*  
*LB medium containing 50 µg/ml ampicillin*

### Centrifuges and Rotors

*Sorvall GSA rotor or equivalent*  
*Sorvall SS-34 rotor or equivalent*

### Special Equipment

*Boiling water bath*

### Additional Reagents

*Step 1 of this protocol requires the reagents listed in Chapter 8, Protocol 7.*  
*Step 2 of this protocol requires the reagents listed in Chapter 1, Protocol 17 or 19.*  
*Step 3 of this protocol requires the reagents listed in Chapter 1, Protocols 23–26.*  
*Step 4 of this protocol requires the reagents listed in Chapter 12, Protocol 3.*

### Vectors and Bacterial Strains

#### *E. coli strain*

Essentially any strain of *E. coli* can be used to express genes cloned in *phoA* vectors. Oka et al. (1985) reported a fivefold higher yield of foreign protein in strain YK537 than strain C600. Strain YK537 carries the *phoA8* mutation, an internal deletion in the alkaline phosphatase gene. However, the difference in expression between these two strains is probably not due to this mutation, as the expression of foreign proteins in isogenic wild-type or *phoA8* strains does not differ (B.L. Wanner, pers. comm.).

If the foreign protein is not toxic, then bacterial strains containing *phoR* mutations can be used. Because wild-type *phoR* genes encode the repressor of the *pho* operon, *phoR* mutant strains constitutively express genes controlled by the *phoA* promoter (Wanner 1987). As with all bacterial expression systems, it may be necessary to try more than one *E. coli* strain to optimize synthesis/export of a given foreign protein (Weikert et al. 1998). The various strains should also be grown at different temperatures to maximize expression levels and protein stability (please see Protocol 1).

#### *pTA1529 or pBAce*

Plasmid pTA1529 is described by Oka et al. (1985). pBAce is available from C.C. Wang (Department of Pharmaceutical Chemistry, University of California, San Francisco).

## METHOD

---

### Preparation of Bacteria Containing the Recombinant Expression Vector

1. Modify by PCR (Chapter 8, Protocol 7), or isolate by restriction enzyme digestion, a fragment of DNA carrying 5'- and 3'-restriction enzyme sites compatible with the polycloning sites in pTA1529 or pBAce.

Constructs generated by PCR should be sequenced to ensure that no spurious mutations were introduced during the amplification reactions.

2. Ligate the DNA fragment containing the cDNA/gene of interest into the expression vector (Chapter 1, Protocol 17 or 19).
3. Transform an appropriate *E. coli* strain with aliquots of the ligation reaction. Plate aliquots of the transformation reaction on LB agar containing 50 µg/ml ampicillin, and incubate the cultures overnight at 37°C.  
As a negative control, transform additional cells of the same strain of *E. coli* with the empty expression vector.
4. Screen the transformants by colony hybridization and/or restriction enzyme analysis, oligonucleotide hybridization, or direct DNA sequence analysis (please see Chapter 12, Protocol 3) of plasmid minipreparations.

### Optimization of the Induction of Target Protein Expression

Numerous studies point to the importance of the rate of cell growth on foreign protein expression. For this reason, it is important to monitor the number of bacteria inoculated into the growth medium, the length of time cells are grown before induction, and the density to which cells are grown after induction. Overgrowth or too rapid growth can overload the bacterial synthetic apparatus and promote formation of inclusion bodies.

5. Inoculate 1-ml cultures of LB medium containing 50 µg/ml ampicillin with one to two colonies containing the empty expression vector, and one to two colonies containing the recombinant and control plasmids. Incubate the cultures overnight at 37°C.
6. Inoculate 5 ml of induction medium containing 50 µg/ml ampicillin in a 50-ml flask with 50 µl of an overnight culture. Incubate the cultures with shaking at 20–37°C.  
For a discussion of factors that affect induction, please see the note to Step 8 in Protocol 1.
7. At various time points after inoculation (e.g., 0, 6, 12, 18, and 24 hours), transfer 1 ml of each culture to a microfuge tube, measure the  $A_{550}$  in a spectrophotometer, and centrifuge the tubes at maximum speed for 1 minute at room temperature in a microfuge. Remove the supernatants by aspiration.  
The kinetics of induction from the *phoA* promoter are slower than those of other promoters, because induction occurs with gradual depletion of phosphate from the medium. The optimum growth temperature will vary with each foreign protein to be expressed and must be established empirically.
8. Resuspend each pellet in 100 µl of 1x SDS gel-loading buffer, and heat the samples to 100°C for 3 minutes. Centrifuge the tubes at maximum speed for 1 minute at room temperature in a microfuge, and store them on ice until all of the samples are collected and ready to load on a gel.
9. Warm the samples to room temperature and load 0.15  $OD_{550}$  units (of original culture) or 40 µg of each suspension on a 10% SDS-polyacrylamide gel.
10. Run the gel at 8–15 V/cm until the bromophenol blue reaches the bottom of the resolving gel.
11. Stain the gel with Coomassie Brilliant Blue or silver, or carry out an immunoblot to visualize the induced protein (please see Appendix 8).

When using the signal sequence of the *phoA* gene to direct secretion of the foreign protein, perform the additional protocol on **SUBCELLULAR LOCALIZATION OF PHOA FUSION PROTEINS** (p. 15.35) to determine the subcellular location of the protein by cell fractionation.

### Large-scale Expression of the Target Protein

12. For large-scale expression and purification of the target protein, inoculate 25 ml of LB medium containing 50 µg/ml ampicillin in a 125-ml flask with a colony of *E. coli* containing the recombinant *phoA* construct. Incubate the culture overnight with agitation at 37°C.
13. Collect the cells by centrifugation at 5000g (6500 rpm in a Sorvall SS-34 rotor) for 15 minutes. Resuspend the cell pellet in 25 ml of induction medium, and collect the cells again by centrifugation.
14. Resuspend the washed cells in 2.5 ml of fresh induction medium, and inoculate the cells into 500 ml of induction medium in a 2-liter flask. Incubate the large-scale culture at the optimum temperature and for the optimum time determined in the previous section.
15. After the cells have grown for the proper length of time, harvest the cells by centrifugation at 4000g (5000 rpm in a Sorvall GSA rotor) for 15 minutes at 4°C.

If a *phoA* expression vector with a signal sequence was used and if the results of the additional protocol indicate that the foreign protein is efficiently exported to the periplasm, then the expressed protein can be purified by osmotic shock as described in the additional protocol. If a *phoA* expression vector without a signal sequence was used, then the foreign protein must be purified by conventional chromatography.

**ADDITIONAL PROTOCOL: SUBCELLULAR LOCALIZATION OF PHO A FUSION PROTEINS**

Accurate measurements of the distribution of PhoA fusion proteins among different cellular compartments requires the use of marker enzymes to assay purification of each of the subcellular fractions (periplasmic space, membrane, and cytoplasm) (Guzman-Verduzco and Kupersztoch 1990). This protocol, although not quantitative, should provide preliminary information on the cellular location of PhoA fusion proteins.

**Additional Materials***Cell lysis buffer*

- 1 mg/ml lysozyme
- 20% (w/v) sucrose
- 30 mM Tris-Cl (pH 8.0)
- 1 mM EDTA (pH 8.0)

*2x SDS Gel-loading buffer*

- 100 mM Tris-Cl (pH 6.8)
- 200 mM dithiothreitol
- 4% SDS (w/v) (electrophoresis grade)
- 0.2% (w/v) bromophenol blue
- 20% (v/v) glycerol

Store 2x SDS gel-loading buffer lacking dithiothreitol at room temperature. Add dithiothreitol from a 1 M stock just before the buffer is used.

*Tris-Cl (0.1 M, pH 8.0)***Methods**

1. Transfer 1 ml of the induced culture containing the highest quantity of the foreign protein to a microfuge tube. Recover the cells by centrifugation at maximum speed for 1 minute at 4°C in a microfuge.

Check the supernatant medium for the presence of secreted protein. To do so, add an equal volume of ice-cold 20% (w/v) trichloroacetic acid to the supernatant. Incubate the acidified solution on ice for at least 20 minutes. Centrifuge the solution at maximum speed for 20 minutes in a microfuge and discard the supernatant. Wash the pellet with 1 ml of ethanol and recover the pellet by centrifugation at maximum speed for 5 minutes in a microfuge. Repeat the ethanol wash and resuspend the pellet in 40 µl of 1x SDS gel-loading buffer. Analyze 20 µl of the sample on an SDS-polyacrylamide gel (Step 7).

2. Suspend the cell pellet in 100 µl of a freshly prepared solution of cell lysis buffer and store the suspension on ice for 10 minutes.

The use of lysozyme to generate spheroplasts has two potential drawbacks. First, contaminating lytic enzymes in some commercial preparations of lysozyme can lyse the bacterial cells. Second, if the foreign protein of interest has a molecular weight similar to that of lysozyme (~15,000), the presence of lysozyme in the buffer can obscure visualization of the expressed protein on stained polyacrylamide gels. Other methods for the preparation of spheroplasts can be tried, including those using reduced concentrations of lysozyme (Marvin and Witholt 1987), osmotic shock, treatment with chloroform (Ames et al. 1984), and use of the peptide antibiotic polymyxin B (Cerny and Teuber 1971). To release polypeptides into the periplasmic space by the latter method, resuspend the cells at Step 1 in 100 µl of 400 µg/ml polymyxin B and incubate on ice for 2 hours. Centrifuge the treated cells as in Step 1. The supernatant contains the periplasmic proteins and the cell pellet contains the cytoplasmic and membrane proteins, which can be further fractionated as described in Steps 4 and 5.

3. Recover the cells by centrifugation as in Step 1. The supernatant is the periplasmic fraction, which should be stored on ice until Step 6.
4. Resuspend the cell pellet in 100 µl of 0.1 M Tris-Cl (pH 8.0) and lyse the cells by freezing and thawing (i.e., place the cells on dry ice to freeze and then thaw them at 37°C; repeat this process twice more).
5. Centrifuge the suspension at maximum speed for 5 minutes at 4°C in a microfuge. The cytoplasmic proteins are found mainly in the supernatant. Resuspend the pellet, which contains the membrane fraction and insoluble inclusion bodies, in 100 µl of 0.1 M Tris-Cl (pH 8.0).

To release the PhoA fusion proteins from the periplasmic space, please see the panel on page 15.43.

6. Add an equal volume of 2x SDS gel-loading buffer to each of the subcellular fractions, mix the solutions well, and then heat the samples to 100°C for 3 minutes. Centrifuge the boiled samples at maximum speed for 1 minute at room temperature in a microfuge.
7. Load an equal volume from each of the fractions on a 10% SDS-polyacrylamide gel.
8. Run the gel at 8–15 V/cm until the bromophenol blue reaches the bottom of the resolving gel.
9. Stain the gel with Coomassie Brilliant Blue to determine the subcellular location of the foreign protein and how effectively the protein is secreted into the periplasm.

# Protocol 5

---

## Purification of Fusion Proteins by Affinity Chromatography on Glutathione Agarose

**F**USION PROTEINS EXPRESSED FROM PGEX VECTORS CONTAIN A GLUTATHIONE *S*-transferase (GST) moiety and can therefore be purified to near homogeneity by affinity chromatography on glutathione-agarose. GSTs are a class of enzymes that utilize glutathione ( $\gamma$ -glutamylcysteinylglycine) as a substrate to inactivate toxic small molecules via formation of mercapturic acids (Jakoby and Ziegler 1990). Because the affinity of GST for its substrate is in the submillimolar range, immobilization of glutathione on an agarose matrix makes a highly efficient affinity chromatography resin. Bound GST fusion proteins are readily displaced from the column by elution with buffers containing free glutathione. The glutathione-agarose resin can then be regenerated by treatment with buffers containing 3 M NaCl.

The capacity of the glutathione-agarose for GST fusion proteins is high (8 mg of fusion protein per 1 ml of bed volume of resin). With fusion protein production in the range of 0.1–10 mg/liter of *E. coli* culture, this capacity means that lysate from 1 liter of *E. coli* can be fractionated on 1 ml of resin.

This protocol uses a batch method to bind, wash, and release the fusion protein from the affinity resin. Although the method is rapid, conventional chromatography using small disposable columns is sometime preferable because it allows smaller amounts of elution buffer to be used, resulting in a higher concentration of protein in the eluate.

### MATERIALS

---

**CAUTION:** Please see Appendix 12 for appropriate handling of materials marked with <!>.

#### Buffers and Solutions

Please see Appendix 1 for components of stock solutions, buffers, and reagents. Dilute stock solutions to the appropriate concentrations.

*Dithiothreitol (1 M)*

*Glutathione elution buffer*

10 mM reduced glutathione

50 mM Tris-HCl (pH 8.0)

*Phosphate-buffered saline (PBS) (4°C)*

*Triton X-100 (0.2% v/v)*

## Enzymes and Buffers

*DNase (5 mg/ml)*

*Lysozyme*

*RNase (5 mg/ml)*

*Thrombin, Enterokinase, or Factor Xa solution*

Follow the manufacturer's instructions for the preparation and storage of these proteases.

## Gels

*Polyacrylamide gel (10%) containing SDS <!>*

For preparation of SDS-polyacrylamide gels used in the separation of proteins, please see Appendix 8.

## Centrifuges and Rotors

*Sorvall SS-34 rotor or equivalent*

## Special Equipment

*Glutathione-agarose resin*

If necessary, adjust the concentration of the resin with 20% ethanol to make a 50% (v/v) slurry.

*Hypodermic needles (18-, 22-, and 25-gauge)*

## Vectors and Bacterial Strains

*E. coli cells expressing a recombinant GST fusion protein (cell pellet generated in Step 17 of Protocol 1 or 2)*

## METHOD

---

### Preparation of the Glutathione-Agarose Resin

1. Gently invert the container of the glutathione-agarose resin to mix the slurry.
2. Transfer an aliquot of the slurry to a 15-ml polypropylene tube (2 ml of the slurry will be needed for each 100 ml of the original bacterial culture).
3. Centrifuge the tube at 500g (2100 rpm in a Sorvall SS-34 rotor) for 5 minutes at 4°C. Carefully remove and discard the supernatant.
4. Add 10 bed volumes of cold PBS to the resin, and mix the slurry by inverting the tube several times. Centrifuge the tube at 500g (2100 rpm in a Sorvall SS-34 rotor) for 5 minutes at 4°C. Carefully remove and discard the supernatant.
5. Add 1 ml of cold PBS per milliliter of resin to make a 50% slurry. Mix the slurry by inverting the tube several times. Keep the suspension on ice until the cell extract has been prepared.

### Preparation of Cell Extract

6. Resuspend the cell pellet (e.g., from Protocol 1, Step 17) in 4 ml of PBS per 100 ml of cell culture.

7. Add lysozyme to a final concentration of 1 mg/ml and incubate the cell suspension on ice for 30 minutes.

Several protocols use sonication or a French press to lyse cells before affinity purification of the GST fusion protein. Lysozyme is more reproducible and avoids the cataclysmic lysis that can release outer membrane proteins and other molecules that cause aggregation of the GST fusion protein or copurify with it on glutathione-agarose chromatography.

8. Add 10 ml of 0.2% Triton X-100. Use a syringe to inject the solution forcibly into the viscous cell lysate. Shake the tube vigorously several times to mix the solution of detergent and cell lysate. Add DNase and RNase to the tube each to a final concentration of 5 µg/ml, and continue the incubation with rocking for 10 minutes at 4°C. Remove the insoluble debris by centrifugation at 3000g (5000 rpm in a Sorvall SS-34 rotor) for 30 minutes at 4°C. Collect the supernatant (cell lysate) in a fresh tube. Add dithiothreitol to a final concentration of 1 mM.

It may be necessary to pass the supernatant through a 0.45-µm filter to prevent clogging of the resin during purification of the GST fusion protein.

Triton X-100 is added to the slurry of lysed cells to prevent aggregation. Detergents that have been reported to solubilize GST fusion proteins and not interfere with the glutathione-agarose affinity purification step include 1% (v/v) Triton X-100, 1% (v/v) Tween-20 plus 10 mM dithiothreitol, 0.03% (w/v) SDS, and 1.5% (w/v) *N*-lauroylsarcosine (Smith and Johnson 1988; Frankel et al. 1991; Grieco et al. 1992). Tween-20, SDS, and *N*-lauroylsarcosine can be added in place of, or simultaneously with, the Triton X-100. Please see the panel on **TROUBLESHOOTING: INSOLUBLE PROTEINS**.

### Purification of the Fusion Protein

9. Combine the cell lysate with an appropriate amount of the 50% slurry of glutathione-agarose resin in PBS. Use 2 ml of slurry for each 100 ml of bacterial culture used to make the protein extract. Shake the mixture gently for 30 minutes at room temperature.
10. Centrifuge the mixture at 500g (2100 rpm in a Sorvall SS-34 rotor) for 5 minutes at 4°C. Carefully remove the supernatant. Save a small amount of the supernatant to analyze by SDS-polyacrylamide gel electrophoresis.
11. Wash unbound proteins from the resin by adding 10 bed volumes of PBS to the pellet, and mix by inverting the tube several times.
12. Centrifuge at 500g (2100 rpm in a Sorvall SS-34 rotor) for 5 minutes at 4°C. Carefully remove the supernatant. Save a small amount of the supernatant to analyze by SDS-polyacrylamide gel electrophoresis.
13. Repeat Steps 11 and 12 two more times.
14. Bound GST fusion protein may be eluted from the resin using glutathione elution buffer. Alternatively, GST fusion proteins may be cleaved while still bound to the gel with thrombin, enterokinase, or Factor Xa, liberating the protein of interest from the GST moiety.

### ELUTION OF THE FUSION PROTEIN USING GLUTATHIONE

- a. Elute the bound protein from the resin by adding 1 bed volume of glutathione elution buffer to the pellet. Incubate the tube with gentle agitation for 10 minutes at room temperature.
- b. Centrifuge the tube as in Step 12. Transfer the supernatant (which contains the eluted fusion protein) to a fresh tube.

- c. Repeat Steps a and b twice more, pooling all three supernatants.

Depending on the particular fusion protein being purified, a significant amount of protein may remain bound to the gel following the elution steps. The volume of elution buffer and the elution times may vary among fusion proteins. Additional elutions may be required. Monitor the eluates for GST protein by SDS-polyacrylamide gel electrophoresis. Estimate the yield of fusion protein by measuring the absorbance at 280 nm. As a general rule for proteins containing a GST tag,  $1 A_{280} = 0.5 \text{ mg/ml}$ . The yield of protein may also be determined by standard chromogenic methods (e.g., Lowry or Bradford). If the Lowry method is used, the sample must first be dialyzed against 2000 volumes of 1x PBS to remove the glutathione, which can interfere with protein measurement. The Bradford method can be performed in the presence of glutathione.

#### PROTEOLYTIC CLEAVAGE OF THE TARGET PROTEIN FROM THE BOUND GST MOIETY

- a. Add thrombin, enterokinase or Factor Xa (as appropriate for the cleavage site within the fusion protein) to the beads. Use 50 units of the appropriate protease in 1 ml of PBS for each milliliter of resin volume. Mix the solution by inverting the tube several times, and incubate the mixture with shaking for 2–16 hours at room temperature. The exact time should be determined empirically using small-scale reactions.
- b. Centrifuge the tube at 500g (2100 rpm in a Sorvall SS-34 rotor) for 5 minutes at 4°C. Carefully transfer the supernatant to a fresh tube.

The GST should still be bound to the matrix and the protein of interest should be in the supernatant. The thrombin or the Factor Xa will also be in the supernatant. The protein of interest can be separated from the protease by conventional chromatography or by SDS-polyacrylamide gel electrophoresis.

15. Analyze the protein profile of each step (cell extract, washes, and elution) on a 10% SDS-polyacrylamide gel.

#### TROUBLESHOOTING: INSOLUBLE PROTEINS

Insoluble GST fusion proteins (detected by the presence of fusion protein in the preliminary induction experiments and by the absence of the polypeptide after affinity chromatography, or in cell fractionation experiments) can also be solubilized with the following detergents: 1% (v/v) Triton X-100, 1% (v/v) Tween-20 plus 10 mM dithiothreitol, 0.03% (w/v) SDS, and especially 1.5% (w/v) *N*-lauroylsarcosine (Smith and Johnson 1988; Frankel et al. 1991; Grieco et al. 1992).

1. Follow the main protocol through Step 7.
2. Centrifuge the cell lysate at 10,000g (7300 rpm in a Sorvall SS-34 rotor) for 10 minutes at 4°C, remove and save the supernatant, and resuspend pellet in 8 ml of 1.5% *N*-lauroylsarcosine, 25 mM triethanolamine, 1 mM EDTA (pH 8.0).
3. Mix the solution for 10 minutes at 4°C and then centrifuge as in Step 2 above.
4. Combine supernatants from the initial detergent-free cell lysate and the resolubilized cell pellet.
5. Proceed with the remainder of the protocol (from Step 9).



# Protocol 6

---

## Purification of Maltose-binding Fusion Proteins by Affinity Chromatography on Amylose Resin

**M**ALTOSE-BINDING PROTEIN (MBP) FUSIONS GENERATE RECOMBINANT PROTEINS in a form that can be purified to near homogeneity by affinity chromatography (Hennig and Schafer 1998). MBP, a periplasmic protein encoded by the *malE* gene of *E. coli*, is a component of the maltose transport system of the bacterium. MBP has an affinity in the micromolar range for maltose and maltodextrins and can thus be purified on matrices consisting of sugars cross-linked to an agarose matrix. The *malE* gene product tolerates a wide variety of fusions and is therefore a useful pack horse in expression studies (Schatz and Beckwith 1990).

The pMAL-c2 or pMAL-p2 vectors (di Guan et al. 1988; Maina et al. 1988; New England Biolabs) contain the IPTG-inducible *tac* promoter adjacent to an extensive polycloning site and an *rrnB* terminator. The polylinker spans the amino terminus of the  $\alpha$ -complementation fragment of  $\beta$ -galactosidase, allowing blue/white screening of bacterial colonies when cloning into these vectors. Because the plasmids also contain the *cI<sup>q</sup>* allele of the *lacI* gene, expression of MBP fusion proteins can be induced by IPTG in most strains of *E. coli*. A spacer sequence of ten asparagine residues separating the *malE* sequence from the polycloning site facilitates cleavage of the fusion protein by Factor X protease and, in addition, may enhance the ability of the MBP fusion protein to bind to the affinity resin. The Factor X protease cleavage site (Ile-Glu-Gly-Arg) lies immediately adjacent to the first restriction enzyme site (*EcoRI*) in the polycloning site. The Factor X protease cleavage site may be replaced as desired by a sequence encoding a cleavage site for other proteases, such as thrombin or enterokinase. pMAL-c2 lacks the MBP signal sequence, whereas pMAL-p2 contains the MBP signal sequence that directs MBP fusion proteins to the periplasmic space. Export into this compartment allows rapid isolation by osmotic shock, decreases exposure of the fusion protein to proteases, and in some cases, allows the formation of disulfide bonds in the foreign protein. Not all fusion proteins, however, are exported efficiently into the periplasm. Thus, any advantage of targeting to the periplasmic space must be established empirically.

MBP fusions have a potential advantage over GST fusions: the *malE* gene sequence is derived from *E. coli* and should therefore contain the appropriate codons and elements of mRNA secondary structure that are required for efficient expression in the bacterium. By contrast, the effectiveness in *E. coli* of the analogous GST sequence, which is derived from a parasitic organism, is unknown. However, no direct comparisons have been published of the efficiency with which the two types of vectors express a series of fusion proteins.

## MATERIALS

**CAUTION:** Please see Appendix 12 for appropriate handling of materials marked with <!>.

### Buffers and Solutions

Please see Appendix 1 for components of stock solutions, buffers, and reagents. Dilute stock solutions to the appropriate concentrations.

*Cell lysis buffer (~150 ml)*

30 mM Tris-Cl (pH 7.1)  
0.1 mM EDTA  
20% (w/v) sucrose

*Cell wash buffer (~250 ml)*

10 mM Tris-Cl (pH 7.1)  
30 mM NaCl

*Column elution buffer (~100 ml)*

10 mM Tris-Cl (pH 7.5)  
10 mM maltose

*Column wash buffer (~250 ml)*

10 mM Tris-Cl (pH 7.1)  
1 M NaCl

*MgCl<sub>2</sub> (0.1 mM, ~250 ml)*

*PMSF (100 mM) <!>*

Add 17.4 mg of PMSF per milliliter of isopropanol. Store at -20°C.

PMSF is inactivated in aqueous solutions. The rate of inactivation increases with increasing pH and is faster at 25°C than at 4°C. The half-life of a 20 mM aqueous solution of PMSF is ~35 minutes at pH 8.0 (James 1978). This short half-life means that aqueous solutions of PMSF can be safely discarded after they have been rendered alkaline (pH >8.6) and stored for several hours at room temperature.

An alternative to PMSF (4-[2-aminoethyl]-benzenesulfonyl fluoride, hydrochloride; Pefabloc SC) is available from Boehringer Mannheim. Pefabloc is an irreversible serine protease inhibitor, is used at the same concentration as PMSF, but is nontoxic and stable in aqueous buffer solutions.

*1x SDS gel-loading buffer*

Store 1x SDS gel-loading buffer lacking dithiothreitol at room temperature. Add dithiothreitol from a 1 M stock, just before the buffer is used.

*Tris-Cl (10 mM, pH 7.1)*

### Enzymes and Buffers

*DNase (5 mg/ml)*

*Lysozyme*

*RNase (5 mg/ml)*

*Thrombin, Enterokinase, or Factor Xa solution*

Follow the manufacturer's instructions for the preparation and storage of these proteases.

### Gels

*Polyacrylamide gel (10%) containing SDS <!>*

For preparation of SDS-polyacrylamide gels used in the separation of proteins, please see Appendix 8.

### Centrifuges and Rotors

*Beckman Ti60 rotor or equivalent*

*Sorvall GSA rotor or equivalent*

*Sorvall SS-34 rotor or equivalent*

## Special Equipment

### *Amylose Agarose*

This affinity chromatography matrix can be synthesized as described by Kellermann and Ferenci (1982) or purchased from New England Biolabs (binding capacity 2–4 mg MBP/ml bed volume).

### *Boiling water bath*

### *Equipment for sonication*

Please see Appendix 8.

### *Disposable Nalgene filter (0.45- $\mu$ m nitrocellulose)*

## Vectors and Bacterial Strains

*E. coli* cells expressing a recombinant MBP fusion protein (cell pellet generated in Step 17 of Protocol 1 or 2)

## METHOD

---

### Preparation of Amylose Agarose

1. Pour a 3 x 6-cm column of amylose agarose. Equilibrate in 10 mM Tris-Cl (pH 7.1) at 4°C.

### Preparation of the Cell Extract

2. Resuspend the cell pellet in 1/10 original culture volume (typically 50 ml) of ice-cold cell wash buffer. Collect the cells by centrifugation at 5000g (5500 rpm in a Sorvall GSA rotor) for 15 minutes at 4°C and again resuspend the pellet in 1/10 original culture volume (typically 50 ml) of ice-cold cell wash buffer.
3. Prepare the cell lysate.

#### **IF AN MBP VECTOR WITHOUT A SIGNAL SEQUENCE WAS USED (PMAL-C2)**

- a. Lyse cells by sonication with a microtip sonicator, using three bursts of 10 seconds each. Use a power setting of ~30 W and keep the cells cold (0°C) during sonication.
- b. Add PMSF to a final concentration of 1 mM and clarify the solution by centrifugation at 87,000g (35,000 rpm in a Beckman Ti60 rotor) for 30 minutes at 4°C.  
Proceed to purify the fusion protein from the supernatant by amylose-agarose chromatography as described in Step 4.

#### **IF AN MBP VECTOR WITH A SIGNAL SEQUENCE WAS USED (PMAL-P2)**

- a. Collect the cells by centrifugation at 5000g (5500 rpm in a Sorvall GSA rotor) for 15 minutes at 4°C and resuspend the cell pellet in 1/20 original culture volume (typically 25 ml) of ice-cold cell wash buffer.
- b. Add PMSF to 1 mM. Stir the cell suspension for 15 minutes at room temperature. Collect the cells by centrifugation at 17,200g (12,000 rpm in a Sorvall SS-34 rotor) for 10 minutes at 4°C.

- c. Spread the cell pellet around the sides of the centrifuge tube. Add ice-cold 0.1 mM MgCl<sub>2</sub> solution (100 ml/liter original culture volume) and stir the suspension for 10 minutes at 4°C.
- d. Centrifuge the shocked cells at 17,200g (12,000 rpm in a Sorvall SS-34 rotor) for 10 minutes at 4°C. Add 10 mM Tris-Cl (pH 7.1) until the pH of the supernatant is 7.1.
- e. Filter the supernatant through a 100-ml disposable Nalgene filter (0.45-µm nitrocellulose membrane), and dialyze the filtered solution against 100 volumes 10 mM Tris-Cl (pH 7.1) at 4°C.

Proceed to purify the fusion protein from the supernatant by amylose-agarose chromatography as described in Step 4.

4. Pour the supernatant from Step 3 over the column. Rinse the column with 100 ml of 10 mM Tris-Cl (pH 7.1). Pass 100 ml of column wash buffer through the column.
5. Elute the bound fusion protein with 50 ml of column elution buffer and collect 1-ml fractions.
6. Analyze aliquots of the collected fractions by SDS-polyacrylamide gel electrophoresis to determine the location of the fusion protein in the series of elution fractions. Pool the fractions containing the fusion protein, and store them at -70°C.
7. Use the appropriate protease to cleave the fusion protein from the MBP moiety.
  - a. Add thrombin, enterokinase or Factor Xa (as appropriate for the cleavage site within the fusion protein) to the beads. Use 50 units of the appropriate protease in 1 ml of PBS for each milliliter of resin volume. Mix the solution by inverting the tube several times, and incubate the mixture with shaking for 2-16 hours at room temperature.

The time required to obtain maximum yield of the foreign protein should be determined empirically using small-scale reactions.

- b. Centrifuge the tube at 500g (2100 rpm in a Sorvall SS-34 rotor) for 5 minutes at 4°C. Carefully transfer the supernatant to a fresh tube.

The protein of interest can be separated from the protease by conventional chromatography or by SDS-polyacrylamide gel electrophoresis.

Proteins secreted into the periplasmic space of *E. coli* can be readily released from cells by osmotic shock as described in Step 3. Treatment of bacteria with hypertonic solutions containing EDTA (i.e., cell lysis buffer) changes membrane/cell wall permeability, and subsequent incubation in a hypotonic solution (i.e., 0.1 mM MgCl<sub>2</sub>) causes permeabilization of the cell wall and release of components from the periplasmic space (Nossal and Heppel 1966). Cells harvested from exponentially growing cultures are more readily shocked than are stationary cells. Typically, ~4% of the total protein mass of *E. coli* is secreted into the periplasmic space. The proteins secreted include a number of degradative enzymes such as alkaline phosphatase, acid phosphatase, RNase, DNase, and nucleotide metabolizing enzymes. Because proteases are also secreted, the use of a protease-deficient *E. coli* strain or the addition of a protease inhibitor cocktail (please see Protocol 1), together with the 10 mM Tris-Cl (pH 7.1) buffer after the shock treatment, may enhance the yield of intact MBP fusion proteins.

Some foreign proteins are not translocated efficiently into the periplasmic space and, as a consequence, are not isolated in high yield by the procedures described in this protocol. Because these fusion proteins generally remain attached to the cytoplasmic membrane, they cannot be efficiently isolated from cells lysed by sonication. For this reason, it is a good idea to determine the distribution of the MBP fusion protein among different cellular fractions (periplasm, cytoplasm, or membrane) (please see Protocol 4). If an expressed protein is found associated with the inner membrane, include 1% Triton X-100 in the cell wash buffer of Step 3a above. The use of other detergents for solubilization of fusion proteins is discussed in Protocol 4.

# Protocol 7

---

## Purification of Histidine-tagged Proteins by Immobilized Ni<sup>2+</sup> Absorption Chromatography

**P**OLYHISTIDINE TRACTS BIND TIGHTLY TO A NUMBER OF TRANSITION METALS and transition metal chelate complexes, such that a protein carrying an exposed His-6 region will bind to a resin charged with divalent nickel ions. Contaminating proteins can be removed with appropriate washing, and the protein of interest can then be eluted by a soluble competing chelator. Because few natural proteins bind with significant affinities to such matrices, His-6-labeled proteins generated by recombinant techniques can be purified substantially in a single step by metal chelate affinity chromatography. Those natural proteins that do bind to these matrices can almost always be removed in a second chromatography step. Metal chelate chromatography has become popular because it is both highly effective and relatively insensitive to proper protein folding, ionic strength, chaotropes, and detergents (Hochuli et al. 1988). Because of the high efficiency, high capacity, concentrating power, and speed of this technique, it should be used as a first (and sometimes only) step in a purification protocol.

To perform metal chelate chromatography, the protein of interest must first be engineered to contain a His-6 sequence in an exposed and relatively flexible site, frequently found at the amino or carboxyl terminus (Van Reeth et al. 1998). It can be helpful to place one or two glycine residues between the His-6 sequence and the rest of the protein. Unique protease cleavage sites also can be inserted to allow removal of the His-6 sequence after purification (please see Table 15-3). Proteases may also be used to desorb proteins from the affinity matrix by cleavage at the linker/His-6 insertion. Coexpression of an unmodified protein of interest together with a His-6-tagged binding partner can allow isolation of the binary complex on the affinity matrix and selective elution of the native target protein (Kozasa and Gilman 1995). This method can be particularly effective if the two proteins can be dissociated gently such that contaminating proteins that bind to the matrix are not eluted (please see Chapter 18, Protocols 2 and 3).

Purification can be performed under both native and denaturing conditions (e.g., in buffers containing 8 M urea or 6 M guanidine hydrochloride). Because any chelator can interfere with metal chelate chromatography, buffers used for extraction and chromatography should be free of EDTA or EGTA. Submillimolar concentrations of dithiothreitol may not interfere significantly. Nevertheless, it is preferable to use buffers containing 1–5 mM of a monothiol such as  $\beta$ -mercaptoethanol or  $\beta$ -mercaptoacetic acid. The target protein is eluted by a chelator such as imidazole or EDTA. Imidazole is the more selective eluant and should be used whenever possible. Efficient elution is usually achieved with 50–100 mM imidazole at pH 7–8. The lowest effective concentra-

tion should be established using a linear gradient of 10–150 mM imidazole. EDTA is more effective, but it may strip Ni<sup>2+</sup> from the NTA-agarose. In this case, the Ni<sup>2+</sup> must then be removed for many applications, either by dialysis or by a second chromatographic step.

The Ni<sup>2+</sup> resin can be easily regenerated and reused many times (please see the additional protocol at the end of this protocol). Because of its large binding capacity, as much as 20 mg of recombinant protein may be purified on a 2.5-ml column. The following protocol is adapted from methods contributed by Elliot Ross (University of Texas Southwestern Medical Center, Dallas) and Tzu-Ching Meng in Nick Tonks' group at Cold Spring Harbor Laboratory.

## MATERIALS

---

**CAUTION:** Please see Appendix 12 for appropriate handling of materials marked with <!>.

### Buffers and Solutions

Please see Appendix 1 for components of stock solutions, buffers, and reagents. Dilute stock solutions to the appropriate concentrations.

*Binding buffer (pH 7.8)*

20 mM sodium phosphate  
500 mM NaCl

*Imidazole elution buffer (pH 6.0)*

20 mM sodium phosphate  
500 mM NaCl

Create a series of four elution buffers containing imidazole at concentrations of 10 mM, 50 mM, 100 mM, and 150 mM by adding the appropriate amount of 3 M imidazole to wash buffer (pH 6.0).

*Triton X-100 (10% v/v)*

*Wash buffer (pH 6.0)*

20 mM sodium phosphate  
500 mM NaCl

### Enzymes and Buffers

*DNase (1 mg/ml)*

*Lysozyme*

*RNase (1 mg/ml)*

### Gels

*Polyacrylamide gel (10%) containing SDS <!>*

For preparation of SDS-polyacrylamide gels used in the separation of proteins, please see Appendix 8.

### Centrifuges and Rotors

*Sorvall SS-34 rotor or equivalent*

### Special Equipment

*Chromatography column (glass or polypropylene)*

*Ni<sup>2+</sup>-charged chromatography resin (e.g., ProBond, Invitrogen; HisTrap, Pharmacia; His-Bind Resin, Novagen; NTA-Ni<sup>2+</sup>-agarose, Qiagen)*

Currently, the most common metal chelate affinity support is nitrilotriacetate (NTA)-Ni<sup>2+</sup>-agarose, available from the suppliers described above. Other matrices with different properties are also available. A proprietary Co<sup>2+</sup> chelate (Talon) is said to bind His-6-tagged proteins with higher affinity, and somewhat higher selectivity, but it cannot be conveniently regenerated in the laboratory and is consequently much more expensive.

*Rocking platform*

## Vectors and Bacterial Strains

*E. coli cells expressing a polyhistidine-tagged protein (generated in Protocol 1, 2, 3, or 4)*

## METHOD

---

### Preparation of the Ni<sup>2+</sup> Affinity Column

1. Gently invert the bottle of Ni<sup>2+</sup>-charged chromatography resin to mix the slurry, and transfer 2 ml to a small polypropylene or glass column. Allow the resin to pack under gravity flow.
2. Wash the resin with 3 column volumes of sterile H<sub>2</sub>O.  
One column volume is equivalent to the volume of the settled bed of resin.
3. Equilibrate the resin with 3 column volumes of binding buffer (pH 7.8). The column is now ready for use in Step 9.

### Preparation of Cell Extract

4. Resuspend the cell pellet (e.g., from Protocol 1, Step 17) in 4 ml of binding buffer (pH 7.8) per 100 ml of cell culture.
5. Add lysozyme to a final concentration of 1 mg/ml and incubate the cell suspension on ice for 30 minutes.

Several protocols use sonication or a French press to lyse cells before affinity purification of the polyhistidine-tagged protein. The use of lysozyme, as described here, is somewhat more reproducible and avoids the cataclysmic lysis that can release membrane proteins and other molecules that cause aggregation of the polyhistidine-tagged protein.

▲ **IMPORTANT** Protease inhibitors may be added, but do not add EDTA or other chelators, which will remove the Ni<sup>2+</sup> from the affinity resin, destroying its ability to bind histidine.

6. Incubate the mixture on a rocking platform for 10 minutes at 4°C.
7. Add Triton X-100, DNase, and RNase to the tube to final concentrations of 1%, 5 µg/ml, and 5 µg/ml, respectively, and continue the incubation with rocking for another 10 minutes at 4°C.
8. Remove the insoluble debris by centrifugation at 3000g (5000 rpm in a Sorvall SS-34 rotor) for 30 minutes at 4°C. Collect the supernatant (cell lysate) in a fresh tube.

It may be necessary to pass the supernatant through a 0.45-µm filter to prevent clogging of the resin during purification of the polyhistidine-tagged protein.

## Purification of the Polyhistidine-tagged Protein

9. Allow the binding buffer above the resin to drain to the top of the column.
10. Immediately load the cell lysate (Step 8) onto the column. Adjust the flow rate to 10 column volumes per hour.

Ni<sup>2+</sup> affinity resins will typically bind ~8–12 mg of protein per milliliter of resin. The amount of polyhistidine-tagged protein produced in *E. coli* will vary depending on the target protein, but it is typically in the range of 1–10 mg of protein per 100 ml of cell culture.
11. Wash the column with 6 column volumes of binding buffer (pH 7.8).
12. Wash the column with 4 volumes of wash buffer (pH 6.0). Continue washing the column until the A<sub>280</sub> of the flowthrough is <0.01.
13. Elute the bound protein with 6 volumes of 10 mM imidazole elution buffer. Collect 1-ml fractions from the column, and monitor the A<sub>280</sub> of each fraction.
14. Repeat Step 13 using imidazole elution buffers containing increasing concentrations of imidazole (i.e., 50 mM, 100 mM, and 150 mM imidazole).

Alternatively, elute the protein using a continuous gradient of increasing imidazole concentration from 10 mM to 100 mM. Most His-tagged proteins will elute between 50 mM and 100 mM imidazole. Instead of using imidazole, the bound protein can be eluted using buffers of decreasing pH (please see the panel on **ALTERNATIVE PROTOCOL: ELUTION OF POLYHISTIDINE-TAGGED PROTEINS FROM METAL AFFINITY COLUMNS USING DECREASING pH**).
15. Assay the fractions of interest for the presence of the polyhistidine-tagged protein by analyzing 20- $\mu$ l aliquots by electrophoresis through a 10% SDS-polyacrylamide gel.

### ALTERNATIVE PROTOCOL: ELUTION OF POLYHISTIDINE-TAGGED PROTEINS FROM METAL AFFINITY COLUMNS USING DECREASING pH

As an alternative to imidazole, polyhistidine-tagged proteins may be eluted from the affinity column using a series of buffers of decreasing pH.

**CAUTION:** Please see Appendix 12 for appropriate handling of materials marked with <!>.

#### Additional Materials

##### Low pH elution buffer (pH 4.0)

20 mM sodium phosphate  
500 mM NaCl  
Use phosphoric acid <!> to lower the pH to 4.0.

##### Wash buffer II (pH 5.5)

20 mM sodium phosphate  
500 mM NaCl

#### Method

1. Carry out the main protocol through Step 12.
2. Wash the column with 6 volumes of Wash buffer II (pH 5.5).
3. Elute the bound protein with 6 volumes of low pH elution buffer (pH 4.0). Collect 1-ml fractions from the column, and monitor the A<sub>280</sub> of each fraction.
4. Assay the fractions of interest for the presence of the polyhistidine-tagged protein by analyzing 20- $\mu$ l aliquots by electrophoresis through a 10% SDS-polyacrylamide gel.



**ADDITIONAL PROTOCOL: REGENERATION OF NTA-Ni<sup>2+</sup>-AGAROSE**

NTA-Ni<sup>2+</sup>-agarose can be reused almost indefinitely if it is washed well and regenerated. If the column has not been oxidized or depleted (loss of light blue color or appearance of yellow/brown color), the manufacturer recommends washing with 0.2 M acetic acid in 30% glycerol. We routinely strip and regenerate the matrix after every use according to the manufacturer's recommendation (Qiagen in this case).

**CAUTION:** Please see Appendix 12 for appropriate handling of materials marked with <!.>.

**Additional Materials**

6 M guanidinium chloride/0.2 M acetic acid <!.>

2% (w/v) SDS

25%, 50%, and 75% ethanol (all v/v)

100 mM EDTA

0.1 M NiSO<sub>4</sub> <!.>

**Method**

**1.** Wash the column successively with

2 volumes of 6 M guanidinium chloride/0.2 M acetic acid (or other stripping agent)

5 volumes of H<sub>2</sub>O

2 volumes of 2% SDS

1 volume each of 25%, 50%, and 75% ethanol

5 volumes of ethanol

1 volume each of 75%, 50%, and 25% ethanol

1 volume of H<sub>2</sub>O

5 volumes of 100 mM EDTA

1 volume of H<sub>2</sub>O

**2.** Regenerate the column with <2 volumes 0.1 M NiSO<sub>4</sub>, wash with H<sub>2</sub>O, and equilibrate with the appropriate chromatographic buffer.

The column should be white after the EDTA wash (or after elution of protein with EDTA) and should return to a pale blue color after regeneration.

# Protocol 8

---

## Purification of Expressed Proteins from Inclusion Bodies

**T**HE EXPRESSION OF FOREIGN PROTEINS AT HIGH LEVELS IN *E. COLI* often results in the formation of cytoplasmic granules or inclusion bodies composed of insoluble aggregates of the expressed protein. These inclusion bodies can be seen with a phase-contrast microscope and are readily separated from most soluble and membrane-bound bacterial proteins as described in this protocol. Briefly, cells expressing high levels of foreign protein are concentrated by centrifugation and lysed by mechanical techniques, sonication, or lysozyme plus detergents. The inclusion bodies are recovered by centrifugation and washed with Triton X-100 and EDTA (Marston et al. 1984) or urea (Schoner et al. 1985). The purpose of the washing steps is to remove as much soluble, adherent bacterial protein as possible from the aggregated foreign protein. In most cases, adjusting the washing conditions allows the isolation of inclusion bodies that contain >90% pure foreign protein. The material extracted from the purified inclusion body can be used directly as an antigen (Harlow and Lane 1988).

To obtain soluble, active protein, the washed inclusion bodies are solubilized and the denatured target protein is then refolded. Various conditions (e.g., guanidine HCl [5–8 M], urea [6–8 M], SDS, alkaline pH, or acetonitrile/propanol) may be used to solubilize the inclusion bodies (Marston 1987). Other methods such as passage of cell suspensions through a French Press or sonication can also be used to lyse cells containing inclusion bodies. Proteins expressed from T7 RNA polymerase vectors in cells containing pLys plasmids can be lysed by methods described in Protocol 2. With all of these procedures, it is crucial to obtain maximum cell lysis in order to obtain inclusion bodies in high yields. Each protein may require a slightly different procedure, which must be determined empirically (please see Mitraki and King 1989). The procedure given below has been used to solubilize prorennin inclusion bodies and is adapted from Marston et al. (1984). Various options for refolding solubilized proteins are outlined in the panel on **ADDITIONAL PROTOCOL: REFOLDING SOLUBILIZED PROTEINS RECOVERED FROM INCLUSION BODIES** at the end of this protocol.

## MATERIALS

---

**CAUTION:** Please see Appendix 12 for appropriate handling of materials marked with <!.>.

### Buffers and Solutions

Please see Appendix 1 for components of stock solutions, buffers, and reagents. Dilute stock solutions to the appropriate concentrations.

#### *Cell lysis buffer I*

50 mM Tris-Cl (pH 8.0)  
1 mM EDTA (pH 8.0)  
100 mM NaCl

#### *Cell lysis buffer II, ice cold*

50 mM Tris-Cl (pH 8.0)  
10 mM EDTA (pH 8.0)  
100 mM NaCl  
0.5% (v/v) Triton X-100

#### *Deoxycholic acid*

Use a protein grade of this bile acid/detergent.

#### *HCl (12 M) (concentrated HCl) <!.>*

#### *Inclusion-body solubilization buffer I*

50 mM Tris-Cl (pH 8.0)  
1 mM EDTA (pH 8.0)  
100 mM NaCl  
8 M urea  
0.1 M PMSF

Prepare the buffer fresh just before use.

#### *Inclusion-body solubilization buffer II*

50 mM  $\text{KH}_2\text{PO}_4$  (pH 10.7)  
1 mM EDTA (pH 8.0)  
50 mM NaCl

#### *KOH (10 N) <!.>*

#### *PMSF (100 mM) <!.>*

#### *1x and 2x SDS gel-loading buffer*

Store 1x and 2x SDS gel-loading buffer lacking dithiothreitol at room temperature. Add dithiothreitol from a 1 M stock just before the buffer is used.

#### *Tris-Cl (0.1 M, pH 8.5) with urea*

For use in Method 2 only; please see Step 7. Prepare 0.1 M Tris-Cl (pH 8.5) with increasing concentrations of urea (e.g., 0.5, 1, 2, and 5 M). Make the solution fresh from solid urea and use immediately. Do not use solutions containing urea that have been stored for any period of time, because the urea decomposes.

### Enzymes and Buffers

#### *DNase I (1 mg/ml)*

#### *Lysozyme (10 mg/ml)*

Prepare the solution fresh in Tris-Cl (pH 8.0).

### Gels

#### *Polyacrylamide gels (10%) containing SDS <!.>*

For preparation of SDS-polyacrylamide gels used in the separation of proteins, please see Appendix 8.

### Centrifuges and Rotors

*Sorvall GSA rotor or equivalent*

### Special Equipment

#### *pH paper*

Optional, please see Step 10.

#### *Polished glass rod*

## Vectors and Bacterial Strains

### *E. coli* cells expressing the protein of interest

Grow 1 liter of *E. coli* cells that have been transformed by any of the methods in Protocols 1–4 and now expresses the protein of interest as inclusion bodies.

## METHOD

---

### Preparation of Cell Extract

1. Centrifuge 1 liter of the cell culture of *E. coli* expressing the protein of interest at 5000g (5500 rpm in a Sorvall GSA rotor) for 15 minutes at 4°C in preweighed centrifuge bottles.  
▲ **IMPORTANT** Perform Steps 2–4 at 4°C.
2. Remove the supernatant and determine the weight of the *E. coli* pellet. For each gram (wet weight) of *E. coli*, add 3 ml of Cell lysis buffer I. Resuspend the pellet by gentle vortexing or by stirring with a polished glass rod.
3. For each gram of *E. coli*, add 4 µl of 100 mM PMSF and then 80 µl of 10 mg/ml lysozyme. Stir the suspension for 20 minutes.  
Other cocktails of protease inhibitors may be added at this step (please see Protocol 1).
4. Stirring continuously, add 4 mg of deoxycholic acid per gram of *E. coli*.
5. Store the suspension at 37°C and stir it occasionally with a glass rod. When the lysate becomes viscous, add 20 µl of 1 mg/ml DNase I per gram of *E. coli*.
6. Store the lysate at room temperature until it is no longer viscous (~30 minutes).

### Purification and Washing of Inclusion Bodies

7. Purify and wash the inclusion bodies using one of the following two methods.

#### **METHOD 1: RECOVER INCLUSION BODIES USING TRITON X-100**

The following procedure is adapted from Marston et al. (1984).

- a. Centrifuge the cell lysate at maximum speed for 15 minutes at 4°C in a microfuge.
- b. Decant the supernatant. Resuspend the pellet in 9 volumes of Cell lysis buffer II at 4°C.
- c. Store the suspension for 5 minutes at room temperature.
- d. Centrifuge the tube at maximum speed for 15 minutes at 4°C in a microfuge.
- e. Decant the supernatant and set it aside for the next step. Resuspend the pellet in 100 µl of H<sub>2</sub>O.
- f. Remove 10-µl samples of the supernatant and of the resuspended pellet. Mix each sample with 10 µl of 2x SDS gel-loading buffer and analyze the samples by SDS-polyacrylamide gel electrophoresis to determine which fraction contains the protein of interest.
- g. If necessary, proceed with Step 8 to solubilize the inclusion bodies.

**METHOD 2: RECOVER INCLUSION BODIES USING UREA**

The following procedure, adapted from Schoner et al. (1985), involves washing and solubilization of inclusion bodies with buffers containing different concentrations of urea.

- a. Centrifuge the cell lysate at maximum speed for 15 minutes at 4°C in a microfuge.
  - ▲ **IMPORTANT** Perform Steps b, d, and f at 4°C.
- b. Decant the supernatant. Resuspend the pellet in 1 ml of H<sub>2</sub>O per gram of *E. coli*. Transfer 100- $\mu$ l aliquots to four microfuge tubes and store the remainder of the suspension at 4°C.
- c. Centrifuge the 100- $\mu$ l aliquots at maximum speed for 15 minutes at 4°C in a microfuge.
- d. Discard the supernatants. Resuspend each pellet in 100  $\mu$ l of 0.1 M Tris-Cl (pH 8.5) containing a different concentration of urea (e.g., 0.5, 1, 2, and 5 M).
- e. Centrifuge the tubes at maximum speed for 15 minutes at 4°C in a microfuge.
- f. Decant the supernatants and set them aside for the next step. Resuspend each pellet in 100  $\mu$ l of H<sub>2</sub>O.
- g. Remove 10- $\mu$ l samples of each supernatant and each resuspended pellet. Mix each sample and resuspended pellet with 10  $\mu$ l of 2x SDS gel-loading buffer and analyze by SDS-polyacrylamide gel electrophoresis to determine which concentration of urea yields the best recovery of the inclusion bodies.
- h. Use the appropriate concentration of urea, determined in Step g, to wash the remaining pellet (from Step b) as described in this method.
- i. If necessary, proceed with Step 8 to solubilize the inclusion bodies.

**Solubilization of Inclusion Bodies**

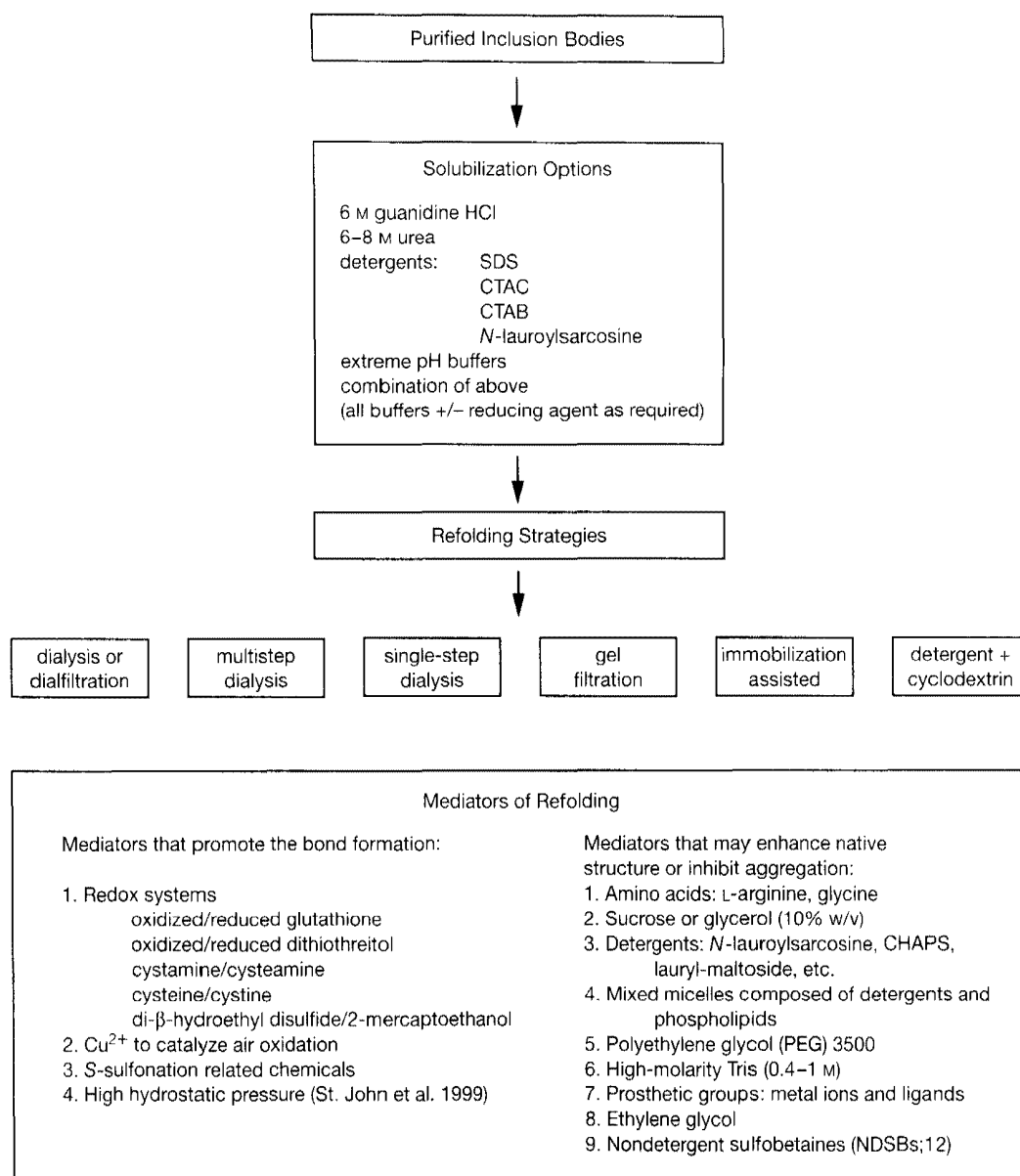
8. Centrifuge the appropriate resuspended pellets from Step 7 at maximum speed for 15 minutes at 4°C in a microfuge, and suspend them in 100  $\mu$ l of Inclusion-body solubilization buffer I containing 0.1 mM PMSF (freshly added).
9. Store the solution for 1 hour at room temperature.
10. Add this solution to 9 volumes of Inclusion-body solubilization buffer II and incubate the mixture for 30 minutes at room temperature. Check that the pH is maintained at 10.7 by spotting small aliquots onto pH paper. If necessary, readjust the pH to 10.7 with 10 N KOH.
11. Adjust the pH of the solution to 8.0 with 12 M HCl, and store the adjusted solution for at least 30 minutes at room temperature.
12. Centrifuge the solution at maximum speed for 15 minutes at room temperature in a microfuge.
13. Decant the supernatant and set it aside for the next step. Resuspend the pellet in 100  $\mu$ l of 1x SDS gel-loading buffer.
14. Remove 10- $\mu$ l samples of the supernatant and resuspended pellet. Mix the supernatant sample with 10  $\mu$ l of 2x SDS gel-loading buffer. Analyze both samples by SDS-polyacrylamide gel electrophoresis to determine the degree of solubilization. Proceed with the additional protocol.

**ADDITIONAL PROTOCOL: REFOLDING SOLUBILIZED PROTEINS RECOVERED FROM INCLUSION BODIES**

Renaturation and refolding of solubilized protein occur during gradual removal of denaturing agents and/or detergents. Of necessity, this involves exposure of hydrophobic regions of the protein to solvent, a process which, unless conditions are carefully controlled, can lead to the formation of insoluble aggregates and/or soluble but inactive multimers. In many cases, considerable work is required to suppress formation of these off-pathway aggregates and thereby allow protein monomers to fold into a fully native conformation. The yield of active protein or of protein with the native structure depends on many factors including the size, number, and distribution of hydrophobic amino acids; the number of repeat structures in the polypeptide; the concentration, purity, and size of the polypeptide; the pH and ionic strength of the solvent; the number of disulfide bonds in the molecule; and, finally, the rate of refolding.

Few general guidelines are possible because the conditions that promote efficient refolding vary widely from protein to protein. Common sense, however, suggests that it would be best to establish a basic set of conditions that minimizes chemical modification of amino acid side chains, inhibits proteolysis, and, in the case of cytosolic proteins, suppresses formation of intermolecular disulfide bonds during purification of the denatured protein. The refolding process can then be optimized by gradually reducing the concentration of denaturing agents and, for secreted proteins, by shifting the balance between oxidizing and reducing conditions at various stages during solubilization and renaturation (Wulfing and Pluckthun 1994). For details of several protocols that have been used successfully with different proteins, please see Marston (1987) and Burgess (1996). The sequence of recovery, solubilization, and refolding of expressed protein from inclusion bodies is diagrammed in Figure 15-6.

Various commercial resources are available for determining the most appropriate refolding strategy for the particular protein under study (e.g., please see the protocols and reagents provided with the Protein Refolding Kit, available from Novagen at [www.novagen.com](http://www.novagen.com)). Although no refolding method is perfect, a technique that yields even a few percent of the expressed protein in an active form will usually provide enough material for subsequent biochemical experimentation. It is often possible to separate the refolded protein from the unfolded and aggregated forms of the polypeptide by gel filtration chromatography (Lin et al. 1989).



**FIGURE 15-6 Methods for Protein Refolding**

A number of strategies are presented that are used to optimize the recovery of functional target protein. Inclusion bodies may be solubilized by exposure to high molarity denaturants, detergents, acidic or alkali buffers, or a combination of reagents. Following solubilization, the target protein may be subjected to any of various strategies for refolding that result in the removal of the solubilizing agent. The most effective strategy for a particular protein must be determined empirically. In general, the presence of cysteine residues in the target protein, or specific requirements for proper formation of essential disulfides, will dictate the use of a reducing agent in the solubilization and refolding buffers. (Reprinted, with permission, from Novagen, Inc.)

---

## EXPRESSION OF CLONED GENES

---

Expression of cloned genes is perhaps the last area of molecular cloning that retains some vestige of the pioneering spirit. Because the routes for isolating genes and cDNAs are now so well-mapped and because enzymes and reagents of high quality are available at almost every step of the way, cloners can usually travel from protein to gene in comfort and with reasonable confidence. However, there is one region of molecular cloning — expression of cloned genes — of which travellers must beware. It is a maze of mirages where success depends on chance and experience may be of little benefit. It is the one area in molecular cloning where investigators can do everything perfectly and still see the experiments fail.

The reasons for this are clear. Too little is known about the mechanism of folding of proteins in different organisms to predict which host-vector system might be best for a given protein, and few methods are available to increase the efficiency of folding or to prevent the aggregation, denaturation, and/or degradation of foreign proteins expressed in environments that are unnatural to them. In the absence of any useful guiding principles, the expression of every cDNA or gene presents a unique set of problems, which must be solved empirically.

### Selection of an Expression System

Five major expression systems have been developed to a point where they are reasonably portable from one laboratory to another, where the necessary components and vectors are readily available from commercial sources or public repositories, and where success can be documented with more than a handful of proteins. The host cells for these systems are *E. coli*, *Bacillus subtilis*, *Saccharomyces cerevisiae*, cultured insect cells, and cultured mammalian cells. Very few, if any, laboratories have all five of these systems running and most investigators will have to choose among the various options.

- **Expression in *E. coli*.** Please see Chapter 15.
- **Expression in mammalian systems.** Please see Chapter 17.
- **Expression in *Saccharomyces cerevisiae*.** Although the range of available expression vectors is extensive (Emr 1990), few foreign proteins have been produced in yeast at levels that are more than modest. *S. cerevisiae* is generally a fairly inefficient factory for recombinant proteins. However, the extremely powerful genetic systems of the organism have been exploited in two important ways, neither of which requires massive overproduction of foreign proteins: First, because many mutants of *S. cerevisiae* can be complemented by expression of the homologous mammalian proteins, yeasts may be used as hosts for the isolation of mammalian cDNAs by complementation. Second, the powerful genetics of yeast have been elegantly exploited to develop selective systems for the isolation of genes that encode pairs of interacting proteins (please see Chapter 18, Protocol 1).
- **Expression in *Bacillus subtilis*.** *B. subtilis* has a well-developed secretory system, and recombinant proteins can often be delivered to the medium in high yield in a soluble and active form. However, this is not necessarily a great advantage since *B. subtilis* also secretes a number of proteases with powerful degradative activities. In addition, the range of vectors is rather limited, and there are few examples of proteins that can be expressed more efficiently in *B. subtilis* than in *E. coli*.
- **Expression in cultured insect cells.** The baculovirus expression system is used to generate large quantities of recombinant proteins in cultured insect cells. A potential advantage of the system is that proteins secreted from insect cells undergo a form of complex glycosylation. However, a major disadvantage is that expression of the foreign protein occurs during acute lytic infection of cells with a recombinant baculovirus stock. Protein production therefore occurs for only a short period of time and results in cell death. Consequently, there is a constant need to generate new virus stocks and new cells for infection. Please see the information panel on **BACULOVIRUSES AND BACULOVIRUS EXPRESSION SYSTEMS** in Chapter 17.



## E. COLI EXPRESSION SYSTEMS

Expression of foreign genes in bacteria has always been the Grail of molecular cloning. The early cloners were remarkably confident that *E. coli* could be reprogrammed to elaborate any desired protein in quantities sufficient for any desired purpose. During the Great Recombinant DNA debate of the early 1970s, the idea that there might be problems in constructing strains of *E. coli* that would make proteins to order was hardly questioned. In fact, much of the discussion centered around the degrees of physical and biological containment that would be required to protect the world from bacteria that expressed this or that foreign gene. Synthesis of foreign proteins in prokaryotes was feared as the approaching apocalypse by the Luddite fringe and was simultaneously peddled to Wall Street as an apotheosis by the more entrepreneurial of the molecular biologists.

As it turned out, neither the dark paranoia nor the day-glo optimism of those times was justified. The doomsayers were spectacularly wrong, as they since have been about other perceived dangers in molecular cloning. In the 20 years since the Asilomar conference, many thousands of strains of *E. coli* have been constructed that express foreign proteins, without untoward consequences. In recognition of this fact, most of the regulations that restricted expression work in *E. coli* were dropped in the United States a few years after Asilomar, with only token opposition from the hard-core pessimists. As for the entrepreneurs, only a few of them became rich from proteins that were synthesized in *E. coli*. For the most part, these proteins were small cytokines and growth factors whose secretion into medium could be easily engineered. Larger secreted proteins and cytosolic proteins of all sizes proved to be far more difficult to produce. After several years of effort to solve problems of prokaryotic expression, most genetic engineering companies abandoned *E. coli* in favor of eukaryotic cells as the means to produce larger secreted proteins.

Although the solutions remain elusive, the reasons for these problems are clear enough. Too little is known about the mechanism of folding of proteins in *E. coli*, and few infallible methods are available either to increase the efficiency of folding or to prevent the aggregation, denaturation, and/or degradation of foreign proteins expressed at high levels in an environment that is unnatural to them. In some cases, the use of mutants of *E. coli* (e.g., *lon* mutants) that are defective in degradation has proven helpful; in many other cases, solubility problems have been alleviated by expressing the polypeptide of interest as part of a hybrid protein. However, most nonsecreted proteins synthesized in *E. coli* accumulate as denatured aggregates, called inclusion bodies, which can be purified by differential centrifugation (for review, please see Marston 1986; Cousens et al. 1987). These aggregates are insoluble in aqueous buffers at neutral pH, but they usually can be dissolved in buffers that are markedly acidic or alkaline or contain high concentrations of detergents, organic solvents, or denaturants. In a few cases, it has then been possible to fold the solubilized protein *in vitro* into an active or native state (for reviews, please see Marston 1986; Kohno et al. 1990).

Most success with *E. coli* expression systems has been achieved with small secretory proteins (Goeddel 1990), which can be translocated into the periplasmic space of *E. coli*, from where they can be recovered and purified, sometimes in an active form. To achieve maximum efficiency, however, it is usually necessary to replace the eukaryotic hydrophobic signal sequences with a bacterial signal sequence and cleavage site. It is unreasonable to expect secretory proteins that depend on glycosylation or specific proteolytic cleavage to be recovered in an active state.

As indicated above, small cytosolic proteins and polypeptides (<100 residues in length) are best expressed in *E. coli* as fusion proteins. The carrier sequences often stabilize the protein of interest against intracellular degradation and provide a binding site that can be used for affinity purification. The protein of interest can sometimes be recovered in an active form by including a proteolytic cleavage site at an appropriate location in the fusion protein.

During the last 20 years, many different carrier sequences have been used in hybrid proteins. Any one of them may work well in a specific construct or in a particular bacterial strain, but none of them is a universal panacea. However, newly developed expression systems that utilize *E. coli* protein thioredoxin as a carrier appear to be a significant improvement over more traditional fusion partners, such as  $\beta$ -galactosidase. The following are the two most problematic groups of proteins.

- **Cytosolic proteins** >100 residues are sometimes toxic, often unstable, and frequently form insoluble inclusion bodies.

- **Large cell-surface proteins and secretory proteins** are translocated inefficiently across the inner membrane of *E. coli*, and only a small fraction of the molecules that reach the periplasmic space are able to fold into an active configuration. Perhaps this is not surprising in view of the fact that in mammalian cells, transport, folding, and biological activity of cell surface and large secretory proteins are often dependent on the correct constellation of chaperone proteins, as well as glycosylation and/or other forms of posttranslational modification.

In the absence of any informing principles that would help to find a general solution to the problems of intracellular protein folding, the expression of every cDNA encoding “difficult” proteins in *E. coli* presents a unique set of problems, which must be solved empirically.

---

## LACZ FUSIONS

---

Gene fusions are created by joining together two pieces of DNA that were not previously connected. Often, the regulatory sequences of the gene of interest are placed upstream of sequences coding for a reporter molecule whose level of expression can be easily measured, for example,  $\beta$  galactosidase. This type of gene fusion allows rapid experimental analysis of the physiological conditions affecting the expression of the gene of interest; and it facilitates mutational analysis of the upstream regulatory region. Gene fusions are also used to create hybrid proteins in which the protein of interest is attached to the amino terminus or the carboxyl terminus of a carrier protein. Many vector systems have been developed for the expression of *lacZ* fusion genes. Some of these are listed in Table 15-6. *LacZ* fusion proteins have several advantages:

- Their expression is placed under the dominion of a well-characterized promoter whose activity can be increased by several orders of magnitude by simple manipulation of the bacterial culture. Transcription of *LacZ* is subject to both negative and positive regulation. Negative regulation is exerted by the *Lac* repressor, which binds to the operator (*LacO*) and prevents synthesis of *lac* mRNA. The *lac* repressor, a tetrameric protein of 150 kD, is encoded by the *lacI* gene. Normally, there are about ten molecules of repressor per cell, sufficient to smother, but not completely strangle, transcription of the *Lac* operon. In the absence of inducer, basal expression generates ~60 molecules of the monomer of  $\beta$ -galactosidase per cell when *lacZ* is carried as a chromosomal *F'* gene, and higher levels when the gene is carried on a multicopy plasmid. Because this level of basal expression may lead to problems if a *LacZ* fusion protein is expressed that is toxic to *E. coli*, many *LacZ* fusion systems make use of a mutant *lacI* gene (*lacI<sup>q</sup>*; Müller-Hill et al. 1968) that synthesizes about tenfold more repressor than wild type. This overproduction of repressor suppresses the basal level of transcription of the *Lac* operon in the absence of inducer. Repression of the *LacZ* operon is relieved by inducers, such as IPTG, which bind to the repressor and cause a conformational change that lowers the affinity of the repressor for the *lac* operator. A fully induced culture of *E. coli* contains ~60,000 molecules of *lacZ*  $\beta$ -galactosidase per cell.

In addition to an inducer such as IPTG, the efficient expression of *lacZ* requires cAMP and an activator protein, CAP. The cAMP-bound form of CAP binds with high affinity to a site in the *lac* promoter (Majors 1975) and facilitates binding of RNA polymerase. Because CAP acts in a positive fashion, this type of regulation is called positive control. In the absence of CAP, the levels of *lac* gene products are reduced up to 50-fold (Beckwith et al. 1972). The activity of CAP is controlled by the intracellular level of cAMP, which is, in turn, regulated by the concentration of glucose. Growth of cells on glucose reduces the intracellular concentration of cAMP and inhibits induction of the *lac* operon.

- The fusion protein inherits a ribosome-binding site and initiation sequence whose efficiency is proven. *lacZ* does not have a particularly good Shine-Dalgarno sequence, and the sequences immediately surrounding the start codon are not optimal for initiation of translation (Hui et al. 1984). Nevertheless, ini-

tiation of protein synthesis occurs efficiently enough that it is not normally a limiting factor in expression of LacZ fusion proteins.

- The *lacZ* segment of the fusion protein serves as an identification tag that can be used for affinity purification on Sepharose columns containing the immobilized inhibitor of  $\beta$ -galactosidase, *p*-aminophenyl- $\beta$ -D-thio-galactoside (also known as TPEG or APTG) (Steers et al. 1971; Germino et al. 1983; Ullmann 1984).
- Fusion to *lacZ* offers some protection against the intracellular proteolysis that lays waste to many foreign proteins expressed in *E. coli*. Produced on their own, these proteins evidently fold into conformations that are susceptible to degradation by ATP-dependent proteases such as *lon* and *clp* (Gottesman 1989). This fate is particularly true of small polypeptides such as somatostatin (Itakura et al. 1977), insulin (Goeddel et al. 1979), and  $\beta$ -endorphin (Shine et al. 1980). When attached to *lacZ* or another carrier, these proteins are stabilized to the point where the fusion protein can comprise 20% of the total cell protein (for review, please see Marston 1986).
- Finally, the high levels of expression that can be achieved with LacZ fusion proteins promote the formation of insoluble aggregates or inclusion bodies, which can be isolated easily (Marston 1987). However, to obtain active fusion protein, the inclusion bodies must be dissolved in strongly denaturing buffers, and the fusion protein must then be purified and refolded. These steps are not trivial, and conditions for each of them must be developed empirically. For reasons that are not understood, foreign proteins attached to the carboxyl terminus of *lacZ* are usually sequestered into inclusion bodies; amino-terminal fusion proteins are generally soluble and can be directly purified from cell lysates by affinity chromatography.

Like other expression systems, LacZ fusions have some disadvantages. First, only a small fraction of the amino acid residues of the fusion proteins may belong to a foreign protein. Second, to obtain biologically active material, the foreign protein usually must be cleaved, either enzymatically or chemically, from its LacZ carrier. This cleavage can be accomplished by building a unique cleavage site between  $\beta$ -galactosidase and the fusion protein. However, if the fusion protein is insoluble, cleavage may be possible only after denaturation or in the presence of denaturant. This feature places restrictions on the types of enzymatic cleavage that can be used. Third,  $\beta$ -galactosidase is not a secreted protein and cannot be translocated across the membrane of *E. coli* even if it is equipped with a signal sequence. Typically, LacZ fusion proteins that carry functional signal sequences become jammed in the membrane and are toxic to the cell (Bassford et al. 1979; Moreno et al. 1980).

Despite these disadvantages, *lacZ* fusions were used successfully in the 1980s to express more than 50 proteins in *E. coli*. Nowadays, however, *lacZ* would probably not be the system of choice. Vectors containing promoters for bacteriophage T7 RNA polymerase have tighter transcription control and can drive higher levels of expression (Studier et al. 1990). Polyhistidine tracts (Smith et al. 1988) may now be the first choice for protein tags since they generally do not destroy protein function and allow affinity purification to be carried out under gentle conditions.

TABLE 15-6 Systems for Expression of LacZ Fusion Proteins

PLASMID VECTOR	SITE OF INSERTION OF FOREIGN DNA	PROMOTER	COMMENTS	REFERENCES
pUR series	carboxyl terminus of <i>lacZ</i>	UV5 <i>lac</i>	Contains multiple cloning sites in all three reading frames.	Rüther and Müller-Hill (1983)
pUK series	amino terminus of <i>lacZ</i>	UV5 <i>lac</i>	Contains cloning sites in all three reading frames.	Koenen et al. (1985)
pEX series	carboxyl terminus of <i>lacZ</i>	bacteriophage $\lambda p_R$	Contains a cloning site in all three reading frames.	Stanley and Luzio (1984)
pMR100		UV5 <i>lac</i> (2 copies)	When foreign DNA is inserted into the polycloning site, a fusion protein is synthesized that has the amino terminus of the bacteriophage $\lambda$ <i>cl</i> gene, a central segment of foreign protein, and $\beta$ -galactosidase at the carboxyl terminus.	Gray et al. (1982)
pAX series	carboxyl terminus of <i>lacZ</i>	<i>lac</i>	At the end of the <i>lacZ</i> gene, PAX vectors contain (1) a hinge region of 187 bp encoding a fragment of collagen, (2) an endoproteinase Xa recognition site followed by (3) a multiple cloning site and (4) the bacteriophage $\lambda$ transcriptional terminator.	Germino and Bastia (1984)
pUC series, pGEMZ series, Bluescript series, and many others	amino terminus of $\alpha$ -fragment of $\beta$ -galactosidase	<i>lac</i>	Contains multiple cloning sites in all three reading frames; insertion of foreign DNA in any frame abolishes $\alpha$ -complementation; insertion in the correct reading frame generates a LacZ- $\alpha$ -fragment fusion protein.	Messing (1983); Norlander et al. (1983); Yanisch-Perron et al. (1985) Product literature from Stratagene and Promega

UV5*lac* is a double mutant of the *lac* promoter in which a G to A transition lies adjacent to a T to A transversion in the RNA polymerase-binding site. UV5*lac* is an "up" promoter that allows transcription of the *lac* operon in the absence of the CAP-AMP complex (Dickson et al. 1975).

---

**CHAOTROPIC AGENTS**

---

In molecular cloning, chaotropic agents are used chiefly to destroy the three-dimensional structure of proteins. The most powerful of the commonly used protein denaturants are guanidinium isothiocyanate and guanidinium chloride, which convert most proteins to a randomly coiled state (Tanford 1968; Gordon 1972). The mechanism of this conversion is unclear, although it seems to involve binding of progressively greater amounts of the guanidinium salt to the protein as denaturation proceeds (Gordon 1972).

The first guanidinium salt to be used as a deproteinization agent during isolation of RNA was chloride (Cox 1968). Although it is a strong inhibitor of ribonuclease, guanidinium chloride (also known as guanidine chloride or aminoformamidine hydrochloride) is not a powerful enough denaturant to allow extraction of intact RNA from tissues that are rich in RNase, such as the pancreas. Guanidinium isothiocyanate (also known as guanidinium rhodanide or guanidine thiocyanate) is a stronger chaotropic agent because it contains a reductant to break protein disulfide bonds and potent cationic and anionic groups that form strong hydrogen bonds. The procedure of Chirgwin et al. (1979), which involves lysis of cells by guanidinium isothiocyanate and ultracentrifugation of the cell lysates through CsCl gradients (Glisin et al. 1973), has become a standard method for isolation of undegraded RNA. More recently, procedures have been developed that combine guanidinium thiocyanate and extraction with phenol/chloroform (Chomczynski and Sacchi 1987; Puissant and Houdebine 1990; please see Chapter 7, Protocol 1). Because the ultracentrifugation step is eliminated, many samples can be processed simultaneously at modest cost.

In a perverse fashion, chaotropic agents, such as guanidine hydrochloride, can also be used to enhance the renaturation of a denatured protein. This use finds two major applications in molecular biology. First, the overexpression of foreign proteins in heterologous hosts, such as *E. coli*, often leads to the formation of aggregates of the expressed protein. These so-called inclusion bodies are readily isolated by low-speed centrifugation and usually consist of almost pure accretions of denatured forms of the foreign protein. The inclusion bodies can sometimes be solubilized with 6 M solutions of guanidine hydrochloride, which acts by dissociating the aggregates and completely denaturing the protein. The unfolded foreign protein will often refold into its native conformation if the chaotropic agent is slowly removed from the solution by dialysis against buffer. This renaturation procedure has been used to refold hundreds of recombinant proteins (Marston 1987).

Second, a similar denaturation/renaturation protocol is useful when screening bacteriophage  $\lambda$  expression libraries with antibody or DNA-binding-site probes (Vinson et al. 1988). In this case, intact or fusion proteins expressed from cDNA inserts are transferred to nitrocellulose filters (Young and Davis 1983). The filters are then incubated in a series of buffers containing 6 M, 3 M, and 0 M guanidinium hydrochloride to denature and renature the expressed proteins. Finally, the filters are probed with an antibody specific for the protein of interest or with a concatenated DNA probe made up of repeats of a DNA sequence specifically recognized by the target protein (e.g., a DNA-binding transcription factor). Vinson et al. (1988) found that the inclusion of a denaturation/renaturation step in the screening procedure could make all or no difference in the identification of a particular cDNA.

## REFERENCES

- Amann E. and Brosius J. 1985. "ATG vectors" for regulated high-level expression of cloned genes in *Escherichia coli*. *Gene* **40**: 183-190.
- Amann E., Brosius J., and Ptashne M. 1983. Vectors bearing a hybrid *trp-lac* promoter useful for regulated expression of cloned genes in *Escherichia coli*. *Gene* **25**: 167-178.
- Ames G.E.-L., Prody C., and Kustu S. 1984. Simple, rapid, and quantitative release of periplasmic proteins by chloroform. *J. Bacteriol.* **160**: 1181-1183.
- Barnes H.J., Arlotto M.P., and Waterman M.R. 1991. Expression and enzymatic activity of recombinant cytochrome P450 17 $\alpha$ -hydroxylase in *Escherichia coli*. *Proc. Natl. Acad. Sci.* **88**: 5597-5601.
- Bassford Jr., P.J., Silhavy T.J., and Beckwith J.R. 1979. Use of gene fusion to study secretion of maltose-binding protein into *Escherichia coli* periplasm. *J. Bacteriol.* **139**: 19-31.
- Beckwith J., Grodzicker T., and Arditti R. 1972. Evidence for two sites in the *lac* promoter region. *J. Mol. Biol.* **69**: 155-160.
- Belder J., Nguyen-Disteche M., Houba-Herlin N., Ghuysen J.M., Maruyama I.N., Hara H., Hirota Y., and Inouye M. 1988. Overexpression, solubilization and refolding of a genetically engineered derivative of the penicillin-binding protein 3 of *Escherichia coli* K12. *Mol. Microbiol.* **2**: 519-525.
- Bennett A.D., Rhind S.K., Lowe P.A., and Hentschel C.C.G. 1984. Polypeptide and protein products, and processes for their production and use. *European Patent Application 0131363*.
- Bennetzen J.L. and Hall B.D. 1982. Codon selection in yeast. *J. Biol. Chem.* **257**: 3026-3031.
- Bernard H.-U. and Helinski D.R. 1979. Use of the lambda phage promoter  $P_{\lambda}$  to promote gene expression in hybrid plasmid cloning vehicles. *Methods Enzymol.* **68**: 482-492.
- Blond-Elguindi S., Cwirla S.E., Dower W.J., Lipshutz R.J., Sprang S.R., Sambrook J.F., and Gething M.-J. 1993. Affinity panning of a library of peptides displayed on bacteriophages reveals the binding specificity of BiP. *Cell* **75**: 717-728.
- Boutelje J., Karlstrom A.R., Hartmanis M.G., Holmgren E., Sjogren A., and Levine R.L. 1990. Human immunodeficiency viral protease is catalytically active as a fusion protein: Characterization of the fusion and native enzymes produced in *Escherichia coli*. *Arch. Biochem. Biophys.* **283**: 141-149.
- Bowden G.A. and Georgiou G. 1990. Folding and aggregation of  $\beta$ -lactamase in the periplasmic space of *Escherichia coli*. *J. Biol. Chem.* **265**: 16760-16766.
- Brewer S.J. and Sassenfeld H.M. 1985. The purification of recombinant proteins using C-terminal polyarginine fusions. *Trends Biotechnol.* **3**: 119-125.
- Brosius J. and Holy A. 1984. Regulation of ribosomal RNA promoters with a synthetic *lac* operator. *Proc. Natl. Acad. Sci.* **81**: 6929-6933.
- Buell G., Schulz M.-F., Selzer G., Chollet A., Movva N.R., Semon D., Escanez S., and Kawashima E. 1985. Optimizing the expression in *E. coli* of a synthetic gene encoding somatomedin-C (IGF-I). *Nucleic Acids Res.* **13**: 1923-1938.
- Burgess R.R. 1996. Purification of overproduced *Escherichia coli* RNA polymerase sigma factors by solubilizing inclusion bodies and refolding from Sarkosyl. *Methods Enzymol.* **273**: 145-149.
- Calos M.P. 1978. DNA sequence for a low-level promoter of the *lac* repressor gene and an "up" promoter mutation. *Nature* **274**: 762-765.
- Canova-Davis E., Eng M., Mulklu V., Reifsnnyder D.H., Olson C.V., and Ling V.T. 1992. Chemical heterogeneity as a result of hydroxylamine cleavage of a fusion protein of human insulin-like growth factor I. *Biochem. J.* **285**: 207-213.
- Carrington J.C. and Dougherty W.G. 1988. A viral cleavage site cassette: Identification of amino acid sequences required for tobacco etch virus polyprotein processing. *Proc. Natl. Acad. Sci.* **85**: 3391-3395.
- Carter P. and Wells J.A. 1987. Engineering enzyme specificity by "substrate-assisted catalysis." *Science* **237**: 394-399.
- Cerny G. and Teuber M. 1971. Differential release of periplasmic versus cytoplasmic enzymes from *Escherichia coli* B by polymyxin B. *Arch. Mikrobiol.* **78**: 166-179.
- Chang J.-Y. 1985. Thrombin specificity. Requirement for polar amino acids adjacent to the thrombin cleavage site of polypeptide substrate. *Eur. J. Biochem.* **151**: 217-224.
- Chen H., Bjerknes M., Kumar R., and Jay E. 1994. Determination of the optimal aligned spacing between the Shine-Dalgarno sequence and the translation initiation codon of *Escherichia coli* mRNAs. *Nucleic Acids Res.* **22**: 4953-4957.
- Chinery R., Poulosom R., Elia G., Hanby A.M., and Wright N.A. 1993. Expression and purification of a trefoil peptide motif in a  $\beta$ -galactosidase fusion protein and its use to search for trefoil-binding sites. *Eur. J. Biochem.* **212**: 557-563.
- Chirgwin J.M., Przybyla A.E., MacDonald R.J., and Rutter W.J. 1979. Isolation of biologically active ribonucleic acid from sources enriched in ribonuclease. *Biochemistry* **18**: 5294-5299.
- Chomczynski P. and Sacchi N. 1987. Single-step method of RNA isolation by acid guanidinium thiocyanate-phenol-chloroform extraction. *Anal. Biochem.* **162**: 156-159.
- Chrunyk B.A., Evans J., Lillquist J., Young P., and Wetzel R. 1993. Inclusion body formation and protein stability in sequence variants of interleukin-1 $\beta$ . *J. Biol. Chem.* **268**: 18053-18061.
- Cousens L.S., Shuster J.R., Gallagos C., Ku L., Stempien M.M., Urdea M.S., Sanchez-Pescador R., Taylor A., and Tekamp-Olson P. 1987. High level expression of proinsulin in the yeast, *Saccharomyces cerevisiae*. *Gene* **61**: 265-275.
- Cox R.A. 1968. The use of guanidinium chloride in the isolation of nucleic acids. *Methods Enzymol.* **12**: 120-129.
- de Boer H.A., Comstock L.J., and Vasser M. 1983. The *tac* promoter: A functional hybrid derived from the *trp* and *lac* promoters. *Proc. Natl. Acad. Sci.* **80**: 21-25.
- Derbyshire V., Astatke M., and Joyce C.M. 1993. Re-engineering the polymerase domain of Klenow fragment and evaluation of overproduction and purification strategies. *Nucleic Acids Res.* **21**: 5439-5448.
- de Smit M.H. and van Duin J. 1994a. Translational initiation on structured messengers. Another role for the Shine-Dalgarno interaction. *J. Mol. Biol.* **235**: 173-184.
- . 1994b. Control of translation by mRNA secondary structure in *Escherichia coli*. A quantitative analysis of literature data. *J. Mol. Biol.* **244**: 144-150.
- Dickson R.C., Abelson J., Barnes W.M., and Reznikoff W.S. 1975. Genetic regulation: The Lac control region. *Science* **187**: 27-35.
- di Guan C., Li P., Riggs P.D., and Inouye H. 1988. Vectors that facilitate the expression and purification of foreign peptides in *Escherichia coli* by fusion to maltose-binding protein. *Gene* **67**: 21-30.

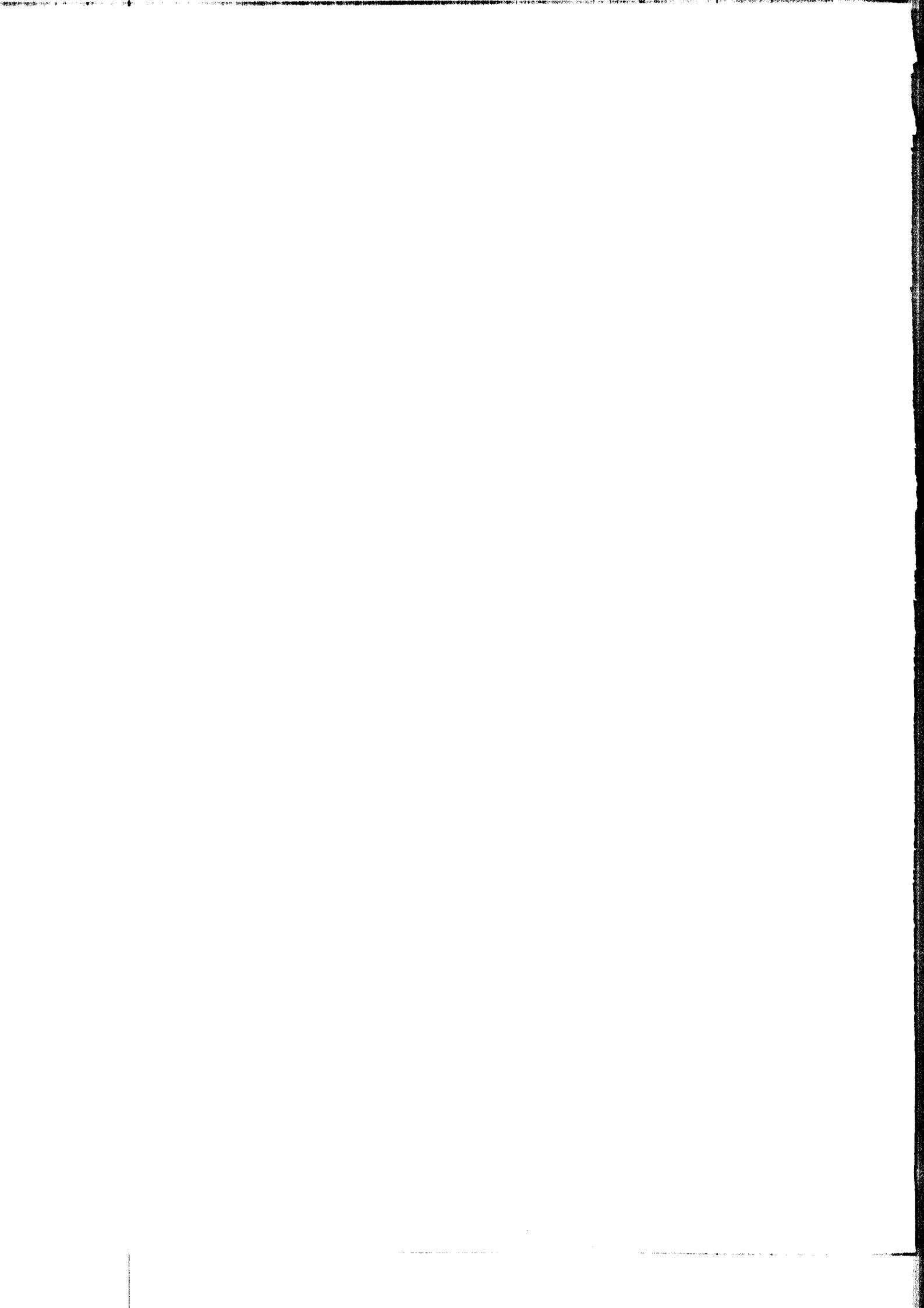
- Dougherty W.G. and Parks T.D. 1989. Molecular genetic and biochemical evidence for the involvement of the heptapeptide cleavage sequence in determining the reaction profile at two tobacco etch virus cleavage sites in cell-free assays. *Virology* **172**: 145–155.
- Dougherty W.G., Carrington J.C., Cary S.M., and Parks T.D. 1988. Biochemical and mutational analysis of a plant virus polyprotein cleavage site. *EMBO J.* **7**: 1281–1287.
- Dykes C.W., Brookless A.B., Coomber B.A., Noble S.A., Humber D.C., and Hobden A.N. 1988. Expression of atrial natriuretic factor as a cleavable fusion protein with chloramphenicol acetyltransferase in *Escherichia coli*. *Eur. J. Biochem.* **174**: 411–416.
- Edalji R., Pitot-Matias T.J., Pratt S.D., Egan D.A., Severin J.M., Gubbins E.G., Petros A.M., Fesik S.W., Burres N.S., and Holzman T.F. 1992. High-level expression of recombinant FK-binding protein from a fusion precursor. *J. Protein Chem.* **11**: 213–223.
- Emr S.D. 1990. Heterologous gene expression in yeast. *Methods Enzymol.* **185**: 231–233.
- Forsberg G., Palm G., Ekebacke A., Josephson S., and Hartmanis M. 1990. Separation and characterization of modified variants of recombinant human insulin-like growth factor I derived from a fusion protein secreted from *Escherichia coli*. *Biochem. J.* **271**: 357–363.
- Forsberg G., Baastrup B., Rondahl H., Holmgren E., Pohl G., Hartmanis M., and Lake M. 1992. An evaluation of different enzymatic cleavage methods for recombinant fusion proteins, applied on des(1-3)insulin-like growth factor I. *J. Protein Chem.* **11**: 201–211.
- Forsberg G., Brobjer M., Holmgren E., Bergdahl K., Persson P., Gautvik K.M., and Hartmanis M. 1991. Thrombin and H64A subtilisin cleavage of fusion proteins for preparation of human recombinant parathyroid hormone. *J. Protein Chem.* **10**: 217–226.
- Frankel S., Sohn R., and Leinwand L. 1991. The use of sarkosyl in generating soluble protein after bacterial expression. *Proc. Natl. Acad. Sci.* **88**: 1192–1196.
- Gearing D.P., Nicola N.A., Metcalf D., Foote S., Willson T.A., Gough N.M., and Williams R.L. 1989. Production of leukemia factor in *Escherichia coli* by a novel procedure and its use in maintaining embryonic stem cells in culture. *Bio/Technology* **7**: 1157–1161.
- Georgiou G. and Valax P. 1996. Expression of correctly folded proteins in *Escherichia coli*. *Curr. Opin. Biotechnol.* **7**: 190–197.
- Germino J. and Bastia D. 1984. Rapid purification of a cloned gene product by genetic fusion and site-specific proteolysis. *Proc. Natl. Acad. Sci.* **81**: 4692–4696.
- Germino J., Gray J.G., Charbonneau H., Vanaman T., and Bastia D. 1983. Use of gene fusions and protein-protein interaction in the isolation of a biologically active regulatory protein: The replication initiator protein of plasmid R6K. *Proc. Natl. Acad. Sci.* **80**: 6848–6852.
- Glisin V., Crkvenjakov R., and Byus C. 1973. Ribonucleic acid isolated by cesium chloride centrifugation. *Biochemistry* **13**: 2633–2637.
- Goeddel D.V. 1990. Systems for heterologous gene expression. *Methods Enzymol.* **185**: 3–7.
- Goeddel D.V., Kleymid D.G., Bolivar F., Heyneker H.L., Yansura D.G., Crea R., Hirose T., Kraszewski A., Itakura K., and Riggs A.D. 1979. Expression in *Escherichia coli* of chemically synthesized genes for human insulin. *Proc. Natl. Acad. Sci.* **76**: 106–110.
- Gold L. 1988. Posttranscriptional regulatory mechanisms in *E. coli*. *Annu. Rev. Biochem.* **57**: 199–233.
- Goldberg A. 1992. The mechanism and functions of ATP-dependent proteases in bacterial and mammalian cells. *Eur. J. Biochem.* **203**: 9–23.
- Goliger J.A. and Roberts J.W. 1987. Bacteriophage 82 gene Q and Q protein. Sequence, overproduction, and activity as a transcription antiterminator in vitro. *J. Biol. Chem.* **262**: 11721–11725.
- Gordon J.A. 1972. Denaturation of globular proteins. Interaction of guanidinium salts with three proteins. *Biochemistry* **11**: 1862–1870.
- Gottesman S. 1989. Genetics of proteolysis in *Escherichia coli*. *Ann. Rev. Genet.* **23**: 163–198.
- . 1990. Minimizing proteolysis in *Escherichia coli*: Genetic solutions. *Methods Enzymol.* **185**: 119–129.
- Gottesman S. and Maurizi M.R. 1992. Regulation by proteolysis: Energy-dependent proteases and their targets. *Microbiol. Rev.* **56**: 592–621.
- Grantham R., Gautier C., and Gouy M. 1980a. Codon frequencies in 119 individual genes confirm consistent choices of degenerate bases according to genome type. *Nucleic Acids Res.* **8**: 1893–1912.
- Grantham R., Gautier C., Gouy M., Jacobzone M., and Mercier R. 1981. Codon catalog usage is a genome strategy modulated for gene expressivity. *Nucleic Acids Res.* **9**: r43–r74.
- Grantham R., Gautier C., Gouy M., Mercier R., and Pavé A. 1980b. Codon catalog usage and the genetic hypothesis. *Nucleic Acids Res.* **8**: r49–r62.
- Gray G.L., Baldrige J.S., McKeown K.S., Heyneker H.L., and Chang C.N. 1985. Periplasmic production of correctly processed human growth hormone in *Escherichia coli*: Natural and bacterial signal sequences are interchangeable. *Gene* **39**: 247–254.
- Gray M.R., Colot H.V., Guarente L., and Rosbash M. 1982. Open reading frame cloning: Identification, cloning, and expression of open reading frame DNA. *Proc. Natl. Acad. Sci.* **79**: 6598–6602.
- Grieco F., Hay J.M., and Hull R. 1992. An improved procedure for the purification of protein fused with glutathione S-transferase. *BioTechniques* **13**: 856–858.
- Guzman-Verduzco L.M. and Kupersztoch Y.M. 1990. Export and analysis of a fusion between the extracellular heat-stable enterotoxin and the periplasmic B subunit of the heat-labile enterotoxin in *Escherichia coli*. *Mol. Microbiol.* **4**: 253–264.
- Haase-Pettingell C.A. and King J. 1988. Formation of aggregates from a thermolabile in vivo folding intermediate in P22 tail-spike maturation. A model for inclusion body formation. *J. Biol. Chem.* **263**: 4977–4983.
- Haffey M.L., Lehman D., and Boger J. 1987. Site-specific cleavage of a fusion protein by renin. *DNA* **6**: 565–571.
- Harlow E. and Lane D. 1988. *Antibodies: A laboratory manual*. Cold Spring Harbor Laboratory, Cold Spring Harbor, New York.
- Hennig L. and Schafer E. 1998. Protein purification with C-terminal fusion of maltose binding protein. *Protein Expr. Purif.* **14**: 367–370.
- Hiraoka Y., Nomata Y., Matsuo K., Tsubota N., Tanabe K., and Fukusawa T. 1991. Efficient production of biologically active human prolactin in *Escherichia coli*. *Mol. Cell. Biol.* **11**: 147–154.
- Hochuli E., Bannwarth W., Döbeli H., Gentz R., and Stüber D. 1988. Genetic approach to facilitate purification of recombi-

- nant proteins with a novel metal chelate adsorbant. *Bio/Technology* **6**: 1321–1325.
- Hopp T.P., Prickett K.S., Price V.L., Libby R.T., March C.J., Cerretti D.P., Urdal D.L., and Conlon P.J. 1988. A short polypeptide marker sequence useful for recombinant protein identification and purification. *Bio/Technology* **6**: 1204–1210.
- Hui A., Hayflick J., Dinkelspiel K., and de Boer H.A. 1984. Mutagenesis of the three bases preceding the start codon of the  $\beta$ -galactosidase mRNA and its effect on translation in *Escherichia coli*. *EMBO J.* **3**: 623–629.
- Huttenhofer A. and Noller H.F. 1994. Footprinting mRNA-ribosome complexes with chemical probes. *EMBO J.* **13**: 3892–3901.
- Itakura K., Hirose T., Crea R., Riggs A.D., Heyneker H.L., Bolivar E., and Boyer H.W. 1977. Expression in *Escherichia coli* of a chemically synthesized gene for the hormone somatostatin. *Science* **198**: 1056–1063.
- Ivanov I., Alexandrova R., Dragulev B., Saraffova A., and AbouHaidar M.G. 1992. Effect of tandemly repeated AGG triplets on the translation of CAT-mRNA in *E. coli*. *FEBS Lett.* **307**: 173–176.
- Jaenicke R. 1991. Protein-folding: Local structures, domains, subunits, and assemblies. *Biochemistry* **30**: 3147–3161.
- Jakoby W.B. and Ziegler D.M. 1990. The enzymes of detoxication. *J. Biol. Chem.* **265**: 20715–20718.
- James G.T. 1978. Inactivation of the protease inhibitor phenylmethylsulfonyl fluoride in buffers. *Anal. Biochem.* **86**: 574–579.
- Jespers L., Sonveaux E., Fastrez J., Phanopoulos A., and Davidson J. 1991. Overexpression of the phage lambda lysozyme cloned in *Escherichia coli*: Use of a degenerative mixture of synthetic ribosome binding sites and increase of protein stability *in vivo*. *Protein Eng.* **4**: 485–492.
- Kane J.F. and Hartley D.L. 1988. Formation of recombinant protein inclusion bodies in *Escherichia coli*. *Trends Biotechnol.* **6**: 95–101.
- Kellermann O.K. and Ferenci T. 1982. Maltose-binding protein from *Escherichia coli*. *Methods Enzymol.* **90**: 459–463.
- King R., Wells J.R., Krieg P., Snoswell M., Brazier J., Bagley C.J., Wallace J.C., Ballard F.J., Ross M., and Francis G.L. 1992. Production and characterization of recombinant insulin-like growth factor-I (IGF-I) and potent analogues of IGF-I, with Gly or Arg substituted for Glu3, following their expression in *Escherichia coli* as fusion proteins. *J. Mol. Endocrinol.* **8**: 29–41.
- Knott J.A., Sullivan C.A., and Weston A. 1988. The isolation and characterisation of human atrial natriuretic factor produced as a fusion protein in *Escherichia coli*. *Eur. J. Biochem.* **174**: 405–410.
- Koenen M., Griesser H.-W., and Müller-Hill B. 1985. Immunological detection of chimeric  $\beta$ -galactosidases expressed by plasmid vectors. In *DNA cloning: A practical approach* (ed. D.M. Glover), vol. 1, pp. 89–100. IRL Press, Oxford, United Kingdom.
- Kohno T., Carmichael D.F., Sommer A., and Thompson R.C. 1990. Refolding of recombinant proteins. *Methods Enzymol.* **185**: 187–195.
- Kopetzki E., Schumacher G., and Buckel P. 1989. Control of formation of active soluble or inactive insoluble baker's yeast  $\alpha$ -glucosidase PI in *Escherichia coli* by induction and growth conditions. *Mol. Gen. Genet.* **216**: 149–155.
- Kozasa T. and Gilman A.G. 1995. Purification of recombinant G proteins from Sf9 cells by hexahistidine tagging of associated subunits. Characterization of  $\alpha_{12}$  and inhibition of adenylyl cyclase by  $\alpha_x$ . *J. Biol. Chem.* **270**: 1734–1741.
- Lauritzen C., Tuchsén E., Hansen P.E., and Skovgaard O. 1991. BPTI and N-terminal extended analogues generated by factor Xa cleavage and cathepsin C trimming of a fusion protein expressed in *Escherichia coli*. *Prot. Expr. Purif.* **2**: 372–378.
- LaVallie E.R. and McCoy J.M. 1995. Gene fusion expression systems in *Escherichia coli*. *Curr. Opin. Biotechnol.* **6**: 501–506.
- LaVallie E.R., DiBlasio E.A., Kovacic S., Grant K.L., Schendel P.F., and McCoy J.J. 1993. A thioredoxin gene fusion expression system that circumvents inclusion body formation in the *E. coli* cytoplasm. *Bio/Technology* **11**: 187–193.
- Lee C.A. and Beckwith J. 1986. Suppression of growth and protein secretion defects in *Escherichia coli secA* mutants by decreasing protein synthesis. *J. Bacteriol.* **166**: 878–883.
- Lee J.M. and Ullrich A. 1984. Human insulin-like growth factor (IGF) produced from a recombinant host, process, expression vector and recombinant host therefore, and IGF-containing pharmaceutical composition. *European Patent Application 0128733*.
- Light A. 1985. Protein solubility, protein modifications and protein folding. *BioTechniques* **3**: 298–306.
- Lin T.-C., Rush J., Spicer E.K., and Konigsberg W.H. 1987. Cloning and expression of T4 DNA polymerase. *Proc. Natl. Acad. Sci.* **84**: 7000–7004.
- Lin X.-L., Wong R.N.S., and Tang J. 1989. Synthesis, purification, and active site mutagenesis of recombinant porcine pepsinogen. *J. Biol. Chem.* **264**: 4482–4489.
- Maina C.V., Riggs P.D., Grandea III, A.G., Slatko B.E., Moran L.S., Tagliamonte J.A., McReynolds L.A., and di Guan C. 1988. An *Escherichia coli* vector to express and purify foreign proteins by fusion to and separation from maltose-binding protein. *Gene* **74**: 365–373.
- Majors J. 1975. Specific binding of CAP factor to *lac* promoter DNA. *Nature* **256**: 672–674.
- Makoff A.J. and Smallwood A.E. 1990. The use of two-cistron constructions in improving the expression of a heterologous gene in *E. coli*. *Nucleic Acids Res.* **18**: 1711–1718.
- Marston F.A. 1986. The purification of eukaryotic polypeptides synthesized in *Escherichia coli*. *Biochem. J.* **240**: 1–12.
- . 1987. The purification of eukaryotic polypeptides expressed in *Escherichia coli*. In *DNA cloning: A practical approach* (ed. D.M. Glover), vol. 3, pp. 59–88. IRL Press, Oxford, United Kingdom.
- Marston F.A. and Hartley D.L. 1990. Solubilization of protein aggregates. *Methods Enzymol.* **182**: 264–276.
- Marston F.A., Lowe P.A., Doel M.T., Schoemaker J.M., White S., and Angal S. 1984. Purification of calf prochymosin (prorennin) synthesized in *Escherichia coli*. *Bio/Technology* **2**: 800–804.
- Marvin H.J.P. and Witholt B. 1987. A highly efficient procedure for the quantitative formation of intact and viable lysozyme spheroplasts from *Escherichia coli*. *Anal. Biochem.* **164**: 320–330.
- Maurizi M.R. 1992. Proteases and protein degradation in *Escherichia coli*. *Experientia* **48**: 178–201.
- Messing J. 1983. New M13 vectors for cloning. *Methods Enzymol.* **101**: 20–78.
- Mieschendahl M., Petri T., and Hänggi U. 1986. A novel prophage independent TRP regulated lambda  $P_L$  expression system. *Bio/Technology* **4**: 802–808.
- Mitraki A. and King J. 1989. Protein folding intermediates and inclusion body formation. *Bio/Technology* **7**: 690–697.



- Moks T., Abrahmsén L., Osterlof B., Josephson S., Ostling M., Enfors S.-O., Persson I., Nilsson B., and Uhlén, M. 1987a. Large-scale affinity purification of human insulin-like growth factor I from culture medium of *Escherichia coli*. *Bio/Technology* **5**: 379–383.
- Moks T., Abrahmsén L., Holmgren E., Bilich M., Olsson A., Uhlén M., Pohl G., Sterky C., Hultberg H., Josephson S., Holmgren A., Jörnvall H., and Nilsson B. 1987b. Expression of human insulin-like growth factor I in bacteria: Use of optimized gene fusion vectors to facilitate protein purification. *Biochemistry* **26**: 5239–5244.
- Moreno F., Fowler A.V., Hall M., Silhavy T.J., Zabin I., and Schwartz M. 1980. A signal sequence is not sufficient to lead  $\beta$ -galactosidase out of the cytoplasm. *Nature* **286**: 356–359.
- Müller-Hill B., Crapo L., and Gilbert W. 1968. Mutants that make more *lac* repressor. *Proc. Natl. Acad. Sci.* **59**: 1259–1264.
- Nagai K. and Thøgerson H.C. 1984. Generation of  $\beta$ -globin by sequence-specific proteolysis of a hybrid protein produced in *Escherichia coli*. *Nature* **309**: 810–812.
- . 1987. Synthesis and sequence-specific proteolysis of hybrid proteins produced in *Escherichia coli*. *Methods Enzymol.* **153**: 461–481.
- Nambiar K.P., Stackhouse J., Presnell S.R., and Benner S.A. 1987. Expression of bovine pancreatic ribonuclease A in *Escherichia coli*. *Eur. J. Biochem.* **163**: 67–71.
- Neidhardt F.C., Bloch P.L., and Smith D.F. 1974. Culture medium for enterobacteria. *J. Bacteriol.* **119**: 736–747.
- Nilsson B. and Abrahmsén L. 1990. Fusion to staphylococcal protein A. *Methods Enzymol.* **185**: 144–161.
- Nilsson B., Abrahmsén L., and Uhlén M. 1985a. Immobilization and purification of enzymes with staphylococcal protein A fusion vectors. *EMBO J.* **4**: 1075–1080.
- Nilsson B., Holmgren E., Josephson S., Philipson I. and Uhlén M. 1985b. Efficient secretion and purification of human insulin-like growth factor I with a gene fusion vector in *Staphylococci*. *Nucleic Acids Res.* **13**: 1151–1162.
- Norlander J., Kempe T., and Messing J. 1983. Construction of improved M13 vectors using oligodeoxynucleotide-directed mutagenesis. *Gene* **26**: 101–106.
- Nossal N.G. and Heppel L.E. 1966. The release of enzymes by osmotic shock from *Escherichia coli* in exponential phase. *J. Biol. Chem.* **241**: 3055–3062.
- O'Hare M., Brown A.N., Hussain K., Gebhardt A., Watson G., Roberts L.M., Vitetta E.S., Thorpe P.E., and Lord J.M. 1990. Cytotoxicity of a recombinant ricin-A-chain fusion protein containing a proteolytically-cleavable spacer sequence. *FEBS Lett.* **273**: 200–204.
- Ohashi H., Katsuta-Enomoto Y., Yasufuku K., Okada K., and Yano M. 1991. Synthesis of human big endothelin-1 by sequence-specific proteolysis of a fusion protein in *Escherichia coli*. *J. Biochem.* **110**: 628–634.
- Oka T., Sakamoto S., Miyoshi K., Fuwa T., Yoda K., Yamasaki M., Tamura G., and Miyake T. 1985. Synthesis and secretion of human epidermal growth factor by *Escherichia coli*. *Proc. Natl. Acad. Sci.* **82**: 7212–7216.
- Ong E., Gilkes N.R., Warren R.A., Miller Jr., R.C., and Kilburn D.G. 1989a. Enzyme immobilization using the cellulose-binding domain of a *Cellulomonas fimi* exoglucanase. *Bio/Technology* **7**: 604–607.
- Ong E., Greenwood J.M., Gilkes N.R., Kilburn D.G., Miller Jr., R.C., and Warren R.A. 1989b. The cellulose-binding domains of cellulases: Tools for biotechnology. *Trends Biotechnol.* **7**: 239–243.
- Pan H., Clary D., and Sadowski P.D. 1991. Identification of the DNA binding domain of the FLP-recombinase. *J. Biol. Chem.* **266**: 11347–11354.
- Panayotatos N. and Truong K. 1981. Specific deletion of DNA sequences between preselected bases. *Nucleic Acids Res.* **9**: 5679–5688.
- Parks T.D., Leuther K.K., Howard E.D., Johnston S.A., and Dougherty W.G. 1994. Release of proteins and peptides from fusion proteins using a recombinant plant virus proteinase. *Anal. Biochem.* **216**: 413–417.
- Persson M., Bergstrand M.G., Bülow L., and Mosbach K. 1988. Enzyme purification by genetically attached polycysteine and polyphenylalanine affinity tails. *Anal. Biochem.* **172**: 330–337.
- Polayes D.A., Goldstein A., Ward G., and Hughes Jr., A.J. 1994. TEV protease, recombinant: A site-specific protease for efficient cleavage of affinity tags from expressed proteins. *Focus (Life Technologies)* **16**: 1–4.
- Prouty W.F. and Goldberg A.L. 1972. Fate of abnormal proteins in *E. coli* accumulation in intracellular granules before catabolism. *Nat. New Biol.* **240**: 147–150.
- Prouty W.F., Karnovsky M.J., and Goldberg A.L. 1975. Degradation of abnormal proteins in *Escherichia coli*. Formation of protein inclusions in cells exposed to amino acid analogs. *J. Biol. Chem.* **250**: 1112–1122.
- Puissant C. and Houdebine L.M. 1990. An improvement of the single-step method of RNA isolation by acid guanidinium thiocyanate-phenol-chloroform extraction. *BioTechniques* **8**: 148–149.
- Queen C. 1983. A vector that uses phage signals for efficient synthesis of proteins in *Escherichia coli*. *J. Mol. Appl. Genet.* **2**: 1–10.
- Rangwala S.H., Finn R.F., Smith C.E., Berberich S.A., Salsgiver W.J., Stallings W.C., Glover G.L., and Olins P.O. 1992. High-level production of active HIV-1 protease in *Escherichia coli*. *Gene* **122**: 263–269.
- Rao R.N. 1984. Construction and properties of plasmid pKC30, a pBR322 derivative containing the  $p_1$ -*N* region of phage lambda. *Gene* **31**: 247–250.
- Remaut E., Stanssens P., and Fiers W. 1981. Plasmid vectors for high-efficiency expression controlled by the  $P_1$  promoter of coliphage lambda. *Gene* **15**: 81–93.
- Ringquist S., Shinedling S., Barrick D., Green L., Binkley J., Stormo G.D., and Gold L. 1992. Translation initiation in *Escherichia coli*: Sequences within the ribosome-binding site. *Mol. Microbiol.* **6**: 1219–1229.
- Rosenberg A.H., Lade B.N., Chui D.S., Lin S.-W., Dunn J.J., and Studier F.W. 1987. Vectors for selective expression of cloned DNAs by T7 RNA polymerase. *Gene* **56**: 125–135.
- Rosenberg M., Ho Y.S., and Shatzman A. 1983. The use of pKc30 and its derivatives for controlled expression of genes. *Methods Enzymol.* **101**: 123–138.
- Rüther U. and Müller-Hill B. 1983. Easy identification of cDNA clones. *EMBO J.* **2**: 1791–1794.
- Sachdev D. and Chirgwin J.M. 1998. Solubility of proteins isolated from inclusion bodies is enhanced by fusion to maltose-binding protein or thioredoxin. *Protein Expr. Purif.* **12**: 122–132.
- Saito Y., Ishii Y., Niwa M., and Ueda I. 1987. Production and isolation of recombinant somatomedin C. *J. Biochem.* **101**: 1081–1288.
- Schatz P.J. and Beckwith J. 1990. Genetic analysis of protein export in *Escherichia coli*. *Annu. Rev. Genet.* **24**: 215–248.
- Schein C.H. 1989. Production of soluble recombinant proteins in bacteria. *Bio/Technology* **7**: 1141–1149.

- . 1991. Optimizing protein folding to the native state in bacteria. *Curr. Opin. Biotechnol.* **2**: 746–750.
- Schein C.H. and Noteborn M.H.M. 1988. Formation of soluble recombinant proteins in *Escherichia coli* is favored by lower growth temperature. *Bio/Technology* **6**: 291–294.
- Schoner R.G., Ellis L.F., and Schoner B.E. 1985. Isolation and purification of protein granules from *Escherichia coli* overproducing biosynthetic human insulin proteins. *Bio/Technology* **3**: 151–154.
- Schumacher G., Sizmman D., Haug H., Buckel P., and Bock A. 1986. Penicillin acylase from *E. coli*: Unique gene-protein relation. *Nucleic Acids Res.* **14**: 5713–5727.
- Shatzman A.R. and Rosenberg M. 1987. Expression, identification, and characterization of recombinant gene products in *Escherichia coli*. *Methods Enzymol.* **152**: 661–673.
- Shine J. and Dalgarno L. 1974. The 3'-terminal sequence of *Escherichia coli* 16S ribosomal RNA: Complementarity to nonsense triplets and ribosome binding sites. *Proc. Natl. Acad. Sci.* **71**: 1342–1346.
- Shine J., Fettes I., Lan N.C., Roberts J.L., and Baxter J.D. 1980. Expression of cloned  $\beta$ -endorphin gene sequences by *Escherichia coli*. *Nature* **285**: 456–463.
- Smith D.B. and Johnson K.S. 1988. Single-step purification of polypeptides expressed in *Escherichia coli* as fusions with glutathione S-transferase. *Gene* **67**: 31–40.
- Smith M.C., Furman T.C., Ingolia T.D., and Pidgeon C. 1988. Chelating peptide-immobilizing metal ion chromatography. A new concept in affinity chromatography for recombinant proteins. *J. Biol. Chem.* **263**: 7211–7215.
- Spector D.L., Goldman, R.D., and Leinwand L.A. 1998. Baculovirus expression: Generation of recombinant baculovirus DNA in *E. coli* using a baculovirus shuttle vector. In *Cells: A laboratory manual. Culture and biochemical analysis of cells*, vol. 1, pp. 66.1–66.28. Cold Spring Harbor Laboratory Press, Cold Spring Harbor, New York.
- Stanley K.K. and Luzio J.P. 1984. Construction of a new family of high efficiency bacterial expression vectors: Identification of cDNA clones coding for human liver proteins. *EMBO J.* **3**: 1429–1434.
- Steers Jr., E., Cuatrecasas P., and Pollard H.B. 1971. The purification of  $\beta$ -galactosidase from *Escherichia coli* by affinity chromatography. *J. Biol. Chem.* **246**: 196–200.
- Steitz J.A. 1979. Genetic signals and nucleotide sequences in messenger RNA. In *Biological regulation and development: Gene expression* (ed. R.F. Goldberg), vol. 1, pp. 349–399. Plenum Press, New York.
- Steitz J.A. and Jakes K. 1975. How ribosomes select initiator regions in mRNA: Base pair formation between the 3' terminus of 16S rRNA and the mRNA during initiation of protein synthesis in *Escherichia coli*. *Proc. Natl. Acad. Sci.* **72**: 4734–4738.
- St. John R.J., Carpenter J.F., and Randolph T.W. 1999. High pressure fosters protein refolding from aggregates at high concentrations. *Proc. Natl. Acad. Sci.* **96**: 13029–13033.
- Studier F.W. and Moffatt B.A. 1986. Use of bacteriophage T7 RNA polymerase to direct selective high-level expression of cloned genes. *J. Mol. Biol.* **189**: 113–130.
- Studier F.W., Rosenberg A.H., Dunn J.J., and Dubendorff J.W. 1990. Use of T7 RNA polymerase to direct expression of cloned genes. *Methods Enzymol.* **185**: 60–89.
- Su X., Prestwood A.K., and McGraw R.A. 1992. Production of recombinant porcine tumor necrosis factor  $\alpha$  in a novel *E. coli* expression system. *Bio/Techniques* **13**: 756–762.
- Szoka P.R., Schreiber A.B., Chan H., and Murthy J. 1986. A general method for retrieving the components of a genetically-engineered fusion protein. *DNA* **5**: 11–20.
- Tabor S. and Richardson C.C. 1985. A bacteriophage T7 RNA polymerase/promoter system for controlled exclusive expression of specific genes. *Proc. Natl. Acad. Sci.* **82**: 1074–1078.
- Talmadge K., Kaufman J., and Gilbert W. 1980. Bacteria mature preproinsulin to proinsulin. *Proc. Natl. Acad. Sci.* **77**: 3988–3992.
- Tanford C. 1968. Protein denaturation. *Adv. Protein Chem.* **23**: 121–282.
- Uhlén M. and Moks T. 1990. Gene fusions for purposes of expression: An introduction. *Methods Enzymol.* **185**: 129–143.
- Ullmann A. 1984. One-step purification of hybrid proteins which have  $\beta$ -galactosidase activity. *Gene* **29**: 27–31.
- Van Heeke G., Shaw R., Schnizer R., Couton J.M., Schuster S.M., and Wagner F.W. 1993. Gene fusions with human carbonic anhydrase II for efficient expression and rapid single-step recovery of recombinant proteins: Expression of the *Escherichia coli* F<sub>1</sub>-ATPase  $\epsilon$  subunit. *Protein Expr. Purif.* **4**: 265–274.
- Van Reeth T., Dreze P.L., Szpirer J., Szpirer C., and Gabant P. 1998. Positive selection vectors to generate fused genes for the expression of his-tagged proteins. *Bio/Techniques* **25**: 898–904.
- Villa S., De Fazio G., Donini S., Tarchi G., and Canosi U. 1988. Expression in *Escherichia coli* and characterization of human-growth-hormone releasing factor. *Eur. J. Biochem.* **171**: 137–141.
- Vinson C.R., LaMarco K.L., Johnson P.F., Landschulz W.H., and McKnight S.L. 1988. In situ detection of sequence-specific DNA binding activity specified by a recombinant bacteriophage. *Genes Dev.* **2**: 801–806.
- Wang M., Scott W.A., Rao K.R., Udey J., Conner G.E., and Brew K. 1989. Recombinant bovine  $\alpha$ -lactalbumin obtained by limited proteolysis of a fusion protein expressed at high levels in *Escherichia coli*. *J. Biol. Chem.* **264**: 21116–21121.
- Wanner B.L. 1987. Phosphate regulation of gene expression in *Escherichia coli*. In *Escherichia coli and Salmonella typhimurium: Cellular and molecular biology* (ed. F.C. Neidhardt et al.), vol. 2, pp. 1326–1333. American Society for Microbiology, Washington, D.C.
- Weickert M.J., Doherty D.H., Best E.A., and Olins P.O. 1996. Optimization of heterologous protein production in *Escherichia coli*. *Curr. Opin. Biotechnol.* **7**: 494–499.
- Weikert C., Sauer U., and Bailey J.E. 1998. An *Escherichia coli* host strain useful for efficient overproduction of secreted recombinant protein. *Biotechnol. Bioeng.* **59**: 386–391.
- Wetzel R., Perry L.J., and Veilleux C. 1991. Mutations in human interferon gamma affecting inclusion body formation identified by a general immunochemical screen. *Bio/Technology* **9**: 731–737.
- Williams D.C., Van Frank R.M., Muth W.L., and Burnett J.P. 1982. Cytoplasmic inclusion bodies in *Escherichia coli* cells overproducing bovine growth hormone. *Science* **215**: 687–689.
- Wulfing C. and Pluckthun A. 1994. Protein folding in the periplasm of *Escherichia coli*. *Mol. Microbiol.* **12**: 685–692.
- Yanisch-Perron C., Vieira J., and Messing J. 1985. Improved M13 phage cloning vectors and host strains: Nucleotide sequences of the M13mp18 and pUC19 vectors. *Gene* **33**: 103–119.
- Young R.A. and Davis R.W. 1983. Efficient isolation of genes by using antibody probes. *Proc. Natl. Acad. Sci.* **80**: 1194–1198.
- Yuan L., Craig S.P., McKerrow J.H., and Wang C.C. 1990. The hypoxanthine-guanine phosphoribosyltransferase of *Schistosoma mansoni*: Further characterization and gene expression in *Escherichia coli*. *J. Biol. Chem.* **265**: 13528–13532.



# Chapter 16

---

## Introducing Cloned Genes into Cultured Mammalian Cells

### INTRODUCTION

### PROTOCOLS

- |   |   |       |
|---|---|-------|
| 1 | DNA Transfection Mediated by Lipofection  | 16.7  |
|   | • Additional Protocol: Histochemical Staining of Cell Monolayers for $\beta$ -Galactosidase                           | 16.13 |
| 2 | Calcium-phosphate-mediated Transfection of Eukaryotic Cells with Plasmid DNAs   | 16.14 |
|   | • Alternative Protocol: High-efficiency Calcium-phosphate-mediated Transfection of Eukaryotic Cells with Plasmid DNAs | 16.19 |
| 3 | Calcium-phosphate-mediated Transfection of Cells with High-molecular-weight Genomic DNA                               | 16.21 |
|   | • Alternative Protocol: Calcium-phosphate-mediated Transfection of Adherent Cells                                     | 16.25 |
|   | • Alternative Protocol: Calcium-phosphate-mediated Transfection of Cells Growing in Suspension                        | 16.26 |
| 4 | Transfection Mediated by DEAE-Dextran: High-efficiency Method   | 16.27 |
|   | • Alternative Protocol: Transfection Mediated by DEAE-Dextran: Increased Cell Viability                               | 16.32 |
| 5 | DNA Transfection by Electroporation   | 16.33 |
| 6 | DNA Transfection by Biolistics  | 16.37 |
|   | • Additional Protocol: Histochemical Staining of Cell Monolayers or Tissue for $\beta$ -Glucuronidase                 | 16.42 |
| 7 | DNA Transfection Using Polybrene  | 16.43 |

### INFORMATION PANELS

- |   |       |
|---|-------|
| Cotransformation  | 16.47 |
| Selective Agents for Stable Transformation                                | 16.48 |
| Lipofection   | 16.50 |
| Transfection of Mammalian Cells with Calcium Phosphate–DNA Coprecipitates | 16.52 |
| Chloroquine Diphosphate   | 16.53 |
| Electroporation   | 16.54 |

A VARIETY OF STRATEGIES ARE AVAILABLE FOR THE DELIVERY of genes into eukaryotic cells. These techniques fall into three categories: transfection by biochemical methods, transfection by physical methods, and virus-mediated transduction. This chapter deals with the first two categories; the third approach is covered extensively in Section 8 of *Cells: A Laboratory Manual* (Spector et al. 1998b). The choice of a particular transfection method is determined by the experimental goal (e.g., the type of assay to be used for screening, the ability of the cell line to survive the stress of transfection, and the efficiency required of the system).

Biochemical methods of transfection, including calcium-phosphate-mediated and diethylaminoethyl (DEAE)-dextran-mediated transfection, have been used for nearly 30 years to deliver nucleic acids into cultured cells. The work of Graham and van der Eb (1973) on transformation of mammalian cells by viral DNAs in the presence of calcium phosphate laid the foundation for the biochemical transformation of genetically marked mouse cells by cloned DNAs (Maitland and McDougall 1977; Wigler et al. 1977), for the transient expression of cloned genes in a variety of mammalian cells (e.g., please see Gorman et al. 1983b), and for the isolation and identification of cellular oncogenes, tumor-suppressing genes, and other single-copy mammalian genes (e.g., please see Wigler et al. 1978; Perucho and Wigler 1981; Weinberg 1985; Friend et al. 1988). More recently, a collection of cationic lipid (liposome) reagents has been used successfully for gene delivery into a wider range of cell types. In all three of these chemical methods (calcium phosphate, DEAE-dextran, and cationic lipids), the chemical agent forms a complex with the DNA that facilitates its uptake into cells.

Two physical methods of transfection are in common use: Biolistic particle delivery and direct microinjection work by perforation of the cell membrane and subsequent delivery of the DNA into the cell; electroporation uses brief electrical pulses to create transient pores in the plasmid membrane through which nucleic acids enter.

## TRANSIENT VS. STABLE TRANSFECTION

---

Two different approaches are used to transfer DNA into eukaryotic cells: transient transfection and stable transfection. In transient transfection, recombinant DNA is introduced into a recipient cell line in order to obtain a temporary but high level of expression of the target gene. The transfected DNA does not necessarily become integrated into the host chromosome. Transient transfection is the method of choice when a large number of samples are to be analyzed within a short period of time. Typically, the cells are harvested between 1 and 4 days after transfection, and the resulting lysates are assayed for expression of the target gene.

Stable or permanent transfection is used to establish clonal cell lines in which the transfected target gene is integrated into chromosomal DNA, from where it directs the synthesis of moderate amounts of the target protein. In general (depending on the cell types), the formation of stably transfected cells occurs with an efficiency that is one to two orders of magnitude lower than the efficiency of transient transfection. Isolation of the rare stable transformant from a background of nontransfected cells is facilitated by the use of a selectable genetic marker. The marker may be present on the recombinant plasmid carrying the target gene, or it may be carried on a separate vector and introduced with the recombinant plasmid into the desired cell line by cotransfection (for further details, please see the information panels on **COTRANSFORMATION** and **SELECTIVE AGENTS FOR STABLE TRANSFORMATION**). In general, all of the methods described below are suitable for use in transient transfection assays, and all, with the exception of DEAE-dextran, may be used for stable transfection.

## TRANSFECTION METHODS

Until recently, cloned DNA has been introduced into cultured eukaryotic cells chiefly by biochemical methods. During the past 10 years, the range of cell types that can be transfected efficiently has been extended with the development of liposome methods, which work well with suspension cultures, and with the use of physical methods such as electroporation and biolistic particle delivery, which may be used successfully with many cell lines that are resistant to transfection by other means. A brief summary of transfection methods is given in Table 16-1.

TABLE 16-1 Transfection Methods

METHOD	EXPRESSION		CELL TOXICITY	CELL TYPES	COMMENTS
	TRANSIENT	STABLE			
Lipid-mediated Protocol 1	yes	yes	varies	adherent cells, primary cell lines, suspension cultures	Cationic lipids are used to create artificial membrane vesicles (liposomes) that bind DNA molecules. The resulting stable cationic complexes adhere to and fuse with the negatively charged cell membrane (Felgner et al. 1987; Felgner et al. 1994).
Calcium-phosphate-mediated Protocols 2 and 3	yes	yes	no	adherent cells (CHO, 293); suspension cultures	Calcium phosphate forms an insoluble coprecipitate with DNA, which attaches to the cell surface and is absorbed by endocytosis (Graham and van der Eb 1973).
DEAE-dextran-mediated Protocol 4	yes	no	yes	BSC-1, CV-1, and COS	Positively charged DEAE-dextran binds to negatively charged phosphate groups of DNA, forming aggregates that bind to the negatively charged plasma membrane. Uptake into the cell is believed to be mediated by endocytosis, which is potentiated by osmotic shock (Vaheri and Pagano 1965).
Electroporation Protocol 5	yes	yes	no	many	Application of brief high-voltage electric pulses to a variety of mammalian and plant cells leads to the formation of nanometer-sized pores in the plasma membrane (Neumann et al. 1982; Zimmermann 1982). DNA is taken directly into the cell cytoplasm either through these pores or as a consequence of the redistribution of membrane components that accompanies the closure of the pores. Electroporation can be extremely efficient and may be used for both transient and stable transfection.
Biolistics Protocol 6	yes	yes	no	primary cell lines; tissues, organs, plant cells	Small particles of tungsten or gold are used to bind DNA, in preparation for delivery into cells, tissues, or organelles by a particle accelerator system (Sanford et al. 1993). This process has been variously called the microprojectile bombardment method, the gene gun method, and the particle acceleration method. Biolistics is used chiefly to transform cell types that are impossible or very difficult to transform by other methods.
Polybrene Protocol 7	yes	yes	varies	CHO and keratinocyte	The polycation Polybrene allows the efficient and stable introduction of low-molecular-weight DNAs (e.g., plasmid DNAs) into cell lines that are relatively resistant to transfection by other methods (Kawai and Nishizawa 1984; Chaney et al. 1986; Kawai and Nishizawa 1984; Chaney et al. 1986; Kawai and Nishizawa 1984; Chaney et al. 1986; Kawai and Nishizawa 1984; Chaney et al. 1986). The uptake of DNA is enhanced by osmotic shock and dimethylsulfoxide (DMSO), which may permeabilize the cell membrane.

## TRANSFECTION CONTROLS

---

All transfection experiments should include controls to test individual reagents and plasmid DNA preparations, and to test for toxicity of the gene or construct being introduced.

### Controls for Transient Expression

#### *Negative Controls*

In transient transfection experiments, one or two dishes of cells should be transfected with the carrier DNA and/or buffer used to dilute the test plasmid or gene. Typically, salmon sperm DNA or another inert carrier such as the vector used to construct the recombinant is transfected into adherent cells in the absence of the test gene. After transfection, the cultured cells should not detach from the dish nor become rounded and glassy in appearance.

#### *Positive Controls*

One or two dishes of cells are transfected with a plasmid encoding a readily assayed gene product such as chloramphenicol acetyl transferase, luciferase, *Escherichia coli*  $\beta$ -galactosidase, or green fluorescent protein, whose expression is driven by a pan-specific promoter such as the human cytomegalovirus immediate early gene region promoter and enhancer. Tracer plasmids of this kind are available from many different commercial suppliers who sell kits containing the enzymes and reagents needed for detection of the encoded protein. Because the endogenous levels of these reporter activities are typically low, the increase in enzyme activity provides a direct indication of the efficiency of the transfection and the quality of the reagents used for a particular experiment. This control is especially important when comparing results of transfection experiments carried out at different times. Cotransfecting the reporter plasmid with the test plasmid or genomic DNA also provides a control for nonspecific toxicity in the overall transfection process.

### Controls for Stable Expression

#### *Negative Controls*

One or two dishes should be transfected with an inert nucleic acid such as salmon sperm DNA, in the absence of the selectable marker. After culturing for 2–3 weeks in the presence of the selected agent (G418, hygromycin, mycophenolic acid), no colonies should be visible.

#### *Positive Controls*

One or two dishes of cells should be transfected with the plasmid encoding the selectable marker in the absence of any other DNA. The number of viable colonies present at the end of the 2–3-week selection period is a measure of the efficiency of the transfection/selection process. A similar number of colonies should be present on dishes into which both the selectable marker and the test plasmid or gene were introduced. A marked discrepancy in the number of colonies on these two sets of dishes can be an indication of a toxic gene product (or in rare instances of a gene product that enhances survival of the transfected cells). If a particular cDNA or gene proves toxic to

recipient cells, consider the use of a regulated promoter such as metallothionein (a  $Zn^{2+}$ - or  $Cd^{2+}$ -responsive DNA), the mouse mammary tumor virus long terminal repeat promoter (a glucocorticoid-responsive DNA), a tetracycline-regulated promoter (Gossen and Bujard 1992; Gossen et al. 1995; Shockett et al. 1995), or an ecdysone-regulated system (No et al. 1996). Alternatively, conditional alleles of some genes can be constructed (Picard et al. 1988).

## OPTIMIZATION AND SPECIAL CONSIDERATIONS

Irrespective of the method used to introduce DNA into cells, the efficiency of transient or stable transfection is determined largely by the cell type that is used (please see Table 16-1). Different lines of cultured cells vary by several orders of magnitude in their ability to take up and express exogenously added DNA. Furthermore, a method that works well for one type of cultured cell

**TABLE 16-2 Commercial Kits and Reagents for Transfection**

MANUFACTURER	WEBSITE ADDRESS	KIT/PRODUCT	METHOD OR REAGENTS
Amersham-Pharmacia Biotech	www.apbiotech.com	CellPect Transfection Kit	$CaPO_4$ or DEAE-Dextran
Bio-Rad	www.biorad.com	CytoFectene Reagent	Cationic lipid
CLONTECH	www.clontech.com	CLONfectin Reagent CalPhos Mammalian Kit	Cationic lipid $CaPO_4$
5 Prime→3 Prime	www.5prime.com	Calcium Phosphate Transfection Kit	$CaPO_4$ DEAE-Dextran
Invitrogen	www.invitrogen.com	Perfect Lipid	Cationic lipid
Life Technologies	www.lifetech.com	Lipofectamine, Lipofectin, LipofectAce, Cellfectin Calcium Phosphate Transfection System	Cationic lipid (proprietary) $CaPO_4$
MBI Fermentas	www.fermentas.com	ExGen 500	Cationic polymer
Novagen	www.novagen.com		
Promega	www.promega.com	Transfast Transfection Tfx Reagents Transfectam ProFectin	Cationic lipid Cationic lipid Cationic lipid $CaPO_4$ or DEAE-Dextran
QIAGEN	www.qiagen.com	SuperFect Effectene  Transfection Reagent Selector Kit	Activated dendrimer Nonliposomal lipid and DNA condensing agent Enhancer Both reagents
Quantum Biotechnologies	www.quantumbiotech.com	GeneSHUTTLE 20 and 40	Cationic lipid
Sigma Aldrich	www.sigma-aldrich.com	DEAE Dextran Kit Calcium Phosphate Transfection Escort, DOTAP, DOPE	DEAE-Dextran $CaPO_4$ Cationic lipid kits
Stratagene	www.stratagene.com	LipoTaxi MBS Mammalian Transfection Kit Mammalian Transfection Kit Primary ENHANCER Reagent	Liposome-mediated Modified $CaPO_4$  $CaPO_4$ and/or DEAE-Dextran Supplemented with lipid, $CaPO_4$
Wako Chemicals USA	www.wakousa.com	GeneTransfer HMG-1, -2 Mixture	Liposome-mediated



may be useless for another. Many of the protocols described in this chapter have been optimized for the standard lines of cultured cells. When using more exotic lines of cells, it is important to compare the efficiencies of several different methods. The protocols in this chapter present commonly used transfection techniques as well as methods that have proven successful with cell lines that are resistant to transfection by standard techniques. Commercial kits are available that provide collections of reagents for many types of transfections (please see Table 16-2).

Many techniques used in eukaryotic cell culture are not discussed in detail in this manual (for specific information on cell culture, please see Volume 1 of *Cells: A Laboratory Manual* [Spector et al. 1998a]). In particular, it is assumed that the conditions for optimal growth and passage of the cell lines to be used in this protocol have already been established.

*The students study molecules now, spinning models across their computer screens and splicing the genes of one creature into those of another. The science of genetics is utterly changed... . Sometimes I wonder where we have misplaced our lives.*

Andrea Barrett  
"The Behavior of the Hawkweeds."

# Protocol 1

---

## DNA Transfection Mediated by Lipofection

**B**ECAUSE A LARGE NUMBER OF VARIABLES AFFECT THE EFFICIENCY of lipofection, we suggest that the conditions outlined in the following protocol be used as a starting point for systematic optimization of the system (for further details, please see the information panel on **LIPOFECTION** at the end of this chapter). Alternatively, a protocol recommended by a commercial manufacturer of a particular lipofectant can be used to begin the optimization process. Once a positive signal has been obtained with a plasmid carrying a standard reporter gene, each of the parameters discussed in the information panel on **LIPOFECTION** may be changed systematically to obtain the maximal ratio of signal to background and to minimize variability between replicate assays. From these results, optimal protocols can be developed to assay the expression of the genes of interest.

To explore the suitability of a wide variety of lipids for the task at hand, we recommend purchasing an optimization kit containing a series of individual lipids or combinations of lipids. Examples of such kits include the Tfx Reagents Transfection Trio (Promega), PerFect Lipid Transfection Kit (Invitrogen), and the Transfection Reagent Optimization System (Life Technologies).

The following protocol is a modification of a method provided by Mark Evans (Alexion Pharmaceuticals, New Haven, Connecticut).

---

### MATERIALS

#### Buffers and Solutions

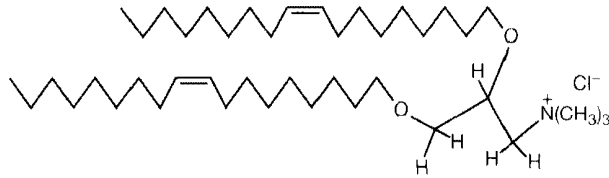
**Please see Appendix 1 for components of stock solutions, buffers, and reagents. Dilute stock solutions to the appropriate concentrations.**

##### *Lipofection reagent*

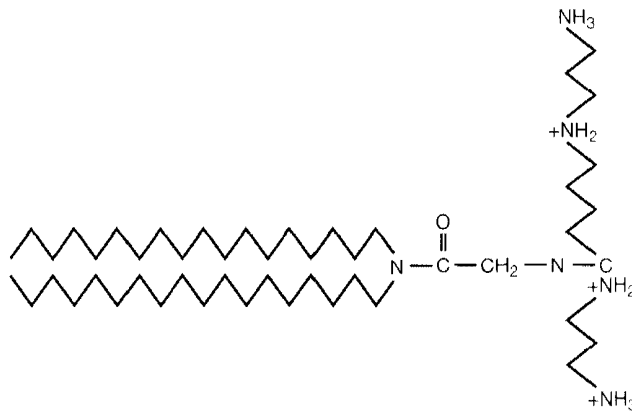
As illustrated in Table 16-4 and described in the information panel on **LIPOFECTION**, several types of lipofection reagents are available. This protocol describes the use of two common lipids:

- Lipofectin (*N*-[1-(2,3-dioleoyloxy)propyl]-*N,N,N*-trimethylammonium chloride [DOTMA]) (Figure 16-1). This monocationic lipid mixed with a helper lipid is usually purchased at a concentration of 1 mg/ml. DOTMA can also be synthesized with the help of an organic chemist (Felgner et al. 1987). If purchased in-house, dissolve 10 mg each of dried DOTMA and the helper lipid dioleoyl phosphatidylethanolamine (DOPE, purchased from Sigma) in 2 ml of sterile deionized H<sub>2</sub>O in a polystyrene tube (do not use polypropylene tubes). Sonicate the turbid solution to form liposomes before diluting to a final concentration of 1 mg/ml. Store the solution at 4°C.

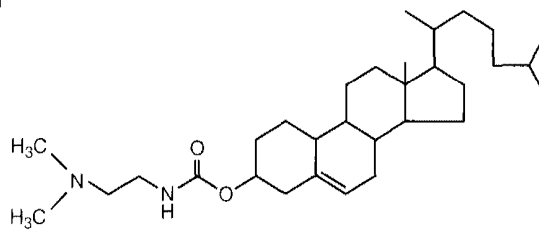
A. DOTMA



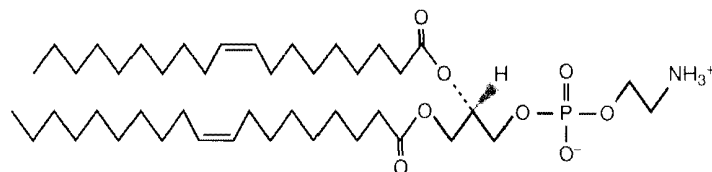
B. DOGS



C. DC-cholesterol



D. DOPE



**FIGURE 16-1 Structures of Lipids Used in Lipofection**

For further descriptions of each of these lipids, please see Table 16-4.

TABLE 16-3 Dimensions of Dishes Used for Cell Culture

SIZE OF PLATE	GROWTH AREA (cm <sup>2</sup> )	RELATIVE AREA <sup>a</sup>	RECOMMENDED VOLUME
96-well	0.32	0.04x	200 $\mu$ l
24-well	1.88	0.25x	500 $\mu$ l
12-well	3.83	0.5x	1.0 ml
6-well	9.4	1.2x	2.0 ml
35-mm	8.0	1.0x	2.0 ml
60-mm	21	2.6x	5.0 ml
10-cm	55	7x	10.0 ml
Flasks	25	3x	5.0 ml
	75	9x	12.0 ml

<sup>a</sup>Relative area is expressed as a factor of the growth area of a 35-mm culture plate.

- Transfectam (Spermine-5-carboxy-glycinedioctadecyl-amide [DOGS]) (Figure 16-1). Polycationic lipids such as DOGS may be substituted for Lipofectin in the protocol. DOGS can be purchased and reconstituted as directed (Promega) or the lipid may be synthesized in-house to save money (Loeffler and Behr 1993). If synthesized in the laboratory, prepare a stock solution as follows: Dissolve 1 mg of polyamine in 40  $\mu$ l of 96% (v/v) ethanol for 5 minutes at room temperature with frequent vortexing. Add 360  $\mu$ l of sterile H<sub>2</sub>O and store the solution at 4°C. Vortex the solution just before use. Polyamines, such as DOGS, do not require the use of polystyrene tubes; polypropylene tubes (i.e., standard microfuge tubes) can be safely used with these reagents. Polystyrene tubes must be used with DOTMA, because the lipid can bind nonspecifically to polypropylene.

#### NaCl (5 M) (optional)

Use as the diluent for DOGS.

#### Sodium citrate (pH 5.5, 20 mM) containing 150 mM NaCl (optional)

Use instead of sterile H<sub>2</sub>O as the diluent for the plasmid DNA if DOGS is the lipofection reagent (Kichler et al. 1998).

## Nucleic Acids and Oligonucleotides

### Plasmid DNA

If carrying out lipofection for the first time or if using an unfamiliar cell line, obtain an expression plasmid encoding *E. coli*  $\beta$ -galactosidase or green fluorescent protein (please see the information panel on **GREEN FLUORESCENT PROTEIN** in Chapter 17). These can be purchased from several commercial manufacturers (e.g., pCMV-SPORT- $\beta$ -gal, Life Technologies, or pEGFP-F, CLONTECH; please see Figures 16-2 and 16-3).

Purify closed circular plasmid DNAs by column chromatography or ethidium bromide-CsCl gradient centrifugation as described in Chapter 1. Dissolve the DNAs in H<sub>2</sub>O at 1  $\mu$ g/ $\mu$ l.

## Media

*Cell culture growth medium (complete, serum-free, and [optional] selective)*

## Special Equipment

### Test tubes, polystyrene or polypropylene

Polystyrene tubes must be used with DOTMA, because the lipid can bind nonspecifically to polypropylene.

### Tissue culture dishes (60 mm)

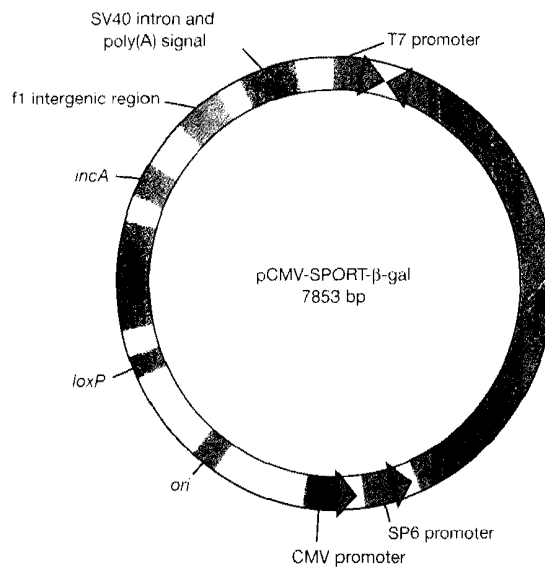
This protocol is designed for cells grown in 60-mm culture dishes. If multiwell plates, flasks, or dishes of a different diameter are used, scale the cell density and reagent volumes accordingly. Please see Table 16-3.

## Additional Reagents

*Step 9 of this protocol may require the reagents listed in Chapter 17, Protocol 7.*

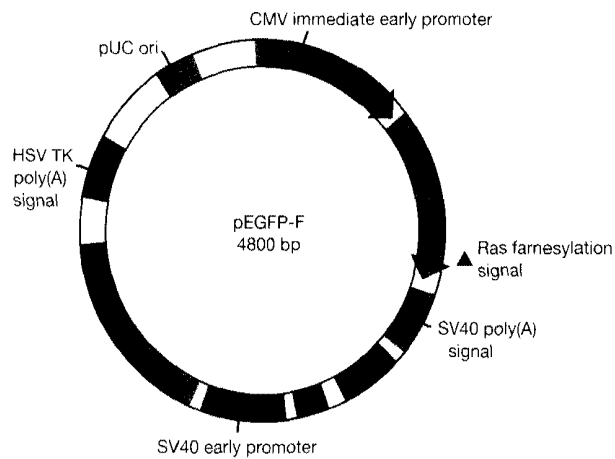
## Cells and Tissues

*Exponentially growing cultures of mammalian cells*



**FIGURE 16-2** pCMV-SPORT-β-gal

pCMV-SPORT-β-gal is a reporter vector that may be used to monitor transfection efficiency. It carries the *E. coli* gene encoding β-galactosidase preceded by the CMV (cytomegalovirus) promoter that drives high levels of transcription in mammalian cells. The SV40 polyadenylation signal downstream from the β-galactosidase sequence directs proper processing of the mRNA in eukaryotic cells. (Reproduced, with permission, from Life Technologies, Inc.)



**FIGURE 16-3** pEGFP-F

pEGFP-F is a reporter vector that may be used both to monitor transfection efficiency and as a cotransfection marker. The vector encodes a modified form of the green fluorescent protein, a farnesylated enhanced GFP (EGFP-F) that remains bound to the plasma membrane in both living and in fixed cells. The EGFP-F-coding sequence is preceded by the CMV (cytomegalovirus) promoter that drives high levels of transcription and is followed by the SV40 polyadenylation signal to direct proper processing of the mRNA in eukaryotic cells. The plasmid carries sequences that allow replication in prokaryotic (pUC ori) as well as eukaryotic (SV40 ori) cells and markers that facilitate selection for the plasmid in prokaryotic (kanamycin) cells as well as eukaryotic (neomycin) cells. The presence of EGFP-F can be detected by fluorescence microscopy. (Adapted, with permission, from CLONTECH.)

TABLE 16-4 Some Lipids Used in Lipofection

ABBREVIATION	IUPAC NAME	TYPE	PRODUCT NAME	CELL LINES COMMONLY USED FOR TRANSFECTION
DOTMA	<i>N</i> -[1-(2,3-dioleoyloxy)propyl]- <i>N,N,N</i> -trimethylammonium chloride	monocationic	Lipofectin	AS52 H187 mouse L cells NIH-3T3 HeLa
DOTAP	<i>N</i> -[1-(2,3-dioleoyloxy)propyl]- <i>N,N,N</i> -trimethylammonium methyl sulfate	monocationic	DOTAP	HeLa
DMRIE	1,2-dimyristyloxypropyl-3-dimethyl-hydroxyethylammonium bromide	monocationic	DMRIE-C	Jurkat CHO-K1 COS-7 BHK-21
DDAB	dimethyl dioctadecylammonium bromide	monocationic	LipofectACE	COS-7 CHO-K1 BHK-21 mouse L cells
Amidine	<i>N-t</i> -butyl- <i>N'</i> -tetradecyl-3-tetradecyl-aminopropionamide	monocationic	CLONfectin	A-431 HEK293 BHK-21 HeLa L6 CV-1
DC-Cholesterol	3β[ <i>N</i> -( <i>N,N'</i> -dimethylaminoethane) carbamoyl]-cholesterol	monocationic	DC-Cholesterol	
DOSPER	1,3-dioleoyloxy-2-(6-carboxyspermyl)propylamide	dicationic	Tfx	CHO HeLa NIH-3T3
DOGS	spermine-5-carboxy-glycine dioctadecyl-amide	polycationic	Transfectam	293 HeLa HepG2 HC11 NIH-3T3
DOSPA	2,3-dioleoyloxy- <i>N</i> -[2(sperminocarbox-amido)ethyl]- <i>N,N</i> -dimethyl-1-propan-aminium trifluoroacetate	polycationic	LipofectAMINE	HT-29 BHK-21 keratinocytes MDCK NIH-3T3
TM-TPS	<i>N,N',N'',N'''</i> -tetramethyl- <i>N,N',N'',N'''</i> -tetrapalmitylspermine	polycationic	CellFECTIN	CHO-K1 COS-7 BHK-21 Jurkat

## METHOD

---

1. Twenty-four hours before lipofection, harvest exponentially growing mammalian cells by trypsinization and replat them on 60-mm tissue culture dishes at a density of  $10^5$  cells/dish (or at  $5 \times 10^4$  cells/35-mm dish). Add 5 ml (or 3 ml for 35-mm dish) of growth medium, and incubate the cultures for 20–24 hours at 37°C in a humidified incubator with an atmosphere of 5–7% CO<sub>2</sub>.

The cells should be ~75% confluent at the time of lipofection. If the cells are grown for fewer than 12 hours before transfection, they will not be well anchored to the substratum and are likely to detach during exposure to lipid.

2. For each 60-mm dish of cultured cells to be transfected, dilute 1–10 µg of plasmid DNA into 100 µl of sterile deionized H<sub>2</sub>O (if using Lipofectin) or 20 mM sodium citrate containing 150 mM NaCl (pH 5.5) (if using Transfectam) in a polystyrene or polypropylene test tube. In a separate tube, dilute 2–50 µl of the lipid solution to a final volume of 100 µl with sterile deionized H<sub>2</sub>O or 300 mM NaCl.

▲ **IMPORTANT** When transfecting with Lipofectin, use polystyrene test tubes; do not use polypropylene tubes, because the cationic lipid DOTMA can bind nonspecifically to polypropylene. For other cationic lipids, use the tubes recommended by the manufacturer.

3. Incubate the tubes for 10 minutes at room temperature.
4. Add the lipid solution to the DNA, and mix the solution by pipetting up and down several times. Incubate the mixture for 10 minutes at room temperature.
5. While the DNA-lipid solution is incubating, wash the cells to be transfected three times with serum-free medium. After the third rinse, add 0.5 ml of serum-free medium to each 60-mm dish and return the washed cells to a 37°C humidified incubator with an atmosphere of 5–7% CO<sub>2</sub>.

It is very important to rinse the cells free of serum before the addition of the lipid-DNA liposomes. In some cases, serum is a very effective inhibitor of the transfection process (Felgner and Holm 1989). Similarly, extracellular matrix components such as sulfated proteoglycans can also inhibit lipofection, presumably by binding the DNA-lipid complexes and preventing their interaction with the plasma membranes of the recipient cells.

6. After the DNA-lipid solution has incubated for 10 minutes, add 900 µl of serum-free medium to each tube. Mix the solution by pipetting up and down several times. Incubate the tubes for 10 minutes at room temperature.
7. Transfer each tube of DNA-lipid-medium solution to a 60-mm dish of cells. Incubate the cells for 1–24 hours at 37°C in a humidified incubator with an atmosphere of 5–7% CO<sub>2</sub>.
8. After the cells have been exposed to the DNA for the appropriate time, wash them three times with serum-free medium. Feed the cells with complete medium and return them to the incubator.
9. If the objective is stable transformation of the cells, proceed to Step 10. Examine the cells 24–96 hours after lipofection using one of the following assays.
  - If a plasmid DNA expressing *E. coli* β-galactosidase was used, follow the steps outlined in Chapter 17, Protocol 7 to measure enzyme activity in cell lysates. Alternatively, carry out a histochemical staining assay as detailed in the panel on **ADDITIONAL PROTOCOL: HISTOCHEMICAL STAINING OF CELL MONOLAYERS FOR β-GALACTOSIDASE**.
  - If a green fluorescence protein expression vector was used, examine the cells with a microscope under 450–490-nm illumination.

- For other gene products, newly synthesized protein may be analyzed by radioimmunoassay, by immunoblotting, by immunoprecipitation following *in vivo* metabolic labeling, or by assays of enzymatic activity in cell extracts.

To minimize dish-to-dish variation in transfection efficiency, it is best to (i) transfect several dishes with each construct, (ii) trypsinize the cells after 24 hours of incubation, (iii) pool the cells, and (iv) replat them on several dishes.

10. To isolate stable transfectants: After the cells have incubated for 48–72 hours in complete medium, trypsinize the cells and replat them in the appropriate selective medium. Change this medium every 2–4 days for 2–3 weeks to remove the debris of dead cells and to allow colonies of resistant cells to grow. Thereafter, individual colonies may be cloned and propagated for assay (for methods, please see Jakoby and Pastan 1979 or Spector et al. 1998b [Chapter 86 in *Cells: A Laboratory Manual*]).

A permanent record of the numbers of colonies may be obtained by fixing the remaining cells with ice-cold methanol for 15 minutes followed by staining with 10% Giemsa for 15 minutes at room temperature before rinsing in tap water. The Giemsa stain should be freshly prepared in phosphate-buffered saline or H<sub>2</sub>O and filtered through Whatman No. 1 filter paper before use.

#### ADDITIONAL PROTOCOL: HISTOCHEMICAL STAINING OF CELL MONOLAYERS FOR $\beta$ -GALACTOSIDASE

This method, designed for cells growing in 60-mm culture dishes, was adapted from Sanes et al. (1986). Kits that contain all of the necessary reagents for immunohistochemical detection of  $\beta$ -galactosidase are available from several manufacturers.

**CAUTION:** Please see Appendix 12 for appropriate handling of materials marked with <!>.

#### Additional Materials

##### Cell fixative

- 2% (v/v) formaldehyde <!>
- 0.2% (v/v) glutaraldehyde <!>
- 1x phosphate-buffered saline

▲ **WARNING** Prepare the cell fixative solution in a chemical fume hood and store at room temperature.

##### Histochemical stain

- 5 mM potassium ferricyanide (K<sub>3</sub>Fe(CN)<sub>6</sub>) <!>
- 5 mM potassium ferrocyanide (K<sub>4</sub>Fe(CN)<sub>6</sub>) <!>
- 2 mM MgCl<sub>2</sub>
- 1x phosphate-buffered saline
- 1 mg/ml X-gal (5-bromo-4-chloro-3-indolyl- $\beta$ -galactoside) <!>

Store the staining solution in the dark at 4°C.

▲ **IMPORTANT** Add the X-gal immediately before applying the stain to the cell monolayer.

##### Phosphate-buffered saline

#### Method

1. Wash the transfected cells twice with 2–3 ml of phosphate-buffered saline at room temperature.
2. Add 5 ml of cell fixative to the cells.
3. Wash the cells once with phosphate-buffered saline.
4. Add 3–5 ml of histochemical stain to the cells.
5. Incubate the cells for 14–24 hours at 37°C.
6. Wash the cell monolayer several times with phosphate-buffered saline.
7. Cover the cell monolayer with a small amount of phosphate-buffered saline and examine under a light microscope.

Cells that have expressed the  $\beta$ -galactosidase expression vector should be a brilliant blue. The transfection frequency can be estimated by counting the relative numbers of stained and unstained cells.



# Protocol 2

---

## Calcium-phosphate-mediated Transfection of Eukaryotic Cells with Plasmid DNAs

**T**HE UPTAKE OF DNA BY CELLS IN CULTURE IS MARKEDLY ENHANCED when the nucleic acid is presented as a coprecipitate of calcium phosphate and DNA. Graham and van der Eb (1973) initially described this method, and their work laid the foundation for the introduction of cloned DNAs into mammalian cells and led directly to reliable methods for both stable transformation of cells and transient expression of cloned DNAs. For further details on the procedure, please see the information panel on **TRANSFECTION OF MAMMALIAN CELLS WITH CALCIUM PHOSPHATE-DNA COPRECIPITATES** at the end of this chapter.

Since the publication of the original method, increases in the efficiency of the procedure have been achieved by incorporating additional steps, such as a glycerol shock (Parker and Stark 1979) and/or a chloroquine treatment (Luthman and Magnusson 1983) in the transfection protocol. Treatment with sodium butyrate has been shown to enhance the expression of plasmids that contain the SV40 early promoter/enhancer in simian and human cells (Gorman et al. 1983a,b). Transfection kits, which frequently include these and other modifications to the original protocol, are available from a number of companies (please see Table 16-2).

This protocol, which describes a calcium-phosphate-mediated transfection method for use with plasmid DNAs and adherent cells, was modified from Jordan et al. (1996), who rigorously optimized calcium-phosphate-based transfection methods for Chinese hamster ovary cells and human embryonic kidney 293 cells. Following this protocol are variations on this basic method:

- For high-efficiency generation of stable transfectants, please see the alternative method at the end of this protocol.
- For use with high-molecular-weight genomic DNAs (Protocol 3) and for use with adherent cells that have been released from the substratum with trypsin, please see the alternative method at the end of Protocol 3.
- For use with nonadherent cells, please see the alternative method at the end of Protocol 3.

**MATERIALS**

**CAUTION:** Please see Appendix 12 for appropriate handling of materials marked with <!.>.

**Buffers and Solutions**

Please see Appendix 1 for components of stock solutions, buffers, and reagents. Dilute stock solutions to the appropriate concentrations.

*CaCl<sub>2</sub>* (2.5 M)

*Chloroquine* (100 mM) (optional)

Dissolve 52 mg of chloroquine diphosphate in 1 ml of deionized distilled H<sub>2</sub>O. Sterilize the solution by passing it through a 0.22- $\mu$ m filter; store the filtrate in foil-wrapped tubes at -20°C. Please see Step 5.

*Giemsa stain* (10% w/v)

The Giemsa stain should be freshly prepared in phosphate-buffered saline or H<sub>2</sub>O and filtered through Whatman No. 1 filter paper before use.

*Glycerol* (15% v/v) in 1x HEPES-buffered saline (optional)

Add 15% (v/v) autoclaved glycerol to filter-sterilized HEPES-buffered saline solution just before use. Please see Step 5.

*2x HEPES-buffered saline*

140 mM NaCl

1.5 mM Na<sub>2</sub>HPO<sub>4</sub>·2H<sub>2</sub>O

50 mM HEPES

Dissolve 0.8 g of NaCl, 0.027 g of Na<sub>2</sub>HPO<sub>4</sub>·2H<sub>2</sub>O, and 1.2 g of HEPES in a total volume of 90 ml of distilled H<sub>2</sub>O. Adjust the pH to 7.05 with 0.5 N NaOH <!.>, and then adjust the volume to 100 ml with distilled H<sub>2</sub>O. Sterilize the solution by passing it through a 0.22- $\mu$ m filter; store the filtrate in 5-ml aliquots at -20°C for periods of up to 1 year.

*Methanol* <!.>

*Phosphate-buffered saline*

The solution should be sterilized by filtration before use and stored at room temperature.

*Sodium butyrate* (500 mM) (optional)

In a chemical fume hood, bring an aliquot of stock butyric acid solution to a pH of 7.0 with 10 N NaOH. Sterilize the solution by passing it through a 0.22- $\mu$ m filter; store in 1-ml aliquots at -20°C. Please see Step 5.

*0.1x TE* (pH 7.6)

1 mM Tris-Cl (pH 7.6)

0.1 mM EDTA (pH 7.6)

Sterilize the solution by passing it through a 0.22- $\mu$ m filter; store the filtrate in aliquots at 4°C.

**Nucleic Acids and Oligonucleotides**

*Plasmid DNA*

Dissolve the DNA in 0.1x TE (pH 7.6) at a concentration of 25  $\mu$ g/ml; 50  $\mu$ l of plasmid solution is required per milliliter of medium.

To obtain the highest transformation efficiencies, plasmid DNAs should be purified by column chromatography (please see Chapter 1, Protocol 9) or by equilibrium centrifugation in CsCl-ethidium bromide density gradients (please see Chapter 1, Protocol 10). If the starting amount of plasmid DNA is limiting, then add carrier DNA to adjust the final concentration to 25  $\mu$ g/ml. Eukaryotic carrier DNA prepared in the laboratory usually gives higher transfection efficiencies than commercially available DNA such as calf thymus or salmon sperm DNA. Sterilize the carrier DNA before use by ethanol precipitation or extraction with chloroform.

**Media**

*Cell culture growth medium* (complete and [optional] selective)

## Special Equipment

### *Tissue culture dishes (60-mm) or 12-well plates*

This protocol is designed for cells grown in 60-mm culture dishes or 12-well plates. If other multiwell plates, flasks, or dishes of a different diameter are used, scale the cell density and reagent volumes accordingly. Please see Table 16-3.

## Additional Reagents

*Step 6 of this protocol requires the reagents listed in Chapter 6, Protocol 10, and Chapter 7, Protocol 8.*

## Cells and Tissues

*Exponentially growing cultures of mammalian cells*

## METHOD

---

1. Twenty-four hours before transfection, harvest exponentially growing cells by trypsinization and replat them at a density of  $1 \times 10^5$  to  $4 \times 10^5$  cells/cm<sup>2</sup> in 60-mm tissue culture dishes or 12-well plates in the appropriate complete medium. Incubate the cultures for 20–24 hours at 37°C in a humidified incubator with an atmosphere of 5–7% CO<sub>2</sub>. Change the medium 1 hour before transfection.

To obtain optimum transfection frequencies, it is important to use exponentially growing cells. Cell lines used for transfection should never be allowed to grow to >80% confluency.

2. Prepare the calcium phosphate–DNA coprecipitate as follows: Combine 100 µl of 2.5 M CaCl<sub>2</sub> with 25 µg of plasmid DNA in a sterile 5-ml plastic tube and, if necessary, bring the final volume to 1 ml with 0.1× TE (pH 7.6). Mix 1 volume of this 2× calcium-DNA solution with an equal volume of 2× HEPES-buffered saline at room temperature. Quickly tap the side of the tube to mix the ingredients and allow the solution to stand for 1 minute.

The precipitation reaction mixture can be doubled or quadrupled in volume if a larger number of cells are to be transfected. Normally, 0.1 ml of the calcium phosphate–DNA coprecipitate is added per 1 ml of medium in the culture dish, well, or flask.

3. Immediately transfer the calcium phosphate–DNA suspension into the medium above the cell monolayer. Use 0.1 ml of suspension for each 1 ml of medium in a well or 60-mm dish. Rock the plate gently to mix the medium, which will become yellow-orange and turbid. Carry out this step as quickly as possible because the efficiency of transfection declines rapidly once the DNA precipitate is formed. If the cells will be treated with chloroquine, glycerol, and/or sodium butyrate, proceed directly to Step 5.

In some instances, higher transfection frequencies are achieved by first removing the medium and then directly adding the calcium phosphate–DNA suspension to the exposed cells. Thereafter, incubate the cells for 15 minutes at room temperature, and then add medium to the dish.

4. Transfected cells that will not be treated with transfection facilitators should be incubated at 37°C in a humidified incubator with an atmosphere of 5–7% CO<sub>2</sub>. After 2–6 hours incubation, remove the medium and DNA precipitate by aspiration. Add 5 ml of warmed (37°C) complete growth medium and return the cells to the incubator for 1–6 days. Proceed to Step 6 to assay for transient expression of the transfected DNA, or proceed directly to Step 7 if the objective is stable transformation of the cells.

5. The uptake of DNA can be increased by treatment of the cells with chloroquine in the presence of the calcium phosphate–DNA coprecipitate or exposure to glycerol and sodium butyrate following removal of the coprecipitate solution from the medium.

#### TREATMENT OF CELLS WITH CHLOROQUINE

Chloroquine is a weak base that is postulated to act by inhibiting the intracellular degradation of the DNA by lysosomal hydrolases (Luthman and Magnusson 1983). The concentration of chloroquine added to the growth medium and the time of treatment are limited by the sensitivity of the cells to the toxic effect of the drug. The optimal concentration of chloroquine for the cell type used should be determined empirically (please see the information panel on **CHLOROQUINE DIPHOSPHATE**).

- a. Dilute 100 mM chloroquine diphosphate 1:1000 directly into the medium either before or after the addition of the calcium phosphate–DNA coprecipitate to the cells.
- b. Incubate the cells for 3–5 hours at 37°C in a humidified incubator with an atmosphere of 5–7% CO<sub>2</sub>.  
Most cells can survive in the presence of chloroquine for 3–5 hours. Cells often develop a vesicularized appearance during treatment with chloroquine.
- c. After the treatment with DNA and chloroquine, remove the medium, wash the cells with phosphate-buffered saline, and add 5 ml of warmed complete growth medium. Return the cells to the incubator for 1–6 days. Proceed to Step 6 to assay for transient expression of the transfected DNA, or proceed directly to Step 7 if the objective is stable transformation of the cells.

#### TREATMENT OF CELLS WITH GLYCEROL

This procedure may be used following treatment with chloroquine. Because cells vary widely in their sensitivity to the toxic effects of glycerol, each cell type must be tested in advance to determine the optimum time (30 seconds to 3 minutes) of treatment.

- a. After cells have been exposed for 2–6 hours to the calcium phosphate–DNA coprecipitate in growth medium ( $\pm$  chloroquine), remove the medium by aspiration and wash the monolayer once with phosphate-buffered saline.
- b. Add 1.5 ml of 15% glycerol in 1x HEPES-buffered saline to each monolayer, and incubate the cells for the predetermined optimum length of time at 37°C.
- c. Remove the glycerol by aspiration, and wash the monolayers once with phosphate-buffered saline.
- d. Add 5 ml of warmed complete growth medium, and incubate the cells for 1–6 days. Proceed to Step 6 to assay for transient expression of the transfected DNA, or proceed directly to Step 7 if the objective is stable transformation of the cells.

#### TREATMENT OF CELLS WITH SODIUM BUTYRATE

The mechanism through which sodium butyrate acts is not known with certainty; however, the compound is an inhibitor of histone deacetylation (Lea and Randolph 1998), which suggests that treatment may lead to histone hyperacetylation and a chromatin structure on the incoming plasmid DNA that is predisposed to transcription (Workman and Kingston 1998).

- a. Following the glycerol shock, dilute 500 mM sodium butyrate directly into the growth medium (Step d, treatment of cells with glycerol). Different concentrations of sodium butyrate are used depending on the cell type. For example:

CV-1	10 mM
NIH-3T3	7 mM
HeLa	5 mM
CHO	2 mM

The correct amount for other cell lines that may be transfected should be determined empirically.

- b. Incubate the cells for 1–6 days. Proceed to Step 6 to assay for transient expression of the transfected DNA, or proceed directly to Step 7 if the objective is stable transformation of the cells.
6. To assay the transfected cells for transient expression of the introduced DNA, harvest the cells 1–6 days after transfection. Analyze RNA or DNA using hybridization. Analyze newly synthesized protein by radioimmunoassay, by immunoblotting, by immunoprecipitation following *in vivo* metabolic labeling, or by assays of enzymatic activity in cell extracts.

To minimize dish-to-dish variation in transfection efficiency, it is best to (i) transfect several dishes with each construct, (ii) trypsinize the cells after 24 hours of incubation, (iii) pool the cells, and (iv) replat them on several dishes.

7. To isolate stable transfectants:

- a. Incubate the cells for 24–48 hours in nonselective medium to allow time for expression of the transferred gene(s).
- b. Either trypsinize and replat the cells in the appropriate selective medium or add the selective medium directly to the cells without further manipulation.
- c. Change the selective medium with care every 2–4 days for 2–3 weeks to remove the debris of dead cells and to allow colonies of resistant cells to grow.
- d. Clone individual colonies and propagate for assay (for methods, please see Jakoby and Pastan 1979 or Spector et al. 1998b [Chapter 86 of *Cells: A Laboratory Manual*]).
- e. Obtain a permanent record of the numbers of colonies by fixing the remaining cells with ice-cold methanol for 15 minutes followed by staining with 10% Giemsa for 15 minutes at room temperature before rinsing in tap water.

The dilution at which the transfected cells should be replated to yield well-separated colonies is determined by the efficiency of stable transformation, which can vary over several orders of magnitude (e.g., please see Spandidos and Wilkie 1984). The efficiency is dependent on the recipient cell type (significant differences have been observed even between different clones or different passage numbers of the same cell line [Corsaro and Pearson 1981; Van Pel et al. 1985]), the nature of the introduced gene and the efficacy of the transcriptional control signals associated with it, and the amount of DNA used in the transfection.

**ALTERNATIVE PROTOCOL: HIGH-EFFICIENCY CALCIUM-PHOSPHATE-MEDIATED TRANSFECTION OF EUKARYOTIC CELLS WITH PLASMID DNAs**

A modification of the classical calcium phosphate transfection method that greatly enhances the efficiency of the procedure was developed by Hiroto Okayama and colleagues (Chen and Okayama 1987, 1988). Their method works particularly well when stable transfectants are to be isolated using supercoiled plasmid DNAs and differs from the classical procedure in that the calcium phosphate-DNA coprecipitate is allowed to form in the tissue culture medium during prolonged incubation (15–24 hours) under controlled conditions of pH (6.96) and reduced CO<sub>2</sub> tension (2–4%).

**Variables Affecting the Efficiency of Transfection**

Variables that affect transfection include the purity, form, and amount of the DNA; the pH of the 2x BES buffer; and the concentration of CO<sub>2</sub> in the incubator.

- Impure plasmid DNAs transfect poorly because of the inhibitory effects of bacterial contaminants. For this reason, the best results are obtained with scrupulously clean DNA, preferably purified through specialized chromatography resins or two rounds of CsCl centrifugation (please see Chapter 1, Protocols 9 and 10). If necessary, the plasmid can be further purified by phenol:chloroform extraction in the presence of 1% (w/v) SDS.
- Linear DNAs yield very low transformation frequencies, perhaps because the slow formation of the calcium phosphate-DNA coprecipitate leaves the DNA exposed for long periods of time to cell nucleases.
- The nature of the precipitate is affected by the amount of DNA used. A transition (visible under the microscope) from a coarse precipitate to a fine precipitate occurs at the optimal DNA concentration (usually 2–3 µg/ml in the growth medium). The optimum DNA concentration encompasses a narrow range and should be determined empirically for individual cell lines.
- The slow formation of the calcium phosphate-DNA coprecipitate requires a slightly acidic pH and incubation in an atmosphere containing low concentrations of CO<sub>2</sub>. The pH curve is very sharp with a clearly defined optimum at 6.96, whereas the CO<sub>2</sub> concentration is optimal between 2% and 4%.

Chen and Okayama (1987) reported that this method could be used for transient analysis of gene expression and that the simultaneous introduction of two or more plasmids reduced the overall efficiency of transfection. The overall frequency was still much higher than that obtained with other calcium phosphate methods. When cotransfecting with a selectable marker, it is usually necessary to optimize the system using mixtures containing different ratios of plasmids carrying the selectable marker of the gene of interest (e.g., 1:2, 1:5, and 1:10).

**Additional Materials***2x BES-buffered saline (BBS)*

50 mM BES (*N,N*-bis[2-hydroxyethyl]-2-aminoethanesulfonic acid)  
280 mM NaCl  
1.5 mM Na<sub>2</sub>HPO<sub>4</sub>·2H<sub>2</sub>O

Dissolve 1.07 g of BES, 1.6 g of NaCl, and 0.027 g of Na<sub>2</sub>HPO<sub>4</sub> in a total volume of 90 ml of distilled H<sub>2</sub>O. Adjust the pH of the solution to 6.96 with HCl at room temperature, and then adjust the volume to 100 ml with distilled H<sub>2</sub>O. Sterilize the solution by passing it through a 0.22-µm filter; store the filtrate in aliquots at –20°C.

*CaCl<sub>2</sub> (0.25 M)*

Dissolve 1.1 g of CaCl<sub>2</sub>·6H<sub>2</sub>O in 20 ml of distilled H<sub>2</sub>O. Sterilize the solution by passing it through a 0.22-µm filter. Store the filtrate in 1-ml aliquots at –20°C.

*Superhelical plasmid at 1 µg/µl in 0.1x TE (pH 7.6)**Tissue culture dishes (90-mm)*

This protocol is designed for cells grown in 90-mm culture dishes. If other multiwell plates, flasks, or dishes of a different diameter are used, scale the cell density and reagent volumes accordingly. Please see Table 16-3.

**Method**

1. Twenty-four hours before transfection, harvest exponentially growing cells by trypsinization and replate aliquots of 5 x 10<sup>5</sup> cells onto 90-mm tissue culture dishes. Add 10 ml of complete growth medium, and incubate the cultures overnight at 37°C in a humidified incubator with an atmosphere of 5–7% CO<sub>2</sub>.

2. Mix 20–30  $\mu\text{g}$  of superhelical plasmid DNA with 0.5 ml of 0.25 M  $\text{CaCl}_2$ . Add 0.5 ml of 2x BES-buffered saline (BBS) and incubate the mixture for 10–20 minutes at room temperature. Do not expect a visible precipitate to form during this time.
3. Add the  $\text{CaCl}_2$ -DNA-BBS solution dropwise to the dishes of cells, swirling gently to mix well. Incubate the cultures for 15–24 hours at 37°C in a humidified incubator in an atmosphere of 2–4%  $\text{CO}_2$ .
4. Remove the medium by aspiration, and rinse the cells twice with medium. Add 10 ml of nonselective medium, and incubate the cultures for 18–24 hours at 37°C in a humidified incubator in an atmosphere of 5%  $\text{CO}_2$ .
5. Following 18–24 hours of incubation in nonselective medium, to allow expression of the transfected gene(s) to occur, trypsinize and replat the cells in the appropriate selective medium. Change the selective medium with care every 2–4 days for 2–3 weeks to remove the debris of dead cells and to allow colonies of resistant cells to grow.

The dilution at which the transfected cells should be replated to yield well-separated colonies is determined by the efficiency of stable transformation, which can vary over several orders of magnitude (e.g., please see Spandidos and Wilkie 1984). The efficiency is dependent on the recipient cell type (significant differences have been observed between different clones or different passage numbers of the same cell line [Corsaro and Pearson 1981; Van Pel et al. 1985]), the nature of the introduced gene and the efficacy of the transcriptional control signals associated with it, and the amount of donor DNA used in the transfection.

6. Thereafter, clone individual colonies and propagate for assay (for methods, please see Jakoby and Pastan 1979 or Spector et al. 1998b [Chapter 86 in *Cells: A Laboratory Manual*]).

A permanent record of the number of colonies may be obtained by fixing the remaining cells with ice-cold methanol for 15 minutes followed by staining with 10% Giemsa for 15 minutes at room temperature before rinsing in tap water. The Giemsa stain should be freshly prepared in phosphate-buffered saline or  $\text{H}_2\text{O}$  and filtered through Whatman No. 1 filter paper before use.

# Protocol 3

---

## Calcium-phosphate-mediated Transfection of Cells with High-molecular-weight Genomic DNA

**M**AMMALIAN GENES HAVE BEEN SUCCESSFULLY ISOLATED by transfecting cultured mammalian cells with genomic DNA, followed by selection for the gene of interest. This includes dominant cellular oncogenes, genes that encode cell surface molecules, and, as selection/identification strategies and techniques have improved, genes that encode intracellular proteins. Target genes are recovered from the chromosomal DNA of stably transfected cells by virtue of their species-specific repetitive DNA elements or by linkage to cotransfected plasmid DNAs.

The method outlined below is a modification of the calcium phosphate procedure described by Graham and Van der Eb (1973), using high-molecular-weight genomic DNA instead of plasmid DNA. The procedure works especially well to generate stable lines of cells carrying transfected genes that complement mutations in the hosts' chromosomal genes (Sege et al. 1984; Kingsley et al. 1986). This protocol was supplied by P. Reddy and M. Krieger (Massachusetts Institute of Technology).

### MATERIALS

---

#### Buffers and Solutions

Please see Appendix 1 for components of stock solutions, buffers, and reagents.  
Dilute stock solutions to the appropriate concentrations.

*CaCl<sub>2</sub> (2 M)*

Sterilize by filtration, and store frozen as 5-ml aliquots.

*Glycerol (15% v/v) in 1x HEPES-buffered saline*

Add 15% (v/v) autoclaved glycerol to filter-sterilized HEPES-buffered saline solution just before use.



*HEPES-buffered saline*

21 mM HEPES  
0.7 mM Na<sub>2</sub>HPO<sub>4</sub>  
137 mM NaCl  
5 mM KCl  
6 mM dextrose

Adjust the pH of the solution to 7.10. Sterilize the solution by filtration and store frozen in 25–50-ml aliquots. Thaw a fresh aliquot before each transfection and check the pH of a small volume. Readjust pH if necessary to 7.10.

*Isopropanol*

*NaCl (3 M)*

Sterilize by filtration, and store at room temperature.

## Nucleic Acids and Oligonucleotides

*Genomic DNA*

Prepare high-molecular-weight DNA in TE from appropriate cells as described in Chapter 6, Protocol 3. Dilute the DNA to 100 µg/ml in TE (pH 7.6). Approximately 20–25 µg of genomic DNA is required to transfect each 90-mm plate of cultured cells.

The genomic DNA must be sheared to a size range of 45–60 kb before using it to transfect cells (please see Steps 2 and 3). The appropriate conditions for shearing the genomic DNA are best determined in preliminary experiments as follows: Shear 2-ml aliquots of high-molecular-weight DNA by passing each aliquot through a 22-gauge needle for a different number of times (e.g., three, four, five, or six times). Examine the DNA by electrophoresis on a 0.6% (w/v) agarose gel followed by staining with either ethidium bromide or SYBR Gold. As markers, use monomeric and dimeric forms of linear bacteriophage λ DNA. To optimize the remaining steps, sheared DNA of the proper size should then be taken through Step 9 of the protocol using dishes without cells.

*Plasmid with selectable marker*

Optional, please see notes to Steps 3 and 12.

## Media

*Cell culture growth medium (complete and selective)*

## Special Equipment

*Polyethylene tubes (12-ml)*

*Shepherd's crook*

Siliconized glass Pasteur pipette containing a hook at the end.

*Tissue culture dishes (90-mm)*

## Cells and Tissues

*Exponentially growing cultures of mammalian cells*

## METHOD

---

1. On day 1 of the experiment, plate exponentially growing cells (e.g., CHO cells) at a density of  $5 \times 10^5$  cells per 90-mm culture dish in appropriate growth medium containing serum. Incubate the cultures for ~16 hours at 37°C in a humidified incubator with an atmosphere of 5% CO<sub>2</sub>.
2. On day 2, shear an appropriate amount of high-molecular-weight DNA into fragments ranging in size from 45 kb to 60 kb, by passing it through a 22-gauge needle for the predetermined number of times (please see the note to the Genomic DNA entry above in Materials).  
Cells should be transfected with 20–25 µg of genomic DNA per 90-mm dish.

3. Precipitate the sheared DNA by adding 0.1 volume of 3 M NaCl and 1 volume of isopropanol. Collect the DNA on a Shepherd's crook. Drain the precipitate briefly against the side of the tube and transfer it to a second tube containing HEPES-buffered saline (1 ml per 12–15  $\mu$ g of DNA). Redissolve the DNA by gentle rotation for 2 hours at 37°C. Make sure that all of the DNA has dissolved before proceeding.

When cotransfecting with a selectable marker (please see the note below Step 12), add to the genomic DNA a sterile solution of the appropriate plasmid to a final concentration of 0.5  $\mu$ g/ml.

4. Transfer 3-ml aliquots of sheared genomic DNA into 12-ml polyethylene tubes (one aliquot per two dishes to be transfected).

The number of dishes required and transfectants obtained will vary from one cell line to another and on the efficiency of the selection method. As a guide, ~15–20 dishes of CHO cells must be transfected to obtain 3–10 stable transformants.

5. To form the calcium phosphate–DNA coprecipitate, gently vortex an aliquot of sheared genomic DNA, and add 120  $\mu$ l of 2 M  $\text{CaCl}_2$  in a dropwise fashion. Incubate the tube for 15–20 minutes at room temperature.

The solution should turn hazy, but it should not form visible clumps of precipitate.

6. Aspirate the medium from two dishes of cells (from Step 1) and gently add 1.5 ml of the calcium phosphate–DNA coprecipitate to each dish. Carefully rotate the dishes to swirl the medium and spread the precipitate over the monolayer of cells. Incubate the cells for 20 minutes at room temperature, rotating the dishes once during the incubation.

7. Gently add 10 ml of warmed (37°C) growth medium to each dish and incubate for 6 hours at 37°C in a humidified incubator with an atmosphere of 5%  $\text{CO}_2$ .

8. Repeat Steps 5–7 until all of the dishes of cells contain the calcium phosphate–DNA precipitate.

9. After 6 hours of incubation, examine each dish under a light microscope. A “peppery” precipitate should be seen adhering to the cells. The precipitate should be neither too fine nor clumpy.

Experience will dictate how a “peppery” precipitate looks under the microscope. Terminate the experiment with cells if a very fine or clumpy precipitate is visualized at this step. The failure to form a peppery precipitate at this step or a hazy solution at Step 5 could be due to the use of a HEPES-buffered saline solution of improper pH, an overly long incubation at Step 5, or a suboptimal concentration of  $\text{CaCl}_2$  or DNA.

10. In most cases, treatment with glycerol at this step will enhance the transfection frequency. To shock the cells with glycerol:

- a. Aspirate the medium containing the calcium phosphate–DNA coprecipitate.
- b. To each dish of cells, add 3 ml of 15% glycerol in 1 $\times$  HEPES-buffered saline that has been warmed to 37°C. Incubate for *no longer than 3 minutes* at room temperature.

It is important that the glycerol in the HEPES-buffered saline *not* be left in contact with the cells for too long. The optimum time period usually spans a narrow range and varies from one cell line to another and from one laboratory to the next. For these reasons, treat only a few dishes at a time and take into account the length of time to aspirate the glycerol in the HEPES-buffered saline. Do not to exceed the optimum incubation period. Seconds can count!

- c. Aspirate the glycerol in the HEPES-buffered saline and rapidly wash the dishes twice with 10 ml of warmed growth medium.
- d. Add 10 ml warmed growth medium and incubate the cultures for 12–15 hours at 37°C in a humidified incubator with an atmosphere of 5%  $\text{CO}_2$ .

11. Replace the medium with 10 ml of fresh growth medium. Continue the incubation overnight at 37°C in a humidified incubator with an atmosphere of 5% CO<sub>2</sub>.
12. Microscopic examination of cells at this point (day 4) should reveal a normal morphology. Cells can be trypsinized and replated in selective medium on day 4. Continue the incubation for 2–3 weeks to allow growth of complemented and/or resistant colonies. Change the medium every 2–3 days.

The length of the selection period, the cell density of replating, and the selection conditions all depend on the mutation or gene being complemented or selected. Optimum cell density for replating at Step 12 usually varies between  $2.5 \times 10^5$  and  $1 \times 10^6$  cells per 90-mm dish. Determine this parameter empirically by plating different numbers of cells without transfection and applying the selection procedure. For logistical reasons, use the highest density that still allows efficient cell killing.

Cotransfection (e.g., with a plasmid conferring G418 resistance) can be used to distinguish between transfectants and revertants. Because the reversion frequency for some mutant cell lines can be as high as  $10^{-6}$  (i.e., 1 per 1 million cells plated), false positives can be a problem. The transfection frequency is usually  $2 \times 10^{-7}$ , and the cotransfection frequency is  $\sim 10^{-8}$ . The use of a selection (e.g., G418 resistance) in conjunction with the mutation/gene selection should eliminate false positives. For further details, please see the information panel on **COTRANSFORMATION**.

13. Thereafter, clone individual colonies and propagate them for assay (for methods, please see Jakoby and Pastan 1979 and Step 7d, p. 16.18).

A permanent record of the numbers of colonies may be obtained by fixing the remaining cells with ice-cold methanol for 15 minutes followed by staining with 10% Giemsa for 15 minutes at room temperature before rinsing in tap water. The Giemsa stain should be freshly prepared in PBS or H<sub>2</sub>O and filtered through Whatman No. 1 filter paper before use.

### **ALTERNATIVE PROTOCOL: CALCIUM-PHOSPHATE-MEDIATED TRANSFECTION OF ADHERENT CELLS**

This protocol can be used with all types of adherent cells, but is particularly useful for polarized epithelial cells, which do not efficiently take up material by endocytosis through the apical plasma membrane.

#### **Additional Materials**

*Exponentially growing adherent mammalian cells*  
*Sorvall H1000B rotor or equivalent*

#### **Method**

1. Harvest exponentially growing adherent cells by trypsinization. Resuspend the cells in growth medium containing serum, and centrifuge aliquots containing  $\sim 10^6$  cells at 800g (2000 rpm in a Sorvall H1000B rotor) for 5 minutes at 4°C. Discard the supernatants.

2. Form the calcium phosphate-DNA coprecipitate as described in Protocol 2, Step 2 if plasmid DNA is used or as described in Protocol 3, Step 5 if genomic DNA is used.

Note that the coprecipitate with plasmid DNA takes only  $\sim 5$  minutes to prepare, whereas the coprecipitate containing genomic DNA takes  $\sim 25$  minutes to prepare. Execute the initial two steps of this protocol so that cells and coprecipitate are ready at the same time.

3. Resuspend each aliquot of  $10^6$  cells in 0.5 ml of the calcium phosphate-DNA suspension, and incubate for 15 minutes at room temperature.

This protocol can be easily modified to accommodate greater numbers of cells. For example, Chu and Sharp (1981) used  $10^8$  cells in 2 ml of calcium phosphate-DNA suspension containing 25  $\mu$ g of DNA. In this case, after 15 minutes, dilute the mixture with 40 ml of complete growth medium supplemented with 0.05x HEPES-buffered saline and 6.25 mM  $\text{CaCl}_2$ . Plate the cells at a density of  $5 \times 10^7$  cells per 150-mm dish.

4. To each aliquot, add 4.5 ml of warmed growth medium (with or without chloroquine; please see Protocol 2, Step 5), and plate the entire suspension ( $\sim 5$  ml) in a single 90-mm tissue culture dish. Incubate the cells for up to 24 hours at 37°C in a humidified incubator with an atmosphere of 5–7%  $\text{CO}_2$ .
5. Some types of cells may be further treated with glycerol and sodium butyrate to facilitate transfection. Please follow the procedures in Protocol 2, Step 5.
6. Thereafter, assay the cells for transient expression or place in the appropriate selective medium for the isolation of stable transformants (please see Protocol 2, Steps 6 and 7).

**ALTERNATIVE PROTOCOL: CALCIUM-PHOSPHATE-MEDIATED TRANSFECTION OF CELLS GROWING IN SUSPENSION**

A few cell lines grown as suspension cultures (e.g., HeLa cells) can be transfected using the modified calcium phosphate procedure described in this protocol. However, most lines of cells grown in suspension are resistant to calcium-phosphate-mediated transfection methods. Intransigent cell lines are best transfected using electroporation (Protocol 5) or lipofection (Protocol 1).

**Additional Materials**

*Exponentially growing mammalian suspension cells*

*Phosphate-buffered saline (PBS)*

*Sorvall H1000B rotor or equivalent*

**Method**

1. Collect cells from an exponentially growing suspension culture by centrifugation at 800g (2000 rpm in a Sorvall H1000B rotor) for 5 minutes at 4°C. Discard the supernatant, and resuspend the cell pellet in 20 volumes of ice-cold PBS. Divide the suspension into aliquots containing  $1 \times 10^7$  cells each. Recover the washed cells by centrifugation as before, and again discard the supernatant.
2. Form the calcium phosphate–DNA coprecipitate as described in Protocol 2, Step 2 if plasmid DNA is used for transfection or as described in Protocol 3, Step 5 if genomic DNA is used.
 

Note that preparation of the coprecipitate with plasmid DNA takes only ~5 minutes to prepare, whereas the coprecipitate containing genomic DNA takes ~25 minutes to prepare. Execute the initial two steps of this protocol so that cells and coprecipitate are ready at the same time.
3. Gently resuspend  $1 \times 10^7$  cells in 1 ml of calcium phosphate–DNA suspension (containing ~20 µg of DNA), and allow the suspension to stand for 20 minutes at room temperature.
4. Add 10 ml of complete growth medium (with or without chloroquine; please see Protocol 2, Step 5) to a tube of cells, and plate the entire suspension in a single 90-mm tissue culture dish. Incubate the cells for 6–24 hours at 37°C in a humidified incubator with an atmosphere of 5–7% CO<sub>2</sub>.
5. (*Optional for cells known to survive a glycerol shock*) At 4–6 hours after beginning Step 4, carry out the following (otherwise, proceed to Step 6):
  - a. Collect the cells by centrifugation at 800g (2000 rpm in a Sorvall H1000B rotor) for 5 minutes at room temperature, and wash them once with PBS.
  - b. Resuspend the washed cells in 1 ml of 15% glycerol in 1× HEPES-buffered saline, and incubate the cells for 30 seconds to 3 minutes at 37°C.
 

Please see the note to Step 10b in the main protocol.
  - c. Dilute the suspension with 10 ml of PBS, and recover the cells by centrifugation as described in Step a. Wash the cells once in PBS.
  - d. Resuspend the washed cells in 10 ml of complete growth medium, and plate them in a 90-mm tissue culture dish. Incubate the culture for 48 hours at 37°C in a humidified incubator with an atmosphere of 5–7% CO<sub>2</sub>.
6. Recover the cells by centrifugation at 800g (2000 rpm in a Sorvall H1000B rotor) for 5 minutes at room temperature, and wash them once with PBS.
7. Resuspend the cells in 10 ml of complete growth medium warmed to 37°C. Return the cells to the incubator for 48 hours before assaying for transient expression of transfected genes (Protocol 2, Step 6) or replating the cells in selective medium for isolation of stable transformants (Protocol 2, Step 7).

# Protocol 4

---

## Transfection Mediated by DEAE-Dextran: High-efficiency Method

**T**HE FIRST TRANSFECTION METHODS, DEVELOPED IN THE LATE 1950s, used hyperosmotic and polycationic proteins to promote entry of DNA into cells (for review, please see Felgner 1990). The results were erratic, and the efficiency of transfection was, at best, very poor. The situation improved dramatically in the mid 1960s when DEAE-dextran (diethylaminoethyl-dextran) was used to introduce poliovirus RNA (Pagano and Vaheri 1965) and SV40 and polyomavirus DNAs (McCutchan and Pagano 1968; Warden and Thorne 1968) into cells. The procedure, with slight modifications, continues to be widely used for transfection of cultured cells with viral genomes and recombinant plasmids. Although the mechanism of action of DEAE-dextran is not understood in detail, it seems likely that the high-molecular-weight positively charged polymer serves as a bridge between the negatively charged nucleic acid and the negatively charged surface of the cell (Lieber et al. 1987; Holter et al. 1989). After the DEAE-dextran/DNA complexes have been internalized by endocytosis (Ryser 1967; Yang and Yang 1997), the DNA somehow escapes from the increasingly acidic endosomes and is transported by unknown mechanisms across the cytoplasm and into the nucleus.

Transfection mediated by DEAE-dextran differs from calcium phosphate coprecipitation in three important respects. First, it is used for transient expression of cloned genes and not for stable transformation of cells (Gluzman 1981). Second, it works very efficiently with lines of cells such as BSC-1, CV-1, and COS but is unsatisfactory with many other types of cells. Third, smaller amounts of DNA are used for transfection with DEAE-dextran than with calcium phosphate coprecipitation. Maximal transfection efficiency of  $10^5$  simian cells is achieved with 0.1–1.0  $\mu\text{g}$  of supercoiled plasmid DNA; larger amounts of DNA (>2–3  $\mu\text{g}$ ) can be inhibitory. By contrast to transfection mediated by calcium phosphate, where high concentrations of DNA are required to promote the formation of a coprecipitate, carrier DNA is rarely used with the DEAE-dextran transfection method.

Since the method was introduced more than 20 years ago, many variants of DEAE-dextran transfection have been described. In most cases, the cells are exposed to a preformed mixture of DNA and high-molecular-weight DEAE-dextran (m.w. >500,000). However, a modified procedure has been described in which the cells are exposed first to DEAE-dextran and then to DNA (al-Moslih and Dubes 1973; Holter et al. 1989). All of these methods seek to maximize the uptake of DNA and to minimize the cytotoxic effects of DEAE-dextran. The following are among the variables that influence the efficiency of transfection.

- **Concentration of DEAE-dextran used and length of time cells are exposed to it.** It is possible to use either a relatively high concentration of DEAE-dextran (1 mg/ml) for short periods (30 minutes to 1.5 hours) or a lower concentration (250  $\mu\text{g}/\text{ml}$ ) for longer periods of time (up to

8 hours). The first of these transfection procedures is the more efficient, but it involves monitoring the cells for early signs of distress when they are exposed to the DNA/DEAE-dextran mixture. The second technique is less demanding and more reliable, but slightly less efficient. However, it can be combined with shock treatments (see below) that can raise the efficiency of transfection to very high levels.

- **Use of facilitators such as DMSO, chloroquine, or glycerol.** The efficiency of transient expression of genes introduced by DEAE transfection is increased ~50-fold if cells are exposed to DMSO, glycerol, polyethyleneimine, or other substances such as Starburst dendrimers that perturb osmosis and increase the efficiency of endocytosis (Lopata et al. 1984; Sussman and Milman 1984; Kukowska-Latello et al. 1996; Zauner et al. 1996; Godbey et al. 1999). A similar increase in efficiency of transfection of some lines of cultured cells may be obtained by exposing the transfected cells to chloroquine, which prevents acidification of endosomes and promotes early release of DNA into the cytoplasm (Luthman and Magnusson 1983). In the best cases, 80% of the cells in a transfected population can express foreign genes when DEAE-dextran and facilitators are used in combination (e.g., please see Kluxen and Lübbert 1993). However, the efficiency of DNA transfection using DEAE-dextran with a facilitator varies greatly from cell line to cell line. Conditions that are optimal for one cell line may not work at all for another. To obtain consistently high efficiencies of transformation with a particular cell line, the following factors should be standardized:

- Density of cells and their state of growth.

- Amount of transfecting DNA.

- Concentration and molecular weight of DEAE-dextran.

- Length of time cells are exposed to DNA.

- Whether the DEAE-dextran and DNA are added to the cells simultaneously or sequentially (al-Moslih and Dubes 1973; Holter et al. 1989).

- Length and temperature of the posttransfection facilitation and the concentration of the facilitating agent.

- Whether the cells are transfected while growing on a solid support or are first removed from the solid support and transfected in suspension (Golub et al. 1989).

For publications that analyze the effects of some or all of these conditions on transfection efficiency, please see Holter et al. (1989), Fregeau and Bleackley (1991), Kluxen and Lübbert (1993), and Luo and Saltzman (1999).

In addition to its use as a primary agent for transfection, DEAE-dextran can also be used as an adjuvant to enhance the efficiency of electroporation. Although the effects appear to vary from one cell line to another, the combination of electroporation and DEAE-dextran in some cases can improve the efficiency of transfection by a factor of 10–100 (Gauss and Leiber 1992).

DNA transfected into cells by the DEAE-dextran method is prone to mutation. This is particularly true of sequences cloned in vectors that can replicate in transfected mammalian cells. For example, when the *E. coli lacI* gene, cloned in a plasmid containing an SV40 origin of replication, was introduced into COS-7 cells, allowed to replicate for several generations, and then returned to *E. coli*, mutations occurred at a frequency of one to several percent (Calos et al. 1983). Stunning in their variety, mutations induced during replication in mammalian cells include deletions, insertions, and base substitutions (Razzaque et al. 1983; Lebkowski et al. 1984; Ashman and Davidson 1985). These mutations are thought to arise as a consequence of damage caused by the action of degradative enzymes and low pH in the lysosomes and also perhaps by the lack of a complete chromatin structure after the transfecting DNA enters the nucleus (Miller et al. 1984; Reeves et al. 1985).

Here, we describe two variations on the classical DEAE-dextran transfection procedure. The first (main protocol) involves a brief exposure of cells to a high concentration of DEAE-dextran and yields higher transfection frequencies but elevated cellular toxicity. The second (please see the panel on **ALTERNATIVE PROTOCOL: TRANSFECTION MEDIATED BY DEAE-DEXTRAN: INCREASED CELL VIABILITY** at the end of this protocol) involves a longer exposure of cells to a lower concentration of DEAE-dextran, which produces lower transfection frequencies but increased cell survival.

#### TRANSFECTION OF COS CELLS

The DEAE-dextran procedure is most often used to transfect simian COS cells. These cells were developed by Gluzman (1981) and express the SV40 large T antigen (please see the information panel on **COS CELLS** in Chapter 11). Introduction of the SV40 origin of replication, typically by the use of the SV40 early promoter-enhancer/origin to express the gene or cDNA of interest, results in the amplification of the origin-containing plasmid to very high copy number (Gluzman 1981). This amplification in turn produces a high level of expression of the transfected cDNA or gene, but severely stresses and eventually kills cells that take up the plasmid. COS cells are thus usually used as transient transfection hosts and analyzed 48–72 hours posttransfection.

The efficiency of DEAE-dextran-mediated transfection of COS cells is very high, often approaching 50% of the cells on a dish. For this reason, COS cells are frequently used in expression cloning (please see Chapter 11, Protocol 2). The high efficiency of transfection also allows multiple plasmids to be introduced simultaneously into the cells. For example, entire intermediary metabolism pathways can be reconstituted in COS cells by introducing expression plasmids encoding individual enzymes in the pathway (Zuber et al. 1988).

## MATERIALS

### Buffers and Solutions

**Please see Appendix 1 for components of stock solutions, buffers, and reagents. Dilute stock solutions to the appropriate concentrations.**

#### *Chloroquine diphosphate (100 mM)*

Dissolve 60 mg of chloroquine diphosphate in 1 ml of deionized distilled H<sub>2</sub>O. Sterilize the solution by passing it through a 0.22- $\mu$ m filter. Store the filtrate in foil-wrapped tubes at -20°C.

Please see the information panel on **CHLOROQUINE DISPHOSPHATE**.

#### *DEAE-dextran (50 mg/ml)*

Dissolve 100 mg of DEAE-dextran ( $M_r = 500,000$ ; Pharmacia) in 2 ml of distilled H<sub>2</sub>O. Sterilize the solution by autoclaving for 20 minutes at 15 psi (1.05 kg/cm<sup>2</sup>) on liquid cycle. Autoclaving also assists dissolution of the polymer.

The molecular weight of the DEAE-dextran originally used for transfection was  $>2 \times 10^6$  (McCutchan and Pagano 1968). Although this material is no longer available commercially, it is still occasionally found in chemical storerooms. The older batches of higher-molecular-weight DEAE-dextran are more efficient for transfection than the lower-molecular-weight polymers currently available.

#### *Phosphate-buffered saline (PBS)*

Sterilize the solution by filtration before use and store it at room temperature.

#### *Tris-buffered saline with dextrose (TBS-D)*

Immediately before use, add 20% (w/v) dextrose (prepared in H<sub>2</sub>O and sterilized by autoclaving or filtration) to the TBS solution. The final dextrose concentration should be 0.1% (v/v).

### Nucleic Acids and Oligonucleotides

#### *Plasmid DNA*

To obtain the highest transformation efficiencies, purify the plasmid DNAs by column chromatography (please see Chapter 1, Protocol 9) or by equilibrium centrifugation in CsCl-ethidium bromide density gradients (please see Chapter 1, Protocol 10).

### Media

*Cell culture growth medium (complete and serum-free)*



## Special Equipment

### *Tissue culture dishes (60-mm or 35-mm)*

This protocol is designed for cells grown in 60-mm or 35-mm culture dishes. If multiwell plates, flasks, or dishes of a different diameter are used, scale the cell density and reagent volumes accordingly. Please see Table 16-3.

## Additional Reagents

*Step 8 of this protocol requires the reagents listed in Chapter 6, Protocol 1, and Chapter 7, Protocol 8.*

## Cells and Tissues

*Exponentially growing cultures of mammalian cells*

### **DEAE-DEXTRAN TRANSFECTION KITS**

Several manufacturers sell kits that provide all of the materials listed in this protocol (e.g., ProFection Mammalian Transfection System from Promega). These kits are somewhat expensive (reagent cost is about \$1 per 60-mm dish), but they serve as a useful source of control reagents when performing DEAE-dextran transfection experiments for the first time.

## METHOD

1. Twenty-four hours before transfection, harvest exponentially growing cells by trypsinization and transfer them to 60-mm tissue culture dishes at a density of  $10^5$  cells/dish (or 35-mm dishes at a density of  $5 \times 10^4$  cells/dish). Add 5 ml (or 3 ml for 35-mm dish) of complete growth medium, and incubate the cultures for 20–24 hours at 37°C in a humidified incubator with an atmosphere of 5–7% CO<sub>2</sub>.

The cells should be ~75% confluent at the time of transfection. If the cells are grown for <12 hours before transfection, they will not be well anchored to the substratum and are more likely to detach during exposure to DEAE-dextran.
2. Prepare the DNA/DEAE-dextran/TBS-D solution by mixing 0.1–4 µg of supercoiled or circular plasmid DNA into 1 mg/ml DEAE-dextran in TBS-D.

0.25 ml of the solution is required for each 60-mm dish; 0.15 ml is required for each 35-mm dish.  
The amount of DNA required to achieve maximal levels of transient expression depends on the exact nature of the construct and should be determined in preliminary experiments. If the construct carries a replicon that will function in the transfected cells (e.g., the SV40 early region promoter/origin of replication), 100–200 ng of DNA per  $10^5$  cells should be sufficient; if no replicon is present, larger amounts of DNA may be required (up to 1 µg per  $10^5$  cells).
3. Remove the medium from the cell culture dishes by aspiration, and wash the monolayers twice with warmed (37°C) PBS and once with warmed TBS-D.
4. Add the DNA/DEAE-dextran/TBS-D solution (250 µl per 60-mm dish, 150 µl per 35-mm dish). Rock the dishes gently to spread the solution evenly across the monolayer of cells. Return the cultures to the incubator for 30–90 minutes (the time will depend on the sensitivity of each batch of cells to the DNA/DEAE-dextran/TBS-D solution). At 15–20-minute intervals, remove the dishes from the incubator, swirl them gently, and check the appearance of the cells under the microscope. If the cells are still firmly attached to the substratum, continue the incubation. Stop the incubation when the cells begin to shrink and round up.

5. Remove the DNA/DEAE-dextran/TBS-D solution by aspiration. Gently wash the monolayers once with warmed TBS-D and then once with warmed PBS, taking care not to dislodge the transfected cells.
6. Add 5 ml (per 60-mm dish) or 3 ml (per 35-mm dish) of warmed medium supplemented with serum and chloroquine (100  $\mu$ M final concentration), and incubate the cultures for 3–5 hours at 37°C in a humidified incubator with an atmosphere of 5–7% CO<sub>2</sub>.

The efficiency of transfection is increased severalfold by treatment with chloroquine, which may act by inhibiting the degradation of the DNA by lysosomal hydrolases (Luthman and Magnusson 1983). Note, however, that the cytotoxic effects of a combination of DEAE-dextran and chloroquine can be severe. It is therefore important to carry out preliminary experiments to determine the maximum permissible length of exposure to chloroquine after treatment of cells with DEAE-dextran (for further details, please see the information panel on **CHOROQUINE DIPHOSPHATE**).

7. Remove the medium by aspiration, and wash the monolayers three times with serum-free medium. Add to the cells 5 ml (per 60-mm dish) or 3 ml (per 35-mm dish) of medium supplemented with serum, and incubate the cultures for 36–60 hours at 37°C in a humidified incubator with an atmosphere of 5–7% CO<sub>2</sub> before assaying for transient expression of the transfected DNA.

The time of incubation should be optimized for the particular cell line and construct under study.

8. To assay the transfected cells for transient expression of the introduced DNA, harvest the cells 36–60 hours after transfection. Analyze RNA or DNA using hybridization. Analyze newly synthesized protein by radioimmunoassay, by immunoblotting, by immunoprecipitation following *in vivo* metabolic labeling, or by assays of enzymatic activity in cell extracts.

To minimize dish-to-dish variation in transfection efficiency, it is best to (i) transfect several dishes with each construct, (ii) trypsinize the cells for 24 hours of incubation, (iii) pool the cells, and (iv) replate them on several dishes.

**ALTERNATIVE PROTOCOL: TRANSFECTION MEDIATED BY DEAE-DEXTRAN:  
INCREASED CELL VIABILITY**

By contrast to the DEAE-dextran method described in the main protocol, this alternative protocol uses a lower concentration of DEAE-dextran (250 µg/ml) that remains in contact with the cells for longer periods of time (up to 8 hours). Although transfection frequencies are not as high as those obtained in the presence of elevated DEAE-dextran concentrations, the use of reduced levels of DEAE-dextran is associated with less cell toxicity.

**Additional Materials***Dulbecco's modified Eagle's medium*

This is standard DMEM buffered with NaHCO<sub>3</sub> and supplemented with serum.

*Dulbecco's modified Eagle's medium, buffered with HEPES (HEPES-buffered DMEM)*

This is DMEM lacking NaHCO<sub>3</sub> but containing 10 mM HEPES (pH 7.15). No serum should be added to this reagent.

**Method**

1. Twenty-four hours before transfection, harvest exponentially growing cells by trypsinization and transfer them to 60-mm tissue culture dishes with 10<sup>5</sup> cells/dish (or 35-mm dishes with 5 × 10<sup>4</sup> cells/dish). Add 5 ml (or 3 ml for 35-mm dish) of complete growth medium, and incubate the cultures for 20–24 hours at 37°C in a humidified incubator with an atmosphere of 5–7% CO<sub>2</sub>.

The cells should be ~75% confluent at the time of transfection. If the cells are grown for <12 hours before transfection, they will not be well anchored to the substratum and are more likely to detach during exposure to DEAE-dextran.

2. Mix 0.1–1 µg of supercoiled or circular plasmid DNA and 250 µg of DEAE-dextran per 1 ml of HEPES-buffered DMEM. The resulting solution will be used at 500 µl per 60-mm dish or 250 µl per 35-mm dish.

The amount of DNA required to achieve maximal levels of protein expression depends on the exact nature of the construct and should be determined in preliminary experiments. If the construct carries a replicon that will function in the transfected cells (e.g., the SV40 early region promoter/origin of replication), 100–200 ng of DNA per 10<sup>5</sup> cells should be sufficient; if no replicon is present, larger amounts of DNA may be required (up to 1 µg per 10<sup>5</sup> cells).

3. Remove the medium from the cell culture dishes by aspiration, and wash the monolayers twice with warmed (37°C) HEPES-buffered DMEM.

4. Add the DNA/DEAE-dextran/DMEM solution to the cells (500 µl per 60-mm dish, 250 µl per 35-mm dish), and return the cells to the incubator for up to 8 hours. Gently rock the dishes every 2 hours to ensure even exposure to the DNA/DEAE-dextran/DMEM solution.

The efficiency of transfection is increased severalfold by concurrent treatment of the cells with chloroquine diphosphate. If used, add the drug (100 µM final concentration) to the DNA/DEAE-dextran solution just before it is applied to the cells. Because chloroquine is toxic to the cells, the time of incubation must then be limited to 3–5 hours.

A simple variation on this step is reported to double the transfection frequency obtained with COS cells (Gonzales and Joly 1995): Plate the cells in small culture flasks with screw caps at the beginning of the experiment and tightly screw the cap after addition of the DNA/DEAE-dextran/DMEM solution in Step 4. Continue the incubation for 8 hours, during which time the medium alkalizes slowly, due to the metabolism of the small amount of CO<sub>2</sub> remaining in the flask. This change, which is marked by the gradual deepening in color from crimson to burgundy of the phenol red indicator in the medium, may stimulate transfection in a manner similar to the use of a reduced CO<sub>2</sub> atmosphere within the incubator (please see the **ALTERNATIVE PROTOCOL: HIGH-EFFICIENCY CALCIUM-PHOSPHATE-MEDIATED TRANSFECTION OF EUKARYOTIC CELLS WITH PLASMID DNAs** in Protocol 2).

5. Remove the DNA/DEAE-dextran/DMEM solution from the cells by aspiration, and gently wash the cell monolayers twice with warmed (37°C) HEPES-buffered DMEM. Take care not to dislodge the transfected cells.

6. Wash the cells once with warmed DMEM (buffered with NaHCO<sub>3</sub>, not HEPES) supplemented with serum. Add to the cells 5 ml (per 60-mm dish) or 3 ml (per 35-mm dish) of complete growth medium, and incubate the cultures for 36–60 hours at 37°C in a humidified incubator with an atmosphere of 5–7% CO<sub>2</sub> before assaying for transient expression of the transfected DNA.

7. To assay the transfected cells for transient expression of the introduced DNA, harvest the cells 36–60 hours after transfection. Analyze RNA or DNA using hybridization. Analyze newly synthesized protein by radioimmunoassay, by immunoblotting, by immunoprecipitation following *in vivo* metabolic labeling, or by assays of enzymatic activity in cell extracts.

To minimize dish-to-dish variation in transfection efficiency, it is best to (i) transfect several dishes with each construct, (ii) trypsinize the cells after 24 hours of incubation, (iii) pool them, and (iv) replat them on several dishes.

# Protocol 5

---

## DNA Transfection by Electroporation

**P**ULSED ELECTRICAL FIELDS CAN BE USED TO INTRODUCE DNA into a variety of animal cells (Neumann et al. 1982; Wong and Neumann 1982; Potter et al. 1984; Sugden et al. 1985; Toneguzzo et al. 1986; Tur-Kaspa et al. 1986), plant cells (Fromm et al. 1985, 1986; Ecker and Davis 1986), and bacteria. Electroporation works well with cell lines that are refractive to other techniques, such as calcium phosphate–DNA coprecipitation. But, as with other transfection methods, the optimal conditions for electroporating DNA into untested cell lines must be determined empirically.

The efficiency of transfection by electroporation is influenced by a number of factors as described below.

- **Strength of the applied electric field.** At low voltage, the plasma membranes of cultured cells are not sufficiently altered to allow passage of DNA molecules; at higher voltage, the cells are irreversibly damaged. For most lines of mammalian cells, the maximal level of transient expression is reached when voltages between 250 V/cm and 750 V/cm are applied. Typically, between 20% and 50% of the cells survive this treatment (as measured by exclusion of trypan blue [Patterson 1979; Baum et al. 1994]).
- **Length of the electric pulse.** Usually, a single electric pulse is passed through the cells. The length, field shape, and strength of the pulse are determined by the capacitance of the power supply and the dimensions of the cuvette. Some electroporation devices grant the investigator control over the characteristics of the pulse; others do not. The optimal length of the electric pulse required for electroporation is 20–100 msec.
- **Temperature.** Some investigators report that maximal levels of transient expression are obtained when the cells are maintained at room temperature during electroporation (Chu et al. 1987); others have obtained better results when the cells are maintained at 0°C (Reiss et al. 1986). These discrepancies may result from differences in the responses of various types of mammalian cells to the passage of electric current or in the amount of heat generated during electroporation when large electrical voltages (>1000 V/cm) and/or extended electric pulses (>100 msec) are used. The efficiency of transient expression is increased if the cells are incubated for 1–2 minutes in the electroporation chamber after exposure to the electric pulse (Rabussay et al. 1987).

- **Conformation and concentration of DNA.** Although both linear and circular DNAs can be transfected by electroporation, higher levels of both transient expression and stable transformation are obtained when linear DNA is used (Neumann et al. 1982; Potter et al. 1984; Toneguzzo et al. 1986). Effective transfection has been obtained with concentrations of DNA ranging from 1  $\mu\text{g}/\text{ml}$  to 40  $\mu\text{g}/\text{ml}$ .
- **Ionic composition of the medium.** The efficiency of transfection is manyfold higher when the cells are suspended in buffered salt solutions (e.g., HEPES-buffered saline) rather than in buffered solutions of nonionic substances such as mannitol or sucrose (Rabussay et al. 1987).

A number of different electroporation instruments are available commercially, and the manufacturers supply detailed protocols for their use. The following method is adapted from a protocol provided by Jennifer Cuthbert and Rhonda Bassel-Duby (University of Texas Southwestern Medical Center, Dallas) and from Baum et al. (1994).

For a review of methods for the introduction of DNA molecules into eukaryotic cells by electroporation, please see Andreason and Evans (1988); for a discussion of the use of electroporation to introduce DNA into bacterial cells, please see Chapter 1, Protocol 26; and for further information on the mechanism of electroporation and optimization, please see the information panel on ELECTROPORATION.

## MATERIALS

---

**CAUTION:** Please see Appendix 12 for appropriate handling of materials marked with <!>.

### Buffers and Solutions

Please see Appendix 1 for components of stock solutions, buffers, and reagents.  
Dilute stock solutions to the appropriate concentrations.

*Giemsa stain (10% w/v)*

The Giemsa stain should be freshly prepared in phosphate-buffered saline or  $\text{H}_2\text{O}$  and filtered through Whatman No. 1 filter paper before use.

*Methanol <!>*

*Phosphate-buffered saline (PBS)*

Sterilize the solution by filtration before use and store it at room temperature.

*Sodium butyrate (500 mM) (optional)*

In a chemical fume hood, bring an aliquot of stock butyric acid solution to a pH of 7.0 with 10 N NaOH. Sterilize the solution by passing it through a 0.22- $\mu\text{m}$  filter; store the filtrate at  $-20^\circ\text{C}$ .

### Nucleic Acids and Oligonucleotides

*Carrier DNA (10 mg/ml; e.g., sonicated salmon sperm DNA) (optional)*

*Linearized or circular plasmid DNA (1  $\mu\text{g}/\mu\text{l}$  in sterile deionized  $\text{H}_2\text{O}$ )*

### Media

*Cell culture growth medium (complete and [optional] selective)*

### Centrifuges and Rotors

*Sorvall H1000B rotor or equivalent*

## Special Equipment

### *Electroporation device and cuvettes*

Gene Pulser II (Bio-Rad Cat. no. 165-2105 for 110-V U.S. Systems and Cat. no. 165-2106 for 220-V European Systems).

### *Tissue culture dishes (35-mm)*

This protocol is designed for cells grown in 35-mm culture dishes. If multiwell plates, flasks, or dishes of a different diameter are used, scale the cell density and reagent volumes accordingly. Please see Table 16-3.

## Additional Reagents

*Step 10 of this protocol may require the reagents listed in Chapter 17, Protocol 7, or in the additional protocol in Protocol 1.*

## Cells and Tissues

*Exponentially growing cultures of mammalian cells*

## METHOD

---

1. Harvest the cells to be transfected from cultures in the mid- to late-logarithmic phase of growth. Use either a rubber policeman or trypsin to release adherent cells. Centrifuge at 500g (1500 rpm in a Sorvall H1000B rotor) for 5 minutes at 4°C.
2. Resuspend the cell pellet in 0.5x volume of the original growth medium and measure the cell number using a hemocytometer (please see Appendix 8).
3. Collect the cells by centrifugation as described in Step 1, and resuspend them in growth medium or phosphate-buffered saline at room temperature at a concentration of  $2.5 \times 10^6$  to  $2.5 \times 10^7$  cells/ml.
4. Transfer 400- $\mu$ l aliquots of the cell suspension ( $10^6$  to  $10^7$  cells) into as many labeled electroporation cuvettes as needed. Place the loaded cuvettes on ice.
5. Set the parameters on the electroporation device. A typical capacitance value is 1050  $\mu$ F. Voltages range from 200 to 350 V, depending on the cell line, but generally average 260 V. Use an infinite internal resistance value. Discharge a blank cuvette containing phosphate-buffered saline at least twice before beginning electroporation of cells.
6. Add 10–30  $\mu$ g of plasmid DNA in a volume of up to 40  $\mu$ l to each cuvette containing cells. (Some investigators add carrier DNA [e.g., salmon sperm DNA] to bring the total amount of DNA to 120  $\mu$ g.) Gently mix the cells and DNA by pipetting the solution up and down. Proceed to Step 7 without delay.  
**▲ IMPORTANT** Do not introduce air bubbles into the suspension during the mixing step.
7. Immediately transfer the cuvette to the electroporator and discharge the device. After 1–2 minutes, remove the cuvette, place it on ice, and proceed immediately to the next step.

8. Transfer the electroporated cells to a 35-mm culture dish using a micropipettor equipped with a sterile tip. Rinse out the cuvette with a fresh aliquot of growth medium, and add the washings to the culture dish. Transfer the dish to a humidified incubator at 37°C with an atmosphere of 5–7% CO<sub>2</sub>.

To incorporate a sodium butyrate shock (please see Protocol 2, Step 5), rinse the cuvette with growth medium containing an appropriate amount of sodium butyrate, and combine the rinse with the electroporated cells in the dish before its transfer to an incubator. After 24 hours, remove butyrate-containing medium and replace with normal growth medium.
9. Repeat Steps 6–8 until all of the DNA cell samples in cuvettes are shocked. Record the actual pulse time for each cuvette to facilitate comparisons between experiments.
10. If the objective is stable transformation of the cells, proceed directly to Step 11. For transient expression, examine the cells 24–96 hours after electroporation using one of the following assays:
  - If a plasmid DNA expressing *E. coli* β-galactosidase was used, follow the steps outlined in Chapter 17, Protocol 7 to measure enzyme activity in cell lysates. Alternatively, carry out a histochemical staining assay as detailed in the additional protocol in Protocol 1.
  - If a green fluorescence protein expression vector was used, examine the cells with a microscope under 450–490-nm illumination.
  - For other gene products, analyze the newly synthesized protein by radioimmunoassay, by immunoblotting, by immunoprecipitation following *in vivo* metabolic labeling, or by assays of appropriate enzymatic activity in cell extracts.

To minimize dish-to-dish variation in transfection efficiency, it is best to (i) transfect several dishes with each construct, (ii) trypsinize the cells after 24 hours of incubation, (iii) pool the cells, and (iv) replat them on several dishes.
11. To isolate stable transfectants: After incubation for 48–72 hours in complete medium, trypsinize the cells and replat them in the appropriate selective medium. The selective medium should be changed every 2–4 days for 2–3 weeks to remove the debris of dead cells and to allow colonies of resistant cells to grow. Thereafter, clone individual colonies and propagate for assay (for methods, please see Jakoby and Pastan 1979 or Spector et al. 1998b [Chapter 86 in *Cells: A Laboratory Manual*]).

A permanent record of the numbers of colonies may be obtained by fixing the remaining cells with ice-cold methanol for 15 minutes, followed by staining with 10% Giemsa for 15 minutes at room temperature before rinsing in tap water. The Giemsa stain should be freshly prepared in phosphate-buffered saline or H<sub>2</sub>O and filtered through Whatman No. 1 filter paper before use.

# Protocol 6

---

## DNA Transfection by Biolistics

**D**ESPITE THE MYRIAD AND INGENIOUS METHODS developed to introduce cloned DNAs into cells, some cell types, tissues, and intracellular organelles remain impermeable to foreign DNA. This problem, which is particularly acute with plant cells, was solved to a large degree with the invention of the “gene gun” by John Sanford, Ed Wolf, and their colleagues at Cornell University. The gene gun was of greatest interest to plant geneticists, whose attempts to introduce DNA into plant cells by conventional methods had been frustratingly inefficient. The gun solved the problem by the crude but efficient strategy of drilling holes through the thick cell walls with DNA-coated metal particles. Despite the initial enormous skepticism of other scientists, Sanford and Wolf published papers on the subject (Klein et al. 1987; Shark et al. 1991; Smith et al. 1992; Sanford et al. 1993), obtained patents on the gene gun and its uses as an instrument to deliver DNA to cells, and formed a company with the apt name of Biolistics, Inc. This method has revolutionized plant genetics: Most of the world’s transgenic crops have been produced using biolistic technology. The travails of Sanford and Wolf and the scientific and commercial rewards of their work are beautifully described by Sanford in a publication available from his philanthropic organization (Feed My Sheep Foundation, Waterloo, New York).

The efficiency with which foreign DNA is introduced into cells by biolistic transformation depends on a large number of variables, including:

- **Cell type.** Cells ranging from bacteria to plants to hepatocytes within the livers of living rodents have been successfully shot with DNA-coated microprojectiles. In each case, the conditions that produced a successful experiment were different.
- **Cell growth.** The density at which cultured cells are bombarded affects the transfection frequency, with greater efficiency realized at low cell density in some cases (e.g., when introducing DNA into intracellular organelles) and at high cell density in others (e.g., when cells of *Bacillus megaterium* are the target). Some cells are best transfected while in the early log phase of their growth cycle, whereas others succumb after being grown to saturation.
- **Culture medium.** The efficiencies with which many bacterial and plant cells can be transfected by biolistic methods can be increased considerably by bombarding the cells in a medium of high osmolarity. Agents such as sorbitol and/or mannitol in concentrations ranging from 0.05 to 1.5 M are used, with the optimum osmoticum and concentration differing between species and cell type.
- **Gene gun settings.** Important parameters include the amount of vacuum applied to the shooting chamber, the helium pressure used to drive the DNA-coated particles, and the distance between the gun and the target cells.



- **Type of ammunition.** Blasting subcellular organelles with inappropriately large-diameter gold or tungsten particles produces only a mess. The optimum particle size for each application differs between cell types and ranges from 0.6  $\mu\text{m}$  for subcellular organelles to 1.6  $\mu\text{m}$  for cultured mammalian cells. Particles made of tungsten or gold are used to deliver the DNA to cells and each metal has its idiosyncrasies. Tungsten particles are irregular in size and some cells are sensitive to the toxic effects of this transition metal. Tungsten is also susceptible to oxidation, which promotes the degradation of DNA. Gold is less toxic and more malleable and consequently can be shaped into particles that are more uniform in diameter. However, gold binds DNA less efficiently and is more expensive than tungsten.

As with many other methods of transfection, the bewildering array of variables that affect the efficiency of biolistic transformation requires that the optimum conditions for gene delivery be determined empirically in each laboratory and for each cell type. Optimization is best achieved by applying a matrix of variables in the initial series of experiments as described by Sanford et al. (1993). From these results, a reproducible method of biolistic transformation can be established for experimental purposes. The following protocol is an amalgam derived from Horch et al. (1999), Sanford et al. (1993), publications from the principal gene gun manufacturer (US/EG Bulletins 1688 and 2087; Bio-Rad), and a method contributed by Steve Finkbeiner (University of California, San Francisco).

## MATERIALS

---

### Buffers and Solutions

**Please see Appendix 1 for components of stock solutions, buffers, and reagents. Dilute stock solutions to the appropriate concentrations.**

*CaCl<sub>2</sub> (2.5 M)*

*Ethanol*

Use a fresh bottle of absolute ethanol that has not been opened previously. Ethanol is hygroscopic and with exposure to air picks up small amounts of water. In the method described below, the presence of water in the ethanol washes of Steps 1, 2, and 3 can interfere with effective bombardment of cells and tissues.

*Glycerol (50% in H<sub>2</sub>O)*

Sterilize the solution by autoclaving.

*Spermidine (0.1 M)*

Dissolve an appropriate amount of spermidine (free-base form) in deionized H<sub>2</sub>O and sterilize the solution by passing it through a 0.22- $\mu\text{m}$  filter. Store the solution in small aliquots at  $-20^{\circ}\text{C}$ . Make a fresh stock solution of this reagent every month.

### Nucleic Acids and Oligonucleotides

*Plasmid DNA*

When carrying out a gene gun experiment for the first time or if a new cell line or tissue is to be transfected, obtain an expression plasmid encoding an appropriate marker gene for use in optimizing delivery. Examples include vectors that express *E. coli*  $\beta$ -galactosidase, green fluorescent protein, and  $\beta$ -glucuronidase (for plants) or selectable markers such as neomycin resistance. Plasmids expressing a gene or cDNA of interest can be used after the process has been optimized.

Investigators debate whether plasmid DNAs purified on various chromatographic resins (please see Chapter 1, Protocol 9), which contain varying amounts of lipopolysaccharide, can be used in biolistic gene delivery. Apparently, even minor contamination of the plasmid DNA with endotoxin/ lipopolysaccharide reduces the frequency of transfection. We thus recommend purification of plasmid DNAs by CsCl-ethidium bromide centrifugation (Chapter 1, Protocol 10). Dissolve the purified plasmid DNA in H<sub>2</sub>O at a concentration of 1  $\mu\text{g}/\mu\text{l}$ .

## Media

*Cell culture growth medium (complete and [optional] selective)*

## Special Equipment

### *Gene gun*

A popular model is the Biolistic PDS-1000/He Particle Delivery System, sold by Bio-Rad, which includes a bombardment chamber with separate connections for vacuum and helium lines. A pump capable of pulling a vacuum of 5 inches of mercury is required. In general, house vacuum lines are unsuitable for this task. A high-pressure (2400–2600 psi) tank of helium gas (>99.999% pure) that is safely anchored to the bench or wall should be connected to the device.

### *Gold or tungsten particles (microcarriers)*

The DNA to be transfected is delivered to cells on tungsten or gold particles that vary in diameter from 0.6 to 5  $\mu\text{m}$ . The optimum pellet diameter for a given cell or tissue type must be determined empirically. The beads are purchased from commercial sources (e.g., Bio-Rad and Sylvania) and prepared for DNA coating as described in Step 1.

### *Lens paper*

### *Microfuge tubes (1.5 ml)*

Use high-quality microfuge tubes. Some brands or batches of microfuge tubes bind excessive amounts of the colloidal particles used as ammunition for gene gun experiments.

## Additional Reagents

*Step 8 of this protocol may require the reagents listed in Chapter 17, Protocol 7.*

## Cells and Tissues

### *Cells or tissue to be transfected*

Adherent cultured cells from various species should be bombarded at 50–80% confluency. Collect plant cells grown in suspension by sterile filtration onto Whatman No. 1 filter papers (7-cm diameter) using a Buchner funnel, and place them on sterile filter papers soaked with culture medium of high osmolarity before bombardment (for details, please see Sanford et al. 1993).

Freshly dissect the mammalian tissue, section at  $\sim 400 \mu\text{m}$ , and maintain the slices in culture dishes as described by McAllister et al. (1995).

Culture bacteria and yeast to mid- to late-logarithmic growth depending on the species and strain, collect by centrifugation, resuspend in a small volume of culture medium of high osmolarity, and plate ( $1 \times 10^8$  to  $2 \times 10^9$  cells) on a thin layer of agar atop a piece of filter paper in a Petri dish before being shot.

## METHOD

---

1. Prepare tungsten or gold particles.
  - a. Weigh 60 mg of gold or tungsten particles into a 1.5-ml microfuge tube.
  - b. Add 1 ml of 70% ethanol to the particles and vortex the tube continuously for 5 minutes at room temperature. Store the tube on the bench top for 15 minutes.
  - c. Collect the particles by centrifugation at maximum speed for 5 seconds in a microfuge.
  - d. Gently remove the supernatant. Resuspend the metal particles in 1-ml of sterile  $\text{H}_2\text{O}$  and vortex the suspension for 1 minute. Store the tube on the bench top for 1 minute.
  - e. Collect the metal particles by centrifugation at maximum speed for 5 seconds in a microfuge.

- f. Repeat the  $H_2O$  wash (Steps d and e) three more times.
  - g. Remove the supernatant after the fourth  $H_2O$  wash. Resuspend the particles in 1 ml of sterile 50% glycerol.

The washed particles are assumed to have a concentration of 60 mg/ml and may be stored at room temperature for 1–2 weeks. Longer storage can result in oxidation of the metal beads and a decline in transfection efficiency.
2. For every six dishes of cells or slices of tissue to be shot, prepare an aliquot of DNA-coated particles as follows:
  - a. While continuously vortexing the stock solution of microcarrier particles, remove a 50- $\mu$ l aliquot (~3 mg).
  - b. Transfer the aliquot to a fresh microfuge tube, and while vortexing, add the following to the tube:

plasmid DNA (~2.5 $\mu$ g)	2.5 $\mu$ l
2.5 M $CaCl_2$	50 $\mu$ l
0.1 M spermidine	20 $\mu$ l

After all ingredients are added, continue vortexing the tube for an additional 3 minutes.  
It is very important that the microfuge tube be continuously vortexed during this procedure to ensure uniform coating of the particles with plasmid DNA.
  - c. Stand the tube on the bench for 1 minute to allow the particles to settle, and then collect them by centrifugation at maximum speed for 2 seconds in a microfuge.

Longer centrifugation times can cause agglomeration of the metal particles, reducing transfection efficiency.
  - d. Remove the supernatant and carefully layer 140  $\mu$ l of 70% ethanol over the pelleted particles. Remove the 70% ethanol, and add 140  $\mu$ l of 100% ethanol, again without disturbing the particles. Remove the supernatant and replace with 50  $\mu$ l of ethanol.
  - e. Resuspend the particle pellet by tapping the side of the tube, followed by gentle vortexing for 2–3 seconds.
3. Place a macrocarrier in the metal holder of the gene gun apparatus using the seating device supplied by the manufacturer. Wash the sheet twice with 6- $\mu$ l aliquots of ethanol. Between washes, blot the sheet dry with lens paper.
4. Vortex the pellet sample from Step 2e for 1 minute. While vortexing, withdraw 6  $\mu$ l of the pellet slurry (~500  $\mu$ g of particles) and, as quickly as possible, spread the aliquot around the central 1 cm of the macrocarrier.
5. Repeat Steps 3 and 4 until the desired number of loaded macrocarriers has been prepared. Allow the ethanol solution containing the DNA-coated particles to dry on the macrocarrier.
6. Load a macrocarrier into the gene gun, and following the manufacturer's directions, shoot a plate of cells or tissue slice.
7. After the vacuum has returned to atmospheric pressure, remove the wounded cells or tissue and place in appropriate culture conditions. Remove the ruptured macrocarrier and repeat Steps 6 and 7 until all plates are shot.

8. If the objective is stable transformation of the cells, proceed directly to Step 9. For transient expression, examine the cells 24–96 hours after shooting, using one of the following assays.
  - If a plasmid DNA expressing *E. coli*  $\beta$ -galactosidase was used, follow the steps outlined in Chapter 17, Protocol 7, to measure enzyme activity in cell lysates. Alternatively, carry out a histochemical staining assay as detailed in the additional protocol in Protocol 1 of this chapter.
  - If a green fluorescence protein expression vector was used, examine the cells with a microscope under 450–490-nm illumination.
  - If a plasmid DNA expressing  $\beta$ -glucuronidase was used, assay for  $\beta$ -glucuronidase activity as detailed in the panel on **ADDITIONAL PROTOCOL: HISTOCHEMICAL STAINING OF CELL MONOLAYERS OR TISSUE FOR  $\beta$ -GLUCURONIDASE**.
  - For other gene products, analyze the newly synthesized protein by radioimmunoassay, by immunoblotting, by immunoprecipitation following *in vivo* metabolic labeling, or by assays of appropriate enzymatic activity in cell extracts.
    - To minimize dish-to-dish variation in transfection efficiency, it is best to (i) transfect several dishes with each construct, (ii) trypsinize the cells after 24 hours of incubation, (iii) pool the cells, and (iv) replat them on several dishes.
9. To isolate stable transfectants: After the cells have incubated for 48–72 hours in complete medium, transfer the bombarded cells to selective medium. The concentration of selective agent and the culture conditions will vary depending on the cell type.

**ADDITIONAL PROTOCOL: HISTOCHEMICAL STAINING OF CELL MONOLAYERS OR TISSUE FOR  $\beta$ -GLUCURONIDASE**

$\beta$ -glucuronidase is often used as a reporter gene in transfected plant cells because the endogenous levels of this hydrolase are very low. The enzyme cleaves many  $\beta$ -glucuronide linkages with high efficiency, including those  $\beta$ -glucuronidases conjugated with fluorescent and histochemical tags that are readily visualized within cells or lysates. This protocol was adapted from Jefferson et al. (1987).

**CAUTION:** Please see Appendix 12 for appropriate handling of materials marked with <!>.

**Additional Materials**

Formaldehyde (0.3% v/v) <!>

X-GlcA solution

- 10 mM EDTA (pH 8.0)
- 100 mM sodium phosphate
- 0.5 mM potassium ferrocyanide <!>
- 0.1% (v/v) Triton X-100
- 0.5 mg/ml X-GlcA (5-bromo-4-chloro-3-indolyl- $\beta$ -D-glucuronide)

Dissolve an appropriate amount of X-GlcA (Sigma) in a small volume of DMSO before adding it to the buffer.

Mannitol (0.3 M)

MES (10 mM, pH 5.6)

$\text{NaH}_2\text{PO}_4$  (50 mM)

**Method**

1. Remove the medium in which the plant cells or tissue are maintained and replace with just enough X-GlcA solution to cover the biological material.

With some plant tissues, the intensity of  $\beta$ -glucuronidase staining can be enhanced by fixing the tissue before addition of the X-GlcA solution. Incubate the section in 0.3% (v/v) formaldehyde/10 mM MES (pH 5.6)/0.3 M mannitol for 30–60 minutes, rinse the section several times with 50 mM  $\text{NaH}_2\text{PO}_4$ , and then cover it with X-GlcA staining solution.

2. Incubate the plates for 12–24 hours at 37°C.
3. Examine the bombarded cells under a light microscope and count the number of blue cells or blue clusters of cells. Cells that have taken up the  $\beta$ -glucuronidase expression plasmid and are synthesizing the enzyme should be a dark blue.

The number of blue spots per dish can be considered to be at best a semiquantitative estimate of transfection efficiency. This number is most useful in determining the optimum conditions for gene bombardment experiments and should not be taken as a quantitative readout of gene expression. If a quantitative measurement of gene expression is needed, then it is best to establish an *in vitro* biochemical assay using a fluorescent  $\beta$ -glucuronidase substrate and cell lysates prepared from transfected cells or tissue slices. For a detailed description of this type of assay, please see Jefferson et al. (1987).

# Protocol 7

---

## DNA Transfection Using Polybrene

**S**EVERAL POLYCATIONS, INCLUDING POLYBRENE (1,5-dimethyl-1,5-diazaundecamethylene polymethobromide) (Kawai and Nishizawa 1984; Chaney et al. 1986) and poly-L-ornithine (Bond and Wold 1987; Dong et al. 1993; Nead and McCance 1995), have been used in the presence of DMSO to facilitate DNA transfection of cells that are insensitive to transfection by other methods.

Variables that influence the efficiency of transfection by Polybrene are the concentrations of DMSO and polycation, the amount of DNA, the temperature of incubation with DMSO, and the length of time the cells are left in contact with the polycation-DNA mixture (Bond and Wold 1987; Aubin et al. 1988; Nead and McCance 1995). The original protocol, which was developed using chicken embryo fibroblasts, had optimal levels of transfection with 30% DMSO and 30  $\mu$ g of Polybrene. Optimal transfection into other cell lines requires different amounts of these reagents.

- Permanent transfection of human epidermal keratinocytes using Polybrene was found to be optimal after a 27% DMSO shock (Jiang et al. 1991).
- Murine NIH-3T3 cells required 15% DMSO (Aubin et al. 1988, 1997) for stable transfection, but 25% DMSO for optimal transient transfection.
- Human keratinocytes were transfected using 12  $\mu$ g/ml poly-L-ornithine during a 6-hour incubation followed by a 4-minute shock with 25% DMSO (Nead and McCance 1995).

The mechanism by which DMSO enhances the uptake of DNA is not known, but may involve a combination of permeabilization of the cell membrane and the osmotic shock. In some experiments using Polybrene (e.g., please see Ogawa et al. 1988), DMSO has been replaced by solutions containing 5–7% NaCl. DNA toxicity is generally not a problem in the Polybrene method of transfection. However, the linear relationship between DNA concentration and transformation efficiency breaks down when using very high concentrations of DNA (Kawai and Nishizawa 1984).

The method outlined below using Polybrene and DMSO was adapted from Aubin et al. (1997). This procedure works efficiently for stable transformation of Chinese hamster ovary and keratinocyte cells by plasmid DNA, yielding ~15-fold more transformants than calcium phosphate-DNA coprecipitation. However, there is no difference between the two methods in the efficiency of transformation of cells by high-molecular-weight DNA.

## MATERIALS

---

**CAUTION:** Please see Appendix 12 for appropriate handling of materials marked with <!>.

### Buffers and Solutions

Please see Appendix 1 for components of stock solutions, buffers, and reagents. Dilute stock solutions to the appropriate concentrations.

*DMSO (30%) in serum-containing medium <!>*

Dilute high-performance liquid chromatography (HPLC)-grade or tissue-culture-grade DMSO to a final concentration of 30% (v/v) in the cell growth medium containing serum just before use in Step 3.

*Giemsa stain (10% w/v)*

The Giemsa stain should be freshly prepared in phosphate-buffered saline or H<sub>2</sub>O and filtered through Whatman No. 1 filter paper before use.

*Methanol <!>*

*Polybrene (10 mg/ml)*

Dissolve Polybrene (Aldrich) at a concentration of 10 mg/ml in H<sub>2</sub>O and sterilize the solution by passing it through a 0.22- $\mu$ m filter. Store the solution as small aliquots (0.25-ml) at -20°C until needed. Discard aliquots after use.

*Sodium butyrate (500 mM) (optional)*

In a chemical fume hood, bring an aliquot of stock butyric acid solution to a pH of 7.0 with 10 N NaOH. Sterilize the solution by passing it through a 0.22- $\mu$ m filter. Store the filtrate in 1-ml aliquots at -20°C.

### Nucleic Acids and Oligonucleotides

*DNA to be transformed, e.g., plasmid DNA (1  $\mu$ g/ $\mu$ l) in H<sub>2</sub>O*

### Media

*Minimum essential medium (MEM)- $\alpha$  (containing 10% fetal calf serum, serum-free, and [optional] selective agents)*

### Special Equipment

*Tissue culture dishes (90-mm)*

This protocol is designed for cells grown in 90-mm culture dishes. If multiwell plates, flasks, or dishes of a different diameter are used, scale the cell density and reagent volumes accordingly. Please see Table 16-3.

### Additional Reagents

*Step 6 of this protocol may require the reagents listed in Chapter 17, Protocol 7, or in the additional protocol in Protocol 1.*

### Cells and Tissues

*Exponentially growing cultures of mammalian cells*

## METHOD

---

1. Harvest exponentially growing cells (e.g., CHO cells) by trypsinization, and replate them at a density of  $5 \times 10^5$  cells per 90-mm tissue culture dish in 10 ml of MEM- $\alpha$  containing 10% fetal calf serum. Incubate the cultures for 18–20 hours at 37°C in a humidified incubator in an atmosphere of 5–7% CO<sub>2</sub>.

2. Replace the medium with 3 ml of warmed (37°C) medium containing serum, DNA (5 ng to 40 µg; no carrier DNA), and 30 µg of Polybrene. Mix the DNA with the medium before adding the 10 mg/ml Polybrene. Return the cells to the incubator for 6–16 hours. Gently rock the dishes every 90 minutes during the early stages of this incubation to ensure even exposure of the cells to the DNA-Polybrene mixture.
3. Remove the medium containing the DNA and Polybrene by aspiration. Add 5 ml of 30% DMSO in serum-containing medium. Gently swirl the DMSO medium around the dish to ensure even exposure of the cells to the solvent and place the dishes in the incubator.
4. After 4 minutes of incubation, remove the dishes from the incubator and immediately aspirate the DMSO solution. Wash the cells once or twice with warmed (37°C) serum-free medium, and add 10 ml of complete medium containing 10% fetal calf serum. If a sodium butyrate boost is to be included, then proceed to Step 5. If not, incubate the cultures for 48 hours at 37°C in a humidified incubator with an atmosphere of 5–7% CO<sub>2</sub>. Then proceed directly to either Step 6 (to assay for transient expression) or Step 7 (to establish stable transformants).

Cells treated with DMSO are prone to detach from the dish. For this reason, the washing steps to remove the solvent-containing medium and the additions of fresh medium should be done as gently as possible, e.g., by slowly pipetting the medium against the side of the dish with each change.

5. (*Optional*) To facilitate the transfection of cells treated with DMSO and Polybrene:
  - a. Add 500 mM sodium butyrate directly to the growth medium to a final concentration of 2.5–10 mM.  
The exact concentration of sodium butyrate added depends on the cell type and must be determined empirically.
  - b. Incubate the cells for 20–24 hours at 37°C in a humidified incubator with an atmosphere of 5–7% CO<sub>2</sub>.
  - c. Remove the medium containing sodium butyrate, and replace it with butyrate-free medium containing 10% fetal bovine serum. Return the cells to the incubator.  
Sodium butyrate treatment of DMSO-permeabilized cells can enhance the transient (but not permanent) expression from certain recombinant plasmids (Aubin et al. 1997), especially those carrying the SV40 early promoter/enhancer, in simian and human cells (Gorman et al. 1983a).
6. If the objective is stable transformation of the cells, proceed directly to Step 7. For transient expression, examine the cells 1–2 days after transfection using one of the following assays:
  - If a plasmid DNA expressing *E. coli* β-galactosidase was used, follow the steps outlined in Chapter 17, Protocol 7, to measure enzyme activity in cell lysates. Alternatively, carry out a histochemical staining assay as detailed in the additional protocol in Protocol 1.
  - If a green fluorescence protein expression vector was used, examine the cells with a microscope under 450–490-nm illumination.
  - For other gene products, analyze the newly synthesized protein by radioimmunoassay, by immunoblotting, by immunoprecipitation following *in vivo* metabolic labeling, or by assays of enzymatic activity in cell extracts.

To minimize dish-to-dish variation in transfection efficiency, it is best to (i) transfect several dishes with each construct, (ii) trypsinize the cells after 24 hours of incubation, (iii) pool the cells, and (iv) replat them on several dishes.



7. To isolate stable transfectants: After the cells have incubated for 48 hours in nonselective medium (to allow expression of the transferred gene[s] to occur [Step 4]), either trypsinize or replat the cells in the appropriate selective medium or add the selective medium directly to the cells without further manipulation. Change this medium every 2–4 days for 2–3 weeks to remove the debris of dead cells and to allow colonies of resistant cells to grow.
8. Thereafter, clone individual colonies and propagate for assay (for methods, please see Jakoby and Pastan 1979 or Spector et al. 1998b [Chapter 86 of *Cells: A Laboratory Manual*]).

A permanent record of the numbers of colonies may be obtained by fixing the remaining cells with ice-cold methanol for 15 minutes, followed by staining with 10% Giemsa for 15 minutes at room temperature before rinsing in tap water. The Giemsa stain should be freshly prepared in phosphate-buffered saline or H<sub>2</sub>O and filtered through Whatman No. 1 filter paper before use.

## COTRANSFORMATION

Analysis of function and expression of transfected genes may require the stable integration of the transfected DNA into the host chromosome. After entering the cell, some of the transfected nucleic acid is transferred from the cytoplasm to the nucleus. Depending on the cell type, up to 80% of a population of cells will then express the transfected gene in a transient fashion. At some point within the first few hours after transfection, the incoming DNA undergoes a series of nonhomologous intermolecular recombination and ligation events to form a large concatemeric structure that eventually integrates into the cellular chromosome. Each transformed cell usually contains only one of these packages, which can exceed 2 Mb in size (Perucho et al. 1980). Stable cell lines can then be isolated that carry integrated copies of the transfected DNA. Transformation rates vary widely from cell type to cell type. In the best cases,  $\sim 1$  cell in  $10^3$  in the original transfected population stably expresses a gene(s) carried by the transfected DNA.

Because the uptake, integration, and expression of DNA are relatively rare events, stable transformants are usually isolated by selection of cells that have acquired a new phenotype. Typically, this phenotype is conferred by the presence in the transfection mixture of a gene encoding antibiotic resistance. Cells transfected for a genetic marker present on one piece of DNA frequently express another genetic marker that was originally carried on a separate DNA molecule. Therefore, cells that stably express selectable (e.g., antibiotic-resistant) markers are also likely to have incorporated other DNA sequences present among the carrier DNA. This phenomenon, in which physically unlinked genes are assembled into a single integrated array and expressed in the same transformed cell, is known as cotransformation.

The first gene to be used extensively for selection in mammalian cells was a viral (herpes simplex) gene encoding thymidine kinase (TK; Wigler et al. 1977). Although many mammalian cell lines express thymidine kinase, several TK<sup>-</sup> lines were created by selection for growth in the presence of 5-bromodeoxyuridine (BrdU). When transfected and stably integrated into the host genome of cell lines lacking thymidine kinase, the viral gene confers the TK<sup>+</sup> phenotype, thereby allowing growth in the presence of aminopterin (for a discussion of the basis for selection, please see the information panel on **SELECTIVE AGENTS FOR STABLE TRANSFORMATION**). Thereafter, this strategy was used to introduce foreign DNA in mammalian cells by cotransfection with a plasmid encoding the *tk* gene (Perucho et al. 1980; Robins et al. 1981). The difficulties or additional efforts involved in creating *tk*<sup>-</sup> mutants promoted the search for other selection schemes. Therefore, other possibilities for selection in cotransformation studies were explored, leading to the development of vectors that express bacterial proteins which confer drug resistance in mammalian cell lines. These selectable markers include, for example, aminoglycoside phosphotransferase (resistance to G418 or neomycin), hygromycin-B phosphotransferase (resistance to hygromycin-B), xanthine-guanine phosphoribosyltransferase (resistance to mycophenolic acid and aminopterin), and puromycin-*N*-acetyl transferase (resistance to puromycin). All have been used with considerable success to establish stably transformed lines of mammalian cells.

In addition to providing a means to introduce exogenous genes into mammalian cells in a stable manner, it is often desirable to increase the stringency of the selective conditions in order to obtain higher levels of expression of the transfected genes. This enhancement in expression can be achieved as a result of increase in copy number, or coamplification, of the target gene and the gene conferring the resistance. A target gene that has been cotransfected with (and become integrated near) a particular marker gene is highly likely to undergo amplification with the marker under selection. Thus, the amplification of the dihydrofolate reductase (*dhfr*) gene resulting from exposure to increasing levels of methotrexate has been used successfully to overexpress cotransfected foreign genes (Schimke 1984). Similarly, the gene encoding adenosine deaminase (ADA) can be amplified through the stepwise increase in concentrations of 2'-deoxycoformycin (dCF; Kaufman et al. 1986) (for further details on gene amplification, please see Stark and Wahl 1984).

For further details on the basis for selection as well as selective conditions required for these systems, please see the information panel on **SELECTIVE AGENTS FOR STABLE TRANSFORMATION**.

---

**SELECTIVE AGENTS FOR STABLE TRANSFORMATION**


---

Resistance to antibiotics has proven to be effective in selecting cotransformants and, in some cases, as a driver for gene amplification.

**Aminopterin**

- **Mode of action.** Thymidine kinase catalyzes a reaction in an alternative pathway for the synthesis of dTTP from thymidine. The enzyme is not required under normal conditions of growth, as cells typically synthesize dTTP from dCDP. However, cells grown in the presence of aminopterin (an analog of dihydrofolate) are unable to utilize the usual pathway for synthesizing dTTP, and thus require thymidine kinase to make use of the alternative pathway.
- **Selective conditions.** Cell lines lacking endogenous thymidine kinase activity are grown in a complete medium supplemented with 100  $\mu\text{M}$  hypoxanthine, 0.4  $\mu\text{M}$  aminopterin, 16  $\mu\text{M}$  thymidine, and 3  $\mu\text{M}$  glycine (HAT medium).

**G418**

- **Mode of action.** This aminoglycoside antibiotic, similar in structure to neomycin, gentamycin, and kanamycin, is the most commonly used selective agent in permanent transfection experiments. G418 and its relatives block protein synthesis through interference with ribosomal functions. The bacterial enzyme aminoglycoside phosphotransferase, carried on the transposon sequence Tn5, converts G418 to a nontoxic form.
- **Selective conditions.** Because each eukaryotic cell line demonstrates a different sensitivity to this antibiotic (and some are completely resistant to it), the optimum amount required to kill nontransfected cells must be established empirically for each new cell line or strain used for permanent transfection. This optimum is established by determining a killing curve for the cell line of interest. In this type of experiment, a plasmid conferring resistance to G418 (e.g., pSV2*neo* or pSV3*neo*; Southern and Berg 1982) is transfected into the cells, and plates of transfected cells are subjected to different concentrations of G418. After a 2–3-week selection period, the concentration of G418 giving rise to the largest number of viable colonies is determined by visual inspection, or better by actual counting of the colonies after staining with Giemsa or gentian violet.

Commercial preparations of G418 vary in their concentration of active antibiotic, with the average purity being ~50%. For this reason, each batch of G418 should be titrated before use in tissue culture. Despite this variation, the amount of G418 used to obtain optimal numbers of transfected colonies is constant for well-characterized cell lines. Table 16-5 gives the optimum G418 concentration ranges for use with several commonly used cell lines.

**TABLE 16-5 Selective G418 Concentration Ranges**

CELL LINE OR ORGANISMS	G418 CONCENTRATION ( $\mu\text{g/ml}$ )
Chinese hamster ovary cells	700–800
Madin-Darby canine kidney cells	500
Human epidermoid A431 cells	400
Simian CV-1 cells	500
<i>Dictyostelium</i>	10–35
Plant	10
Yeast	125–500

**TABLE 16-6 Selective Concentrations of Hygromycin B**

ORGANISM	INHIBITORY CONCENTRATION OF HYGROMYCIN B	REFERENCES
<i>Escherichia coli</i>	200 µg/ml	Gritz and Davies (1983)
<i>Saccharomyces cerevisiae</i>	200 µg/ml	Gritz and Davies (1983)
Mammalian cells	12–400 µg/ml, depending on the cell line	Sugden et al. (1985); Palmer et al. (1987)

**Hygromycin B <!>**

- **Mode of action.** Hygromycin B is an aminocyclitol antibiotic produced by *Streptomyces hygroscopicus* (Pittenger et al. 1953). Hygromycin B inhibits protein synthesis in both prokaryotes and eukaryotes by interfering with translocation (Cabañas et al. 1978; Gonzalez et al. 1978) and causing mistranslation in vivo and in vitro (Singh et al. 1979).  
A bacterial plasmid-borne gene has been identified and sequenced (Gritz and Davies 1983), which encodes a 341-amino-acid hygromycin-B phosphotransferase (Rao et al. 1983) that inactivates the antibiotic. This gene has been used as a selectable marker in *E. coli*, and chimeric genes constructed with the appropriate promoters act as dominant selectable markers in *Saccharomyces cerevisiae* (Gritz and Davies 1983; Kaster et al. 1984), mammalian cells (Santerre et al. 1984; Sugden et al. 1985), and plants (van den Elzen 1985; Waldron et al. 1985).
- **Selective conditions.** The concentrations of antibiotic required to inhibit growth of various organisms are presented in Table 16-6.

**Methotrexate (MTX) <!>**

- **Mode of action.** An analog of dihydrofolate, methotrexate is a powerful inhibitor of dihydrofolate reductase (DHFR), an enzyme required for purine biosynthesis. Increasing levels of methotrexate can result in amplification of the gene encoding DHFR with concomitant increase in its levels of expression. The system is therefore extremely effective for amplification of cotransfected genes (Simonsen and Levinson 1983).
- **Selective conditions.** The medium is typically supplemented with 0.01–300 µM methotrexate.

**Mycophenolic Acid**

- **Mode of action.** Mycophenolic acid, a weak dibasic acid with antibiotic properties, specifically inhibits inosinate (IMP) dehydrogenase, an enzyme of mammalian cells that converts IMP to xanthine monophosphate (XMP). This block to synthesis of guanosine monophosphate (GMP) can be relieved by supplying cells with xanthine and a functional *E. coli gpt* gene, which encodes an enzyme, xanthine-guanine phosphoribosyltransferase, that converts xanthine to XMP. *E. coli gpt* can therefore be used in the presence of mycophenolic acid as a dominant selectable marker for cotransformation of mammalian cells of any type (Mulligan and Berg 1981a,b). The selection can be made more efficient by the addition of aminopterin, which blocks the endogenous pathway of purine biosynthesis (for further details, please see Gorman et al. 1983b).
- **Selective conditions.** The concentration of antibiotic required to inhibit growth in mammalian cells is ~25 µg/ml.

**Puromycin**

- **Mode of action.** Puromycin, acting as an analog of aminoacyl tRNA, inhibits protein synthesis by causing premature chain termination. The antibiotic becomes acetylated, and thereby inactivated, by the action of puromycin-*N*-actyl transferase (de la Luna et al. 1988).
- **Selective conditions.** The concentrations of antibiotic required to inhibit growth of mammalian cell lines is typically in the range of 0.5–10 µg/ml; many transformed cell lines are effectively selected at 2 µg/ml.

## LIPOFECTION

Lipofection is the generic name of a set of techniques used to introduce exogenous DNAs into cultured mammalian cells. Many variants of the basic method have been developed, but they all adhere to the same general principle: The DNA to be transfected is coated by a lipid, which either interacts directly with the plasma membrane of the cell (Bangham 1992) or is taken into the cell by nonreceptor-mediated endocytosis (Zhou and Huang 1994; Zabner et al. 1995), presumably as a prelude to membrane fusion in endosomes (Pinnaduwaage et al. 1989; Leventis and Silvius 1990; Rose et al. 1991). However, as with other transfection techniques, only a small percentage of liposomes deliver their cargo of DNA into the nucleus (Tseng et al. 1997). As judged from microscopy, most of the DNA remains associated with the membrane compartments of the cell, where it is unavailable for transport into the cytoplasm and subsequent movement to the nucleus (Zabner et al. 1995). Nevertheless, when working at its best, lipofection can deliver DNA into cells more efficiently than precipitation with polycations such as calcium phosphate and at lower cost than electroporation.

Like other transfection techniques, lipofection is not universally successful: The efficiency of both transient expression and stable transformation by exogenously added genes varies widely from cell line to cell line. Different types of cells may show a range of quantitative responses to the same lipofection protocol. Different protocols used on the same cell line may generate results that span an extensive range. However, lipofection works very well in many situations where standard methods are notoriously inefficient, for example, transfection of primary cultures or cultures of differentiated cells (e.g., please see Thompson et al. 1999) or introduction of very high-molecular-weight DNA into standard cell lines (e.g., please see Strauss 1996). Lipofection is therefore the method of choice for introducing genes into differentiated cells *in vitro* and is the technique of first resort when older methods of transfection are inadequate.

### The Chemistry of Lipofection

There are two general classes of liposomal transfection reagents: those that are anionic and those that are cationic. Transfection with anionic liposomes, which was first used in the late 1970s to deliver DNA and RNA to cells in a biologically active form, requires that the DNA be trapped in the internal aqueous space of large artificial lamellar liposomes (for reviews of this early work, please see Fraley and Papahadjopoulos 1981, 1982; Fraley et al. 1981; Straubinger and Papahadjopoulos 1983). However, the technique in its basic form never entered widespread use, perhaps because of its time-consuming nature and problems with reproducibility by investigators who were not expert in lipid chemistry.

The lipofection techniques in common use today stem from a seminal discovery by Peter Felgner that cationic lipids react spontaneously with DNA to form a unilamellar shell which can fuse with cell membranes (Felgner et al. 1987; Felgner and Ringold 1989). The formation of DNA-lipid complexes is due to ionic interactions between the head group of the lipid, which carries a strongly positive charge that neutralizes the negatively charged phosphate groups on the DNA (please see Figure 16-1).

The first generation of cationic lipids were monocationic double-chain amphiphiles with a positively charged quaternary amino head group (Duzgunes et al. 1989), linked to the lipid backbone by ether or ester linkages. Such monocationic lipids suffer from two major problems: They are toxic to many types of mammalian and insect cells, and their ability to promote transfection is restricted to a small range of cell lines (Felgner et al. 1987; Felgner and Ringold 1989). The later generations of cationic lipids are polycationic, have a far wider host range, and are considerably less toxic than their predecessors (for review, please see Gao and Huang 1993). In most cases, preparations of cationic lipids used for transfection consist of a mixture of synthetic cationic lipid and a fusogenic lipid (phosphatidylethanolamine or DOPE). Several cationic and polycationic lipids active in transfection are described in Table 16-4. Depending on the composition of the lipid mixture, the DNA to be transfected becomes incorporated either into multilamellar structures composed of alternating layers of lipid bilayer and hydrated DNA or into hexagonal columns arranged in a honeycomb structure (Labat-Moleur et al. 1996; Koltover et al. 1998). Each column or tube in the honeycomb consists of a central core of hydrated DNA molecules and a surrounding hexagonal shell of lipid monolayers. Experiments with model systems suggest that honeycomb arrangements of this type deliver DNA across lipid bilayers more efficiently than multilamellar structures.

## A Plethora of Lipofectants Is Available

The same properties of lipids that facilitate the formation of transfection-competent structures with DNA also bring unwanted side effects. Chief among these are a generalized toxicity, which is manifested by cells rounding up and detaching from the dish. In addition, lipofection is vulnerable to interference by fats and lipoproteins in serum and by charged components of the extracellular matrix such as chondroitin sulfate (Felgner and Holm 1989). Systematic modifications of the cationic and neutral lipids have been made in an effort to overcome these drawbacks (e.g., please see Behr et al. 1989; Felgner et al. 1994), resulting in a wealth of effective lipofection reagents. Unfortunately, these reagents, many of which are commercially available, work with varying efficiencies with different types of cells. Although few head-to-head comparisons of efficiency are available, the companies that market these reagents for lipofection provide useful bibliographies and lists of cell lines that can be efficiently transfected with the help of their particular products. The toxicity of these compounds varies from cell line to cell line, as does inter alia, the optimal ratio of cationic lipids:DNA and the amount of cationic lipid that can be added to a given number of cells (e.g., please see Felgner et al. 1987; Ho et al. 1991; Ponder et al. 1991; Farhood et al. 1992; Harrison et al. 1995).

## Optimizing Lipofection

In addition to the properties and chemical composition of the cationic and neutral lipids, several other variables affect the efficiency of lipofection, including:

- **Initial density of the cell culture.** Cell monolayers should be in mid-log phase and should be between 40% and 75% confluent.
- **Amount of DNA added per dish.** Depending on the concentration of the sequences of interest, as little as 50 ng and as much as 40 µg of DNA might be required to obtain maximum signal from a reporter gene.
- **Medium and serum used to grow the cells.**
- **Time of exposure of cells to the cationic lipid-DNA complex,** which varies from 0.1 to 24 hours.
- **Purity of the DNA preparation.** Wherever possible, the DNA should be dissolved in H<sub>2</sub>O rather than buffers containing EDTA. Plasmid preparations used for lipofection should be free of bacterial lipopolysaccharides and should preferably be purified by chromatography on anion exchange resins or by CsCl-ethidium bromide equilibrium density centrifugation.

All of these variables must be optimized in order to establish optimum transfection frequencies for a target cell line.

---

**TRANSFECTION OF MAMMALIAN CELLS WITH CALCIUM PHOSPHATE-DNA COPRECIPITATES**


---

DNA can be introduced into many lines of cultured mammalian cells as a coprecipitate with calcium phosphate. After entering the cell by endocytosis, some of the coprecipitate escapes from endosomes or lysosomes and enters the cytoplasm, from where it is transferred to the nucleus. Depending on the cell type, up to 50% of a population of cells then express transfected genes in a transient fashion. Transformed cell lines that carry integrated copies of the transfected DNA can also be selected, although at a much lower frequency. Transformation rates vary widely from cell type to cell type. In the best cases, ~1 cell in 10<sup>3</sup> permanently expresses a selectable marker(s) carried by the transfected DNA.

Calcium-phosphate-mediated DNA transfection was developed by Frank Graham and Alex van der Eb (1973) as a method to introduce adenovirus and SV40 DNA into adherent cultured cells. Graham and van der Eb worked out optimal conditions for the formation of calcium phosphate-DNA coprecipitates and for subsequent exposure of cells to the coprecipitate. Their work laid the foundation for the biochemical transformation of genetically marked mouse cells by cloned DNAs (Maitland and McDougall 1977; Wigler et al. 1977); for the transient expression of cloned genes in a variety of mammalian cells (e.g., please see Gorman 1985); and for the isolation and identification of cellular oncogenes, tumor-suppressing genes, and other single-copy mammalian genes (e.g., please see Wigler et al. 1978; Perucho and Wigler 1981; Weinberg 1985; Friend et al. 1988). However, Graham and van der Eb never profited financially from their discovery. That was left to Wigler, Axel, and their colleagues who in 1983 were awarded a lucrative patent for cotransformation of unlinked segments of DNA by the calcium phosphate method (please see the information panel on **COTRANSFORMATION**).

Published procedures differ widely in the manner in which calcium phosphate-DNA coprecipitates are formed prior to their addition to cells. Some methods advise against anything but the gentlest agitation and suggest, for example, that air bubbled gently from an electric pipetting device should be used to mix the DNA and the buffered solution of calcium phosphate. Other methods advocate slow mixing during addition of the DNA solution, followed by gentle vortexing. Whatever technique is chosen, the aim should be to avoid creation of coarse precipitates that are endocytosed and processed inefficiently by cells. In addition to the speed of mixing, the following are other factors that affect the efficiency of transfection:

- **Size and concentration of the DNA.** The inclusion of high-molecular-weight genomic DNA in the coprecipitate increases the efficiency of transformation by small DNAs (e.g., plasmids) (e.g., please see Chen and Okayama 1987). Soon after transfection, the small DNAs integrate in the carrier DNA, often forming an array of head-to-tail tandems. This assemblage subsequently integrates into the chromosome of the transfected cell (Perucho and Wigler 1981).
- **Exact pH of the buffer and the concentration of calcium and phosphate ions** (Jordan et al. 1996). Some investigators make up several batches of HEPES-buffered saline over the pH range 6.90–7.15 and test each batch for the quality of the calcium phosphate-DNA precipitates and for the efficiency of transformation.
- **Use of facilitators.** Increases in the efficiency of transient expression and transformation can be achieved by exposing cells to glycerol (Parker and Stark 1979), chloroquine (Luthman and Magnusson 1983), commercially available “transfection maximizers” (e.g., please see Zhang and Kain 1996), or certain inhibitors of cysteine proteases (Coonrod et al. 1997). In general, these agents are toxic to cells, and their effects on viability and transfection efficiency vary from one type of cell to another. For example, chloroquine, an amine that prevents acidification of endosomes and lysosomes and inhibits lysosomal protease cathepsin B (Wibo and Poole 1974), improves the transfection efficiency of some types of cells and decreases the efficiency of others (Chang 1994). The optimal time, length, and intensity of treatment with facilitators must therefore be determined empirically for each cell line.

The level of transient expression is determined chiefly by the intensity of transcription from the promoter and its associated *cis*-acting control elements. In specific cases, it may be possible to increase the level of expression by exposing the transfected cells to hormones, heavy metals, or other substances that activate the appropriate cellular transcription factors. In addition, expression of genes carried on plasmids that contain the SV40 enhancer can be enhanced by treating transfected simian and human cells with sodium butyrate (Gorman et al. 1983a,b). Transfection kits, which frequently include these and other modifications to the original protocol, are available from a number of companies (please see Table 16-2).

DNA transfected as a calcium phosphate coprecipitate or with DEAE-dextran as a facilitator is mutated at a high frequency (~1% per gene) in all mammalian cells examined (Calos et al. 1983; Lebkowski et al. 1984). This effect is confined to the transfected sequences and does not affect the chromosomal DNA of the host cell (Razzaque et al. 1983). The mutations, which are predominantly base substitutions and deletions, appear to occur shortly after the transfecting DNA arrives in the nucleus (Lebkowski et al. 1984). However, replication of the incoming DNA is not necessary. Because almost all of the base substitutions occur at G:C base pairs, it seems likely that the major premutational events are hydrolysis of the sugar base glycosyl bond of deoxyguanosine residues and deamination of cytosine residues. Both of these reactions occur readily at acid pH and would take place as the incoming DNA passes through endosomes, which maintain a pH of ~5 (de Duve et al. 1974). Linear DNA is especially prone to deletions (Razzaque et al. 1983; Miller et al. 1984) presumably because it serves as an attractive substrate for exonucleases. Although these mutation rates are extraordinarily high, they have little relevance to transient expression of transfected genes unless the gene of interest is large and/or has a very high content of G+C. Most of the work on mutation rates was carried out with *lacI*, which is encoded by a 750-bp segment of DNA. A gene that is 10 kb in length might therefore be expected to suffer a mutation rate of 12% or more depending on its content of G+C.

---

## CHLOROQUINE DIPHOSPHATE

---

Chloroquine (F.W. = 519.5), an amine that prevents acidification of endosomes and lysosomes and inhibits lysosomal protease cathepsin B (Wibo and Poole 1974), increases the efficiency of transfection of some types of cells and decreases the efficiency of others (Chang 1994). By inhibiting acidification of lysosomes, chloroquine may prevent or delay the degradation of transfecting DNA by lysosomal hydrolases (Luthman and Magnusson 1983). Unfortunately, the beneficial effects of chloroquine are modest and do not extend to all cell lines. In fact, although treatment with chloroquine improves the transfection efficiency of some types of cells, it decreases the efficiency of others (Chang 1994). Because the balance between the benefits and disadvantages of chloroquine varies so widely from cell line to cell line, there is simply no way to predict whether the drug will lead to a useful increase in transfection frequency in a particular circumstance. However, if low frequencies of transfection are a problem, it is certainly worth exploring whether chloroquine can help. The optimal time, length, and intensity of treatment must be determined empirically for each cell line. Typically, however, cells will be exposed to chloroquine diphosphate at a final concentration of 100  $\mu$ M for 3–5 hours either before, during, or after the cells are exposed to a calcium phosphate–DNA coprecipitate, or during exposure of cells to a mixture of DNA and DEAE-dextran. In the presence of chloroquine, the cells develop a vesicularized appearance. After the treatment, the cells are washed with phosphate-buffered saline and medium and then incubated for 24–60 hours before assaying for expression of the transfected DNA. Chloroquine diphosphate is prepared as a 100 mM stock solution (52 mg/ml in H<sub>2</sub>O), which should be sterilized by filtration and stored in foil-covered tubes at –20°C.



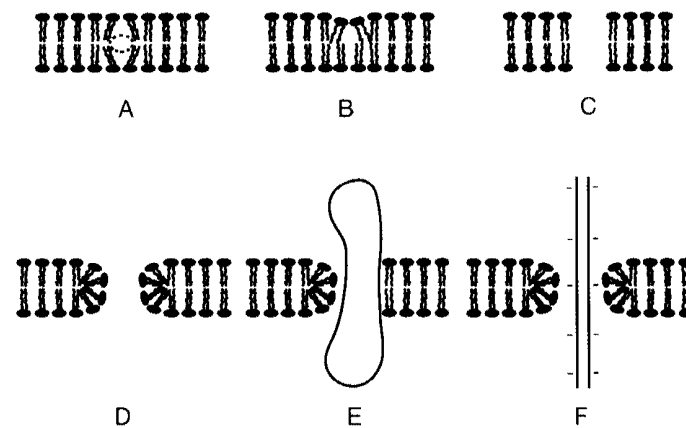
## ELECTROPORATION

Nucleic acids do not enter cells under their own power; they require assistance in crossing physical barriers at the cell boundary and in reaching an intracellular site where they can be expressed and/or replicated. Exposure of many types of cells to an electrical discharge reversibly destabilizes their membranes and transiently induces the formation of aqueous pathways or membrane pores (Neumann and Rosenheck 1972; Neumann et al. 1982; Wong and Neumann 1982; for reviews, please see Zimmermann 1982; Andreason and Evans 1988; Tsong 1991; Weaver 1993) that potentiate the entry of DNA molecules (Neumann et al. 1982). This method, which is known as *electroporation*, has been developed into a rapid, simple, and efficient technique for introducing DNA into a wide variety of cells, including bacteria, yeasts, plant cells, and a large number of cultured mammalian cell lines. The chief practical advantages of electroporation are that it can be applied to a wide variety of cells, both prokaryotic and eukaryotic, and that it is extremely simple to carry out.

### The Mechanism of Electroporation

Because the changes in membrane structure that accompany electroporation cannot be visualized in real time by microscopy, our understanding of the mechanism is based on evidence that is both patchy and circumstantial. While evidence for many of the steps is lacking, the following model (Weaver 1993) nevertheless provides a plausible account of the sequence of events that are initiated by increasing the transmembrane voltage from its physiological value of  $\sim 0.1$  to  $0.5$ – $1.0$  V. Figure 16-4 shows the following sequence of events:

- **The onset of electroporation causes a membrane dimple** followed by formation of transient hydrophobic pores whose diameter fluctuates from a minimum of 2 nm to a maximum of several nanometers.
- **Some of the larger hydrophobic pores are converted to hydrophilic pores** because the energy needed to form an aqueous pore is reduced as the transmembrane voltage is increased and the energy required to maintain the circumference of a large hydrophilic pore is significantly lower than that required to maintain a large hydrophobic pore. For this reason, hydrophilic pores have an extended half-life and may be further stabilized by attachment to underlying cytoskeletal elements. The generation of such long-lived metastable pores allows small ions and molecules to enter and leave the cell long after the transmembrane voltage has returned to low values (Rosenheck et al. 1975; Zimmermann et al. 1976; Lindner et al. 1977). The detailed mechanism by which molecules pass through hydrophilic pores is not known, but may include electrophoresis (Chermodnick et al. 1990) electroendo-osmosis, diffusion, and endocytosis (Weaver and Barnett 1992). Reclosing of the pores appears to be a stochastic process that can be delayed by keeping the cells at  $0^{\circ}\text{C}$ . While the pores remain open, up to 0.5  $\mu\text{g}$  of DNA can enter the cell (Bertling et al. 1987). Size seems to be no impediment since DNA molecules up to 150 kb in size can easily pass through the pores (Knutson and Yee 1987). Because the DNA enters directly into the cytoplasm, it is not exposed to acid conditions in endosomes and lysosomes. This route may explain why the rate of mutation in DNA introduced to mammalian cells by electroporation is apparently very low (Drinkwater and Kleindienst 1986; Bertling et al. 1987) compared with DNA transfected as calcium phosphate coprecipitates or DEAE-dextran complexes (e.g., please see Calos et al. 1983). For *E. coli*, electroporation is currently the most efficient method available for transformation with plasmids. In excess of 80% of the cells in a culture can be transformed to ampicillin resistance by this method and efficiencies of transformation approaching the theoretical maximum of one transformant per molecule of plasmid DNA have been reported (Smith et al. 1990). However, the number of transformants obtained is marker-dependent. When pBR322, which carries genes conferring resistance to two antibiotics (ampicillin and tetracycline), is introduced into *E. coli* by electroporation, the number of tetracycline-resistant transformants is  $\sim 100$ -fold less than the number of ampicillin-resistant transformants (Steele et al. 1994). This effect is not seen when the plasmid is introduced to the bacteria by the calcium chloride method. One possible explanation is that electroporation damages or changes the bacterial membrane so that it can no longer interact efficiently with the tetracycline resistance protein.



**FIGURE 16-4** Changes in the Membrane during Electroporation

Drawings of hypothetical structures for transient and metastable membrane conformations believed to be relevant to electroporation. (A) Fredd volume fluctuation; (B) aqueous protrusion or "dimple"; (C,D) hydrophobic pores usually regarded as the "primary pores" through which ions and molecules pass; (E) composite pore with "foot in the door" charged macromolecule inserted into a hydrophilic pore. The transient aqueous pore model assumes that transitions from A→B→C or D occur with increasing frequency as  $U$  is increased. Type F may form by entry of a tethered macromolecule, while the transmembrane voltage is significantly elevated, and then persist after  $U$  has decayed to a small value through pore conduction. It is emphasized that these hypothetical structures have not been directly observed and that support for them derives from the interpretation of a variety of experiments involving electrical, optical, mechanical, and molecular transport behavior. (Redrawn, with permission, from Weaver 1993 [copyright Wiley-Liss, Inc.] )

Typically, between 50% and 70% of cells exposed to high electric field strengths are killed. The lethal effects, which vary in intensity from one cell type to another, are not due to heating or electrolysis and are independent of the current density and energy input. Instead, cell killing is dependent on field strength and the total time of treatment (Sale and Hamilton 1967). The most likely cause of cell killing is the rupture of cell membranes, which leads to rapid loss of ionic balance and massive efflux of cellular components.

### Electrical Conditions Required for Electroporation

Electroporation of almost all mammalian cells is induced when the transmembrane voltage,  $\Delta U(t)$ , is increased to 0.5–1.0 V for durations of microseconds to milliseconds. This translates to an electric field strength of ~7.5–15.0 kV/cm. Because this value is constant and is independent of the biochemical nature of the cell membrane, it seems likely that variations in the efficiency of electroporation from cell line to cell line are due to differences in the rate and efficiency of membrane recovery at the end of the pulse.

The transmembrane voltage,  $\Delta U(t)$ , induced by electric fields varies in direct proportion to the diameter of the cell that is the target for transfection (Knutson and Yee 1987). Electroporation of mammalian cells, for example, requires smaller electric fields (<10 kV/cm) than does electroporation of yeasts or bacteria (12.5–16.5 kV/cm). Most of the commercial suppliers of electroporation machines provide literature describing the approximate voltages required for transfection of specific types of cells in their particular apparatus.

Three important characteristics of the pulse affect the efficiency of electroporation: the *length* of the pulse, its *field-strength*, and its *shape*. Most of the commercial electroporation machines use capacitive discharge to produce controlled pulses whose length is mainly determined by the value of the capacitor and the conductivity of the medium. Thus, the time constant of the pulse can be altered by switching capacitors according to the manufacturer's instructions or by changing the ionic strength of the medium. When the

charge from the capacitor is directed to a sample placed between two electrodes, the voltage across the electrodes rises rapidly to a peak ( $V_0$ ) and declines over time ( $t$ ) according to the equation:

$$V_t = V_0 [e^{-t/\tau}]$$

where  $t$  is the time constant, which is equal to the time over which the voltage declines to ~37% of peak value.  $\tau$  (measured in seconds) is also equal to the product of the resistance ( $R$ , measured in ohms [ $\Omega$ ]) and the capacitance ( $C$ , in Farads [F]):

$$\tau = RC$$

From this equation, it follows (1) that a larger capacitor requires more time to discharge through a medium of a given resistance and (2) that a capacitor of a given size discharges more slowly as the resistance of the medium increases. Electroporation of mammalian cells is usually carried out in buffered saline solutions or culture media using a capacitor of 25.0  $\mu\text{F}$  whose discharge has a time constant of ~0.5 msec.

The *field strength* ( $E$ ) of the pulse varies in direct proportion to the applied voltage ( $V$ ) and in inverse proportion to the distance ( $d$ ) between the two electrodes, which is usually determined by the size of the cuvette through which the pulse travels.

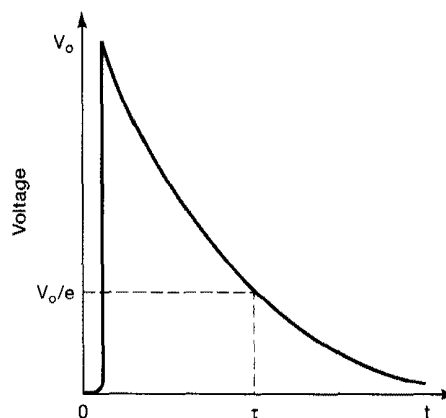
$$E = F(V,d)$$

Most manufacturers provide cuvettes in three sizes, where the interelectrode distances are, respectively, 0.1 cm, 0.2 cm, and 0.4 cm. When 1000 V are discharged into these cuvettes,  $E_0$  is 10,000 V/cm in the 0.1-cm cuvette, 5000 V/cm in the 0.2-cm cuvette, and 2500 V/cm in the 0.4-cm cuvette.

The *shape* of the pulse is determined by the design of the electroporation device. The wave form produced by most commercial machines is simply the exponential decay pattern of a discharging capacitor. In some types of electroporation apparatuses, square waves can be generated by rapidly increasing the voltage, maintaining it at the desired level for a specified time (pulse width), and then rapidly reducing the voltage to zero. Square pulses can be grouped into two general categories: very high field strength of very short duration (typically 8 kV/cm for 5.4 msec) (Neumann et al. 1982), and low field strength of medium to long duration (e.g., <2 kV/cm for >10 msec) (e.g., please see Potter et al. 1984). Although differences in the effectiveness of these various waveforms have been reported from time to time (e.g., please see Knutson and Yee 1987), there is no evidence that any one of them is consistently better than any other. For all practical purposes, the exponential wave forms produced by commercial electroporation machines are perfectly satisfactory.

#### FIGURE 16-5 Changes in the Electric Field during Electroporation

Time course of the electric field generated by capacitor discharge.  $V_0$  represents the time constant for the decay of the electric field;  $(\tau)RC$ , where  $C$  is the capacitance of the discharge capacitor and  $R$  is the resistance of the discharge unit; the resistance of the sample cell usually determines the circuit resistance. ( $t$ ) Time.



## Optimizing Conditions for Electroporation

A major advantage of electroporation over other methods of transfection is that it works for a very wide variety of mammalian cells, including those that are difficult to transfect by other means (e.g., please see Potter et al. 1984; Tur-Kaspa et al. 1986; Chu et al. 1987). However, despite its advantages, electroporation is not always the most efficient way to introduce DNA into a particular cell line. For example, COS cells are transfected most efficiently by the DEAE-dextran/DNA method (Kluxen and Lübbert 1993), whereas for other cell lines, lipofection or polybrene treatment are the techniques of choice (e.g., please see Jiang et al. 1991). To find out whether electroporation is a useful method of transfection for a particular cell line, it is important to use a range of field strengths and pulse lengths and thereby to establish conditions that generate the maximum numbers of transfectants. Such conditions have been reported for >50 types of mammalian cells, and it is sometimes possible to save a lot of work by simply reading the relevant literature. Most of the companies that sell electroporation devices produce excellent up-to-date lists of papers in which electroporation has been used for transfection. These bibliographies are often the easiest way to gain access to information about the properties of a particular cell line or its close relatives. However, because of variation in properties between different cultivars of the same cell line, it is important for investigators to confirm that the conditions described in the literature are optimal for cells grown in their laboratory.

Because transfection and cell killing are independently determined by field strength (Chu et al. 1987), it is best to expose aliquots of cells to electric fields of increasing strength with time constants between 50 and 200 msec. For each field strength, measure (1) the number of cells that express a transfected reporter gene (10–40 µg/ml of linearized plasmid DNA in the electroporation buffer) and (2) the proportion of cells that survive exposure to the electric field. Plating efficiency is a more accurate measure of cell survival than staining with vital dyes since, after electroporation, cells can remain permeable to vital dyes such as trypan blue for an hour or two. The following are other variables that have been reported to affect the efficiency of electroporation.

- **The temperature of the cells before, during, and after electroporation** (e.g., please see Potter et al. 1984; Chu et al. 1987). Usually, electroporation is carried out on cells that have been prechilled to 0°C. The cells are held at 0°C after electroporation (to maintain the pores in an open position) and are diluted into warm medium for plating (Rabussay et al. 1987).
- **The concentration and conformation of the DNA** (e.g., please see Neumann et al. 1982; Potter et al. 1984; Tonneguzzo and Keating 1986). Linear DNA is preferred for stable transformation; circular DNA is for transient transfection. Preparations containing DNA at a concentration of 1 µg/ml to 80 µg/ml are optimal.
- **The state of the cells.** The best results are obtained with cell cultures in the mid-log phase of growth that are actively dividing.

## REFERENCES

- al-Moslih M.I. and Dubes G.R. 1973. The kinetics of DEAE-dextran induced cell sensitization to transfection. *J. Gen. Virol.* **18**: 189–193.
- Andreason G.L. and Evans G.A. 1988. Introduction and expression of DNA molecules in eukaryotic cells by electroporation. *BioTechniques* **6**: 650–660.
- Ashman C.R. and Davidson R.L. 1985. High spontaneous mutation frequency of BPV shuttle vector. *Somat. Cell Mol. Genet.* **11**: 499–504.
- Aubin R.J., Weinfield M., and Paterson M.C. 1988. Factors influencing efficiency and reproducibility of polybrene-assisted gene transfer. *Somatic Cell Mol. Genet.* **14**: 155–167.
- Aubin R.J., Weinfeld M., Taghavi M., Mirzayans R., and Paterson M.C. 1997. Highly effective delivery of foreign DNA to adherent cells via polybrene-DMSO-assisted gene transfer. *Methods Mol. Biol.* **62**: 319–342.
- Bangham A.D. 1992. Liposomes: Realizing their promise. *Hosp. Pract.* **27**: 51–62.
- Baum C., Forster P., Hegewisch-Becker S., and Harbers K. 1994. An optimized electroporation protocol applicable to a wide range of cell lines. *BioTechniques* **17**: 1058–1062.
- Behr J.-P., Demeneix B., Loeffler J.-P., and Perez-Mutul J. 1989. Efficient gene transfer into mammalian primary endocrine cells with lipopolyamine-coated DNA. *Proc. Natl. Acad. Sci.* **86**: 6982–6986.
- Bertling W., Hunger-Bertling K., and Cline M.-J. 1987. Intracellular uptake and persistence of biologically active DNA after electroporation of mammalian cells. *J. Biochem. Biophys. Methods* **14**: 223–232.
- Bond V.C. and Wold B. 1987. Poly-L-ornithine-mediated transfection of mammalian cells. *Mol. Cell. Biol.* **7**: 2286–2293.
- Cabañas M.J., Vázquez D., and Modolell J. 1978. Dual interference of hygromycin B with ribosomal translocation and with aminoacyl-tRNA recognition. *Eur. J. Biochem.* **87**: 21–27.
- Calos M., Lebkowski J.S., and Botchan M.R. 1983. High mutation frequency in DNA transfected into mammalian cells. *Proc. Natl. Acad. Sci.* **80**: 3015–3019.
- Chaney W.G., Howard D.R., Pollard J.W., Sallustio S., and Stanley P. 1986. High-frequency transfection of CHO cells using polybrene. *Somat. Cell Mol. Genet.* **12**: 237–244.
- Chang P.L. 1994. Calcium phosphate-mediated DNA transfection. In *Gene Therapeutics: Methods and applications of direct gene transfer* (ed. J.A. Wolfe), pp. 157–179. Birkhäuser, Boston, Massachusetts.
- Chen C. and Okayama H. 1987. High-efficiency transformation of mammalian cells by plasmid DNA. *Mol. Cell. Biol.* **7**: 2745–2752.
- . 1988. Calcium phosphate-mediated gene transfer: A highly efficient transfection system for stably transforming cells with plasmid DNA. *BioTechniques* **6**: 632–638.
- Chermodnick L.V., Sokolov A.V., and Budker V.G. 1990. Electrostimulated uptake of DNA by liposomes. *Biochim. Biophys. Acta* **1024**: 179–183.
- Chu G. and Sharp P.A. 1981. SV40 DNA transfection of cells in suspension: Analysis of efficiency of transcription and translation of T-antigen. *Gene* **13**: 197–202.
- Chu G., Hayakawa H., and Berg P. 1987. Electroporation for the efficient transfection of mammalian cells with DNA. *Nucleic Acids Res.* **15**: 1311–1326.
- Coonrod A., Li F.-Q., and Horwitz M. 1997. On the mechanism of DNA transfection: Efficient gene transfer without viruses. *Gene Ther.* **4**: 1313–1321.
- Corsaro C.M. and Pearson M.L. 1981. Enhancing the efficiency of DNA-mediated gene transfer in mammalian cells. *Somat. Cell Mol. Genet.* **7**: 603–616.
- de Duve C., de Barsey T., Poole B., Tronet A., Tulkens P., and Van Hoof E. 1974. Lysosomotropic agents. *Biochem. Pharmacol.* **23**: 2495–2531.
- de la Luna S., Soria L., Pulido D., Ortin J., and Jimenez A. 1988. Efficient transformation of mammalian cells with constructs containing puromycin-resistance marker. *Gene* **62**: 121–126.
- Dong Y., Skoultchi A.I., and Pollard J.W. 1993. Efficient DNA transfection of quiescent mammalian cells using poly-L-ornithine. *Nucleic Acids Res.* **21**: 771–772.
- Drinkwater N.R. and Kleindienst D.K. 1986. Chemically induced mutagenesis in a shuttle vector with a low-background mutant frequency. *Proc. Natl. Acad. Sci.* **83**: 3402–3406.
- Duzgunes N., Goldstein J.A., Friend D.S., and Felgner P.L. 1989. Fusion of liposomes containing a novel cationic lipid, N-[2,3-(dioleoyloxy)propyl]-N,N,N-trimethylammonium: Induction by multivalent anions and asymmetric fusion with acidic phospholipid vesicles. *Biochemistry* **28**: 9179–9184.
- Ecker J.R. and Davis R.W. 1986. Inhibition of gene expression in plant cells by expression of antisense RNA. *Proc. Natl. Acad. Sci.* **83**: 5372–5376.
- Farhood H., Bottega R., Epand R.M., and Huang L. 1992. Effect of cationic cholesterol on gene transfer and protein kinase C activity. *Biochim. Biophys. Acta* **1111**: 239–246.
- Felgner J.H., Kumar R., Sridhar C.N., Wheeler C.J., Tsai Y.I., Border R., Ramsey P., Martin M., and Felgner P.L. 1994. Enhanced gene delivery and mechanism studies with a novel series of cationic lipid formulations. *J. Biol. Chem.* **269**: 2550–2561.
- Felgner P.L. 1990. Particulate systems and polymers for in vitro and in vivo delivery of polynucleotides. *Adv. Drug Delivery Rev.* **5**: 163–187.
- Felgner P.L. and Holm M. 1989. Cationic liposome-mediated transfection. *Focus (Life Technologies)* **11**: 21–25.
- Felgner P.L. and Ringold G. 1989. Cationic liposome-mediated transfection. *Nature* **337**: 387–388.
- Felgner P.L., Gadek T.R., Holm M., Roman R., Chan H.W., Wenz M., Northrop J.P., Ringold G.M., and Danielsen M. 1987. Lipofection: A highly efficient, lipid-mediated DNA-transfection procedure. *Proc. Natl. Acad. Sci.* **84**: 7413–7417.
- Fralely R. and Papahadjopoulos D. 1981. New generation liposomes: The engineering of an efficient vehicle for intracellular delivery of nucleic acids. *Trends Biochem. Sci.* **6**: 77–80.
- . 1982. Liposomes: The development of a new carrier system for introducing nucleic acid into plant and animal cells. *Curr. Top. Microbiol.* **96**: 171–191.
- Fralely R., Straubinger R.M., Rule G., Springer E.I., and Papahadjopoulos D. 1981. Liposome-mediated delivery of deoxyribonucleic acid to cells: Enhanced efficiency of delivery related to lipid composition and incubation conditions. *Biochemistry* **20**: 6978–6987.
- Fregeau C.J. and Bleackley R.C. 1991. Factors influencing transient expression in cytotoxic T cells following DEAE dextran-mediated gene transfer. *Somat. Cell Mol. Genet.* **17**: 239–257.

- Friend S.H., Dryja T.P., and Weinberg R.A. 1988. Oncogenes and tumor-suppressing genes. *N. Engl. J. Med.* **318**: 618-622.
- Fromm M., Taylor L.P., and Walbot V. 1985. Expression of genes transferred into monocot and dicot plant cells by electroporation. *Proc. Natl. Acad. Sci.* **82**: 5824-5828.
- . 1986. Stable transformation of maize after gene transfer by electroporation. *Nature* **319**: 791-793.
- Gao X. and Huang L. 1993. Cationic liposomes and polymers for gene transfer. *Liposome Res.* **3**: 17-30.
- Gauss G.H. and Lieber M.R. 1992. DEAE-dextran enhances electroporation of mammalian cells. *Nucleic Acids Res.* **20**: 6739-6740.
- Gluzman Y. 1981. SV40-transformed simian cells support the replication of early SV40 mutants. *Cell* **23**: 175-182.
- Godbey W., Wu. K. Hirasaki G., and Mikos A. 1999. Improved packing of poly(ethyleneimine)/DNA complexes increases transfection efficiency. *Gene Ther.* **6**: 1380-1388.
- Golub E.I., Kim H., and Volsky D.J. 1989. Transfection of DNA into adherent cells by DEAE-dextran/DMSO method increases dramatically if the cells are removed from surface and treated in suspension. *Nucleic Acid Res.* **17**: 4902.
- Gonzales A.L. and Joly E. 1995. A simple procedure to increase efficiency of DEAE-dextran transfection of COS cells. *Trends Genet.* **11**: 216-217.
- Gonzalez A., Jimenez A., Vázquez D., Davies J., and Schindler D. 1978. Studies on the mode of action of hygromycin B, an inhibitor of translocation in eukaryotes. *Biochim. Biophys. Acta* **521**: 459-469.
- Gorman C. 1985. High efficiency transfer into mammalian cells. In *DNA cloning: A practical approach* (ed. D.M. Glover), pp. 143-190. IRL Press, Oxford, United Kingdom.
- Gorman C.M., Howard B.H., and Reeves R. 1983a. Expression of recombinant plasmids in mammalian cells is enhanced by sodium butyrate. *Nucleic Acids Res.* **11**: 7631-7648.
- Gorman C., Padmanabhan R., and Howard B.H. 1983b. High efficiency DNA-mediated transformation of primate cells. *Science* **221**: 551-553.
- Gossen M. and Bujard H. 1992. Tight control of gene expression in mammalian cells by tetracycline-responsive promoters. *Proc. Natl. Acad. Sci.* **89**: 5547-5551.
- Gossen M., Freundlieb S., Bender G., Muller G., Hillen W., and Bujard H. 1995. Transcriptional activation by tetracyclines in mammalian cells. *Science* **268**: 1766-1769.
- Graham E.L. and van der Eb A.J. 1973. A new technique for the assay of infectivity of human adenovirus 5 DNA. *Virology* **52**: 456-467.
- Gritz L. and Davies J. 1983. Plasmid-encoded hygromycin-B resistance: The sequence of hygromycin-B-phosphotransferase and its expression in *E. coli* and *S. cerevisiae*. *Gene* **25**: 179-188.
- Harrison G.S., Wang Y., Tomczak J., Hogan C., Shpall E.J., Curiel T.J., and Felgner P.L. 1995. Optimization of gene transfer using cationic lipids in cell lines and primary human CD4<sup>+</sup> and CD34<sup>+</sup> hematopoietic cells. *BioTechniques* **19**: 816-823.
- Ho W.-Z., Gonczol E., Srinivasan A., Douglas S.D., and Plotkin S.A. 1991. Minitransfection: A simple, fast technique for transfections. *J. Virol. Methods* **32**: 79-88.
- Holter W., Fordis C.M., and Howard B.H. 1989. Efficient gene transfer by sequential treatment of mammalian cells with DEAE-dextran and deoxyribonucleic acid. *Exp. Cell Res.* **184**: 546-551.
- Horch H.W., Krüttgen A., Portbury S.D., and Katz L.C. 1999. Destabilization of cortical dendrites and spines by BDNF. *Neuron* **23**: 353-364.
- Jakoby W.B. and Pastan I.H., eds. 1979. Cell culture. *Methods Enzymol.* vol. 58.
- Jefferson R.A., Kavanagh T.A., and Bevan M.W. 1987. GUS fusions:  $\beta$ -glucuronidase as a sensitive and versatile gene fusion marker in higher plants. *EMBO J.* **6**: 3901-3907.
- Jiang C.K., Connolly D., and Blumenberg M. 1991. Comparison of methods for transfection of human epidermal keratinocytes. *J. Investig. Dermatol.* **97**: 969-973.
- Jordan M., Schallhorn A., and Wurm F.W. 1996. Transfecting mammalian cells: Optimization of critical parameters affecting calcium-phosphate precipitate formation. *Nucleic Acids Res.* **24**: 596-601.
- Kaster K.R., Burgett S., and Ingolia T.D. 1984. Hygromycin B resistance as dominant selectable marker in yeast. *Curr. Genet.* **8**: 353-358.
- Kaufman R.J., Murtha P., Ingolia D.E., Yeung C.Y., and Kellems R.E. 1986. Selection and amplification of heterologous genes encoding adenosine deaminase in mammalian cells. *Proc. Natl. Acad. Sci.* **83**: 3136-3140.
- Kawai S. and Nishizawa M. 1984. New procedure for DNA transfection with polycation and dimethyl sulfoxide. *Mol. Cell. Biol.* **4**: 1172-1174.
- Kichler A., Zauner W., Ogris M., and Wagner E. 1998. Influence of the DNA complexation medium on the transfection efficiency of lipospermine/DNA particles. *Gene Ther.* **5**: 855-860.
- Kingsley D.M., Sege R.D., Kozarsky K.F., and Krieger M. 1986. DNA-mediated transfer of a human gene required for low-density lipoprotein receptor expression and for multiple Golgi processing pathways. *Mol. Cell. Biol.* **6**: 2734-2737.
- Klein T.M., Wolf E.D., Wu R., and Sanford J.C. 1987. High-velocity microprojectiles for delivering nucleic acids into living cells. *Nature* **327**: 70-73.
- Kluxen F.-W. and Lübbert H. 1993. Maximal expression of recombinant cDNAs in COS cells for use in expression cloning. *Anal. Biochem.* **208**: 352-356.
- Knutson J.C. and Yee D. 1987. Electroporation: Parameters affecting transfer of DNA into mammalian cells. *Anal. Biochem.* **164**: 44-52.
- Koltover I., Salditt T., Radler J.O., and Safinya C.R. 1998. An inverted hexagonal phase of cationic liposome-DNA complexes related to DNA release and delivery. *Science* **281**: 78-81.
- Kukowska-Latello J.F., Bielinska A.U., Johnson J., Spindler R., Tomalia D.A., and Baker Jr., J.R. 1996. Efficient transfer of genetic material into mammalian cells using Starburst polyamidoamine dendrimers. *Proc. Natl. Acad. Sci.* **3**: 4897-4902.
- Labat-Moleur E., Steffan A.-M., Brisson C., Perron H., Feugeas O., Furstemberger P., Oberling F., Brambilla E., and Behr J.-P. 1996. An electron microscopy study into the mechanism of gene transfer with lipopolyamines. *Gene Ther.* **3**: 1010-1017.
- Lea M.A. and Randolph V.M. 1998. Induction of reporter gene expression by inhibitors of histone deacetylase. *Anticancer Res.* **18**: 2717-2722.
- Lebkowski J.S., DuBridg R.B., Antell E.A., Greisen K.S., and Calos M.P. 1984. Transfected DNA is mutated in monkey, mouse, and human cells. *Mol. Cell. Biol.* **4**: 1951-1960.
- Leventis R. and Silvius J.R. 1990. Interactions of mammalian cells with lipid dispersions containing novel metabolizable cationic amphiphiles. *Biochim. Biophys. Acta* **1023**: 124-132.
- Lieber M.R., Hesse J.E., Mizuuchi K., and Gellert M. 1987.

- Developmental stage specificity of the lymphoid V(D)J recombination activity. *Genes Dev.* **1**: 751-761.
- Lindner P., Neumann E., and Rosenheck K. 1977. Kinetics of permeability changes induced by electric impulses in chromaffin granules. *J. Membr. Biol.* **32**: 231-254.
- Loeffler J.-P. and Behr J.-P. 1993. Gene transfer into primary and established mammalian cell lines with lipopolyamine-coated DNA. *Methods Enzymol.* **217**: 599-618.
- Lopata M.A., Cleveland D.W., and Sollner-Webb B. 1984. High level expression of a chloramphenicol acetyl transferase gene by DEAE-dextran mediated DNA transfection coupled with a dimethyl sulfoxide or glycerol shock treatment. *Nucleic Acids Res.* **12**: 5707-5717.
- Luo D.L. and Saltzman W.M. 1999. Synthetic DNA delivery systems. *Nat. Biotechnol.* **18**: 33-37.
- Luthman H. and Magnusson G. 1983. High efficiency polyoma DNA transfection of chloroquine treated cells. *Nucleic Acids Res.* **11**: 1295-1308.
- Maitland N.J. and McDougall J.K. 1977. Biochemical transformation of mouse cells by fragments of herpes simplex DNA. *Cell* **11**: 233-241.
- McAllister A.K., Lo D.C., and Katz L.C. 1995. Neurotrophins regulate dendritic growth in developing visual cortex. *Neuron* **15**: 791-803.
- McCutchan J.H. and Pagano J.S. 1968. Enhancement of the infectivity of simian virus 40 deoxyribonucleic acid with diethyl aminoethyl-dextran. *J. Natl. Cancer Inst.* **41**: 351-357.
- Miller J.H., Lebkowski J.S., Greisen K.S., and Calos M.P. 1984. Specificity of mutations induced in transfected DNA by mammalian cells. *EMBO J.* **3**: 3117-3121.
- Mulligan R.C. and Berg P. 1981a. Selection for animal cells that express the *E. coli* gene coding for xanthine-guanine phosphoribosyltransferase. *Proc. Natl. Acad. Sci.* **78**: 2072-2076.
- 1981b. Factors governing the expression of a bacterial gene in mammalian cells. *Mol. Cell. Biol.* **1**: 449-459.
- Nead M.A. and McCance D.J. 1995. Poly-L-ornithine-mediated transfection of human keratinocytes. *J. Investig. Dermatol.* **105**: 668-671.
- Neumann E. and Rosenheck K. 1972. Permeability changes induced by electric impulses in vesicular membranes. *J. Membr. Biol.* **10**: 279-290.
- Neumann E., Schaefer-Ridder M., Wang Y., and Hofschneider P.H. 1982. Gene transfer into mouse lymphoma cells by electroporation in high electric fields. *EMBO J.* **1**: 841-845.
- No D., Yao T.P., and Evans R.M. 1996. Ecdysone-inducible gene expression in mammalian cells and transgenic mice. *Proc. Natl. Acad. Sci.* **93**: 3346-3351.
- Ogawa T., Hyodo M., and Suzuki K. 1988. A new transfection method of mouse FM3A mammary carcinoma cells with plasmid DNA. *Nucleic Acids Symp. Ser.* **19**: 153-155.
- Pagano J.S. and Vaheer A. 1965. Enhancement of infectivity of poliovirus RNA with diethyl-aminoethyl-dextran (DEAE-D). *Arch. Gesamte Virusforsch.* **17**: 456-464.
- Palmer T.D., Hock R.A., Osborne W.R.A., and Miller A.D. 1987. Efficient retrovirus-mediated transfer and expression of a human adenosine deaminase gene in diploid skin fibroblasts from an adenosine-deficient human. *Proc. Natl. Acad. Sci.* **84**: 1055-1059.
- Parker B.A. and Stark G.R. 1979. Regulation of simian virus 40 transcription: Sensitive analysis of the RNA species present early in infections by virus or viral DNA. *J. Virol.* **31**: 360-369.
- Patterson Jr., M.K. 1979. Measurement of growth and viability of cells in culture. *Methods Enzymol.* **58**: 141-152.
- Perucho M. and Wigler M. 1981. Linkage and expression of foreign DNA in cultured animal cells. *Cold Spring Harbor Symp. Quant. Biol.* **45**: 829-838.
- Perucho M., Hanahan D., and Wigler M. 1980. Genetic and physical linkage of exogenous sequences in transformed cells. *Cell* **22**: 309-317.
- Picard D., Salser S.J., and Yamamoto K.R. 1988. A movable and regulable inactivation function within the steroid binding domain of the glucocorticoid receptor. *Cell* **54**: 1073-1080.
- Pinnaduwa P., Schmitt L., and Huang L. 1989. Use of a quaternary ammonium detergent in liposome mediated DNA transfection of mouse L-cells. *Biochim. Biophys. Acta* **985**: 33-37.
- Pittenger R.C., Wolfe R.N., Hoehn M.M., Marks P.N., Dailey W.A., and McGuire J.M. 1953. Hygromycin. I. Preliminary studies on the production and biological activity of a new antibiotic. *Antibiot. Chemother.* **3**: 1268-1278.
- Ponder K.P., Dunbar R.P., Wilson D.R., Darlington G.J., and Woo S.L.C. 1991. Evaluation of relative promoter strength in primary hepatocytes using optimized lipofection. *Hum. Gene Ther.* **2**: 41-52.
- Potter H., Weir L., and Leder P. 1984. Enhancer-dependent expression of human  $\kappa$  immunoglobulin genes introduced into mouse pre-B lymphocytes by electroporation. *Proc. Natl. Acad. Sci.* **81**: 7161-7165.
- Rabussay D., Uher L., Bates G., and Piastuch W. 1987. Electroporation of mammalian and plant cells. *Focus (Life Technologies)* **9**: 1-3.
- Rao R., Allen N., Hobbs J., Alborn W., Kirst H., and Paschal J. 1983. Genetic and enzymatic basis of hygromycin B resistance in *Escherichia coli*. *Antimicrob. Agents Chemother.* **24**: 689-695.
- Razzaque A., Mizusawa H., and Seidman M.M. 1983. Rearrangement and mutagenesis of a shuttle vector plasmid after passage in mammalian cells. *Proc. Natl. Acad. Sci.* **80**: 3010-3014.
- Reeves R., Gorman C.M., and Howard B.H. 1985. Minichromosome assembly of non-integrated plasmid DNA transfected into mammalian cells. *Nucleic Acids Res.* **13**: 3599-3615.
- Reiss M., Jastreboff M.M., Bertino J.R., and Narayanan R. 1986. DNA-mediated gene transfer into epidermal cells using electroporation. *Biochem. Biophys. Res. Commun.* **137**: 244-249.
- Robins D.M., Ripley S., Henderson A.S., and Axel R. 1981. Transforming DNA integrates into the host cell chromosome. *Cell* **23**: 29-39.
- Rose J.K., Buonocore L., and Whitt M.A. 1991. A new cationic liposome reagent mediating nearly quantitative transfection of animal cells. *BioTechniques* **10**: 520-525.
- Rosenheck K., Lindner P., and Pecht L. 1975. Effect of electric fields on light-scattering and fluorescence of chromaffin granules. *J. Membr. Biol.* **12**: 1-12.
- Ryser H.J.-P. 1967. A membrane effect of basic polymers dependent on molecular size. *Nature* **215**: 934-936.
- Sale A.J.H. and Hamilton W.A. 1967. Effects of high electric fields on microorganisms. I. Killing of bacteria and yeasts. *Biochim. Biophys. Acta* **148**: 781-788.
- Sanes J., Rubinstein J.L., and Nicolas J.F. 1986. Use of recombinant retroviruses to study post-implantation cell lineages in mouse embryos. *EMBO J.* **5**: 3133-3142.
- Sanford J.C., Smith F.D., and Russell J.A. 1993. Optimizing the

- biolistic process for different biological applications. *Methods Enzymol.* **217**: 483–509.
- Santerre R., Allen N., Hobbs J., Rao R., and Schmidt R. 1984. Expression of prokaryotic genes for hygromycin B and G418 resistance as dominant-selection markers in mouse. *Gene* **30**: 147–156.
- Schimke R.T. 1984. Gene amplification in cultured animal cells. *Cell* **37**: 705–713.
- Sege R.D., Kozarsky K., Nelson D.L., and Krieger M. 1984. Expression and regulation of human low-density lipoprotein receptors in Chinese hamster ovary cells. *Nature* **307**: 742–745.
- Shark K.B., Smith F.D., Harpending P.R., Rasmussen J.L., and Sanford J.C. 1991. Biolistic transformation of a prokaryote, *Bacillus megaterium*. *Appl. Environ. Microbiol.* **57**: 480–485.
- Shockett P., Difilippantonio M., Hellman N., and Schatz D. 1995. A modified tetracycline-regulated system provides autoregulatory, inducible gene expression in cultured cells and transgenic mice. *Proc. Natl. Acad. Sci.* **92**: 6522–6526.
- Simonsen C.C. and Levinson A.D. 1983. Isolation and expression of an altered mouse dihydrofolate reductase cDNA. *Proc Natl. Acad. Sci.* **80**: 2495–2499.
- Singh A., Ursic D., and Davies J. 1979. Phenotypic suppression and misreading in *S. cerevisiae*. *Nature* **277**: 146–148.
- Smith F.D., Harpending P.R., and Sanford J.C. 1992. Biolistic transformation of prokaryotes: Factors that affect biolistic transformation of very small cells. *J. Gen. Microbiol.* **138**: 239–248.
- Smith M., Jessee J., Landers T., and Jordan J. 1990. High efficiency bacterial electroporation  $1 \times 10^{10}$  *E. coli* transformants per microgram. *Focus (Life Technologies)* **12**: 38–40.
- Southern P.J. and Berg P. 1982. Transformation of mammalian cells to antibiotic resistance with a bacterial gene under control of the SV40 early region promoter. *J. Mol. Appl. Genet.* **1**: 327–341.
- Spandidos D.A. and Wilkie N.M. 1984. Expression of exogenous DNA in mammalian cells. In *Transcription and translation: A practical approach* (ed. B.D. Hames and S.J. Higgins), pp. 1–48. IRL Press, Oxford, United Kingdom.
- Spector D.L., Goldman R.D., and Leinwand L.A. 1998a. *Cells: A laboratory manual*, vol. 1: *Culture and biochemical analysis of cells*. Cold Spring Harbor Laboratory Press, Cold Spring Harbor, New York.
- . 1998b. *Cells: A laboratory manual*, vol. 2: *Light microscopy and cell structure*. Cold Spring Harbor Laboratory Press, Cold Spring Harbor, New York.
- Stark G. and Wahl G. 1984. Gene amplification. *Annu. Rev. Biochem.* **53**: 447–491.
- Steele C., Zhang S., and Shillito E.J. 1994. Effect of different antibiotics on efficiency of transformation of bacteria by electroporation. *BioTechniques* **17**: 360–365.
- Straubinger R.M. and Papahadjopoulos D. 1983. Liposomes as carriers for intracellular delivery of nucleic acids. *Methods Enzymol.* **101**: 512–527.
- Strauss W.M. 1996. Transfection of mammalian cells by lipofection. *Methods Mol. Biol.* **54**: 307–327.
- Sugden B., Marsh K., and Yates J. 1985. A vector that replicates as a plasmid and can be efficiently selected in B-lymphoblasts transformed by Epstein-Barr virus. *Mol. Cell. Biol.* **5**: 410–413.
- Sussman D.J. and Milman G. 1984. Short-term, high efficiency expression of transfected DNA. *Mol. Cell. Biol.* **4**: 1641–1643.
- Thompson C.D., Frazier-Jessen M.R., Rawat R., Nordan R.P., and Brown R.T. 1999. Evaluation of methods for transient transfection of a murine macrophage cell line, RAW 264.7. *BioTechniques* **27**: 824–832.
- Toneguzzo F. and Keating A. 1986. Stable expression of selectable genes introduced into human hematopoietic stem cells by electric field-mediated DNA transfer. *Proc. Natl. Acad. Sci.* **83**: 3496–3499.
- Toneguzzo F., Hayday A.C., and Keating A. 1986. Electric field-mediated DNA transfer: Transient and stable gene expression in human and mouse lymphoid cells. *Mol. Cell. Biol.* **6**: 703–706.
- Tseng W.-C., Haselton F.R., and Giorgio T.D. 1997. Transfection by cationic liposomes using simultaneous single cell measurements of plasmid delivery and transgene expression. *J. Biol. Chem.* **272**: 25641–25647.
- Tsong T.Y. 1991. Electroporation of cell membranes. *Biophys. J.* **60**: 297–306.
- Tur-Kaspa R., Teicher L., Levine B.J., Skoultchi A.I., and Shafritz D.A. 1986. Use of electroporation to introduce biologically active foreign genes into primary rat hepatocytes. *Mol. Cell. Biol.* **6**: 716–718.
- Vaheri A. and Pagano J.S. 1965. Infectious poliovirus RNA: A sensitive method of assay. *Virology* **27**: 434–436.
- van den Elzen P., Townsend J., Lee K., and Bedbrook J. 1985. A chimeric hygromycin resistance gene as a selectable marker in plant cells. *Plant Mol. Biol.* **5**: 299–302.
- Van Pel A., De Plaen E., and Boon T. 1985. Selection of highly transfectable variant from mouse mastocytoma P815. *Somat. Cell Mol. Genet.* **11**: 467–475.
- Waldron C., Murphy E.B., Roberts J.L., Gustafson G.D., Armour S.L., and Malcolm S.K. 1985. Resistance to hygromycin B: A new marker for plant transformation studies. *Plant Mol. Biol.* **5**: 103–108.
- Warden D. and Thorne H.V. 1968. The infectivity of polyoma virus DNA for mouse embryo cells in the presence of diethylaminoethyl-dextran. *J. Gen. Virol.* **3**: 371–377.
- Weaver J.C. 1993. Electroporation: A general phenomenon for manipulating cells and tissues. *J. Cell. Biochem.* **51**: 426–435.
- Weaver J.C. and Barnett A. 1992. Progress towards a theoretical model of electroporation mechanism: Membrane behavior and molecular transport. In *Guide to electroporation and electrofusion* (ed. D.C. Chang et al.), pp. 91–117. Academic Press, San Diego, California.
- Weinberg R.A. 1985. Oncogenes and the molecular basis of cancer. *Harvey Lect.* **80**: 29–136.
- Wigler M., Pellicer A., Silverstein S., and Axel R. 1978. Biochemical transfer of single-copy eukaryotic genes using total cellular DNA as a donor. *Cell* **14**: 725–731.
- Wigler M., Silverstein S., Lee L.S., Pellicer A., Cheng V.C., and Axel R. 1977. Transfer of purified herpes virus thymidine kinase gene to cultured mouse cells. *Cell* **11**: 223–232.
- Wibo M. and Poole B. 1974. Protein degradation in cultured cells. II. The uptake of chloroquine by rat fibroblasts and the inhibition of cellular protein degradation and cathepsin B1. *J. Cell Biol.* **63**: 430–440.
- Wong T.-K. and Neumann E. 1982. Electric field mediated gene transfer. *Biochem. Biophys. Res. Commun.* **107**: 584–587.
- Workman J.L. and Kingston R.E. 1998. Alteration of nucleosome structure as a mechanism of transcriptional regulation. *Annu. Rev. Biochem.* **67**: 545–579.
- Yang Y.W. and Yang J.C. 1997. Studies of DEAE-dextran-mediated gene transfer. *Biotechnol. Appl. Biochem.* **25**: 47–51.
- Zabner J., Fasbender A.J., Moninger T., Poellinger K.A., and Welsh



- M.J. 1995. Cellular and molecular barriers to gene transfer by a cationic lipid. *J. Biol. Chem.* **270**: 18997-19007.
- Zauner W., Kichler A., Schmidt W., Sinski A., and Wagner E. 1996. Glycerol enhancement of ligand-polylysine/DNA transfection. *BioTechniques* **20**: 905-913.
- Zhang G. and Kain S.R. 1996. Transfection maximizer increases the efficiency of calcium phosphate transfections with mammalian cells. *BioTechniques* **21**: 940-945.
- Zhou X. and Huang L. 1994. DNA transfection mediated by cationic liposomes containing lipopolylysine: Characterization and mechanism of action. *Biochim. Biophys. Acta* **1189**: 195-203.
- Zimmermann U. 1982. Electric field-mediated fusion and related electrical phenomena. *Biochim. Biophys. Acta* **694**: 227-277.
- Zimmermann U., Riemann E., and Pilwat G. 1976. Enzyme loading of electrically homogeneous human red blood cell ghosts prepared by dielectric breakdown. *Biochim. Biophys. Acta* **436**: 460-474.
- Zuber M.X., Mason J.I., Simpson E.R., and Waterman M.R. 1988. Simultaneous transfection of COS-1 cells with mitochondrial and microsomal steroid hydroxylases: Incorporation of a steroidogenic pathway into non-steroidogenic cells. *Proc. Natl. Acad. Sci.* **85**: 699-703.

# Chapter 17

---

## Analysis of Gene Expression in Cultured Mammalian Cells

### INTRODUCTION

### PROTOCOLS

#### *Cis-Acting Regions and Trans-acting Factors*

- 1 Mapping Protein-binding Sites on DNA by DNase I Footprinting 17.4
  - Alternative Protocol: Mapping Protein-binding Sites on DNA by Hydroxyl Radical Footprinting 17.12
- 2 Gel Retardation Assays for DNA-binding Proteins 17.13
  - Additional Protocol: Supershift Assays 17.17
  - Additional Protocol: Competition Assays 17.17
- 3 Mapping DNase-I-hypersensitive Sites 17.18

#### *Analysis of Primary Transcripts*

- 4 Transcriptional Run-on Assays 17.23

#### *Reporter Assays*

- Introduction to Reporter Assays: CAT, Luciferase, and  $\beta$ -galactosidase (Protocols 5–7) 17.30
- 5 Measurement of Chloramphenicol Acetyltransferase in Extracts of Mammalian Cells Using Thin-layer Chromatography 17.33
  - Alternative Protocol: Measurement of CAT by Extraction with Organic Solvents 17.40
  - Alternative Protocol: Measurement of CAT by Diffusion of Reaction Products into Scintillation Fluid 17.41
- 6 Assay for Luciferase in Extracts of Mammalian Cells 17.42
  - Alternative Protocol: Using a Scintillation Counter to Measure Luciferase 17.46
  - Alternative Protocol: Assay for Luciferase in Cells Growing in 96-well Plates 17.47
- 7 Assay for  $\beta$ -galactosidase in Extracts of Mammalian Cells 17.48

**Inducible Systems**

8	Tetracycline as Regulator of Inducible Gene Expression in Mammalian Cells	17.52
	Stage 1: Stable Transfection of Fibroblasts with pTet-tTA	17.60
	Stage 2: Stable Transfection of Inducible tTA-expressing NIH-3T3 Cells with Tetracycline-regulated Target Genes	17.65
	Stage 3: Analysis of Protein Expression in Transfected Cells	17.68
	• Alternative Protocol: Tetracycline-regulated Induction of Gene Expression in Transiently Transfected Cells Using the Autoregulatory tTA System	17.70
9	Ecdysone as Regulator of Inducible Gene Expression in Mammalian Cells	17.71

**INFORMATION PANELS**

Footprinting DNA	17.75
Gel Retardation Assays	17.78
Baculoviruses and Baculovirus Expression Systems	17.81
Green Fluorescent Protein	17.84
Epitope Tagging	17.90
Chloramphenicol Acetyltransferase	17.94
Luciferase	17.96
$\beta$ -galactosidase	17.97

**T**HIS CHAPTER DEALS WITH FOUR EXPERIMENTAL METHODS that are commonly used to measure the transcriptional activity of mammalian genes and to regulate their expression in transfected cells.

- **Identifying DNA-protein complexes.** *cis*-acting regulatory regions of genes bind *trans*-acting factors that can either protect target sequences from experimental attack by deoxyribonuclease or can enhance their sensitivity to the enzyme. Protocol 1 describes methods for “footprinting” regulatory elements of DNA to identify regions that bind nuclear proteins. Target sequences also can be identified by forming DNA-protein complexes and analyzing the products by gel retardation assays, as described in Protocol 2. For further information, please see the information panels on **FOOTPRINTING DNA** and **GEL RETARDATION ASSAYS** at the end of this chapter. Protocol 3 describes a method to scan regions within and distal to genes for potential regulatory sequences whose sensitivity to digestion with exogenous DNase I changes as a function of transcriptional activity. These so-called hypersensitive sites are detected by Southern hybridization of the products of digestion of genomic DNA in isolated nuclei using a probe derived from the target gene.
- **Analyzing primary transcripts by transcriptional run-on.** Protocol 4 describes a method to measure the intensity of transcription of a target gene under different experimental conditions. Nuclei isolated from cells expressing the gene of interest are radiolabeled *in vitro*, and the resulting labeled RNAs are hybridized to a vast excess of the cloned gene. The amount of radioactivity specifically bound to the target sequences is a measure of its transcriptional activity. Please note that methods to measure and analyze steady-state mRNA levels are described in Chapters 7 and 8 of this book. These methods include ribonuclease protection, primer extension, northern blotting, and real time PCR.
- **Using reporter genes as markers to map regulatory elements and to quantify their power.** Protocols 5, 6, and 7 describe the use of three different reporter genes encoding easily assayed enzyme activities: chloramphenicol acetyltransferase (CAT), luciferase, and  $\beta$ -galactosidase. The strengths and weaknesses of these three systems are compared in the introduction preceding Protocol 5.
- **Regulating expression of target genes.** Regulatory systems controlled by small diffusible ligands can be imported into mammalian cells and used to control the expression of target genes. Protocol 8 describes the use of tetracycline-responsive systems to regulate expression of transiently transfected genes. Protocol 9 describes how analogs of the insect hormone ecdysone can be used as a inducer of gene expression in mammalian cells.

Expression systems based on the use of baculovirus vectors have proven to be tremendously useful for the production of foreign proteins, fusion proteins, and simultaneous expression of two or more (up to four) proteins. For further details, please see the information panel on **BACULOVIRUSES AND BACULOVIRUS EXPRESSION SYSTEMS**. Protocols for the use of the baculovirus expression system may be found in Spector et al. (1998; Chapter 66 of *Cells: A Laboratory Manual*).

*Science is built up with facts, as a house is with stones. But a collection of facts is no more a science than a heap of stones is a house.*

Henri Poincare (1854–1912)

# Protocol 1

---

## Mapping Protein-binding Sites on DNA by DNase I Footprinting

**D**NASE I FOOTPRINTING IS A METHOD TO VISUALIZE DIRECTLY the binding of a protein to a specific DNA sequence (please see Figure 17-1) (Galas and Schmitz 1978). The assay is usually used in combination with gel retardation assays (please see Protocol 2) to identify nuclear factors that bind to sequences in the regulatory regions of genes. A DNase I "footprint" is generated when a bound transcription factor protects a segment of DNA from the nucleolytic activity of DNase I. In a typical experiment, the pattern of DNase I cleavage obtained for a target DNA fragment in the presence and absence of nuclear extract is compared. Footprints appear as tracts where no cleavage occurs in the presence of nuclear extract. By comparing the electrophoretic mobility of the DNase I cleavage products to those of a sequence ladder derived from the same DNA fragment, the position of the footprint, and hence the DNA sequence recognized by a DNA-binding protein, can be determined. Overall, the method is fast and sensitive and provides resolution at the nucleotide level.

In this protocol, we describe methods for mapping protein-binding sites on a radiolabeled fragment of DNA. The protocol uses DNase I to fragment the DNA, whereas an alternative protocol uses hydroxyl radicals to fragment the DNA. For suggestions on how to optimize the footprinting reactions, please see the panel on **TROUBLESHOOTING AND OPTIMIZATION OF DNASE I FOOTPRINTING** at the end of this protocol.

### MATERIALS

---

**CAUTION:** Please see Appendix 12 for appropriate handling of materials marked with <!.>.

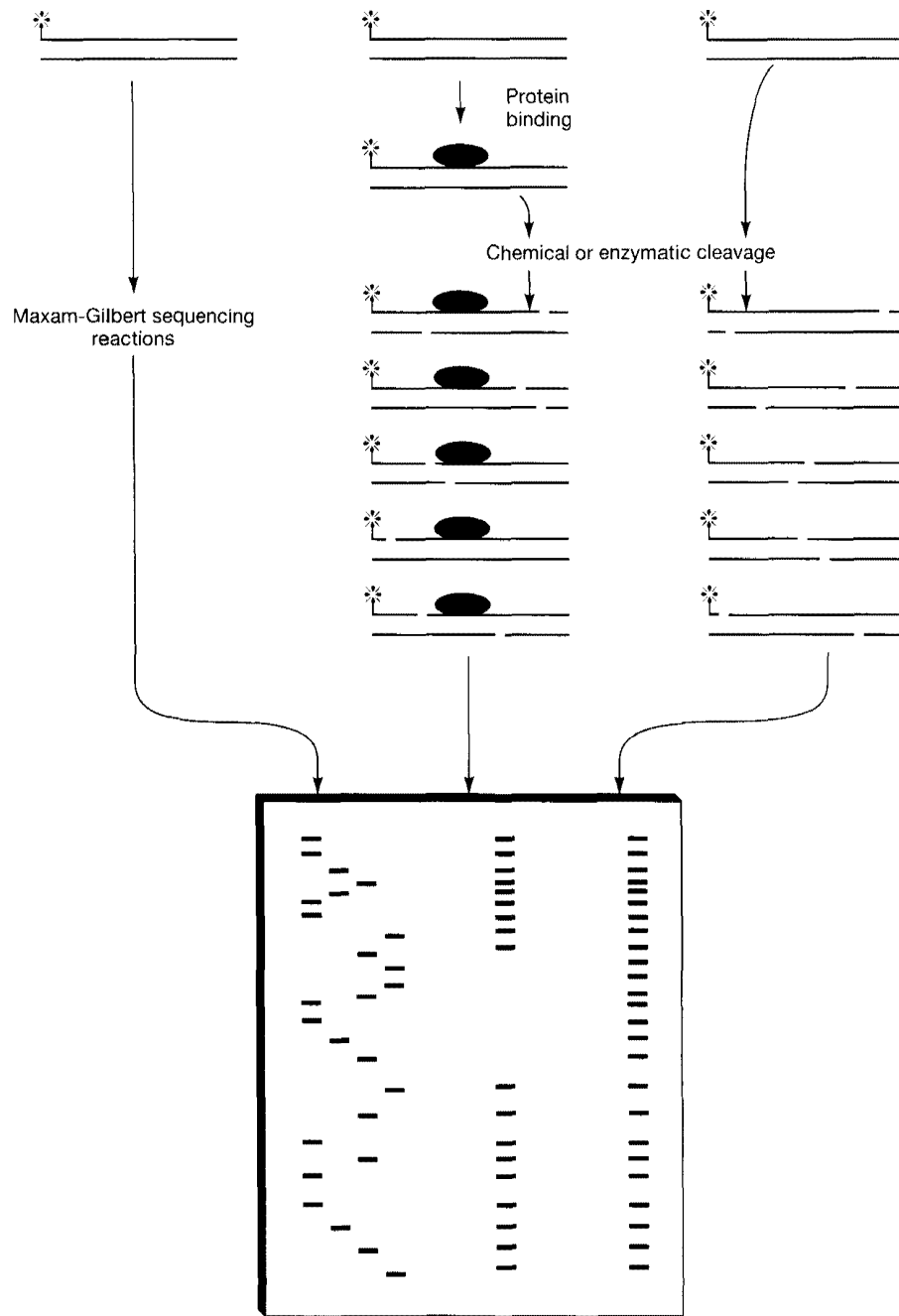
#### Buffers and Solutions

Please see Appendix 1 for components of stock solutions, buffers, and reagents.  
Dilute stock solutions to the appropriate concentrations.

##### *Cell homogenization buffer*

- 10 mM HEPES-KOH (pH 7.9) <!.>
- 1.5 mM MgCl<sub>2</sub>
- 10 mM KCl
- 0.5 mM dithiothreitol
- 0.5 mM phenylmethylsulfonyl fluoride <!.>

*Cell homogenization buffer containing 0.05% (v/v) Nonidet P-40*



**FIGURE 17-1 Steps Involved in DNA Footprinting**

A fragment of double-stranded DNA of defined length is first labeled at one end of one strand, incubated with a putative DNA-binding protein and then incubated with a cleavage reagent under conditions that result in an average of one cleavage event per labeled molecule. The DNA is purified and analyzed by electrophoresis through a denaturing polyacrylamide gel. If cleavage occurs randomly, the resulting populations of radiolabeled single-stranded DNA fragments will differ in length by a single nucleotide and will appear as a semicontinuous ladder after autoradiography of the gel. However, if a region of DNA is protected from cleavage by a bound protein, there will be a gap in the ladder of radioactive fragments. This "footprint" can be precisely located by aligning the gap with a set of Maxam-Gilbert sequencing reactions, carried out on the same radiolabeled DNA.

*Cell resuspension buffer*

40 mM HEPES-KOH (pH 7.9)  
0.4 M KCl  
1 mM dithiothreitol  
10% (v/v) glycerol  
0.1 mM phenylmethylsulfonyl fluoride  
0.1% (w/v) aprotinin

Store the buffer at 0°C until needed.

*Cell rinse buffer*

40 mM Tris-Cl (pH 7.4)  
1 mM EDTA  
0.15 M NaCl

Store the buffer at 0°C until needed.

*Ethanol*

*Ficoll 400 (20% w/v)*

Dissolve the Ficoll in sterile H<sub>2</sub>O and store the solution frozen in 100- $\mu$ l aliquots at -20°C.

*Formamide dye mix <!>*

10 ml of formamide  
10 mg of xylene cyanol FF  
10 mg of bromophenol blue

Store at room temperature.

*MgCl<sub>2</sub>/CaCl<sub>2</sub> solution*

10 mM MgCl<sub>2</sub>  
5 mM CaCl<sub>2</sub>

Sterilize the solution by filtration and store the filtrate at room temperature.

*NaCl (5 M)*

*Nonidet P-40 (0.05% v/v)*

*Phenol:chloroform <!>*

*Phosphate-buffered saline without calcium and magnesium salts*

*Polyvinyl alcohol (10% w/v)*

Dissolve the polyvinyl alcohol in sterile H<sub>2</sub>O and store the solution frozen in 100- $\mu$ l aliquots at -20°C.

*Stop mix*

20 mM EDTA (pH 8.0)  
1% (w/v) SDS  
0.2 M NaCl  
125  $\mu$ g/ml yeast tRNA

*Tissue homogenization buffer*

10 mM HEPES-KOH (pH 7.6)  
25 mM KCl  
0.15 mM spermine  
0.5 mM spermidine  
1 mM EDTA (pH 8.0)  
2 M sucrose  
10% (v/v) glycerol

The buffer should be ice cold at the time of use. Add protease inhibitors such as 0.5 mM phenylmethylsulfonyl fluoride (PMSF), 1  $\mu$ g/ml leupeptin, 1  $\mu$ g/ml pepstatin, or others as needed, just before Step 1.

*Tissue resuspension buffer*

5 mM HEPES-KOH (pH 7.9)  
1.5 mM MgCl<sub>2</sub>  
0.5 mM dithiothreitol  
0.5 mM phenylmethylsulfonyl fluoride  
26% (v/v) glycerol

Store the buffer at 0°C until needed.

*Trypan Blue dye (0.4% w/v)*

Dissolve an appropriate amount of dye in phosphate-buffered saline without calcium and magnesium salts. Store the solution at room temperature.

## Enzymes and Buffers

*DNase I (1 mg/ml)*

Dissolve the enzyme in 10 mM Tris-Cl (pH 8.0). Store the solution frozen in small aliquots at  $-20^{\circ}\text{C}$ . Dilute the solution 1:100 in ice-cold 10 mM Tris-Cl (pH 8.0) just before Step 3.

## Gels

*Denaturing 6% or 8% polyacrylamide sequencing gel (Chapter 12, Protocol 8) <1>*

## Nucleic Acids and Oligonucleotides

*Poly(dI-dC) (1 mg/ml)*

Dissolve an appropriate amount of poly(dI-dC) in sterile  $\text{H}_2\text{O}$  and store the solution in 100- $\mu\text{l}$  aliquots at  $-20^{\circ}\text{C}$ . The nucleic acid copolymer is added to decrease nonspecific binding of proteins to the radiolabeled DNA fragment. The optimum concentration (usually between 0 and 100  $\mu\text{g/ml}$ ) of poly(dI-dC) in a binding reaction should be determined empirically. Other nucleic acids that can be used to decrease nonspecific binding include sheared genomic DNA (e.g., from *E. coli*, salmon sperm, or calf thymus), tRNAs, sheared or restricted plasmid DNA, poly(dA-dT), and poly(dG-dC).

*Sequencing gel size standards*

These typically consist of the (A+G) reactions of a Maxam and Gilbert sequencing experiment derived from the target DNA fragment. For a method to perform chemical sequencing reactions, please see Chapter 12, Protocol 7. Alternatively, use a dideoxy terminator sequencing reaction (Chapter 12, Protocols 3–6), of a DNA whose 5' end is identical to the radiolabeled end of the DNA fragment digested with DNase I.

## Radioactive Compounds

*$^{32}\text{P}$ -end-labeled DNA (200–500 bp in length, specific activity  $\geq 2.5 \times 10^7$  cpm/ $\mu\text{g}$   $\geq 5000$  cpm/fmole) <1>*

End labeling of the DNA fragment can be accomplished by phosphorylation (Chapter 9, Protocols 13–16, or Chapter 10, Protocol 2), by filling in of a 3'-recessed end using a DNA polymerase (Chapter 9, Protocols 10 and 11, or Chapter 10, Protocol 7), or by using an end-labeled primer in a polymerase chain reaction (PCR; Chapter 8, Protocol 1). Of these, the latter method is fastest, independent of restriction sites, and allows the positioning of the DNA-binding site at multiple positions relative to the end label. Whatever method of radiolabeling is used, purify the DNA fragment by electrophoresis through an agarose or polyacrylamide gel before use in the footprinting reaction.

The DNA fragment used in the reaction should be 200–500 bp in length, with the binding site of interest at least 30 bp from the radiolabeled end. Resolution on the sequencing gel deteriorates when longer DNA fragments are used. Sites that are too close to an end may not be recognized by the DNA-binding protein or by DNase I.

## Centrifuges and Rotors

*Beckman SW28 rotor or equivalent, chilled to  $4^{\circ}\text{C}$*

*Sorvall H1000B rotor or equivalent, chilled to  $4^{\circ}\text{C}$*

## Special Equipment

*Boiling water bath*

*Dounce homogenizer with type-B pestle*

*Polyallomer or ultraclear swinging-bucket centrifuge tubes*

*Rubber policeman*

## Additional Reagents

*Steps 7–10 of this protocol require the reagents listed in Chapter 12, Protocols 8, 11, and 12.*

## Cells and Tissues

*Fresh tissue, Cultured cells, or Protein fractions derived from cells or tissues*



**CONTROL REACTIONS FOR DNASE I FOOTPRINTING**

At least two control reactions (described in Step 2) should be included in every experiment. A control lacking any DNA-binding protein is required to identify regions of the naked DNA fragment that are resistant to digestion with DNase I or that are only partially digested. A control reaction lacking DNase I but including DNA-binding protein(s) exposes endogenous endonucleases that can give rise to overdigestion and/or nonrandom cleavage patterns. When using partially or highly purified fractions of proteins, the latter control may be unnecessary, provided a contaminating nuclease does not cofractionate with the DNA-binding protein of interest.

When carrying out DNA footprinting for the first time, it is useful to have a positive control in which a ubiquitously expressed DNA-binding protein of high abundance and affinity is assayed. Examples include the nuclear factors Sp1 and NF-1, which bind avidly to DNA fragments containing variations on the sequences CCGCCC and TGGN<sub>3</sub>ACC, respectively. Both of these factors are present in nuclear extracts from cultured HeLa cells, a cell line that is easy to procure and grow. It is worthwhile obtaining these or other positive control reagents before carrying out a DNA footprinting study. Alternatively, several companies sell partially purified preparations of nuclear transcription factors that can be used as positive controls.

**METHOD**

1. Prepare nuclear extracts using one of the following three methods. Alternatively, fractions derived from purification of cellular proteins can be used directly in Step 2.

**PREPARATION OF NUCLEAR EXTRACTS FROM TISSUE**

- a. Dissect and mince 10–15 g of tissue. Adjust the volume of minced tissue to 30 ml with ice-cold tissue homogenization buffer. Homogenize in a tight-fitting Dounce homogenizer until >80–90% of the cells are broken as determined by microscopy.
- b. To monitor lysis, mix 10  $\mu$ l of the cell suspension with an equal volume of 0.4% Trypan Blue dye and examine the solution under a microscope equipped with a 20 $\times$  objective. Lysed cells take up the dye and stain blue, whereas intact cells exclude dye and remain translucent. Continue to homogenize the tissue until >80–90% of the cells are broken.
- c. Dilute the homogenate to 85 ml with ice-cold tissue homogenization buffer. Layer 27-ml aliquots over 10-ml cushions of ice-cold tissue homogenization buffer in ultraclear or polyallomer swinging-bucket centrifuge tubes. Centrifuge the tubes at 103,900g (24,000 rpm in a Beckman SW28 rotor) for 40 minutes at 4°C.
- d. Decant the supernatant and allow the tubes to drain in an inverted position for 1–2 minutes. Place the tubes on ice.  
(Optional) Use a razor blade to cut off the top two thirds of the tube and place the bottom one third containing the nuclei on ice.
- e. Resuspend the pellet of nuclei in 2 ml of ice-cold tissue resuspension buffer. Accurately measure the volume of the resuspended nuclei and add ice-cold 5 M NaCl to a final concentration of 300 mM. Mix the suspension gently. Incubate the suspension for 30 minutes on ice.

- f. Recover the nuclei by centrifugation at 103,900g (24,000 rpm in a Beckman SW28 rotor) for 20 minutes at 4°C. Carefully transfer the supernatant to a fresh tube. Divide the supernatant into aliquots of 100–200  $\mu$ l. Reserve an aliquot for protein concentration determination. Snap-freeze the remainder of the aliquots in liquid nitrogen, and store them in liquid nitrogen.
- g. Determine the protein concentration of the supernatant by the Bradford method.

#### PREPARATION OF NUCLEAR EXTRACTS FROM CULTURED MAMMALIAN CELLS

- a. Harvest  $0.5 \times 10^8$  to  $1 \times 10^8$  cells from their culture flasks, plates, or wells. Collect the cells by centrifugation at 250g (1100 rpm in a Sorvall H1000B rotor) for 10 minutes at room temperature. Rinse the cells several times with phosphate-buffered saline without calcium and magnesium salts.
- b. Resuspend the cell pellet in 5 volumes of ice-cold cell homogenization buffer. Incubate the cells for 10 minutes on ice, and then collect them by centrifugation as before.
- c. Resuspend the cell pellet in 3 volumes of ice-cold cell homogenization buffer containing 0.05% (v/v) Nonidet P-40, and homogenize the cells with 20 strokes of a tight-fitting Dounce homogenizer. The body of the homogenizer should be buried in ice during the homogenization process, during which the swollen cells lyse and release intact nuclei.
- d. Collect the nuclei by centrifugation at 250g (1100 rpm in a Sorvall H1000B rotor) for 10 minutes at 4°C. Remove the supernatant, and resuspend the pellet of nuclei in 1 ml of cell resuspension buffer. Accurately measure the volume of the resuspended nuclei and add 5 M NaCl to a final concentration of 300 mM. Mix the suspension gently and incubate for 30 minutes on ice.
- e. Recover the nuclei by centrifugation at 103,900g (24,000 rpm in a Beckman SW28 rotor) for 20 minutes at 4°C. Carefully transfer the supernatant to a chilled, fresh tube. Divide the supernatant into aliquots of 100–200  $\mu$ l. Reserve an aliquot for protein concentration determination. Quick freeze the aliquots in liquid nitrogen, and store them in liquid nitrogen. Determine the protein concentration of the supernatant by the Bradford method.

#### PREPARATION OF NUCLEAR EXTRACTS FROM SMALL NUMBERS OF CULTURED MAMMALIAN CELLS

This procedure is suitable for cells transfected with plasmids expressing cDNAs encoding transcription factors.

- a. Rinse the cells with several changes of cell rinse buffer. Add 1 ml of the cell rinse buffer to each dish, and scrape the cells into the buffer using a rubber policeman.
- b. Transfer the cell suspension to a 1.5-ml microfuge tube, and pellet the cells by centrifuging at maximum speed for 2 minutes at room temperature in a microfuge.
- c. Resuspend the cell pellet in 300  $\mu$ l of cell resuspension buffer per 150-mm dish of original cells. Subject the resuspended cells to three cycles of freezing and thawing.
- d. Remove the cellular debris by centrifuging the tubes at maximum speed for 5 minutes at 4°C in a microfuge. Store the supernatant (i.e., the cell lysate) in small aliquots at –70°C.

2. To an appropriate number of 1.5-ml microfuge tubes add:

nuclear extract or protein fraction	1–23 $\mu$ l
$^{32}$ P-end-labeled DNA	1–10 fmoles
1 mg/ml poly(dI-dC)	1 $\mu$ l
H <sub>2</sub> O	to 25 $\mu$ l
<i>Optional additions:</i>	
20% Ficoll 400	12 $\mu$ l
or	
10% polyvinyl alcohol	10 $\mu$ l

Centrifuge the tubes for 5 seconds at 4°C in a microfuge to deposit the reaction mixtures at the bottom of the tubes. Incubate the reaction mixtures for 10–30 minutes on ice.

For each DNA fragment or fraction to be assayed, set up two control reactions. One control without the nuclear extract, the other without addition of DNase I in Step 3.

3. Add 50  $\mu$ l of MgCl<sub>2</sub>/CaCl<sub>2</sub> solution at room temperature and mix gently. Incubate the reactions for 1 minute at room temperature. Add 1–8  $\mu$ l of diluted DNase I solution to the microfuge tubes, mix gently, and incubate the reactions for 1 minute at room temperature.
4. Stop the reactions by adding 75  $\mu$ l of stop mix. Vortex briefly and extract the reactions with an equal volume of phenol:chloroform.
5. Transfer the aqueous phases to fresh microfuge tubes, and precipitate the nucleic acids with 2.5 volumes of ethanol. Chill the ethanolic solution for 15 minutes at –70°C, and collect precipitates by centrifugation at maximum speed for 10 minutes at 4°C in a microfuge. Rinse the pellets with 1 ml of 70% ethanol, centrifuge again, and dry in the air to remove the last traces of ethanol.
6. Solubilize the DNA pellets in 5–10  $\mu$ l of formamide dye mix by vigorous vortexing. Denature the DNA solutions by boiling for 3–5 minutes.
7. Set up a denaturing 6% or 8% polyacrylamide sequencing gel and run the gel for at least 30 minutes before loading the DNA samples.
8. Load the DNA samples in the following order:
  - sequence ladder
  - control DNA digested with DNase I in the absence of nuclear extract
  - target DNA from reactions digested with DNase I in the presence of nuclear extract
  - target DNA incubated with nuclear extract and no DNase I
9. Run the gel at sufficient constant power to maintain a temperature of 45–50°C.
  - The time required to achieve optimal resolution of the sequence of interest must be determined empirically. Monitor the progress of the electrophoretic run by following the migration of the marker dyes in the formamide gel-loading buffer.
10. After electrophoresis is complete, pry the glass plates apart and transfer the gel to a piece of thick blotting paper. Dry the gel under vacuum for ~1 hour, and expose it to X-ray film without an intensifying screen for 12–16 hours at –20°C. Alternatively, subject the dried gel to phosphorimage analysis for 1–3 hours.

#### TROUBLESHOOTING AND OPTIMIZATION OF DNASE I FOOTPRINTING

- The concentration of monovalent cations in the reaction mixture (Step 2) should be <200 mM and is typically in the 50 mM range. Higher concentrations are almost always inhibitory, disrupting interactions between proteins and negatively charged DNA. High-salt fractions from chromatography steps should be diluted appropriately, dialyzed against low-salt buffers, or passed through a Centricon or desalting column before assaying.
- Buffering in the DNase I footprinting assay is provided by the ingredients of the nuclear extract. If this proves unsatisfactory, then in Step 2, include the following components at the listed final concentrations: 20 mM HEPES-KOH (pH 7.9)/50 mM KCl/2 mM MgCl<sub>2</sub>/0–4 mM spermidine/0–0.02 mM zinc acetate/0.1 µg/ml bovine serum albumin/10% (v/v) glycerol/0.5 mM dithiothreitol.
- The optimum concentration of magnesium should be determined empirically for each DNA fragment. With each new binding site or DNA fragment, a magnesium titration curve should be set up by varying the concentration of magnesium (try a range of 0.1–10 mM) while keeping all other variables constant. Similarly, the optimum temperature (from 0°C to 37°C) of binding and protection should be determined in trial reactions.
- The amount of protein extract required to visualize a footprint depends on the abundance of the factor of interest and the affinity of the protein for the DNA. Relatively abundant transcription factors such as Sp1 (Dyran and Tjian 1983) and NF-1 (Rosenfeld and Kelly 1986) can be detected in 1–20 µg of crude nuclear extract protein obtained from cultured mammalian cells (e.g., HeLa cells). In worst case scenarios, such as the sterol regulatory element-binding proteins (SREBPs), nuclear extract must be purified blindly through one or more chromatographic steps before footprinting activity can be detected (Briggs et al. 1993; Wang et al. 1993). The standard methods of preparing nuclear extracts described in Protocol 1 derived from the classical procedures of Dignam et al. (1983) and Manley et al. (1983).
- The concentration of DNase I required to produce a convincing ladder of DNA fragments usually varies between 50 and 500 ng/ml. The exact concentration must be determined empirically and can vary from one DNA fragment to another and among different preparations of the same fragment. Cleavage depends on the specific activity of the DNase I, the purity of the DNA fragment, and, to a lesser extent, the sequence of the DNA fragment in question. Some investigators find it easier to vary the incubation time or temperature in Step 3, rather than to vary the amount of DNase I added to the reaction.

**ALTERNATIVE PROTOCOL: MAPPING PROTEIN-BINDING SITES ON DNA BY HYDROXYL RADICAL FOOTPRINTING**

DNase I does not cleave DNA at random, and as a consequence, the pattern of bands detected in a footprinting experiment will not represent cleavage at every phosphodiester bond in the probe. As long as the enzyme cleaves at one or more points within the sequence protected by a DNA-binding protein, a binary complex can be inferred. However, an interaction can be missed if the protein of interest binds between two points of DNase I cleavage. To avoid this problem and to increase the resolution of footprinting to the nucleotide level, Tullius and Dombroski (1986) introduced a chemical cleavage method termed hydroxyl radical footprinting that relies on the ability of hydroxyl radicals generated by Fe(II)-catalyzed reduction of  $O_2$  or  $H_2O_2$  to cleave the DNA backbone. The method is straightforward; the chemical reagent cleaves essentially all phosphodiester bonds equally and is inert to most buffer components. Unlike DNase I footprinting, the method can sometimes provide detailed information regarding relative affinities between a protein and individual nucleotides within a recognition sequence.

**Additional Materials***Fe(II)-EDTA solution*

Prepare a solution of 0.4 mM Fe(II) by dissolving an appropriate amount of  $(NH_4)_2Fe(SO_4)_2 \cdot 6H_2O$  in  $H_2O$ . Prepare a 0.8 mM solution of EDTA. Mix equal volumes of the 0.4 mM Fe(II) and 0.8 mM EDTA solutions to make the Fe(II)-EDTA solution; 1  $\mu$ l of this solution is used per reaction.

*0.6% hydrogen peroxide**20 mM sodium ascorbate**3 M sodium acetate (pH 5.5)**TE (pH 8.0)**0.1 M thiourea*

▲ **IMPORTANT** Prepare all of the additional materials just before beginning Step 3 below.

*Timer***Method**

1. Prepare nuclear extracts as described in Step 1 of the main protocol, or use fractions derived from purification of cellular proteins.
2. Form protein-DNA complexes as described in Step 2 of the main protocol, making sure that the final concentration of glycerol (a hydroxyl radical scavenger) in the reaction is <0.5% (v/v).  
Glycerol is a component of the homogenization or resuspension buffer used in Step 1.
3. Carefully pipette 1  $\mu$ l of the Fe(II)-EDTA solution, 1  $\mu$ l of 0.6% hydrogen peroxide, and 1  $\mu$ l of 20 mM sodium ascorbate at a single position on the side of the tube containing the protein-DNA complex. Mix these reagents by pipetting up and down. Start a timer and tap the side of the tube to mix the cleavage reagents and the protein-DNA solution. Allow the cleavage reaction to proceed for 1–2 minutes at room temperature.

The time and temperature of incubation can be varied to optimize detection of a footprint.

4. Stop the reaction by the addition of 2  $\mu$ l of 0.1 M thiourea and 2.5  $\mu$ l of 3 M sodium acetate (pH 5.5). Mix the contents of the tube and add 100  $\mu$ l of ethanol. Precipitate the DNA on ice for 15 minutes. Recover the nucleic acids by centrifugation at maximum speed for 10 minutes in a microfuge.
5. Dissolve the DNA pellet in 100  $\mu$ l of TE (pH 8.0). Extract the DNA with 100  $\mu$ l of phenol:chloroform and then with chloroform alone. Precipitate the aqueous phase with ethanol and collect the precipitated DNA by centrifugation at maximum speed for 10 minutes in a microfuge. Rinse the pellet with 1 ml of 70% ethanol, centrifuge briefly, and dry in air to remove the last traces of ethanol.
6. Analyze the samples by gel electrophoresis as described in Steps 6–10 of the main protocol.  
Autoradiography or phosphorimaging should reveal a ladder corresponding to cleavage at adjacent phosphodiester bonds in the control reaction without protein; an intact DNA fragment in the control that was not exposed to the Fe(II)-EDTA solution; and footprints in the test lanes containing target DNA.

# Protocol 2

---

## Gel Retardation Assays for DNA-binding Proteins

**G**EL RETARDATION ASSAYS FOR DNA-BINDING PROTEINS, developed by Fried and Crothers (1981), provided the first kinetic analyses of the interactions of the *Escherichia coli* lactose repressor with its DNA-binding site. The simplicity and sensitivity of the reaction and the quantitative nature of the assay led to its rapid adoption by the growing community of researchers studying transcription and gene regulation. The assay is now routinely used to follow the purification of DNA (or RNA)-binding proteins, to determine the sequence requirements of a known or suspected DNA-binding protein, to establish reaction constants (e.g., affinity binding constants and on/off rates), and to study protein-protein assembly or the interactions of multiple proteins on gene sequences (please see the information panel on **GEL RETARDATION ASSAYS**).

The assay, which is straightforward, exploits electrophoretic mobility differences between a rapidly migrating DNA containing a binding site and a more slowly migrating complex of protein bound to DNA. Typically, the DNA fragment is radiolabeled with  $^{32}\text{P}$ , whereas the proteins are unlabeled. Binding of the DNA by a protein leads to a complex with an electrophoretic mobility characteristic of the protein. The method is exquisitely sensitive, because high-specific-activity DNA probes can be used and because a phenomenon known as "caging" occurs within the polyacrylamide gel (Cann 1989). Caging is thought to occur because the protein-nucleic acid complexes migrate through the pores of the gel during electrophoresis, which transiently increases their concentrations over and above that in an aqueous solution. This concentration in turn shifts the binding equilibrium in favor of complex formation and allows the detection of even very weak binding interactions. The following method for gel retardation assays is derived in part from a protocol provided by Michael Briggs (Pharmacia Corp., St. Louis).

### MATERIALS

---

**CAUTION:** Please see Appendix 12 for appropriate handling of materials marked with <!>.

#### Buffers and Solutions

Please see Appendix 1 for components of stock solutions, buffers, and reagents. Dilute stock solutions to the appropriate concentrations.

*Ficoll 400 (20% w/v)*

Dissolve the solute in sterile  $\text{H}_2\text{O}$  and store the solution in 100- $\mu\text{l}$  aliquots at  $-20^\circ\text{C}$ .

*Polyvinyl alcohol (10% w/v)*

Dissolve the solute in sterile  $\text{H}_2\text{O}$  and store the solution in 100- $\mu\text{l}$  aliquots at  $-20^\circ\text{C}$ .

*Sucrose dye solution*

0.25% (w/v) bromophenol blue

0.25% (w/v) xylene cyanol

40% (w/v) sucrose (dextrose)

Dissolve the solutes in H<sub>2</sub>O and pass the solution through a 0.22- $\mu$ m filter; store the filtrate at room temperature or 4°C.

*10x Tris-glycine or Tris-borate-EDTA (TBE) buffer*

## Gels

*Neutral 4–7% polyacrylamide gel ( $\leq 1.5$  mm in thickness) <1>*

## Nucleic Acids and Oligonucleotides

*Poly(dI-dC) (1 mg/ml)*

Dissolve an appropriate amount of poly(dI-dC) in sterile H<sub>2</sub>O and store the solution in 100- $\mu$ l aliquots at -20°C. For additional information on the role of poly(dI-dC) in gel retardation experiments, please see the panel on **POLY(dI-dC)**.

## Radioactive Compounds

*<sup>32</sup>P-labeled control DNA <1>*

*<sup>32</sup>P-labeled target DNA of >20 bp (specific activity  $\geq 2.5 \times 10^7$  cpm/ $\mu$ g [ $\geq 5000$  cpm/fmole])*

Labeling of the DNA fragment can be accomplished by phosphorylation (Chapter 9, Protocols 13–16, or Chapter 10, Protocol 2), filling in of a 3'-recessed end using a DNA polymerase (Chapter 9, Protocols 10 and 11, or Chapter 10, Protocol 7), or by using PCR to incorporate radiolabeled nucleotides into the body of the probe (Chapter 8, Protocol 1). Of these, the latter method is fastest and provides probes of the highest specific activity. For suggestions on how to radiolabel the DNA probe, please see the panel on **TROUBLESHOOTING AND OPTIMIZATION OF GEL RETARDATION ASSAYS** at the end of this protocol.

## Special Equipment

*Blotting paper*

## Cells and Tissues

*Control nuclear extract or protein fraction*

*Nuclear extract or Protein fraction(s)*

Prepare the extract by one of the methods described in Protocol 1. In-vitro-translated protein made in rabbit reticulocyte lysates or wheat germ extracts can also be used as a source of DNA-binding proteins. In the latter cases, aliquots of 1–20  $\mu$ l are typically used in place of a nuclear extract.

### **POLY(dI-dC)**

This nucleic acid polymer is added to gel retardation assays to reduce nonspecific binding of proteins to the radiolabeled DNA fragment. The amount recommended in Step 1 (50  $\mu$ g/ml of reaction) is a median value. The optimum amount (usually between 0 and 100  $\mu$ g/ml) of poly(dI-dC) added to a reaction should be determined empirically for each DNA-binding activity. Other nucleic acids that can be used to decrease nonspecific binding include sheared genomic DNA (e.g., from *E. coli*, salmon sperm, or calf thymus), tRNAs, sheared or restricted plasmid DNA, poly(dA-dT), or poly(dG-dC). When assaying for binding proteins whose recognition sites are immediately adjacent to one another, using one binding site as a competitor can reveal the presence of protein binding to the adjacent site. This approach can be crucial when one DNA-binding protein is present in the nuclear extract at a much lower concentration than the other (e.g., a basal transcription factor such as Sp1 vs. a rare regulatory protein). Once specific binding of a nuclear protein to a target DNA sequence has been established in a gel retardation assay, it is a good idea to vary the nonspecific competitor. For example, if a protein of interest binds to a particular sequence in the presence of 10  $\mu$ g/ml of poly(dI-dC), substitute 10  $\mu$ g/ml of poly(dG-dC) for the poly(dI-dC) in the reaction and determine the consequences for binding. Many examples exist in the literature in which changing the concentration or identity of the carrier nucleic acid dramatically affects the results, sometimes simply enhancing binding, or, in more extreme cases, revealing completely different binding activities.

## METHOD

---

1. To a sterile 1.5-ml microfuge tube add:

<sup>32</sup> P-labeled target DNA	1 ng (1–10 fmole)
1 mg/ml poly(dI-dC)	1 $\mu$ l
nuclear extract (5–10 $\mu$ g)	$\leq$ 10 $\mu$ l
or	
protein fraction	$\leq$ 10 $\mu$ l
20% Ficoll 400	5 $\mu$ l
or	
10% polyvinyl alcohol	4 $\mu$ l
H <sub>2</sub> O	to 20 $\mu$ l

Include control reactions with every experiment. Positive control reactions contain a nuclear extract (or protein fraction) and a radiolabeled DNA fragment carrying a sequence recognized by a DNA-binding protein that is abundant in the extract and has high affinity for the DNA sequence. Examples are a DNA fragment containing an Sp1, C/EBP, or NF-1 site and mammalian cell nuclear extract, or a *lacI* recognition site and extract derived from a *lacI<sup>q</sup>* strain of *E. coli*. The negative control reactions contain the radiolabeled target DNA fragment, but no nuclear extract.

- Centrifuge the reaction tubes for several seconds in a microfuge to deposit the reaction mixtures at the bottom of the tubes. Incubate the reactions for 10–30 minutes on ice.
- Add 3  $\mu$ l of sucrose dye solution to each tube. Load the samples into the slots of a neutral 4–7% polyacrylamide gel.
- Run the gel in either 0.5x Tris-glycine buffer or 0.5x TBE buffer at 200–250 V and 20 mA for  $\geq$ 2 hours.
 

Depending on the lability of the binding protein(s) and the affinity of the binding reaction(s), it may be necessary to run the gel at 4°C.
- After electrophoresis is complete, pry the gel plates apart, transfer the gel to a piece of sturdy blotting paper, and dry the gel for ~1 hour on a gel dryer.
- Expose the dried gel to X-ray film for  $\geq$ 1 hour at –20°C to visualize radiolabeled DNA fragments. Less abundant DNA-protein complexes can be detected after 1–3-hours on a phosphorimager.



**TROUBLESHOOTING AND OPTIMIZATION OF GEL RETARDATION ASSAYS**

- The concentration of monovalent cations in the reaction mixture (Step 1) should be <200 mM and is typically in the 50 mM range. Higher concentrations are almost always inhibitory. High-salt fractions from chromatography steps should be diluted appropriately, dialyzed against low-salt buffers, or passed through a Centricon or desalting column before assaying.
- Buffering in the gel retardation assay is provided by the ingredients of the nuclear extract. If buffering proves to be unsatisfactory, include the following components at the listed final concentrations: 20 mM HEPES-KOH (pH 7.9)/50 mM KCl/2 mM MgCl<sub>2</sub>/0–4 mM spermidine/0–0.02 mM zinc acetate/0.1 µg/ml bovine serum albumin/10% (v/v) glycerol/0.5 mM dithiothreitol.
- The DNA fragment used in the reaction should be longer than 20 bp, with the recognition sequence at least 4 bp away from each end of the fragment. Polymerizing the recognition sequence by ligation of monomer sites or by chemical synthesis may enhance detection of rare or low-affinity binding proteins.
- Phosphatases or exonucleases present in crude nuclear extracts can remove radioactive nucleotides from the ends of DNA probes, generating unlabeled binding sites that can act as competitors of the binding reaction. Probes should have blunt ends to avoid high backgrounds caused by the abundant and nonspecific single-stranded nucleic-acid-binding proteins present in many cells. For this reason, double-stranded probes formed by annealing single-stranded oligonucleotides should be checked by polyacrylamide gel electrophoresis for completion of annealing. If a significant proportion of single-stranded oligonucleotides remain, then adjust the concentrations of the oligonucleotides in subsequent annealing reactions. An advantage to using the Klenow fragment of *E. coli* DNA polymerase I to fill and radiolabel a probe is that the enzyme will only act on double-stranded DNAs. Single-stranded DNA or unhybridized oligonucleotides from an incomplete annealing reaction will not be radiolabeled by Klenow enzyme, and thus any protein-DNA complexes involving them will not be visualized in the autoradiogram or phosphorimage of the gel.
- The optimum concentration of Mg<sup>2+</sup> should be determined empirically for each DNA-binding protein. With a new binding site or DNA probe, an Mg<sup>2+</sup> titration curve should be set up by varying the concentration of Mg<sup>2+</sup> (try a range of 0.1–10.0 mM) while keeping all other variables unchanged. Similarly, the optimum temperature (from 0°C to 37°C) of binding and the effects of exogenously added stabilizing proteins (e.g., albumin and cytochrome c) should be determined in trial reactions.
- Addition of bystander proteins to the reaction mixture can sometimes stabilize a given protein-DNA interaction. Proteins that have been used in this way include bovine serum albumin, milk proteins (BLOTTO, which is non-fat dried milk), cytochrome c, fetuin, bovine milk casein, thyroglobulin, asialofetuin, and bovine submaxillary mucin (type 1), all at 0.015–1 mg/ml. These proteins sometimes act by stabilizing a dilute transcription factor or DNA-binding protein. More often than not, however, the mechanism is unknown and the best additive must be determined by trial and error. Steroid hormone receptors and certain other transcription factors are stimulated by the addition of sodium molybdate at concentrations between 0.1 and 5.0 mM. The addition of standard reagents that enhance protein stability (e.g., protease inhibitors, phosphatase inhibitors, kinase inhibitors, and glycerol) may improve the binding between protein and DNA.
- As with DNA footprinting, the amount of protein extract required to visualize a retained band depends on the abundance of the factor of interest and the affinity of the protein for the DNA. It may be necessary to purify the protein through several chromatographic steps to remove inhibitors or to increase factor abundance to detectable levels. The use of DNA affinity chromatography to purify a DNA-binding protein should be delayed until a given fraction is substantially free of endogenous nucleases.
- The best resolution of retained protein-DNA complexes is usually obtained on polyacrylamide gels that contain between 4% and 7% polyacrylamide. A ratio of acrylamide to bis-acrylamide of 29:1 provides good resolution. An optimum gel size is 20 × 20 cm with 1.5-mm spacers. The choice of buffer used in the gel is often a matter of convenience. Laboratories that keep concentrated stocks of TBE for use in agarose and polyacrylamide gel electrophoresis use 0.5x TBE in gels to separate stocks and free probes, whereas laboratories that spend more time doing protein gel electrophoresis will typically use Tris-glycine buffers. These buffers can also be used at 0.25x concentration in the polyacrylamide gel.

**ADDITIONAL PROTOCOL: SUPERSHIFT ASSAYS**

The identity of a DNA-binding protein in a particular band detected in a gel retardation assay can often be identified by using specific antibody probes to "supershift" the complex (Kristie and Roizman 1986). In this type of experiment, an antibody against the suspected protein is added to the reaction mixture before, during, or after formation of the complex, and the reaction mixture is separated on the gel. If the antibody recognizes the band in question, then the mobility of the complex will shift to a larger size due to the formation of a ternary complex between the antibody, DNA-binding protein, and the DNA probe. In some cases, addition of antibody disrupts the formation of the complex rather than increasing its molecular weight. A similar experimental design can be used to study interactions between different protein components of transcription factor complexes that assemble on eukaryotic promoters (Lieberman and Berk 1991).

Antibodies directed against a variety of eukaryotic transcription factors are available from several companies. These antibodies can be used both to identify a known factor and as positive controls in the supershift assay.

**Additional Materials***Antibody against the protein of interest*

This is usually an IgG fraction arising from a rabbit polyclonal antiserum (Harlow and Lane 1988).

**Method**

1. Incubate varying amounts of antibody with the nuclear extract preparation to be used in Step 1 of the main protocol for 10–30 minutes at room temperature. The amount of antibody to add depends on the affinity of the antiserum and the abundance of the transcription factor. Try a range between 1 and 100  $\mu\text{g}$  of antibody per standard gel retardation reaction.
2. After the incubation, add the DNA probe and the other ingredients listed in Step 1 of the main protocol, and carry out the remaining procedures in the main protocol. Addition of antibody should disrupt or shift the mobility of the complex in question.

Although a particular antibody may recognize the transcription factor of interest in an immunoblotting or immunoprecipitation experiment, the same antibody may not work in a supershift assay. This discrepancy is usually due to the inability of the antibody to recognize the native protein. The best solution is to use another antiserum that recognizes a different epitope on the transcription factor. Other solutions include increasing the concentration in the binding buffer, adding low concentrations (0.01–0.5%) of nonionic detergents (e.g., Tween-20, Nonidet P-40, and Triton X-100) to the binding buffer, or increasing the amount of antibody in the reaction. The temperature at which the preincubation step is performed can be varied between 0°C and 37°C to facilitate antibody recognition and complex stability. Finally, experiments can be carried out to determine if addition of the antibody before or after the DNA probe affects the supershift.

**ADDITIONAL PROTOCOL: COMPETITION ASSAYS**

The specificity of an observed DNA-binding reaction can be tested in competition assays in which an excess of unlabeled probe is added together with the radiolabeled probe during Step 1 of the main protocol. Specific DNA binding is usually defined as that which is competed by a reasonable excess of unlabeled probe. For most transcription factors that exhibit high-affinity binding to a target DNA sequence, a 10–100-fold molar excess of unlabeled probe should eliminate the radiolabeled complex.

Competition assays can also be used to identify a protein that is present in a given retained band. For example, if a probe encompassing the 5'-flanking region of a gene is used that contains several different recognition elements within its sequence and thus gives rise to multiple DNA-protein complexes with different mobilities, then addition of a 100-fold molar excess of an oligonucleotide containing a known recognition sequence such as that bound by the Sp1 factor should eliminate the band corresponding to Sp1-DNA complexes. Similar competition assays with oligonucleotides eliminating other recognition sequences can identify proteins present in other complexes, and antibodies against the suspected transcription factors can be used in supershift assays (please see the panel on **ADDITIONAL PROTOCOL: SUPERSHIFT ASSAYS**) to confirm a tentative identification.

Finally, competition assays can be used to identify important nucleotides in the binding site of a given transcription factor. By carrying out a series of competition assays using oligonucleotides that differ in a single nucleotide from that used to identify the binding protein, crucial nucleotides within the recognition element can be quickly identified.

# Protocol 3

---

## Mapping DNase-I-hypersensitive Sites

**T**HE CONTROL REGIONS IN A EUKARYOTIC GENE CAN OFTEN BE LOCALIZED by mapping DNase-I-hypersensitive sites. For reasons that are not well understood, genes contain discrete sequences of DNA that are sensitive to DNase I cleavage, and the pattern of these so-called hypersensitive sites changes depending on the activation state of the gene (Weintraub and Groudine 1976). By comparing the pattern of hypersensitive sites obtained by cleavage of a quiescent gene with that obtained when the gene is actively transcribed, regions that participate in gene regulation (either induction or suppression) can be identified. A major strength of the method is that it makes no a priori assumptions about the locations of control sequences and thus allows an investigator to examine many hundreds of kilobases of DNA for potential regulatory sequences.

A case that illustrates the power of DNase I hypersensitivity mapping is the identification of the locus control region, a master regulatory sequence that directs the complicated temporal and cell-type-specific transcription patterns of multiple linked hemoglobin genes and that maps ~10 kb away from the first gene in the cluster (Tuan et al. 1985; Forrester et al. 1986). These sequences, which contain several DNase-I-hypersensitive sites, are both necessary and sufficient for the expression of globin genes in erythroid cells (Grosfeld et al. 1987; Townes and Behringer 1990). Similar success stories have been realized with many other genes (for review, please see Gross and Garrard 1988).

Several theories have been proposed to explain the occurrence of DNase-I-hypersensitive sites (Gross and Garrard 1988). The best of these ideas is that the sites represent regions of the DNA from which nucleosomes have been displaced by the binding of transcription factors and/or DNA unwinding proteins. In turn, the bound proteins are thought to lead to enhanced transcription of the gene, either directly by interacting with components of the basal transcription apparatus or indirectly by establishing a conformation conducive to transcription (Wallrath et al. 1994). A variety of functional sequences are associated with DNase-I-hypersensitive sites, including enhancers, silencers, developmental control regions, and tissue-specific regulatory regions. For this reason, mapping hypersensitive sites in the nuclei of different tissues or at different times of development can provide a wealth of information about the expression of a target gene.

The most popular method of mapping hypersensitive sites involves the isolation of nuclei from a cell or tissue of interest followed by incubation of the intact nuclei with varying amounts of DNase I. A control incubation is also carried out that contains no exogenous DNase I. The genomic DNA from the treated and control nuclei is then purified by phenol:chloroform extraction and incubated with a restriction enzyme. The fragments of DNA are separated by agarose gel

electrophoresis, transferred to a membrane filter, and hybridized to a labeled probe derived from the target gene. If the probe corresponds to the 5' end of the gene, then only the restriction fragments arising from that region will be detected by the probe in the no-DNase-I control. If DNase I was included in the initial incubation and a hypersensitive site exists in one or more of the DNA fragments recognized by the probe, then shorter DNAs will be detected on the Southern blot corresponding to fragments that were cleaved at one end by the restriction enzyme and at the other end by the DNase I. By determining the size of the doubly cleaved DNAs, the position of the hypersensitive site can be deduced and the location of a potential control sequence inferred. The exact location of the regulatory region can be mapped to within  $\pm 50$  nucleotides by using different restriction enzymes and probes. With additional effort and the use of the polymerase chain reaction (PCR), the position of a hypersensitive site can be pinpointed to within a few nucleotides of the site (Pfeifer 1992).

In summary, DNase I hypersensitivity mapping is an excellent method to map potential regulatory regions both within and distal to a target gene. The technique is especially useful (1) in the early stages of promoter analysis when the locations of the regulatory sequences are unknown and (2) in analyzing genes that exhibit tissue-specific regulation (for further details on the activities and properties of DNase I, please see Appendix 4). The following protocol originated in Bob Tjian's laboratory (University of California at Berkeley) and was provided by Tim Hoey (Tularik, Inc., South San Francisco, California).

## MATERIALS

**CAUTION:** Please see Appendix 12 for appropriate handling of materials marked with <!.>.

### Buffers and Solutions

Please see Appendix 1 for components of stock solutions, buffers, and reagents. Dilute stock solutions to the appropriate concentrations.

#### Buffer A

- 50 mM Tris-Cl (pH 7.9)
- 100 mM NaCl
- 3 mM MgCl<sub>2</sub>
- 1 mM dithiothreitol
- 0.2 mM phenylmethylsulfonyl fluoride<!.>

Store Buffer A at 4°C. Add dithiothreitol and PMSF to Buffer A just before use.

#### EDTA (0.5 M, pH 8.0)

#### Ethanol

#### Lysis buffer

- 50 mM Tris-Cl (pH 7.9)
- 100 mM KCl
- 5 mM MgCl<sub>2</sub>
- 0.05% (v/v) saponin
- 50% (v/v) glycerol
- 200 mM  $\beta$ -mercaptoethanol <!.>

Store lysis buffer at 4°C. Add  $\beta$ -mercaptoethanol to the lysis buffer just before use.

#### Phenol:chloroform <!.>

#### Phosphate-buffered saline without calcium and magnesium salts

#### SDS buffer

- 20 mM Tris-Cl (pH 7.9)
- 100 mM NaCl
- 70 mM EDTA (pH 8.0)
- 2% (w/v) SDS

Store the SDS buffer at room temperature.

TE

*Trypan Blue dye (0.4% w/v)*

Dissolve an appropriate amount of dye in phosphate-buffered saline without calcium and magnesium salts. Store the solution at room temperature.

## Enzymes and Buffers

*DNase I dilution buffer*

10 mM HEPES-KOH (pH 7.9) <math>^{!}>

30 mM  $\text{CaCl}_2$

30 mM  $\text{MgCl}_2$

50% (v/v) glycerol

*DNase I solution*

Dilute a preparation of RNase-free DNase I to a concentration of 10 units/ $\mu\text{l}$  using DNase dilution buffer. Store the solution at  $-20^\circ\text{C}$ . One unit is defined as the amount of DNase that will cause a change in  $A_{260}$  of 0.001/minute/ml of a reaction using a calf thymus DNA substrate.

*Proteinase K solution*

Dissolve proteinase K at 0.2 mg/ml in a solution of 50 mM Tris-Cl (pH 7.9) and 100 mM NaCl. Store the solution in small aliquots at  $-20^\circ\text{C}$ .

*RNase solution*

Dissolve a preparation of DNase-free RNase at a concentration of 0.5 mg/ml in TE (pH 8.0).

## Centrifuges and Rotors

*Sorvall H1000B rotor or equivalent*

## Special Equipment

*Screw-cap tubes (50 ml)*

*Shaking water baths preset to  $50^\circ\text{C}$  and  $55^\circ\text{C}$*

## Additional Reagents

*Step 18 of this protocol requires the reagents listed in Chapter 6, Protocols 8 and 10.*

## Cells and Tissues

*Eukaryotic cells*

Approximately  $10^8$  cells are required per DNase I hypersensitivity mapping experiment.

## METHOD

---

1. Harvest  $\sim 10^8$  cells from spinner cultures, flasks, or dishes, and wash the cells twice with 25-ml aliquots of ice-cold phosphate-buffered saline without calcium and magnesium salts.  
Alternatively, if starting with fresh tissue, isolate the nuclei as described in Protocol 1, Step 1.
2. Resuspend the cell pellet from the final wash in 1.5 ml of ice-cold lysis buffer. Incubate the cells for 10 minutes on ice to allow cell lysis to occur.
3. Mix a 10- $\mu\text{l}$  aliquot of cell lysate with an equal volume of 0.4% Trypan Blue dye and examine the solution under a microscope equipped with a 20x objective. Lysed cells and nuclei take up the dye and appear blue, whereas unlysed cells are impermeable to the dye and remain translucent. Continue the incubation on ice until  $>80\%$  of cells are lysed.
4. Recover nuclei from the lysed cells by centrifugation of the suspension at 1300g (2500 rpm in a Sorvall H1000B rotor) for 15 minutes at  $4^\circ\text{C}$ .
5. Carefully remove the supernatant and resuspend the pellet of nuclei in 1.5 ml of ice-cold Buffer A. Collect the nuclei by centrifugation as described in Step 4.

6. Resuspend the nuclear pellet in 4 ml of ice-cold Buffer A.
7. Set up a series of dilutions of the standard DNase I solution (1/40, 1/80, 1/160, 1/320, 1/640, 1/1280, and 1/2560 in DNase dilution buffer). Store the dilutions on ice.
8. Label a series of tubes 1 through 9 and add 180  $\mu$ l of resuspended nuclei from Step 6 to each tube.
9. To Tube 1, add 20  $\mu$ l of DNase I dilution buffer containing no DNase I and store the tube on ice until Step 12, below. To Tube 2, add 20  $\mu$ l of DNase I dilution buffer containing no DNase and incubate as described in Step 11, below. Tubes 1 and 2 are controls.
10. To Tubes 3 through 9, add 20  $\mu$ l of each of the progressive dilutions, i.e., to Tube 3, add 20  $\mu$ l of the 1/2560 dilution, to Tube 4, add 20  $\mu$ l of the 1/1280 dilution, etc.
11. Incubate Tubes 2–9 for 20 minutes at 37°C.
12. Terminate the reactions by adding three individual aliquots of 16.6  $\mu$ l of 0.5 M EDTA to each tube, with vortexing between additions. When all of the tubes have been treated, add 12  $\mu$ l of RNase solution to each tube. Incubate the reactions for 30 minutes at 37°C to allow digestion of nuclear RNA.
13. Digest nuclear proteins by adding 40  $\mu$ l of proteinase K solution to each tube. Mix the solution gently by pipetting the mixture up and down. Add 100  $\mu$ l of SDS buffer to each tube and mix once more. Incubate the tubes for 16 hours at 50°C with rotation or rocking.
14. Add an additional aliquot of 100  $\mu$ l of proteinase K solution and continue the digestion for a further 2–3 hours at 50°C.
15. Extract the digestion mixtures three times with phenol:chloroform. Be gentle. Precipitate the DNA with the addition of 3 volumes of ice-cold ethanol, incubate for 30 minutes on ice, and collect the DNA precipitates by centrifugation at 1200g (2400 rpm in a Sorvall H1000B rotor) in a benchtop centrifuge. Decant the supernatant and drain the last dregs of ethanol from the tubes on a paper towel.
16. Add 200  $\mu$ l of TE to each tube and allow the DNA to redissolve with rocking or rotation overnight at 55°C.
  - ▲ **IMPORTANT** An extended incubation is required for complete solubilization and recovery of the DNase-treated DNA.
17. Determine the  $A_{260}$  of the resuspended DNA and estimate the concentration.
18. Digest the DNA with a restriction enzyme(s), followed by Southern blotting and hybridization as described in Chapter 6, Protocols 8 and 10. Load 15–30  $\mu$ g of restricted genomic DNA per lane on the agarose gel.

#### HYBRIDIZATION PROBES

DNA fragments produced by DNase I cleavage can be present in substoichiometric mass relative to the parental uncleaved fragment. This situation can arise due to incomplete cleavage of sensitive sites, incomplete occupation of a binding site by a nuclear regulatory factor, intercellular variations in gene expression, or, when working with tissues, the presence of diverse cell types with different gene expression patterns. For these reasons, it is crucial to use high-specific-activity radioactive probes when mapping hypersensitive sites. The specific activity of the probe, as determined using methods described in Appendix 8, should be  $>5 \times 10^8$  cpm/ $\mu$ g. Single-stranded DNA probes derived from bacteriophage M13 templates (Chapter 3, Protocol 4) are sensitive high-specific-activity probes that are complementary to short regions (~200 nucleotides of the target DNA). They are thus ideal for high-resolution hypersensitivity mapping experiments.

**CONTROLS FOR DNASE I HYPERSENSITIVITY MAPPING**

After completion of Southern blotting and visualization of the hybridized probe by autoradiography or phosphorimaging analysis, one or more additional bands should be seen in lanes containing DNA digested with DNase I. These bands are shorter than the intact, undigested fragment detected by the labeled probe, usually not as sharp, and, sometimes, not as intense. They should not be present in the controls lacking DNase I (Tubes 1 and 2 in the protocol). If the correct range of DNase I concentrations was used, the additional bands will be absent in the low end of the titration range, clearly visible in the mid-range, and lost in a broad smear at the high end of the range of nucleolytic enzyme. The amount of DNase I added to the nuclei can be increased or decreased to compensate for under- or overdigestion in order to obtain the perfect cosmetic result. Sites that appear at relatively low concentrations of DNase I enzyme are sometimes referred to as "major" sites, whereas those that appear at higher enzyme concentrations are labeled "minor" hypersensitive sites (e.g., please see Tuan et al. 1985).

To obtain results of this sort requires that the appropriate regulatory regions of the gene be examined with the appropriate probe. When starting the analysis of regulatory regions in a new gene, it is a good idea to set up a series of control reactions in which a DNase-I-hypersensitive site in a control gene is examined with a defined restriction digest and probe. Ideally, the control gene should be regulated by the same physiological events as the target gene. The choice of probes should be made without assuming where regulatory sequences might lie. Thus, probes should be designed to allow examination of all regions of a target gene. Although most regulatory regions occur immediately 5' to the gene, it is not uncommon for control sequences to map to the extreme 5' - and 3' -flanking regions of a gene or in an intron.

DNase-I-hypersensitive site mapping suffers from several inherent limitations. Small DNA fragments (<1 kb) arising from the action of DNase on a unique gene in a complex mammalian genome are difficult to visualize by blotting and Southern hybridization. Furthermore, there is a good deal of variation in signal strength between experiments. These problems can usually be overcome by using more than one restriction enzyme and probe in the experiments, by using more than one cell source of nuclei (e.g., expressing and nonexpressing cells, stimulated or nonstimulated cells, and different cell lines), and by simply repeating successful experiments. By using restriction enzyme double digests and various probes, it is possible to position the undigested and digested DNA fragments in the range of maximum resolution (1–10 kb) on the Southern blot. In addition, these conditions allow fine-structure mapping and ultimate positioning of the hypersensitive site on the gene map.

As mentioned in the introduction to this protocol, hypersensitive sites often mark sequences that are important for target gene expression. Once a hypersensitive site has been identified, then higher-resolution techniques such as DNase footprinting (Protocol 1) and gel retardation assays (Protocol 2) can be used to define the proteins that bind to the DNA. When these methods are combined with expression analyses using transfected reporter genes (e.g., please see Protocols 5–7), a complete picture of the regulatory regions of a gene can be assembled.

# Protocol 4

---

## Transcriptional Run-on Assays

**N**UCLEAR RUN-ON ASSAYS ARE USED TO DETERMINE WHETHER A CLONED GENE is transcriptionally regulated. Ideally, nuclear run-on assays should be done *after* hybridization experiments that examine changes in steady-state mRNA levels and *before* analysis of the promoter.

In the simplest of terms, nuclear run-on assays allow the measurement of the number of RNA polymerases traversing the gene at a given time in cells subject to one or more regulatory inputs. A typical experiment involves the isolation of nuclei from cells expressing the gene of interest and their subsequent incubation with [<sup>32</sup>P]UTP. The radiolabeled UTP is incorporated into nascent RNA transcripts by RNA polymerase molecules that were actively transcribing the gene at the time the cells were harvested (very little initiation of transcription occurs in isolated nuclei). The transcriptional activity of the target gene in the nuclei is measured by hybridizing the radiolabeled RNAs to an excess of the target gene immobilized on a nitrocellulose or nylon membrane. The fraction of radioactivity that hybridizes to the immobilized DNA reflects the contribution of the target gene to the total transcriptional activity of the cell (Srivastava and Schonfeld 1998).

Regulatory inputs that change the transcriptional activity of the gene are detected by an increase or decrease in hybridization in a nuclear run-on experiment. A change in hybridization generally means that a larger or smaller number of transcription complexes are traversing the gene and that the stimulus affected the number of initiation events at the promoter of the target gene. If this type of result is obtained, it is probable that *cis*-acting DNA sequences underlie the observed changes in gene activity and that subsequent identification of these elements might be accomplished by transfection of appropriate reporter gene constructs. However, changes in hybridization are not necessarily synonymous with regulation of transcription at the level of initiation. In certain isolated cases, changes in hybridization can also be associated with more complex regulatory mechanisms, such as effects on the rate of RNA polymerase movement along the gene (attenuation) (e.g., please see Bentley and Groudine 1986).

Regulatory inputs that affect posttranscriptional events such as mRNA stability, transport, or translation do not alter the level of hybridization of primary transcripts of the target gene. Sequences that affect posttranscriptional processes can often be identified by analyzing the sequence of the mRNA itself. The function of such *cis*-acting elements can be analyzed in detail by construction and expression of genes encoding appropriate mRNAs.

Because the number of nascent RNA transcripts from a single-copy gene is very low, large amounts of cDNA or gene must be applied to the membrane, copious quantities of [<sup>32</sup>P]UTP are



required to radiolabel the nascent RNA, and hybridization should be carried out for extended periods of time. The following methods were derived from protocols provided by Dorothy Yuan, Diane Jelinek, and Karl Normington (all of University of Texas Southwestern Medical Center, Dallas).

## MATERIALS

▲ **IMPORTANT** All test tubes and solutions must be prepared RNase-free.

**CAUTION:** Please see Appendix 12 for appropriate handling of materials marked with <!.>.

### Buffers and Solutions

Please see Appendix 1 for components of stock solutions, buffers, and reagents. Dilute stock solutions to the appropriate concentrations.

*Chloroform* <!.>

*Chloroform:isoamyl alcohol* <!.>

*DNA denaturation solution*

2 M NaCl

0.1 M NaOH <!.>

*Ethanol*

*Glycerol storage buffer*

50 mM Tris-Cl (pH 8.3)

5 mM MgCl<sub>2</sub>

0.1 mM EDTA (pH 8.0)

40% (v/v) glycerol

Store the buffer at 4°C.

*HSB buffer*

10 mM Tris-Cl (pH 7.4)

50 mM MgCl<sub>2</sub>

2 mM CaCl<sub>2</sub>

0.5 M NaCl

Store the buffer at room temperature.

*Labeling buffer*

20 mM Tris-Cl (pH 8.0 at 4°C)

140 mM KCl

10 mM MgCl<sub>2</sub>

1 mM MoCl<sub>2</sub>

20% (v/v) glycerol

14 mM β-mercaptoethanol <!.>

1 mM each of ATP, GTP, and CTP

10 mM phosphocreatine

100 μg/ml phosphocreatine kinase

0.1 μM [<sup>32</sup>P]UTP, 500–5000 μCi/ml <!.>

Just before use, add the last five ingredients and keep the solution at 4°C. Exercise extreme care after the radioactive UTP has been added.

*LiCl (5 M)*

*Lysis buffer*

10 mM Tris-Cl (pH 8.4 at 4°C)

1.5 mM MgCl<sub>2</sub>

0.14 M NaCl

Store the buffer at 4°C.

*NaCl (2 M)*

*NaOH (0.1 M)* <!.>

*Nonidet P-40 (5% v/v)*

*Nuclei wash buffer*

20 mM Tris-Cl (pH 8.0 at 4°C)

140 mM KCl

10 mM MgCl<sub>2</sub>1 mM MoCl<sub>2</sub>

20% (v/v) glycerol

14 mM β-mercaptoethanol

Store the buffer at 4°C. Just before use, add the β-mercaptoethanol to the buffer from a concentrated stock solution.

*Phenol <math>\langle ! \rangle</math>**Phosphate-buffered saline (PBS)**Prehybridization/Hybridization solution <math>\langle ! \rangle</math>*

Hybridization buffer containing formamide is generally used in nuclear run-on assays, e.g., 50% (v/v) formamide, 6× SSC, 5 mM sodium pyrophosphate, 2× Denhardt's solution, 0.5% (w/v) SDS, 10 μg/ml poly(A), and 100 μg/ml salmon sperm DNA (please see Chapter 6, Protocol 10).

*2x Reaction buffer*

10 mM Tris-Cl (pH 8.0)

5 mM MgCl<sub>2</sub>

0.3 M KCl

Store the buffer at 4°C. Just before use, add 5 μl of 1 M dithiothreitol, 100 μl of 100 mM ATP, 10 μl of 100 mM CTP, and 10 μl of 100 mM GTP to 1 ml of 2x reaction buffer.

*RNasin*RNasin is a generalized term for the rat liver RNase inhibitor protein. Preparations of this enzyme are available from several companies (please see the information panel on **INHIBITORS OF RNASES** in Chapter 7).*SDS (0.5% w/v)**6x SSC**Stop buffer*

50 mM Tris-Cl (pH 7.5)

20 mM EDTA (pH 8.0)

0.8% (w/v) SDS

Store the buffer at room temperature.

*Tissue homogenization buffer*

10 mM HEPES-KOH (pH 7.6)

25 mM KCl

0.15 mM spermine

0.5 mM spermidine

1 mM EDTA (pH 8.0)

2 M sucrose

10% (v/v) glycerol

Store the buffer at 4°C. Just before use in Step 1, add dithiothreitol to 1 mM and protease inhibitors (0.5 mM phenylmethylsulfonyl fluoride, 1 μg/ml leupeptin, 1 μg/ml pepstatin, or others as needed).

*Trypan Blue dye (0.4% w/v)*

Dissolve an appropriate amount of dye in phosphate-buffered saline without calcium and magnesium salts. Store the solution at room temperature.

**Enzymes and Buffers***DNase solution*

Dissolve 2 mg of RNase-free DNase (e.g., Worthington) in 1 ml of 0.0025 N HCl, 50% (v/v) glycerol. Store the solution at -20°C.

*Proteinase K (optional)**Restriction enzyme(s)*

Please see Step 9.

**Radioactive Compounds***[α-<sup>32</sup>P]UTP (500–5000 μCi/ml) <math>\langle ! \rangle</math>*

Use 100 μCi for each sample of nuclei to be radiolabeled.

## Centrifuges and Rotors

Beckman SW28 rotor or equivalent  
Sorvall H1000B rotor or equivalent  
Sorvall SS-34 rotor or equivalent

▲ **IMPORTANT** Chill all rotors to 4°C.

## Special Equipment

Boiling water bath  
Dounce homogenizer with type-B pestle  
Polyallomer or ultraclear swinging-bucket centrifuge tubes  
Polypropylene tubes (17 × 100 mm)  
Razor blades  
Shaking water bath preset to 30°C  
Water baths preset to 4°C and 65°C

## Additional Reagents

Step 11 of this protocol requires the reagents and equipment listed in Chapter 7, Protocol 9.  
Step 13 of this protocol requires the reagents listed in Chapter 6, Protocol 8.  
Steps 14–16 of this protocol require the reagents listed in Chapter 6, Protocols 8 and 10.

## Vectors and Bacterial Strains

Nonrecombinant plasmid vector  
Recombinant plasmid containing the cDNA or gene of interest

## Cells and Tissues

Cultured cells or Fresh tissue

## METHOD

---

### Isolation of Nuclei and Radiolabeling of RNA Transcripts

1. Isolate nuclei from either cultured cells or fresh tissue.

#### ISOLATION OF NUCLEI FROM CULTURED CELLS

- a. Scrape the cells from culture dishes and wash them twice with ice-cold PBS. Resuspend  $1 \times 10^7$  to  $1 \times 10^8$  cells in 1 ml of ice-cold lysis buffer in a 17 × 100-mm polypropylene tube. Add 2–4 μl of 5% Nonidet P-40 and incubate the suspension for 10 minutes on ice.
- b. Mix 10 μl of the suspension with an equal volume of 0.4% Trypan Blue dye and examine the solution under a microscope equipped with a 20x objective. Lysed cells take up the dye and appear blue, whereas unlysed cells are impermeable to the dye and remain translucent. Continue adding 2-μl aliquots of 5% Nonidet P-40 and check cell lysis until >80% of the cells are lysed.
- c. Recover the nuclei by centrifugation at 1300g (2500 rpm in a Sorvall H1000B rotor) for 1 minute in a benchtop centrifuge. Remove and discard the supernatant. Wash the pellet of nuclei twice in 1-ml of ice-cold nuclei wash buffer. Proceed to Step 2.

**ISOLATION OF NUCLEI FROM TISSUE**

- a. Dissect and mince 10–15 g of tissue. Adjust the volume of minced tissue to 30 ml with ice-cold tissue homogenization buffer, and homogenize in a tight-fitting Dounce homogenizer.
- b. To monitor lysis, mix 10  $\mu$ l of the cell suspension with an equal volume of 0.4% Trypan Blue dye and examine the solution under a microscope equipped with a 20x objective. Lysed cells take up the dye and stain blue, whereas intact cells exclude dye and remain translucent. Continue to homogenize the tissue until >80–90% of the cells are broken.
- c. Dilute the homogenate to 85 ml with ice-cold tissue homogenization buffer. Layer 27-ml aliquots over 10-ml cushions of ice-cold homogenization buffer in ultraclear or polyalloymer swinging bucket centrifuge tubes. Centrifuge the tubes at 103,900g (24,000 rpm in a Beckman SW28 rotor) for 40 minutes at 4°C.
- d. Decant the supernatant and allow the tubes to drain in an inverted position for 1–2 minutes. Place the tubes on ice. Resuspend each pellet in 2 ml of glycerol storage buffer by pipetting the mixture up and down.
 

*(Optional)* Use a razor blade to cut off the top two thirds of the tube and place the bottom one third containing the nuclei on ice before resuspending the pellets in glycerol storage buffer.
- e. Mix 10  $\mu$ l of resuspended nuclei with 990  $\mu$ l of 0.5% SDS. Measure the OD<sub>260</sub> in a UV spectrophotometer and dilute resuspended nuclei with glycerol storage buffer to a final concentration of 50 OD<sub>260</sub>/ml. Divide the preparation of nuclei into 200- $\mu$ l aliquots in 1.5-ml microfuge tubes, snap freeze the aliquots in liquid nitrogen, and store them at –70°C. Proceed to Step 2.

2. Radiolabel the nascent RNA transcripts in the isolated nuclei.

**RADIOLABELING OF THE TRANSCRIPTS IN NUCLEI ISOLATED FROM CULTURED CELLS**

- a. Remove as much supernatant as possible from the last wash (Step 1c), and resuspend the nuclei in 50–100  $\mu$ l of labeling buffer. Incubate the nuclei for 15–20 minutes at 30°C in a shaking water bath.
 

▲ **WARNING** Exercise extreme care after the radioactive UTP has been added to the solution. Wear gloves and goggles and be careful not to contaminate bench surfaces, etc., with this highly radioactive solution.
- b. Pellet the nuclei by centrifugation at 800g (1960 rpm in a Sorvall H1000B rotor) for 5 minutes in a benchtop centrifuge, and carefully discard the supernatant as radioactive waste. Proceed to Step 3.
 

The incorporation of [<sup>32</sup>P]UTP into RNA can be monitored by trichloroacetic acid (TCA) precipitation as described in Appendix 8. In a successful labeling reaction containing 100  $\mu$ Ci of radiolabeled UTP and 10 OD<sub>260</sub> of nuclei, 80–90% of the <sup>32</sup>P will be incorporated into TCA-precipitable material.

**RADIOLABELING OF THE TRANSCRIPTS IN NUCLEI ISOLATED FROM TISSUE**

- a. Transfer an appropriate number of aliquots of the nuclear preparation from –70°C to an ice bucket. When the aliquots have thawed, add 400 units of RNasin to each tube. Add 200  $\mu$ l of 2x reaction buffer supplemented with nucleotides and dithiothreitol to each tube of nuclei. Add 100  $\mu$ Ci of [ $\alpha$ -<sup>32</sup>P]UTP.
 

▲ **WARNING** Exercise extreme care after the radioactive UTP has been added to the solution. Wear gloves and goggles and be careful not to contaminate bench surfaces, etc., with this highly radioactive solution.

- b. Incubate the nuclei for 20 minutes in a 30°C shaking water bath. Recover the nuclei by centrifugation at 2000 rpm for 1–2 minutes. Carefully discard the supernatant as radioactive waste. Proceed to Step 3.

The incorporation of [<sup>32</sup>P]UTP into RNA at this step can be monitored by TCA precipitation as described in Appendix 8. In a successful labeling reaction using 100 μCi of radiolabel and 10 OD<sub>260</sub> of nuclei, 80–90% of the <sup>32</sup>P will be incorporated into TCA-precipitable material.

3. Resuspend the nuclear pellet in 1 ml of ice-cold HSB buffer, and add 10 μl of DNase solution. Pipette the nuclei up and down until they are resuspended and the viscosity of the solution is reduced (1–5 minutes). Add 2 ml of stop buffer.

DNase treatment serves to reduce the viscosity of the solution and to prevent the trapping of nascent radiolabeled RNA transcripts in genomic DNA. The viscosity never completely disappears and clumps of nuclei often remain.

4. (*Optional*) To increase the yield of radiolabeled RNA, add proteinase K after the DNase step. Following the addition of 2 ml of stop buffer, add proteinase K to a final concentration of 100 μg/ml. Incubate the solution for 30 minutes at 42°C. Proceed to Step 5.

For more extensive DNA removal and radiolabeled RNA purification protocols, please see Groudine et al. (1981).

5. Add 3 ml of phenol and incubate the mixture for 15 minutes at 65°C with vortexing every 5 minutes. Add 3 ml of chloroform:isoamyl alcohol, vortex, and separate the organic and aqueous phases by centrifugation at 1900g (3000 rpm in a Sorvall H1000B rotor). Extract the aqueous layer again with 3 ml of chloroform, centrifuge as before, and transfer the aqueous layer to a fresh tube.
6. Add 0.3 ml of 5 M LiCl and 2.5 volumes of ethanol, and mix well. Collect precipitated nucleic acids by centrifugation at 12,000g (10,000 rpm in a Sorvall SS-34 rotor) for 10 minutes.
7. Resuspend the pellet in 0.4 ml of H<sub>2</sub>O and transfer it to a 1.5-ml microfuge tube. Add 40 μl of 5 M LiCl and 2.5 volumes of ethanol. Centrifuge the solution for 10 minutes at maximum speed in a microfuge.
8. Resuspend the pellet in 100 μl of H<sub>2</sub>O and measure the cpm/μl in a liquid scintillation counter.

### Hybridization of the RNA to Immobilized DNA

9. Linearize 10 μg of recombinant plasmid DNA containing the cDNA or gene of interest and 10 μg of empty plasmid vector using a restriction enzyme whose sites of cleavage are present in the vector sequences.
10. Recover the cleaved DNAs using standard ethanol precipitation, and resuspend each of the pellets separately in 20 μl of DNA denaturation solution. Boil the resuspended DNAs for 2 minutes, and then add 180 μl of 6x SSC to each tube.
11. Cut a piece of nylon or nitrocellulose membrane to the appropriate size for use in a dot- or slot-blotting apparatus. Wet the membrane in H<sub>2</sub>O and then soak it for 5–10 minutes in 6x SSC. Clamp the wet membrane in the blotting apparatus, attach a vacuum line, and apply suction to the device (please see Chapter 7, Protocol 9).
12. Filter the denatured DNAs through separate slots and wash each filter with 200 μl of 6x SSC.
13. Dismantle the device, dry the membrane in the air, and fix the DNA to the membrane by baking or by exposure to UV light.

14. Place the membrane in prehybridization solution and incubate it for at least 16 hours at an appropriate temperature (e.g., 42°C for solvents containing 50% formamide).
15. Add the radiolabeled probe ( $2 \times 10^6$  to  $4 \times 10^6$  cpm/ml of  $^{32}\text{P}$ -labeled RNA from Step 8) directly to the prehybridization solution, and incubate the filter for a further 72 hours.
16. Wash the membrane at high stringency and expose it to X-ray film or a phosphorimager plate. Typical exposure times are 24–72 hours for X-ray film and 4–24 hours for a phosphorimager plate.

#### HYBRIDIZATION CONTROLS AND TROUBLESHOOTING

- The inclusion of  $\alpha$ -amanitin in the labeling step at 0.5  $\mu\text{g}/\text{ml}$  can be used to demonstrate that an observed hybridization signal is due to transcription by RNA polymerase II (Marzluff and Huang 1984).
- Several hybridization controls should be included in a nuclear run-on experiment. As a negative control for spurious hybridization, isolate and analyze nuclear RNA from cells that do not express the gene of interest. Immobilize an empty plasmid vector on the nylon/nitrocellulose filter to act as a control for spurious hybridization. Prepare two positive hybridization controls, including a gene that is expressed in the cells but is known not to respond to the regulatory input (e.g., actin, glyceraldehyde 3-phosphate dehydrogenase, and cyclophilin), and a gene that is known to respond to the stimulus.
- The cDNA or gene of interest in the immobilized DNA should not contain repetitive DNA sequences and represent as much of the gene as possible. DNA fragments containing separate regions or exons of the gene can be used to assay for differences in the rate of elongation (Bentley and Groudine 1986) and/or to confirm a given hybridization result. It should also be kept in mind that, in rare instances, both strands of the DNA can be transcribed. For this reason, use a single-stranded DNA probe from one or more regions or exons as a control in at least one experiment.
- The overall sensitivity of the hybridization assay can be enhanced by trimming the excess membrane from the immobilized DNA (i.e., leaving just the DNA-containing slot or dot) and carrying out the hybridization in a test tube in a small volume under mineral oil in a water bath set at the appropriate temperature.
- In some cases, partial hydrolysis of nascent RNA transcripts will enhance hybridization. Resuspend the final RNA pellet from Step 8 in 100  $\mu\text{l}$  of 10 mM Tris-Cl (pH 7.4), 10 mM EDTA, and 200 mM NaCl, and add 25  $\mu\text{l}$  of 1 N NaOH. Incubate the solution on ice for 15 minutes and then neutralize the reaction by adding 25  $\mu\text{l}$  of 1 N HCl. Add 500  $\mu\text{l}$  of 1.2x Denhardt's solution and set up the hybridization reaction as described.
- If substantial background is encountered in these protocols, treat the washed filter with RNase T1 (10 units/ml) and RNase A (20  $\mu\text{g}/\text{ml}$ ) in 2x SSC for 1 hour at 37°C to reduce nonspecific binding of the probe to the membrane.

## Reporter Assays: CAT, Luciferase, and $\beta$ -galactosidase

**R**EPORTER GENES OR MARKERS PROVIDE A CONVENIENT MEANS to identify and analyze the regulatory elements of genes. Standard recombinant methods are used to join the regulatory sequence of interest to a reporter gene or marker carried in an expression vector. The resulting recombinant is then introduced into an appropriate cell line, where its expression is detected by measurement of the reporter mRNA or the reporter protein, or, in the case of enzyme reporters, by assaying for the relevant catalytic activity. Whatever the method of detection, these reporters typically have an easily measured output that can be distinguished from the background of proteins in the host cell. Most of the detection methods in common use are sensitive, specific, quantitative, reproducible, and rapid to perform.

Reporter systems are used to measure transcriptional activity, in particular to study promoters and enhancers and their interactions with *cis*-acting elements and *trans*-acting proteins, as well as their responses to environmental changes. The fine structure of a regulatory region can be analyzed by a series of “promoter-bashing experiments” in which selected mutations are introduced into the sequence under study, and its consequent activity (or ability to express the reporter) is measured and compared to that of the wild-type or normal sequence.

### REPORTER GENES USED IN ANALYSIS OF REGULATORY ELEMENTS

---

After Gorman et al. (1982) first described the use of chloramphenicol acetyltransferase (CAT) as a reporter, the CAT gene became widely adopted as a reporter for many of the standard lines of cultured mammalian cells. CAT remains in common use and fulfills many of the criteria required of a reporter (please see Table 17-1). Several different assays are available to measure CAT activity, using procedures and equipment that are available in most laboratories. Despite its virtues, CAT is not an ideal reporter in all circumstances. Other reporter systems have therefore been developed in an effort to increase the sensitivity of detection and to expand the range of cell lines that could be used as hosts (for reviews, please see Alam and Cook 1990; Bronstein et al. 1994; Groskreutz and Schenborn 1997; Naylor 1999).

Each of these newer reporter systems uses a different method of detection and each has different strengths and weaknesses.

- The firefly luciferase gene produces light from luciferin in the presence of ATP (de Wet et al. 1987; please see the information panel on **LUCIFERASE**). Measurements of luciferase activity therefore require a luminometer or liquid scintillation counter with single photon-counting

**TABLE 17-1 Comparison of Commonly Used Reporter Genes**

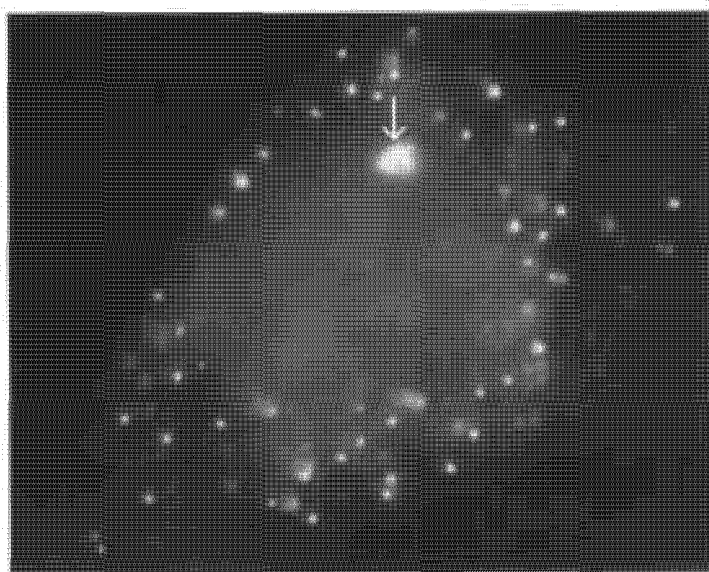
REPORTER GENE <sup>a</sup>	ADVANTAGES	DISADVANTAGES
CAT (bacterial)	no endogenous activity; automated ELISA available	narrow linear range; use of radioisotopes; stable
$\beta$ -galactosidase (bacterial)	well-characterized and stable; simple colorimetric readouts; sensitive bio- or chemiluminescent assays available	endogenous activity (mammalian cells)
Luciferase (firefly)	high specific activity; no endogenous activity, broad dynamic range; convenient assays	requires substrate (luciferin) and presence of O <sub>2</sub> and ATP
Luciferase (bacterial)	good for measuring/analyzing prokaryotic gene transcription	less sensitive than firefly; not suitable for mammalian cells
Alkaline phosphatase (human placental)	secreted protein; inexpensive colorimetric and highly sensitive luminescent assays available	endogenous activity in some cells; interference with compounds being screened
GFP (jellyfish)	autofluorescent (no substrate needed); no endogenous activity; mutants with altered spectral qualities available	requires posttranslational modification; low sensitivity (no signal amplification)

<sup>a</sup> $\beta$ -glucuronidase is frequently used as a reporter in plants (Jefferson 1987).  
Reproduced, with permission, from Naylor (1999 ©Elsevier Science).

ability. For some experiments, luciferase is a better reporter than CAT. The assay for luciferase is more sensitive and is therefore preferred when a weak promoter is analyzed or when the line of cultured cells is transfected with low efficiency. Luciferase is also the reporter of choice when analyzing promoters whose activity is down-regulated in response to a signal. The half-life of luciferase in transfected cells is short (~3 hours) and the enzymatic activity declines rapidly as a result of down-regulation of the promoter. CAT, on the other hand, is very stable ( $T_{0.5} > 50$  hours) and maintains its full enzymatic power long after the rate of transcription has been reduced (Thompson et al. 1991). Although it is possible to follow the disappearance of CAT using mRNA by primer extension or nuclease protection, these assays are far more laborious than those used to quantify luciferase activity.

- Growth hormone is secreted into the medium, where it is easily detected and accurately quantified by a commercially available radioimmunoassay. However, the rationale for using growth hormone as reporter is built on the assumption that the rate at which secreted protein accumulates in the medium parallels the rate at which the gene encoding the preprotein is transcribed in the nucleus. This assumption may seem reasonable, but it has not been proven in all circumstances. Secretion and transcriptional control lie at opposite ends of the continuum of events that constitute gene expression and are separated by a large number of steps, each of which may be subjected to control. Secretion may be a good surrogate for transcription in most cases, but there are situations in which it certainly is not, for example, in cell lines that have defects in the secretory pathway.
- Green fluorescent protein (GFP) and its engineered variants are the best nonenzymatic reporter systems in current use. GFP is unique among various light-emitting proteins in being autofluorescent, i.e., it requires no exogenous cofactors or independent substrates for activity. Moreover, as its presence is easily detected by measuring absorbance at the appropriate wavelength, the system provides a noninvasive means of monitoring reporter gene expression in both fixed and living cells. However, because the fluorescent signal is not amplified (even in some of the brighter mutants of GFP), detection requires that expression of GFP be driven by very strong promoters or other regulatory elements. The most spectacular applications are in





**FIGURE 17-2 Localization of a Stably Integrated Transgene and Its Protein Product**

A gene encoding a fusion protein composed of cyan fluorescent protein and a peroxisomal targeting signal was cloned downstream from a tetracycline-responsive element (TRE) controlling a minimal cytomegalovirus promoter. Lac operator sequences from the *E. coli lacZ* gene were located upstream of the TRE. The construct was used to transfect BHK cells, and a stable cell line was selected that expressed cyan fluorescent protein from integrated copies of the transgene. The chromosomal site of integration can be detected in live interphase cells by transient expression of a fusion protein consisting of yellow fluorescent protein and the *lac* repressor that binds operator sequences (please see arrow in the figure). The cyan fluorescent protein expressed from the transgene is visible in peroxisomes distributed throughout the cytoplasm of the cell. (Photo provided courtesy of Toshiro Tsukamoto [Himeji Institute of Technology, Japan] and David L. Spector [Cold Spring Harbor Laboratory].)

the utilization of GFP as a fusion partner to follow the transport, localization, and fate of a targeted protein (e.g., please see Figure 17-2). For further information on GFP, please see Tsien (1998) and the information panel on **GREEN FLUORESCENT PROTEIN** at the end of this chapter.

- Epitope tagging provides another method to monitor expression and localization of proteins. A well-characterized epitope tag expressed as part of a protein of interest confers immunoreactivity to a well-characterized antibody. Epitope tags can be used both for immunolocalization of the target protein and for quantitation by commercially available radioimmunoassays. For further information, please see the excellent review by Jarvik and Telmer (1998) and the information panel on **EPITOPE TAGGING**. Specific protocols for engineering fusion constructs using epitope tags and fluorescent proteins may be found in *Cells: A Laboratory Manual* (Spector et al. 1998; Chapters 71 and 78, respectively)

## TRANSFECTION CONTROLS

When measuring the effect of promoters and enhancers on gene expression, it is essential to include an internal control that will distinguish differences in the level of transcription from differences in the efficiency of transfection or in the preparation of extracts. This control is best achieved by cotransfecting the cells with two plasmids: one plasmid that carries the construct under investigation and another plasmid that constitutively expresses an activity that can be assayed in the same cell extracts. *E. coli*  $\beta$ -galactosidase is a convenient enzyme for this purpose and methods to assay this enzyme in cell extracts are described in Protocol 7.

# Protocol 5

---

## Measurement of Chloramphenicol Acetyltransferase in Extracts of Mammalian Cells Using Thin-layer Chromatography

**T**HE FIRST EXPERIMENTS TO MAP REGULATORY DNA SEQUENCES in a eukaryotic promoter used primer extension to detect transcripts of a viral thymidine kinase gene that had been injected into *Xenopus* oocytes (McKnight and Gavis 1980; McKnight and Kingsbury 1982). Although the prevailing viewpoint at the time was that eukaryotic genes were impossibly complex and quite beyond analysis by methods then available (Lewin 1974), McKnight showed that this was not the case and in so doing initiated the field of eukaryotic promoter analysis. Today, many hundreds of regulatory elements have been identified using variations on his methods, and a large number of nuclear proteins that interact with these sequences have been purified and their genes cloned.

As more and more laboratories began mapping eukaryotic promoters, it soon became apparent that a simpler and more rapid assay than primer extension was needed to measure promoter activity. Of the many so-called reporter genes that have been developed to meet this need, the bacterial enzyme chloramphenicol acetyltransferase (CAT) and the firefly enzyme luciferase (please see Protocol 6) have become the most popular.

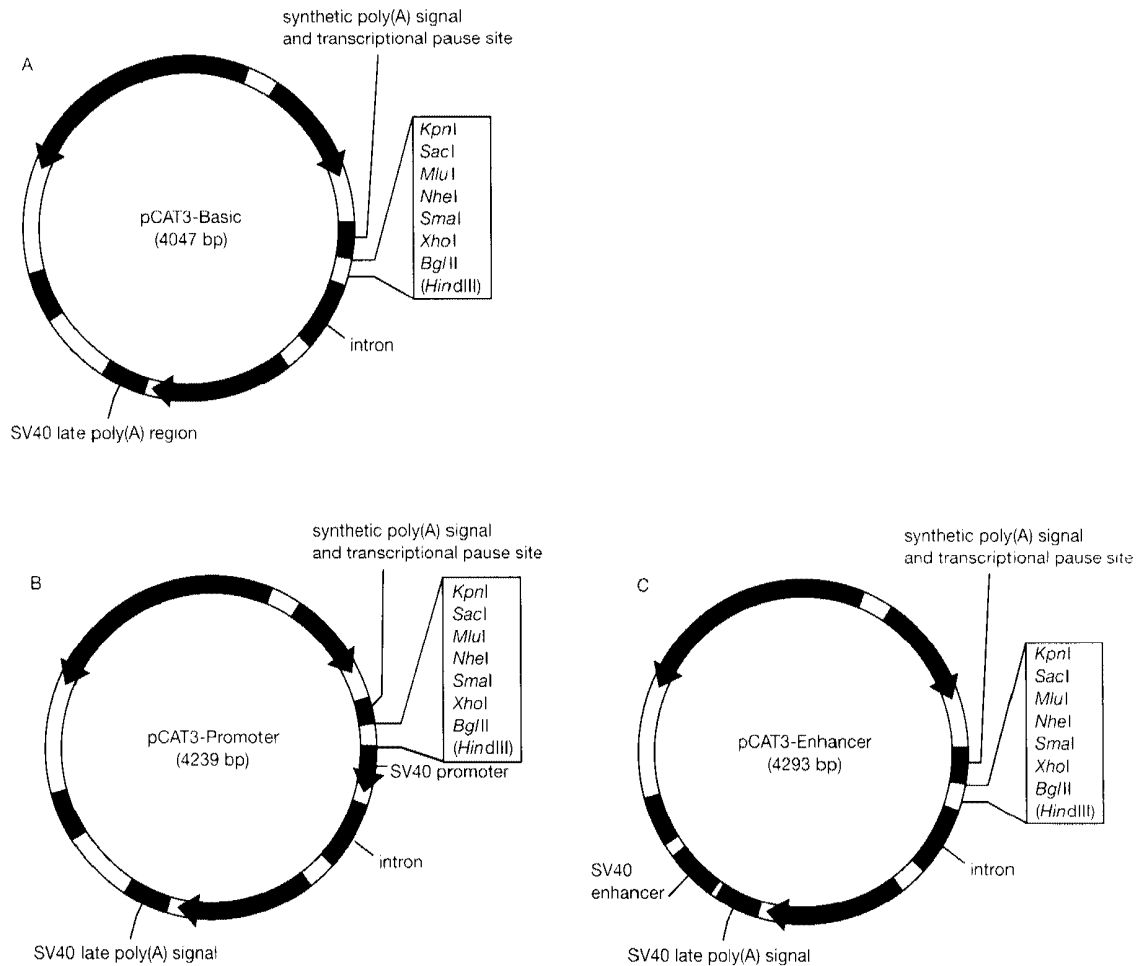
CAT is encoded by a prokaryotic gene that confers resistance to the antibiotic chloramphenicol. The enzyme transfers an acetyl group from acetyl-coenzyme A (acetyl-CoA) to chloramphenicol and thereby inactivates the ability of the antibiotic to bind to and inhibit prokaryotic ribosomes (for further details, please see the information panel on CHLORAMPHENICOL ACETYLTRANSFERASE). Because there are no CAT genes in mammalian cells, and because the assay for CAT enzymatic activity is sensitive and reproducible, the prokaryotic CAT gene has become a popular reporter of eukaryotic promoter output. In a typical experiment, a fragment of eukaryotic DNA is placed upstream (5') of the coding region of the CAT gene and the resulting plasmid is transfected into mammalian cells. After a period of time to allow expression of the transfected gene, CAT activity is measured using one of the assays described in this protocol. If the assay is set up correctly, there will be a linear relationship between the amount of CAT activity and the level of transcription of the transfected construct. By making mutations in the putative promoter DNA fragment and assaying the ability of the mutant constructs to direct the synthesis of CAT activity after transfection, it is possible to define regulatory sequences in the DNA.

Despite the quantitative nature of the CAT assay, it should always be kept in mind that transcription is not directly measured in the assay and that parameters such as the half-life of the CAT protein in a transfected cell can influence the results. This consideration becomes especially important when scoring for suppression of transcription. Another potential problem is that CAT activity may be generated from transcripts that are accurately initiated both at the promoter of interest and from transcripts initiated at ectopic sites in the vector (Langner et al. 1986). The level of such aberrant transcription may greatly inflate the estimates of the activity of the promoter under test. In some cases, the background caused by spurious transcription can be eliminated by placing a transcription termination signal upstream of the promoter of interest (Heard et al. 1987; Araki et al. 1988). To reduce the possibility of error, the conclusions obtained by analysis of promoters or enhancers linked to CAT (or any other reporter enzyme activity) must be confirmed by direct assay of the mRNAs encoded by one or more of the chimeric constructs. The accuracy with which transcripts are initiated from chimeric genes should also be checked by mapping the precise location of the 5' terminus of the mRNA on its template DNA. Techniques to measure mRNA levels and to map the 5' termini of mRNAs include primer extension, digestion of DNA-RNA hybrids with nuclease S1, and digestion of RNA-RNA hybrids with RNase A. Protocols for these types of experiments are detailed in Chapter 7.

In the current protocol, we outline three different assays that can be used to detect CAT enzyme activity expressed from pCAT3 reporter vectors transfected into mammalian cells (please see Figure 17-3): measuring CAT activity using thin-layer chromatography (main protocol), measuring CAT activity following extraction with organic solvents (first alternative protocol, p. 17.40), and measuring CAT activity following diffusion of products into scintillation fluid (second alternative protocol, p. 17.41).

#### **CONTROLS**

Controls to determine intrinsic CAT enzyme activity should include mock-transfected cells and cells transfected with the CAT vector lacking a promoter. A control that lacks any cell extract should also be included to measure the background contributed by the thin-layer chromatograms. As a positive control for CAT activity and transfection, use extracts from cells transfected with a construct equipped with a strong promoter (SV40 early or late region promoters, cytomegalovirus immediate early region, or Rous sarcoma virus long terminal repeat) linked to the CAT gene (e.g., please see Figure 17-3). Finally, results obtained with the CAT assay should be confirmed by direct measurements of RNA.

**FIGURE 17-3 pCAT3 Vectors**

Summarized here are the features of pCAT3 vectors that carry the coding sequence for CAT (Luckow and Schütz 1987). All vectors in the series contain (1) the origin of replication derived from filamentous phage (f1 ori), (2) an origin of plasmid replication in *E. coli* (ori), (3) an ampicillin resistance marker ( $Amp^R$ ) for selection in prokaryotic cells, and (4) a poly(A) addition signal and a transcriptional pause site located 5' of the CAT gene to reduce the background of readthrough transcription from upstream sequences. The arrows in the CAT gene and in  $Amp^R$  indicate the direction of transcription. The sequence of interest is inserted into the multiple cloning site (MCS). (A) The basic vector lacks eukaryotic promoter and enhancer sequences. The expression of CAT in this vector depends on the insertion and proper orientation of a functional promoter upstream of the CAT gene. Putative enhancer elements can also be inserted upstream of the promoter or in the *Bam*HI or *Sal*I sites downstream from the CAT gene. (B) The promoter vector contains an SV40 promoter upstream of the intron and the CAT gene. DNA sequences carrying putative enhancer elements can be inserted either upstream or downstream from the promoter-CAT transcription unit. (C) The enhancer vector carries an SV40 enhancer located downstream from the CAT gene and poly(A) addition signal. The enhancer aids in identifying functional promoter elements because its presence often results in high levels of transcription of the CAT gene. (Modified, with permission, from Promega Corp.)

**MATERIALS**

**CAUTION:** Please see Appendix 12 for appropriate handling of materials marked with <!.>.

**Buffers and Solutions**

Please see Appendix 1 for components of stock solutions, buffers, and reagents. Dilute stock solutions to the appropriate concentrations.

*CAT reaction mixture 1*

1 M Tris-Cl (pH 7.8)	50 $\mu$ l
[ <sup>14</sup> C]chloramphenicol (60 mCi/mMole, diluted in H <sub>2</sub> O to 0.1 mCi/ml) <!.>	10 $\mu$ l
acetyl-CoA (freshly prepared at a concentration of 3.5 mg/ml in H <sub>2</sub> O)	20 $\mu$ l

Prepare 80  $\mu$ l of CAT reaction mixture 1 per 50  $\mu$ l of cell lysate to be assayed. Assemble the reaction mixture immediately before use.

Acetyl-CoA is the S-acetylated form of coenzyme A. Two carbon units from fat and carbohydrate enter the citric acid cycle in this form. It is used as an acetylating cofactor in many biological reactions, as in this protocol, for acetylation of chloramphenicol by CAT.

*Ethyl acetate <!.>*

Ethyl acetate (CH<sub>3</sub>COOCH<sub>2</sub>CH<sub>3</sub>) is an organic solvent used in thin-layer chromatographic assays of CAT activity. Mix 1 part ethyl acetate with 19 parts chloroform to make a solvent that separates acetylated and nonacetylated forms of chloramphenicol on silica gel plates. Ethyl acetate is an extremely flammable (flash point = -4°C) and volatile ester with a scent of ripe fruit.

*Lysis buffer*

0.1 M Tris-Cl (pH 7.8)
0.5% (v/v) Triton X-100

Use if lysing the cells with detergent (please see Step 4).

The same lysis buffer can also be used to prepare cell extracts for measurements of  $\beta$ -galactosidase activity (please see Protocol 7).

**▲ IMPORTANT** Use a highly purified preparation of Triton X-100 in the cell lysis buffer. Lower-grade detergent samples can inhibit CAT enzyme activity. The detergent Nonidet P-40 at 0.125% (v/v) can be substituted for Triton X-100 in the lysis buffer.

*Phosphate-buffered saline (PBS) without calcium and magnesium salts**Thin-layer chromatography (TLC) solvent*

190 ml of chloroform <!.>
10 ml of methanol <!.>

Prepare 200 ml per TLC tank. Two TLC plates can be developed per tank.

*Tris-Cl (1 M, pH 7.8)***Radioactive Compounds***Radioactive ink <!.>*

Use to mark adhesive dot labels as guides for orienting the autoradiogram with the TLC plate.

**Special Equipment***Dry ice/ethanol bath <!.>*

Use these items if lysing the cells by freezing and thawing.

*Marking pen with ethanol-insoluble ink**Rotary vacuum evaporator*

For example, a Savant SpeedVac.

*Rubber policeman**Thin-layer chromatography plates (e.g., Sybron SIL G/UV254, Brinkmann)**Thin-layer chromatography tank (27.5 x 27.5 x 7.5 cm)*

This tank is available from scientific supply houses (e.g., Sigma-Aldrich Techware).

*Water bath preset to 65°C*

## Cells and Tissues

### *Cultured mammalian cells transfected with pCAT vectors carrying the DNA of interest*

The cells should be transfected (using one of the transfection protocols in Chapter 16) with a CAT reporter construct (e.g., the pCAT3 series) and an expression plasmid containing the  $\beta$ -galactosidase gene (pCMV-SPORT- $\beta$ -gal; please see Figure 16-2 in Chapter 16) or another reporter gene suitable for normalizing the results of CAT assay. For details of the pCAT vector series, please see Figure 17-3.

## METHOD

---

### Preparation of Transfected Cell Pellets

1. Use gentle aspiration to remove the medium from transfected monolayers of cells growing in 90-mm tissue culture dishes. Wash the monolayers three times with 5 ml of PBS without calcium and magnesium salts.
2. Stand the dishes at an angle for 2–3 minutes to allow the last traces of PBS to drain to one side. Remove the last traces of PBS by aspiration. Add 1 ml of PBS to each plate, and use a rubber policeman to scrape the cells into microfuge tubes. Store the tubes in ice until all of the plates have been processed.
3. Recover the cells by centrifugation at maximum speed for 10 seconds at room temperature in a microfuge. Gently resuspend the cell pellets in 1 ml of ice-cold PBS, and again recover the cells by centrifugation. Remove the last traces of PBS from the cell pellets and from the walls of the tubes. Store the cell pellets at  $-20^{\circ}\text{C}$  for future analysis or prepare cell extracts by either of the methods in Step 4.

The PBS can be conveniently removed with a disposable pipette tip attached to a vacuum line. Use gentle suction, and touch the tip to the surface of the liquid. Keep the tip as far away from the cell pellet as possible while the fluid is withdrawn from the tube. The pipette tip can then be used to vacuum the walls of the tube to remove any adherent droplets of fluid.

### Preparation of Cell Extracts

4. Lyse the cells either by repeated cycles of freezing and thawing or by incubating the cells in detergent-containing buffers. The latter is a quicker and easier method of cell lysis that permits CAT,  $\beta$ -galactosidase, and other marker gene assays to be adapted to a 96-well microtiter plate format (Protocol 6) (Bignon et al. 1993).

#### LYSIS OF CELLS BY REPEATED FREEZING AND THAWING

- a. Resuspend the cell pellet from one 90-mm dish in 100  $\mu\text{l}$  of 0.25 M Tris-Cl (pH 7.8). Vortex the suspension vigorously to break up clumps of cells.
- b. Disrupt the cells by three cycles of freezing in a dry ice/ethanol bath and thawing at  $37^{\circ}\text{C}$ . Make sure that the tubes have been marked with ethanol-insoluble ink.
- c. Centrifuge the suspension of disrupted cells at maximum speed for 5 minutes at  $4^{\circ}\text{C}$  in a microfuge. Transfer the supernatant to a fresh microfuge tube. Set aside 50  $\mu\text{l}$  of this supernatant for the CAT assay, and store the remainder of the extract at  $-20^{\circ}\text{C}$ .

#### LYSIS OF CELLS USING DETERGENT-CONTAINING BUFFERS

- a. To lyse cells with detergent, resuspend the cell pellets from Step 3 in 500  $\mu$ l of lysis buffer. Incubate the mixture for 15 minutes at 37°C.  
Use 100  $\mu$ l of this lysis buffer per cell pellet for extracts prepared from cells grown in 35-mm dishes.
- b. Remove the cellular debris by centrifuging the tubes at maximum speed for 10 minutes in a microfuge. Recover the supernatant. Assay CAT activity using one of the methods described in this protocol. Snap freeze the remainder of the cleared lysates in liquid nitrogen and store them at -70°C.

#### Detection of CAT Activity Using Thin-layer Chromatography

5. Incubate a 50- $\mu$ l aliquot of the cell extract for 10 minutes at 65°C to inactivate endogenous deacetylases. If the extract is cloudy or opaque at this stage, remove the particulate material by centrifugation at maximum speed for 2 minutes at 4°C in a microfuge.
6. Mix each of the samples to be assayed with 80  $\mu$ l of CAT reaction mixture 1, and incubate the reactions at 37°C. The length of the incubation depends on the concentration of CAT in the cell extract, which in turn depends on the strength of the promoter and the cell type under investigation. In most cases, incubation for 30 minutes to 2 hours is sufficient.  
The reactions can be incubated for longer periods of time (up to 16 hours) when the expression of the CAT gene is low in the transfected cells. However, in this case, it is advisable to add an additional 10- $\mu$ l aliquot of acetyl-CoA to each reaction after 2 hours of incubation.
7. Add 1 ml of ethyl acetate to each sample, and mix the solutions thoroughly by vortexing for three periods of 10 seconds. Centrifuge the mixtures at maximum speed for 5 minutes at room temperature in a microfuge.  
The acetylated forms of chloramphenicol partition into the organic (upper) phase; unacetylated chloramphenicol remains in the aqueous phase.
8. Use a pipette to transfer exactly 900  $\mu$ l of the upper phase to a fresh tube, carefully avoiding the lower phase and the interface. Discard the tube containing the lower phase in the radioactive waste.
9. Evaporate the ethyl acetate under vacuum by placing the tubes in a rotary evaporator (e.g., Savant SpeedVac) for ~1 hour.
10. Add 25  $\mu$ l of ethyl acetate to each tube and dissolve the reaction products by gentle vortexing.
11. Apply 10–15  $\mu$ l of the dissolved reaction products to the origin of a 25-mm silica gel TLC plate. The origin on the plate can be marked with a soft-lead pencil. Apply 5  $\mu$ l at a time, and evaporate the sample to dryness with a hair dryer after each application.
12. Prepare a TLC tank containing 200 ml of TLC solvent. Place the TLC plate in the tank, close the chamber, and allow the solvent front to move ~75% of the distance to the top of the plate.  
A number of different TLC plates and solvents can be used to separate acetylated forms of chloramphenicol. We routinely use chloroform:methanol (95:5) and Sybron SIL G/UV254 (Brinkmann) TLC plates. Touchstone (1992) provides a good introduction to TLC methods and troubleshooting.
13. Remove the TLC plate from the tank and allow it to dry at room temperature. Place adhesive dot labels marked with radioactive ink on the TLC plate to align the plate with the film, and

then expose the plate to X-ray film. Alternatively, enclose the plate in a phosphorimaging cassette. Store the cassette at room temperature for an appropriate period of time.

Do not cover the TLC plate with Saran Wrap, as this coverage will block the relatively weak radiation emitted by the  $^{14}\text{C}$  isotope.

14. Develop the X-ray film and align it with the plate. Alternatively, expose the chromatogram to the imager plate of a phosphorimager device or subject the plate to scanning.

Typically, three radioactive spots are detected. The spot that has migrated the least distance from the origin consists of nonacetylated chloramphenicol that partitioned into ethyl acetate. The two faster-migrating spots are modified forms of chloramphenicol that have been acetylated at one or the other of two potential sites. Diacetylated chloramphenicol may be detected as a third, even faster migrating spot only when high concentrations of CAT or lengthy incubations with copious amounts of extract protein are used.

15. To quantitate CAT activity, cut the radioactive spots from the TLC plate and measure the amount of radioactivity they contain in a liquid scintillation counter (please see Appendix 9). Use another aliquot of the cell extract (from Step 3 above) to determine the concentration of protein in the extract, using a rapid colorimetric assay, such as the Bradford assay. Reduce the concentration of Triton X-100 to  $\leq 0.1\%$  by dilution before determining the concentration of protein to prevent interference with the assay. Express the CAT activity as pmoles of acetylated product formed per unit time per milligram of cell extract protein.

Thin-layer chromatography on silica gels followed by scraping and scintillation counting of the modified chloramphenicol products can become quite tedious when large numbers of samples are prepared. An alternate method for quantitating the amount of product in these cases is to use a phosphorimager to scan the TLC plates.

"Intrinsic" acetylation of chloramphenicol in the absence of cellular extracts can contribute to background. If this is a problem, try decreasing the concentration of chloramphenicol in the assays two- to fourfold (Heard et al. 1987).



**ALTERNATIVE PROTOCOL: MEASUREMENT OF CAT BY EXTRACTION WITH ORGANIC SOLVENTS**

In this procedure (Sleigh 1986), the acetylated CoA is radiolabeled, and transfer of  $^{14}\text{C}$ -labeled acetate to unlabeled chloramphenicol is measured. The acetylated, radiolabeled forms of chloramphenicol are separated from unreacted acetyl-CoA by extraction with ethyl acetate. The acetylated chloramphenicol product partitions into the organic phase and the acetyl-CoA substrate remains in the aqueous phase.

**CAUTION:** Please see Appendix 12 for appropriate handling of materials marked with <math>\langle ! \rangle</math>.

**Additional Materials***CAT reaction mixture 2*

8 mM chloramphenicol <math>\langle ! \rangle</math>	20 $\mu\text{l}$
0.25 M Tris-Cl (pH 7.8)	30 $\mu\text{l}$
$^{14}\text{C}$ acetyl-CoA <math>\langle ! \rangle</math>	20 $\mu\text{l}$

The 8 mM solution of chloramphenicol is made by dissolving 2.57 mg of chloramphenicol in 1 ml of ethanol. The solution of  $^{14}\text{C}$ acetyl-CoA is prepared by dissolving  $^{14}\text{C}$ acetyl-CoA (58 Ci/mole) in  $\text{H}_2\text{O}$  to a concentration of 50 mCi/ml. Dispense the solution into 20- $\mu\text{l}$  aliquots and store them at  $-70^\circ\text{C}$ . Immediately before setting up the reaction, dilute the  $^{14}\text{C}$ acetyl-CoA tenfold into a solution of unlabeled acetyl-CoA (0.5 mM). The concentrations of the reagents in the final reaction mixture are 2.3 mM chloramphenicol, 0.11 M Tris-Cl, and 129 mM (1 mCi/ml)  $^{14}\text{C}$ acetyl-CoA.

For each 30  $\mu\text{l}$  of cell extract to be tested, 70  $\mu\text{l}$  of CAT reaction mixture 2 is required.

*Scintillation fluid (e.g., Insta-Gel, Packard)*

**Method**

1. Prepare extracts of transfected cells as described in the main protocol, Steps 1–4. Set aside 30- $\mu\text{l}$  aliquots of the extracts for the CAT assay.
2. Add 30  $\mu\text{l}$  of each cell extract to 70  $\mu\text{l}$  of CAT reaction mixture 2. Incubate the reactions for 10 minutes at  $65^\circ\text{C}$  to inactivate deacetylases and then for 1 hour at  $37^\circ\text{C}$  to allow the CAT enzyme to function.
3. Transfer the samples to an ice bath, and add 100  $\mu\text{l}$  of ice-cold ethyl acetate. Mix the phases by vigorous vortexing. Centrifuge the mixtures at maximum speed for 3 minutes at room temperature in a microfuge.
4. Transfer 80  $\mu\text{l}$  of the organic (upper) phase to a fresh tube. Add 100  $\mu\text{l}$  of ice-cold ethyl acetate to the original tube (the aqueous phase). Vortex vigorously and centrifuge again as in Step 3. Transfer 100  $\mu\text{l}$  of the organic phase to the tube containing 80  $\mu\text{l}$  of ethyl acetate from the first extraction.  
Take great care not to transfer any of the aqueous phase, which contains radiolabeled substrate.
5. Mix the combined organic phases with 1 ml of scintillation fluid in a 1.5-ml plastic tube. Measure the radioactivity by liquid scintillation counting (please see Appendix 8). Determine the specific activity of the CAT after measuring the concentration of protein in the cell extracts using a rapid colorimetric assay such as the Bradford assay.

The linear range of this assay is between 0.03 and 0.25 unit of enzyme per milliliter of incubation mixture (a unit of CAT activity is defined as the amount of enzyme that transfers 1 nmole of acetyl groups from acetyl-CoA to chloramphenicol in 1 minute at  $37^\circ\text{C}$  [pH 7.8]).

**ALTERNATIVE PROTOCOL: MEASUREMENT OF CAT BY DIFFUSION OF REACTION PRODUCTS INTO SCINTILLATION FLUID**

This improved version of the previous alternative protocol does not involve extraction of the acetylated chloramphenicol into ethyl acetate. Instead, the reaction mixture is overlaid with water-immiscible scintillation fluid. Acetylated forms of chloramphenicol produced by the activity of CAT in the aqueous phase diffuse rapidly into the scintillation fluid (Neumann et al. 1987), where they are trapped. Acetyl-CoA and nonacetylated chloramphenicol remain in the aqueous phase. Only the radioactivity in the scintillation fluid can be detected by liquid scintillation counting, and this can be measured at any stage during the enzymatic reaction. Because this technique is a continuous assay, rather than a single-endpoint assay, it yields semiquantitative kinetic data that can be analyzed by standard mathematical formulas.

In the original description of this method, high concentrations (100  $\mu\text{M}$ ) of unlabeled acetyl-CoA were used to ensure that sufficient substrate was present to satisfy the  $K_m$  of CAT. Large amounts (5  $\mu\text{Ci}$  of  $^3\text{H}$ ) of expensive radiolabeled acetyl-CoA were therefore required in each assay. However, adequate results can be obtained by omitting the unlabeled acetyl-CoA from the assay and reducing the amount of radioactive substrate to 0.1  $\mu\text{Ci}$  (Eastman 1987). Under these conditions, the reaction is linear with enzyme concentration as long as less than 0.0125 unit of CAT is present per assay (where 1 unit of CAT catalyzes the acetylation of 1 nmole of chloramphenicol in 1 minute at 37°C at pH 7.8). Commercial preparations of CAT are available (e.g., Sigma) that can be used both as positive controls and to standardize enzyme activity in crude extracts of transfected cells.

**CAUTION:** Please see Appendix 12 for appropriate handling of materials marked with <!>.

**Additional Materials***CAT reaction mixture 3*

1 M Tris-Cl (pH 7.8)	25 $\mu\text{l}$
5 mM chloramphenicol <!>	50 $\mu\text{l}$
[ $^3\text{H}$ ]acetyl-CoA (200 mCi/mmole) <!>	0.1 $\mu\text{Ci}$
H <sub>2</sub> O	to 200 $\mu\text{l}$

The 5 mM solution of chloramphenicol is made by dissolving 1.6 mg of chloramphenicol in 1 ml of ethanol. [ $^3\text{H}$ ]acetyl-CoA can be purchased at the indicated specific activity (e.g., New England Nuclear) or diluted from higher specific activity stocks in H<sub>2</sub>O. Store the radiolabeled acetyl-CoA at -70°C. [ $^{14}\text{C}$ ]acetyl-CoA (0.1  $\mu\text{Ci}$ ) can be substituted for the tritium-labeled compound. The concentrations of reagents in the final reaction mixture are 125 mM Tris-Cl, 1.25 mM chloramphenicol, and 0.35 mM acetyl-CoA.

For each 30  $\mu\text{l}$  of cell extract to be tested, 200  $\mu\text{l}$  of CAT reaction mixture 3 is required.

*Glass scintillation vials (7 ml)*

*Water-immiscible scintillation fluid (e.g., Econofluor, New England Nuclear)*

**Method**

1. Prepare extracts of transfected cells as described in the main protocol, Steps 1–4. Reserve 30- $\mu\text{l}$  aliquots of the extracts for the CAT assay.
2. Mix 30  $\mu\text{l}$  of each cell extract with 20  $\mu\text{l}$  of 100 mM Tris-Cl (pH 7.8) in a 7-ml glass scintillation vial. Heat the mixtures for 15 minutes at 65°C to inactivate deacetylases in the extract. Transfer the vials to a water bath set at 37°C.
3. Add 200  $\mu\text{l}$  of freshly prepared CAT reaction mixture 3. Use a pipette to carefully overlay the reaction mixtures with 5 ml of a water-immiscible scintillation fluid, and then incubate the mixtures at 37°C. Mixing of the two phases is not necessary. Measure the radioactivity in the scintillation fluid by liquid scintillation counting (please see Appendix 8). Calculate the specific activity of the CAT after measuring the concentration of protein in the cell extracts.

The vials containing the reaction mixtures may be counted for 0.1 minute at selected time intervals (e.g., every 20 minutes) until the enzymatic reaction is complete, or they may be counted at a single endpoint determined on the basis of previous experiments.

# Protocol 6

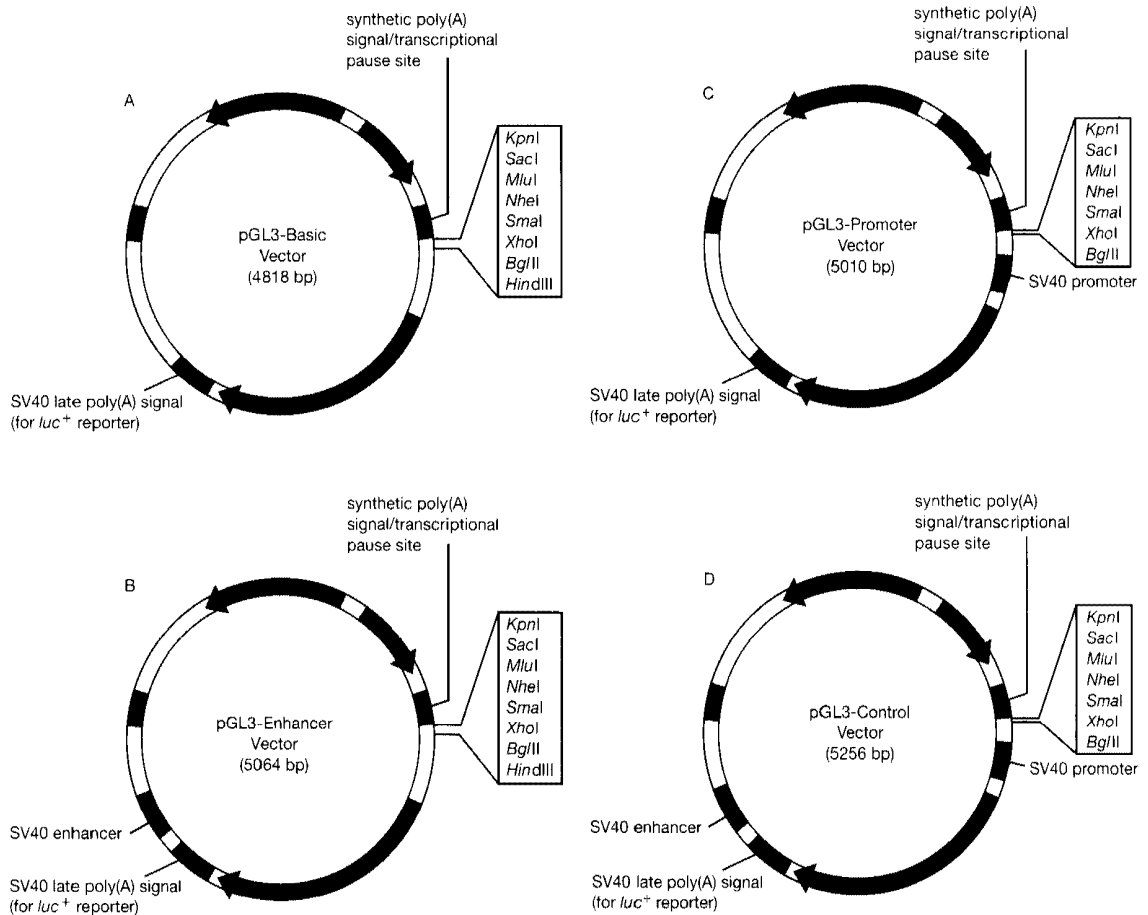
---

## Assay for Luciferase in Extracts of Mammalian Cells

**L**UCIFERASE IS THE REPORTER GENE OF CHOICE in many laboratories: (1) The luciferase assay is more sensitive than assays for CAT or other commonly used reporter genes. The exceptionally high sensitivity of the luciferase assay allows analysis of weak promoters and use of smaller amounts of DNA and cells in transfection studies. (2) The assay does not require the use of radioactive materials. (3) The assay is linear over eight orders of magnitude, and small amounts of transfected cell lysate can therefore be assayed for enzyme activity and whole dish-to-dish comparisons are made easier. (4) The buffer used to lyse cells is compatible with other assays for marker genes such as CAT, other luciferase genes, and  $\beta$ -galactosidase, which simplifies the process of normalization, and in some cases, allows the assay of two marker genes in the same aliquot of cell lysate. (5) The luciferase assay can be carried out in 96-well plates to facilitate the analyses of large numbers of transfected cells (please see the panel on **ALTERNATIVE PROTOCOL: ASSAY FOR LUCIFERASE IN CELLS GROWING IN 96-WELL PLATES** at the end of this protocol).

Luminometers or standard scintillation counters can be used to detect light released by the action of the luciferase enzyme. Of these two, measurement with a scintillation counter is more sensitive (Hill et al. 1993) but requires more time. Many different types of luminometers are commercially available (for review, please see Stanley 1992). Although these devices are quite expensive (\$20,000–30,000), the assays themselves are very quick, and it is thus usually possible for several laboratories to share one machine.

In this protocol, we describe methods for the measurement of luciferase expressed from vectors transfected into mammalian cells (please see Figure 17-4). Additional enzyme activities, such as those for CAT,  $\beta$ -galactosidase, and alkaline phosphatase, can also be directly measured in cell lysates prepared as described in this protocol. For a more complete description of luciferase, please see the information panel on **LUCIFERASE**.



**FIGURE 17-4 pGL3 vectors**

Summarized here are the features of the pGL3 vectors that carry the coding sequence for a modified version of firefly luciferase (*luc*<sup>+</sup>). All vectors in the series contain (1) the origin of replication derived from filamentous phage (*f1 ori*), (2) an origin of plasmid replication in *E. coli* (*ori*), (3) an ampicillin resistance marker (*Amp*<sup>R</sup>) for selection in prokaryotic cells, and (4) a poly(A) addition signal and a transcriptional pause site located 5' of the *luc*<sup>+</sup> gene to reduce the background of readthrough transcription from upstream sequences. The arrows in *luc*<sup>+</sup> and *Amp*<sup>R</sup> indicate the directions of transcription. The sequence of interest is inserted into the multiple cloning site (MCS) at the 5' end of *luc*<sup>+</sup>. (A) The basic vector lacks eukaryotic promoter and enhancer sequences. The expression of luciferase in this vector depends on the insertion and proper orientation of a functional promoter upstream of the intron and *luc*<sup>+</sup> gene. Putative enhancer elements can also be inserted upstream of the promoter or in the *Bam*HI or *Sal*I sites downstream from the *luc*<sup>+</sup> gene. (B) The enhancer vector carries an SV40 enhancer located downstream from the *luc*<sup>+</sup> gene and poly(A) addition signal. The enhancer aids in identifying functional promoter elements, because its presence often results in high levels of transcription of the *luc*<sup>+</sup> gene. (C) The promoter vector contains an SV40 promoter upstream of the intron and the *luc*<sup>+</sup> gene. DNA sequences carrying putative enhancer elements can be inserted either upstream or downstream from the promoter-*luc*<sup>+</sup> transcription unit. (D) The control vector contains the SV40 promoter and enhancer sequences, resulting in strong expression of *luc*<sup>+</sup> in many mammalian cell lines. This vector may be used to monitor transfection efficiency and is a convenient standard for promoter and enhancer activities expressed by pGL3 recombinants. (Modified, with permission, from Promega Corp.)

## MATERIALS

---

### Buffers and Solutions

Please see Appendix 1 for components of stock solutions, buffers, and reagents. Dilute stock solutions to the appropriate concentrations.

#### *Cell lysis buffer*

25 mM glycylglycine (pH 7.8)  
15 mM MgSO<sub>4</sub>  
4 mM EGTA  
1% (v/v) Triton X-100

Just before use, add dithiothreitol from a 1 M stock solution to a final concentration of 1 mM. Approximately 1 ml of cell lysis buffer is needed per 100-mm dish of cells to be assayed.

#### *Luciferase assay buffer*

15 mM potassium phosphate (pH 7.8)  
25 mM glycylglycine  
15 mM MgSO<sub>4</sub>  
4 mM EGTA  
2 mM ATP

Just before use, add dithiothreitol from a 1 M stock solution to a final concentration of 1 mM. Approximately 400  $\mu$ l of luciferase enzyme assay buffer is needed per luminometer assay tube.

#### *Luciferin solution*

25 mM glycylglycine  
15 mM MgSO<sub>4</sub>  
4 mM EGTA  
0.2 mM luciferin

Just before use, add dithiothreitol from a 1 M stock solution to a final concentration of 2 mM. Approximately 200  $\mu$ l of luciferin solution is needed per luminometer assay tube. The addition of 1–2  $\mu$ M CoA to the luciferin solution will produce a more intense and sustained light emission (Wood 1991).

▲ **IMPORTANT** Luciferin is a generic term for substrates that generate light when acted upon by a luciferase enzyme. The most common luciferase gene in use is derived from the firefly and acts on a particular luciferin substrate. Other luciferase enzymes, such as those from the sea pansy (*Renilla reniformis*) or certain marine bacteria, use chemically different luciferin substrates. Make sure that the luciferin substrate used in the above buffer matches the luciferase gene incorporated into the expression plasmid.

*Phosphate-buffered saline (PBS) without calcium and magnesium salts*

### Special Equipment

*Luminometer and luminometer assay tubes*  
*Rubber policeman*

### Cells and Tissues

#### *Cultured mammalian cells transfected with the DNA of interest*

The cells should be transfected (using one of the transfection protocols in Chapter 16) with a luciferase reporter construct (please see Figure 17-4) and an expression plasmid containing the  $\beta$ -galactosidase gene (pCMV-SPORT- $\beta$ -gal; please see Figure 16-2 in Chapter 16) or another reporter gene suitable for normalizing the results of luciferase assay.

**OPTIMIZING THE MEASUREMENT OF LUCIFERASE ENZYME ACTIVITY**

- The importance of working in the linear range of the luciferase assay cannot be overemphasized. A twofold difference in signal between two enzyme preparations assayed in the nonlinear range can translate into a 100-fold difference when the same preparations are assayed in the linear range. For each transfected culture, it is important to establish that the signal obtained is proportional to the volume of lysate added to the assay.
- Lysis of cells by freezing and thawing results in the inactivation and inefficient recovery of luciferase (Brasier et al. 1989). For this reason, a buffer containing a nonionic detergent such as Triton X-100 is used to lyse the plasma membranes of transfected cells and to release cytoplasmic luciferase. At the concentrations of detergent used, the nuclear membrane remains intact and does not release chromatin into the cell lysate.
- The concentration of ATP required to obtain maximum luciferase activity varies depending on the cell type transfected. For some cells, such as HepG2 cells, the optimum concentration of ATP in the assay is 2 mM (Brasier et al. 1989), whereas in other cell lines such as mouse L cells, the optimum is 0.3 mM (Nguyen et al. 1988). The presence of excess ATP leads to a decrease in enzyme activity due to allosteric inhibition (DeLuca and McElroy 1984). For these reasons, it is a good idea to determine empirically the optimum ATP concentration for each cell line (or buffer) used in luciferase assays.
- The amount of luciferase expressed in a transfected cell from a given construct is a function of the strength of the promoter, as well as the kinetics of luciferase mRNA transport, translation, and enzyme turnover. The time at which luciferase expression is maximal following transfection can be as short as 16 hours or as long as 120 hours, depending on the cell line.

**METHOD**

1. Between 24 and 72 hours after transfection, wash the cells three times at room temperature with PBS without calcium and magnesium salts. Add and remove the PBS gently, because some mammalian cells (e.g., human embryonic kidney 293 cells) can be easily displaced from the dish by vigorous pipetting.

Although 24–72 hours may be a typical period of time to allow maximal expression of the luciferase gene in transfected cells, please see the comments in the panel on **OPTIMIZING THE MEASUREMENT OF LUCIFERASE ENZYME ACTIVITY**.

2. Add 1 ml of ice-cold cell lysis buffer per 100-mm dish of transfected cells. Swirl the buffer gently and scrape the lysed cells from the dish using a rubber policeman. Transfer the cell lysate to a 1.5-ml microfuge tube.
3. Centrifuge the cell lysate at maximum speed for 5 minutes at 4°C in a microfuge. Carefully transfer the supernatant to a fresh 1.5-ml microfuge tube.
4. Determine the concentration of protein in the lysate using a rapid colorimetric assay, such as the Bradford assay. Reduce the concentration of Triton X-100 to  $\leq 0.1\%$  by dilution before determining the concentration of protein to prevent interference with the assay.

The cell lysates may be stored at this step as small aliquots at  $-70^{\circ}\text{C}$ . Although the luciferase is unstable when stored at  $4^{\circ}\text{C}$  or  $-20^{\circ}\text{C}$  in this lysis buffer (Brasier et al. 1989), the enzyme can be safely stored at  $4^{\circ}\text{C}$  in lysis buffer containing 15% (v/v) glycerol and 1% (w/v) bovine serum albumin.

5. Tap the side of the tube containing the lysate to gently mix the contents. Add 5–200- $\mu\text{l}$  aliquots of cell lysate to individual luminometer tubes containing 360  $\mu\text{l}$  of luciferase assay buffer at room temperature. Place a tube in the luminometer.

An alternative to using a luminometer to measure the luciferase enzyme activity is presented in the panel on **ALTERNATIVE PROTOCOL: USING A SCINTILLATION COUNTER TO MEASURE LUCIFERASE**.

6. To start the assay, inject 200  $\mu$ l of luciferin solution into the luminometer tube and measure the light output for a period of 2–60 seconds at room temperature.  
The optimum time of light collection must be determined empirically and will depend on the type of cell transfected and the particular substrate and luciferase enzyme used.
7. Measure the relative light units generated in each tube and determine the linear range of the assay. Use the amount of cell lysate protein that produces a response in the middle of the linear range in subsequent assays. This amount will vary depending on the strength of the promoter being studied, and to a lesser extent, on the efficiency of transfection in individual experiments. Express luciferase activity as relative light units/mg of protein in the cell lysate.

#### ALTERNATIVE PROTOCOL: USING A SCINTILLATION COUNTER TO MEASURE LUCIFERASE

A scintillation counter can be used in place of a luminometer to detect light emitted by the action of luciferase on luciferin (Nguyen et al. 1988; Fulton and Van Ness 1993). A somewhat higher sensitivity is claimed for scintillation counting over luminometry (Hill et al. 1993); however, luciferase assays require more time when using a scintillation counter. Nguyen et al. (1988) reported that the intensity and kinetics of light emitted by luciferase in cell lysates were sensitive to pH and the particular buffer used in the lysate. If the luciferase assay buffer recommended in the protocol does not yield consistent enzyme activity measurements, then substitute 25 mM Tris-phosphate (pH 7.8) for the glycylglycine component of all the buffers.

#### Method

1. Prepare cell lysates from transfected cells as described in Steps 1–4 of the main protocol.
2. Transfer an aliquot of cell lysate in a 1.5-ml microfuge tube, add luciferase assay buffer followed by the luciferin solution, and quickly mix the ingredients by gently tapping or vortexing the tube. Within 10–15 seconds of mixing the reagents, place the tube in a scintillation counter and count for a 3-minute interval, using either a specialized channel for chemiluminescence or a broad channel to detect all low-energy emissions. It is important to standardize the time between reagent mixing and scintillation counting, as variations in this time can give rise to 2–3% fluctuations in luminescent intensity (Nguyen et al. 1988).

If the scintillation counter has a switch to turn off the coincidence circuit (i.e., a specialized channel for measuring chemiluminescence), and this circuit is turned off before counting of the luciferase-containing tube, then the counts per minute detected are directly proportional to the amount of luciferase enzyme present in the aliquot of cell lysate (minus any blank value obtained with mock-transfected cell lysate). If the coincidence circuit is not turned off, then the amount of luciferase enzyme is proportional to the square root of the counts per minute, i.e.,

$$\text{Amount of enzyme} = (\text{cpm in sample} - \text{cpm in blank})^{1/2}$$

The coincidence circuit in a scintillation counter links dual amplifiers (photomultipliers) that flank the counting chamber and record simultaneous signals (radioactive decay) emitted by the sample. A degradation event is only counted if it is detected by both amplifiers at the same time. This method of detection eliminates background noise resulting from stray radiation and heat. When measuring chemiluminescence, the chance that two light-emitting events will occur simultaneously is proportional to the chance of having two coincident events in two independent series of totally random events, a frequency that is described by the square of the luminescent intensity. Thus, by taking the square root of the observed intensity (cpm obtained when the coincidence circuit is on), the activity of luciferase in the sample is accurately obtained.

**ALTERNATIVE PROTOCOL: ASSAY FOR LUCIFERASE IN CELLS GROWING IN 96-WELL PLATES**

To facilitate high-throughput screening, transfected cells can be cultured in 96-well microtiter plates and screened in a luminometer capable of reading the assay directly from the plates. The following protocol is adapted from one supplied by Makoto Makishima and David Mangelsdorf (University of Texas Southwestern Medical Center, Dallas).

**CAUTION:** Please see Appendix 12 for appropriate handling of materials marked with <!>.

**Additional Materials**

0.1 M ATP

50 mM CoA

10x Core buffer

300 mM tricine (pH 7.8)

80 mM magnesium acetate

2 mM EDTA

10 mM luciferin

$\beta$ -mercaptoethanol <!>

Phosphate-buffered saline (PBS) lacking calcium and magnesium salts

10% (v/v) Triton X-100

**Method**

1. Prepare the luciferase assay-lysis buffer as follows:

10x core buffer	2 ml
10% Triton X-100	2 ml
10 mM luciferin	1 ml
0.1 M ATP	300 $\mu$ l
50 mM CoA	200 $\mu$ l
$\beta$ -mercaptoethanol	140 $\mu$ l
H <sub>2</sub> O	to 20 ml

A 90-mm culture dish will provide enough cells to inoculate four 96-well plates. Each plate will require ~5 ml of luciferase assay-lysis buffer.

2. Wash the transfected cells three times with PBS, tapping the inverted plate gently onto paper towels between each wash.
3. Add 50  $\mu$ l of luciferase assay-lysis buffer to each well of cells. Avoid making bubbles in the wells. Incubate the plates for 1 minute at room temperature.
4. Measure the light output from the reactions in a luminometer according to the manufacturer's instructions. The optimum time of light collection must be determined empirically and will depend on the type of cell transfected and the particular substrate and luciferase enzyme used.



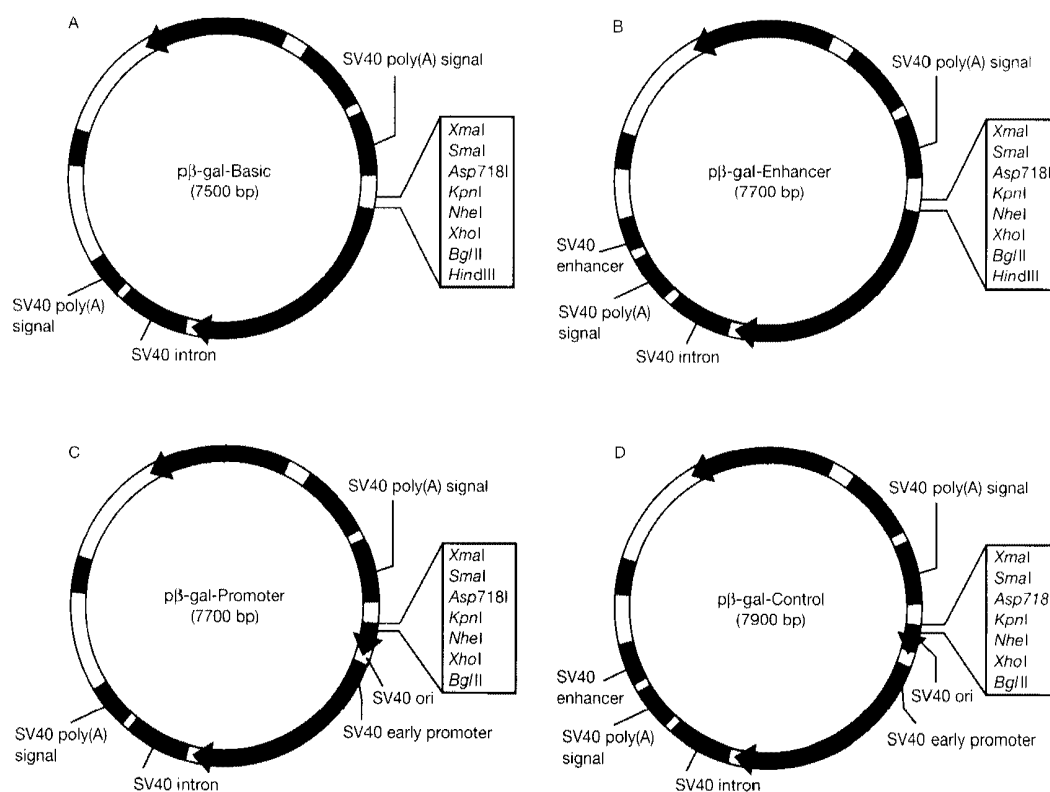
# Protocol 7

---

## Assay for $\beta$ -galactosidase in Extracts of Mammalian Cells

**T**HE *E. COLI*  $\beta$ -GALACTOSIDASE GENE IS OFTEN USED AS AN INTERNAL REFERENCE in transfection studies (Hall et al. 1983). In a typical experiment, a test plasmid containing a eukaryotic gene promoter linked to CAT or luciferase is cotransfected into a mammalian cell line with a small amount of a plasmid that contains the  $\beta$ -galactosidase gene linked to a strong constitutive promoter. After a period of time to allow expression, enzyme activities arising from the expression of test and control plasmid are determined in cell lysates. By dividing the amount of CAT or luciferase activity by the  $\beta$ -galactosidase activity, a normalized expression value can be obtained (please see below). Constructs are available that carry the  $\beta$ -galactosidase gene downstream from promoters that express strongly in a wide variety of eukaryotic cell types (e.g., the SV40 early promoter, the Rous sarcoma virus long terminal repeat promoter, or the immediate early region promoter of cytomegalovirus; for a description of these plasmids, please see Figure 16-2 in the introduction to Chapter 16). Extracts of most types of cultured mammalian cells contain relatively low levels of endogenous  $\beta$ -galactosidase activity, and an increase in enzyme activity of up to 100-fold can usually be detected during the course of a transfection. With effort,  $\beta$ -galactosidase can also be used as an internal control in certain specialized cells (e.g., gut epithelial cells and human embryonic kidney 293 cells) that express high endogenous levels of  $\beta$ -galactosidase activity. Because endogenous  $\beta$ -galactosidase activity is usually more heat-labile than the bacterial enzyme, a heating step can be used to eliminate the endogenous  $\beta$ -galactosidase activity while preserving the bacterial activity expressed from the control plasmid (Young et al. 1993). In addition, most mammalian  $\beta$ -galactosidases are associated with the lysosome and therefore have an acidic pH optimum. The *E. coli* enzyme has a neutral to slightly alkaline pH optimum. The contribution of the mammalian enzyme can therefore be reduced by carrying out the  $\beta$ -galactosidase assay at pH 7.5. For further details, please see the information panel on  $\beta$ -GALACTOSIDASE.

Several different approaches are used to normalize CAT or other reporter enzyme activities to  $\beta$ -galactosidase activity. In one approach, the amount of protein in individual extracts prepared from a series of transfected cells is first measured, and CAT and  $\beta$ -galactosidase are then assayed separately using a standard amount of protein in each assay. Finally, the CAT activity is normalized to the  $\beta$ -galactosidase activity. In another method, the  $\beta$ -galactosidase activity in a constant volume of extract is first measured, and CAT assays are then carried out using amounts of extract containing the same amount of  $\beta$ -galactosidase activity. Alternatively, both enzymatic assays are carried out in a constant volume of extract, and the results are then normalized to a defined level of  $\beta$ -galactosidase activity (i.e., the amount of CAT activity is divided by the amount of  $\beta$ -galactosidase activity).


**FIGURE 17-5**  $\beta$ -gal Vectors

Summarized here are the features of  $\beta$ -gal reporter vectors that carry the coding sequence for  $\beta$ -galactosidase. All vectors in the series contain (1) the origin of replication derived from filamentous phage (f1 ori), (2) an origin of plasmid replication in *E. coli* (ori), (3) the origin of replication for SV40 that allows replication in mammalian cells, (4) an ampicillin resistance marker ( $Amp^R$ ) for selection in prokaryotic cells, and (5) a poly(A) addition signal located 5' of *lacZ* to reduce the background of readthrough transcription from upstream sequences. The sequence of interest is cloned into the multiple cloning site (MCS) at the 5' end of the *lacZ* gene. (A)  $\beta$ -gal-Basic lacks eukaryotic promoter and enhancer sequences. This vector may be used as a negative control or as a vehicle to characterize cloned promoters. (B)  $\beta$ -gal-Enhancer lacks the SV40 promoter, but contains the SV40 enhancer. This vector can be used to study cloned promoter sequences. (C)  $\beta$ -gal-Promoter lacks the SV40 enhancer, but contains the SV40 promoter. This vector can be used to study cloned enhancer sequences. (D)  $\beta$ -gal-Control contains the SV40 early promoter and enhancer. This vector can be used as a positive control or as a reference when comparing the activities of different promoter and enhancer elements. (Modified, with permission, from CLONTECH.)

ity). With some marker genes such as luciferase, the amounts of  $\beta$ -galactosidase and luciferase that are present in the same aliquot of cell lysate can be determined by using different luminescent substrates simultaneously.

This protocol describes the detection of  $\beta$ -galactosidase expressed from reporter vectors (please see Figure 17-5) transfected into mammalian cells. The assay described is both simple and rapid and can be carried out using a visible light spectrophotometer. Please note that several manufacturers sell kits that can be used to assay  $\beta$ -galactosidase in eukaryotic cell lysates. The average cost of a single reaction is typically  $\leq 1$  dollar. Many of these kits contain the same buffers listed here and adhere closely to the protocol. However, some kits gain a distinct advantage by containing a cell lysis buffer which allows multiple enzyme activities to be assayed, including  $\beta$ -galactosidase, CAT (Protocol 5), and luciferase (Protocol 6).

ONPG (*o*-nitrophenyl- $\beta$ -D-galactopyranoside) is the most widely used substrate in assays for  $\beta$ -galactosidase in bacterial and eukaryotic cell lysates. ONPG is colorless but on hydrolysis yields *o*-nitrophenol that is yellow in alkaline solution ( $\lambda_{\text{max}}$  420 nm at pH 10.2). When ONPG is in excess, the OD<sub>420</sub> of the assay solution increases linearly as a function of time and enzyme concentration (Lederberg 1950; Hestrin et al. 1955; Pardee et al. 1959; Miller 1972, 1992). The reaction can be stopped by adding a concentrated solution of Na<sub>2</sub>CO<sub>3</sub>, which shifts the pH to ~11, inactivates  $\beta$ -galactosidase, and maximizes the absorbance of *o*-nitrophenol at 420 nm.

## MATERIALS

**CAUTION:** Please see Appendix 12 for appropriate handling of materials marked with <!>.

### Buffers and Solutions

Please see Appendix 1 for components of stock solutions, buffers, and reagents. Dilute stock solutions to the appropriate concentrations.

#### 100x Mg<sup>2+</sup> solution

0.1 M MgCl<sub>2</sub>  
4.5 M  $\beta$ -mercaptoethanol <!>

Just before use, add an appropriate amount of  $\beta$ -mercaptoethanol from a 14.7 M stock.

#### Na<sub>2</sub>CO<sub>3</sub> (1 M)

Dissolve 10.6 g of the anhydrous solid in 100 ml of H<sub>2</sub>O.

#### 1x ONPG

Dissolve ONPG at a concentration of 4 mg/ml in 0.1 M sodium phosphate (pH 7.5).

#### Sodium phosphate (0.1 M, pH 7.5)

Mix 41 ml of 0.2 M Na<sub>2</sub>HPO<sub>4</sub>·2H<sub>2</sub>O ( $M_r$  = 178.05; 35.61 g/liter), 9 ml of 0.2 M NaH<sub>2</sub>PO<sub>4</sub>·2H<sub>2</sub>O ( $M_r$  = 156.01; 31.21 g/liter), and 50 ml of H<sub>2</sub>O.

#### Tris-Cl (1 M, pH 7.8)

### Enzymes and Buffers

#### *E. coli* $\beta$ -galactosidase

The enzyme is commercially available (e.g., Sigma).

### Additional Reagents

Step 1 of this protocol requires the reagents listed in Protocol 5 of this chapter.

### Cells and Tissues

#### Cultured mammalian cells transfected with the DNA of interest

Use one of the transfection protocols in Chapter 16 to transfect the cells with a plasmid containing a  $\beta$ -galactosidase reporter gene (e.g., the p $\beta$ -gal reporter series from CLONTECH; please see Figure 17-5).

#### $\beta$ -GALACTOSIDASE SUBSTRATES

The assay relies on the ability of the *E. coli*  $\beta$ -galactosidase enzyme to hydrolyze ONPG to free *o*-nitrophenol and  $\beta$ -D-galactose (Lederberg 1950). The substrate *o*-nitrophenol is yellow in aqueous solutions and absorbs light of 420 nm wavelength. Since the invention of this assay by Joshua Lederberg, more sensitive substrates for the detection of  $\beta$ -galactosidase have been developed. These include 4-methylumbelliferyl  $\beta$ -D-galactoside (Sigma, catalog no. M1633), whose hydrolysis product 4-methylumbelliferone is detected by fluorometry (excitation wavelength = 364 nm, emission wavelength = 440 nm) and is blue in buffers with a basic pH (Roth 1969), and chlorophenol red  $\beta$ -D-galactopyranoside (Boehringer Mannheim), whose hydrolysis product is detected in a visible-light spectrophotometer at 570 nm wavelength (Eustice et al. 1991). An assay using 4-methylumbelliferyl- $\beta$ -D-galactoside as a substrate is about tenfold more sensitive than one using ONPG, whereas an assay using chlorophenol red  $\beta$ -D-galactopyranoside is ~20 times more sensitive than one using ONPG. Finally, chemiluminescent substrates for  $\beta$ -galactosidase whose hydrolysis product can be detected in a luminometer or scintillation counter are sold by several companies (e.g., Lumi-Gal, Lumigen Corp., Detroit, Michigan; Galacto-Light, Tropix Corp., Bedford, Massachusetts). For a review of one of these dual-assay kits, please see Martin et al. (1996). Assays using chemiluminescent substrates are 20–1000-fold more sensitive than ONPG-based assays (Jain and Magrath 1991; Beale et al. 1992). For further details, please see Appendix 9.

## METHOD

1. Prepare cell extracts from the transfected cells as described in Protocol 5, Steps 1–4. Set aside  $\sim 30 \mu\text{l}$  of the extract for the  $\beta$ -galactosidase assay. The exact amount of extract required will depend on the strength of the promoter driving the expression of the  $\beta$ -galactosidase gene, the efficiency of transfection, and the incubation time of the assay. If a heat treatment is to be used to inactivate endogenous  $\beta$ -galactosidases, incubate the cell lysates for 45–60 minutes at  $50^\circ\text{C}$  before assay. Luciferase activity is also inactivated by preheating; assay luciferase and  $\beta$ -galactosidase activities in separate aliquots of cell lysate if a preheating step has been used.
2. For each sample of transfected cell lysate to be assayed, mix:
 

100x $\text{Mg}^{2+}$ solution	3 $\mu\text{l}$
1x ONPG	66 $\mu\text{l}$
cell extract	30 $\mu\text{l}$
0.1 M sodium phosphate (pH 7.5)	201 $\mu\text{l}$

It is essential to include positive and negative controls. These assays check for the presence of endogenous inhibitors and  $\beta$ -galactosidase, respectively. All of the controls should contain 30  $\mu\text{l}$  of cell extract from mock-transfected cells. In addition, the positive controls should include 1  $\mu\text{l}$  of a commercial preparation of *E. coli*  $\beta$ -galactosidase (50 units/ml). The commercial enzyme preparation should be dissolved at a concentration of 3000 units/ml in 0.1 M sodium phosphate (pH 7.5). Just before use, transfer 1  $\mu\text{l}$  of the stock solution of  $\beta$ -galactosidase into 60  $\mu\text{l}$  of 0.1 M sodium phosphate (pH 7.5) to make a working stock of the enzyme containing 50 units/ml. One unit of *E. coli*  $\beta$ -galactosidase is defined as the amount of enzyme that will hydrolyze 1  $\mu\text{mole}$  of ONPG substrate in 1 minute at  $37^\circ\text{C}$ .
3. Incubate the reactions for 30 minutes at  $37^\circ\text{C}$  or until a faint yellow color has developed. In most cell types, the background of endogenous  $\beta$ -galactosidase activity is very low, allowing incubation times as long as 4–6 hours to be used.
4. Stop the reactions by adding 500  $\mu\text{l}$  of 1 M  $\text{Na}_2\text{CO}_3$  to each tube. Read the optical density of the solutions at a wavelength of 420 nm in a spectrophotometer.
 

The linear range of the assay is 0.2–0.8  $\text{OD}_{420}$ . If the assay fails outside this range, repeat the experiment using less protein extract. The extract can be diluted in 0.25 M Tris-Cl (pH 7.8) to decrease the protein concentration.

Biochemists calculate the specific activity of the  $\beta$ -galactosidase enzyme and express this value as units of enzyme activity per milligram of cell protein, where 1 unit of *E. coli*  $\beta$ -galactosidase is defined as the amount of enzyme that will hydrolyze 1  $\mu\text{mole}$  of ONPG substrate in 1 minute at  $37^\circ\text{C}$ . This value can then be used to normalize expression of the marker gene, whose specific activity has also been determined. Most molecular biologists simply divide the amount of CAT or luciferase activity by the amount of  $\beta$ -galactosidase activity present in a given volume to normalize for transfection efficiency, thus ignoring the calculation of specific activity.

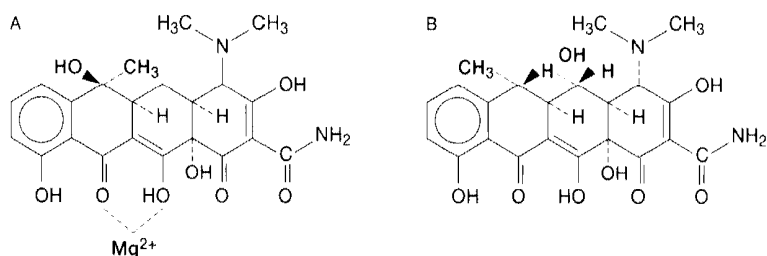
# Protocol 8

## Tetracycline as Regulator of Inducible Gene Expression in Mammalian Cells

**W**HEN ESTABLISHED WITH DILIGENCE AND USED WITH CARE, tetracycline-responsive expression systems offer an elegant method to maintain control over the expression of genes transfected into eukaryotic cells. The systems discussed below have evolved over the years and have been used successfully to control gene expression in a wide variety of organisms, including cultured mammalian, amphibian, and plant cells (for review, please see Freundlieb et al. 1997), and *Saccharomyces cerevisiae* (Garí et al. 1997; Bellí et al. 1998); in transgenic organisms that include *Drosophila melanogaster* (Girard et al. 1998), plants (Weinmann et al. 1994; Zeidler et al. 1996), and mammals (Furth et al. 1994; Efrat et al. 1995; Ewald et al. 1996; Kistner et al. 1996; Redfern et al. 1999), and mammalian tissues into which genes have been directly injected (Fishman et al. 1994; Dhawan et al. 1995). For further general information on systems for inducible expression, please see, for example, Kost (1997), Saez et al. (1997), Shockett and Schatz (1997), and Rossi and Blau (1998).

### TETRACYCLINE

The first of the tetracyclines — chlortetracycline — was discovered in 1948 as a naturally occurring antibiotic that was synthesized by *Streptomyces aureofaciens* and was active against a wide range of Gram-positive and -negative bacteria and protozoa. By 1980, ~1000 tetracycline derivatives had been isolated and/or synthesized, and the estimated global production of the drugs was



**FIGURE 17-6 Structure of Tetracycline and Doxycycline**

The carbon atoms in the tetracycline skeleton carry substitute groups in various tetracycline derivatives. Chemical bonds (colored arrowheads) appear above the plane of the figure; ionic bonds (dashed lines) appear below the plane of the figure. (A) Tetracycline- $Mg^{2+}$ ; (B) doxycycline.

in excess of 500 metric tons (for review, please see Chopra et al. 1992). All of these compounds share an identical four-ring carbocyclic skeleton that supports a variety of groups at carbons 5, 6, and 7 and binds  $Mg^{2+}$  through oxygen atoms attached to carbons 11 and 12 (Figure 17-6).

Entry of tetracycline into bacterial cells involves passive diffusion across the outer membrane through porin channels, which are composed of the OmpF protein. However, onward movement from the periplasmic space into the cytoplasm does not appear to involve a specific protein channel. Instead, tetracycline crosses the cytoplasmic membrane by facilitated diffusion in a process driven by pH or electropotential gradients. Tetracycline inhibits bacterial growth by binding to ribosomes ( $K_a \sim 10^9 M^{-1}$ ) and disrupting codon-anticodon interactions (for reviews, please see Tritton 1977; Gale et al. 1981; Chopra 1985; Chopra et al. 1992). Specifically, tetracycline prevents attachment of aminoacyl-tRNA to the acceptor site on the 30S ribosomal subunit. Tetracycline binds tightly, albeit reversibly, to a single site on the 30S subunit that is composed of residues from at least four proteins (S3, S7, S14, and S19) and residues from the 893–1054 region of 16S rRNA.

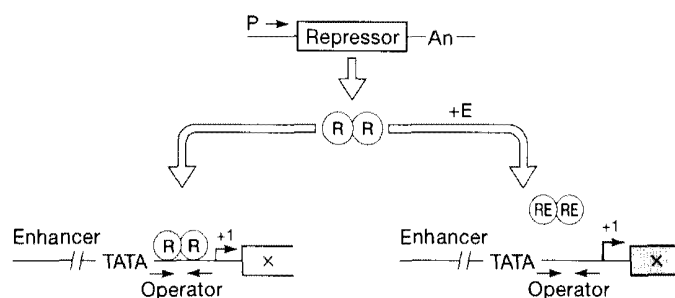
The chief mechanism by which *E. coli* becomes resistant to high concentrations of tetracycline involves multimeric antiporter proteins, known as Tet proteins, that are embedded in the bacterial inner membrane and, in exchange for a proton, catalyze the outward transport of tetracycline- $Mg^{2+}$  complexes from the cytosol (Franklin 1967; McMurry et al. 1980; Kaneko et al. 1985; Hickman and Levy 1988; Yamaguchi et al. 1990; Thanassi et al. 1995). Of the several known classes of Tet antiporters, the TetA proteins encoded by transposon Tn10 and the plasmid pBR322 are the most important in molecular cloning; 399 amino acids in length (Backman and Boyer 1983), they consist of two domains, each containing six transmembrane segments. The two domains are connected by a cytoplasmic loop of 30–40 amino acids rich in positively charged residues (for review, please see Chopra et al. 1992).

When TetA is present in high concentrations, cations are transported from the bacterial cell at such a rate that the membrane becomes depolarized and the viability of the cell is threatened (Eckert and Beck 1989). To prevent catastrophe, expression of TetA is tightly controlled by a helix-turn-helix repressor protein (TetR, 24 kD), the product of the *tetR* gene. In the absence of antibiotic, homodimers of the repressor bind tightly ( $K_d = 10^{-11} M$ ) to the major grooves of two 15-bp palindromic operator sequences (*tetO*<sub>1,2</sub>), thus preventing expression of the divergently transcribed genes *tetR* and *tetA* (Hillen et al. 1984; Heuer and Hillen 1988; Kleinschmidt et al. 1988; Hillen and Berens 1994; Hinrichs et al. 1994; Helbl et al. 1995; Orth et al. 2000). TetR is therefore a powerful negative regulator of transcription both of its own gene and of *tetA*.

Binding of tetracycline- $Mg^{2+}$  to TetR ( $K_a = 10^9 M^{-1}$ ) induces a conformational change that reduces the affinity of the repressor for *tetO* by nine orders of magnitude (Kleinschmidt et al. 1988; Lederer et al. 1995). The differentials between binding constants ensure that transcription of *tetR* is suppressed in the absence of tetracycline and induced by concentrations of the drug that are too low to affect protein synthesis (please see Figure 17-7). Crystal structures are now available for free TetR (Orth et al. 1998), the complexes between TetR and tetracycline- $Mg^{2+}$  (Hinrichs et al. 1994; Kisker et al. 1995), and the complexes between TetR and TetO (Figure 17-7) (Orth et al. 2000).

## TetO AND TetR ARE USED TO CONTROL EXPRESSION OF GENES TRANSFECTED INTO EUKARYOTIC CELLS

Various forms of TetR and TetO are used to regulate expression of target genes transfected into eukaryotic cells. Because of all the components — repressor, operators, and effectors — are prokaryotic in origin, these systems have few if any significant effects on the expression of resident host genes.



**FIGURE 17-7 Schematic Representation of a Repression System**

In the repression system, the repressor (R) is synthesized under the control of an appropriate promoter (P). When the effector (E), for example, tetracycline or doxycycline, is absent, the repressor binds one or several strategically placed operator sequences (dyad symmetries are indicated by small arrows) within a promoter/enhancer region and interferes with transcription initiation (the TATA box and transcriptional start site [+1] of the promoter are indicated). In the presence of effector, repression is relieved (RE), thereby allowing transcription of the controlled gene (X). Reproduced, with permission, from Gossen et al. 1994 [©Elsevier Science].

### The Tet Repression System

In this system (initially described by Gossen and Bujard 1992), the initiation of transcription of a target gene is controlled by the Tet repressor, which is supplied in *trans*. A recombinant is constructed that contains several tandem copies of the *tetO* elements upstream of the transcriptional start site of the gene of interest and downstream from a minimal promoter. Expression from this promoter can be tightly controlled in eukaryotic cells that express Tet repressor. In the absence of tetracycline, the repressor binds to the *cis*-acting elements and interferes with initiation of transcription by RNA polymerase II (Heins et al. 1992). In the presence of tetracycline, repression is relieved, allowing the gene of interest to be transcribed. Tissue specificity is achieved by selection of an appropriate promoter for expression of the Tet repressor in the target cells.

The Tet repressor system has been used successfully in transgenic plants (Gossen and Bujard 1992; Furth et al. 1994; Wu and Chiang 1996), with the best results being achieved in tobacco (Gatz et al. 1991, 1992; for reviews, please see Gossen et al. 1993, 1994; Gatz 1995). However, efforts to establish a corresponding system in mammalian cells have been only partially successful at best, perhaps because repression of a strong promoter requires a concentration of repressor high enough to saturate the *tetO* elements. Such concentrations of Tet repressor are difficult to sustain in mammalian cells (Gossen et al. 1994).

### The Tet *Trans*-activator System

Expression of genes transfected into eukaryotic cells can be controlled more efficiently by converting TetR to a transcriptional *trans*-activator. Fusing TetR to the carboxy-terminal acidic domain of the herpes simplex type-1 (HSV-1), VP16 protein creates a transcriptional activator (tTA) (Gossen and Bujard 1992; Weinmann et al. 1994; Gossen et al. 1995) that, in the absence of tetracycline, binds to tandemly arranged *tetO* sequences inserted into a minimal promoter and thereby induces transcription of a downstream target gene. However, doxycycline, a water-soluble analog of tetracycline, abolishes the ability of tTA to bind to *tetO* sequences and, in a dose-dependent fashion, destroys the *trans*-activating ability of the chimeric protein and restrains expression of the target gene. After withdrawal of the antibiotic, tTA activates transcription of the target gene. The gene product accumulates at a linear rate for several hours and may increase in concentration by >100,000-fold.

The dynamic range of the Tet system is much lower in transiently transfected cells than in stable cell lines carrying integrated copies of the target gene and its *trans*-activator (e.g., please see Freundlieb et al. 1999). To achieve differences of 1000-fold between the repressed and induced states, it is necessary to create stable cell lines containing integrated copies of the tTA gene and the target gene. This can be done in two ways:

- The target gene of interest is cloned into a “response” plasmid encoding a compound promoter that typically consists of seven tandemly arranged copies of TetO and the minimal immediate early promoter of cytomegalovirus. The gene encoding the *trans*-activating protein tTA is cloned into a separate “regulator” plasmid downstream from a suitable mammalian promoter. The two plasmids are then transfected into the mammalian cell of choice to create “double-stable” cell lines. Transfection is usually carried out in two stages. First, the regulator plasmid is used to generate stable cell lines that express tTA constitutively. These cells are then transfected with the response plasmid and further sublines are selected that express desired quantities of the target gene product only in the absence of tetracycline or doxycycline. In some cases, it is possible to reduce the labor of sequential transfection and screening by using cell lines in which integrated copies of the regulator plasmid have already been installed (e.g., please see Gossen and Bujard 1992; Wu and Chiang 1996). Several cell lines of this type are commercially available from CLONTECH.
- Alternatively, the *trans*-activator gene and the target gene can be cloned into a single plasmid. Because transfection of mammalian cells with both genes is carried out simultaneously, one round of tedious screening is eliminated. In addition, the variation in expression that may occur if the regulator and target genes are integrated at separate chromosomal sites may be lessened (Schultze et al. 1996).

Whether stable cell lines are established with one plasmid or two, full occupancy of the tandemly arranged *tetO* sequences is not required for maximal expression of the target gene. Between 6,000 and 10,000 molecules of tTA per cell are sufficient to increase the level of expression of integrated copies of response plasmids by a factor of  $10^5$ . Larger quantities of tetracycline-dependent *trans*-activators may, in fact, be toxic (e.g., please see Howe et al. 1995; Shockett et al. 1995; Saez et al. 1997).

The CLONTECH Web Site contains a bibliography of several hundred papers ([www.clontech.com/tet/Refs/index.html](http://www.clontech.com/tet/Refs/index.html)) that describe the successful use of the tetracycline activation systems in cultured cells and transgenic organisms. However, success is not guaranteed. The tTA system cannot be stably established in some cell lines, and, in others, the transcription of target genes placed under the control of TetO cannot be regulated by doxycycline (e.g., please see Ackland-Berglund and Leib 1995; Howe et al. 1995; Miller and Rizzino 1995). Integration of the target gene into an actively transcribed region of chromosomal DNA may lead to constitutively high levels of expression in the uninduced state. Ways to avoid these and other problems and to optimize the efficiency of the system are discussed by Gossen and Bujard (1995) and Yin et al. (1996). In addition, please see the panel on TROUBLESHOOTING at the end of this introduction.

## The Tet Reversed Activator System

In the conventional Tet *trans*-activation system, low-to-moderate concentrations of doxycycline are constantly required to suppress transcription of the target gene, and induction after withdrawal of the antibiotic is slow and asynchronous. More efficient induction of expression of the target gene can be obtained with the Tet reversed system, which uses a mutant Tet repressor (rTetR) that differs from the wild-type protein at four amino acids (Gossen et al. 1995). When



fused to the VP16 activation domain, rTetR creates a "reverse" tTA (rtTA) that represses transcription in the absence of an effector, but activates transcription when doxycycline or anhydrotetracycline (Gossen and Bujard 1993) is supplied. Thus, genes placed under the control of rtTA may be kept in a repressed state until the inducer is introduced to the system. The rtTA system, which is available from commercial sources, is ~100 times more sensitive to doxycycline or anhydrotetracycline than to tetracycline.

### The Autoregulatory Tet System

To increase the levels of expression of target genes and to suppress the toxic consequences of constitutive expression of tTA in mammalian cells, Shockett and co-workers (Shockett et al. 1995; Shockett and Schatz 1996) placed tTA under the control of *tetO* elements. Expression of tTA is therefore autoregulated in stably transfected cells and can be controlled by doxycycline. In the presence of the antibiotic, tTA is produced constitutively in small amounts from the minimal cytomegalovirus promoter but is unable to bind to *tetO* sequences upstream of tTA and the target gene. When the antibiotic is withdrawn from the system, tTA binds to both sets of *tetO* sequences and drives expression both of itself and the target gene.

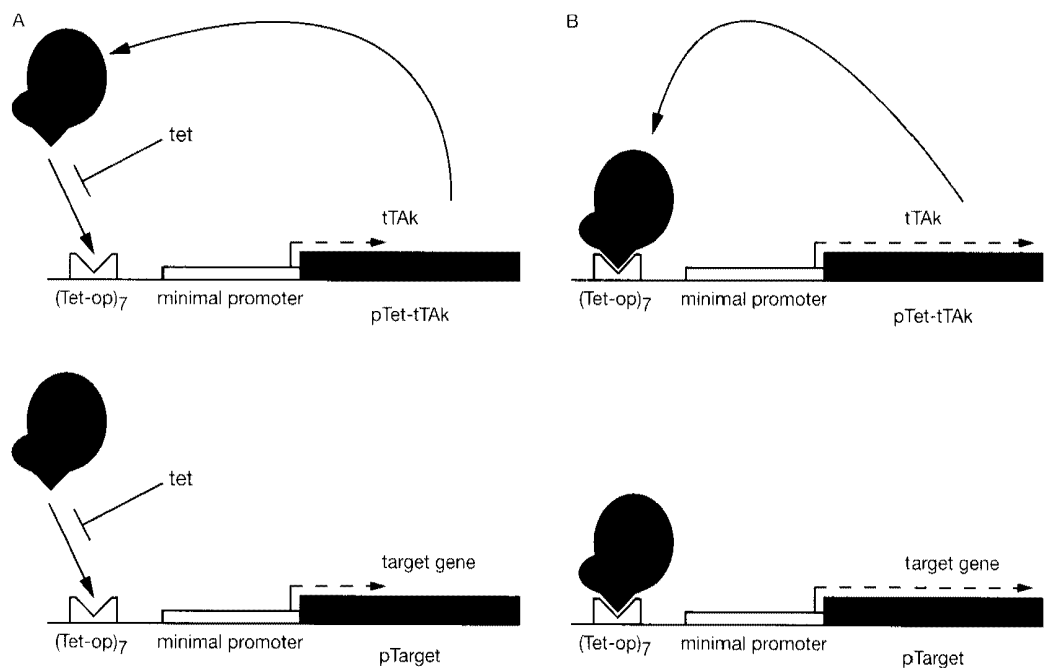
When this system was used in stable lines of transfected 3T3 cells, expression of the recombination activating genes *RAG1* and *RAG2* was substantially higher and the proportion of transformed clones that could be induced was also increased (Shockett et al. 1995). Similarly, in transgenic mice expressing a luciferase reporter gene, the levels of expression were one to two orders of magnitude higher in the autoregulatory system than in the conventional *trans*-activation system.

### Tet Systems with Reduced Basal Activity

High levels of basal transcription of the target gene may result from activation in the absence of bound *trans*-activators, from the inability of tetracycline or doxycycline to squelch *trans*-activation mediated by tTA, and/or from the integration of target genes at transcriptionally active chromosomal sites (Furth et al. 1994; Howe et al. 1995; Kistner et al. 1996). To repress basal transcription, tetracycline-controlled transcription silencers (tTS) have been constructed that suppress the activity of promoters responsive to rtTA. These silencers are chimeric proteins consisting of a modified Tet repressor (TetR) fused to repressor domains of, for example, the mammalian Kox1 or Kid proteins (Deutschle et al. 1995; Forster et al. 1999; Freundlieb et al. 1999). In the absence of doxycycline, homodimers of tTS bind to *tetO* sequences upstream of the target gene and suppress transcription. The silencers dissociate from *tetO* in the presence of doxycycline, allowing homodimers of rtTA to take their place and activate transcription of the target gene.

Success with this approach is possible because the affinity of rtTA for doxycycline is ~100-fold lower than that for tTS or tTA (Gossen et al. 1995). Low concentrations of doxycycline therefore allow tTS but not rtTA to bind to *tetO* sequences. Conversely, high concentrations of doxycycline allow rtTA to bind but prevent binding of tTS. When tTS is expressed in the same cell as rtTA, the *tetO* sites upstream of the target gene are occupied by tTS in the absence of doxycycline and transcription of the target gene is suppressed. In the presence of high concentrations of the antibiotic, the *tetO* sites are occupied by rtTA and the target gene is actively transcribed.

In this system, switching between suppression and activation might be compromised if tTS and rtTA were to form heterodimers that could still bind to *tetO*. This problem can be avoided by equipping tTS and rtTA with noncompatible dimerization domains, derived from different classes of TetR proteins (Rossi et al. 1998; Schnappinger et al. 1998; Baron et al. 1999; Forster et al. 1999).

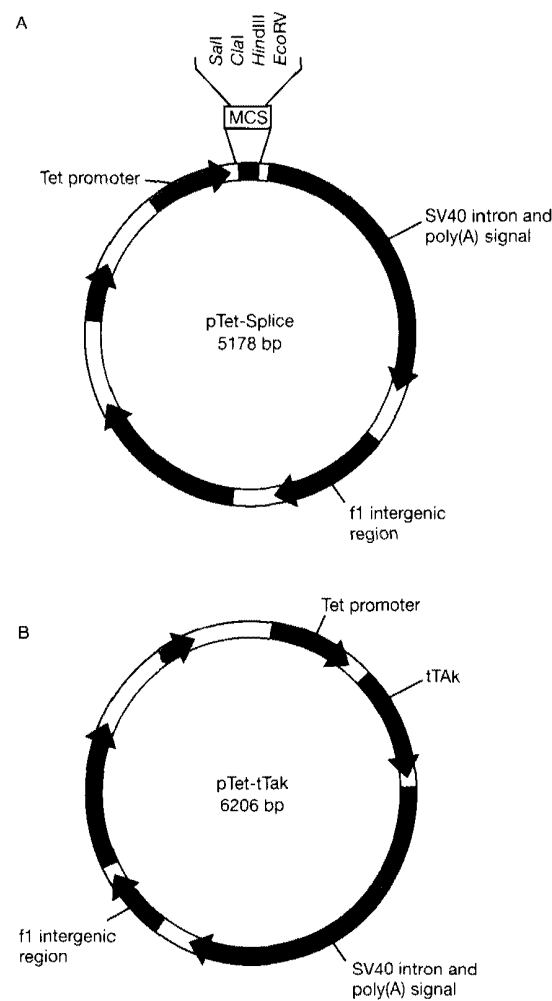


**FIGURE 17-8 Autoregulatory Strategy for Inducible Gene Expression**

Autoregulatory expression of tTA is accomplished in pTet-tTak by placing the tTak gene under the control of *tetP* consisting of seven tandemly arranged copies of the *tet* operator [(Tet-op)<sub>7</sub>] upstream of the minimal hCMV promoter region which contains a TATA box and transcriptional start site. Expression of the target gene is also controlled by *tetP*. The tTA protein is shown as two adjoining ellipses that represent the two domains of the protein (for DNA binding and *trans*-activation). (A) In the presence of tetracycline (Tet), the basal activity of the minimal hCMV promoter results in very low levels of the tTA protein, and any tTA protein produced is blocked from binding to Tet-op. Both target gene and tTA expression are therefore maintained at low levels. (B) When tetracycline is removed, the small amounts of tTA present bind Tet-op, stimulating expression of the tTA gene. Higher levels of the tTA protein now stimulate higher levels of tTA and thus, target gene expression. (Modified, with permission, from Shockett et al. 1995 [©National Academy of Sciences, U.S.A.] )

The following protocol uses an autoregulatory system in which the transcriptional *trans*-activator (tTA) drives its own expression and that of a target gene in cultured cells. As discussed above, tTA is a fusion protein consisting of the tetracycline repressor of *E. coli* and the transcriptional activation domain of the VP16 protein of herpes simplex virus. In the absence of tetracycline, tTA binds to and activates genes preceded by a heptamerized version of the Tet operator sequences (*tetO*) plus a minimal cytomegalovirus promoter (here collectively referred to as TetP). Binding of tTA to TetP and subsequent gene activation are blocked in the presence of tetracycline (Figure 17-8). The plasmid pTet-Splice (Figure 17-9A) contains TetP upstream and SV40 splice and polyadenylation signals downstream from a multiple cloning site into which sequences encoding the open reading frame of a target gene are easily inserted. Autoregulatory tTA expression is driven from the plasmid pTet-tTak (Figure 17-9B), in which the tTA open reading frame (including an optimal sequence for initiation of translation according to Kozak [1984]) has been inserted into pTet-Splice.

The following protocol is divided into three stages: stable transfection of fibroblasts with pTet-tTak, stable transfection of inducible tTA-expressing NIH-3T3 cells, and analysis of the protein expression in transfected cells. Stably transfected cell lines expressing *trans*-activator and tar-



**FIGURE 17-9 Tet-regulated Expression Vectors**

Two plasmids are used to clone the target gene and place it under control of an inducible promoter. The two vectors are cotransfected into mammalian cells, and expression of the target gene is controlled by altering the amount of tetracycline in the culture medium. (A) The target gene is cloned into the multiple cloning site (MCS) of plasmid pTet-Splice. Its expression is controlled by the Tet promoter sequence. Proper processing of the transcript in mammalian cells is facilitated by the presence of the SV40 intron and polyadenylation signal. (B) pTet-tTak contains the gene for the tetracycline *trans*-activator (tTA) under the control of the tetracycline operator (TetO) and the basal cytomegalovirus promoter. (Modified, with permission, from Life Technologies, Inc.)

get gene(s) are derived in two stages. In Stage 1, untransformed cells are cotransfected with pTet-tTak and a plasmid encoding a selectable marker. Stable transformants exhibiting inducible tTA expression are selected. In Stage 2, these clones are cotransfected with plasmids encoding (1) a plasmid containing the target gene downstream from a minimal promoter and tandemly arranged *tetO* sequences target gene(s) and (2) a second selectable marker. In the examples presented here, the vector pSV2His is used to confer the first selectable marker, and pPGKPuro provides the second selectable marker. Other plasmids carrying selectable markers may be used, such as pTet-Splice-Neo, which confers neomycin resistance (Qiu and Stavnezer 1998). Alternatively, pTet-tTak may be cotransfected with the expression plasmid and a plasmid containing a single selectable marker. The choice of approach depends on the feasibility of screening for the products of the target genes. Although the consecutive method is more systematic, the cotransfection

approach may be faster if a straightforward screening method for expression of the target gene is available. Stage 3 describes the analysis of expression in transfected cells as well as an alternative approach for transient transfection.

Stable clones expressing tTA (or tTA + target gene[s] if cotransfecting) may be obtained in ~12–14 days. Generally, an additional 2 weeks are required for expansion and further testing of candidate clones. Selection, expansion, and testing of doubly transformed clones that exhibit inducible expression of the target gene will require another 4–6 weeks of work. Alternatively, stable transformants expressing inducible tTA may be transiently transfected with an appropriate target gene construct. Although induction of expression may be less dramatic, expression of the target genes may be achieved within 48 hours. The following protocol was provided by Penny Shockett and David Schatz (Yale University School of Medicine, New Haven, Connecticut).

#### TROUBLESHOOTING

- The basal activity of the minimal cytomegalovirus promoter varies from one cell line to another and may be affected by DNA sequences in the response plasmid that act as enhancers or other modulators of transcription. Before constructing a double-stable cell line, carry out transient transfection experiments to compare the basal activity of the minimal promoter in one or more target cell lines with the basal activity in a “standard” cell line such as HeLa. Ideally, the basal activity of the response plasmid should be no greater in transfected target cells than in transfected HeLa cells.
- Careful selection of clones expressing tTA is essential as is the subsequent selection of “double-stable” cell lines in which expression of the gene of interest is adequately controlled. To obtain highly regulated gene expression, it may be necessary to select clones of cells where the Tet operator, together with its minimal promoter, is integrated into a transcriptionally “silent” region that nevertheless remains accessible to tTA (Gossen and Bujard 1995). Such integration events cannot be arranged to order but must be identified by trial and error. However, techniques have been described to screen populations of transfected cells for low basal expression and high inducibility using the tetracycline-regulated promoter (Kirchhoff et al. 1995).
- High levels of expression cannot be expected in stable cell lines that express tTA and are then transfected with a plasmid containing *tet* operator sequences and a target gene. The high concentrations of plasmid used for transfection may titrate all of the available tTA, thereby reducing the opportunity for binding of multiple repressors to tandem operator sequences (Gossen and Bujard 1995).
- In many cases, the level of target gene expression can be controlled by varying the concentration of effector. Doxycycline-HCl at a concentration of 1–20 ng/ml in culture medium is generally sufficient to inactivate tTA in most double-stable cell lines.

## STAGE 1: Stable Transfection of Fibroblasts with pTet-tTAk

This stage of the protocol describes a method that can be used either to derive stable cell lines expressing inducible tTA alone or can be used to cotransfect cell lines simultaneously with both pTet-tTAk and the plasmid expressing the tetracycline-regulated target gene(s). In this protocol, the plasmids are introduced into NIH-3T3 cells using calcium-phosphate-mediated stable transfection. These protocols can be adapted for other cell types using the preferred methods of transfection and selection for those cells (for other transfection protocols, please see Chapter 16).

Cell lines that stably express both autoregulatory tTA and target genes have been derived by simultaneous transfection of all of the plasmids. This method may be faster than sequential transfection of the tetracycline-controlled plasmids, but it could require screening more clones than if stable lines with low basal and high induced levels of tTA are first derived, and subsequently transfected with plasmids encoding the target genes. Theoretically, for the derivation of these clones, any combination of selectable markers should work for consecutive cotransfection.

### MATERIALS

---

#### Buffers and Solutions

**Please see Appendix 1 for components of stock solutions, buffers, and reagents. Dilute stock solutions to the appropriate concentrations.**

*CaCl<sub>2</sub> (2 M)*

Sterilize the solution by filtration, and store the filtrate in 5-ml aliquots at -20°C.

*Calf serum (10%)*

*Chloroquine (10 mg/ml)*

Optional, please see Step 7.

Prepare the chloroquine in H<sub>2</sub>O, sterilize the solution by filtration, and store the filtrate at -20°C.

Chloroquine at 10 mg/ml is equivalent to 19 mM. Please see the information panel on **CHLOROQUINE DIPHOSPHATE** in Chapter 16.

*Glycerol (15%) in HEPES-buffered saline*

*HEPES-buffered saline*

*Phosphate-buffered saline*

#### Enzymes and Buffers

*Appropriate restriction endonuclease(s)*

Please see Step 2.

*1x Trypsin-EDTA*

0.05% trypsin

0.5 mM EDTA (pH 8.0)

## Media

### *Dulbecco's modified Eagle's medium complete (DMEM complete)*

DMEM  
 100 units/ml penicillin  
 100 µg/ml streptomycin  
 2 mM glutamine  
 10% bovine calf serum

### *DMEM complete containing 0.5 µg/ml tetracycline-HCl*

Prepare a 10 mg/ml stock of tetracycline-HCl in 70% ethanol and store at -20°C. All DMEM complete media used in this protocol (with or without the selection reagents) that contain 0.5 µg/ml tetracycline-HCl may be stored protected from the light for ~1 month at 4°C.

### *Selection medium containing L-histidinol and 0.5 µg/ml tetracycline*

histidine-free DMEM  
 100 units/ml penicillin  
 100 µg/ml streptomycin  
 2 mM glutamine  
 10% donor bovine calf serum  
 125, 250, or 500 µM L-histidinol (prepare a 125 mM stock and store it at -20°C)  
 0.5 µg/ml tetracycline-HCl (prepare a 10 mg/ml stock in 70% ethanol and store it at -20°C)

Histidine-free DMEM is available from Irvine Scientific, Santa Ana, California. Selection medium that contains 0.5 µg/ml tetracycline-HCl may be stored protected from the light for ~1 month at 4°C.

## Special Equipment

### *Plastic cloning rings*

Autoclave the cloning rings in an upright position in a thin layer of vacuum grease.

### *Polystyrene tubes (4 ml)*

### *Tissue culture dishes (6 cm and 10 cm)*

These protocols can be scaled down to require fewer cells by using smaller dishes or wells and reducing all components proportionately.

## Additional Reagents

Step 23 requires the reagents listed in Chapter 7, Protocol 8, or Appendix 8.

## Vectors and Bacterial Strains

### *pSV2-His*

Purify all plasmids by equilibrium centrifugation in CsCl-ethidium bromide gradients (Chapter 1, Protocol 10) or by column chromatography (Chapter 1, Protocol 9).

For information on pSV2-His, please see Damke et al. (1995). The plasmids pTet-tTAK and pTet-Splice are available from Life Technologies. Other vectors carrying selectable markers are commercially available (e.g., pCI-neo from Promega or pTK-HYG from CLONTECH). If another vector is substituted for pSV2-His, then use the appropriate selection media for the selectable marker carried by that plasmid.

### *pTet-Splice carrying the target gene ORF(s)*

Optional, please see Step 2.

### *pTet-tTAK*

## Cells and Tissues

### *Cultured mammalian cells*

This protocol uses NIH-3T3 cells, but other cells would certainly work. Grow the cells in the appropriate medium.

## METHOD

## Culture and Transfection of Cells

1. Culture adherent cells in DMEM complete. The day before transfection, transfer the cells into DMEM complete containing 0.5 µg/ml tetracycline-HCl (tetracycline). Apply enough cells per 10-cm dish so that on the day of the transfection, the cells will be 33% confluent.

▲ **IMPORTANT** From this point on, maintain cells in the presence of 0.5 µg/ml tetracycline-HCl at 37°C, in an atmosphere of 5% CO<sub>2</sub>, unless otherwise stated.

2. Linearize the plasmids at an appropriate restriction endonuclease site and adjust the DNA concentration of each plasmid to ≥0.5 mg/ml. Mix 10–20 µg of pTet-tTAK plasmid and 1–2 µg of pSV2-His (~10:1 molar ratio of Tet plasmid to the selectable marker plasmid) with 500 µl of HEPES-buffered saline in a clear 4-ml polystyrene tube.

If the target gene is being cotransfected simultaneously, add a pTet-Splice recombinant carrying the target gene in an amount that is equimolar to pTet-tTAK.

Prepare a control for mock transfection containing the HEPES-buffered saline and no DNA. All of the mock-transfected cells should die in histidine-free DMEM containing L-histidinol.

3. Add 32.5 µl of 2 M CaCl<sub>2</sub> to the DNA mixture. Immediately mix the solution by gentle vortexing. Store the solution at room temperature, mixing it from time to time. A cloudy precipitate should form over the course of 15–30 minutes.

For additional details on transfecting cells using CaPO<sub>4</sub>, please see Chapter 16, Protocols 2 and 3.

4. Aspirate all of the medium from the dishes of cells prepared in Step 1.
5. Mix the CaCl<sub>2</sub>-DNA precipitate a few times by pipetting with a Pasteur pipette. Apply the mixture dropwise and distribute it evenly over the cell monolayers.
6. Incubate the cells in an atmosphere of 5% CO<sub>2</sub> for 30 minutes at 37°C, rocking the plate after 15 minutes to ensure even coverage of the DNA precipitate.
7. To each dish of cells, add 10 ml of DMEM complete containing tetracycline. Incubate the cells in an atmosphere of 5% CO<sub>2</sub> for 4–5 hours at 37°C.

If the cells will tolerate it, chloroquine may be added at this time to a final concentration of 25 µM. The optimal incubation time for transfection may vary for different cell types.

8. Gently aspirate the medium from the cells. Avoid disruption of the precipitate that has settled onto the cells.
9. Subject the cells to a glycerol shock by adding 2.5 ml of 15% glycerol in HEPES-buffered saline warmed to 37°C. Store the cells for 2.5 minutes at room temperature. Add the glycerol dropwise to the culture.

It is normal for cells to look somewhat ragged after glycerol shock. The use of chloroquine (Step 7) may further reduce cell integrity, but may improve transfection efficiency.

10. Aspirate the glycerol solution after *exactly* 2.5 minutes. Work quickly, because glycerol can be very toxic to cells.
 

Exposure to the glycerol solution can be increased to 4–5 minutes to optimize the transfection efficiency for certain resilient cell types. As a general rule, cells should be shocked for the longest period of time that allows survival of ~50% of the cells.
11. Immediately, gently, and quickly wash the cells by adding 10 ml of DMEM complete containing tetracycline. Immediately remove the medium by aspiration and repeat the wash.
 

▲ **IMPORTANT** Because the cells tend to detach easily from the plate after glycerol shock, add all of the medium to a single spot on the plate.
12. Add 10 ml of DMEM complete containing tetracycline to the cells, and incubate the cultures overnight at 37°C.
13. Approximately 16–24 hours after transfection, aspirate the medium and replace it with 10 ml of DMEM complete containing tetracycline. Incubate the cultures for a total of 48 hours at 37°C after the transfection (i.e., the sum of the incubation times in Steps 12 and 13).

### Selection and Cloning of Transfected Cells

14. Forty-eight hours after transfection, passage several dilutions of the cells into selection medium containing 125  $\mu$ M L-histidinol and 0.5  $\mu$ g/ml tetracycline-HCl. Cell densities should range from  $\sim 1 \times 10^6$  to  $3 \times 10^4$  cells per 10-cm plate. Include several plates containing  $\sim 1 \times 10^5$  cells.
15. After incubating the cultures in selection medium for 4 days, feed them with a further 3–4 ml of selection medium containing 125  $\mu$ M L-histidinol and 0.5  $\mu$ g/ml tetracycline-HCl.
16. When colonies have formed (typically after  $\sim 10$ –12 days of selection), replace the medium with selection medium containing 250  $\mu$ M L-histidinol and 0.5  $\mu$ g/ml tetracycline-HCl.
 

L-histidinol is normally toxic to cells. The concentration of L-histidinol in the selection medium is therefore raised only after the number of cells expressing pSV2-His at high levels reaches a critical mass.
17. When colonies are well-established (at day 12–15 of selection), delineate their borders by drawing a circle on the bottom of the culture dish around each colony. Aspirate the medium from the plate, and place a sterile plastic cloning ring on the plate to surround an individual clone. Repeat this process for each colony to be picked. Choose cells from plates on which individual colonies are well spaced and can be easily distinguished.
 

▲ **IMPORTANT** After stable transfection with pTet-tTAk, it is imperative that the cells be maintained in medium containing 0.5  $\mu$ g/ml tetracycline to prevent any toxic effects of tTA expression and subsequent selection against clones expressing high levels of tTA.
18. Quickly wash the clones with  $\sim 100$   $\mu$ l of phosphate-buffered saline. To release the cells, add 2 drops of 1x trypsin-EDTA ( $\sim 100$   $\mu$ l) and incubate for 30–60 seconds. Loosen the cells by pipetting up and down with a Pasteur pipette. Transfer each colony to one well of a 24-well tissue culture plate that contains 1 ml of selection medium containing 250  $\mu$ M L-histidinol and tetracycline.
 

Perform all subsequent passaging of cells by using a standard procedure, such as (i) a quick PBS wash, (ii) a 1–3-minute incubation with trypsin-EDTA (2 ml per confluent 10-cm plate) using selection medium containing tetracycline, or (iii) 10% calf serum (3 ml) to dilute/stop the activity of the trypsin.



19. When the cells in the wells have grown to 80% confluency, transfer them into 6-cm tissue culture dishes in selection medium containing 500  $\mu\text{M}$  L-histidinol and tetracycline.  
NIH-3T3 cells become 80% confluent in ~4–7 days; however, the time required to reach 80% confluency varies from cell line to cell line and even from clone to clone.
20. Expand the cells (typically use a 1:5 to 1:10 dilution of the cells) in selection medium containing 500  $\mu\text{M}$  L-histidinol and tetracycline.

### Testing of Cells for Inducible Protein Expression

21. When the cell monolayers are again ~80% confluent, recover a portion of each clone of cells and store them in aliquots in liquid nitrogen. Passage the remainder of the cells until they have expanded sufficiently to allow testing for inducible expression of protein.  
When the frozen cells are later used, they should be revived and grown in histidine-free DMEM containing 500  $\mu\text{M}$  L-histidinol and 0.5  $\mu\text{g/ml}$  tetracycline-HCl.
22. If cells were cotransfected with both tTA and the target plasmids, then directly analyze the products of the target genes, as described in Stage 3. If cells were transfected with only the pTet-tTA plasmid, then prepare the cells to be tested for inducible expression as follows:
  - a. The night before induction, plate the cells in selection medium containing 500  $\mu\text{M}$  L-histidinol and 0.5  $\mu\text{g/ml}$  tetracycline at an appropriate density so that they will be subconfluent at the time of harvest.
  - b. The next day, wash the cells three times with PBS, swirling the plates gently each time.
  - c. After the third wash, immediately add selection medium containing 500  $\mu\text{M}$  L-histidinol, but lacking tetracycline. Culture the cells in the presence or absence of tetracycline for 6–48 hours.

It is essential to include controls that are maintained in selection medium containing 500  $\mu\text{M}$  L-histidinol and 0.5  $\mu\text{g/ml}$  tetracycline.

23. Test the cells for inducible expression of tTA, by northern analysis or immunoblotting. Cell lines expressing tTA may then be transfected with the target plasmid(s) as described in Stage 2.  
In stably transfected NIH-3T3 cells, induced tTA and target gene expression is observed typically after 6 hours of induction and reaches a maximum 6 hours later.

## STAGE 2: Stable Transfection of Inducible tTA-expressing NIH-3T3 Cells with Tetracycline-regulated Target Genes

This procedure describes the transfection with target gene(s) of cell lines already expressing inducible tTA (generated in Stage 1). Selection of pTet-tTA and pSV2-His with L-histidinol is maintained and a plasmid encoding puromycin resistance (or another selectable marker) is cotransfected with plasmid(s) encoding the target gene(s). Cells carrying these plasmids are subsequently selected in both L-histidinol and puromycin.

### MATERIALS

---

#### Buffers and Solutions

Please see Appendix 1 for components of stock solutions, buffers, and reagents. Dilute stock solutions to the appropriate concentrations.

*Calf serum (10%)*  
*HEPES-buffered saline*  
*Phosphate-buffered saline*

#### Enzymes and Buffers

*Appropriate restriction endonuclease(s)*  
*1x Trypsin-EDTA*  
0.05% trypsin  
0.5 mM EDTA (pH 8.0)

#### Media

*Selection medium containing 500  $\mu$ M L-histidinol and 0.5  $\mu$ g/ml tetracycline (with or without 3  $\mu$ g/ml puromycin)*  
histidine-free DMEM  
100 units/ml penicillin  
100  $\mu$ g/ml streptomycin  
2 mM glutamine  
10% bovine calf serum  
500  $\mu$ M L-histidinol (dilute in a 125 mM stock and store it at  $-20^{\circ}\text{C}$ )  
0.5  $\mu$ g/ml tetracycline-HCl (prepare a 10 mg/ml stock in 70% ethanol and store it at  $-20^{\circ}\text{C}$ )  
Histidine-free DMEM is available from Irvine Scientific (Santa Ana, California). Selection medium that contains 0.5  $\mu$ g/ml tetracycline-HCl may be stored protected from the light for  $\sim$ 1 month at  $4^{\circ}\text{C}$ .  
Add puromycin to 3  $\mu$ g/ml when appropriate.

#### Special Equipment

*Plastic cloning rings*  
Autoclave the cloning rings in an upright position in vacuum grease.  
*Polystyrene tube (4 ml)*  
*Tissue culture dishes (6 cm and 10 cm)*  
*Tissue culture plates (24-well)*

## Additional Reagents

*Step 3 of this stage requires the reagents listed in Stage 1 of this protocol.*

## Vectors and Bacterial Strains

*pPGKPuro (or vector carrying another selectable marker)*

Purify all plasmids by equilibrium centrifugation in CsCl-ethidium bromide gradients (Chapter 1, Protocol 10) or by column chromatography (Chapter 1, Protocol 9).

For information on selectable markers, please see Damke et al. (1995). The plasmids pTet-Splice and pUHC13-3 are available from Life Technologies. Other vectors carrying selectable markers are commercially available (e.g., pCI-neo from Promega and pTK-HYG or pPUR from CLONTECH). If another vector is substituted for pPGKPuro, then use the appropriate selection media for the selectable marker carried by that plasmid.

*pTet-Splice carrying a reporter gene, (optional, e.g., pUHC13-3)*

*pTet-Splice carrying the target gene ORF(s)*

## Cells and Tissues

*Stable cell lines that inducibly express autoregulatory tTA (Stage 1)*

## METHOD

---

### Culture and Transfection of Cells

1. Culture stable cell lines that inducibly express autoregulatory tTA (isolated in Stage 1) in complete selection medium containing 500  $\mu\text{M}$  L-histidinol and 0.5  $\mu\text{g/ml}$  tetracycline-HCl. The day before transfection, passage the cells into 10-cm tissue culture dishes containing complete selection medium. Transfer enough cells per dish so that on the day of the transfection, the cell monolayers will be 33% confluent.

▲ **IMPORTANT** From this point on, maintain the cells in the presence of 0.5  $\mu\text{g/ml}$  tetracycline-HCl at 37°C, in an atmosphere of 5%  $\text{CO}_2$  unless otherwise stated.

2. Linearize the plasmids to be used for transfection and adjust the DNA concentration of each to  $\geq 0.5$  mg/ml. Mix 10–20  $\mu\text{g}$  of each target gene plasmid(s) and 1–2  $\mu\text{g}$  of pPGKPuro (a 10:1 molar ratio of each tetracycline plasmid to selectable marker plasmid) with 500  $\mu\text{l}$  of HEPES-buffered saline in a clear 4-ml polystyrene tube.

Prepare a control for mock transfection containing HEPES-buffered saline and no DNA. All of the mock-transfected cells should die when incubated in a medium containing puromycin. Please see the note to Step 4.

3. Carry out Steps 3–13 from Stage 1.

▲ **IMPORTANT** Be sure to substitute the selection medium containing 500  $\mu\text{M}$  L-histidinol and 0.5  $\mu\text{g/ml}$  tetracycline-HCl in this transfection, whenever Stage 1 calls for DMEM complete containing tetracycline.

### Selection and Cloning of Transfected Cells

4. Forty-eight hours after transfection, passage the cells into selection medium containing 500  $\mu\text{M}$  L-histidinol, 3  $\mu\text{g/ml}$  puromycin, and 0.5  $\mu\text{g/ml}$  tetracycline at several dilutions ranging from  $\sim 1 \times 10^6$  to  $3 \times 10^4$  cells per 10-cm plate. Include several plates containing  $\sim 1 \times 10^5$  cells.

The lowest concentration of puromycin that kills all untransfected cells within a few days should be determined empirically before transfection and varies with the cell type. A concentration of

3  $\mu\text{g/ml}$  puromycin is sufficient for selection of transfected NIH-3T3 cells. Most types of cells are killed efficiently in concentrations of puromycin ranging from 0.1  $\mu\text{g/ml}$  to 10  $\mu\text{g/ml}$ .

5. After incubating cultures in selection medium for 4 days, feed them with a further 3–4 ml of selection medium containing 500  $\mu\text{M}$  L-histidinol, 3  $\mu\text{g/ml}$  puromycin, and 0.5  $\mu\text{g/ml}$  tetracycline.
6. When colonies are well-established (at day 12–14 of selection), delineate their borders by drawing a circle on the bottom of the culture dish around each colony. Aspirate the medium from the plate, and place a sterile plastic cloning ring on the plate to surround an individual clone. Repeat the procedure with each colony that is to be picked. Choose cells from plates on which individual colonies are well spaced and can be easily distinguished.
7. Quickly wash the clones with  $\sim 100$   $\mu\text{l}$  of phosphate-buffered saline. To release the cells, add 2 drops of 1 $\times$  trypsin-EDTA ( $\sim 100$   $\mu\text{l}$ ) and incubate for 30–60 seconds. Loosen the cells by pipetting up and down with a Pasteur pipette. Transfer each colony to one well of a 24-well tissue culture plate that contains 1 ml of selection medium containing 500  $\mu\text{M}$  L-histidinol, 3  $\mu\text{g/ml}$  puromycin, and 0.5  $\mu\text{g/ml}$  tetracycline.

Carry out all subsequent passaging of cells by a standard procedure, such as (i) a quick PBS wash, and (ii) a 1–3-minute incubation with trypsin-EDTA (2 ml per confluent 10-cm plate) using 10% calf serum (3 ml) to dilute/stop the activity of the trypsin.
8. When cells in the wells have grown to 80% confluency, transfer them into 6-cm dishes that contain selection medium containing 500  $\mu\text{M}$  L-histidinol, 3  $\mu\text{g/ml}$  puromycin, and 0.5  $\mu\text{g/ml}$  tetracycline.

NIH-3T3 cells become 80% confluent in  $\sim 4$ –7 days; however, the time required to reach 80% confluency varies from cell line to cell line and even from clone to clone.
9. Expand the cells (typically use a 1:5 to 1:10 dilution of the cells) in selection medium containing 500  $\mu\text{M}$  L-histidinol, 3  $\mu\text{g/ml}$  puromycin, and 0.5  $\mu\text{g/ml}$  tetracycline.
10. When cell monolayers are again  $\sim 80\%$  confluent, recover a portion of each clone of the cells and store them in aliquots in liquid nitrogen. Passage the remainder of the cells until they have expanded sufficiently to allow testing for inducible expression of the target gene product(s) as described in Stage 3.

When the frozen cells are later used, they should be revived and grown in selection medium containing 500  $\mu\text{M}$  L-histidinol, 3  $\mu\text{g/ml}$  puromycin, and 0.5  $\mu\text{g/ml}$  tetracycline-HCl.

## STAGE 3: Analysis of Protein Expression in Transfected Cells

Two strategies are presented for analyzing expression of the target protein(s) in transfected cells. In the main protocol, stably transfected cells (obtained in the first two stages of this protocol) are induced for expression of the target gene. After harvesting and lysis of the cells, the lysates are analyzed by SDS-polyacrylamide gel electrophoresis, and target proteins are detected by immunoblotting. An alternative protocol describes the transient transfection and induction of transiently transfected tetracycline-regulated plasmids.

### MATERIALS

---

**CAUTION:** Please see Appendix 12 for appropriate handling of materials marked with <!>.

#### Buffers and Solutions

Please see Appendix 1 for components of stock solutions, buffers, and reagents. Dilute stock solutions to the appropriate concentrations.

*Calf serum (10%)*

*Phosphate-buffered saline*

*1× Protein sample buffer*

#### Antibodies

*Antibodies appropriate for detecting the target proteins of interest by immunoblotting*

#### Gels

*Tris-glycine SDS-polyacrylamide gel <!>*

Cast the gel with a concentration of acrylamide that is appropriate for observing the target protein(s). Please see Appendix 8.

#### Media

*Selection medium containing 500  $\mu$ M L-histidinol and 3  $\mu$ g/ml puromycin (with or without 0.5  $\mu$ g/ml tetracycline)*

*histidine-free DMEM*

*100 units/ml penicillin*

*100  $\mu$ g/ml streptomycin*

*2 mM glutamine*

*10% bovine calf serum*

*500  $\mu$ M L-histidinol (dilute in a 125 mM stock and store it at  $-20^{\circ}$ C)*

*3  $\mu$ g/ml puromycin*

*Histidine-free DMEM is available from Irvine Scientific (Santa Ana, California).*

*Add tetracycline to 0.5  $\mu$ g/ml when appropriate (prepare a 10 mg/ml stock of tetracycline-HCl in 70% ethanol and store at  $-20^{\circ}$ C). Selection medium that contains 0.5  $\mu$ g/ml tetracycline-HCl may be stored protected from the light for  $\sim$ 1 month at  $4^{\circ}$ C.*

#### Special Equipment

*Boiling water bath*

*Polyvinylidene difluoride (PVDF) membrane*

#### Additional Reagents

*Step 13 of this protocol requires reagents and equipment for immunoblotting as listed in Appendix 8.*

#### Cells and Tissues

*Stable cell lines that inducibly express autoregulatory tTA and contain the plasmids harboring the target genes of interest*

## METHOD

### Growth and Induction of Cells

1. The night before induction, plate the cells in selection medium containing 500  $\mu\text{M}$  L-histidinol, 3  $\mu\text{g}/\text{ml}$  puromycin, and 0.5  $\mu\text{g}/\text{ml}$  tetracycline at an appropriate density so that they will be subconfluent at the time of harvest.
2. The next day, wash the cells three times with phosphate-buffered saline, swirling the plates gently each time.
3. After the third wash, immediately add selection medium containing 500  $\mu\text{M}$  L-histidinol, 3  $\mu\text{g}/\text{ml}$  puromycin, but lacking tetracycline. Culture the cells in the presence or absence of tetracycline for 6–48 hours.

In stably transfected NIH-3T3 cells, induced tTA and target gene expression typically is observed by 6 hours and peaks at ~12 hours after induction.

It is essential to include controls that are maintained in selection medium containing 500  $\mu\text{M}$  L-histidinol, 3  $\mu\text{g}/\text{ml}$  puromycin, and 0.5  $\mu\text{g}/\text{ml}$  tetracycline.

### Harvesting of the Cells

4. After the cells have grown for the appropriate length of time, harvest them quickly and place them in a tube in an ice bucket.
 

If the cells are harvested using trypsin, wash the cells with cold phosphate-buffered saline lacking calcium and magnesium salts and stop the trypsin treatment with cold selection medium containing 10% calf serum (with or without tetracycline, as appropriate). Immediately transfer the tubes to an ice bucket.
5. For each clone and control, transfer  $0.5 \times 10^6$  cells to a microfuge tube, and centrifuge all of the tubes at 3000 rpm (low to moderate speed) for 5 minutes at 4°C.
6. Wash the cell pellets by adding 1 ml of ice-cold phosphate-buffered saline. Pellet the cells as in Step 5, and gently aspirate the supernatant without disturbing the cell pellet.
7. Keep the cell pellets on ice and loosen them by gently and quickly running the tubes over the open holes of a microfuge rack before freezing the cell pellets at  $-70^\circ\text{C}$ .

### Preparation of Lysates

8. Resuspend each cell pellet in 30  $\mu\text{l}$  of protein sample buffer by gently pipetting the cells and then vortexing the tubes.
 

This step may also be carried out before freezing the cells.
9. Boil the cells in protein sample buffer for 10 minutes.
10. Recover the cell debris by centrifugation at maximum speed for 2 minutes in a microfuge.
11. Load 10  $\mu\text{l}$  of cell lysate per lane of a Tris-glycine SDS-polyacrylamide gel.
 

If the cell lysates are not loaded immediately onto a gel, they may be stored at  $-20^\circ\text{C}$  or  $-70^\circ\text{C}$ , but should be boiled again before loading them onto a gel.
12. Run the gel for the appropriate length of time (please see Appendix 8).
13. Electrotransfer the proteins from the SDS-polyacrylamide gel to a PVDF membrane, and probe the membrane with the appropriate antibodies (please see Appendix 8).

### ALTERNATIVE PROTOCOL: TETRACYCLINE-REGULATED INDUCTION OF GENE EXPRESSION IN TRANSIENTLY TRANSFECTED CELLS USING THE AUTOREGULATORY tTA SYSTEM

Transient transfection of tetracycline-regulated plasmids is useful in several situations, for example, the initial testing of the autoregulatory system in a given cell line, and screening tTA-expressing cell lines for inducible expression of another Tet plasmid. When testing the autoregulatory tTA system, induction of tTA mRNA is generally a reliable indicator of induced tTA expression. Alternatively, the vector pUHC13-3 (Life Technologies), which encodes luciferase under tetracycline control, may be transiently transfected into cell lines that are capable (or are likely to be capable) of tTA expression (Damke et al. 1995). Transfected cells are then cultured for 12–48 hours in the presence and absence of tetracycline. Luciferase activity in cell lysates can be easily measured (using a kit available from Promega) and is normalized to total protein, determined using a Bradford protein assay, or to a transfection control (Damke et al. 1995).

▲ **IMPORTANT** Be aware that the basal expression of tetracycline-controlled genes carried in transiently transfected plasmids is generally higher than the basal expression of similar genes in stably transformed cells. In addition, the high sensitivity of the luciferase assay may generate misplaced optimism about the efficiency of induced expression of tetracycline-regulated genes. As long as the results are interpreted with caution, transient transfection with plasmids such as pUHC13-3 offers a rapid method to screen many clones in a short period of time.

#### Additional Materials

*Calf serum (10%)*

*Cells appropriate for transfection*

*Medium containing 0.5 µg/ml tetracycline-HCl appropriate for growing the cells to be transfected*

Prepare a 10 mg/ml stock of tetracycline-HCl in 70% ethanol and store it at –20°C. All media used in this protocol (with or without the selection reagents) containing 0.5 µg/ml tetracycline-HCl may be stored protected from the light for ~1 month at 4°C.

*pTet-tTAk*

*pTet-Splice carrying the target gene or pTet-Splice carrying a reporter marker*

The plasmids pTet-tTAk and pTet-Splice are available from Life Technologies.

*Phosphate-buffered saline (PBS)*

*Step 2 of this protocol requires the reagents listed in the appropriate transfection protocol in Chapter 16.*

*Step 8 requires the reagents listed in Chapter 6, Protocol 8; Chapter 7, Protocol 8; or Appendix 8.*

#### Method

1. The night before the transfection, transfer the cells into the appropriate medium containing 0.5 µg/ml tetracycline-HCl.
2. Transfect semiconfluent cultures of cells using pTet-tTAk alone or in combination with a vector carrying the target sequence (pTet-Splice carrying the target gene or pTet-Splice carrying a reporter marker) using the preferred method of transfection for the cells under study (for a selection of transfection protocols, please see Chapter 16).
3. Wash the cells that will be induced three times with *medium lacking tetracycline*.

Wash the cultures of cells that will remain uninduced with medium containing tetracycline.

4. Feed the cells with 10 ml of medium with or without tetracycline, as appropriate. Culture the cells for 12–48 hours.
5. After the cells have grown for the appropriate length of time, harvest them quickly and transfer them to a tube in an ice bucket.  
If the cells are harvested using trypsin, wash them with cold PBS and stop the trypsin treatment with cold medium containing 10% calf serum (with or without tetracycline, as appropriate). Immediately transfer the tubes to an ice bucket.
6. Wash the cell pellets by adding 1 ml of ice-cold PBS. Pellet the cells by centrifuging the tubes at 3000 rpm for 5 minutes at 4°C in a microfuge, and gently aspirate the supernatant without disturbing the cell pellet.
7. Keep the cell pellets on ice and loosen them by gently and quickly running the tubes over the open holes of a microfuge rack before freezing at –70°C or lysing the cells for analysis of inducible protein expression.
8. Analyze tTA or target gene expression (experimental or reporter) by immunoblotting, Southern or northern hybridization, or other appropriate assay.

In cells that stably express tTA, transient target gene expression is generally observed within 12 hours. In cells transiently expressing tTA and a tetracycline-sensitive luciferase reporter (pUHC13-3), luciferase activity has been observed to increase by two orders of magnitude within 20 hours following induction.

# Protocol 9

---

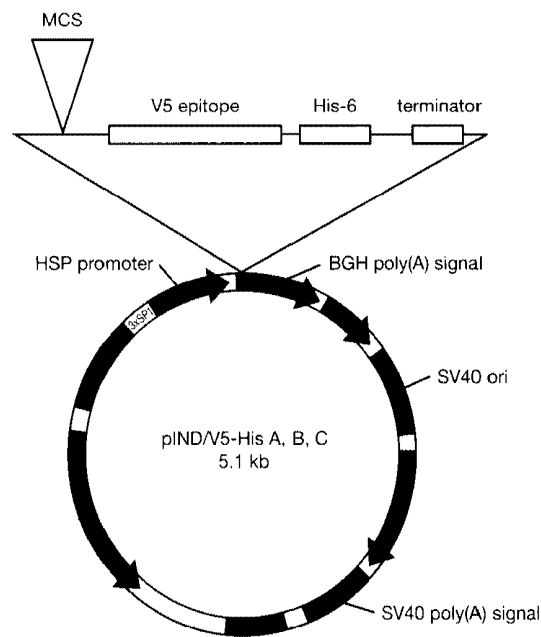
## Ecdysone as Regulator of Inducible Gene Expression in Mammalian Cells

**T**RANSSCRIPTION UNITS REGULATED BY STEROIDS OCCUR COMMONLY in a wide variety of eukaryotes. In *Drosophila melanogaster*, for example, the molting hormone ecdysone is an inducer of metamorphosis. The degeneration of larval tissues and the appearance of adult structures during molting are triggered by the interaction of ecdysone, the nuclear ecdysone receptor, and *cis*-acting response elements (EcRE). The functional ecdysone receptor is a heterodimer composed of the ecdysone receptor (EcR) and the Ultraspiracle protein (USP), another member of the nuclear receptor family (Yao et al. 1992, 1993). In the presence of ecdysone, the two proteins EcR and USP interact and bind to the two inverted half-sites of ecdysone response elements, which are placed upstream of many of the genes involved in *Drosophila* morphogenesis (for further information and references, please see Russell 1996; Thummel 1997; White et al. 1997).

Responsiveness to ecdysone may be reconstituted in mammalian cells that have been cotransfected with EcR and USP. When these cells are exposed to ecdysone or to one of its analogs, such as ponasterone A or muristerone A, transcription of an ecdysone-responsive reporter gene is induced (Christopherson et al. 1992; Yao et al. 1992). The sensitivity of the reconstituted system has been improved by creating a more potent receptor complex, in which (1) USP has been replaced with its mammalian homolog, the retinoid X receptor (RXR), (2) EcR has been truncated at the amino terminus and fused to the VP16 activation domain (Sadowski et al. 1988; Triezenberg et al. 1988a,b; Cress and Triezenberg 1991; No et al. 1996), and (3) the DNA-binding domain within EcR has been mutated at three amino acid residues, altering its binding specificity to mimic that of a glucocorticoid receptor (GR) (Umesono and Evans 1989). In transfected cells able to express both RXR and the modified EcR, the addition of ecdysone or one of its analogs results in the formation of functional heterodimers that bind to a set of hybrid response elements contained within an inducible expression vector (Figure 17-10).

The hybrid response elements consist of two different half sites,  $5'AGGTCA^3$ , which is bound by RXR, and  $5'AGAACA^3$ , which is recognized by the GR-binding domain of EcR. This hybrid response element is uniquely responsive to the hybrid receptor protein (No et al. 1996). Binding of the heterodimer to the response elements stimulates transcription from an adjacent minimal promoter of any gene that has been cloned into the inducible expression vector (Figure 17-11). Because mammalian cells are not normally responsive to ecdysone or its analogs and do not contain the ecdysone receptor, basal levels of transcription are very low or undetectable. Upon addition of the hormone, induction levels of >1000-fold have been reported (for reviews, please see Clackson 1997; Saez et al. 1997; Harvey and Caskey 1998).





**FIGURE 17-10** pIND(SP1)/V5-His A

The vector is used to clone a target gene and place its expression under control of the ecdysone-sensitive response elements. The main features of the vector are the ecdysone/glucocorticoid response elements (E/GRE, 5 copies); SP1 enhancer elements (SP1, 3 copies); heat shock minimal promoter (HSP); poly(A) addition signal from bovine growth hormone (BGH); and tags for convenient purification of the expressed protein (V5 epitope and polyhistidine [His6] tags). Other features include (1) the origin of replication derived from filamentous phage (f1 ori), (2) the colE1 origin of replication in *E. coli*, (3) an ampicillin resistance marker (Amp<sup>R</sup>) for selection in prokaryotic cells, (4) the origin of replication for SV40 that allows replication in mammalian cells, and (5) a neomycin resistance marker for selection in mammalian cells (Neo<sup>R</sup>). (Modified, with permission, from Invitrogen.)

The use of the ecdysone-inducible expression system for the selective production of proteins within transfected mammalian cells was first reported by No et al. (1996) and has since been used successfully to study the functions of numerous proteins, including the roles of Smad4 in colon cells (Calonge and Massagué 1999), the effect of missense mutations in the proapoptotic gene *BAX* (Gil et al. 1999), and the functions of the tumor suppressor PTEN phosphatase (Tamura et al. 1998). In addition, the system has been used to analyze the activity of “designer” zinc finger transcription factors (Kang and Kim 2000) and to develop a mechanism that modulates neuronal excitability by controlling the expression of transduced ion channels (Johns et al. 1999). The following protocol is adapted from the one that accompanies an Ecdysone-inducible Mammalian Expression System (available from Invitrogen). A similar system is available commercially from Stratagene.

## MATERIALS

### Buffers and Solutions

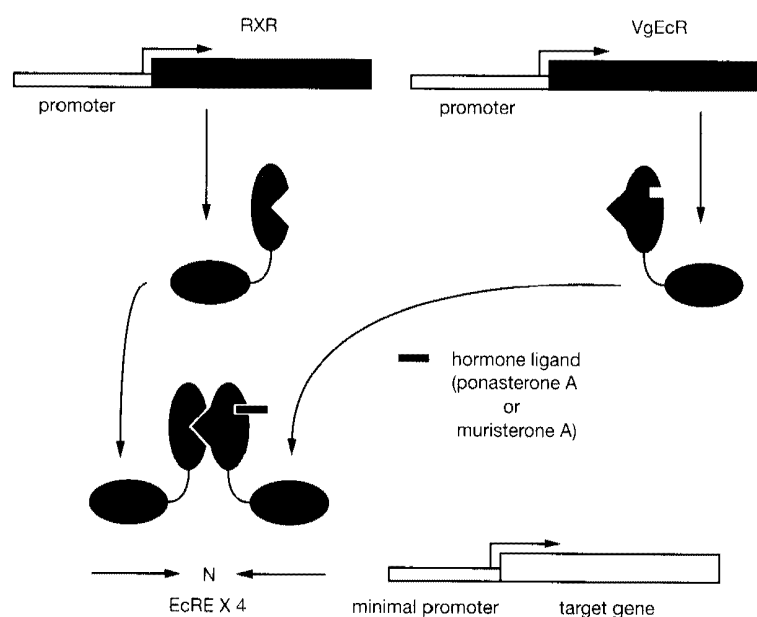
Please see Appendix 1 for components of stock solutions, buffers, and reagents. Dilute stock solutions to the appropriate concentrations.

*Neomycin*

*Ponasterone A*

An alternative ecdysone analog is muristerone A (Sigma).

*Zeocin*



**FIGURE 17-11 Schematic Diagram of Ecdysone-inducible Gene Expression System**

A plasmid encoding the genes for the ecdysone receptor (EcR) and the retinoid X receptor (RXR) is used to express the two receptor proteins. A second plasmid is used to clone the target gene and place it under control of ecdysone-sensitive response element (EcRE) sequences that are positioned upstream of a minimal promoter (please see Figure 17-10). The two vectors are transfected into mammalian cells and expression of the target gene is controlled by addition of inducing hormone in the culture medium. In the presence of hormone (ponasterone A or muristerone A), EcR and RXR heterodimerize to form the functional ecdysone receptor that activates transcription of the target gene from the EcRE-containing promoter. Please see text for further details. (Modified, with permission, from No et al. 1996 [©National Academy of Sciences, U.S.A.] )

## Media

*Medium appropriate for growing the cells to be transfected*

The medium must be variously supplemented with Zeocin, neomycin, and ponasterone A.

## Additional Reagents

*Steps 1, 2, and 6 of this protocol require the reagents listed in the appropriate transfection protocol in Chapter 16.*

*Step 4 of this protocol requires the reagents listed in Protocol 6 of this chapter.*

*Step 8 of this protocol requires the reagents listed in Chapter 6, Protocol 8; Chapter 7, Protocol 8; or Appendix 8.*

## Vectors and Bacterial Strains

*An ecdysone-inducible expression plasmid (e.g., the pIND series; Invitrogen) carrying a luciferase reporter gene*

*An ecdysone-inducible plasmid harboring the gene of interest pVgRXR (Invitrogen)*

## Cells and Tissues

*Cultured mammalian cells*

## METHOD

---

1. Stably transfect cells with pVgRXR using the preferred method of transfection for the cells under study (for a selection of transfection protocols, please see Chapter 16).

If pVgRXR is used, then use Zeocin to select for cells carrying the plasmid. For plasmid(s) other than pVgRXR, use the appropriate antibiotic to obtain colonies of stable integrants.

Perform a control mock transfection with no DNA added to the cells. All of the mock-transfected cells should die in the presence of Zeocin.

2. To choose clones capable of selectively inducing gene expression in the presence of ecdysone or one of its analogs, transiently transfect Zeocin-resistant colonies obtained in Step 1 with an ecdysone-inducible expression plasmid carrying a luciferase reporter gene (again, for a selection of transfection protocols, please see Chapter 16).
3. Twenty-four to ninety-six hours after transfection, induce the expression of luciferase by replacing the medium with fresh medium containing Zeocin, neomycin, and 5  $\mu\text{M}$  ponasterone A. Incubate the cells for 20 hours at 37°C in a humidified incubator with an atmosphere of 5–7%  $\text{CO}_2$ .

The amount of ponasterone A and the length of the induction period that will yield optimal induction of the reporter molecule will vary with different cell lines. To optimize, test a range of hormone concentrations, from 0.1–10  $\mu\text{M}$  ponasterone A, and vary the period of induction from 16 to 72 hours.

It is essential to include control cultures that are not exposed to ponasterone A. Incubate these control cultures in medium containing only Zeocin and neomycin.

4. Assay for luciferase activity according to Protocol 6.
5. Use clones that exhibit the desired level of ecdysone-induced luciferase activity. Expand the cell culture in medium containing Zeocin and neomycin.
6. Stably transfect cells from Step 5 with an ecdysone-inducible plasmid harboring the gene of interest and a hygromycin resistance marker using the preferred method of transfection for the cells under study (for a selection of transfection protocols, please see Chapter 16).

Perform a control mock transfection with no DNA added to the cells. All of the mock-transfected cells should survive in the presence of Zeocin, but die in the presence of the second antibiotic (typically neomycin or hygromycin).

7. Expand the chosen colonies of cells that are resistant to both antibiotics, hygromycin and neomycin.
8. Analyze expression of the target gene by immunoblotting, northern hybridization, or other appropriate assay.

---

## FOOTPRINTING DNA

---

Footprinting is used to identify the region in a segment of cloned DNA that is recognized by a sequence-specific DNA-binding protein such as a transcription factor. The technique involves probing the accessibility of each nucleotide in a defined sequence of DNA to reagents that cleave the phosphodiester backbone. These reagents include enzymes such as DNase I (Galas and Schmitz 1978; Schmitz and Galas 1979) and chemical nucleases such as hydroxyl radicals and copper-phenanthroline ions (for review, please see Sigman and Chen 1990; Sigman et al. 1993).

The key to success with DNA footprinting lies in establishing conditions for cleavage that generate reproducible differences when the same segment of DNA is reacted in the presence and absence of protein. The power of the method lies in the side-by-side visual comparison on sequencing gels of the cleavage products obtained with and without protein.

### Commonly Used Cleavage Reagents

The two types of cleavage reagents used in DNA footprinting attack DNA in quite different ways. Enzymes such as DNase I use an in-line SN-2 mechanism to catalyze nucleophilic attack on the scissile phosphodiester bond. By contrast, chemical agents such as hydroxyl radicals and copper-phenanthroline ions are redox-active coordination complexes that oxidize the deoxyribose moiety of DNA (Sigman et al. 1979; Hertzberg and Dervan 1982).

#### *DNase I*

DNase I was the reagent originally used to develop DNA footprinting (Galas and Schmitz 1978; Schmitz and Galas 1979) and despite the subsequent discovery of elegant chemical methods to cleave DNA in a sequence-independent fashion, it remains by far the most popular way to localize specific interactions between proteins and DNA. It has been known for many years that pancreatic DNase I, in the presence of  $Mg^{2+}$ , introduces nicks into each strand of double-stranded DNA independently. However, whether this nicking occurs at random or displays sequence specificity remains a surprisingly murky topic, with conflicting data from several groups. On the one hand, biochemical analysis of the digestion products of bulk *E. coli* DNA shows only weak sequence specificity (Ehrlich et al. 1973; Bernardi et al. 1975). On the other hand, Scheffler et al. (1968) have shown that DNase I has a very marked preference for cleaving poly[d(A-T)]-poly[d(A-T)] to the 5' side of T residues, a result that was confirmed with homopolymeric poly[d(A-T)] by Lomonosoff et al. (1981). However, this specificity may be due more to an unusual conformation of the DNA associated with the homopolymer, rather than to preference of the enzyme for particular sequences (Klug et al. 1979). Analysis of the crystal structure of complexes between DNase I and short double-stranded oligonucleotides shows that an exposed loop of the enzyme binds in the minor groove of B-DNA with both strands of the nucleic acid bending to make contact with the enzyme (Suck et al. 1984; Suck and Oefner 1986). Because regions of DNA containing several consecutive adenine or thymine residues are comparatively rigid and have a narrow minor groove, Suck et al. (1988) have suggested that A-T tracts in DNA might be relatively resistant to cleavage with DNase I.

In view of this confusion, it is prudent to check that DNase I displays no major bias in its pattern of cleavage of radiolabeled target DNA that has not been incubated with protein. Bias can be ascertained from pilot experiments set up to establish conditions for optimum cleavage of the radiolabeled target DNA by DNase I. The aim here is to cleave each DNA molecule once between the labeled end and the distal terminus of the binding site. The longer the distance between the labeled end and the binding site, the lower the amount of cleavage required. Pilot experiments are usually carried out using a range of concentrations of enzyme to find conditions under which the naked DNA is neither underreacted (much of the original fragment remains uncleaved and the bands forming the ladder are faint) or overreacted (little of the original fragment remains and the smaller fragments are overrepresented in the digest). As a rough guide, an amount of DNase should be used that cleaves only ~50% of the labeled molecules in the reaction. For variations on the protocol, please see Tullius et al. (1987), Hochschild (1991), Garabedian et al. (1993), and Lakin (1993). The goal is to establish conditions where partial cleavage of the relevant segment of naked DNA by DNase I yields a ladder of partial digestion products that differ in size from one another by one base. Ideally, there should be no gaps in the ladder and no dramatic differences in intensity from one band

to the next. In practice, however, it is usually impossible to achieve this level of impartiality, even with naked DNA.

A frequent finding associated with the use of DNase I in footprinting is the appearance of intense bands on the autoradiogram in samples incubated with a DNA-binding protein and the cleavage enzyme. These so-called hypersensitive sites, which reflect enhanced cleavage of the DNA by DNase, may arise as a consequence of conformational changes in double-stranded DNA induced by binding of protein or they may be due to protein-protein interactions between the nuclease and a protein bound to the DNA. The nature of the conformational changes is not well-understood, but it may be related to localized bends, kinks, base flipping (Klimasauskas et al. 1994), or single-stranded bulges (Kimball et al. 1995) in the DNA brought about by binding of protein. The hypersensitive sites typically flank a bona fide footprint.

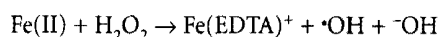
When very short DNAs are used as substrates for DNase I, "end-effects" become apparent (Galas and Schmitz 1978; Lomonosoff et al. 1981). The probability that a particular phosphodiester bond will be cleaved increases as a function of its distance from the 5' end of a DNA strand, at least as far as the eighth phosphodiester bond. It is therefore important to ensure that the footprinted region does not lie very close to the labeled 5' end of the DNA fragment.

Usually, footprinting reactions are analyzed side by side with Maxam-Gilbert reactions on DNA sequencing gels (please see Chapter 12, Protocol 7). If the footprinted DNA fragment is labeled at its 5' end, the autoradiographic bands obtained from the two sets of reactions do not line up because the radiolabeled products carry different groups at their 3' ends. The base-specific chemical reactions cause the removal of a base and its sugar and generate a 3'-phosphorylated terminus on the labeled DNA strand. DNase I cleaves the phosphodiester bond and leaves a 3'-hydroxyl terminus on the labeled DNA strand. The electrophoretic mobility of the chemical cleavage reactions is therefore slightly greater than that of the fragment produced by digestion with DNase I. This problem is more severe when short DNA fragments are examined.

DNA fragments representing eukaryotic promoter sequences often contain multiple binding sites for one or more transcription factors. To define accurately the boundaries of individual footprints, it is best to carry out footprinting assays in which the 5' end of the DNA fragment is radiolabeled in one experiment and the 3' end of the DNA is radiolabeled in a second experiment. By comparing the protected regions of DNA obtained in the two experiments, subtleties in the boundaries can be detected, and a more accurate picture of the binding sites and their relationships to each other can be determined. Use of 3'-labeled fragments also eliminates the problem of electrophoretic migration differences between DNA standards generated by Maxam-Gilbert cleavage and the footprinted DNA, since in this case, all DNAs will have 3'-phosphorylated termini.

### **Hydroxyl Radicals**

Hydroxyl radicals cleave DNA by abstracting a hydrogen atom from a deoxyribose moiety (Hertzberg and Dervan 1982; Price and Tullius 1992). These radicals are usually generated by reacting the EDTA complex of Fe(II) with H<sub>2</sub>O<sub>2</sub> (Fenton 1894):



Fe(II) is regenerated from the Fe(III) product by including ascorbate in the reaction mixture. The hydroxyl radicals, which are diffusible and extremely short-lived, react with deoxyribose residues on the surface of the DNA. Cleavage therefore occurs in a manner that is largely independent of nucleotide sequence (Henner et al. 1982). In addition, because of their smaller size, the hydroxyl radicals can react more efficiently than DNase I with nucleotides on the periphery of the binding site. This access means that the region of tight contact between the protein ligand and its binding site can be defined with higher precision. The efficiency of cleavage of naked DNA can be improved if the Fe(II)-EDTA complex is linked to a DNA-binding ligand, for example, propylmethidium (Hertzberg and Dervan 1982; Tullius et al. 1987). However, in this case, cleavage of the backbone depends on intercalation of the methidium moiety into double-stranded DNA. When intercalation is prevented by binding of a protein, the resulting footprint is larger than that obtained with free Fe(II)-EDTA and is very similar to that produced by digestion with DNase I (Van Dyke and Dervan 1983; Tullius et al. 1987).

### **1,10-Penanthroline-Copper**

The chemistry of this reaction is similar to that of Fe(II)-EDTA, except that the tetrahedral cuprous complex binds in the minor groove of DNA and positions the copper ion close to a deoxyribose residue.

Oxidation of the cuprous ion by hydrogen peroxide then generates a copper-oxo species that efficiently abstracts a hydrogen atom from the deoxyribose (Spassky and Sigman 1985; Sigman and Chen 1990). Unlike Fe(II)-EDTA, 1,10-phenanthroline-copper(I) cleaves naked DNA in a fashion that is greatly influenced by the nucleotide sequence. This effect is presumed to be a consequence of sequence-specific variation in structural features of the minor groove of DNA.

The footprints obtained with the  $\lambda$  repressor with 1,10-phenanthroline-copper(I) are very similar in size to those produced by cleavage with DNase I (Tullius et al. 1987). Apparently, the bound protein can suppress binding of the cuprous complex even on the side of the helix that is not in contact with the protein.

#### **Other Reagents**

Several additional chemical reagents cleave DNA and can be used to study DNA-protein interactions. Examples include rhodium complexes with 1,10-phenanthroline (Chow and Barton 1992), which cleave DNA in a light-dependent fashion and are insensitive to common ingredients in laboratory buffers such as divalent cations, EDTA, glycerol and reducing reagents (Sitlani et al. 1992), porphyrin derivatives (Ward et al. 1986), and uranyl salts such as uranyl acetate and uranyl nitrate (Nielsen et al. 1988; Gaynor et al. 1989). These chemical nucleases must be synthesized in the laboratory, and their use requires more than a passing knowledge of inorganic chemistry. For many of them, it is not yet clear whether they provide additional information over and above that obtained with 1,10-phenanthroline-copper or hydroxyl radicals in footprinting experiments. However, certain rhodium derivatives of 1,10-phenanthroline (Chow et al. 1992) and the uranyl salts (Gaynor et al. 1989) also cleave RNA and can thus be used to define RNA-protein interactions.

### **Selection of a Cleavage Reagent**

The choice among DNA cleavage reagents is largely a matter of personal preference. DNase I is relatively bulky (450 × 400 × 350 nm; Suck et al. 1984) and might be expected to have difficulty in gaining access to nucleotides on the periphery of a binding site that are sterically shielded by a bound protein. This limitation may explain why footprinting with DNase I tends to give larger less-well-defined footprinting patterns, whereas hydroxyl radicals yield smaller focused footprints (Sawadogo and Roeder 1985; Tullius et al. 1987). DNase I maps the outer limits of the area of contact between DNA and protein, whereas hydroxyl radicals define an inner, tight core. Obviously, both pieces of information are valuable, and it is therefore worthwhile to carry out footprinting experiments with two different reagents. DNase I is a safe bet since it has gained wide acceptance and has been used successfully by large numbers of laboratories. However, chemical reagents, such as 1,10-phenanthroline-copper(I), are a better choice if cleavage (1) cannot be detected between every base pair when naked DNA containing the region of interest is partially degraded by DNase I (Galas and Schmitz 1978) and (2) if the target region is known or suspected of containing long runs of adenine or thymine residues.

Both DNase I (Papavassiliou 1993) and 1,10-phenanthroline-copper(I) (Kuwabara and Sigman 1987) can be used to cleave the DNA moiety of protein-DNA complexes within the matrix of a separating gel. This use allows footprinting to be coupled directly with a gel retardation assay. By contrast, hydroxyl radicals, which are preferred when accurate definition is required of the region of contact between the protein and DNA, are always used on protein-DNA complexes in free solution. DNase I can also be used to digest protein-DNA complexes in solution, followed by gel electrophoresis to separate protein-DNA complexes from free DNA. The DNA can then be extracted from the complexes, denatured, and analyzed on sequencing gels.

### **In Vivo DNA Footprinting**

The 5'-flanking regions of many eukaryotic genes contain dozens of binding sites for different transcription factors. Although it is relatively straightforward to document the ability of proteins to bind to these sites using DNA footprinting assays and the cleavage reagents discussed above, it is far more difficult to determine which binding sites are used in vivo and which are a consequence of the use of high concentrations of naked DNA and binding sites in vitro. These questions may be answered by performing in vivo footprinting experiments in which the ability of proteins to bind to the regulatory regions of the target gene is determined in an expressing cell. The earliest experiments of this nature were carried out by George Church and Walter Gilbert, who used chemical cleavage reagents to examine methylation patterns in the 5'-flanking regions of murine immunoglobulin heavy-chain genes (Church and Gilbert 1984). To

detect the very weak signals emanating from the single-copy target gene and their differential methylation required heroic measures that involved the generation of very high specific activity probes, separation of cleaved genomic DNA by electrophoresis through sequencing gels, followed by electrophoretic transfer of the DNA to nylon filters, and Southern analysis to detect methylation-sensitive variations in the cleavage products derived from the immunoglobulin genes.

Few laboratories could match the technical wizardry required to perform these reactions and their application to *in vivo* footprinting. The method might have suffered an ignoble death of neglect had not Barbara Wold and colleagues used PCR specifically to amplify *in-vivo*-footprinted DNA fragments (Mueller and Wold 1989; Pfeifer et al. 1989). In this adaptation, which they called ligation-mediated PCR, the genomic DNA of living cells is first challenged with a DNA cleavage reagent such as dimethylsulfate, and the fragmented DNA is purified by extraction with phenol:chloroform and ethanol precipitation. A round of primer extension on the treated DNA defines the cleavage endpoints and produces blunt-ended fragments to which linkers of a defined sequence are added by ligation. A PCR is next carried out using a primer that is complementary to the added linker sequence and a second primer that lies downstream from the suspected DNA footprint. In the absence of protein binding, a ladder of products is amplified that can be visualized after separation by gel electrophoresis. Each DNA fragment in the ladder represents a distinct cleavage point along the target gene. However, if a protein was bound to a site that lies between the two amplification primers, DNA fragments whose endpoints are within the binding site will be underrepresented due to protection of the DNA from the cleavage reagent. These will have a reduced intensity on the gel when compared to DNAs generated in the absence of protein binding.

Detailed protocols for ligation-mediated PCR are now available (Zaret 1997), and in general, these methods are quite reproducible in most molecular biology laboratories. The method has been used to demonstrate the *in vivo* binding of tissue-specific transcription factors (Mueller and Wold 1989), to map methylation sites in inactive genes (Pfeifer et al. 1989), and in combination with other enzymatic, chemical cleavage, and cross-linking reagents to define protein-DNA interactions and the presence of unusual DNA conformations in transcribed genes (Zaret 1997). By varying the conditions in which the cells of interest are cultured, or the times at which cells are harvested from an organism, it is possible to paint a detailed picture of the footprints left by the dynamic associations of various transcription factors with the regulatory regions of a target gene.

---

## GEL RETARDATION ASSAYS

---

Electrophoresis of protein-DNA complexes through nondenaturing acrylamide or agarose gels is the simplest and most widely used of several physical assays to detect specific interactions between DNA-binding proteins and their target sequences. The gel retardation assay typically involves the addition of protein to defined end-labeled fragments of double-stranded DNA, separation of protein-DNA complexes from naked DNA by electrophoresis, and visualization of the DNA by autoradiography. Binding of protein almost always reduces the electrophoretic mobility of the target DNA, resulting in discrete bands that correspond to individual protein-DNA complexes.

Gel retardation was introduced by Dahlberg et al. (1969) and Shaup et al. (1970) as a technique to assay interactions between ribosomal proteins and ribosomal RNA. The method in common use today, however, is a direct descendant of studies in the early 1980s of the equilibria and kinetics of association of purified prokaryotic regulatory proteins with their target DNA sequences (Fried and Crothers 1981, 1983, 1984a,b; Garner and Revzin 1981; Hendrickson 1985; Hendrickson and Schleif 1985). Certainly, at that time, it was not recognized that the technique could be used to detect sequence-specific DNA-binding proteins in complex mixtures, such as crude lysates of mammalian cells. This advance came only after unlabeled carrier DNA (see below) was shown to suppress nonspecific binding of proteins to the radiolabeled target DNA (Strauss and Varshavsky 1984; Carthew et al. 1985; Singh et al. 1986). Since then, the technique has been extended to analyze complexes formed between proteins and unusual conformations of DNA, including Holliday junctions (Parsons et al. 1990; Dunderdale et al. 1991), mismatched base pairs (Jiricny et al. 1988), and Z-DNA (Nordheim and Meese 1988; for review, please see Lane et al. 1992). However, the chief use of

the assay remains by far the detection and analysis of complexes formed between *trans*-acting proteins and *cis*-acting DNA sequences that control gene expression in both eukaryotes and prokaryotes. Among the advantages of the gel retardation assay for these purposes are the following.

- **Speed, high sensitivity, and discrimination.** Femtomole quantities of sequence-specific binding proteins can be detected by their effect on the mobility of a radiolabeled target DNA even when other DNA-binding proteins are present, as, for example, in a crude cell extract. The gel retardation assay can be completed within a few hours and is therefore ideal for monitoring the purification of *trans*-acting transcription factors and other sequence-specific binding proteins.
- **Target sequences for a particular DNA-binding protein can be identified in a mixed population of DNA fragments.**
- **Complexes between DNA-binding proteins and their target sequences can often be resolved** into several components that reflect alternative stoichiometries, interactions between several different proteins, or multiple proteins competing for the same site.
- **The method can easily be adapted for quantitative determination** of association rate constants, dissociation rate constants, cooperativity, abundance, and specificity.

Many of these points are discussed in greater detail below.

### Mechanism of Gel Retardation

That protein-DNA complexes migrate as discrete bands in gels was unanticipated since the half-life of many complexes is manyfold shorter than the time required to run a gel. Two theories have been proposed to explain why protein-DNA complexes are kinetically more stable in gels than in free solution. The first theory suggests that the gel directly affects the dissociation constant of protein-DNA complexes. Although this idea was supported by early experimental data (Fried and Crothers 1981), subsequent analyses have failed to confirm gel-mediated stabilization of protein-DNA complexes. Instead, it seems that the gel acts as a dehydrated cage that prevents diffusion of dissociated components. This caging effect maintains high local concentrations of the components and effectively drives the equilibrium of the bimolecular reassociation reaction to the right. A robust theoretical underpinning for this argument has been provided by Cann (1989) whose calculations show that the optimal range of concentrations of DNA in standard gel retardation assays is  $1 \times 10^{-8}$  to  $5 \times 10^{-8}$  M over a range of binding constants from  $10^9$  to  $10^{13}$  M<sup>-1</sup>, with the optimal ratio of binding protein to DNA varying from 0.5 for strong interactions to 10 or more for weak interactions.

### Measuring Dissociation Constants of Protein-DNA Complexes by Gel Retardation

To measure the value of  $K_d$ , the dissociation constant for a protein-DNA complex, a series of binding reactions are set up using a wide range (four to six orders of magnitude) of protein concentrations. The aim is to find the concentration required to bind half of the DNA. The data are generally plotted as a fraction of the free DNA (usually estimated from densitometry of gel bands) versus  $\log_{10}$  concentration of protein in the binding reaction. The equilibrium constant can then be estimated from the resulting sigmoid curve provided (1) the ratio of protein to available binding sites at the midpoint of the reaction ( $= K_d$ ) is  $>10$  (Carey 1988, 1991), (2) virtually all of the DNA in the reaction can be driven into complex by a vast excess of protein, and (3) the experimental data fit a theoretical binding curve calculated from an equation describing binding between independent and equivalent sites. For noncooperative interactions, an increase of 1.81  $\log_{10}$  units in protein concentration is required to increase the fraction of DNA appearing in complex from 10% to 90%. Deviation from this value indicates that binding is cooperative or is occurring at multiple sites. Values  $<1.8 \log_{10}$  units indicate positive cooperativity during the binding reaction: Values  $>1.8 \log_{10}$  units indicate negative cooperativity (Carey 1991).

### Mobility of Protein-DNA Complexes

Three major factors affect the rate of migration of protein-DNA complexes through gels. These are the mass of the protein-DNA complexes, their overall charge, and the conformation of the DNA within them. As a general rule, the mobility of the complex is related to the size of the free protein (Carey 1988). Thus, the mobilities of the retarded bands typically decrease as a monotonic function of protein mass (e.g., please see



Hope and Struhl 1985; Bétermier et al. 1989). If, however, the bound protein is highly acidic and carries a strong negative charge, the mobility of the complex may not be appreciably different from that of naked DNA. This problem can be solved by carrying out electrophoresis at low pH (Carey 1988).

A more radical deviation in mobility occurs when binding of protein induces bending of the DNA fragment. The mobility of the "bent" complex is then lower (sometimes by a considerable amount) than might be predicted simply from the mass of the bound protein. The greater the angle of induced bend, the greater the reduction in mobility (Koo and Crothers 1988). Furthermore, the closer the location of the bend to the middle of the molecule, the slower its migration. This position effect has been used to map the location of protein-induced bends in DNAs (e.g., please see Wu and Crothers 1984; Kim et al. 1989). In general, conformation-induced effects are (1) magnified when DNA complexes are analyzed by electrophoresis at low temperatures in the presence of  $Mg^{2+}$  (Diekmann 1987) and in gels with small pore sizes (Marini et al. 1983) and (2) reduced in the presence of DNA-binding ligands such as distamycin (Wu and Crothers 1984).

## Practical Matters

In addition to the theoretical matters discussed above, the practical advice that follows may be useful to the first-time user of gel retardation assays.

- **Gel matrices.** 5% polyacrylamide gels are used to analyze complexes formed with DNA fragments >200 nucleotides in length; 10% polyacrylamide gels are generally used for shorter DNAs. Agarose gels are not used unless the mass of the binding protein(s) or the DNA is very large (>1 kb). Because of their large pore sizes, agarose gels cannot detect protein-induced bending of DNAs.
- **Electrophoresis buffers.** Most protein-DNA complexes are stable and carry a slight negative charge at neutral pH, and thus 0.5x TBE is the standard buffer of choice. However, in the small minority of cases where the protein component of the complex carries a strong negative or positive charge, it may be necessary to use acid (e.g., TAE at pH 6.0) or alkaline buffers (e.g., 50 mM Tris-glycine at pH 9.2).
- **Addition of carrier DNAs.** Unlabeled carrier DNA is generally added to the binding mixture to eliminate nonspecific binding of proteins present in cell extracts to the radiolabeled target DNA. The aim is to add just sufficient carrier to absorb all of the proteins that bind nonspecifically to DNA without affecting the kinetics of formation or the stability of specific complexes involving the target DNA. The amount of carrier required in a particular circumstance must be determined empirically, but this task is rarely onerous because the range of acceptable carrier concentrations is usually quite broad. If too much carrier is used, none of the target DNA will form complexes; if too little carrier is used, all of the probe will bind nonspecifically to proteins in the extract and will thereby be prevented from entering the gel.

*E. coli* DNA was the first carrier DNA to be used as a nonspecific competitor in gel retardation assays (Strauss and Varshavsky 1984), and this was followed by eukaryotic chromosomal DNAs of high complexity (e.g., calf thymus and human DNA). However, the possibility that these DNAs might contain specific binding sites for the proteins under study quickly led to their replacement by synthetic alternating copolymers such as poly(dA-dT)·poly(dA-dT) or poly(dI-dC)·poly(dI-dC) or by the polysulfated carbohydrate heparin (Carthew et al. 1985; Singh et al. 1986).

- **Cofactors.** Certain transcription factors, particularly those of prokaryotic origin, require the presence of a specific cofactor for optimum binding. The CAP protein, for example, depends on cAMP for binding (Fried and Crothers 1983), whereas the tryptophan repressor TrpR requires tryptophan for efficient binding (Carey 1988).
- **Extracts.** Mammalian DNA-binding proteins are usually detectable in concentrated lysates of whole cells or in extracts of nuclear preparations. The methods to prepare these extracts have long since been optimized (e.g., please see Dignam et al. 1983; Chodosh et al. 1986; Kadonaga and Tjian 1986; Singh et al. 1986) and there is little point in trying anything new and fancy, at least during the initial phases of characterization of a new DNA-binding protein.
- **Size of bound proteins.** The size of a protein in a protein-DNA complex can be measured by cross-linking with UV irradiation and then resolving the complexes by SDS-polyacrylamide gel electrophoresis. In many cases, the presence of a previously characterized DNA-binding protein can be confirmed by immunological analysis. An antibody that binds specifically to a particular DNA-binding protein can either prevent formation of a specific protein-DNA complex or further retard ("supershift") the electrophoretic mobility of the complex (Kristie and Roizman 1986).

## BACULOVIRUSES AND BACULOVIRUS EXPRESSION SYSTEMS

Baculoviruses cause a "melting" disease of lepidopteran larvae (e.g., silkworms) that has been studied by microbiologists since the nineteenth century. In the 1940s, Dr. G. Bergold discovered that many rod-shaped virus particles ("baculo" means rod) were embedded within the polyhedral crystals (~2  $\mu\text{m}$  in diameter) known to be the disease agent of melting disease (Bergold 1947). Furthermore, these rod-shaped virus particles could be released from the polyhedra by treatment with alkaline solutions such as those found in the midgut of the insect host.

Research during the 1950s and 1960s was aimed at understanding viral pathogenesis, primarily by electron microscopic analysis (Harrap and Robertson 1968; Tanada and Leutenegger 1968, 1970; Harrap 1970; Summers 1971; Stoltz and Summers 1972). Our current view of how baculoviruses cause disease emerged from these studies. The crystals studied by Bergold are the occluded form of a subset of baculoviruses known as nuclear polyhedrosis viruses (NPVs). The crystals (also known as polyhedral inclusion bodies or PIBs) are ingested by the insect and solubilized in the insect midgut, the primary site of infection. The midgut cells and other cells within the insect produce PIBs as well as a second form of the virus, the budded virus (BV) that is responsible for systemic infection of the host and is the infectious form in cell culture. By the late 1960s and early 1970s, insect cell lines were established that could support budded virus replication as well as the production of occluded virus (Grace 1962; Goodwin et al. 1970; Hink 1970, 1972).

In 1975, the first baculovirus was registered as a pesticide for use on cotton by the Environmental Protection Agency in the United States (Ignoffo 1973, 1981). For several years, the cotton bollworm virus was commercially marketed as a substitute for the increasingly ineffectual organophosphate pesticides. But, in the late 1970s, the pyrethroid-based chemicals were registered and marketed, eliminating the market for the more expensive virus pesticides. During the 1980s, the U.S. Forest Service developed other baculovirus pesticides, including NPVs of the gypsy moth and the tussock moth, which are still used today for pest control in public forests (Martignoni 1984). Industrial interest, however, faded until the advent of technology to genetically improve baculoviruses as pesticides (McCutchen et al. 1991; O'Reilly and Miller 1991; Stewart et al. 1991; Tomalski and Miller 1991, 1992), coupled with increased resistance of pests to pyrethroids.

The registration of baculoviruses as pesticides had positive effect on both baculovirus research and biotechnology. The application of these viruses on millions of acres of agricultural and forest land highlighted the need to know more about how these viruses caused disease and the nature of their host-range limitation (Summers et al. 1975). Increased research led to a more sophisticated understanding of the viruses and eventually to the development of baculoviruses as expression vectors.

Baculoviruses constitute an immense family of viruses, the Baculoviridae, which includes >500 known members ubiquitously distributed in terrestrial and marine ecosystems (Martignoni and Iwai 1986). Each baculovirus infects a limited number of arthropod species and some cause lethal epizootics. Those viruses causing diseases of pest species (e.g., Armyworms) or beneficial insects (e.g., silkworms or shrimp) have received more attention because of their potential use as pesticides or their potential to cause devastating diseases of commercially valuable arthropods.

The baculovirus most commonly used as a gene expression vector, *Autographa californica* nuclear polyhedrosis (AcNPV or AcMNPV), for example, also has considerable potential as an insect pest control agent against certain agricultural pest moth species (e.g., the cabbage looper *Trichoplusia ni* and the fall armyworm *Spodoptera frugiperda*). AcMNPV was isolated from alfalfa loopers (*A. californica*) in the early 1970s (Vail et al. 1971). Because it had potential as a pesticide and could be readily propagated in several established cell lines, it was adopted for molecular genetic analysis (Lee and Miller 1978, 1979; Smith and Summers 1978, 1979; Brown et al. 1979; Carstens et al. 1979; Miller and Dawes 1979; Miller 1981). The *Bombyx mori* nuclear polyhedrosis virus (BmNPV) is also used as a gene expression vector (Maeda 1989), primarily for expression in insect larvae because of the large size of the silkworm larvae.

Baculoviruses have large (~80–200 kbp) circular DNA genomes (Summers and Anderson 1972, 1973), several of which (including AcMNPV 133,894 bp; Ayres et al. 1994) have been completely sequenced. The AcMNPV genome contains at least 154 open reading frames, most of which have been assigned at least a rudimentary function.

Approximately 20 genes appear to encode viral structural proteins (Rohrmann 1992; Kool and Vlak 1993), whereas a similar number have been assigned roles in gene regulation (Todd et al. 1994). A number

of genes appear to have been acquired from the host at some point in evolution; for example, baculovirus genes encoding proteins with significant sequence identity to host proteins include superoxide dismutase, ubiquitin, protein kinases, protein phosphatase, proliferating cell nuclear antigen,  $\omega$ -conotoxin-like protein, and chitinase (Kool and Vlak 1993; Ayres et al. 1994). The virus interacts extensively with cellular processes and actively blocks apoptosis (Clem et al. 1991; Clem and Miller 1993; Crook et al. 1993; Birnbaum et al. 1994), an antiviral defense mechanism (Clem and Miller 1993). The virus controls its host at the organismal level as well as at the molecular and cellular levels. For example, the virus contains a gene encoding a UDP-glucose transferase that acts specifically on ecdysone, the major molting hormone of insects, thus allowing the virus to block molting and pupation of its host (O'Reilly and Miller 1989).

Regulation of baculovirus gene expression appears thus far to be controlled primarily at the level of transcription. AcMNPV genes are transcribed in three basic phases: early, late, and very late phases. Early phase genes appear to be transcribed by host RNA polymerase II (Gruha et al. 1981; Huh and Weaver 1990a,b; Hoopes and Rohrmann 1991; Glocker et al. 1993), but early gene transcription is additionally modulated by the products of at least three early viral genes, *ie-1*, *ie-2*, and *pe-38* (Guarino and Summers 1986; Carson et al. 1988; Kovacs et al. 1991; Lu and Carstens 1993). Transcription of the late and very late genes involves a virus-induced  $\alpha$ -amanitin-resistant RNA polymerase (Gruha et al. 1981; Huh and Weaver 1990a,b; Yang et al. 1991). The latter appears to be encoded at least in part by the virus (Passarelli et al. 1994).

Late and very late gene transcription is dependent on DNA replication (Gordon and Carstens 1984; Rice and Miller 1986; Lu and Carstens 1991; Lu and Miller 1994). Although the viral DNA replication origins have not been defined, eight regions known as "homologous regions" (hrs) are dispersed in the viral genome and appear to act as origins of DNA replication for plasmids in transient expression assays (Pearson et al. 1992; Kool et al. 1993a,b); the homologous regions also have enhancer-like function for early gene expression (Guarino and Summers 1986). Origin-specific plasmid DNA replication can be *trans*-activated by the addition of ten viral genes, including the three genes involved in early gene regulation (Kool et al. 1994; Lu and Miller 1994).

Optimal expression from a late reporter gene in transient expression assays requires these ten genes and eight additional genes, all of which influence the steady-state levels of reporter gene expression (Lu and Miller 1994; Todd et al. 1994). Two of these genes encode proteins with motifs conserved in the largest and second largest subunits of eukaryotic and prokaryotic RNA polymerases, suggesting a direct role in transcription (Lu and Miller 1994; Passarelli et al. 1994). Only one factor specifically affecting very large late gene expression has been identified thus far, and this factor is related by sequence motifs to the  $\lambda$  integrase family (McLachlin and Miller 1994).

Although the early viral promoters are largely reminiscent of RNA polymerase II promoters, late and very late promoters of baculoviruses are unusual and appear to lack "upstream-activating" sequences (for review, please see O'Reilly et al. 1992). Both late and very late promoters contain an essential sequence, TAAG, at the transcriptional start site. This sequence is probably sufficient to serve as a "late promoter" for the new RNA polymerase, although the context of the TAAG sequence, especially the 5 or 6 bp immediately upstream and downstream from the TAAG, influences the expression level (Morris and Miller 1994). For the very late polyhedrin promoter, the 50 bp between the TAAG and the translational start codon of the polyhedrin open reading frame are required for the massive transcriptional activation observed during the very late phase of infection (Ooi et al. 1989). These 50 bp including the TAAG sequence are sufficient, in the context of the viral genome, to drive high levels of polyhedrin or heterologous gene expression during the very late phase of infection. Mutations within this 50-bp region influence steady-state levels of mRNA by affecting transcriptional initiation rather than mRNA turnover rates (Ooi et al. 1989). The choice of promoters used for heterologous gene expression is thus a crucial determinant of when and how much gene expression occurs. However, the context of the translational initiation codon and additional 5' leader and 3' trailer can also exert some effect.

Since polyhedrin promoter-driven expression initiates ~20 hours after infection and cell lysis does not occur until 72–94 hours postinfection, the very late phase encompasses ~30–50 hours of intense gene expression. Very high levels of polyhedrin mRNA are produced during this time, and polyhedrin constitutes ~25% of the total protein of the infected cell by the time of lysis. Similar levels of expression have been observed for several stable proteins encoded by foreign genes placed under the control of the polyhedrin promoter in baculovirus vectors. Usually, however, foreign proteins are expressed at a somewhat lower level, typically between 1% and 10% of total cellular protein.

## Baculovirus Vectors

Until recently, recombinant baculoviruses were produced by cotransfecting stable lines of cultured insect cells with linearized baculovirus DNA and a transfer plasmid carrying the foreign gene behind a strong viral promoter (usually the polyhedrin promoter). Once inside the cell, homologous recombination between the plasmid and the viral genome generated a recombinant that carries the foreign gene in place of the endogenous polyhedrin gene (Smith et al. 1983; Maeda et al. 1984; Pennock et al. 1984; for more complete descriptions of the method, please see King and Possee 1992; O'Reilly et al. 1992; Luckow 1993; Miller 1993).

The linearized baculovirus DNA used for transfection is obtained by digesting the genome of an AcMNPV vector with restriction enzymes that remove a reporter gene (*lacZ* or GFP) and part of an essential baculovirus gene. The resulting linear DNA is noninfectious and cannot generate viable progeny viruses unless it recombines with the transfer plasmid (Kitts et al. 1990; Kitts and Possee 1993). The recombinant viruses can be recognized because they generate plaques in monolayers of insect cells that are either colorless (*lacZ*) or nonfluorescent (GFP).

Many different transfer plasmids have been developed for a variety of applications. For example, plasmid vectors are available for expression of proteins as fusions to glutathione S-transferase (GST) or as His-6-tagged fusions. Other plasmids allow for the simultaneous expression of two or more (up to four so far) different genes. A variety of promoters that drive expression at different stages in the virus infection process have also been developed; promoters that drive expression earlier than the polyhedrin promoter are often not as strong but provide for a longer period of expression, while the cell is more capable of posttranslationally modifying the gene product.

More recently, methods have been developed to ligate foreign genes directly into baculovirus vectors. Ernst et al. (1994) created a baculovirus that could be linearized at a unique *SceI* site and could be used to propagate and express foreign genes equipped with *SceI* termini. The usefulness of this method was greatly increased when Lu and Miller (1996) developed a more versatile vector system that could accept DNAs with *EcoRI* termini. As a consequence of these advances, baculovirus expression systems have assembled a tremendous record of success: More than 800 different gene products have been expressed to levels that are sufficient for biochemical and structural analyses of the purified proteins. Whereas baculovirus vectors were once used when all else failed, they are now often the first systems to be tried for expression of a newly isolated eukaryotic gene.

## Drawbacks of Baculovirus Expression Systems

The major advantage of baculovirus vectors is their capacity to produce very high levels of biologically active proteins. An additional benefit accrues if the foreign protein is equipped with a signal sequence. In this case, the protein can be translationally modified by N-linked glycosylation at consensus Asn-X-Ser/Thr sequences and secreted from the infected cells. Authentic co- and posttranslational processing of eukaryotic secreted proteins is generally essential for their full biological activity. Finally, by comparison to mammalian cells, lines of cultured insect cells are relatively easy to grow, inexpensive to maintain, and can be produced in large numbers.

Nevertheless, baculovirus expression systems have certain disadvantages. High-level expression of proteins is discontinuous and short lived: Cultured insect cells must be grown, infected, and harvested before lysis, usually within 1 week of infection with recombinant viruses. To overcome these problems, stable plasmid-based expression systems have been developed (for review, please see McCarrroll and King 1997). The results obtained so far with stably transformed lines of insect cells are encouraging in that a few proteins have been expressed at relatively high levels. However, other proteins are expressed at much lower levels in stably transformed cell lines than in the conventional system of acutely infected cells. The reasons for this variability are unknown. Insect cells do not generally provide "complex" N-glycosylation such as addition of galactose and sialic acid residues. Instead, they trim the core oligosaccharide to  $\text{Man}_{3-5}\text{GlcNac}_2$ , with some fucose addition on GlcNac. Although this type of N-glycosylation is usually sufficient to provide biologically active mammalian products, the lack of terminal complex glycosylation may result in subtle differences in, for example, solubility, stability, and immune response. In addition, because of the very high levels of expression that the baculovirus system can achieve, the posttranslational machinery of the cell often does not keep pace with expression, and protein modification may not be efficient (Jarvis et al. 1990). Finally, be warned that some genes just do not express well in the baculovirus expression system; in this respect, baculovirus systems are no different from other eukaryotic and prokaryotic expression systems.

## Commercially Available Baculovirus Expression Systems

The best way to obtain the clones, vectors, and cell lines that are components of baculovirus expression systems is simply to buy a kit. Invitrogen and CLONTECH both sell comprehensive sets of reagents that are supplied with straightforward instructions and clearly written technical material. The manipulations are simple, the success rate is very high, and the kits are reasonably inexpensive. So go for it!

---

## GREEN FLUORESCENT PROTEIN

---

The bioluminescent jellyfish *Aequorea victoria* (illustrated on the cover of this book) emits a characteristic green fluorescence, visible as a ring of light around the edge of the umbrella (Harvey 1952). This is due to the activity of two proteins: the calcium-binding photoprotein aequorin, and its companion, the green fluorescent protein (GFP). In the last 10 years, GFP has become one of the most interesting proteins in biochemistry and molecular biology. In addition to providing a tool to understand and manipulate the relationship between protein structure and spectroscopic function, GFP has been used with increasing success as a marker for gene expression and intracellular processes in organisms ranging from bacteria to transgenic mice.

GFP, discovered by Shimomura et al. (1962), is a 238-residue polypeptide ( $M_r = 26,888$ ) encoded by three exons spread over 2.6 kb of the *A. victoria* genome (Prasher et al. 1992). The protein is stable to a wide variety of harsh conditions including heat, extreme pH, and chemical denaturants (Ward and Bokman 1982) and continues to emit fluorescence after fixation in formaldehyde (Chalfie et al. 1994). However, the fluorescence is rapidly quenched under reducing conditions (Inouye and Tsuji 1994).

The emission spectrum of GFP peaks at 508 nm (Johnson et al. 1962), a wavelength close to that of living *Aequorea* tissue, but distinct from the chemiluminescence of pure aequorin, which is blue and peaks near 470 nm. With the initial purification and crystallization of GFP, it was discovered that calcium-activated aequorin could efficiently transfer its luminescent energy to GFP when the two were coadsorbed onto a cationic support (Morise et al. 1974). Green light is produced when energy is transferred by a Förster-type mechanism from  $\text{Ca}^{2+}$ -activated aequorin to GFP. Blue light emitted by activated aequorin is captured by a hexapeptide chromophore (beginning at residue 64 of GFP) that contains a cyclic structure (4-[*p*-hydroxybenzylidene]imidazolidin-5-one) attached to the peptide backbone through the 1- and 2-positions of the ring (Shimomura 1979). Interestingly, this structure appears to be conserved among fluorescent proteins, even those from nonbioluminescent organisms (Matz et al. 1999).

## Structure and Function

The resolution of the crystal structure of GFP provided an explanation for many of its observed physical properties (Ormo et al. 1996; Yang et al. 1996). The protein consists of a  $\beta$ -barrel structure composed of 11 strands ( $\beta$  sheets) that encapsulate a central  $\alpha$ -helix. The chromophore, formed by the cyclization of residues Ser-65, Tyr-66, and Gly-67, is contained within a short helical structure, which is itself buried inside the tightly woven 11-stranded  $\beta$ -barrel (Ormo et al. 1996; Yang et al. 1996; Brejc et al. 1997). The insulation of the chromophore inside the  $\beta$  "can" confers many of the physical properties of GFP, including resistance to urea, detergents, proteolytic attack, thermal denaturation, and, in some cases, to formaldehyde fixation. The secondary and tertiary structures of GFP suggest a mechanism for the function of the protein. Of recent note, the resolution of the crystal structure of the aequorin from *Aequorea aequorea*, reported by Head et al. (2000), has provided further details of the mechanism of the bioluminescent reaction for that calcium-sensitive photoprotein.

The GFP chromophore does not require special biosynthetic pathways that are specific to Cnidaria. Instead, it can be formed in a wide range of cells that normally do not produce light. GFP undergoes an autocatalytic, intramolecular reaction to create the chromofluor in a posttranslational formation that occurs with a time constant of nearly 4 hours in the native protein (Heim et al. 1994; Inouye and Tsuji 1994). This reaction involves cyclization and oxidization of the trimer Ser-65, dehydro-Tyr-66, and Gly-67 (Heim et al. 1994). The isolated chromophore, the intact GFP protein, and synthetic chromophores all dis-

play very similar spectral characteristics: They absorb light maximally at ~390 nm with a smaller peak of absorbance at ~480 nm (Morise et al. 1974; Ward et al. 1980; Cody et al. 1993). However, only the intact GFP emits green light (with a peak at 509 nm and a shoulder at 540 nm) (Morise et al. 1974). Because the ratio of the two absorption peaks is sensitive to such factors as pH, temperature, and ionic strength (Ward and Bokman 1982), it has been suggested that the chromophore may exist in two different forms. Recent structural studies demonstrate that the two peaks of absorbance, ~390 nm and ~480 nm, represent two forms of the chromophore, having protonated and deprotonated tyrosyl hydroxyl groups, respectively (Brejc et al. 1997; Palm et al. 1997). Molecular dynamic studies of the wild-type and mutant versions of the protein, such as GFP-S65T and GFP-F64L/65T (EGFP), provide an explanation of how these conformational and chemical changes within the chromophore affect its function (Haupts et al. 1998).

## GFP as Reporter

The demonstration that GFP maintained its ability to fluoresce in organisms other than *Aequorea* (Chalfie et al. 1994) suggested that no other agents such as antibodies, cofactors, or enzyme substrates are necessary for its activity. These initial findings opened the way for GFP to be used as a marker in *Caenorhabditis elegans* (Chalfie et al. 1994), bacteria and yeasts (Flach et al. 1994; Nabeshima et al. 1995; Yeh et al. 1995; Niedenthal et al. 1996), *Drosophila* (Wang and Hazelrigg 1994; Barthmaier and Fyrberg 1995); zebrafish (Amsterdam et al. 1995), plants (Chiu et al. 1996), and cultured mammalian cells (Marshall et al. 1995; Misteli et al. 1997). There are now several reports that GFP may be used effectively as a reporter in transgenic mice (Ikawa et al. 1995; Chiocchetti et al. 1997; Okabe et al. 1997; Zhuo et al. 1997).

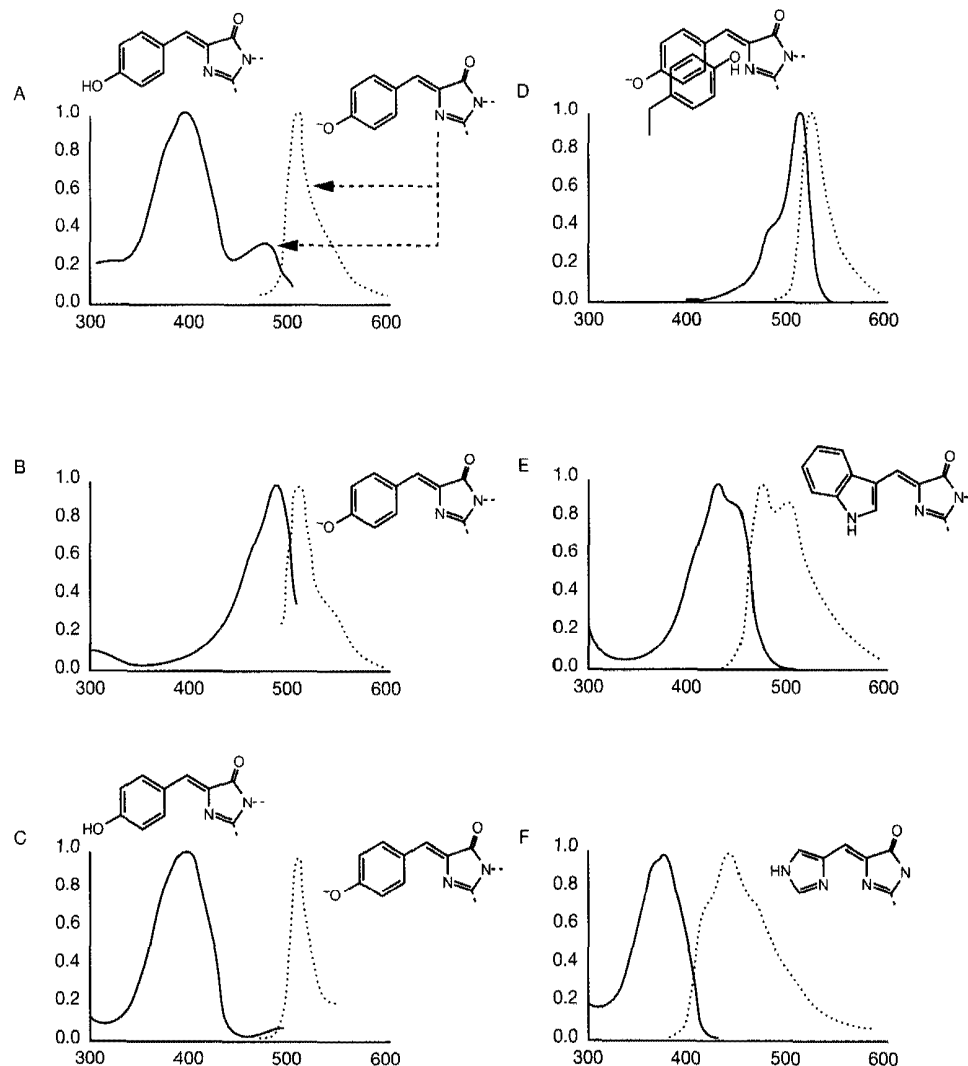
These early remarkable successes suggested that many potential difficulties in the heterologous expression of the jellyfish protein were not insurmountable. Despite these demonstrations, however, wild-type GFP suffered from several limitations that may have impact on experimental design.

- The posttranslational modifications required to form the chromophore and the inaccessibility of the chromophore in the depths of the  $\beta$  "can" result in a lag (>1 hour) between synthesis of GFP and its ability to emit fluorescence. This delay may complicate studies of gene expression where an immediate read-out is desired.
- Efficient expression in higher eukaryotes and plants may require optimization of the coding sequence of GFP.
- No definitive prediction can be made about whether a particular fusion protein involving GFP will generate a functional and fluorescent protein. To avoid problems, a variety of fusion constructs should be generated and characterized.
- Overexpression of protein in cells may cause problems in general. It is thought, for example, that expression of GFP to high levels in yeast can lead to mislocalization of the protein within the cells. It is unclear, however, whether this effect is due to the overabundance or the nature of the protein.
- It may be difficult to detect GFP-specific fluorescence over background autofluorescence, although, in some cases, this may be overcome using confocal microscopy. To record a good signal, the correct equipment, careful choice of filters, and a thorough knowledge of microscopy may be necessary.
- GFP exhibits significant spectral changes in response to protein concentration, ionic strength, and pH. It is therefore important to assay GFP under standard conditions.

The heterologous expression of *Aequorea* GFP in different organisms therefore originally met with only limited success. For example, the presence of cryptic splice sites in the original clone resulted in the deletion of portions of the coding region in some organisms such as plants, the translation initiation site was not optimal for expression in many foreign hosts (Kozak 1987), and some of the codons were infrequently used. The entire cDNA sequence encoding GFP has now been mutagenized or synthesized in several different ways by various groups to alter some or all of these features, and the signal produced by the reporter has been increased considerably (Haseloff and Amos 1995; Reichel et al. 1996; Zolotkin et al. 1996; Haseloff et al. 1997). In addition, the problem of a relatively low level of transcription has been addressed by the insertion of strong constitutive promoters from viruses such as cytomegalovirus (CMV), SV40, or the human immunodeficiency virus (HIV) long terminal repeat upstream of the GFP-coding region (Gervaix et al. 1997), which results in significant levels of expression.

In attempts to overcome some of the limitations of detection of GFP, extensive structure-driven, site-directed mutagenesis studies have been carried out. As a result of these studies, an increasingly long list of

variants has been described, each having altered fluorescence excitation and/or emission spectra (for a summary of these, please see Figure 17-12) (Crameri et al. 1996; Heim and Tsien 1996; Cormack et al. 1997). In many of these cases, the altered properties provide significant advantages over wild-type GFP for many applications. For example, mutation of Tyr-66 has significant impact on GFP because the fluorescent properties of the chromophore largely derive from the  $\pi$  electron-conjugated framework of this amino acid. Amino acid substitutions at position 66 result in alteration of excitation/emission wavelengths, in some cases, generating proteins that fluoresce yellow, blue, and cyan. However, mutation of Tyr-66 can also reduce fluorescent output to 20% of the wild-type protein. By contrast, mutants at the adjacent position Thr-65, such as S65T (Heim et al. 1995) or S65G, S72A (Cormack et al. 1996), display an excitation peak that is four-



**FIGURE 17-12** Fluorescence Excitation and Emission Spectra for GFP Variants

The fluorescence excitation and emission spectra are represented as solid and dashed lines, respectively, for typical members of the six major classes of GFP mutants, together with the chromophore structures believed to be responsible for the spectra. Spectra have been normalized to a maximum amplitude of 1. When only one structure is drawn, both excitation and emission spectra arise from the same state of chromophore protonation. The actual GFPs depicted are wild type (Class I) (A); Emerald (Class II) (B); H9-40 (Class III) (C); Topaz (Class IV; yellow fluorescent protein) (D); W1B (Class V; cyan fluorescent protein) (E); P-4-3 (Class VI; blue fluorescent protein) (F). (Adapted, with permission, from Tsien 1998 [©Annual Reviews].)

to sixfold greater than that of wild-type GFP. In some mutants, the oxidation step required to generate the fluorophore occurs more rapidly in the mutant protein than in the wild-type protein. Figure 17-12 illustrates the fluorescent excitation and emission spectra for several GFP mutants.

### GFP as Fusion Tag

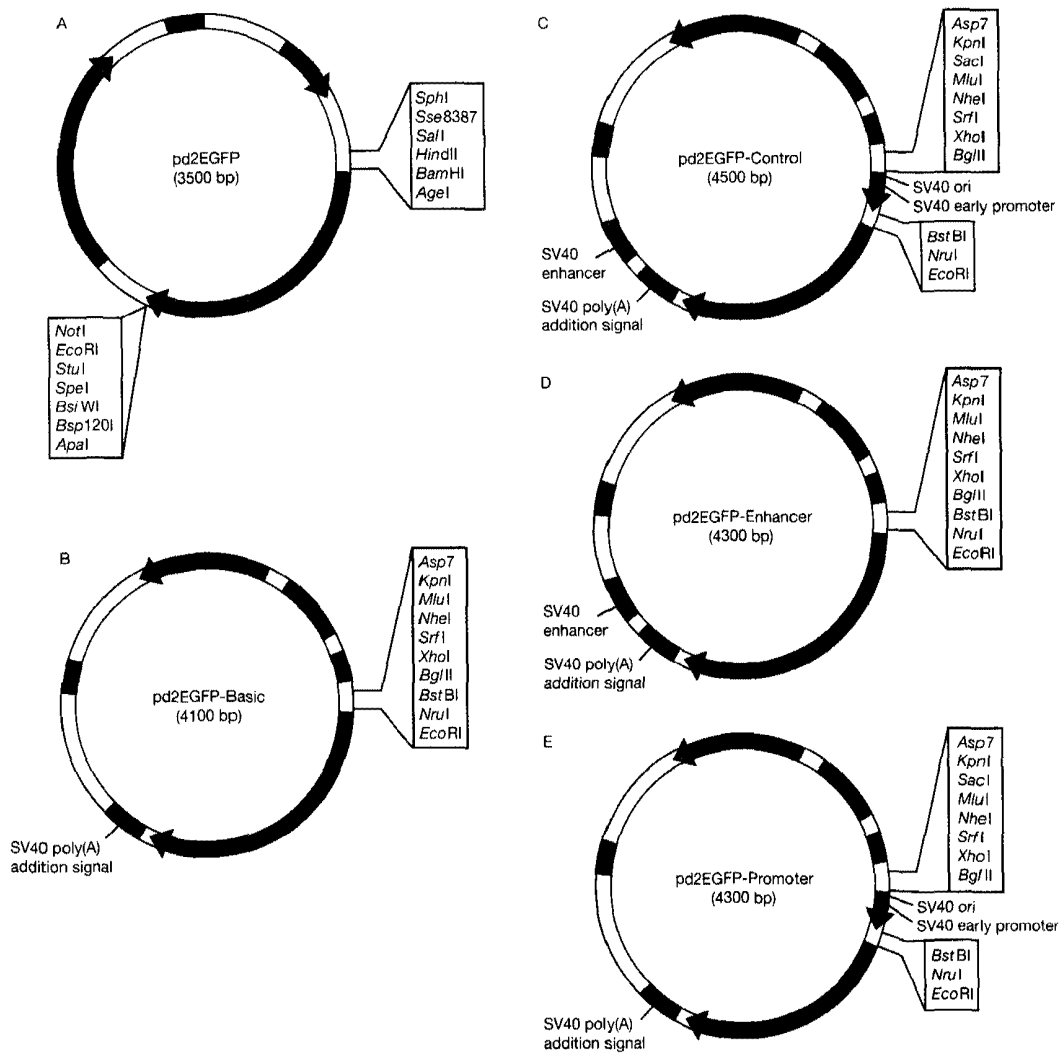
GFP markers are most commonly used either as a tag to track the levels and localization of the fusion partner or as an indicator to detect environmental changes or protein interactions. In tagging applications, the use of recombinant techniques as well as mutagenesis has resulted in the production of several vectors that optimize expression of the fusion product. Such vectors typically employ a "brightened" form of the fluorescent protein whose codon usage has been optimized for expression in a particular cell line (e.g., please see Zolotkin et al. 1996), and the expression of such constructs is typically driven by strong promoters such as that from cytomegalovirus. Figure 17-13 describes the pd2EGFP vector series that offer many of these features.

Various recombinant strategies may be used to fuse the GFP tag to the amino terminus or carboxyl terminus of the target protein (for an excellent discussion of creating fusion constructs, please see Hughes 1998). In cases where the addition of the tag to the end a protein is not well-tolerated, it may be possible to insert the GFP tag within the coding sequence of the target protein. This placement will, in some cases, allow proper folding of the tag and produce a functional chromophore (e.g., please see Siegel and Isacoff 1997). These constructs may be introduced into the cell or organism using standard methods for transient or stable expression (please see Chapter 16). The fate of the constructs (e.g., their transport or expression) is then followed using conventional fluorescence microscopy. Because detection does not require permeabilization or fixation of cells, there is little probability of introducing artifacts. Moreover, expressed GFP-fusion proteins are rarely toxic to cells, although fusion partners localized to the cell nucleus may induce more damaging side effects than those found in the cytoskeleton, for example (T. Misteli and D. Spector, unpubl.).

Among the most successful tagging applications has been the use of GFP to monitor the dynamic localization and fate of fused proteins in living cells and organisms. Since the initial report that described tracking ribonucleoprotein (RNP) particles during *Drosophila* oogenesis (Wang and Hazelrigg 1994), GFP has been targeted to and expressed successfully in nearly every major organelle of the cell. Among the wide range of reports in the literature are studies dealing with visualizing the dynamic properties of organelles such as the Golgi (Cole et al. 1996; Presley et al. 1997), observing events in the cytoskeleton (Olson et al. 1995) and along secretory pathways (Wacker et al. 1997), and following the events of protein trafficking (Lee et al. 1996) and cytokinesis (Finger et al. 1998). Of particular note are studies that use a set of GFP variants to track different proteins simultaneously within the cell (Misteli and Spector 1997; Tsien and Miyawaki 1998). Recently, fluorescent proteins having significant homology with GFP have been isolated from the nonbioluminescent species of *Anthozoa* (Matz et al. 1999). Among these, a red fluorescent protein was shown to exhibit a maximum emission spectrum at 583 nm, "red-shifted" well outside the range of other GFP variants. As is depicted in Figure 17-12, the large shifts in the mutant GFPs are in the excitation, rather than in the emission wavelengths. The red fluorescent protein can be easily detected using either the standard epifluorescent microscope or typical confocal microscope, and therefore promises to be of great use in double- or triple-labeling studies.

The combination of random and directed mutagenesis studies have produced altered chromophore structures that enable GFP to serve as indicators of environmental changes in the cell or of interactions between or among proteins (for a more complete description of these studies and their possibilities, please see the review on biochemical imaging by Tsien and Miyawaki 1998). These studies of resonance energy transfer are based on systems for detecting the transfer of energy between two molecules, serving as donor and acceptor, on different proteins. Because the probability of energy transfer between two molecules diminishes as the sixth power of the distance between them, this strategy provides an exquisitely sensitive measure of the distance and interaction between the molecules. The use of GFP variants in energy transfer experiments can facilitate, for example, the detection of conformational changes in a protein associated with the binding of calcium to calmodulin (Miyawaki et al. 1997), as well as the depolarization of ion channels (Siegel and Isacoff 1997). Recently, GFP applications using fluorescence resonance energy transfer (FRET) have been used to detect and measure protein activation and interactions (Day 1998; Mahajan et al. 1998, 1999; Wouters and Bastiaens 1999). For a detailed discussion of the use of FRET to detect protein interactions, please see Chapter 18, Protocol 7. A variation of this approach, known as bioluminescent resonance





**FIGURE 17-13 pd2EGFP Vectors**

Summarized here are the features of the pdEGFP reporter vectors. All vectors in the series carry the coding sequence for a destabilized variant of the enhanced GFP (dEGFP). EGFP has a single, red-shifted excitation peak and fluoresces ~35 times more intensely than does GFP. The codon usage of EGFP is optimized for human coding preferences. The destabilized variant has a half-life of ~2 hours in mammalian cells, by contrast to EGFP, which has a half-life of ~24 hours. Because of its rapid turnover, d2EGFP is useful as a reporter for measuring the kinetics of transient mRNA transcription from a regulated promoter. All vectors in the series carry (1) an origin of plasmid replication in *E. coli* (pUC ori), (2) an ampicillin resistance marker (Amp<sup>R</sup>) for selection in prokaryotic cells, and (3) a multiple cloning site (MCS) at the 5' end of the EGFP sequence for insertion of the sequence under study. (A) pd2EGFP is intended primarily as a source of the d2EGFP-coding sequence. The coding region can be amplified by PCR or excised using the flanking restriction sites in the MCS. (B) The basic vector lacks eukaryotic promoter and enhancer sequences, allowing maximum flexibility in cloning regulatory sequences. The expression of EGFP depends on the insertion and proper orientation of a functional promoter upstream of the intron and EGFP gene. (C) The enhancer vector lacks the SV40 promoter, but contains the SV40 enhancer. This vector can be used to study promoter sequences cloned into the MCS. (D) The promoter vector lacks the SV40 enhancer, but contains the SV40 early promoter. This vector can be used to study enhancer sequences cloned into the MCS. (E) The control vector contains the SV40 early promoter and SV40 enhancer. This vector can be used as a positive control or as a reference when comparing the activities of promoter and enhancer elements. (Modified, with permission, from CLONTECH.)

energy transfer (BRET), relies on the use of a natural bioluminescent pathway to transfer energy to GFP (Angers et al. 2000). In this case, either the enzyme luciferase from the sea pansy *Renilla reniformis* or the photoprotein aequorin from *A. victoria* serves as energy donor by catalyzing the oxidation of coelenterazine. Luciferase and aequorin normally emit blue light; therefore, a detectable shift in emission toward a longer wavelength characteristic of a green or yellow fluorescent protein acceptor molecule signals that the transfer of energy has occurred.

Clearly, the possibilities for using fluorescent tags to probe the mysteries of the cell seem to be limitless. The use of natural and engineered GFP variants having distinctive spectral properties will facilitate the tracking of many proteins through the cell simultaneously, as well as the detection of their physiological activities and interactions. Live cell imaging in developing organisms is likely to resolve many questions of cell migration during development and differentiation.

### Resources for Using GFP

Further information on use of wild-type and mutant forms of GFP as markers for gene expression in a wide variety of species can be found in the many reviews of the protein that have appeared in recent years (e.g., please see Leffel et al. 1997; Tsien 1998; Haseloff et al. 1999; Ikawa et al. 1999; Naylor 1999). These reviews are obligatory reading for those investigators who want to use GFP as a reporter in their particular experimental organism or cell type.

An extensive range of GFP variants (natural as well as mutant), vectors, and antibodies is now commercially available. CLONTECH has perhaps the most comprehensive set of vectors; GFP antibodies are available from many companies, including Chemicon Intl., Panvera, CLONTECH, and Alexis Corp. For the Web Sites of many of these companies as well as addresses for other resources that provide information relevant to studies using GFP, please see Table 17-2.

**TABLE 17-2 Resources**

RESOURCE	WEB SITE	COMMENTS/INFORMATION
Brookhaven National Laboratory	<a href="http://www.pdb.bnl.gov/browse_it">www.pdb.bnl.gov/browse_it</a>	structure of GFP (GFP PDB files)
NIH Image Home Page	<a href="http://rsb.info.nih.gov/nih-image/">http://rsb.info.nih.gov/nih-image/</a>	information on digital microscopy and shareware for image analysis
Codon usage database	<a href="http://www.kazusa.or.jp/codon">www.kazusa.or.jp/codon</a>	codon usage frequencies for any organism; good for optimizing design for expression
CLONTECH	<a href="http://www.gfp.clontech.com">www.gfp.clontech.com</a>	GFP products suitable for many applications: enhanced and destabilized GFP vectors, recombinant fluorescent proteins, GFP antibodies, GFP sequencing primers
Quantum Biotechnology	<a href="http://www.qbi.com/autofluo">www.qbi.com/autofluo</a>	good line of autofluorescent proteins; many spectral properties
Invitrogen	<a href="http://www.invitrogen">www.invitrogen</a>	lines of GFP constructs
Life Technologies	<a href="http://www.lifetechnologies.com">www.lifetechnologies.com</a>	transfection reagents and vectors
PanVera	<a href="http://www.panvera.com">www.panvera.com</a>	GFP antibodies
Image Analysis Laboratory	<a href="http://www2.med.unipg.it/imagelab">www2.med.unipg.it/imagelab</a>	information on using GFP to study targeting sequences; advice on microscopy
Molecular Motion Laboratory	<a href="http://www.yale.med.edu/ophtha/thom/tools">www.yale.med.edu/ophtha/thom/tools</a>	many useful links to Quick-time videos, images, GFP resources

---

## EPITOPE TAGGING

---

### Epitope Tagging: An Overview

Fusion proteins consist of the amino acid residues of interest covalently attached at their amino or carboxyl termini to a set of carrier sequences. When the carrier sequences contain a useful antigenic determinant, the fusion protein is said to be tagged with an epitope. Epitope tagging is a powerful technique to characterize proteins of interest without purification. Another major advantage of epitope tagging is that well-characterized and highly specific antibodies can be used to study proteins of interest without the long laborious routines and uncertainties for production and characterization of antibodies. Epitope tagging has become a routine practice in the yeasts *Saccharomyces cerevisiae* and *Schizosaccharomyces pombe* (Bahler et al. 1998; Longtine et al. 1998). A tag can be fused to the carboxyl terminus of a protein at its endogenous locus using existing PCR modules without cloning and disrupting its endogenous promoter. In mammalian cells, this approach is not feasible at the present time. In most cases, the fusion protein is expressed under the control of a heterologous promoter (Sells and Chernoff 1995; Chubet and Brizzard 1996; Georgiev et al. 1996; Hosfield and Lu 1998), which typically results in abnormal expression of the gene of interest. Therefore, epitope tagging cannot be used, for example, to study regulation of a cell-cycle-regulated gene.

One assumption here is that addition of an epitope tag does not affect the function, intracellular transport, modification, or location of the target protein. Several studies have suggested that most proteins can accept a tag at one terminus or other regions without severe loss of their functions (Prasad and Goff 1989; Anand et al. 1993; Ross-Macdonald et al. 1997). However, whether this holds true must be tested whenever possible. In yeast, where the excavation of chromosomal genes is a routine matter, it is often possible to erase any doubts immediately by testing the ability of the epitope-tagged protein to complement a null allele. In mammalian cells, these matters must be taken on faith, and any results obtained should remain open to question until they have been confirmed by other means. In cases where a sensitive functional assay is available *in vitro*, it is sometimes possible to synthesize enough of the tagged protein in cell-free systems to confirm that it has retained full activity.

### Epitope Tagging: Practical Considerations

Table 17-3 presents a sample of the epitopes that have been used for tagging. Because most of these epitopes are derived from a hormone or an oncogene, there is a finite but small chance of immunological cross-reaction with cellular material. In most cases, a single monoclonal antibody specific for the epitope can be used for immunostaining, immunoblotting, immunoprecipitation, and immunopurification.

The number of well-characterized epitopes is growing rapidly, and many commercial companies now sell kits that contain the materials and instructions to construct and test epitope-tagged fusion proteins of various sorts. However, before deciding to use an epitope-tagging strategy, it is best to work out the cost of the necessary reagents. This is especially important if the goal is to use the epitope for large-scale affinity purification of the fusion protein. Some of the companies charge such outrageous prices for monoclonal antibodies that the ongoing cost of the system quickly becomes prohibitive for many laboratories.

Another important consideration is to determine whether the selected epitope has been used in the literature for a purpose similar to that of its intended application. Even though epitope tagging may vary from protein to protein, the fact that similar approaches have been exploited with a particular tag increases the likelihood of its success and may provide some ideas and some detailed information on how to utilize this epitope, which may not exist in most general protocols.

It is very important to choose a tag whose cognate antibody will not cross-react with a protein in the host cells used for expression of the epitope-tagged protein and to choose a tagging site on the target protein that will not interfere with the function of any topogenic sequences (e.g., hydrophobic signal sequences) or trafficking signals (e.g., nuclear transport signals or endoplasmic reticulum retention sequences). Whenever possible, however, the epitope tags should be added to the amino or the carboxyl terminus of the target protein, where they are most likely to be accessible to antibody and least likely to interfere with the function of the target protein.

When an epitope tag is used for immunopurification, it is best to choose a tag that may be removed from the target protein. Removal is sometimes necessary to restore protein function, to increase solubility,

or to decrease antigenicity. Although success is not guaranteed, removal may be accomplished by incorporating a protease cleavage site in the peptide linker between the epitope tag and the target protein (for details, please see the introduction to Chapter 15). However, enzymatic removal is often inefficient (because the cleavage site is inaccessible) and sometimes destructive (because the cleaving protease is not absolutely specific or because of contamination with nonspecific proteases) (Nagai and Thøgersen 1987; Dykes et al. 1988).

### Epitope Tagging: Applications

Since the introduction of epitope tagging by Munro and Pelham (1984), it has been used to address several experimental problems, including the detection, localization, and purification of expressed proteins. The protein of interest can be detected with immunological reagents directed against the epitope and purified by affinity chromatography in the absence of a functional assay (Field et al. 1988). In addition, because the tagged protein can be differentiated unambiguously from related cellular proteins (Davis and Fink 1990), its size and location can be ascertained by western blotting and immunofluorescence (Munro and Pelham 1986, 1987; Geli et al. 1988; Pelham et al. 1988; Swanson et al. 1991), its pattern of biosynthesis and post-translational modification can be followed by pulse-labeling and immunoprecipitation, and its interactions with other proteins can be probed by coimmunoprecipitation (Kolodziej and Young 1989; Squinto et al. 1990). Finally, with the development of sensitive mass spectrometry for peptide sequencing, epitope tagging has been used increasingly for purification of protein complexes and identification of components in the protein complexes (Ogryzko et al. 1998; Shao et al. 1999). Although it is not possible to provide a comprehensive list of the relevant literature, below are some recent major applications of epitope tagging.

- **Gene expression and localization.** Epitope tagging has been used to study gene expression in various organisms using western blotting. If it is difficult to detect the expression of a fusion protein using a single epitope, due to a low expression level and instability of the protein, sensitivity can be increased by adding multiple epitopes (Nakajima and Yaoita 1997). Once a fusion protein is expressed, its localization can be detected by immunofluorescence. This technique is very useful to study localizations of isoforms of a gene family that share highly significant sequence identity, where specific antibodies to different isoforms are always difficult to generate (Scherer et al. 1995; Toyota et al. 1998). Epitope tagging can also be used for mapping regions of a protein that are responsible for targeting the protein to specific locations (Xu et al. 1998).
- **Interactions.** By using coimmunoprecipitation and detection by western blotting, epitope tagging has been used widely to study protein-protein interactions *in vitro* and *in vivo* (Chinnaiyan et al. 1995; Hsu et al. 1996) (for details, please see Chapter 18, Protocols 2, 3, and 4). In cases where no antibodies are available for either of the two potentially interacting proteins, different tags may be attached to each of the two proteins. The antibody that recognizes one epitope is then used for immunoprecipitation, whereas the antibody against the other epitope is used for detection of the immunoprecipitated proteins. In this case, it is always wise to perform the reciprocal coimmunoprecipitation experiment to determine whether the interaction is specific. Moreover, it is important to recognize that because candidate proteins identified by immunoprecipitation may not interact directly with the bait protein, it is advisable to use other means to confirm whether a direct interaction exists.
- **Purification of protein complexes.** In many cases, a biological function is carried out by a protein complex instead of a single protein. Therefore, it is essential to identify and purify all of the components of a protein complex. In organisms such as yeast where genetic approaches exist to identify all of the components performing the same function, it is still necessary to purify protein complexes to study their biochemical functions. Epitope tagging has provided a way to purify protein complexes by immunoaffinity chromatography and immunoprecipitation (Chiang and Roeder 1993; Ogryzko et al. 1998; Shao et al. 1999). Now that the complete genomic sequences of several organisms are available (e.g., the yeast *S. cerevisiae*, *C. elegans*, and *Drosophila*), and with the significant reduction in the amounts of materials required for peptide sequencing by mass spectrometry (Dukan et al. 1998; Huang et al. 2000), the use of immunoprecipitation to identify components in protein complexes is likely to become one of the major techniques in proteomics.

TABLE 17-3 Epitope Tagging

ORIGIN OF TAG	DESCRIPTION OF EPITOPE	SOURCE OF ANTIBODIES	REFERENCES
Substance P	QFFGLM The sequence of this hexapeptide corresponds to the carboxy-terminal half of substance P.	MAB NCI/34 to substance P recognizes only the carboxy-terminal pentapeptide of substance P (Cuello et al. 1979). However, this antibody can be used for western blotting or immunofluorescence only after carboxyl groups in the target protein have been converted to amides with soluble carbodiimide and $\text{NH}_4\text{Cl}$ (Munro and Pelham 1984).	Cuello et al. (1979); Munro and Pelham (1984); Albers and Fuchs (1987)
Human c-Myc protein	EQKLISEEDL	MAB 9E10 (Evan et al. 1985) was raised against a synthetic peptide comprising residues 409–439 of human <i>c-myc</i> . The epitope recognized by MAB 9E10 was identified by progressive deletion of residues 409–439 of <i>c-myc</i> (Munro and Pelham 1986).	Evan et al. (1985); Munro and Pelham (1986, 1987); Pelham et al. (1988); Squinto et al. (1990); Adamson et al. (1992); Sells and Chernoff (1995)
Anonymous open reading frame	KAEDESS The translational stop codon at the end of the <i>HGPRT</i> gene was mutated to allow extended translation to the next in-frame stop codon. The resulting protein, which is enzymatically active, carries a unique negatively charged heptapeptide at its carboxyl terminus.	Polyclonal antibodies were raised against a synthetic peptide and affinity-purified.	Yee et al. (1987)
Colicin A protein	178 amino-terminal amino acids of colicin A protein.	MAB 1c11 recognizes an epitope located in the first 70 amino acids of colicin A protein (Cavard et al. 1986).	Cavard et al. (1986)
Influenza virus hemagglutinin	YPYDVPDYA	MABs were originally raised against a synthetic peptide corresponding to amino acids 75–110 of the hemagglutinin protein of the H3 subtype of influenza virus (Niman et al. 1983). MABs 12CA5 and 3F10 are now available commercially from Berkeley Antibody Co. (Babco), which recognize the complete antigenic determinant (YPYDVPDYA) of the immunizing 36-residue peptide (Wilson et al. 1984). This nonapeptide can be used to release fusion proteins from the MAB.	Niman et al. (1983); Wilson et al. (1984); Field et al. (1988); Swanson et al. (1991); West et al. (1992); Marck et al. (1993); Sells and Chernoff (1995)
SV40 T antigen	85 amino-terminal amino acids of SV40 large T antigen.	MAB Pab 419 (L19 in Harlow et al. 1981).	Harlow et al. (1981); Sugano et al. (1992)
FLAG sequence	DYKDDDDK FLAG was designed as a hydrophilic, immunogenic purification tag that could be removed from the target protein by proteolytic cleavage (Hopp et al. 1988). The five carboxy-terminal amino acids of the FLAG epitope are adapted from the site cleaved by enterokinase in its natural substrate bovine	MAB 4E11 (Hopp et al. 1988; Prickett et al. 1989), which is specific for the FLAG sequence, can be used for immunoblotting, immunoprecipitation, and immunoaffinity purification. Binding of proteins tagged with the FLAG epitope to this antibody is calcium-dependent and reversible with chelating agents such as EGTA or at low pH.	Davie and Neurath (1955); Hopp et al. (1988); Knott et al. (1988); Prickett et al. (1989)

trypsinogen. Digestion with enterokinase, which cleaves after the lysine residue in the sequence VDDDDK (Davie and Neurath 1955), should remove an amino-terminal FLAG sequence after immunopurification of a tagged protein.

Vesicular stomatitis virus (VSV) G protein	YTDIEMNRLGK 11 amino acids from the carboxyl terminus of VSV G protein (Kreis 1986).	Polyclonal and monoclonal antibodies were raised against a synthetic peptide containing the 15 carboxy-terminal amino acids (497-511) of VSV G protein (Kreis 1986). Affinity-purified polyclonal antibodies recognize epitopes distributed along the entire 15-residue peptide, whereas the MAb PD54 reacted only with the carboxy-terminal pentapeptide. Both types of antibodies recognize proteins tagged with the 11-residue epitope, although the polyclonal antibody reacts more strongly (Soldati and Perriard 1991).	Kreis (1986); Soldati and Perriard (1991)
T7-Tag	MASMTGGQQMG	MAb T7 • Tag (sold by Novagen).	Lutz-Freyermuth et al. (1990); Tsai et al. (1992)
AU epitopes	DTYRYI (AU1) and TDFYLK (AU5)	MAbs AU1 and AU5 were developed against papillomavirus major capsid protein.	Lim et al. (1990)
His-6 epitope	HHHHHH	MAbs 6-His, 6xHis, and HIS-11 are commercially available.	
HPOL	HPOL	Mab1051c recognizes a peptide from the thumb region of the herpes simplex virus type-1 DNA polymerase (HPOL).	Schreiner et al. (1999)
Btag	QYPALT	Two MAbs (D11 and F10) developed against the major core protein, VP7, of bluetongue virus were tested to recognize the BTag epitope at any regions of recombinant proteins.	Wang et al. (1996)
3B3	QRQYGDVFKGD	MAb 3B3 was raised against ORF gE of a varicella zoster virus and tested to react with the 3B3 epitope placed in other proteins.	Hatfield et al. (1997)
Glu-Glu	EYMPME or EFMPME	Synthetic peptide EEEEYMPME from polyomavirus medium T antigen was used to produce MAb Glu-Glu. This antibody has been used for affinity purification.	Grussenmeyer et al. (1985)
IRS	RYIRS	MAb IRS1 recognizes fusion proteins containing the epitope at the carboxyl terminus of the proteins only.	Liang et al. (1996); Luo et al. (1996)

## CHLORAMPHENICOL ACETYLTRANSFERASE

Acetyl-coenzyme:chloramphenicol acetyltransferase (acetyl-CoA:CAT; EC 2.3.1.28) has become widely used as a reporter molecule for the indirect assay of transcriptional regulatory elements in transfected mammalian cells. The enzyme covalently modifies chloramphenicol by transferring an acetyl group from acetyl-CoA to the primary hydroxyl residue (C3) of chloramphenicol (please see Figure 17-14).

The product of this reaction, 3-acetyl chloramphenicol, undergoes a nonenzymatic rearrangement in which the acetyl group is transferred to the C1 residue, forming 1-acetyl chloramphenicol. This rearrangement reopens the primary hydroxyl on C3 to a second cycle of acetylation that gives rise to the diacetylated product 1,3-diacetyl chloramphenicol.

The CAT gene is responsible for resistance to chloramphenicol in strains of bacteria that are resistant to the antibiotic. After mono- or diacetylation, chloramphenicol cannot bind to the peptidyl transferase center of prokaryotic ribosomes, the exclusive target for the antibiotic's action. In field strains of Enterobacteria and other Gram-negative bacteria, the CAT gene is constitutively expressed and is usually carried on plasmids that confer multiple drug resistance. In staphylococci, CAT activity is almost invariably encoded by small (<5 kb) plasmids that carry no other resistance markers. Amino acid sequences of several variants of CAT from both Gram-positive and Gram-negative bacteria are highly homologous. All known variants are trimers consisting of identical subunits of  $M_r = 25,000$ . The type I variant, which is encoded by a 1102-bp segment of transposon Tn9, is in wide use as a reporter gene. However, most kinetic and structural analyses are carried out with the type III variant, which yields crystals suitable for X-ray analysis. The trimeric structure is stabilized by a  $\beta$ -pleated sheet that extends from one subunit to the next (Leslie et al. 1988). The two substrates (chloramphenicol and acetyl-CoA) approach the active site through tunnels located on opposite sides of the molecule. The active site, which is located at the subunit interface, contains a histidine residue, which is postulated to act as a general base catalyst in the acetylation reaction (Leslie et al. 1988; Shaw et al. 1988).

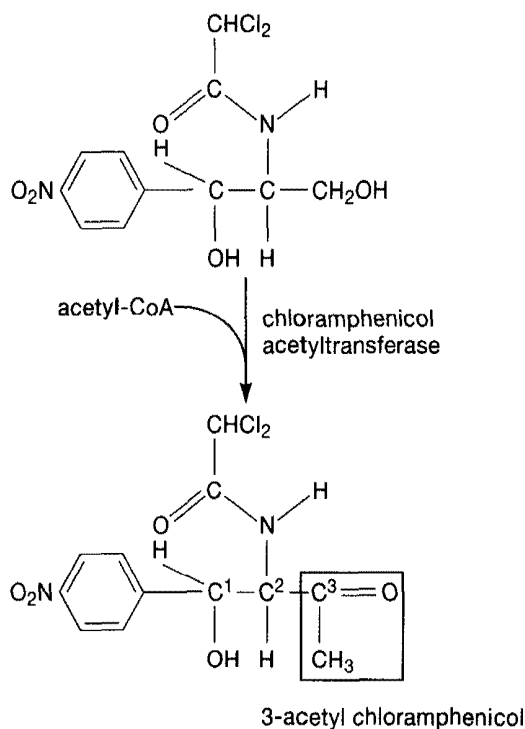


FIGURE 17-14 Reaction Catalyzed by CAT

## Expression of CAT in Mammalian Cells

Virtually all transfection experiments with CAT have been carried out with constructs derived from the plasmid pSV2CAT, which contains the SV40 promoter/enhancer, 29 bp of untranslated sequence, the CAT-coding sequence, and 8 bp of DNA 3' to the UAA stop codon (Gorman 1985). pSV2CAT cannot confer chloramphenicol resistance upon bacteria because the CAT gene is not linked to a prokaryotic promoter. To assay putative promoters in mammalian cells, a derivative of pSV2CAT has been constructed (pSVOCAT) (Gorman et al. 1982) that allows the promoter region of SV40 to be replaced by the promoter under test.

The CAT gene fulfills many of the criteria required of an ideal reporter gene in mammalian cells. Because CAT is a prokaryotic enzyme, there are no endogenous or competing activities in mammalian cells and the enzyme is quite stable. However, some of the assays used to measure CAT activity in lysates of transfected cells are expensive and time-consuming, and unless great care is taken, they may be inaccurate. Many of the older assays are variations on the methods of Shaw (1975) and Gorman et al. (1982) in which extracts prepared from transfected cells are incubated with  $^{14}\text{C}$ -labeled chloramphenicol. The acetylated products are separated from the unmodified drug by thin-layer chromatography and quantitated by autoradiography or by scraping the spots from the thin-layer plates and counting them by scintillation spectroscopy. CAT activity is then calculated as the percentage of chloramphenicol converted to mono- and diacetylated products. However, all of these older methods are labor-intensive, semiquantitative, and of limited sensitivity ( $\sim 10^{-2}$  units of CAT activity). (One international unit of CAT is defined as the amount of enzyme that catalyzes the production of 1  $\mu\text{mole}$  of product per minute. This is approximately equivalent to  $1.5 \times 10^{11}$  molecules of enzyme.)

The insensitivity of the assay is in part due to the presence of enzymes in extracts of transfected cells that hydrolyze acetyl-CoA. The sensitivity and reproducibility of the assay are greatly improved if the extracts are adjusted to 10 mM EDTA and then heated to 60°C for 10 minutes (Sleigh 1986; Crabb and Dixon 1987) before assay. Newer assays that circumvent the use of thin-layer chromatography include the acetylation of unlabeled chloramphenicol with  $^{14}\text{C}$ -labeled acetyl-CoA. At the end of the reaction, the mixture is extracted with ethyl acetate. The mono- and diacetylated forms of chloramphenicol partition into the organic phase, whereas the acetyl-CoA remains in the aqueous phase. The amount of chloramphenicol converted to the acetylated form can then be measured in a liquid scintillation counter. Subsequent variations on this assay include:

- Extraction of reaction products into liquid scintillation fluor (e.g., please see Eastman 1987; Neumann et al. 1987; Nielsen et al. 1989).
- Enzymatic butyration of radiolabeled chloramphenicol (Seed and Sheen 1988).
- Use of fluorescent substrates for CAT that display bright fluorescence when excited at the appropriate wavelength (Young et al. 1991).

Because of the peculiar chemistry of the CAT reaction, however, none of these assays are truly quantitative. As discussed above, the monoacetylated reaction product, 3-acetyl chloramphenicol, is converted by a nonenzymatic rearrangement to 1-acetyl chloramphenicol. This remains tightly bound to CAT and is then acetylated relatively slowly to 1,3-diacetyl chloramphenicol. Assays that measure the yield of mono- and/or diacetylated products therefore cannot be quantitative. This problem is exacerbated when the concentration of substrate in the assay is significantly lower than the  $K_m$  of CAT for chloramphenicol, which is variously reported to be between 7.5 and 60  $\mu\text{M}$  (e.g., please see Sankaran 1992 and references therein). CAT assays can, however, be made truly quantitative by two methods:

- Use as substrate 1-deoxy chloramphenicol (Murray et al. 1991). This substrate, in which the residue on the C1 atom is replaced by a proton, generates a single acetylated product (3-acetyl, 1-deoxy chloramphenicol), thereby simplifying measurement of enzymatic activity. Radioactive 1-deoxy chloramphenicol is available from Amersham.
- Measure the initial kinetics of the enzymatic reaction, instead of the radioactivity accumulated after a set length of time. This will ensure that the reaction has not been performed under conditions where substrate is limiting (Desbois et al. 1992).

It is preferable to express CAT activity as the amount of product formed per milligram cell extract per unit time (i.e., as a specific activity, not simply as a percent conversion figure).

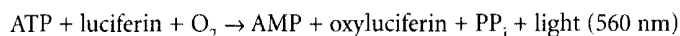


---

**LUCIFERASE**

---

It is luciferase activity that makes fireflies glow as they dance through the summer night air. While providing children with countless hours of twilight fun, luciferase also aids molecular biologists interested in mammalian gene transcription. With few exceptions, such as the gut of the firefly beetle and some marine organisms, luciferase enzyme activity is not found in eukaryotic cells, and thus it serves as an excellent reporter gene in promoter analysis studies. Most luciferase marker genes currently in use for promoter analysis are derived from the *luc* gene of the firefly (*Photinus pyralis*) (de Wet et al. 1985, 1987; Bronstein et al. 1994). The utility of the firefly luciferase gene was recognized by de Wet et al. (1987) who isolated the gene and expressed it as an active enzyme in mammalian cells. These authors took advantage of many years of research into the biochemistry of chemiluminescence and bioluminescence to develop a rapid and sensitive assay for luciferase activity expressed from transfected DNAs. Since this initial report, many modifications have been made to the luciferase assay including the development of modified luciferase genes with higher levels of expression, the use of different assay reagents that change the kinetics of light release, the use of small molecules that stabilize the luciferase enzyme, and the isolation and expression of luciferase genes from several different organisms (de Wet et al. 1987; Bronstein et al. 1994; Himes and Shannon 2000). The enzyme has a characteristic behavior with respect to substrate specificity, light release kinetics, allosteric modulation, and intracellular stability. Luciferase, in the presence of  $Mg^{2+}$ , catalyzes the reaction:



The luciferase enzyme encoded by the firefly cDNA contains a peptide sequence at its carboxyl terminus that targets the protein to the peroxisome compartment of the cell. The peroxisome is a subcellular organelle surrounded by a lipid bilayer that contains a variety of enzymes participating in oxidative metabolism and other aspects of intermediary metabolism. Early studies showed that overexpression of luciferase from some promoter constructs overloaded the capacity of the peroxisome to import the enzyme, leading to a constipated and sick cell. To eliminate this and other problems relating to the expression of an insect enzyme in mammalian cell lines, several alterations have been made to the original firefly luciferase cDNA, including the removal of the peroxisomal targeting sequence, the elimination of sequences predicted to give rise to RNA secondary structure, the inclusion of an optimum translational initiation sequence (a Kozak sequence), the swapping of prevalent insect codons for their mammalian counterparts, the inclusion of polyadenylation sequences upstream and downstream from the luciferase cDNA, and the removal of restriction enzyme sites within the cDNA. An example of a commercially available vector containing a highly modified luciferase cDNA is the pGL series available from Promega (please see Figure 17-4).

Other luciferase genes have been isolated from diverse marine and bacterial organisms and some of these are beginning to be used in molecular biological assays. An example is the luciferase/luciferin enzyme system from the sea pansy (*Renilla reniformis*), which utilizes a substrate different from that of firefly luciferase and which has different biochemical properties. Together, the firefly and sea pansy luciferase enzymes constitute a dual reporter assay system that is available from Promega and that allows measurement of both enzymes in the same test tube (Dual-Luciferase Reporter Assay System). The advantage of this and other dual reporter assay systems (e.g., Dual-Light by Tropix, Inc., Bedford, Massachusetts) is that both the test gene construct (linked to the firefly luciferase) and a transfection/standardization control (a constitutive eukaryotic promoter linked to the sea pansy luciferase or  $\beta$ -galactosidase genes) can be assayed in a single aliquot of cell lysate by the same biochemical method (light emission). It is likely that other luciferase/substrate combinations will be developed in the future that will expedite the use of this system for transcription studies. Keep in mind that the optimum assay components may differ for the luciferase enzymes of different species.

## **$\beta$ -GALACTOSIDASE**

*E. coli*  $\beta$ -galactosidase ( $M_r = 465,412$ ; EC 3.2.1.23) is a tetramer of four identical polypeptide subunits, each consisting of 1023 amino acids. This polypeptide is encoded by the first gene (*lacZ*) of the *lac* operon. Fowler and Zabin (1978) determined the amino acid sequence of  $\beta$ -galactosidase and Kalnins et al. (1983) reported the nucleotide sequence of the *lacZ* gene 8 years later (GenBank accession number = V00296). X-ray diffraction analysis of crystals of  $\beta$ -galactosidase show that the tetramer displays 222-point symmetry (Jacobson et al. 1994). The individual polypeptide chains fold into five sequential domains, with an extended segment of ~50 amino acid residues at the amino terminus. This segment corresponds to the  $\alpha$ -peptide, discussed in more detail later.  $\beta$ -galactosidase, whose synthesis is induced by lactose and certain other galactosides, catalyzes two enzymatic reactions:

- Hydrolysis of  $\beta$ -D-galactopyranosides. The enzyme is essential for the hydrolysis in *E. coli* of the disaccharide lactose (1,4-O- $\beta$ -D-galactopyranosyl-D-glucose) into glucose and galactose.
- A transgalactosidation reaction in which lactose is converted to allolactose (1,6-O- $\beta$ -D-galactopyranosyl-D-glucose), the true inducer of the *lac* operon (Müller-Hill et al. 1964; Jobe and Bourgeois 1972).

$\beta$ -galactosidase also interacts with a series of synthetic analogs of lactose in which glucose has been replaced by other moieties. As described in more detail below, these include:

- The chromogenic substrates *o*-nitrophenyl- $\beta$ -D-galactoside (ONPG) and 5-bromo-4-chloro-3-indolyl- $\beta$ -D-galactoside (X-gal), and the fluorogenic substrate 4-methylumbelliferyl- $\beta$ -D-galactoside (MUG).
- Inhibitors such as *p*-aminophenyl- $\beta$ -D-thio-galactoside (TPEG), which is used for affinity purification of *lacZ* fusion proteins (Germino et al. 1983; Ullmann 1984).

$\beta$ -galactosidase is tolerant of deletions and substitutions of amino acids at its amino and carboxyl termini. Up to 26 amino acids can be removed from the amino terminus and replaced with several hundred or more residues of a variety of other proteins without affecting enzymatic activity (Brickman et al. 1979; Fowler and Zabin 1983). The two carboxy-terminal amino acids are dispensable and can be replaced by other coding regions to generate active chimeric  $\beta$ -galactosidases (Rüther and Müller-Hill 1983).

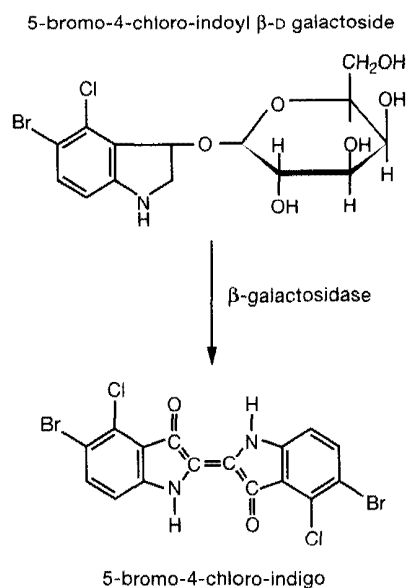
$\beta$ -galactosidase has one other extremely useful peculiarity: the amino and carboxyl domains of the enzyme need not be carried on the same molecule to generate  $\beta$ -galactosidase activity. Instead, two inactive fragments of the polypeptide chain, one lacking the amino-terminal region (the  $\alpha$ -acceptor) and the other the carboxy-terminal region (the  $\alpha$ -donor), are able to associate both *in vivo* and *in vitro* to form a tetrameric active enzyme (Ullmann et al. 1967; Ullmann and Perrin 1970). This unusual form of complementation, called  $\alpha$ -complementation, is widely used in molecular cloning to monitor insertion of foreign DNA sequences into vectors encoding the amino-terminal ( $\alpha$ -donor) fragment of  $\beta$ -galactosidase (for more details, please see the information panel on  $\alpha$ -COMPLEMENTATION in Chapter 1).

### **Quantitative Assays**

#### ***Hydrolysis of ONPG***

$\beta$ -galactosidase activity in bacterial cultures is usually assayed spectrophotometrically. Because the enzyme cleaves  $\beta$ -galactosidic linkages (please see Figure 17-15), it will hydrolyze the synthetic chromogenic substrate ONPG, generating *o*-nitrophenol, which is yellow in aqueous solution. The course of the reaction can therefore be followed by monitoring absorbance at 420 nm (Lederberg 1950).

The assay is carried out using bacterial cells that have been permeabilized with toluene or chloroform and suspended in a buffer containing high concentrations of  $\beta$ -mercaptoethanol (Miller 1972). After incubation with ONPG for set periods of time, the reaction is terminated with  $\text{Na}_2\text{CO}_3$  and the  $\text{OD}_{420}$  is measured. Because the absorbance at 420 nm is a combination of absorbance by *o*-nitrophenol and light scattering by bacterial debris, it is essential to centrifuge the reaction mixtures briefly (60 seconds in a



**FIGURE 17-15** Reaction Catalyzed by  $\beta$ -galactosidase

microfuge) before measuring the  $OD_{420}$  of the supernatant.  $\beta$ -galactosidase activity of the bacterial culture is expressed in Miller units:

$$\text{Units of } \beta\text{-galactosidase} = F(1000 \times OD_{420} \cdot t \times v \times OD_{600})$$

where  $OD_{420}$  is the absorbance at 420 nm of the reaction mixture;  $OD_{600}$  is the absorbance at 600 nm of the bacterial culture just before the enzyme activity is assayed;  $t$  is the time of the reaction in minutes; and  $v$  is volume of the culture (ml) used in the assay. Miller units are proportional to the increase in *o*-nitrophenol per minute per bacterium; 1 ml of a fully induced wild-type culture of *E. coli* contains ~1000 units of  $\beta$ -galactosidase activity, whereas an uninduced culture contains <1 unit.

*E. coli*  $\beta$ -galactosidase can also be expressed in mammalian cells (e.g., please see Hall et al. 1983). A slightly modified version of the Miller assay can be used to measure the activity of the bacterial enzyme expressed in cultured vertebrate cells (Norton and Coffin 1985) and yeasts (Rose and Botstein 1983; Sledziewski et al. 1990).

#### Hydrolysis of MUG

$\beta$ -galactosidase will hydrolyze the synthetic fluorogenic substrate MUG (available from Sigma), generating 4-methylumbelliferone, which emits an intense bluish fluorescence in alkaline solution. The course of the reaction can therefore be followed fluorometrically by exciting at 364 nm and recording the light emitted at 440 nm (Roth 1969; Youngman 1987).

The fluorometric assay is ~10 times more sensitive than the spectrophotometric assay, but of course, it requires an expensive fluorometer. The fluorometric assay is useful only under special circumstances, for example, to quantitate the activity of a weakly expressed gene that has been fused to *lacZ*. The older spectrophotometric assay is perfectly adequate for almost all routine assays of  $\beta$ -galactosidase activity in bacterial, mammalian, and yeast cultures.

#### Histochemical Stains

$\beta$ -galactosidase in many ways is an ideal histochemical marker. It is a stable enzyme and its expression in cultured mammalian cells, yeasts, *Drosophila*, or transgenic mammals does not appear to be either deleterious or advantageous to the host. In addition, a sensitive chromogenic assay is available (see below) that generates a nondiffusible, brightly colored product. Finally, in all but a few specialized eukaryotic cells, hydrolysis of  $\beta$ -galactosidic linkages is catalyzed by lysosomal enzymes that are active only under acid conditions. Because these enzymes are inactive at the neutral pH used to assay for *lacZ*, background staining is negligible.

Substituted indolyl dyes were first used in the 1950s for histochemical localization of nonspecific esterases (for review, please see Burstone 1962). These dyes work because the enzymatically released indolyl is oxidized rapidly to an insoluble indigo that can be seen readily at the sites of enzyme activity. In the early 1960s, the "indigogenic principle," as it was known, was applied successfully to the histochemical localization of mammalian glucosidase through the use of 5-bromo-3-indolyl- $\beta$ -D-glucopyranoside (Pearson et al. 1961). This work was extended to  $\beta$ -galactosidase (Pearson et al. 1963) when a new series of dihalogeno-indolyl compounds were synthesized by J. Horwitz and his co-workers at the Detroit Institute of Cancer Research (Horwitz et al. 1964). Among these compounds was X-gal, which is hydrolyzed by  $\beta$ -galactosidase to 5-bromo-4-chloro-indigo.

In 1967, Julian Davies, working at the Pasteur Institute, was trying to develop nondestructive histochemical stains that would allow him to distinguish between  $lac^+$  and  $lac^-$  colonies. This goal required finding a specific chromogenic substrate that would be hydrolyzed by  $\beta$ -galactosidase to highly colored products that were both nondiffusible and nontoxic. Davies was pleased to find that phenyl- $\beta$ -galactosides produced a satisfactory color reaction, but he was less gratified by their conversion into toxic nitrophenols that efficiently killed the very cells he was trying to identify. Understandably, Davies, who is voluble and Welsh, found this situation a little frustrating. He expressed his Cymric indignation to Mel Cohn, a visitor to the laboratory, who fortunately remembered reading the brief paper by Horwitz and his colleagues describing the use of dihalogeno-indolyl compounds as histological stains for  $\beta$ -galactosidase (Horwitz et al. 1964). Davies' next problem was to persuade the people at the Pasteur Institute to buy some X-gal. In those days, X-gal was not available commercially and custom synthesis cost 1000 dollars per gram. After much discussion, X-gal was ordered, synthesized, and delivered. In addition to being sensitive and nontoxic, X-gal turned out to be an extremely beautiful histochemical reagent that has generated gorgeous pictures of  $\beta$ -galactosidase expression in flora and fauna of all types.

In their original paper, Pearson et al. (1963) mentioned that the level of  $\beta$ -galactosidase activity in brain was low. This was hard for the people at the Pasteur Institute to understand, since in their mind, there was clearly a connection between  $\beta$ -galactosidase and intellect. When Jacques Monod first saw the brilliant blue color of induced bacterial colonies, he commented that this was proof that *E. coli* was the most intelligent organism in the world.

In eukaryotic organisms, the histochemical reaction for  $\beta$ -galactosidase is carried out on cryosections (Goring et al. 1987), on cultured cells and tissue sections fixed with buffered aldehyde (Sanes et al. 1986) or unbuffered formaldehyde (Login et al. 1987), or on sections fixed with glutaraldehyde in a microwave oven (Murti and Schimenti 1991). Since  $\beta$ -galactosidase is a cytosolic enzyme, staining is sometimes difficult to see in eukaryotic cells such as lymphocytes that contain very little cytoplasm. This problem can be eliminated by using a modified form of  $\beta$ -galactosidase (Bonnerot et al. 1987) that carries an amino-terminal nuclear transport signal (PKKKRKV) derived from SV40 large T antigen. The modified enzyme migrates to a perinuclear location and accumulates near nuclear pores. The resulting concentration of histochemical staining improves the sensitivity of detection of  $\beta$ -galactosidase and allows the enzyme to be precisely localized in complex tissues.

**TABLE 17-4 Heterologous Expression of  $\beta$ -galactosidase**

ORGANISM	ORIGINAL REFERENCE
Bacteria	Davies and Jacob (1968)
Yeast	Guarente and Ptashne (1981)
<i>Drosophila</i>	Lis et al. (1983)
Mammalian cells in culture	Hall et al. (1983)
Transgenic mice	Goring et al. (1987). <i>lacZ</i> had previously been used as a reporter in a recombinant retrovirus that had been injected into mouse embryos (Sanes et al. 1986).

## REFERENCES

- Ackland-Berglund C.E. and Lieb D.A. 1995. The efficacy of tetracycline-controlled gene expression is influenced by cell type. *BioTechniques* **18**: 196–200.
- Adamson P., Paterson H.F., and Hall A. 1992. Intracellular localization of the P21<sup>hho</sup> proteins. *J. Cell Biol.* **119**: 617–627.
- Alam J. and Cook J.L. 1990. Reporter genes: Application to the study of mammalian gene transcription. *Anal. Biochem.* **188**: 245–254.
- Albers K. and Fuchs E. 1987. The expression of mutant epidermal keratins cDNAs transfected in simple epithelial and squamous cell carcinoma lines. *J. Cell Biol.* **105**: 791–806.
- Amsterdam A., Lin S., and Hopkins N. 1995. The *Aequorea victoria* green fluorescent protein can be used as a reporter in live zebra fish embryos. *Dev. Biol.* **171**: 123–129.
- Anand R., Bason L., Saedi M.S., Gerzanich V., Peng X., and Lindstrom J. 1993. Reporter epitopes: A novel approach to examine transmembrane topology of integral membrane proteins applied to the alpha 1 subunit of the nicotinic acetylcholine receptor. *Biochemistry* **32**: 9975–9984.
- Angers S., Salahpour A., Joly E., Hilairat S., Chelsky D., Dennis M., and Bouvier M. 2000. Detection of  $\beta_2$ -adrenergic receptor dimerization in living cells using bioluminescence resonance energy transfer (BRET). *Proc. Natl. Acad. Sci.* **97**: 3684–3689.
- Araki E., Shimada F., Shichiri M., Mori M., and Ebina Y. 1988. pSV00CAT low background CAT plasmid. *Nucleic Acids Res.* **16**: 1627.
- Ayres M.D., Howard S.C., Kuzio J., Lopez-Ferber M., and Possee R.D. 1994. The complete DNA sequence of *Autographa californica* nuclear polyhedrosis virus. *Virology* **202**: 586–605.
- Backman K. and Boyer H.W. 1983. Tetracycline resistance in *Escherichia coli* is mediated by one polypeptide. *Gene* **26**: 197–203.
- Bahler J., Wu J.Q., Longtine M.S., Shah N.G., McKenzie III, A., Steever A.B., Wach A., Philippsen P., and Pringle J.R. 1998. Heterologous modules for efficient and versatile PCR-based gene targeting in *Schizosaccharomyces pombe*. *Yeast* **14**: 943–951.
- Baron U., Schnappinger D., Helbl V., Gossen M., Hillen W., and Bujard H. 1999. Generation of conditional mutants in higher eukaryotes by switching between the expression of two genes. *Proc. Natl. Acad. Sci.* **96**: 1013–1018.
- Barthmaier P. and Fyrberg F. 1995. Monitoring development and pathology of *Drosophila* indirect flight muscles using green fluorescent protein. *Dev. Biol.* **169**: 770–774.
- Beale E.G., Deeb E.A., Handley R.S., Akhavan-Tafti H., and Schaap A.P. 1992. A rapid and simple chemiluminescent assay for *Escherichia coli*  $\beta$ -galactosidase. *BioTechniques* **12**: 320–323.
- Belli G., Garí E., Aldea M., and Herrero E. 1998. Functional analysis of yeast essential genes using a promoter-substitution cassette and the tetracycline-regulatable dual expression system. *Yeast* **14**: 1127–1138.
- Bentley D.L. and Groudine M. 1986. A block to elongation is largely responsible for decreased transcription of *c-myc* in differentiated HL60 cells. *Nature* **321**: 702–706.
- Bergold G.H. 1947. Die Isolierung des polyeder-virus und die natur der polyeder. *Z. Naturforsch. Teil B* **2b**: 122–143.
- Bernardi A., Gaillard C., and Bernardi G. 1975. The specificity of five DNAases as studied by the analysis of 5'-terminal doublets. *Eur. J. Biochem.* **52**: 451–457.
- Bétermier M., Alazard R., Lefrère V., and Chandler M. 1989. Functional domains of bacteriophage Mu transposase: Properties of C-terminal deletions. *Mol. Microbiol.* **3**: 1159–1171.
- Bignon C., Daniel D., and Djiane J. 1993.  $\beta$ -Galactosidase and chloramphenicol acetyltransferase assays in 96-well plates. *BioTechniques* **15**: 243–245.
- Birnbaum M.J., Clem R.J., and Miller L.K. 1994. An apoptosis-inhibiting gene from a nuclear polyhedrosis virus a polypeptide with Cys/His sequence motifs. *J. Virol.* **68**: 2521–2528.
- Bonnerot C., Rocancourt D., Briand P., Grimber G., and Nicolas J.-F. 1987. A  $\beta$ -galactosidase hybrid protein targeted to nuclei as a marker for developmental studies. *Proc. Natl. Acad. Sci.* **84**: 6795–6799.
- Brasier A.R., Tate J.E., and Habener J.F. 1989. Optimized use of firefly luciferase assay as a reporter gene in mammalian cell lines. *BioTechniques* **7**: 1116–1122.
- Brejč K., Sixma T.K., Kitts P.A., Kain S.R., Tsien, R.Y., Ormo M., and Remington S.J. 1997. Structural basis for dual excitation and photoisomerization of the *Aequorea victoria* green fluorescent protein. *Proc. Natl. Acad. Sci.* **94**: 2306–2311.
- Brickman E., Silhavy T.J., Bassford Jr., P.J., Shuman H.A., and Beckwith J.R. 1979. Sites within gene *lacZ* of *Escherichia coli* for formation of active hybrid  $\beta$ -galactosidase molecules. *J. Bacteriol.* **139**: 13–18.
- Briggs M.R., Yokoyama C., Wang X., Brown M.S., and Goldstein J.L. 1993. Nuclear protein that binds sterol regulatory element of low density lipoprotein receptor promoter. I. Identification of the protein and delineation of its target nucleotide sequence. *J. Biol. Chem.* **268**: 14490–14496.
- Bronstein I., Fortin J., Stanley P.E., Stewart G.S.A.B., and Kricka L.J. 1994. Chemiluminescent and bioluminescent reporter gene assays. *Anal. Biochem.* **219**: 169–181.
- Brown M., Crawford A.M., and Faulkner P. 1979. Genetic analysis of a baculovirus *Autographa californica* nuclear polyhedrosis virus. I. Isolation of temperature sensitive mutants and assortment into complementation groups. *J. Virol.* **31**: 190–198.
- Burstone M. 1962. *Enzyme histochemistry, and its applications in the study of neoplasms*, p. 304. Academic Press, New York.
- Calonge M.J. and Massagué J. 1999. *Smad4/DPCA* silencing and hyperactive Ras jointly disrupt transforming growth factor- $\beta$  antiproliferative responses in colon cancer cells. *J. Biol. Chem.* **274**: 33637–33643.
- Cann J.R. 1989. Phenomenological theory of gel electrophoresis of protein-nucleic acid complexes. *J. Biol. Chem.* **264**: 17032–17040.
- Carey J. 1988. Gel retardation at low pH resolves *trp*-repressor-DNA complexes for quantitative study. *Proc. Natl. Acad. Sci.* **85**: 975–979.
- . 1991. Gel retardation. *Methods Enzymol.* **208**: 103–117.
- Carson D.D., Guarino L.A., and Summers M.D. 1988. Functional mapping of an AcNPV immediately early gene which augments expression of the IE-1 trans-activated 39k gene. *Virology* **162**: 444–451.
- Carstens E.B., Tjia S.T., and Doerfler W. 1979. Infection of *Spodoptera frugiperda* cells with *Autographa californica* nuclear polyhedrosis virus. I. Synthesis of intracellular proteins after virus infection. *Virology* **99**: 386–398.

- Carthew R.W., Chodosh L.A., and Sharp P.A. 1985. An RNA polymerase II transcription factor binds to an upstream element in the adenovirus major late promoter. *Cell* **43**: 439–448.
- Cavard D., Crozel V., Gorvel J.-P., Pattus F., Batty D., and Lazdunski C. 1986. A molecular, genetic and immunological approach to the functioning of colicin A, a pore-forming protein. *J. Mol. Biol.* **187**: 1152–1156.
- Chalfie M., Tu Y., Euskirchen G., Ward W.W., and Prasher D.C. 1994. Green fluorescent protein as a marker for gene expression. *Science* **263**: 802–805.
- Chiang C.M. and Roeder R.G. 1993. Expression and purification of general transcription factors by FLAG epitope-tagging and peptide elution. *Pept. Res.* **6**: 62–64.
- Chinnaiyan A.M., O'Rourke K., Tewari M., and Dixit V.M. 1995. FADD, a novel death domain-containing protein, interacts with the death domain of Fas and initiates apoptosis. *Cell* **81**: 505–512.
- Chiocchetti A., Tolosano E., Hirsch E., Silengo L., and Altruda F. 1997. Green fluorescent protein as a reporter of gene expression in transgenic mice. *Biochim. Biophys. Acta* **1352**: 193–202.
- Chiu W.L., Niwa Y., Zeng W., Hirano T., Kobayashi H., and Sheen J. 1996. Engineered GFP as a vital reporter in plants. *Curr. Biol.* **6**: 325–330.
- Chodosh L.A., Carthew R.W., and Sharp P.A. 1986. A single polypeptide possesses the binding and activities of the adenovirus major late transcription factor. *Mol. Cell. Biol.* **6**: 4723–4733.
- Chopra I. 1985. Mode of action of the tetracyclines and the nature of bacterial resistance to them. In *The tetracyclines* (ed. J.J. Hlavka and J.H. Boothe), pp. 317–392. Springer-Verlag, Berlin.
- Chopra I., Hawkey P.M., and Hinton M. 1992. Tetracyclines, molecular and clinical aspects. *J. Antimicrob. Chemother.* **29**: 245–277.
- Chow C.S. and Barton J.K. 1992. Transition metal complexes as probes of nucleic acids. *Methods Enzymol.* **212**: 219–242.
- Chow C.S., Behlen L.S., Uhlenbeck O.C., and Barton J.K. 1992. Recognition of tertiary structure in tRNAs by Rh(phen)<sub>2</sub>phi<sup>3+</sup>, a new reagent for RNA structure-function mapping. *Biochemistry* **31**: 972–982.
- Christopherson K.S., Mark M.R., Bajaj V., and Godowski P.J. 1992. Ecdysteroid-dependent regulation of genes in mammalian cells by a *Drosophila* ecdysone receptor and chimeric transactivators. *Proc. Natl. Acad. Sci.* **89**: 6314–6318.
- Chubet R.G. and Brizzard B.L. 1996. Vectors for expression and secretion of FLAG epitope-tagged proteins in mammalian cells. *BioTechniques* **20**: 136–141.
- Church G.M. and Gilbert W. 1984. Genomic sequencing. *Proc. Natl. Acad. Sci.* **81**: 1991–1995.
- Clackson T. 1997. Controlling mammalian gene expression with small molecules. *Curr. Opin. Chem. Biol.* **1**: 210–218.
- Clem R.J. and Miller L.K. 1993. Apoptosis reduces both the in vitro replication and the in vivo infectivity of a baculovirus. *J. Virol.* **67**: 3730–3738.
- Clem R.J., Fechtmeier M., and Miller L.K. 1991. Prevention of apoptosis by a baculovirus gene during infection of insect cells. *Science* **254**: 1388–1390.
- Cody C.W., Prasher D.C., Westler W.M., Prendergast F.G., and Ward W.W. 1993. Chemical structure of the hexapeptide chromophore of *Aequorea*. *Biochemistry* **32**: 1212–1218.
- Cole N.B., Smith C.L., Sciaky N., Terasaki M., Edidin M., and Lippincott-Schwartz J. 1996. Diffusional mobility of Golgi proteins in membranes of living cells. *Science* **273**: 797–801.
- Cormack B.P., Valdivia R.H., and Falkow S. 1996. FACS optimized mutants of the green fluorescent protein (GFP). *Gene* **173**: 33–38.
- Cormack B.P., Bertram G., Egerton M., Gow N.A., Falkow S., and Brown A.J. 1997. Yeast-enhanced green fluorescent protein (yEGFP) a reporter of gene expression in *Candida albicans*. *Microbiology* **143**: 303–311.
- Crabb D.W. and Dixon J.E. 1987. A method for increasing the sensitivity of chloramphenicol acetyltransferase assays in extracts of transfected mammalian cells. *Anal. Biochem.* **163**: 88–92.
- Cramer A., Whitehorn E.A., Tate E., and Stemmer W.P.C. 1996. Improved green fluorescent protein by molecular evolution using DNA shuffling. *Nat. Biotechnol.* **14**: 313–319.
- Cress W.D. and Triezenberg S.J. 1991. Critical structural elements of the VP16 transcriptional activation domain. *Science* **251**: 87–90.
- Crook N.E., Clem R.J., and Miller L.K. 1993. An apoptosis-inhibiting baculovirus gene with a zinc finger-like motif. *J. Virol.* **67**: 2168–2174.
- Cuello A.C., Galfré G., and Milstein C. 1979. Detection of substance P in the central nervous system by a monoclonal antibody. *Proc. Natl. Acad. Sci.* **76**: 3532–3536.
- Dahlberg A.E., Dingman C.W., and Peacock A.C. 1969. Electrophoretic characterization of bacterial polyribosomes in agarose-polyacrylamide composite gels. *J. Mol. Biol.* **41**: 139–147.
- Damke H., Gossen M., Freundlieb S., Bujard H., and Schmid S.L. 1995. Tightly regulated and inducible expression of dominant interfering dynamin mutant in stably transformed HeLa cells. *Methods Enzymol.* **257**: 209–220.
- Davie E.W. and Neurath H. 1955. Identification of a peptide released during autocatalytic activation of trypsinogen. *J. Biol. Chem.* **212**: 515–529.
- Davies J. and Jacob F. 1968. Genetic mapping of the regulator and operator genes of the *lac* operon. *J. Mol. Biol.* **36**: 413–417.
- Davis L.I. and Fink G.R. 1990. The NUP1 gene encodes an essential component of the yeast nuclear pore complex. *Cell* **61**: 965–978.
- Day R.N. 1998. Visualization of Pit-1 transcription factor interactions in the living cell nucleus by fluorescence resonance energy transfer microscopy. *Mol. Endocrinol.* **12**: 410–419.
- DeLuca M. and McElroy W.D. 1984. Two kinetically distinguishable ATP sites in firefly luciferase. *Biochem. Biophys. Res. Commun.* **123**: 764–770.
- Desbois C., Massé T., and Madjar J.-J. 1992. Optimization of the CAT assay procedure by determining the initial rate of the reaction. *Trends Genet.* **8**: 300–301.
- Deutschle U., Meyer W.K., and Thiesen H.J. 1995. Tetracycline-reversible silencing of eukaryotic promoters. *Mol. Cell. Biol.* **15**: 1907–1914.
- de Wet J.R., Wood K.V., Helinsky D.R., and DeLuca M. 1985. Cloning of firefly luciferase cDNA and the expression of active luciferase in *Escherichia coli*. *Proc. Natl. Acad. Sci.* **82**: 7870–7873.
- de Wet J.R., Wood K.V., DeLuca M., Helinsky D.R., and Subramani S. 1987. Firefly luciferase gene: Structure and expression in mammalian cells. *Mol. Cell. Biol.* **7**: 725–737.
- Dhawan J., Rando T.A., Elson S.L., Bujard H., and Blau H.M. 1995. Tetracycline-regulated gene expression following direct gene transfer into mouse skeletal muscle. *Somat. Cell Mol.*

- Genet.* **21**: 233–240.
- Diekmann S. 1987. Temperature and salt dependence of the migration anomaly of curved DNA fragments. *Nucleic Acids Res.* **15**: 247–265.
- Dignam J.D., Lebovitz R.M., and Roeder R.C. 1983. Accurate transcription initiation by RNA polymerase II in a soluble extract from isolated mammalian nuclei. *Nucleic Acids Res.* **11**: 1475–1489.
- Dukan S., Turlin E., Biville F., Bolbach G., Touati D., Tabet J.C., and Blais J.C. 1998. Coupling 2D SDS-PAGE with CNBr cleavage and MALDI-TOFMS: A strategy applied to the identification of proteins induced by a hypochlorous acid stress in *Escherichia coli*. *Anal. Chem.* **70**: 4433–4440.
- Dunderdale H.J., Benson F.E., Parsons C.A., Sharples G.I., Lloyd R.G., and West S.C. 1991. Formation and resolution of recombination intermediates by *E. coli* RecA and RuvC proteins. *Nature* **354**: 506–510.
- Dykes C.W., Bookless A.B., Coomber B.A., Noble S.A., Humber D.C., and Hobden A.N. 1988. Expression of atrial natriuretic factor as a cleavable fusion protein with chloramphenicol acetyltransferase in *Escherichia coli*. *Eur. J. Biochem.* **174**: 411–416.
- Dynan W.S. and Tjian R. 1983. The promoter-specific transcription factor Sp1 binds to upstream sequences in the SV40 early promoter. *Cell* **35**: 79–87.
- Eastman A. 1987. An improvement to the novel rapid assay for chloramphenicol acetyltransferase gene expression. *BioTechniques* **5**: 730–732.
- Eckert B. and Beck C.F. 1989. Topology of the transposon Tn10-encoded tetracycline resistance protein within the inner membrane of *Escherichia coli*. *J. Biol. Chem.* **264**: 11663–11670.
- Efrat S., Fusco-DeMane D., Lemberg H., Emran O.A., and Wang X. 1995. Conditional transformation of a pancreatic beta-cell line derived from transgenic mice expressing a tetracycline-regulated oncogene. *Proc. Natl. Acad. Sci.* **92**: 3576–3580.
- Ehrlich S.D., Bertazzoni U., and Bernardi G. 1973. The specificity of pancreatic deoxyribonuclease. *Eur. J. Biochem.* **40**: 143–147.
- Ernst W.J., Grabherr R.M., and Katinger H.W.D. 1994. Direct cloning into the *Autographica californica* nuclear polyhedrosis virus for generation of recombinant baculoviruses. *Nucleic Acids Res.* **22**: 2855–2856.
- Eustice D.C., Feldman P.A., Colberg-Poley A.M., Buckery R.M., and Neubauer R.H. 1991. A sensitive method for the detection of  $\beta$ -galactosidase in transfected mammalian cells. *BioTechniques* **11**: 739–742.
- Evan G.I., Lewis G.K., Ramsay G., and Bishop J.M. 1985. Isolation of monoclonal antibodies specific for human *c-myc* proto-oncogene product. *Mol. Cell. Biol.* **5**: 3610–3616.
- Ewald D., Li M., Efrat S., Auer G., Wall R.J., Furth P.A., and Hennighausen L. 1996. Time-sensitive reversal of hyperplasia in transgenic mice expressing SV40 T antigen. *Science* **273**: 1384–1386.
- Fenton H.J.H. 1894. Oxidation of tartaric acid in presence of iron. *J. Chem. Soc.* **65**: 899–910.
- Field J., Nikawa J., Broek D., MacDonald B., Rodgers L., Wilson I.A., Lerner R.A., and Wigler M. 1988. Purification of a RAS-responsive adenyl cyclase complex from *Saccharomyces cerevisiae* by use of an epitope addition method. *Mol. Cell. Biol.* **8**: 2159–2165.
- Finger F.P., Hughes T.E., and Novick P. 1998. Sec3p is a spatial landmark for polarized secretion in budding yeast. *Cell* **92**: 559–571.
- Fishman G.I., Kaplan M.L., and Buttrick P.M. 1994. Tetracycline-regulated cardiac gene expression *in vivo*. *J. Clin. Invest.* **93**: 1864–1868.
- Flach J., Bossie M., Vogel J., Corbett A., Jinks T., Willins D.A., and Silver P.A. 1994. A yeast RNA-binding protein shuttles between the nucleus and the cytoplasm. *Mol. Cell. Biol.* **14**: 8399–8407.
- Forrester W.C., Thompson C., Elder J.T., and Groudine M. 1986. A developmentally stable chromatin structure in the human  $\beta$ -globin gene cluster. *Proc. Natl. Acad. Sci.* **83**: 1359–1363.
- Forster K., Helbl V., Lederer T., Urlinger S., Wittenburg N., and Hillen W. 1999. Tetracycline-inducible expression systems with reduced basal activity in mammalian cells. *Nucleic Acids Res.* **27**: 708–710.
- Fowler A.V. and Zabin I. 1978. Amino acid sequence of  $\beta$ -galactosidase. XI. Peptide ordering procedures and the complete sequence. *J. Biol. Chem.* **253**: 5521–5525.
- . 1983. Purification, structure, and properties of hybrid  $\beta$ -galactosidase proteins. *J. Biol. Chem.* **258**: 14354–14358.
- Franklin T.J. 1967. Resistance of *Escherichia coli* to tetracyclines. Changes in permeability to tetracyclines in *Escherichia coli* bearing transposable resistance factors. *Biochem. J.* **105**: 371–378.
- Freundlieb S., Schirra-Müller C., and Bujard H. 1999. A tetracycline controlled activation/repression system with increased potential for gene transfer into mammalian cells. *J. Gene Med.* **1**: 4–12.
- Freundlieb S., Baron U., Bonin A., Gossen M., and Bujard H. 1997. Use of tetracycline-controlled gene expression systems to study mammalian cell cycle. *Methods Enzymol.* **283**: 159–172.
- Fried M.G. and Crothers D.M. 1981. Equilibria and kinetics of *lac* repressor-operator interactions by polyacrylamide gel electrophoresis. *Nucleic Acids Res.* **9**: 6505–6524.
- . 1983. CAP and RNA polymerase interactions with the *lac* promoter: Binding stoichiometry and long-range effects. *Nucleic Acids Res.* **11**: 141–158.
- . 1984a. Equilibrium studies of the cyclic AMP receptor protein-DNA interaction. *J. Mol. Biol.* **172**: 241–262.
- . 1984b. Kinetics and mechanism in the reaction of gene regulatory proteins with DNA. *J. Mol. Biol.* **172**: 263–282.
- Fulton R. and Van Ness B. 1993. Luminescent reporter gene assays for luciferase and  $\beta$ -galactosidase using a liquid scintillation counter. *BioTechniques* **14**: 762–763.
- Furth P.A., St. Onge L., Böger H., Gruss P., Gossen M., Kistner A., Bujard H., and Hennighausen L. 1994. Temporal control of gene expression in transgenic mice by a tetracycline-responsive promoter. *Proc. Natl. Acad. Sci.* **91**: 9302–9306.
- Galas D.J. and Schmitz A. 1978. DNase footprinting: A simple method for the detection of protein-DNA binding specificity. *Nucleic Acids Res.* **5**: 3157–3170.
- Gale E.F., Cundliffe E., Reynolds P.E., Richmond M.H., and Waring M.J. 1981. *The molecular basis of antibiotic action*, 2nd edition. Wiley, New York.
- Garabedian M.J., LaBauer J., Liu W.-H., and Thomas J.R. 1993. Analysis of protein-DNA interactions. In *Gene transcription: A practical approach* (ed. D. Rickwood and B.D. Hames), pp. 243–294. Oxford University Press, Oxford, United Kingdom.
- Gari E., Piedrafita L., Aldea M., and Herrero E. 1997. A set of vectors with a tetracycline-regulatable promoter system for modulated gene expression in *Saccharomyces cerevisiae*. *Yeast* **13**: 837–848.

- Garner M.M. and Revzin A. 1981. A gel electrophoresis method for quantifying the binding of proteins to specific DNA regions: Application to components of the *Escherichia coli* lactose operon regulatory system. *Nucleic Acids Res.* **9**: 3047–3060.
- Gatz C. 1995. Novel inducible/repressible gene expression systems. *Methods Cell Biol.* **50**: 411–424.
- Gatz C., Froberg C., and Wendenberg R. 1992. Stringent repression and homogeneous derepression by tetracycline of a modified CaMV 35S promoter in intact transgenic tobacco plants. *Plant J.* **2**: 397–404.
- Gatz C., Kaiser A., and Wendenberg R. 1991. Regulation of a modified CaMV 35S promoter by the Tn10-encoded Tet repressor in transgenic tobacco. *Mol. Gen. Genet.* **227**: 229–237.
- Gaynor R., Soultanakis E., Kuwabara M., Garcia J., and Sigman D.S. 1989. Specific binding of a HeLa cell nuclear protein to RNA sequences in the human immunodeficiency virus transactivating region. *Proc. Natl. Acad. Sci.* **86**: 4858–4863.
- Geli V., Baty D., and Lazdunski C. 1988. Use of a foreign epitope as a "tag" for the localization of minor proteins within a cell: The case of the immunity protein to colicin A. *Proc. Natl. Acad. Sci.* **85**: 689–693.
- Georgiev O., Bourquin J.P., Gstaiger M., Knoepfel L., Schaffner W., and Hovens C. 1996. Two versatile eukaryotic vectors permitting epitope tagging, radiolabelling and nuclear localisation of expressed proteins. *Gene* **168**: 165–167.
- Germino J., Gray J.G., Charbonneau H., Vanaman T., and Bastia D. 1983. Use of gene fusions and protein-protein interaction in the isolation of a biologically active regulatory protein: The replication initiator protein of plasmid R6K. *Proc. Natl. Acad. Sci.* **80**: 6848–6852.
- Gervais A., West D., Leoni L.M., Richman D.D., Wong-Staal F., and Corbeil J. 1997. A new reporter cell line to monitor HIV infection and drug susceptibility in vitro. *Proc. Natl. Acad. Sci.* **94**: 4653–4658.
- Gil J., Yamamoto H., Zapata J.M., Reed J.C., and Perucho M. 1999. Impairment of the proapoptotic activity of Bax by missense mutations found in gastrointestinal cancers. *Cancer Res.* **59**: 2034–2037.
- Girard F., Bello B., Laemmler U., and Gehring W.J. 1998. In vivo analysis of scaffold-associated regions in *Drosophila*: A synthetic high-affinity SAR binding protein suppresses position effect variegation. *EMBO J.* **17**: 2079–2085.
- Glocker B., Hoopers Jr., R.R., Hodges L., and Rohrmann G.F. 1993. In vitro transcription from baculovirus late gene promoters: Accurate mRNA initiation by nuclear extracts prepared from infected *Spodoptera frugiperda* cells. *J. Virol.* **67**: 3771–3776.
- Goodwin R., Vaughn J., Adams J., and Loulides S. 1970. Replication of a nuclear polyhedrosis virus in an established insect cell line. *J. Invertebr. Pathol.* **16**: 284–288.
- Gordon J.D. and Carstens E.B. 1984. Phenotypic characterization and physical mapping of a temperature sensitive mutant of *Autographa californica* nuclear polyhedrosis virus defective in DNA synthesis. *Virology* **138**: 69–81.
- Goring D.R., Rossant J., Clapoff S., Breitman M.L., and Tsui L.-C. 1987. In situ detection of  $\beta$ -galactosidase in lenses of transgenic mice with a  $\gamma$ -crystallin/*lacZ* gene. *Science* **235**: 456–458.
- Gorman C. 1985. High efficiency gene transfer into mammalian cells. In *DNA cloning: A practical approach* (ed. D. Glover), vol. 2, pp. 143–190. IRL Press, Oxford, United Kingdom.
- Gorman C.M., Moffat L.F., and Howard B.H. 1982. Recombinant genomes which express chloramphenicol acetyltransferase in mammalian cells. *Mol. Cell. Biol.* **2**: 1044–1051.
- Gossen M. and Bujard H. 1992. Tight control of gene expression in mammalian cells by tetracycline-responsive promoters. *Proc. Natl. Acad. Sci.* **89**: 5547–5551.
- . 1993. Anhydrotetracycline, a novel effector for tetracycline controlled gene expression systems in eukaryotic cells. *Nucleic Acids Res.* **21**: 4411–4412.
- . 1995. Efficacy of tetracycline controlled gene expression in influenced of cell type: Commentary. *BioTechniques* **19**: 213–215.
- Gossen M., Bonin A.L., and Bujard H. 1993. Control of gene activity in higher eukaryotic cells by prokaryotic regulatory elements. *Trends Biochem. Sci.* **18**: 471–475.
- Gossen M., Bonin A.L., Freundlieb S., and Bujard H. 1994. Inducible gene expression systems for higher eukaryotic cells. *Curr. Opin. Biotechnol.* **5**: 516–520.
- Gossen M., Freundlieb S., Bender G., Müller G., Hillen W., and Bujard H. 1995. Transcriptional activation by tetracyclines in mammalian cells. *Science* **268**: 1766–1769.
- Grace T.D.C. 1962. Establishment of four strains of cells from insect tissues grown *in vitro*. *Nature* **195**: 788–789.
- Groskreutz D. and Schenborn E.T. 1997. Reporter systems. *Methods Mol. Biol.* **63**: 11–30.
- Gross D.S. and Garrard W.T. 1988. Nuclease hypersensitive sites in chromatin. *Annu. Rev. Biochem.* **57**: 159–197.
- Grosveld F., van Assendelft G.B., Greaves D.R., and Kollias G. 1987. Position-independent, high-level expression of the human  $\beta$ -globin gene in transgenic mice. *Cell* **51**: 975–985.
- Groudine M., Peretz M., and Weintraub H. 1981. Transcriptional regulation of hemoglobin switching in chicken embryos. *Mol. Cell. Biol.* **1**: 281–288.
- Grula M.A., Buller P.L., and Weaver R.F. 1981.  $\alpha$ -Amanitin-resistant viral RNA synthesis in nuclei isolated from nuclear polyhedrosis virus-infected *Heliothis zea* larvae and *Spodoptera frugiperda* cells. *J. Virol.* **38**: 916–921.
- Grussenmeyer T., Scheidtmann K.H., Hutchinson M.A., Eckhart W., and Walter G. 1985. Complexes of polyoma virus medium T antigen and cellular proteins. *Proc. Natl. Acad. Sci.* **82**: 7952–7954.
- Guarente L. and Ptashne M. 1981. Fusion of *Escherichia coli lacZ* to the cytochrome *c* gene of *Saccharomyces cerevisiae*. *Proc. Natl. Acad. Sci.* **78**: 2199–2203.
- Guarino L.A. and Summers M.D. 1986. Interspersed homologous DNA of *Autographa californica* nuclear polyhedrosis virus enhances delayed-early gene expression. *J. Virol.* **60**: 215–223.
- Hall C.V., Jacob P.E., Ringold G.M., and Lee F. 1983. Expression and regulation of *Escherichia coli lacZ* gene fusions in mammalian cells. *J. Mol. Appl. Genet.* **2**: 101–109.
- Harlow E. and Lane D. 1988. *Antibodies: A laboratory manual*. Cold Spring Harbor Laboratory, Cold Spring Harbor, New York.
- Harlow E., Crawford L.V., Pim D.C., and Williamson N.M. 1981. Monoclonal antibodies specific for the SV40 tumor antigen. *J. Virol.* **39**: 861–869.
- Harrap K. 1970. Cell infection by a nuclear polyhedrosis virus. *Virology* **42**: 311–318.
- Harrap K. and Robertson L. 1968. A possible infection pathway in the development of a nuclear polyhedrosis virus. *J. Gen. Virol.* **3**: 221–225.
- Harvey D.M. and Caskey C.T. 1998. Inducible control of gene



- expression: Prospects for gene therapy. *Curr. Opin. Chem. Biol.* **2**: 512–518.
- Harvey E.N. 1952. *Bioluminescence*. Academic Press, New York.
- Haseloff J. and Amos B. 1995. GFP in plants (erratum *Trends Genet.* [1995] **11**: 374). *Trends Genet.* **11**: 328–329.
- Haseloff J., Dormand E.L., and Brand A.H. 1999. Live imaging with green fluorescent protein. *Methods Mol. Biol.* **122**: 241–259.
- Haseloff J., Siemering K.R., Prasher D.C., and Hodge S. 1997. Removal of a cryptic intron and subcellular localization of green fluorescent protein are required to mark transgenic *Arabidopsis* plants brightly. *Proc. Natl. Acad. Sci.* **94**: 2122–2127.
- Hatfield C., Duus K.M., Chen J., Jones D.H., and Grose C. 1997. Epitope mapping and tagging by recombination PCR mutagenesis (erratum *BioTechniques* [1999] **26**: 716). *BioTechniques* **22**: 332–337.
- Haupts U., Maiti S., Schwille P., and Webb W.W. 1998. Dynamics of fluorescence fluctuation in green fluorescent protein observed by fluorescence correlation spectroscopy. *Proc. Natl. Acad. Sci.* **95**: 13573–13578.
- Head J.F., Inouye S.I., Teranishi K., and Shimomura O. 2000. The crystal structure of the photoprotein aequorin at 2.3 Å resolution. *Nature* **405**: 372–376.
- Heard J.-M., Herbolm P., Ott M.-O., Mottura-Rollier A., Weiss M., and Yaniv M. 1987. Determinants of rat albumin promoter tissue specificity analyzed by an improved transient expression system. *Mol. Cell. Biol.* **7**: 2425–2434.
- Heim R. and Tsien R. 1996. Engineering green fluorescent protein for improved brightness, longer wavelengths and fluorescence resonance energy transfer. *Curr. Biol.* **6**: 178–182.
- Heim R., Cubitt A.B., and Tsien R.Y. 1995. Improved green fluorescence. *Nature* **373**: 663–664.
- Heim R., Prasher D.C., and Tsien R.Y. 1994. Wavelength mutations and posttranslational autooxidation of green fluorescent protein. *Proc. Natl. Acad. Sci.* **91**: 12501–12504.
- Heins L., Frohberg C., and Gatz C. 1992. The Tn10-encoded Tet repressor blocks early but not late steps of assembly of the RNA polymerase II initiation complex in vivo. *Mol. Gen. Genet.* **232**: 328–331.
- Helbl V., Berens C., and Hillen W. 1995. Proximity probing of Tet repressor to tet operator by dimethylsulfate reveals protected and accessible functions for each recognized base-pair in the major groove. *J. Mol. Biol.* **245**: 538–548.
- Hendrickson W. 1985. Protein-DNA interactions studied by the gel electrophoresis-DNA binding assay. *BioTechniques* **3**: 198–207.
- Hendrickson W. and Schleif R. 1985. A dimer of AraC protein contacts three adjacent major grooves of the araI DNA site. *Proc. Natl. Acad. Sci.* **82**: 3129–3133.
- Henner W.D., Grunberg S.M., and Haseltine W.A. 1982. Sites and structure of gamma radiation-induced DNA strand breaks. *J. Biol. Chem.* **257**: 11750–11754.
- Hertzberg R.P. and Dervan P.B. 1982. Cleavage of double helical DNA by methidiumpropyl-EDTA-iron(II). *J. Am. Chem. Soc.* **104**: 313–315.
- Hestrin S., Feingold D.S., and Schramm M. 1955. Hexoside hydrolases. *Methods Enzymol.* **1**: 231–257.
- Heuer C. and Hillen W. 1988. Tet repressor-tet operator contacts probed by operator DNA-modification interference studies. *J. Mol. Biol.* **202**: 407–415.
- Hickman R.K. and Levy S.B. 1988. Evidence that TET protein functions as a multimer in the inner membrane of *Escherichia coli*. *J. Bacteriol.* **170**: 1715–1720.
- Hill P.J., Rees C.E.D., Winson M.K., and Stewart G.S.A.B. 1993. The application of lux genes. *Biotechnol. Appl. Biochem.* **17**: 3–14.
- Hillen W. and Berens C. 1994. Mechanisms underlying expression of Tn10 encoded tetracycline resistance. *Annu. Rev. Microbiol.* **48**: 345–369.
- Hillen W., Schollmeier K., and Gatz C. 1984. Control of expression of the Tn10-encoded tetracycline resistance operon. II. Interaction of RNA polymerase and Tet repressor with the tet operon regulatory region. *J. Mol. Biol.* **172**: 185–201.
- Himes S.R. and Shannon M.F. 2000. Assays for transcriptional activity based on the luciferase reporter gene. *Methods Mol. Biol.* **130**: 165–174.
- Hink W.F. 1970. Established insect cell line from the cabbage looper, *Trichoplusia ni*. *Nature* **226**: 466–467.
- . 1972. Invertebrate tissue culture. In *A catalog of invertebrate cell lines* (ed. C. Vago), vol. 2, pp. 363–387. Academic Press, New York.
- Hinrichs W., Kisker C., Düvel M., Müller A., Tovar K., Hillen W., and Saenger W. 1994. Structure of the Tet repressor-tetracycline complex and regulation of antibiotic resistance. *Science* **264**: 418–420.
- Hochschild A. 1991. Detecting cooperative protein-DNA interactions and DNA loop formation by footprinting. *Methods Enzymol.* **208**: 343–361.
- Hoopes R.R. and Rohrmann G. F. 1991. In vitro transcription of baculovirus immediate early genes — Accurate messenger RNA initiation by nuclear extracts from both insect and human cells. *Proc. Natl. Acad. Sci.* **88**: 4513–4517.
- Hope I.A. and Struhl K. 1985. GCN4 protein, synthesized in vitro, binds HIS3 regulatory sequences: Implications for general control of amino acid biosynthetic genes in yeast. *Cell* **43**: 177–188.
- Hopp T.P., Prickett K.S., Price V.L., Libby R.T., March C.I., Cerretti D.P., Urdal D.L., and Conlon P.J. 1988. A short polypeptide marker sequence useful for recombinant protein identification and purification. *Bio/Technology* **6**: 1204–1210.
- Horwitz J.P., Chua J., Curby R.J., Tomson A.J., DaRooge M.A., Fisher B.E., Mauricio J., and Klundt I. 1964. Substrates for cytochemical demonstration of enzyme activity. I. Some substituted 3-indolyl-β-D-glycopyranosides. *J. Med. Chem.* **7**: 574–575.
- Hosfield T. and Lu Q. 1998. Versatile epitope tagging vector for gene expression in mammalian cells. *BioTechniques* **25**: 306–309.
- Howe J.R., Skryabin B.V., Belcher S.M., Zerillo C.A., and Schmauss C. 1995. The responsiveness of a tetracycline expression system differs in different cell lines. *J. Biol. Chem.* **270**: 14168–14174.
- Hsu H., Shu H.B., Pan M.G., and Goeddel D.V. 1996. TRADD-TRAF2 and TRADD-FADD interactions define two distinct TNF receptor 1 signal transduction pathways. *Cell* **84**: 299–308.
- Huang P., Wall D.B., Parus S., and Lubman D.M. 2000. On-line capillary liquid chromatography tandem mass spectrometry on an ion trap/reflectron time-of-flight mass spectrometer using the sequence tag database search approach for peptide sequencing and protein identification. *J. Am. Soc. Mass Spectrom.* **11**: 127–135.
- Hughes T. 1998. Heterologous expression of the green fluorescent protein. In *Cells: A laboratory manual: Light microscopy and cell structure* (ed. D.L. Spector et al.), vol. 2, pp. 78.1–78.8.

- Cold Spring Harbor Laboratory Press, Cold Spring Harbor, New York.
- Huh N.E. and Weaver R.F. 1990a. Categorizing some early and late transcripts directed by the *Autographa californica* nuclear polyhedrosis virus. *J. Gen. Virol.* **71**: 2195–2200.
- . 1990b. Identifying the RNA polymerases that synthesize specific transcripts of the *Autographa californica* nuclear polyhedrosis virus. *J. Gen. Virol.* **71**: 195–202.
- Ignoffo C. 1973. Development of a viral insecticide: Concept to commercialization. *Exp. Parasitol.* **33**: 380–406.
- . 1981. Living microbial insecticides. In *Essays in applied microbiology* (ed. J.R. Norris and M.H. Richmond), pp. 1–31. Wiley, New York.
- Ikawa M., Yamada S., Nakanishi T., and Okabe M. 1999. Green fluorescent protein (GFP) as a vital marker in mammals. *Curr. Top. Dev. Biol.* **44**: 1–20.
- Ikawa M., Kominami K., Yoshimura Y., Tanaka K., Nishimune Y., and Okabe M. 1995. A rapid and non-invasive selection of transgenic embryos before implantation using green fluorescent protein (GFP). *FEBS Lett.* **375**: 125–128.
- Inouye S. and Tsuji E.I. 1994. Evidence for redox forms of the *Aequorea* green fluorescent protein. *FEBS Lett.* **351**: 211–214.
- Jacobson R.H., Zhang X.-J., DuBose R.F., and Matthews B.W. 1994. Three-dimensional structure of  $\beta$ -galactosidase from *E. coli*. *Nature* **369**: 761–766.
- Jain V.K. and Magrath I.T. 1991. A chemiluminescent assay for quantitation of  $\beta$ -galactosidase in the femtogram range: Application to quantitation of  $\beta$ -galactosidase in *lacZ*-transfected cells. *Anal. Biochem.* **199**: 119–124.
- Jarvik J.W. and Telmer C.A. 1998. Epitope tagging. *Annu. Rev. Genet.* **32**: 601–618.
- Jarvis D.L., Oker-Blom C., and Summers M.D. 1990. Role of glycosylation in the transport of recombinant glycoproteins through the secretory pathway of lepidopteran insect cells. *J. Cell. Biochem.* **42**: 181–191.
- Jefferson R.A. 1987. Assaying chimeric genes in plants: The GUS gene fusion system. *Plant Mol. Biol. Rep.* **5**: 387–405.
- Jiricny J., Wu S.-S., Wood S.G., and Modrich P. 1988. Mismatch-containing oligonucleotide duplexes bound by the *E. coli* MutS protein. *Nucleic Acids Res.* **16**: 7843–7853.
- Jobe A. and Bourgeois S. 1972. *lac* repressor-operator interactions. VI. The natural inducer of the *lac* operon. *J. Mol. Biol.* **69**: 397–408.
- Johns D.C., Marx R., Mains R.E., O'Rourke B., and Marban E. 1999. Inducible genetic suppression of neuronal excitability. *J. Neurosci.* **19**: 1691–1697.
- Johnson F.H., Shimomura O., Saiga Y., Gershman L.C., Reynolds G.T., and Waters J.R. 1962. Quantum efficiency of cypridina luminescence, with a note on that of *Aequorea*. *J. Cell. Comp. Physiol.* **60**: 85–103.
- Kadonaga J.T. and Tjian R. 1986. Affinity-purification of sequence-specific DNA binding proteins. *Proc. Natl. Acad. Sci.* **83**: 5889–5893.
- Kalnins A., Otto K., R  ther U., and M  ller-Hill B. 1983. Sequence of the *lacZ* gene of *Escherichia coli*. *EMBO J.* **2**: 593–597.
- Kaneko M., Yamaguchi A., and Sawai T. 1985. Energetics of tetracycline efflux system coded by Tn10 in *Escherichia coli*. *FEBS Lett.* **193**: 194–198.
- Kang J.S. and Kim J.S. 2000. Zinc finger proteins as designer transcription factors. *J. Biol. Chem.* **275**: 8742–8748.
- Kim J., Zwieb C., Wu C., and Adhya S. 1989. Bending of DNA by gene regulatory proteins: Construction and use of a DNA bending vector. *Gene* **85**: 15–23.
- Kimball A.S., Kimball M.L., Jayaram M., and Tullius T.D. 1995. Chemical probe and missing nucleoside analysis of Flp recombinase bound to the recombination target sequence. *Nucleic Acids Res.* **23**: 3009–3017.
- King L.A. and Possee R.D. 1992. *The baculovirus expression system: A laboratory guide*. Chapman & Hall, London, United Kingdom.
- Kirchhoff S., K  ster M., Wirth M., Schaper E., Gossen M., Bujard H., and Hauser H. 1995. Identification of mammalian cell clones exhibiting highly-regulated expression from inducible promoters. *Trends Genet.* **11**: 219–220.
- Kisker C., Hinrichs W., Tovar K., Hillen W., and Saenger W. 1995. The complex formed between Tet repressor and tetracycline-Mg<sup>2+</sup> reveals mechanism of antibiotic resistance. *J. Mol. Biol.* **247**: 260–280.
- Kistner A., Gossen M., Zimmermann E., Jerecic J., Ullmer C., Lubbert H., and Bujard H. 1996. Doxycycline-mediated quantitative and tissue-specific control of gene expression in transgenic mice. *Proc. Natl. Acad. Sci.* **93**: 10933–10938.
- Kitts P.A. and Possee R.D. 1993. A method for producing recombinant baculovirus expression vectors at high frequency. *BioTechniques* **14**: 810–817.
- Kitts P.A., Ayres M.D., and Possee R.D. 1990. Linearization of baculovirus DNA enhances the recovery of recombinant expression vectors. *Nucleic Acids Res.* **18**: 5667–5672.
- Kleinschmidt C., Tovar K., Hillen W., and Poerschke D. 1988. Dynamics of repressor-operator recognition: The Tn10-encoded tetracycline resistance control. *Biochemistry* **27**: 1094–1104.
- Klimasauskas S., Kumar S., Roberts R.J., and Cheng X. 1994. Hhal methyltransferase flips its target base out of the DNA helix. *Cell* **76**: 357–369.
- Klug A., Wiswamitra M.A., Kenneard O., Shakked Z., and Steitz T.A. 1979. A hypothesis on a specific sequence-dependent conformation of DNA and its relation to the binding of the *lac* repressor protein. *J. Mol. Biol.* **131**: 669–680.
- Knott J.A., Sullivan C.A., and Weston A. 1988. The isolation and characterisation of human atrial natriuretic factor produced as a fusion protein in *Escherichia coli*. *Eur. J. Biochem.* **174**: 405–410.
- Kolodziej P. and Young R.A. 1989. RNA polymerase II subunit RPB3 is an essential component of the mRNA transcription apparatus. *Mol. Cell. Biol.* **9**: 5387–5394.
- Koo H.S. and Crothers D.M. 1988. Calibration of DNA curvature and a unified description of sequence-directed bending. *Proc. Natl. Acad. Sci.* **85**: 1763–1767.
- Kool M. and Vlcek J.M. 1993. The structural and functional organization of the *Autographa californica* nuclear polyhedrosis virus genome: An overview. *Arch. Virol.* **130**: 1–16.
- Kool M., Voeten J., Goldbach R.W., and Vlcek J.M. 1994. Functional mapping of regions of the *Autographa californica* nuclear polyhedrosis viral genome required for DNA replication. *Virology* **198**: 680–689.
- Kool M., van den Berg P.M., Tramper J., Goldbach R.W., and Vlcek J.M. 1993a. Location of two putative origins of DNA replication of *Autographa californica* nuclear polyhedrosis virus. *Virology* **192**: 94–101.
- Kool M., Voeten J., Goldbach R.W., Tramper J., and Vlcek J.M. 1993b. Identification of seven putative origins of *Autographa californica* multiple nucleocapsid nuclear polyhedrosis virus DNA replication. *J. Gen. Virol.* **74**: 2661–2668.
- Kost T.A. 1997. Expression systems: Gene expression systems in the genomics era. *Curr. Opin. Biotechnol.* **8**: 539–541.

- Kovacs G.R., Guarino L.A., and Summers M.D. 1991. Novel regulatory properties of the IE1 and IE0 transactivators encoded by the baculovirus *Autographa californica* multicapsid nuclear polyhedrosis virus. *J. Virol.* **65**: 5281–5288.
- Kozak M. 1984. Compilation and analysis of sequences upstream from the translational start site PG in eukaryotic mRNAs. *Nucleic Acids Res.* **12**: 857–872.
- . 1987. An analysis of 5'-noncoding sequences from 699 vertebrate messenger RNAs. *Nucleic Acids Res.* **15**: 8125–8148.
- Kreis T.E. 1986. Microinjected antibodies against the cytoplasmic domain of vesicular stomatitis virus glycoprotein block its transport to the cell surface. *EMBO J.* **5**: 931–941.
- Kristie T.M. and Roizman B. 1986.  $\alpha 4$ , The major regulatory protein of herpes simplex virus type 1, is stably and specifically associated with promoter-regulatory domains of  $\alpha$  genes and of selected other viral genes. *Proc. Natl. Acad. Sci.* **83**: 3218–3222.
- Kuwabara M.D. and Sigman D.S. 1987. Footprinting DNA-protein complexes in situ following gel retardation assays using 1,10-phenanthroline-copper ion: *Escherichia coli* RNA polymerase-*lac* promoter complexes. *Biochemistry* **26**: 7234–7238.
- Lakin N.D. 1993. Determination of DNA sequences that bind transcription factors by DNA footprinting. In *Transcription factors: A practical approach* (ed. D.S. Latchman et al.), pp. 27–46. Oxford University Press, Oxford, United Kingdom.
- Lane D., Prentki P., and Chandler M. 1992. Use of gel retardation to analyze protein-nucleic acid interactions. *Microbiol. Rev.* **56**: 509–528.
- Langner K.-D., Weyer U., and Doerfler W. 1986. *Trans* effect of the E1 region of adenoviruses on the expression of a prokaryotic gene in mammalian cells: Resistance to 5'-CCGG-3' methylation. *Proc. Natl. Acad. Sci.* **83**: 1598–1602.
- Lederberg J. 1950. The  $\beta$ -D-galactosidase of *Escherichia coli* strain K-12. *J. Bacteriol.* **60**: 381–392.
- Lederer T., Takahashi M., and Hillen W. 1995. Thermodynamic analysis of tetracycline-mediated induction of Tet repressor by a quantitative methylation protection assay. *Anal. Biochem.* **232**: 190–196.
- Lee H.H. and Miller L.K. 1978. Isolation of genotypic variants of *Autographa californica* nuclear polyhedrosis virus. *J. Virol.* **27**: 754–767.
- . 1979. Isolation, complementation, and initial characterization of temperature sensitive mutants of the baculovirus *Autographa californica* nuclear polyhedrosis virus. *J. Virol.* **31**: 240–252.
- Lee M.S., Henry M., and Silver P.A. 1996. A protein that shuttles between the nucleus and the cytoplasm is an important mediator of RNA export. *Genes Dev.* **10**: 1233–1246.
- Leffel S.M., Mabon S.A., and Stewart Jr., C.N. 1997. Applications of green fluorescent protein in plants. *BioTechniques* **23**: 912–918.
- Leslie A.G.W., Moody P.C.F., and Shaw W.V. 1988. Structure of chloramphenicol acetyltransferase at 1.75-Å resolution. *Proc. Natl. Acad. Sci.* **85**: 4133–4137.
- Lewin B. 1974. *Gene expression. II. Eucaryotic chromosomes*. Wiley, London, United Kingdom.
- Liang T.C., Luo W., Hsieh J.T., and Lin S.H. 1996. Antibody binding to a peptide but not the whole protein by recognition of the C-terminal carboxy group. *Arch. Biochem. Biophys.* **329**: 208–214.
- Lieberman P.M. and Berk A.J. 1991. The Zta *trans*-activator protein stabilizes TFIID association with promoter DNA by direct protein-protein interaction. *Genes Dev.* **5**: 2441–2454.
- Lim P.S., Jenson A.B., Cowser L., Nakai Y., Lim L.Y., Jin X.W., and Sundberg J.P. 1990. Distribution and specific identification of papillomavirus major capsid protein epitopes by immunocytochemistry and epitope scanning of synthetic peptides. *J. Infect. Dis.* **162**: 1263–1269.
- Lis J.T., Simon J.A., and Sutton C.A. 1983. New heat shock puffs and  $\beta$ -galactosidase activity resulting from transformation of *Drosophila* with an hsp70-*lacZ* hybrid gene. *Cell* **35**: 403–410.
- Login G.R., Schnitt S.J., and Dvorak A.M. 1987. Rapid microwave fixation of human tissues for light microscopic immunoperoxidase identification of diagnostically useful antigens. *Lab. Invest.* **57**: 585–591.
- Lomonosoff G.P., Butler P.J.G., and Klug A. 1981. Sequence-dependent structural variation in the conformation of DNA. *J. Mol. Biol.* **149**: 745–760.
- Longtine M.S., McKenzie III, A., Demarini D.J., Shah N.G., Wach A., Brachat A., Philippsen P., and Pringle J.R. 1998. Additional modules for versatile and economical PCR-based gene deletion and modification in *Saccharomyces cerevisiae*. *Yeast* **14**: 953–961.
- Lu A. and Carstens E.B. 1991. Nucleotide sequence of a gene essential for viral DNA replication in the baculovirus *Autographa californica* nuclear polyhedrosis virus. *Virology* **181**: 336–347.
- . 1993. Immediate-early baculovirus genes transactivate the p143 gene promoter of *Autographa californica* nuclear polyhedrosis virus. *Virology* **195**: 710–718.
- Lu A. and Miller L.K. 1994. Identification of three late expression factor genes within the 33.8 to 43.4-map-unit region of *Autographa californica* nuclear polyhedrosis virus. *J. Virol.* **68**: 6710–6718.
- . 1996. Generation of recombinant baculoviruses by direct cloning. *BioTechniques* **21**: 63–68.
- Luckow B. and Schütz G. 1987. CAT constructions with unique restriction sites for the functional analysis of eukaryotic promoters and regulatory elements. *Nucleic Acids Res.* **15**: 5490.
- Luckow V.A. 1993. Baculovirus systems for the expression of human gene products. *Curr. Opin. Biotechnol.* **4**: 564–572.
- Luo W., Liang T.C., Li J.M., Hsieh J.T., and Lin S.H. 1996. A universal tag for recombinant proteins. *Arch. Biochem. Biophys.* **329**: 215–220.
- Lutz-Freyermuth C., Query C.C., and Keene J.D. 1990. Quantitative determination that one of two potential RNA-binding domains of the A protein component of the U1 small nuclear ribonucleoprotein complex binds with high affinity to stem-loop II of U1 RNA. *Proc. Natl. Acad. Sci.* **87**: 6393–6397.
- Maeda S. 1989. Gene transfer vectors of a baculovirus, *Bombyx mori* nuclear polyhedrosis virus, and their use for expression of foreign genes in insect cells. In *Invertebrate cell system applications* (ed. J. Mitsuhashi), pp. 167–182. CRC Press, Boca Raton, Florida.
- Maeda S., Kawai T., Obinata M., Chika T., Horiuchi T., Maekawa K., Nakasuji K., Sacki T., Yamada K., and Furusawa M. 1984. Characteristics of human interferon- $\alpha$  produced by a gene transferred by a baculovirus in the silkworm, *Bombyx mori*. *Proc. Jpn. Acad.* **60**: 423–426.
- Mahajan N.P., Harrison-Shostak D.C., Michaux J., and Herman B. 1999. Novel mutant green fluorescent protein protease substrates reveal the activation of specific caspases during apoptosis. *Chem. Biol.* **6**: 401–409.
- Mahajan N.P., Linder K., Berry G., Gordon G.W., Heim R., and Herman B. 1998. Bcl-2 and Bax interactions in mitochondria probed with green fluorescent protein and fluorescence reso-

- nance energy transfer. *Nat. Biotechnol.* **16**: 547–552.
- Manley J.L., Fire A., Samuels M., and Sharp P.A. 1983. In vitro transcription: Whole cell extract. *Methods Enzymol.* **101**: 568–582.
- Marck C., Lefebvre O., Carles C., Riva M., Chaussivert N., Ruet A., and Sentenac A. 1993. The TFIIB-assembling subunit of yeast transcription factor TFIIC has both tetratricopeptide repeats and basic helix-loop-helix motifs. *Proc. Natl. Acad. Sci.* **90**: 4027–4031.
- Marini J.C., Levene S.D., Crothers D.M., and Englund P.T. 1983. A bent helix in kinetoplast DNA. *Cold Spring Harbor Symp. Quant. Biol.* **47**: 279–283.
- Marshall J., Molloy R., Moss G.W., Howe J.R., and Hughes T.E. 1995. The jellyfish green fluorescent protein: A new tool for studying ion channel expression and function. *Neuron* **14**: 211–215.
- Martignoni M.E. 1984. Baculovirus: An attractive biological alternative. In *Chemical and biological controls in forestry* (ed. W.Y. Garner and J. Harvey, Jr.), pp. 55–67. American Chemical Society, Washington, D.C.
- Martignoni M.E. and Iwai P.J. 1986. A catalog of viral diseases of insects, mites, and ticks, 4th edition (Forest Service, U.S. Department of Agriculture, Pacific Northwest Research Station, Portland, Oregon). *General Tech. Rep. PNW* **195**: 51.
- Martin C.S., Wight P.A., Dobretsova A., and Bronstein I. 1996. Dual luminescence-based reporter gene assay for luciferase and  $\beta$ -galactosidase. *BioTechniques* **21**: 520–524.
- Marzluff W.F. and Huang R.C.C. 1984. Transcription of RNA in isolated nuclei. In *Transcription and translation: A practical approach* (ed. B.D. Hames and S.J. Higgins), pp. 89–129. IRL Press, Oxford, United Kingdom.
- Matz M.V., Fradkov A.F., Labas Y.A., Savitsky A.P., Zaraisky A.G., Markelov M.K., and Lukyanov S.A. 1999. Fluorescent proteins from nonbioluminescent *Anthozoa* species. *Nat. Biotechnol.* **17**: 969–973.
- McCarroll L. and King L. 1997. Stable insect cultures for recombinant protein production. *Curr. Opin. Biotechnol.* **8**: 590–594.
- McCutchen B.E., Choudary P.V., Crenshaw R., Maddox D., Kamita S.G., Palekar N., Volrath S., Fowler E., Hammock B.D., and Maeda S. 1991. Development of a recombinant baculovirus expressing an insect-selective neurotoxin: Potential for pest control. *BioTechnology* **9**: 848–852.
- McKnight S.L. and Gavis E.R. 1980. Expression of the herpes simplex virus thymidine kinase gene in *Xenopus laevis* oocytes: An assay for the study of deletion mutants constructed in vitro. *Nucleic Acids Res.* **8**: 5931–5948.
- McKnight S.L. and Kingsbury R. 1982. Transcriptional control signals of a eukaryotic protein-coding gene. *Science* **217**: 316–325.
- McLachlin J.R. and Miller L.K. 1994. Identification and characterization of vlf-1, a baculovirus gene involved in very late gene expression. *J. Virol.* **68**: 7746–7756.
- McMurry L., Petrucci Jr., R.E., and Levy S.B. 1980. Active efflux of tetracycline encoded by four genetically different tetracycline resistance determinants in *Escherichia coli*. *Proc. Natl. Acad. Sci.* **77**: 3974–3977.
- Miller J.H. 1972. *Experiments in molecular genetics*. Cold Spring Harbor Laboratory, Cold Spring Harbor, New York.
- . 1992. Procedures for working with *lac*. In *A short course in bacterial genetics: A laboratory manual and handbook for E. coli and related bacteria*, pp. 71–80. Cold Spring Harbor Laboratory Press, Cold Spring Harbor, New York.
- Miller K. and Rizzino A. 1995. The function of inducible promoter systems in F9 embryonal carcinoma cells. *Exp. Cell Res.* **218**: 144–150.
- Miller L.K. 1981. Construction of a genetic map of the baculovirus *Autographa californica* nuclear polyhedrosis virus by marker rescue of temperature sensitive mutants. *J. Virol.* **39**: 973–976.
- . 1993. Baculoviruses: High expression in insect cells. *Curr. Opin. Genet. Dev.* **3**: 97–101.
- Miller L.K. and Dawes K.P. 1979. Physical map of the DNA genome of *Autographa californica* nuclear polyhedrosis virus. *J. Virol.* **29**: 1044–1045.
- Misteli T. and Spector D.L. 1997. Application of the green fluorescent protein in cell biology and biotechnology. *Nat. Biotechnol.* **15**: 961–964.
- Misteli T., Caceres J.E., and Spector D.L. 1997. The dynamics of a pre-mRNA splicing factor in living cells. *Nature* **387**: 523–527.
- Miyawaki A., Llopis J., Heim R., McCaffery J.M., Adams J.A., Ikura M., and Tsien R.Y. 1997. Fluorescent indicators for  $Ca^{2+}$  based on green fluorescent proteins and calmodulin. *Nature* **388**: 882–887.
- Morise H., Shimomura O., Johnson E.H., and Winant J. 1974. Intermolecular energy transfer in the bioluminescent system of *Aequorea*. *Biochemistry* **13**: 2656–2662.
- Morris T.D. and Miller L.K. 1994. Mutational analysis of a baculovirus major late promoter. *Gene* **140**: 147–153.
- Mueller P.R. and Wold B. 1989. In vivo footprinting of a muscle specific enhancer by ligation mediated PCR. *Science* **246**: 780–786.
- Müller-Hill B., Rickenberg H.V., and Wallenfels K. 1964. Specificity of induction of the enzymes of the *lac* operon in *Escherichia coli*. *J. Mol. Biol.* **10**: 303–308.
- Munro S. and Pelham H.R.B. 1984. Use of peptide tagging to detect proteins expressed from cloned genes: Deletion mapping of functional domains of *Drosophila* hsp 70. *EMBO J.* **3**: 3087–3093.
- . 1986. An Hsp70-like protein in the ER: Identity with the 78 kd glucose-regulated protein and immunoglobulin heavychain binding protein. *Cell* **46**: 291–300.
- . 1987. A C-terminal signal prevents secretion of luminal ER proteins. *Cell* **48**: 899–907.
- Murray I.A., Lewendon A., Williams J.A., Cullis P.M., Lashford A.G., and Shaw W.V. 1991. A novel substrate for assays of gene expression using chloramphenicol acetyltransferase. *Nucleic Acids Res.* **19**: 6648.
- Murti J.R. and Schimenti J.C. 1991. Microwave-accelerated fixation and *lacZ* activity staining of testicular cells in transgenic mice. *Anal. Biochem.* **198**: 92–96.
- Nabeshima K., Kurooka H., Takeuchi M., Kinoshita K., Nakaseko Y., and Yanagida M. 1995. p93dis1, which is required for sister chromatid separation, is a novel microtubule and spindle pole body-associated protein phosphorylated at the Cdc2 target sites. *Genes Dev.* **9**: 1572–1585.
- Nagai K. and Thøgersen H.C. 1987. Synthesis and sequence-specific proteolysis of hybrid proteins produced in *Escherichia coli*. *Methods Enzymol.* **153**: 461–481.
- Nakajima K. and Yaoita Y. 1997. Construction of multiple-epitope tag sequence by PCR for sensitive Western blot analysis. *Nucleic Acids Res.* **25**: 2231–2232.
- Naylor L.H. 1999. Reporter gene technology: The future looks bright. *Biochem. Pharmacol.* **58**: 749–757.
- Neumann J.R., Morency C.A., and Russian K.O. 1987. A novel

- rapid assay for chloramphenicol acetyltransferase gene expression. *BioTechniques* **5**: 444–448.
- Nguyen V.T., Morange M., and Bensaude O. 1988. Firefly luminescence assays using scintillation counters for quantitation in transfected mammalian cells. *Anal. Biochem.* **171**: 404–408.
- Niedenthal R.K., Riles L., Johnston M., and Hegemann J.H. 1996. Green fluorescent protein as a marker for gene expression and subcellular localization in budding yeast. *Yeast* **12**: 773–786.
- Nielsen D.A., Chang T.-C., and Shapiro D.J. 1989. A highly sensitive, mixed-phase assay for chloramphenicol acetyltransferase activity in transfected cells. *Anal. Biochem.* **179**: 19–23.
- Nielsen P.E., Jeppesen C., and Buchardt O. 1988. Uranyl salts as photochemical agents for the cleavage of DNA and probing of protein-DNA contacts. *FEBS Lett.* **235**: 122–124.
- Niman H.L., Houghten R.A., Walker L.E., Reisfeld R.A., Wilson I.A., Hogle J.M., and Lerner R.A. 1983. Generation of protein-reactive antibodies by short peptides is an event of high frequency: Implications for the structural basis of immune recognition. *Proc. Natl. Acad. Sci.* **80**: 4949–4953.
- No D., Yao T.-P., and Evans R.M. 1996. Ecdysone-inducible gene expression in mammalian cells and transgenic mice. *Proc. Natl. Acad. Sci.* **93**: 3346–3351.
- Nordheim A. and Meese K. 1988. Topoisomer gel retardation: Detection of anti-Z DNA antibodies bound to Z-DNA within supercoiled minicircles. *Nucleic Acids Res.* **16**: 21–37.
- Norton P. A. and Coffin J.M. 1985. Bacterial  $\beta$ -galactosidase as a marker of *Rous sarcoma* virus gene expression and replication. *Mol. Cell. Biol.* **5**: 281–290.
- Ogryzko V.V., Kotani T., Zhang X., Schlitz R.L., Howard T., Yang X.J., Howard B.H., Qin J., and Nakatani Y. 1998. Histone-like TAFs within the PCAF histone acetylase complex. *Cell* **94**: 35–44.
- Okabe M., Ikawa M., Kominami K., Nakanishi T., and Nishimune Y. 1997. 'Green mice' as a source of ubiquitous green cells. *FEBS Lett.* **407**: 313–319.
- Olson K.R., McIntosh, J.R., and Olmsted J.B. 1995. Analysis of MAP 4 function in living cells using green fluorescent protein (GFP) chimeras. *J. Cell Biol.* **130**: 639–650.
- Ooi B.G., Rankin C., and Miller L.K. 1989. Downstream sequences augment transcription from the essential initiation site of a baculovirus polyhedrin gene. *J. Mol. Biol.* **210**: 721–736.
- O'Reilly D.R. and Miller L.K. 1989. A baculovirus blocks insect molting by producing ecdysteroid UDP-glucosyl transferase. *Science* **245**: 1110–1112.
- . 1991. Improvement of a baculovirus pesticide by deletion of the egt gene. *Bio/Technology* **9**: 1086–1089.
- O'Reilly D.R., Miller L.K., and Luckow V.A. 1992. *Baculovirus expression vectors: A laboratory manual*. W.H. Freeman, New York.
- Ormo M., Cubitt A.B., Kallio K., Gross L.A., Tsien R.Y., and Remington S.J. 1996. Crystal structure of the *Aequorea victoria* green fluorescent protein. *Science* **273**: 1392–1395.
- Orth P., Schnappinger D., Hillen W., Saenger W., and Hinrichs W. 2000. Structural basis of gene regulation by the tetracycline inducible Tet repressor-operator system. *Nat. Struct. Biol.* **7**: 215–219.
- Orth P., Cordes F., Schnappinger D., Hillen W., Saenger W., and Hinrichs W. 1998. Conformational changes of the Tet repressor induced by tetracycline trapping. *J. Mol. Biol.* **279**: 439–447.
- Palm G., Zdanov A., Gaitanaris G.A., Stauber R., Pavlakis G.N., and Wlodawer A. 1997. The structural basis for spectral variations in green fluorescent protein. *Nat. Struct. Biol.* **4**: 361–365.
- Papavassiliou A.G. 1993. Localization of DNA-protein contact points by DMS resistance of complexes resolved in gel retardation assays. *Nucleic Acids Res.* **21**: 757–758.
- Pardee A.B., Jacob F., and Monod J. 1959. The genetic control and cytoplasmic expression of "inducibility" in the synthesis of  $\beta$ -galactosidase by *E. coli*. *J. Mol. Biol.* **1**: 165–178.
- Parsons C.A., Kemper B., and West S.C. 1990. Specificity of binding to four-way junctions in DNA by bacteriophage T7 endonuclease. *Nucleic Acids Res.* **18**: 4377–4384.
- Passarelli A.L., Todd J.W., and Miller L.K. 1994. A baculovirus gene involved in late gene expression predicts a 102 kDa polypeptide with a conserved motif of RNA polymerases. *J. Virol.* **68**: 4673–4678.
- Pearson B., Andrews M., and Grose F. 1961. Histochemical demonstration of mammalian glucosidase by means of 3-(5-bromoindolyl)- $\beta$ -D-glucopyranoside. *Proc. Soc. Exp. Biol. Med.* **108**: 619–623.
- Pearson B., Wolf P.L., and Vazquez J. 1963. A comparative study of a series of new indolyl compounds to localize  $\beta$ -galactosidase in tissues. *Lab. Invest.* **12**: 1249–1259.
- Pearson M., Bjornson R., Pearson G., and Rohrmann G. 1992. The *Autographa californica* baculovirus genome: Evidence for multiple replication origins. *Science* **257**: 1382–1384.
- Pelham H.R.B., Hardwick K.G., and Lewis M.J. 1988. Sorting of soluble ER proteins in yeast. *EMBO J.* **7**: 1757–1762.
- Pennock G.D., Shoemaker C., and Miller L.K. 1984. Strong and regulated expression of *Escherichia coli*  $\beta$ -galactosidase in insect cells with a baculovirus vector. *Mol. Cell. Biol.* **4**: 399–406.
- Pfeifer G.P. 1992. Analysis of chromatin structure by ligation-mediated PCR. *PCR Methods Appl.* **2**: 107–111.
- Pfeifer G.P., Steigerwald S.D., Mueller P.R., Wold B., and Riggs A.D. 1989. Genomic sequencing and methylation analysis by ligation mediated PCR. *Science* **246**: 810–813.
- Prasad V.R. and Goff S.P. 1989. Linker insertion mutagenesis of the human immunodeficiency virus reverse transcriptase expressed in bacteria: Definition of the minimal polymerase domain. *Proc. Natl. Acad. Sci.* **86**: 3104–3108.
- Prasher D.C., Eckenrode V.K., Ward W.W., Prendergast F.G., and Cormier M.J. 1992. Primary structure of the *Aequorea victoria* fluorescent green protein. *Gene* **111**: 229–233.
- Presley J.F., Cole N.B., Schroer T.A., Hirschberg K., Zaal K.J.M., and Lippencott-Schwartz J. 1997. ER-to-Golgi transport visualized in living cells. *Nature* **389**: 81–85.
- Price M.A. and Tullius T.D. 1992. Using hydroxyl radical to probe DNA structure. *Methods Enzymol.* **212**: 194–219.
- Prickett K.S., Amberg D.C., and Hopp T.P. 1989. A calcium-dependent antibody for identification and purification of recombinant proteins. *BioTechniques* **7**: 580–589.
- Qiu G. and Stavnezer J. 1998. Overexpression of BSAP/Pax-5 inhibits switching to IgA and enhances switching to IgE in the I.29  $\mu$  B cell line. *J. Immunol.* **161**: 2906–2918.
- Redfern C.H., Coward P., Degtyarev M.Y., Lee E.K., Kwa A.T., Hennighausen L., Bujard H., Fishman G.I., and Conklin B.R. 1999. Conditional expression and signaling of a specifically designed Gi-coupled receptor in transgenic mice. *Nat. Biotechnol.* **17**: 165–169.
- Reichel C., Mathur J., Eckes P., Langenkemper K., Koncz C., Schell J., Reiss B., and Maas C. 1996. Enhanced green fluorescence

- by the expression of an *Aequorea victoria* green fluorescent protein mutant in mono- and dicotyledonous plant cells. *Proc. Natl. Acad. Sci.* **93**: 5888–5893.
- Rice W.C. and Miller L.K. 1986. Baculovirus transcription in the presence of inhibitors and in nonpermissive *Drosophila* cells. *Virus Res.* **6**: 155–172.
- Rohrmann G.F. 1992. Baculovirus structural proteins. *J. Gen. Virol.* **73**: 749–761.
- Rose M. and Botstein D. 1983. Construction and use of gene fusions to *lacZ* ( $\beta$ -galactosidase) that are expressed in yeast. *Methods Enzymol.* **101**: 167–180.
- Rosenfeld P.J. and Kelly T.J. 1986. Purification of nuclear factor 1 by DNA recognition site affinity chromatography. *J. Biol. Chem.* **261**: 1398–1408.
- Rossi F.M. and Blau H.M. 1998. Recent advances in inducible gene expression systems. *Curr. Opin. Biotechnol.* **9**: 451–456.
- Rossi F.M., Guicherit O.M., Spicher A., Kringstein A.M., Fatyol K., Blakely B.T., and Blau H.M. 1998. Tetracycline-regulatable factors with distinct dimerization domain allow reversible growth inhibition by p16. *Nat. Genet.* **20**: 389–393.
- Ross-Macdonald P., Sheehan A., Roeder G.S., and Snyder M. 1997. A multipurpose transposon system for analyzing protein production, localization, and function in *Saccharomyces cerevisiae*. *Proc. Natl. Acad. Sci.* **94**: 190–195.
- Roth M. 1969. Fluorimetric assay of enzymes. *Methods Biochem. Anal.* **17**: 189–285.
- Russell S.R. 1996. Nuclear hormone receptors and the *Drosophila* ecdysone response. *Biochem. Soc. Symp.* **62**: 111–121.
- Rüther U. and Müller-Hill B. 1983. Easy identification of cDNA clones. *EMBO J.* **2**: 1791–1794.
- Sadowski I., Ma J., Triezenberg S., and Ptashne M. 1988. Gal4-VP16 is an unusually potent transcriptional activator. *Nature* **335**: 563–564.
- Saez E., No D., West A., and Evans R.M. 1997. Inducible gene expression in mammalian cells and transgenic mice. *Curr. Opin. Biotechnol.* **8**: 608–616.
- Sanes J.R., Rubenstein J.L.R., and Nicolas J.-F. 1986. Use of a recombinant retrovirus to study post-implantation cell lineage in mouse embryos. *EMBO J.* **5**: 3133–3142.
- Sankaran L. 1992. A simple quantitative assay for chloramphenicol acetyltransferase by direct extraction of the labeled product into scintillation cocktail. *Anal. Biochem.* **200**: 180–186.
- Sawadogo M. and Roeder R.G. 1985. Interaction of a gene-specific transcription factor with the adenovirus late promoter upstream of the TATA box region. *Cell* **43**: 165–175.
- Scheffler I.E., Elson E.L., and Baldwin R.L. 1968. Helix formation by dAT oligomers. I. Hairpin and straight-chain helices. *J. Mol. Biol.* **36**: 291–304.
- Scherer P.E., Tang Z., Chun M., Sargiacomo M., Lodish H.F., and Lisanti M.P. 1995. Caveolin isoforms differ in their N-terminal protein sequence and subcellular distribution. Identification and epitope mapping of an isoform-specific monoclonal antibody probe. *J. Biol. Chem.* **270**: 16395–16401.
- Schmitz A. and Galas D.G. 1979. The interaction of RNA polymerase and *lac* repressor with the *lac* control region. *Nucleic Acids Res.* **6**: 111–137.
- Schnappinger D., Schubert P., Pfeleiderer K., and Hillen W. 1998. Determinants of protein-protein recognition by four helix bundles: Changing the dimerization specificity of Tet repressor. *EMBO J.* **17**: 535–543.
- Schreiner U., Hansen J., Kuhn F.J., and Knopf C.W. 1999. A novel protein tag from herpes simplex virus type 1 DNA polymerase. *Intervirology* **42**: 17–21.
- Schultze N., Burki Y., Lang Y., Certa U., and Bluethmann H. 1996. Efficient control of gene expression by single-step integration of the tetracycline system in transgenic mice. *Nat. Biotechnol.* **14**: 499–503.
- Seed B. and Sheen J.Y. 1988. A simple phase extraction assay for chloramphenicol acetyltransferase. *Gene* **67**: 271–277.
- Sells M.A. and Chernoff J. 1995. Epitope-tag vectors for eukaryotic protein production. *Gene* **152**: 187–189.
- Shao Z., Raible F., Mollaaghababa R., Guyon J.R., Wu C.T., Bender W., and Kingston R.E. 1999. Stabilization of chromatin structure by PRC1, a Polycomb complex. *Cell* **98**: 37–46.
- Shaup H.W., Green M., and Kurland G.C. 1970. Molecular interactions of ribosomal components. I. Identification of RNA binding sites for individual 30S ribosomal proteins. *Mol. Gen. Genet.* **109**: 193–205.
- Shaw W.V. 1975. Chloramphenicol acetyltransferase from chloramphenicol-resistant bacteria. *Methods Enzymol.* **43**: 737–755.
- Shaw W.V., Day P., Lewendon A., and Murray I.A. 1988. Tinkering with antibiotic resistance: Chloramphenicol acetyltransferase and its substrates. *Biochem. Soc. Trans.* **16**: 939–942.
- Shimomura O. 1979. Structure of the chromophore of *Aequorea* green fluorescent protein. *FEBS Lett.* **104**: 220–222.
- Shimomura O., Johnson F.H., and Saiga Y. 1962. Extraction, purification and properties of aequorin, a bioluminescent protein from the luminous hydromedusa, *Aequorea*. *J. Cell. Comp. Physiol.* **59**: 223–239.
- Shockett P.E. and Schatz D.G. 1996. Diverse strategies for tetracycline-regulated inducible gene expression. *Proc. Natl. Acad. Sci.* **93**: 5173–5176.
- . 1997. Inducible gene expression using an autoregulatory tetracycline controlled system. In *Current protocols in molecular biology* (ed. F.A. Ausubel et al.), pp. 16.21.1–16.21.9. Wiley, New York.
- Shockett P.E., Difillippantonio M., Hellmann N., and Schatz D.G. 1995. A modified tetracycline-regulated system provides autoragulatory inducible gene expression in cultured cells and transgenic mice. *Proc. Natl. Acad. Sci.* **92**: 6522–6526.
- Siegel M.S. and Isacoff E.Y. 1997. A genetically encoded optical probe of membrane voltage. *Neuron* **19**: 735–741.
- Sigman D.S. and Chen C.B. 1990. Chemical nucleases: New reagents in molecular biology. *Annu. Rev. Biochem.* **59**: 207–236.
- Sigman D.S., Mazumder A., and Perrin D.M. 1993. Chemical nucleases. *Chem. Rev.* **93**: 2295–2316.
- Sigman D.S., Graham D.R., D'Aurora V., and Stern A.M. 1979. Oxygen-dependent cleavage of DNA by the 1,10-phenanthroline-cuprous complex. Inhibition of *Escherichia coli* DNA polymerase I. *J. Biol. Chem.* **254**: 12269–12272.
- Singh H., Sen R., Baltimore D., and Sharp P.A. 1986. A nuclear factor that binds to a conserved motif in transcriptional control elements of immunoglobulin genes. *Nature* **319**: 154–158.
- Sitlani A., Long E.C., Pyle A.M., and Barton J.K. 1992. DNA photocleavage by phenanthrenequinone diimine complexes of rhodium(III): Shape-selective recognition and reaction. *J. Am. Chem. Soc.* **114**: 2303–2312.
- Sledziewski A.Z., Bell A., Yip C., Kelsay K., Grant F.J., and MacKay V.L. 1990. Superimposition of temperature regulation on yeast promoters. *Methods Enzymol.* **185**: 351–366.
- Sleigh M.J. 1986. A nonchromatographic assay for expression of

- the chloramphenicol acetyltransferase gene in eukaryotic cells. *Anal. Biochem.* **156**: 251–256.
- Smith G.E. and Summers M.D. 1978. Analysis of baculovirus genomes with restriction endonucleases. *Virology* **89**: 517–527.
- . 1979. Restriction maps of five *Autographa californica* MNPV and *Galleria mellonella* MNPV DNAs with endonucleases *Sma*I, *KPN*I, *Bam*HI, *Sac*I, *Xho*I, and *Eco*RI. *J. Virol.* **30**: 828–838.
- Smith G.E., Summers M.D., and Fraser M.J. 1983. Production of human  $\beta$ -interferon in insect cells infected with a baculovirus expression vector. *Mol. Cell. Biol.* **3**: 2156–2165.
- Soldati T. and Perriard J.-C. 1991. Intracompartamental sorting of essential myosin light chains: Molecular dissection and in vivo monitoring by epitope tagging. *Cell* **66**: 277–289.
- Spassky A. and Sigman D.S. 1985. Nuclease activity of 1,10-phenanthroline-copper ion. Conformational analysis and footprinting of the *lac* operon. *Biochemistry* **24**: 8050–8056.
- Squinto S.P., Aldrich T.H., Lindsay R.M., Morrisset D.M., Panayotatos N., Bianco S.M., Furth M.E., and Yancopoulos G.D. 1990. Identification of functional receptors for ciliary neurotrophic factor on neuronal cell lines and primary neurons. *Neuron* **5**: 757–766.
- Srivastava R.A. and Schonfeld G. 1998. Measurements of rate of transcription in isolated nuclei by nuclear “run-off” assay. *Methods Mol. Biol.* **86**: 201–207.
- Stanley P.E. 1992. A survey of more than 90 commercially available luminometers and imaging devices for low-light measurements of chemiluminescence and bioluminescence, including instruments for manual, automated, and specialized operation, for HPLC, LC, GLC and microtitre plates. 1. Descriptions. *J. Biolumin. Chemilumin.* **7**: 77–108.
- Stewart L.M.D., Hirst M., Lopez Ferber M., Merryweather A.T., Cayley P.J., and Possee R.D. 1991. Construction of an improved baculovirus insecticide containing an insect-specific toxin gene. *Nature* **352**: 85–88.
- Stoltz D.B. and Summers M.D. 1972. Observations on the morphogenesis and structure of hemocytic poxvirus in the midgut *Chironomus attenuatus*. *J. Ultrastruct. Res.* **40**: 581–598.
- Strauss F. and Varshavsky A. 1984. A protein binds to a satellite DNA repeat at three specific sites that would be brought into mutual proximity by DNA folding in the nucleosome. *Cell* **37**: 889–901.
- Suck D. and Oefner C. 1986. Structure of DNase I at 2.0 Å resolution suggests a mechanism for binding to and cutting DNA. *Nature* **321**: 620–625.
- Suck D., Lahm A., and Oefner C. 1988. Structure refined to 2.0 Å of a nicked DNA octanucleotide complex with DNase I. *Nature* **332**: 464–468.
- Suck D., Oefner C., and Kabsch W. 1984. Three-dimensional structure of bovine pancreatic DNase I at 2.5 Å resolution. *EMBO J.* **3**: 2423–2430.
- Sugano S., Kim D.W., Yu Y.-S., Mizushima-Sugano J., Yoshimoto K., Watanabe S., Suzuki F., and Yamaguchi N. 1992. Use of an epitope-tagged cDNA library to isolate cDNAs encoding proteins with nuclear localization potential. *Gene* **120**: 2227–2233.
- Summers M.D. 1971. Electron microscopic observations on granulosis virus entry, uncoating and replication processes during infection of the midgut cells of *Trichoplusia ni*. *J. Ultrastruct. Res.* **35**: 606–625.
- Summers M.D. and Anderson D.L. 1972. Granulosis virus deoxyribonucleic acid: A closed double-stranded molecule. *J. Virol.* **9**: 710–713.
- . 1973. Characterization of nuclear polyhedrosis virus DNA. *J. Virol.* **12**: 1336–1346.
- Summers M., Engler R., Falcon L.A., and Vail P. 1975. *Baculoviruses for insect pest control: Safety considerations*. American Society for Microbiology, Washington, D.C.
- Swanson R.N., Conesa C., Lefebvre O., Carles C., Ruet A., Queemeneur E., Gagnon J., and Sentenac A. 1991. Isolation of TFC1, a gene encoding one of two DNA-binding subunits of yeast transcription factor tau (TFIIIC). *Proc. Natl. Acad. Sci.* **88**: 4887–4891.
- Tamura M., Gu J., Matsumoto K., Aota S., Parsons R., and Yamada K.M. 1998. Inhibition of cell migration, spreading, and focal adhesions by tumor suppressor PTEN. *Science* **280**: 1614–1617.
- Tanada Y. and Leutenegger R. 1968. Histopathology of a granulosis virus disease of the codling moth *Carpocapsa pomonella*. *J. Invertebr. Pathol.* **10**: 39–47.
- . 1970. Multiplication of a granulosis virus in larval midgut cells of *Trichoplusia ni* and possible pathways of invasion into the haemocoel. *J. Ultrastruct. Res.* **30**: 589–600.
- Thanassi D.G., Suh G.S.B., and Nikaido H. 1995. Role of outer membrane barrier in efflux-mediated tetracycline resistance of *Escherichia coli*. *J. Bacteriol.* **177**: 998–1007.
- Thompson J.F., Hayes L.S., and Lloyd D.B. 1991. Modulation of firefly luciferase stability and impact on study of gene regulation. *Gene* **103**: 171–177.
- Thummel C.S. 1997. Dueling orphans — Interacting nuclear receptors coordinate *Drosophila* metamorphosis. *BioEssays* **19**: 669–672.
- Todd J.W., Passarelli A.L., and Miller L.K. 1994. Eighteen baculovirus genes including *lef-11*, *p35*, *39k* and *p47* support late gene expression. *J. Virol.* **69**: 968–974.
- Tomalski M.D. and Miller L.K. 1991. Insect paralysis by baculovirus-mediated expression of a mite neurotoxin gene. *Nature* **352**: 82–85.
- . 1992. Expression of a paralytic neurotoxin gene to improve insect baculoviruses as biopesticides. *Bio/Technology* **10**: 545–549.
- Touchstone J.C. 1992. *Practice of thin layer chromatography*, 3rd edition. Wiley, New York.
- Townes T.M. and Behringer R.R. 1990. Human globin locus activation region (LAR): Role in temporal control. *Trends Genet.* **6**: 219–223.
- Toyota N., Uzawa H., and Shimada Y. 1998. Assembly of force-expressed troponin-I isoforms in myofibrils of cultured cardiac and fast skeletal muscle cells as studied by epitope tagging. *J. Muscle Res. Cell Motil.* **19**: 937–947.
- Triezenberg S.J., Kingsbury R.C., and McKnight S.L. 1988a. Functional dissection of VP16, the *trans*-activator of herpes simplex virus immediate early gene expression. *Genes Dev.* **2**: 718–729.
- Triezenberg S.J., LaMarco K.L., and McKnight S.L. 1988b. Evidence of DNA: Protein interactions that mediate HSV-1 immediate early gene activation by VP16. *Genes Dev.* **2**: 730–742.
- Tritton T.R. 1977. Ribosome-tetracycline interactions. *Biochemistry* **16**: 4133–4138.
- Tsai D.E., Kenan D.J., and Keene J.D. 1992. *In vitro* selection of an RNA epitope immunologically cross-reactive with a peptide. *Proc. Natl. Acad. Sci.* **89**: 8864–8868.
- Tsien R.Y. 1998. The green fluorescent protein. *Annu. Rev. Biochem.* **67**: 509–544.
- Tsien R.Y. and Miyawaki A. 1998. Seeing the machinery of live cells. *Science* **280**: 1954–1955.

- Tuan D., Solomon W., Li Q., and London I.M. 1985. The "β-like-globin" gene domain in human erythroid cells. *Proc. Natl. Acad. Sci.* **82**: 6384–6388.
- Tullius T.D. and Dombroski B.A. 1986. Hydroxyl radical "footprinting": High resolution information about DNA-protein contacts and application to lambda repressor and Cro protein. *Proc. Natl. Acad. Sci.* **83**: 5469–5473.
- Tullius T.D., Dombroski B.A., Churchill M.E.A., and Kam L. 1987. Hydroxyl radical footprinting: A high resolution method for mapping protein-DNA contacts. *Methods Enzymol.* **155**: 537–558.
- Ullmann A. 1984. One-step purification of hybrid proteins which have β-galactosidase activity. *Gene* **29**: 27–31.
- Ullmann A. and Perrin D. 1970. Complementation in β-galactosidase. In *The lactose operon* (ed. J.R. Beckwith and D. Zipser), pp. 143–172. Cold Spring Harbor Laboratory, Cold Spring Harbor, New York.
- Ullmann A., Jacob F., and Monod J. 1967. Characterization by in vitro complementation of a peptide corresponding to an operator-proximal segment of the β-galactosidase structural gene of *Escherichia coli*. *J. Mol. Biol.* **24**: 339–343.
- Umesono K. and Evans R.M. 1989. Determinants of target gene specificity for steroid/thyroid hormone receptors. *Cell* **57**: 1139–1146.
- Vail P.V., Sutter G., Jay D.L., and Gough D. 1971. Reciprocal infectivity of nuclear polyhedrosis viruses of the cabbage looper and alfalfa looper. *J. Invertebr. Pathol.* **17**: 383–388.
- Van Dyke M.W. and Dervan P.B. 1983. Methidiumpropyl-EDTA.FE(II) and DNase I footprinting report different small molecule binding sites on DNA. *Nucleic Acids Res.* **11**: 5555–5567.
- Wacker I., Kaether C., Kromer A., Migala A., Almers W., and Gerdes H.H. 1997. Microtubule-dependent transport of secretory vesicles visualized in real time with a GFP-tagged secretory protein. *J. Cell Sci.* **110**: 1453–1463.
- Wallrath L.L., Lu Q., Granock H., and Elgin S.C.R. 1994. Architectural variations of inducible promoters: Preset and remodeling chromatin structures. *BioEssays* **16**: 165–170.
- Wang L.F., Yu M., White J.R., and Eaton B.T. 1996. BTag: A novel six-residue epitope tag for surveillance and purification of recombinant proteins. *Gene* **169**: 53–58.
- Wang S. and Hazelrigg T. 1994. Implications for *bcd* mRNA localization from spatial distribution of *exu* protein in *Drosophila* oogenesis. *Nature* **369**: 400–403.
- Wang X., Briggs M.R., Hua X., Yokoyama C., Goldstein J.L., and Brown M.S. 1993. Nuclear protein that binds sterol regulatory element of low density lipoprotein receptor promoter. II. Purification and characterization. *J. Biol. Chem.* **268**: 14497–14504.
- Ward B., Skorobogaty A., and Dabrowiak J.C. 1986. DNA cleavage specificity of a group of cationic metalloporphyrins. *Biochemistry* **25**: 6875–6883.
- Ward W.W. and Bokman S.H. 1982. Reversible denaturation of *Aequorea* green fluorescent protein: Physical separation and characterization of the renatured protein. *Biochemistry* **21**: 4535–4550.
- Ward W.W., Cody C.W., Hart R.C., and Cormier M.J. 1980. Spectrophotometric identity of the energy transfer chromophores in *Renilla* and *Aequorea* green fluorescent proteins. *Photochem. Photobiol.* **31**: 611–615.
- Weinmann P., Gossen M., Hillen W., Bujard H., and Gatz C. 1994. A chimeric transactivator allows tetracycline-responsive gene expression in whole plants. *Plant J.* **5**: 559–569.
- Weintraub H. and Groudine M. 1976. Chromosome subunits in active genes have an altered conformation. *Science* **193**: 848–856.
- West A.H., Clark D.J., Martin J., Neupert W., Hartl F.-U., and Horwich A.L. 1992. Two related genes encoding extremely hydrophobic proteins suppress a lethal mutation in the yeast mitochondrial processing enhancing protein. *J. Biol. Chem.* **267**: 24625–24633.
- White K.P., Hurban P., Watanabe T., and Hogness D.S. 1997. Coordination of *Drosophila* metamorphosis by two ecdysone-induced nuclear receptors. *Science* **276**: 114–117.
- Wilson I.A., Niman H.L., Houghten R.A., Chersonson A.R., Connolly M.L., and Lerner R.A. 1984. The structure of an antigenic determinant in a protein. *Cell* **37**: 767–778.
- Wood K.V. 1991. The origin of beetle luciferases. In *Bioluminescence and chemiluminescence: Current status* (ed. P. Stanley and L. Kricka), pp. 11–14. Wiley, Chichester, United Kingdom.
- Wouters E.S. and Bastiaens P.I.H. 1999. Fluorescence lifetime imaging of receptor tyrosine kinase activity in cells. *Curr. Biol.* **9**: 1127–1130.
- Wu H.-M. and Crothers D.M. 1984. The locus of sequence-directed and protein-induced DNA binding. *Nature* **308**: 509–513.
- Wu S.-Y. and Chiang C.-M. 1996. Establishment of stable cell lines expressing potentially toxic proteins by tetracycline-regulated and epitope-tagging methods. *BioTechniques* **21**: 718–725.
- Xu L., Gonzalez-Agosti C., Beauchamp R., Pinney D., Sterner C., and Ramesh V. 1998. Analysis of molecular domains of epitope-tagged merlin isoforms in Cos-7 cells and primary rat Schwann cells. *Exp. Cell Res.* **238**: 231–240.
- Yamaguchi A., Udagawa T., and Sawai T. 1990. Transport of divalent cations with tetracycline as mediated by the transposon Tn10-encoded tetracycline resistance protein. *J. Biol. Chem.* **265**: 4809–4813.
- Yang C.L., Stetler D.A., and Weaver R.F. 1991. Structural comparison of the *Autographa californica* nuclear polyhedrosis virus-induced RNA polymerase and the three nuclear RNA polymerases from the host, *Spodoptera frugiperda*. *Virus Res.* **20**: 251–264.
- Yang F., Moss L.G., and Phillips G.N. 1996. The molecular structure of green fluorescent protein. *Nat. Biotechnol.* **14**: 1246–1251.
- Yao T.-P., Segreaves W.A., Oro A.E., McKeown M., and Evans R.M. 1992. *Drosophila ultraspiracle* modulates ecdysone receptor function via heterodimer formation. *Cell* **71**: 63–72.
- Yao T.-P., Forman B.M., Jiang Z., Cherbas L., Chen J.-D., McKeown M., Cherbas P., and Evans R.M. 1993. Functional ecdysone receptor is the product of *EcR* and *ultraspiracle* genes. *Nature* **366**: 476–479.
- Yee J.-K., Jolly D.J., Miller A.D., Willis R., Wolff J., and Friedman T. 1987. Epitope insertion into the human hypoxanthine phosphoribosyltransferase protein and detection of the mutant protein by an antipeptide antibody. *Gene* **53**: 97–104.
- Yeh E., Skibbens R.V., Cheng J.W., Salmon E.D., and Bloom K. 1995. Spindle dynamics and cell cycle regulation of dynein in the budding yeast *Saccharomyces cerevisiae*. *J. Cell Biol.* **130**: 687–700.
- Yin D.X., Zhu L., and Schimke R.T. 1996. Tetracycline-controlled gene expression system achieves high level and quantitative control of gene expression. *Anal. Biochem.* **235**: 195–201.
- Young D.C., Kingsley S.D., Ryan K.A. and Dutko F.J. 1993. Selective inactivation of eukaryotic β-galactosidase in assays for inhibitors of HIV-1 TAT using bacterial β-galactosidase



- as a reporter enzyme. *Anal. Biochem.* **215**: 24–30.
- Young S.L., Barbera L., Kaynard A.H., Haugland R.P., Kang H.C., Brinkley M., and Melner M.H. 1991. A nonradioactive assay for transfected chloramphenicol acetyltransferase activity using fluorescent substrates. *Anal. Biochem.* **197**: 401–407.
- Youngman P. 1987. Plasmid vectors for recovering and exploiting TN917 transpositions in *Bacillus* and other gram-positive bacteria. In *Plasmids: A practical approach* (ed. K.G. Hardy), pp. 79–103. IRL Press, Oxford, United Kingdom.
- Zaret K. 1997. Editorial. *Methods* **11**: 149–150.
- Zeidler M., Gatz C., Hartmann E., and Hughes J. 1996. Tetracycline-regulated reporter gene expression in the moss *Physcomitrella patens*. *Plant Mol. Biol.* **30**: 199–205.
- Zhuo L., Sun B., Zhang C.L., Fine A., Chiu S.Y., and Messing A. 1997. Live astrocytes visualized by green fluorescent protein in transgenic mice. *Dev. Biol.* **187**: 36–42.
- Zolotkin S.M., Potter W.W., Hauswirth J.G., and Muzyczka N. 1996. A “humanized” green fluorescent protein cDNA adapted for high level expression in mammalian cells. *J. Virol.* **70**: 4646–4654.

# Chapter 18

## Protein Interaction Technologies

Erica A. Golemis, Peter D. Adams, Philippe I.H. Bastiaens, Margret B. Einarson, Robert J. Fisher, Alisa G. Harpur, Maxine V. Medaglia, Michael Ohh, Ilya Serebriiskii

### INTRODUCTION

### PROTOCOLS

- 1 Two-hybrid and Other Two-component Systems 18.6
  - Stage 1: Characterization of a Bait-LexA Fusion Protein 18.17
    - Alternative Protocol: Assay of  $\beta$ -galactosidase Activity by Chloroform Overlay 18.28
  - Stage 2: Selecting an Interactor 18.30
  - Stage 3: Second Confirmation of Positive Interactions 18.38
    - Alternative Protocol: Rapid Screen for Interaction Trap Positives 18.46
- 2 Detection of Protein-Protein Interactions Using Far Western with GST Fusion Proteins 18.48
  - Additional Protocol: Refolding of Membrane-bound Proteins 18.53
  - Alternative Protocol: Detection of Protein-Protein Interactions with Anti-GST Antibodies 18.54
- 3 Detection of Protein-Protein Interactions Using the GST Fusion Protein Pulldown Technique 18.55
- 4 Identification of Associated Proteins by Coimmunoprecipitation 18.60
- 5 Probing Protein Interactions Using GFP and Fluorescence Resonance Energy Transfer 18.69
  - Stage 1: Labeling Proteins with Fluorescent Dyes 18.80
  - Stage 2: Cell Preparation for FLIM-FRET Analysis 18.84
    - Alternative Protocol: Preparation of Fixed Cells for FLIM-FRET Analysis 18.87
    - Alternative Protocol: Microinjection of Live Cells 18.88
  - Stage 3: FLIM-FRET Measurements 18.90
- 6 Analysis of Interacting Proteins with Surface Plasmon Resonance Spectroscopy Using BIAcore 18.96
  - Stage 1: Preparation of the Capture Surface and Test Binding 18.104
  - Stage 2: Kinetic Analysis of the Antibody-Antigen Interaction 18.108

### INFORMATION PANELS

- Filamentous Phage Display 18.115
- Genomics and the Interaction Trap 18.123
- Interaction Trap and Related Technologies 18.125

THE PRIMARY GOAL OF THIS MANUAL HAS BEEN THE DESCRIPTION OF METHODS to identify and manipulate nucleic acids. In Chapters 15, 16, and 17, the focus broadened to address the proteins encoded by nucleic acids of interest and detailed means to express these proteins in bacteria and a variety of eukaryotic host organisms. This chapter provides an introduction to a number of current methodologies that are used to begin to understand the interactions of proteins.

Different biological subdisciplines ask distinct questions about protein-protein interactions. Broadly defined, much of the current effort directed at the study of proteins can be divided into four subcategories:

- **Biochemical and structural studies** of protein interactions with other proteins or small ligands.
- **Mechanistic studies** that delve into the networks of protein interaction that mediate signal transduction, the cell cycle, and gene expression.
- **Genetic studies**, in which evidence bearing on protein interactions is initially inferred from patterns of genetic interference or epistasis.
- **Cell biological studies**, which are frequently focused on localization and colocalization of proteins in dynamically reorganizing cells.

Within these biological contexts, many discrete questions may be posed about the interactions of any one protein. For example, does the protein function alone, as part of a small complex (e.g., dimerically), or as part of a large assembly? Would the protein be likely to associate with high affinity with a single partner molecule or would any interactions involve multiple lower-affinity contacts across a broader surface? Does the protein utilize a canonical and separable domain for interaction with a defined motif on a partner protein? If so, how is specificity for partner proteins conferred and how are nonspecific interactions with other proteins containing similar motifs suppressed? Is the protein subject to transient interactions, such as might occur between particular kinases or other modifying enzymes and substrates? Do modifications such as phosphorylation and glycosylation affect interactions of the protein and other partner molecules? Do protein interactions regulate the catalytic function or substrate specificity of proteins with enzymatic activity? Do mutations that affect protein interactions, whether naturally occurring or experimentally induced, have clear measurable biological effects? Can therapeutic agents be developed that specifically modulate protein-protein interactions? Do two proteins of predicted common function colocalize in such a way as to enable direct interactions? Does the affinity of a protein-protein interaction measured *in vitro* reflect the strength of the interaction *in vivo*? If a protein interacts simultaneously with multiple partners, are the interactions competitive, additive, or synergistic? How does one begin to identify such arrays of partners?

These and other questions devolve into several discrete classes of inquiry. In one class, the goal is to identify every possible interacting set of proteins for the protein of interest. In this case, physiological significance is temporarily downplayed in an effort to cast a broad net. In the second class, where interacting proteins of interest have been defined, the goal is to establish physiological significance by detailing the biological function and impact of their interactions. In this case, it is essential to study the interaction under conditions that correspond as closely as possible to the endogenous situation. In the third class, an interaction has been identified, and validated as physiological, and is reasonably well understood. Here, the goal is to devise high-throughput methodologies to identify agents that modulate the interaction in desirable ways. No single technique is optimal to address all of the questions or classes of interest; however, by com-

binning experimental approaches, it is possible to make considerable progress. The techniques presented here bear on all three described classes.

A complete review of the origins and nature of methods to analyze and characterize protein interactions is beyond the scope of this chapter. An excellent list of references has been compiled by Phizicky and Fields (1995), along with an extensive discussion of parameters that can be crucial in choosing a specific technique to detect particular protein interactions. In addition, space does not allow presentation of all available interaction techniques. Thus, for example, traditional biochemical copurification methodologies have been omitted. One more recently developed approach, omitted here but worth considering for some applications, is the use of mass spectrometry. This technique has been used with recent striking success in large-scale biochemical applications, identifying constituents of large complexes composed of multiple proteins that associate to perform a specific function or group of functions. For useful introductions to this method, please see Kuster and Mann (1998), Rigaut et al. (1999), and Yates (2000). Another field with direct relevance to protein interactions is that of molecular modeling, which combines information about protein domains, patterns of evolutionary conservation, and structural coordination to predict interaction patterns. For discussions of modeling approaches, please see Aitken (1999), Enright et al. (1999), and Marcotte et al. (1999).

This chapter focuses on a number of basic techniques that have gained wide acceptance and are amenable to use by individual investigators focused on the study of specific proteins.

- Bacterially expressed glutathione *S*-transferase (GST)-fused proteins are used to perform direct measure of protein-protein interactions and for affinity purification. Far western analysis (Blackwood and Eisenman 1991; Kaelin et al. 1992), in which a labeled protein probe is used to probe for interactions with defined or library-encoded proteins immobilized on a membrane, is an offshoot of conventional western analyses. The GST pulldown (Kaelin et al. 1991) is a related technique in which either (1) a single defined in-vitro-expressed protein, (2) an unknown protein present in a pool of proteins in a cell lysate, or (3) an unknown protein expressed from a pool of in-vitro-translated cDNAs is collected by its interaction with a fusion protein composed of the target protein linked to a GST moiety. The complex is then isolated through the binding of the GST moiety to glutathione-coupled beads, followed by purification. This technique can also be used to derive semiquantitative estimates of the affinity of protein-protein interactions.
- In phage display (Smith 1985), a library of proteins (Bass et al. 1990) or peptides (Cwirla et al. 1990; Scott and Smith 1990) is expressed as fusions to a surface-displayed coat protein of a filamentous phage such as M13. Proteins expressed in this manner can be probed using strategies similar to those utilized for screening conventional bacterial expression libraries with antibodies or GST-fused probes. The life cycle and culturing properties of the filamentous bacteriophage facilitate the generation of libraries of particularly high complexity (up to  $10^{10}$  individual constituents), thereby maximizing chances of finding a novel interaction or discovering mutations that perturb a predefined interaction in a meaningful way. For the theory and practice of affinity selection techniques used with phage display-based systems, please see Barbas et al. (2001) and the information panel on **FILAMENTOUS PHAGE DISPLAY** at the end of this chapter.
- Two-hybrid systems (Fields and Song 1989; Chien et al. 1991; Durfee et al. 1993; Gyuris et al. 1993; Vojtek et al. 1993) also mimic natural systems. These systems utilize the genetic power of the yeast *Saccharomyces cerevisiae* as host for analysis of protein-protein interactions. The two-hybrid system (Fields and Song 1989) artificially mimics the natural process of transcription, building on observations that transcriptional activators can be separated into discrete regions

corresponding to DNA-binding domains and transcriptional activation domains (Brent and Ptashne 1985; Hope and Struhl 1986). In the standard two-hybrid approach, the association of an activation domain with a DNA-binding domain is rendered dependent on a bridging function provided by two interacting proteins, fused respectively to the DNA-binding domain and the activation domain; productive interaction leads to transcriptional activation of reporters whose products can be easily scored on the basis of colorimetric tests or the ability of the novel *trans*-activator to transcribe a yeast gene essential for growth of the organism. The ease of manipulation and genetic power of yeast allow assessment of a large number of interactions at low cost, and with the potential for high throughput, as exemplified in recent genomic applications (e.g., please see Fromont-Racine et al. 1997; Uetz et al. 2000; Walhout et al. 2000).

- Immunological studies have long used naturally generated antibodies as tools to probe diverse cellular functions (Harlow and Lane 1988). Coimmunoprecipitation — the detection of a protein by immunoprecipitation with an antibody directed against a partner molecule — has been used for at least two decades (e.g., please see Moon and Lazarides 1983) and provides a direct method of establishing protein association in either *in vitro* or *in vivo* situations. In parallel, antibodies have been developed as tools to localize specific proteins in the context of cellular ultrastructure. Initial analysis of the cellular cytoskeleton with antibodies to actin (Lazarides and Weber 1974) developed into the current set of colocalization strategies to assign proteins with suspected common function to overlapping compartments (e.g., please see Weber et al. 1982). More recent refinements include fluorescence resonance energy transfer (FRET), in which the transfer of energy from an excited donor fluorophore carried by one protein is transferred to an acceptor fluorophore carried by another protein. Association between the two proteins results in a quantifiable change in the ratio of intensity of the two labeled protein probes, which is a dynamic measure of their proximity within a living or fixed cell (Adams et al. 1991). One advantage of FRET is that proteins can be made fluorescent in a variety of ways, either by reaction with labeled antibody, or direct coupling of dye, or by synthesis as a fusion protein with a form of green fluorescent protein (GFP).
- Finally, biochemical approaches designed to allow rapid measurement of binding constants and other physical parameters associated with protein-protein or protein-peptide interactions led to the development of surface plasmon resonance (for early descriptions of the technique, please see Place et al. [1985] and Jonsson et al. [1991]). In this approach, one protein to be analyzed is secured to a flat sensor chip in a flow chamber, after which a solution containing a prospective interacting partner is passed over the first protein in a continuous flow. Light is directed at a defined angle across the chip, and the resonance angle of reflected light is measured; the establishment of a protein-protein interaction causes a change in this angle. By calculating such changes over time, equilibrium binding constants and on and off rates can be readily estimated. Its speed and high sensitivity make this technique extremely attractive for many forms of analyses.

The two-hybrid and GST-fusion-based screening approaches described in Protocols 1, 2, and 3 are all suitable in applications that cast a broad net. For studies addressing physiological validation and exploration of interactions, coimmunoprecipitation of endogenous proteins (Protocol 4) and FRET (Protocol 5) are clearly preferred. For the rapid analysis of previously defined interactions, two-hybrid and GST pulldown assays have found some significant use; surface plasmon resonance (Protocol 6) obviously has much potential power.

It is important to note that the intrinsic nature of particular proteins dictates, to some extent, which techniques can be gainfully used for analysis of protein-protein interactions. For

example, if an interaction is likely to be mediated by posttranslational modifications that occur only in eukaryotes, phage display is not likely to be useful. If a protein interacts simultaneously with multiple partners in a complex fashion, yeast two-hybrid assays may not be of great value. As a basic caveat, many of the techniques described here do not prove whether an observed interaction is direct or indirect, i.e., whether it is mediated by additional proteins present in a pooled lysate or expressed in yeast. If the goal is to establish direct interactions, a method using pure proteins eventually must be used. Anticipating these kinds of potential problems in advance can save much time and effort that otherwise may be invested in an inappropriate assay system.

*Beauty is a harmonious relation between something in our nature and the quality of the object which delights us.*

Blaise Pascal (1623–1662)

# Protocol 1

---

## Two-hybrid and Other Two-component Systems

Erica A. Golemis and Ilya Serebriiskii

*Fox Chase Cancer Center, Philadelphia, Pennsylvania 19111*

**M**OST PROTEINS CONSIST OF MULTIPLE DOMAINS of partially or completely separable function. Significantly, these multiple domains in many cases do not need to be physically attached by covalent bonds; instead, activities of the intact protein can be reproduced by bringing individual domains into intimate contact. This basic property has been exploited in screening systems to measure the affinity of protein-protein interactions *in vivo* and to identify novel protein-protein interactions. Protein interactions so exploited have spanned a range of biological functions, including  $\alpha$ -complementation (Ullmann et al. 1967), ubiquitin-mediated targeting for protein degradation (Johnsson and Varshavsky 1994), reconstitution of repressor function (Hu et al. 1990), and generation of a transcriptional activator by combining DNA-binding domains with transcriptional activation domain functions (Fields and Song 1989). This last approach has developed into the two-hybrid system (Figure 18-1) and has become a standard and powerful tool for protein analysis. As the system matured, it has spun off a series of second-generation-related technologies that promise to greatly expand its utility.

### TWO-HYBRID SYSTEMS

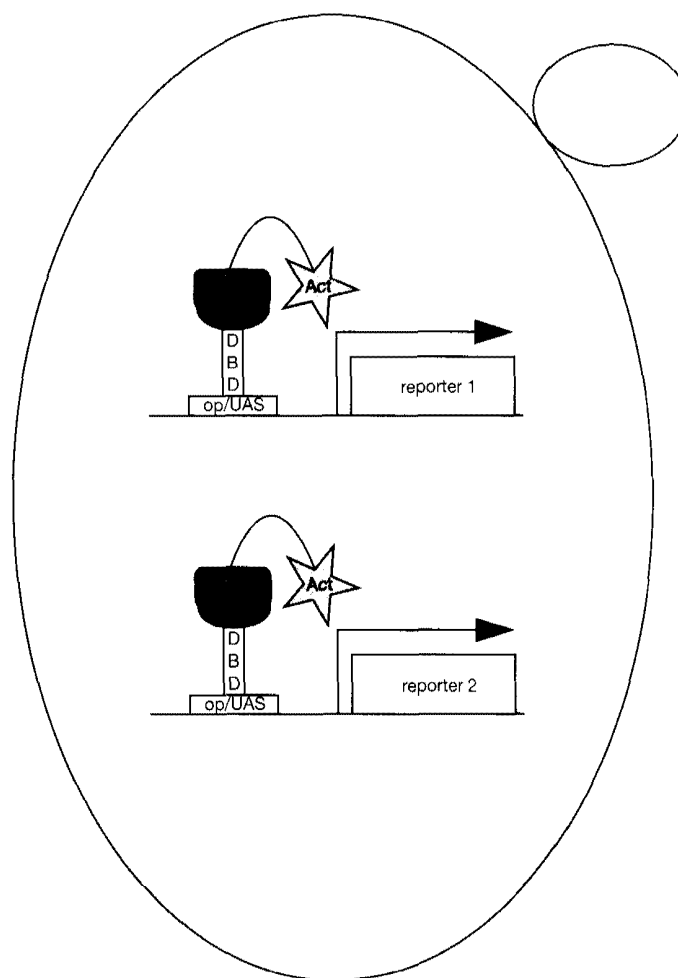
---

#### Starting Point

Two-hybrid systems were initially designed to identify and estimate the affinity of interactions between pairs of single proteins (Fields and Song 1989). However, because two-hybrid systems consist of a substantial number of components (plasmids for bait, prey, and reporter, as well as integrated reporters), it was initially uncertain whether they could accurately distinguish interactions of physiological relevance from lower-affinity interactions of questionable relevance. After several years of use by the scientific community, and after controlled tests of measured interaction affinity (Estojak et al. 1995), it became apparent that for the majority of bait proteins (>75%), a two-hybrid approach could be effectively used both to screen expression libraries for novel interacting proteins and to study interactions between known partners. Given this demonstrated effectiveness of the basic two-hybrid systems (Chien et al. 1991; Durfee et al. 1993; Gyuris et al. 1993; Vojtek et al. 1993) at solving a two-body problem, interest turned to the possibility of extending two-hybrid system capabilities to address more complex interactions involving greater numbers of system components.

#### Modified Baits

Initially, all two-hybrid systems used the yeast *S. cerevisiae* as a host cell. This proved to be a limitation in some studies of bait proteins from higher organisms, when posttranslational modifi-



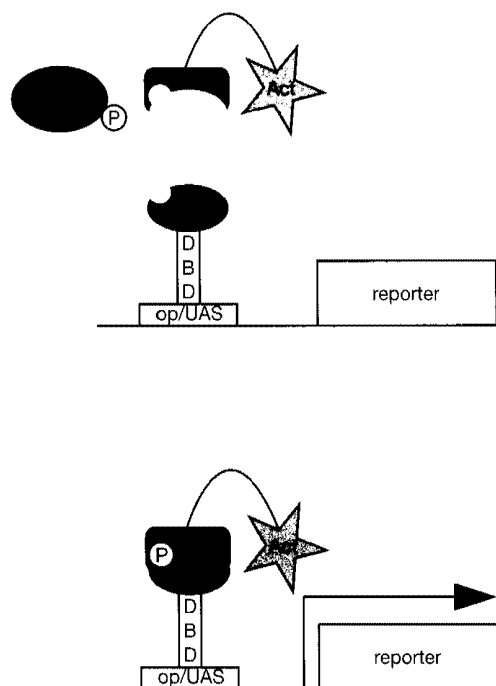
**FIGURE 18-1 The Two-hybrid System**

Diagram of the basic two-hybrid system to detect interactions between two proteins in a yeast cell. As shown, a DNA-binding domain (DBD)-fused bait protein of interest interacts with an activation domain (Act)-fused to a partner protein (Prey), either known or selected from a cDNA library. The interacting pair binds a specific sequence motif (op, operator, or UAS, upstream activating sequence, depending on whether LexA or GAL4 is used as a DBD), activating transcription of two separate reporter genes.

cations required to enable certain protein-protein interactions were not possible because of the absence of the appropriate modifying enzymes in yeast. The problem was especially severe in the case of baits relevant to higher eukaryotic signal transduction, given the prevalence of site-specific phosphorylation by tyrosine kinases as a means of regulating protein-protein interactions.

To solve the problem, Osborne et al. (1995, 1996) set up a two-hybrid screen in a strain of yeast that had been engineered to express the mammalian tyrosine kinase Lck. This enabled them to successfully screen a library for proteins that could bind specifically to a bait, derived from an IgE receptor, that carried phosphorylated tyrosine residues. Other groups have since had similar successes expressing other kinases of mammalian origin, and this approach has become generally useful (Figure 18-2). One potential drawback to this type of approach arises if the overexpressed modifying enzyme is deleterious in yeast: For example, constitutive expression of Src is generally toxic, probably due to the broad specificity of its phospho-kinase activity. In general, this approach is most success-





**FIGURE 18-2 Modified Bait**

A prey is unable to interact with a bait in the absence of posttranslational modification of the bait. A coexpressed kinase phosphorylates the bait protein, creating a binding interface for the prey.

ful either when working with a kinase or other posttranslational modifier of circumscribed substrate specificity or when placing the modifier under control of an inducible or repressible promoter.

## Peptides

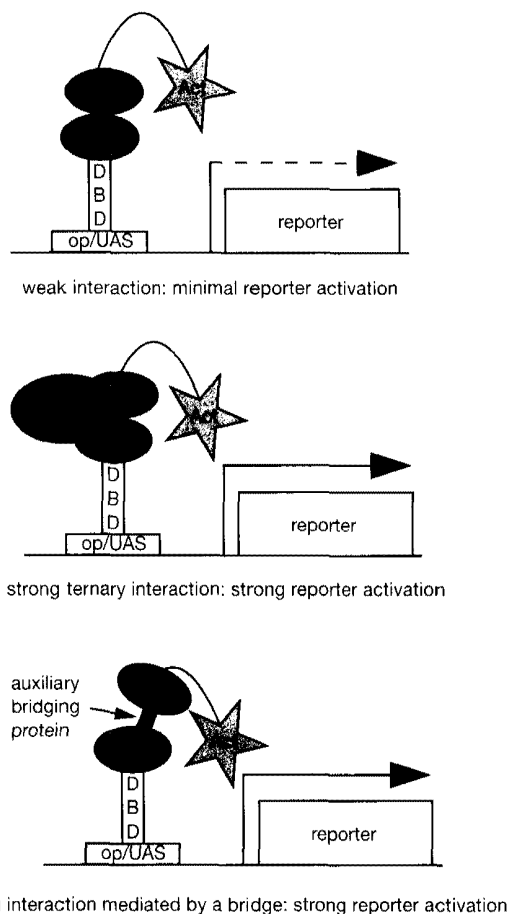
Extending the capacity of a two-hybrid system to interactions between proteins and very small (<16 residue) peptides was of considerable interest for several reasons. One anticipated benefit was the ability to identify minimal sets of conserved sequences required for interaction with a bait. A second benefit was the identification of small peptides that could regulate the activity of a bait protein, either by competitive binding and blocking of an interaction between a protein and its normal partner or by interfering with the protein's intrinsic catalytic activity.

In two independent demonstrations, small specific interacting peptides were successfully selected from a library: M. Yang et al. (1995) used a retinoblastoma (Rb) bait to isolate multiple peptides containing the canonical LxCxE Rb-interacting motif, whereas Colas et al. (1996) isolated Cdk2-interacting peptides (termed aptamers), some of which proved to inhibit Cdk2 kinase activity. The peptide libraries used in the two studies were significantly different in design, with the peptides in one case fused to the carboxyl terminus of the GAL4 activation domain (M. Yang et al. 1995), and in the second case, constrained on both ends within a loop on the surface of the cytoplasmic protein thioredoxin (Colas et al. 1996). The fact that both approaches worked well implies considerable flexibility in peptide-protein recognition. Peptide aptamers can not only be identified from genetic screens, but also be used as baits in further screens for interacting proteins, thus helping to elucidate complex genetic networks, such as the yeast mating pheromone response pathway (Geyer et al. 1999; Norman et al. 1999).

In a related application, Stagljar et al. (1996) described a rapid method to identify small interaction-specifying sequences within larger proteins. In this approach, cDNA encoding a known interacting protein was sheared by sonication and cloned into a prey vector using the shotgun technique. The resulting targeted library was cotransformed with the bait of interest, and direct selection was made for fragments capable of conferring interaction (Stagljar et al. 1996). The low-tech, cost-effective quality of such an approach makes it a useful addition to studies of protein function.

## Ternary Complexes

A single protein may be strongly bound to a multiprotein complex by interacting simultaneously and at low affinity with several different components of the complex. Some bait proteins that normally exist in a multisubunit complex may therefore interact with individual partners with affinity inadequate to be detected by the two-hybrid system. Coexpression of the bait with a previously defined partner protein might provide an interface that supports stronger interactions, allowing the identification of additional complex members (Figure 18-3). A number of groups



**FIGURE 18-3 Ternary Complexes**

A bait and prey, while part of the same higher-order complex, either form transient contacts or do not directly interact, resulting in little or no activation of reporter genes (*top*). Coexpression of a third partner (Auxiliary) known to associate with the bait and to be a component of the complex may stabilize previously weak interactions between bait and prey (*middle*) or act as a bridge to recruit prey to bait (*bottom*).

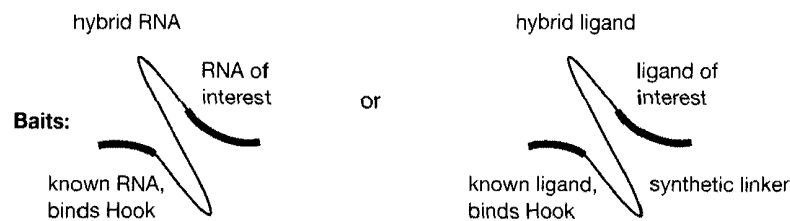
have demonstrated that coexpression of an “auxiliary bait” is sufficient to strengthen such ternary interactions (Tomashek et al. 1996; Zhang and Lautar 1996; Tirode et al. 1997). This straightforward approach has been used successfully to identify caspase substrates (Kamada et al. 1998; Van Crielinge et al. 1998) and to analyze a four-subunit protein complex (Pause et al. 1999).

The ternary “partner” in a three-component interaction need not necessarily be a protein, but instead may be a hormone or a drug. Chiu et al. (1994) first described the use of an FKBP12 bait in conjunction with rapamycin to identify the RAPT1 protein from a library, subsequently demonstrating that the interaction was dependent on the presence of rapamycin. In a separate study, Lee et al. (1995) were able to identify proteins that interacted with the thyroid hormone receptor in the presence or absence of thyroid hormone. The primary constraint on this use of the two-hybrid system is the permeability of yeast to the ternary small molecule of choice.

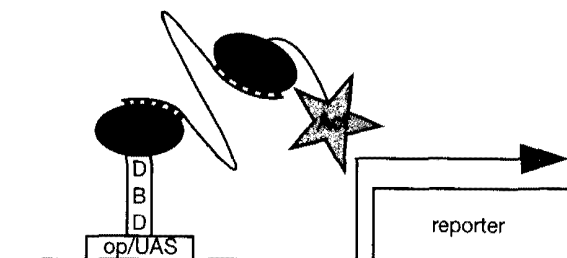
## Bait and Hook

Further applications of two-hybrid systems that promise to be particularly powerful are strategies to study protein-RNA or protein-drug interactions. In these strategies, a standardized “hook” is used to display an RNA molecule or a drug to the incoming prey, forming a nonprotein bridge to the reporter gene (Figure 18-4).

**Hook:** known RNA- or ligand-binding protein, fused to DNA-binding domain



**Preys:** known or novel (library) protein with RNA or ligand binding specificity



**FIGURE 18-4 Bait and Hook**

In this strategy, the DNA-binding domain (DBD) is fused to a defined protein with the capacity to bind either RNA or a chemical ligand. This fusion construct, termed “Hook,” is coexpressed with a hybrid RNA (Bait) containing the RNA-binding site for the Hook and a novel probe sequence or, alternatively, yeast containing the Hook are grown in the presence of a chemically synthesized molecule (Bait) that fuses the Hook ligand and the actual probe sequence. The prey constitutes an activation-domain-fused protein as in other two-hybrid manifestations; in this case, the protein has the property of binding the probe RNA or chemical ligand.

In one example used to identify RNA-interacting molecules, a DNA-binding domain was fused to the coat protein of the MS2 phage, which is known to bind a consensus RNA stem-loop. The RNase P (polymerase III) promoter was then used to express high levels of a synthetic RNA comprising the MS2 target stem-loop and the actual RNA target of interaction, the iron response element (IRE). When the prey, consisting of the iron regulatory protein fused to an activation domain, was bound to the IRE sequence, it was able to activate expression efficiently of the bait-responsive reporter (SenGupta et al. 1996). This system is commercially available from Invitrogen. A similar system has also been built around a DNA-binding domain, a bait derived from the human immunodeficiency virus (HIV) Rev protein, and a Rev response element (RRE) fused to RNA (Putz et al. 1996). Both systems have been used to screen libraries and have identified specific RNA-interacting molecules (e.g., please see Putz et al. 1996; Wang et al. 1996; Park et al. 1999b; SenGupta et al. 1999). A major problem with the technique is a relatively high background of false positives due to nonspecific RNA-interacting proteins (Park et al. 1999a).

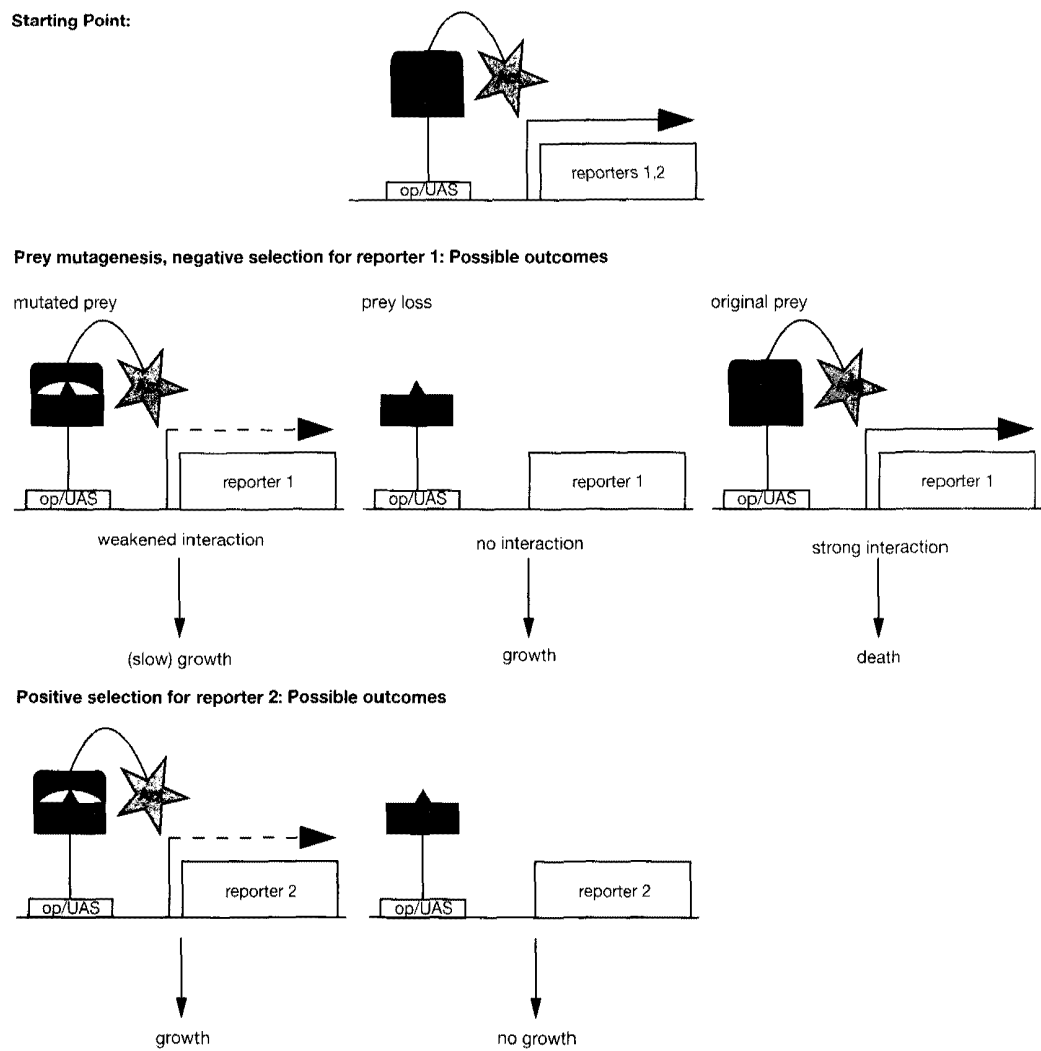
To detect interactions between proteins and chemical ligands, the hook was constructed as a fusion between a DNA-binding domain and the hormone-binding domain of the glucocorticoid receptor. To generate a bait, dexamethasone (the glucocorticoid receptor ligand) was conjugated to the compound of interest, FK506. Using this hook-bait combination, it was possible to analyze interactions between FK506 and its binding partner, FKBP12. This system appears to be genetically robust, as it was used to isolate FKBP12 from a cDNA library in a blind screen and to discriminate FKBP12 mutants with high and low affinity for FK506 (Licitra and Liu 1996). A similar strategy could be adapted to the study of multiple drugs of pharmacological interest, although a potential limitation is the poor permeability of yeast to some classes of compounds.

## Reverse Two-hybrid

The original two-hybrid systems relied on transcriptional activation of selectable markers to score protein-protein interaction. In a reciprocal approach, two-hybrid activation of counterselectable markers was used to develop an assay for loss of protein-protein interactions (Figure 18-5). In the first description of this approach, Vidal et al. (1996a,b) described a rapid screen for mutations that disrupted the ability of the transcription factor E2F1 to associate with its partner DP1. In the absence of interaction between the two partner proteins, transcription of the *URA3* reporter gene was abolished, thereby preserving the viability of yeasts grown in the presence of 5-FOA, a metabolite toxic to the uracil pathway. Application of a secondary positive selection eliminated mutations that resulted in complete loss of translation of the E2F1 bait. This system has been used successfully with other pairs of interacting proteins (Yasugi et al. 1997). In addition to its use in mutational hunts, this type of reverse selection may theoretically be used to screen drugs or peptide ligands that disrupt protein-protein interactions. A first elegant example has been published by Huang and Schreiber (1997). Similar results can be achieved with a "split-hybrid" system (Shih et al. 1996). Upon interaction, expression of the tetracycline repressor (TetR) is induced, which binds to and represses transcription from a TetR-operator-controlled *HIS3* gene. Disruption of the original protein interaction results in elimination of TetR transcription, which in turn restores *HIS3* synthesis and allows cells to grow in the absence of histidine. This approach was used to identify mutants of the cAMP response element-binding protein (CREB) that no longer associate with CREB-binding protein (Shih et al. 1996).

## Dual Bait

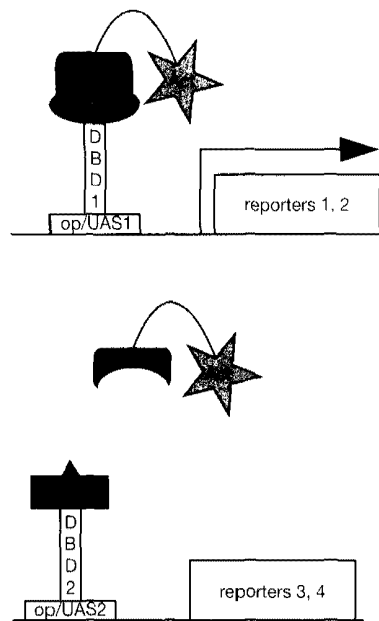
The original two-hybrid systems register the interaction of single bait-single prey combinations through activation of two bait-responsive reporter genes. If the complexity of the system is



**FIGURE 18-5 Reverse Two-hybrid**

As shown, mutations that weaken the interaction between bait and prey are selected in two steps. As a starting point, a bait-prey interaction is constructed using two reporters (one of which is counterselectable) whose normal expression is dependent on an interaction event. Following mutagenesis of the prey construct, a first counterselection is applied; yeast in which the interaction has been reduced, or the prey has been lost, continue to grow, whereas yeast with nonmutated (original) preys continue to activate reporter strongly, and are killed. At a second positive selection stage, only yeast containing a prey capable of interacting with the bait survive.

increased so that yeast expresses a single prey and two independent baits, each targeted to distinct reporter genes, several novel applications become possible (Figure 18-6). In one scenario, it is possible to screen in a single step for mutations (or for coexpressed proteins, or pharmaceutical agents) that selectively alter the interaction between a prey and one of two distinct partners. For genomic applications (see below), dual baits facilitate the assignment of protein interaction patterns. In library screens, the presence of two independent baits with distinct reporter readouts would allow the performance of two separate interactor screens from a single library



**FIGURE 18-6 Dual Bait**

This method discriminates between the interactions of a single prey with two different baits. The first DNA-binding domain fusion protein (DBD1-Bait) drives the expression of reporters 1 and 2 through op/UAS1. A second separate DNA-binding domain fused to a distinct bait (DBD2-Bait\*) directs expression of reporters 3 and 4 through op/UAS2. This reagent set can be used to select preys that interact with the DBD1-Bait but not DBD2-Bait\* from a library. Alternatively, if a prey interacts with both DBD1-Bait and DBD2-Bait\*, it can be used to select for mutations or molecules that selectively disrupt the interaction with one of the two baits.

transformation; furthermore, each screen could be used as a control to eliminate false positives from the other screen.

One limitation slowing the development of successful dual bait strategies has been the difficulty in devising combinations of markers and reporters to drive expression of all required components in yeast. Initial versions of dual bait approaches have solved the problem by utilizing single reporters, rather than the normal double reporters for each of the two baits (Jiang and Carlson 1996; Inouye et al. 1997; Xu et al. 1997). A slightly improved version using a double reporter for one bait, and a single reporter for the second bait, was described by Grossel et al. (1999). A fully developed incarnation of this approach retains two separate reporter systems for each of two independent baits and has been able to distinguish clearly specific interactions by a number of criteria (Serebriiskii et al. 1999). This version may prove to be particularly useful for screening of high-complexity libraries where high specificity and suppression of false positives are mandatory. Dual-bait reagents have been used to identify mutations in Pak1 kinase that selectively reduce the affinity of the kinase for either of two partners, the Cdc42 or Rac GTPases (M. Reeder and J. Chernoff, pers. comm.). These techniques may also be useful when combined with approaches such as those described by Marykwas and Passmore (1995) to characterize specific mutant alleles responsible for disrupting protein-protein interactions.

## STREAMLINING THE BASIC TECHNIQUE: MISCELLANEA

---

A number of investigators have generated modified reagents or protocols designed to improve the functioning of the "basic" two-hybrid system; some of these reagents may also find use in more recently developed systems (see above) or in genomic applications described below. Improved vectors with extended polylinkers and/or altered reading frames (James et al. 1996; Roder et al. 1996) should facilitate construction of activation domain (AD) and DNA-binding domain (DBD) fusions. Both AD and DBD can now be fused to proteins of interest at either the amino- or carboxy-terminal end (Beranger et al. 1997; Brown and MacGillivray 1997) to minimize the risk of sterically blocking domains involved in protein interactions. New vectors conditionally expressing auxiliary baits facilitate three-hybrid analysis (Tirode et al. 1997; Fuller et al. 1998), whereas integrating, low-copy, or conditionally expressing vectors yield more robust results in traditional two-hybrid analysis (e.g., please see Durfee et al. 1999). New reporter genes that have the potential to be more sensitive and/or more reliable and convenient are being introduced: yeast  $\alpha$ -galactosidase (MEL1) (Aho et al. 1997), *Escherichia coli*  $\beta$ -glucuronidase (Hirt 1991; Serebriiskii et al. 1999), and GFP (Mancini et al. 1997; Cormack et al. 1998; Mayer et al. 1999). The use of suitable antibiotic resistance genes (e.g., Zeomycin resistance, Zeo<sup>R</sup>, and others) as selectable plasmid markers in yeast (Huang and Schreiber 1997) increases the number of plasmids that can be simultaneously expressed in a single yeast, facilitating the set-up of three-hybrid or reverse two-hybrid experiments. Other vector sets containing alternate antibiotic resistance genes (Watson et al. 1996; Bannasch and Schwab 1999) reduce the number of steps required in recovering positive library plasmids to *E. coli* after a screen.

Beyond vectors, a number of related techniques have the potential to speed two-hybrid analysis, including (1) the use of agarose overlays to score activation of *lacZ* and  $\beta$ -glucuronidase reporter genes (Duttweiler 1996), (2) polymerase chain reaction (PCR) screening of putative positive clones (Kaiser et al. 1994; Klebanow and Weil 1999), and (3) wider use of robotic microtiter-plate-based replica techniques (Buckholz et al. 1999).

Reagents from the two workhorse two-hybrid systems, derived separately from GAL4 and LexA, have long been described as incompatible because of the overlapping use of selective markers. However, a recent report suggests that reagents sometimes can be combined, reducing the need to reclone baits/preys when working with different sets of clones (Dagher and Filhol-Cochet 1997). In addition, increased use of Zeo<sup>R</sup> and other antibiotic markers (Huang and Schreiber 1997) may facilitate exchange of libraries between the GAL4 and LexA- or cI-based systems.

A recombination-based technique to (re)construct two-hybrid plasmids rapidly in yeast was developed by Petermann et al. (1998). This technique does not require plasmid isolation and intermediate hosts, and it can be used to facilitate interaction mating and/or retesting of interactions by retransformation. Using this approach, PCR-amplified library inserts, obtained from primary positive transformants, can be rapidly converted into plasmids; alternatively, this approach can be used to construct entire two-hybrid libraries (Hua et al. 1998; Fusco et al. 1999) or to generate full-length cDNA molecules from yeast two-hybrid clones and RACE (rapid amplification of cDNA ends) products (Hemenway et al. 1999).

Considerable effort has gone into solving the problem of false positives in two-hybrid screens. Parameters affecting isolation of false positives in two-hybrid screens have been studied, and some new approaches to their detection have been developed (Serebriiskii et al. 2000). A host strain that contains three reporter genes under the control of different GAL4-inducible promoters allows elimination of virtually all false positives specific to the promoter element in the GAL4 system (James et al. 1996); and, as discussed earlier, two-bait systems should help in rapid detec-

tion and elimination of false positives at an early stage in library screens (e.g., please see Serebriiskii et al. 1999). A database of false positives available on the World Wide Web will help to validate cDNAs obtained from screens (<http://www.fccc.edu/research/labs/golemis/InteractionTrapInWork.html>). This and other sites on the Internet provide a wealth of information on setting up and analyzing results of two-hybrid analysis; descriptions of the available vectors, libraries, maps, and sequences; protocols and references; full texts of important articles on two-hybrid systems; and even information on upcoming two-hybrid courses (if the investigator should become overwhelmed by the options and reagents available).

## SOLUTIONS FOR ACTIVATING BAITS: "SWAPPED" TWO-HYBRID AND RNA POLYMERASE-III-BASED TWO-HYBRID SYSTEMS

---

One of the major limitations of the two-hybrid system is that the bait protein (traditionally fused to DBD) should not be self-activating for transcription. The first system to overcome this limitation was the so-called "swapped system" (Du et al. 1996) in which a gene encoding a protein of interest was fused to an activation domain and screened against a library of DBD-fused proteins. In this initial work, the majority of isolated clones were self-activating DBD fusions, a problem that can be alleviated by prescreening as discussed in the information panel on **GENOMICS AND THE INTERACTION TRAP**.

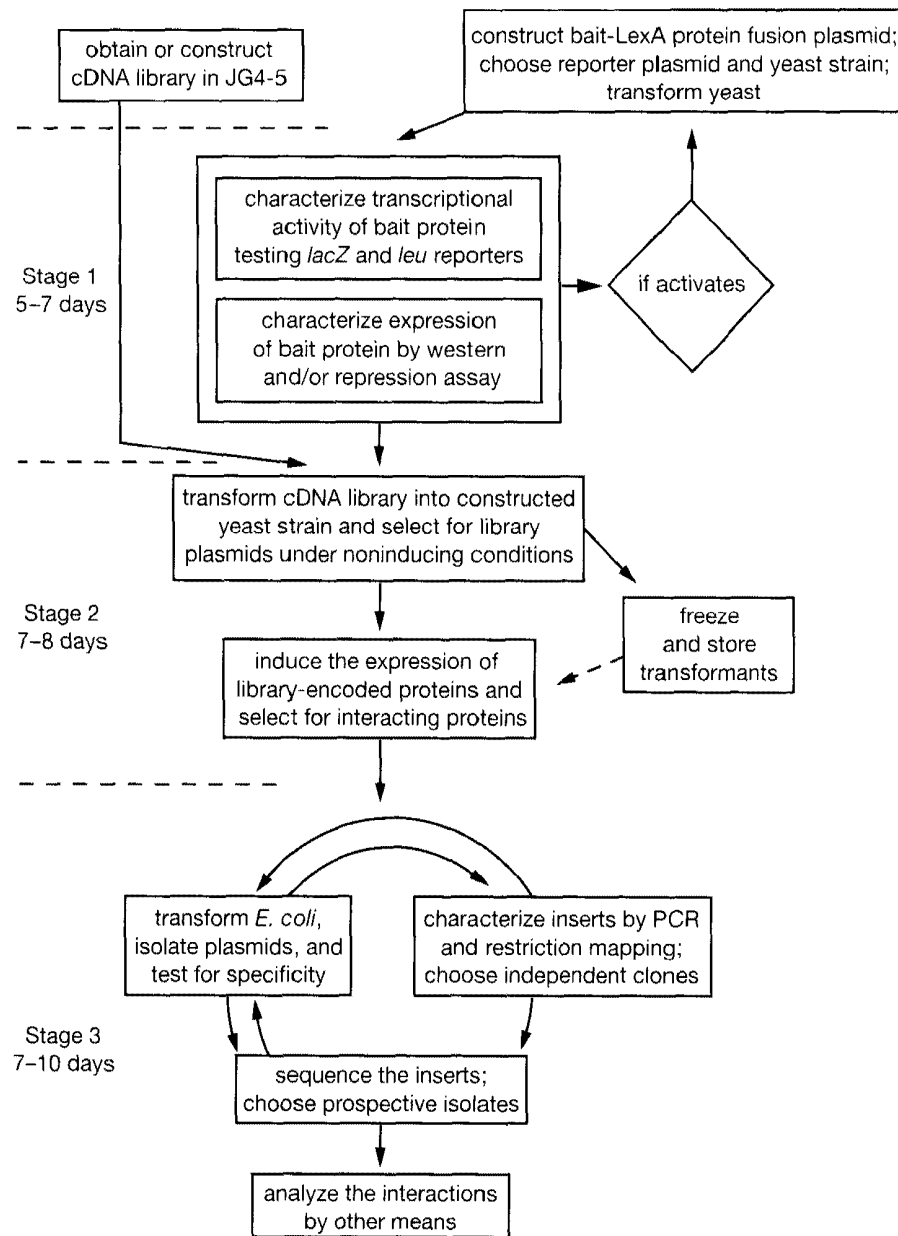
A more radical solution is provided by a two-hybrid system based on RNA polymerase III. The promoter of the essential *SNR6* gene is responsive to polymerase III; reporter genes have been developed in which a binding site for GAL4 is incorporated within the context of the *SNR6* promoter. This system detects the interaction between a GAL4-fused bait and a  $\tau$ 138-fused prey protein; upon interaction,  $\tau$ 138 recruits the remaining components of the TFIIC factor, enabling the polymerase III machinery to transcribe the yeast essential gene *SNR6*. There are no known transcriptional activators of polymerase III, and polymerase II *trans*-activators do not regulate polymerase-III-mediated transcription in yeast. In fact, as demonstrated, strong transcriptional activators such as GAL4 or VP16 fused to GAL4 DBD were quite incapable of activating transcription of the UAS(G)-*SNR6* gene (Marsolier et al. 1997; Marsolier and Sentenac 1999). Additional modifications have allowed the development of one- and three-hybrid approaches based on this system.

## SUMMARY

---

The number of potential uses for two-hybrid-derived systems has expanded at a breathtaking pace during the last several years. Perhaps because the basic system reagents — yeast and plasmids — are inexpensive and relatively easy to manipulate, a great many investigators have felt free to extend the limits of the technology. The resulting demonstration of innovation and creativity has led to the generation of a great number of basic tools that can now be recombined for use in ever more sophisticated screens (e.g., please see Liberles et al. 1997). If the next few years match the pace of the preceding years, it may be that screening a genome's worth of coding information will not be as daunting a task as it now seems (please see the information panel on **INTERACTION TRAP AND RELATED TECHNOLOGIES** at the end of this chapter).





**FIGURE 18-7 Flowchart: Two-hybrid System**

Flowchart, controls, and library screen. See text for details. (Redrawn from Spector et al. 1998.)

The following protocol for the execution of an interaction trap/two-hybrid screen is divided into three stages: Characterization of a Bait-LexA Fusion Protein, Selecting an Interactor, and Second Confirmation of Positive Interactions. In Stage 1, characterization of a novel bait is described, with attention to controls to increase the likelihood that the bait will function effectively. In Stage 2, transformation of a cDNA library and selection of positive interactors are detailed. In Stage 3, a series of first-order and subsequent control experiments are outlined to establish the biological significance of an interacting protein. A flowchart illustrating the order and approximate time necessary to perform various stages is shown in Figure 18-7.

## STAGE 1: Characterization of a Bait-LexA Fusion Protein

An interactor hunt begins with the generation of a construct that expresses the protein of interest fused to the bacterial protein LexA (a pBait). This construct is cotransformed with a *lexAop-lacZ* reporter plasmid into a yeast strain containing a chromosomally integrated *lexAop-LEU2* reporter gene. The pBait is analyzed in control experiments to establish whether it can be used in a two-hybrid screen. These controls determine whether the bait is expressed as a stable nuclear protein of the correct predicted size that does not independently activate transcription of the *lexA* operator-based reporter genes to any significant degree. Depending on the result of these controls, the bait may be used directly to screen a library under conditions established during validation of the bait. Alternatively, different combinations of reporter strains/plasmids can be used, or the bait can be modified according to provided guidelines. Tables 18-1 and 18-2 describe the features and various functions of the plasmids used in construction and testing of the plasmid carrying the gene encoding the bait fusion protein. The structures of the LexA fusion and activation domain fusion vectors are shown in Figure 18-8.

In choosing how to construct a bait, it is important to remember that the assay depends on the ability of the bait to enter the nucleus and requires the bait to be a transcriptional *non-activator*. Therefore, if the chosen protein has obvious sequences that confer attachment to membranes, or sequences that are transcriptional activation domains, these should be removed. Although some investigators have attempted to use two-hybrid systems to find associating partners for proteins that are normally extracellular, this is an unproven strategy and should be regarded as a high-risk venture.

The following methods utilize basic yeast media and transformation procedures. It is good practice to move expeditiously through the characterization steps described below. If plasmids are retained for extended periods of time in yeast maintained on Parafilm-wrapped selective plates at 4°C, the expression levels of proteins will gradually drop. After 2 weeks or so, results may become somewhat variable. If delays are foreseen, the best options are either to repeat transformations with bait protein and the *lexAop-lacZ* reporter before moving on to library screening or to store at -70°C a stock of yeast transformed with bait and reporter constructs that can be thawed immediately before library screening.

### MATERIALS

**CAUTION:** Please see Appendix 12 for appropriate handling of materials marked with <!.>.

#### Buffers and Solutions

Please see Appendix 1 for components of stock solutions, buffers, and reagents. Dilute stock solutions to the appropriate concentrations.

##### 2x SDS gel-loading buffer

- 100 mM Tris-Cl (pH 6.8)
- 200 mM dithiothreitol
- 4% SDS (electrophoresis grade)
- 0.2% bromophenol blue
- 20% glycerol

SDS gel-loading buffer lacking dithiothreitol can be stored at room temperature. Add dithiothreitol from a 1 M stock just before the buffer is used.

## Gels

*SDS-polyacrylamide gel* <1>

Please see Appendix 8 for preparation of SDS-polyacrylamide gels used in the separation of proteins.

## Nucleic Acids and Oligonucleotides

*Target DNA encoding the protein of interest (bait)*

## Antibodies

*Monoclonal antibody to LexA (CLONTECH) or Polyclonal antibody to LexA (Invitrogen) or Specific antibody to the fusion domain of the target protein (if available)*

## Media

**Please see Appendix 2 for components of yeast media.**

### *CM selective medium*

Use Table 18-3 to estimate the amount of media required and Table 18-4 to prepare the necessary selective media.

Yeast nitrogen base without amino acids (YNB) is sold either with or without ammonium sulfate. Table 18-4 assumes that the YNB contains ammonium sulfate. If the bottle of yeast nitrogen base instructs that 1.7 g/liter be added to make media, then it *does not* contain ammonium sulfate and 5 g of ammonium sulfate per liter of media should be added.

### *Yeast selective X-gal medium*

- i. Prepare the base medium in 900 ml of H<sub>2</sub>O, according to Table 18-4. Autoclave the base medium and cool it to 55°C.
- ii. In a separate bottle, autoclave 7 g of sodium phosphate (dibasic) and 3 g of sodium phosphate (monobasic) in 100 ml of distilled H<sub>2</sub>O.
- iii. Mix the two autoclaved solutions together, and add 0.8 ml of 100 mg/ml X-gal (in *N,N*-dimethylformamide <1>). Pour the plates.

### *YPD medium*

- 20 g of peptone
- 10 g of yeast extract
- 20 g of glucose
- 20 g of agar (if for plates)

Add 1 liter of distilled H<sub>2</sub>O and autoclave the medium for 20 minutes. Before pouring plates, cool the autoclaved medium to 55°C.

## Special Equipment

*Dry ice/ethanol bath* <1>

Please see Step 13.

*Flat-edged toothpicks, sterilized*

To sterilize, transfer standard toothpicks to a 250-ml beaker, cover the beaker with aluminum foil, and autoclave under standard dry conditions.

*Heat block or Thermocycler preset to 100°C, or Boiling water bath*

## Additional Reagents

*Step 1 of this protocol requires the reagents for subcloning listed in Chapter 1, Protocol 17.*

*Step 2 of this protocol requires the reagents for transformation of yeast listed in Spector et al. (1998, Chapter 21).*

*Step 17 of this protocol requires the reagents for immunoblotting listed in Appendix 8.*

## Vectors and Yeast Strains

*S. cerevisiae strains for selection and propagation of vectors (please see Table 18-6)*

*Vectors carrying LexA (please see Table 18-1) and activation domain fusion sequences (please see Table 18-2) and LacZ reporter plasmids (please see Table 18-5)*

TABLE 18-1 LexA Fusion Plasmids

PLASMID	SELECTION IN		COMMENT/DESCRIPTION	CONTACT/ SOURCES <sup>a,b,c</sup>
	YEAST	<i>E. COLI</i>		
pMW101	HIS3	Cm <sup>R</sup>	Basic plasmid to clone bait as fusion with LexA; expression is driven by the ADH1 promoter.	Serebriiskii and Golemis
pMW103	HIS3	Km <sup>R</sup>	Basic plasmid to clone bait as fusion with LexA; expression is driven by the ADH1 promoter.	Serebriiskii and Golemis
pEG202	HIS3	Ap <sup>R</sup>	Basic plasmid to clone bait as fusion with LexA; expression is driven by the ADH1 promoter.	OriGene CLONTECH MoBiTec Display
pJK202	HIS3	Ap <sup>R</sup>	A derivative of pEG202. The incorporation of nuclear localization sequences between LexA and polylinker enhances the ability of the bait fusion protein to translocate to nucleus.	OriGene
pNLexA	HIS3	Ap <sup>R</sup>	Polylinker is upstream of LexA; allows fusion of LexA to carboxyl terminus of bait, leaving amino-terminal residues of bait unblocked.	OriGene
pGilda	HIS3	Ap <sup>R</sup>	GAL1 promoter replaces ADH promoter in the pEG202 backbone; should be used if continuous presence of the the bait is toxic to yeast.	OriGene CLONTECH
pEG202I	HIS3	Ap <sup>R</sup>	A derivative of pEG202, which can be integrated into yeast <i>HIS3</i> gene after digestion with <i>KpnI</i> ; ensures lower levels of bait expression.	Serebriiskii and Golemis
pRFHM1 (control)	HIS3	Ap <sup>R</sup>	Homeodomain of <i>bicoid</i> cloned into pEG202 backbone; the resulting nonactivating fusion is recommended as a negative control for activation and interaction assays, and as a positive control for repression assays.	OriGene
pSH17-4 (control)	HIS3	Ap <sup>R</sup>	GAL4 activation domain cloned into pEG202 backbone; recommended as a positive control for transcriptional activation.	OriGene
pHybLex/Zeo	Zeo <sup>R</sup>	Zeo <sup>R</sup>	Bait cloning vector, compatible with IT and all other two-hybrid systems. Minimal ADH1 promoter expresses LexA followed by extended polylinker.	Invitrogen
pCGLex/p2GLex	Zeo <sup>R</sup>	Zeo <sup>R</sup>	Gal-inducible bait vector, compatible with IT and all other two-hybrid systems. GAL1 promoter expresses LexA followed by extended polylinker; both high- and low-copy number versions available.	Huang and Schreiber (1997)

Reprinted from E.A. Golemis Web Site: [http://www.fccc.edu/research/labs/golemis/com\\_sources1.html](http://www.fccc.edu/research/labs/golemis/com_sources1.html)

<sup>a</sup>Notes:

*I. Serebriiskii and E.A. Golemis*: [www.fccc.edu/research/labs/golemis/InteractionTrapInWork.html](http://www.fccc.edu/research/labs/golemis/InteractionTrapInWork.html) (Fox Chase Cancer Center, 7701 Burholme Avenue, Philadelphia, PA 19111)

*OriGene*: [www.origene.com/yeast.html](http://www.origene.com/yeast.html) (re DupLEX-A Yeast Two-Hybrid System)

*CLONTECH*: [www.clontech.com/products/catalog/MATCHMAKER/MMLexA.html](http://www.clontech.com/products/catalog/MATCHMAKER/MMLexA.html) (re MATCHMAKER LexA Two-Hybrid System)

*MoBiTec*: [www.mobitec-us.com/h\\_nav.html](http://www.mobitec-us.com/h_nav.html) (re Grow'n'Glow GFP Yeast Two- and One-Hybrid Systems)

*Display Systems*: [www.displaysystems.com/Products/P...it\\_Sy/displaygreen\\_Two-Hybrid\\_Kit\\_Sy.html](http://www.displaysystems.com/Products/P...it_Sy/displaygreen_Two-Hybrid_Kit_Sy.html) (re displayGREEN Two-Hybrid Kit)

*Invitrogen*: [www.invitrogen.com/catalog\\_project/cat\\_hybrid.html](http://www.invitrogen.com/catalog_project/cat_hybrid.html) (re Hybrid Hunter Improved Two-Hybrid System for the Detection of Protein-Protein Interactions)

<sup>b</sup>Credits: Interaction Trap (IT) reagents represent the work of many contributors: The original basic reagents were developed in the Brent laboratory (Department of Molecular Biology, MGH, Boston). Plasmids with altered antibiotic resistance markers (all pMW plasmids) were constructed at Glaxo (Research Triangle Park). Plasmids and strains for specialized applications have been developed by E. Golemis (Fox Chase Cancer Center, Philadelphia: pEG202, EG48, EG191); J. Gyuris (Mitotix, Cambridge: pJG4-5); J. Kamens (BASE, Worcester: pJK101, pJK202); cumulative efforts of I. York (Dana-Farber Cancer Center, Boston) and M. Sainz and S. Nottwehr (University of Oregon: pNLexA); D.A. Shaywitz (MIT Center for Cancer Research, Cambridge: pGilda); R. Buckholz (Glaxo, Research Triangle Park: pEG202I, pJG4-5I); S. Hanes (Wadsworth Institute, Albany: pSH18-34, pSH17-4); R. Brent (Department of Molecular Biology, MGH, Boston: pRB1840); R. Finley (Wayne State University, Detroit: pRFHM1, RFY206); A.B. Vojtek and S.M. Hollenberg (Fred Hutchinson Cancer Research Center, Seattle, Washington).

<sup>c</sup>Earlier versions of screening protocols utilized LexA fusion and reporter plasmids incorporating genes for resistance to ampicillin (Amp<sup>R</sup>) for plasmid maintenance in bacteria (pEG202, pSH18-34; Golemis et al. 1995). These versions have been superseded by comparable plasmids incorporating resistance to kanamycin (Km<sup>R</sup>) (Watson et al. 1996) or chloramphenicol (Cm<sup>R</sup>) (Watson et al. 1996). The use of these markers facilitates the purification of library plasmids in later steps by eliminating the need for passage through K12 bacteria. Features of the basic vectors used in the two-hybrid system are illustrated in Figure 18-8.

TABLE 18-2 Activation Domain Fusion Plasmids

PLASMID	SELECTION IN		COMMENT/DESCRIPTION	CONTACT/ SOURCES <sup>a,b,c</sup>
	YEAST	<i>E. COLI</i>		
pJG4-5	TRP1	Ap <sup>R</sup>	Library construction plasmid; GAL1 promoter provides efficient expression of a gene fused to a cassette consisting of nuclear localization sequence, transcriptional activation domain, and HA epitope tag.	OriGene CLONTECH MoBiTec Display
pJG4-5I	TRP1	Ap <sup>R</sup>	A derivative of pJG4-5 that can be integrated into yeast <i>TRP1</i> gene after digestion with <i>Bst</i> 36I; designed to study interactions that occur physiologically at low protein concentrations (in combination with pEE2021).	Serebriiskii and Golemis
pYESTrp	TRP1	Ap <sup>R</sup>	GAL1 promoter expresses nuclear localization domain, transcriptional activation domain, V5 epitope tag, multiple cloning sites; contains f1 ori and T7 promoter/flanking site; used to express cDNA libraries.	Invitrogen
pNB42 series	TRP1	Ap <sup>R</sup>	Allow fusion to the amino terminus of an activation domain, leaving amino-terminal residues of prey unblocked; various multiple cloning sites; no libraries yet available.	Brown and MacGillivray (1997)
pMW102	TRP1	Km <sup>R</sup>	Same as pJG4-5, but with altered antibiotic resistance markers; no libraries yet available.	Serebriiskii and Golemis
pMW104	TRP1	Cm <sup>R</sup>		
pCGB42/p2GB42	Genet <sup>R</sup>	Km <sup>R</sup>	The same <i>Tn903</i> -encoded gene confers kanamycin resistance in <i>E. coli</i> and geneticin resistance in yeast; both high- and low-copy number versions available; multiple cloning site.	Huang and Schreiber (1997)

Reprinted from E.A. Golemis Web Site: [http://www.fccc.edu/research/labs/golemis/com\\_sources1.html](http://www.fccc.edu/research/labs/golemis/com_sources1.html)

<sup>a,b,c</sup>Please see Table 18-1.

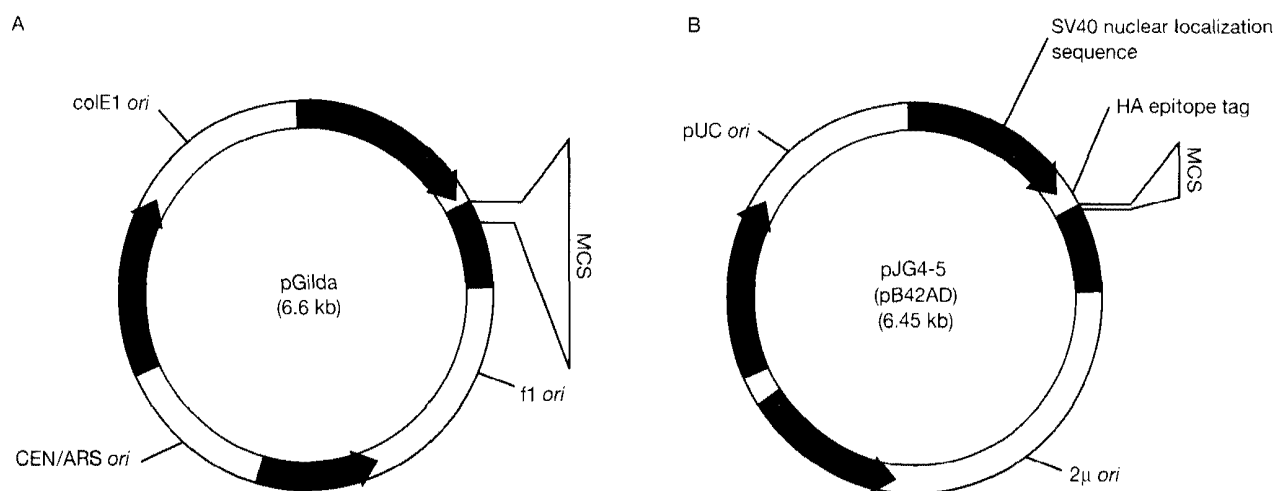


FIGURE 18-8 Two-hybrid Basic Vectors

(A) LexA fusion vector pGilda. The vector is used (as an example of a bait vector) to express bait proteins as fusions to the DNA-binding domain (DBD) of LexA under the control of the GAL1 inducible promoter (pGAL1). Plasmids contain the *HIS3* selectable marker, the 2- $\mu$ m origin of replication to allow propagation in yeast, an antibiotic resistance gene, and the *colE1* origin of replication to allow propagation in *E. coli*. Invitrogen has recently developed an Interaction-Trap system in which both the *HIS3* marker and antibiotic resistance markers have been replaced with the Zeocin resistance gene, which can be selected in both yeast and bacteria. As this vector backbone is combined with specialized LexA-fusion cassettes, it is likely to facilitate two-hybrid screening. (B) pJG4-5 (pB42AD). The vector is used to express inserts as fusion proteins to the SV40 nuclear localization sequence, the 88-residue activator B42, and the hemagglutinin (HA) epitope tag. Expression of the fusion protein is under control of the GAL1 inducible promoter (pGAL1). Details of polylinkers and vector sequences can be found at [www.fccc.edu/research/labs/golemis/InteractionTrapInWork.html](http://www.fccc.edu/research/labs/golemis/InteractionTrapInWork.html). (Adapted, with permission, from CLONTECH.)

**TABLE 18-3 Yeast CM Selective Media Required for Two-hybrid Analysis**

MEDIA	STAGE 1	STAGE 2	STAGE 3
CM Selective Media (ml)			
CM Glu -W			(100)
CM Glu -[UH]		(100)	400
CM Gal -[UHW]		100	
CM Selective Agar Plates (number)			
CM Glu -U	2		
CM Glu -[UH]		8-10	(3)
CM Glu -[UHL]	1		
CM Glu -[UHW]		4 + 30L*	6-12
CM Glu -[UHWL]			1-6
CM Gal -U	3-4		
CM Gal -[UHL]	3-4		
CM Gal -[UHW]			2-12
CM Gal -[UHWL]		20-24	2-12
CM Gal Xgal -U	(1)		
CM Glu Xgal -U	(1)		
CM Gal Xgal -[UHW]			(2-6)
CM Glu Xgal -[UHW]			(2-6)

Complete minimal (CM) is a medium that contains all necessary supplements. To test the growth requirement(s) of a particular strain, prepare a series of selective media for which each expected auxotrophy is supplemented, except the one of interest. In drop out or selective media, a particular ingredient is lacking or "dropped out" (e.g., -[UH] is lacking uracil and histidine).

Values are approximate minimum number of plates or volume of liquid medium required to complete each of the outlined protocols, assuming characterization and library screening with a single bait. Values in parentheses reflect plates that may or may not be required, based on the particular assay alternative chosen. (L\*) Large plates are used in library screening (please see text); all other plates are 10-cm in diameter. Because the results of library screening are variable, the number of plates required in Stage 3 may be greater or less than the average values given.

**TABLE 18-4 Yeast CM Selective Media for Two-hybrid Analysis**

INGREDIENTS	CM(GLU) -U-H MEDIUM	CM(GLU) -U AGAR	CM(GLU) -U-H AGAR	CM(GLU) -U-H-L AGAR	CM(GLU, X-GAL)-U AGAR <sup>a</sup>	CM(GAL) -U-H-L AGAR	CM(GAL, X-GAL)-U-H-L AGAR <sup>a</sup>
YNB	6.7 g	6.7 g	6.7 g	6.7 g	6.7 g	6.7 g	6.7 g
Glucose	20 g	20 g	20 g	20 g	20 g		
Galactose						20 g	20 g
Dropout mix	2 g	2 g	2 g	2 g	2 g	2 g	2 g
Leucine	15 ml	15 ml	15 ml		15 ml		
Tryptophan	10 ml	10 ml	10 ml	10 ml	10 ml	10 ml	10 ml
Histidine		5 ml			5 ml		
Agar		20 g	20 g	20 g	20 g	20 g	20 g

To prepare liquid or agar medium, mix the ingredients in a final volume of 1 liter of H<sub>2</sub>O. Autoclave for 20 minutes. Cool the agar medium to 55°C before pouring plates: Leucine stock = 4 mg/ml; Tryptophan stock = 4 mg/ml; Histidine stock = 4 mg/ml.

<sup>a</sup>For media containing X-gal, prepare the appropriate base medium in 900 ml of H<sub>2</sub>O, and use it in the recipe for yeast selective X-gal medium.

TABLE 18-5 Reporter Plasmids

PLASMID	SELECTION IN		NO. OF OPERATORS	COMMENT/DESCRIPTION	CONTACT/SOURCES <sup>a,b,c</sup>
	YEAST	<i>E. COLI</i>			
pMW112	URA3	Km <sup>R</sup>	8	Transcription of the <i>lacZ</i> gene is directed by LexA operators: The most sensitive indicator plasmids for transcriptional activation have eight operators, intermediate reporters have two operators, and the most stringent reporters have one operator.	Serebriiskii and Golemis
pMW109	URA3	Km <sup>R</sup>	2	See comment for pMW112.	Serebriiskii and Golemis
pMW111	URA3	Km <sup>R</sup>	1	See comment for pMW112.	Serebriiskii and Golemis
pMW107	URA3	Cm <sup>R</sup>	8	See comment for pMW112.	Serebriiskii and Golemis
pMW108	URA3	Cm <sup>R</sup>	2	See comment for pMW112.	Serebriiskii and Golemis
pMW110	URA3	Cm <sup>R</sup>	1	See comment for pMW112.	Serebriiskii and Golemis
pSH18-34	URA3	Ap <sup>R</sup>	8	See comment for pMW112.	OriGene Invitrogen CLONTECH
pJK103	URA3	Ap <sup>R</sup>	2	See comment for pMW112.	OriGene
pRB1840	URA3	Ap <sup>R</sup>	1	See comment for pMW112.	OriGene
pJK101 (control)	URA3	Ap <sup>R</sup>	(2)	The basal activity of the <i>lacZ</i> gene is under control of two <i>lexA</i> operators; used to monitor bait binding to operator sequences (in repression assay).	OriGene
pGNG1	URA3	Ap <sup>R</sup>	8?	<i>lacZ</i> gene is replaced by GFP.	MoBiTec Display Systems
pLexAop-lucU	URA3	Ap <sup>R</sup>	8	<i>lacZ</i> gene is replaced by luciferase.	Fujita et al. (1999)

Reprinted from E.A. Golemis Web Site: [http://www.fccc.edu/research/labs/golemis/com\\_sources1.html](http://www.fccc.edu/research/labs/golemis/com_sources1.html)

<sup>a,b,c</sup>Please see Table 18-1.

TABLE 18-6 Yeast Selection Strains

PLASMID	GENOTYPE	NO. OF OPERATORS	COMMENT/DESCRIPTION	CONTACT/SOURCES <sup>a,b,c</sup>
EGY191	<i>MAT<math>\alpha</math>, trp1, his3, ura3, lexAops-LEU2</i>	2	See comment for EGY48.	OriGene Invitrogen CLONTECH MoBiTec Display
L40	<i>MAT<math>\alpha</math>, trp1, leu2, ade2, GAL4, lexAops-HIS3, lexAops-lacZ</i>	4 8	Expression driven from GAL1 promoter is constitutive in L40 (inducible in EGY strains). Selection is for <i>HIS</i> prototrophy; integrated <i>lacZ</i> reporter is considerably less sensitive than the <i>lacZ</i> reporter carried on pSH18-34 in EGY strains.	Invitrogen
RFY206	<i>MAT<math>\alpha</math>, trp1, his3, ura3, leu2, lys2</i>		Used in mating assay.	OriGene

Reprinted from E.A. Golemis Web Site: [http://www.fccc.edu/research/labs/golemis/com\\_sources1.html](http://www.fccc.edu/research/labs/golemis/com_sources1.html)

<sup>a,b,c</sup>Please see Table 18-1.

## METHOD

---

### Construction of a Bait-LexA Fusion Protein

1. Clone the target DNA encoding the protein to be used as bait into the polylinker of a LexA fusion vector (e.g., pMW101 or pMW103) to synthesize an in-frame fusion to LexA. Ensure that a translational stop sequence is present at the carboxyl terminus of the desired bait sequence. The resulting plasmid is referred to as pBait.
2. Set up a series of transformations of the EGY48 *lexAop-LEU2* selection strain of yeast using the following combinations of LexA fusion and *lexAop-lacZ* reporter plasmids:
  - a. pBait + pMW112 (test for activation)
  - b. pSH17-4 + pMW112 (positive control for activation)
  - c. pRFHM1 + pMW112 (negative control for activation)
  - d. pBait + pJK101 (test for repression/DNA binding)
  - e. pRFHM1 + pJK101 (positive control for repression)
  - f. pJK101 alone (negative control for repression)

For a description of the function of each of the plasmids, please see Tables 18-1 and 18-2.

3. Plate each transformation mixture on selective dropout plates: CM(Glu)-Ura-His (for plasmid combinations **a–e**) or CM(Glu)-Ura (for plasmid combination **f**), as appropriate. Incubate the plates for 2–3 days at 30°C to select for transformed yeast colonies that contain the plasmids.

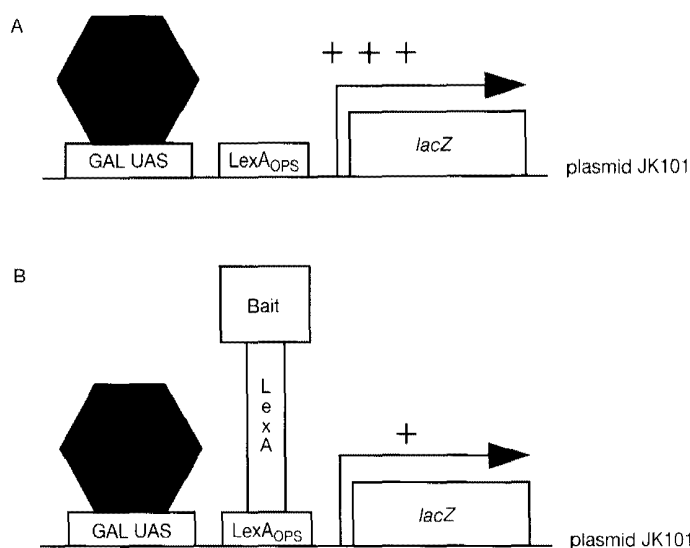
If colonies are not apparent within 3–4 days, or if only a very small number (<20) of colonies are obtained, transformation should be repeated.
4. Make a master plate of transformants, from which specific colonies can be assayed for the phenotype of activation of *lacZ* and *LEU2* reporters as described in Steps 5–9.

### Characterization of Activation and Repression Activity: Assay for X-gal and Leu2 Phenotype

Steps 5–9 are used to test the bait-LexA fusion protein for transcriptional activity and to demonstrate that the fusion of the bait does not affect LexA DNA-binding activity (for an illustration of the repression assay, please see Figure 18-9). Several independent colonies are assayed for each combination of plasmids transformed in Step 2. This is important because, for some bait constructs, the level of protein expression varies among independent colonies, as does the apparent ability to activate transcription of the two reporters. Instead of performing Steps 5–8, a test for activation by the chloroform overlay assay is given in the alternative protocol at the end of Stage 1.

5. From each transformation **a–f** (from Step 2), use sterile, standard flat-edged toothpicks to pick ~8 colonies. Touch a clean toothpick to the colony to pick up cells, and restreak them as a 1-cm-long streak in a grid on a fresh CM(Glu)-Ura-His or CM(Glu)-Ura plate. As many as 60–80 streaks can generally be grown on a single plate. Incubate the plates overnight at 30°C.





**FIGURE 18-9** Repression Assay for DNA-binding (Brent and Ptashne 1984)

Plasmid JK101 contains the upstream-activating sequence (UAS) from the GAL1 gene followed by LexA operators upstream of the *lacZ*-coding sequence. (A) On medium containing galactose, the product of the yeast GAL4 gene accumulates and binds to the GAL upstream-activating sequence (GAL<sub>UAS</sub>). (B) LexA-fused proteins enter the nucleus and bind the *lexA* operator sequences (Lex<sub>OPS</sub>), thereby blocking activation from the GAL<sub>UAS</sub> and repressing  $\beta$ -galactosidase activity three- to fivefold. Note that on glucose X-gal medium, yeast containing JK101 appear as white colonies because GAL<sub>UAS</sub> transcription is repressed. (Redrawn from Spector et al. 1998.)

6. On the second day, restreak from the two master plates to each of the following:

*Transformations a–f*: Streak onto CM(Glu, X-gal)-Ura and onto CM(Gal, X-gal)-Ura

*Transformations a–c*: Streak onto CM(Glu)-Ura-His-Leu and onto CM(Gal)-Ura-His-Leu

Only uracil is dropped out (histidine is present) from the X-gal plates, to allow side-by-side comparison of the JK101 plasmid-only transformation (f) with (d,e). Lack of selection for the LexA-fused plasmid does not notably affect transcriptional activation over the period of this assay.

In general, it is helpful to make a relatively thick streak of yeast (i.e., cells should be visible by eye) on X-gal plates, but a relatively thin streak (i.e., cells barely visible by eye, but detectable by low-power dissecting scope) on –Leu plates. Yeast do not grow as well at neutral pH (buffered to 7.0 to optimize  $\beta$ -galactosidase activity) as they do on normal media (pH ~5.0–5.5). Hence, it is easier to determine a blue-white phenotype if sufficient cells are initially plated so that fewer cell divisions are required. Conversely, if yeast are plated too densely on –Leu plates, sufficient cross-feeding will occur between cells and some growth will occur even in the absence of activation of the reporter, obscuring a true positive result.

Two LexA fusion plasmids (pRFHM1 and pSH17-4) are used as positive and negative controls for assaying transcriptional activation by newly created LexA bait proteins. pMW102 itself (or the related plasmid pEG202) is not a good negative control because the peptide encoded by the uninterrupted polylinker sequence functions as a weak transcriptional activator.

pMW112 (and related plasmid pSH18-34) is one of the most sensitive *lacZ* reporters available and will detect any potential ability to activate *lacZ* transcription. However, for some baits, the *LEU2* reporter in yeast strain EGY48 is even more sensitive than the pSH18-34 reporter, so it is possible that a bait protein that gives little or no signal in a  $\beta$ -galactosidase assay would nevertheless permit some level of growth on –Leu medium. If the streak of cells derived by transformation with positive control plasmids (pSH17-4 and pMW112) does not turn deep blue on X-gal plates within 1–2 days, there may be a problem with the plates.

TABLE 18-7 Expected Results for a "Well-behaved" Bait

ASSAY	PLASMIDS TO TRANSFORM		ANTICIPATED RESULTS		
			X-GAL PLATES		GROWTH
	REPORTER	LEXA FUSION	GLU	GAL	LEU-GAL
Activation					
test	pMW112	pBait	white/ light blue	white/ light blue	(no)
negative control	pMW112	pRFHM1	white	white	no
positive control	pMW112	pSH17-4	blue	blue	yes
Repression					
test	pJK101	pBait	(white)	(lighter blue)	
negative control	pJK101	–	white	blue	do NOT test
positive control	pJK101	pRFHM1	white	lighter blue	

See text for details.

7. Incubate the plates for up to 4 days at 30°C.
8. Assay for repression and activation activities:
  - a. For repression, observe the X-gal phenotype at ~12–24 hours after streaking.
  - b. For activation, observe the X-gal phenotype between 18 and 72 hours after streaking.
  - c. Observe the Leu2 phenotype between 48 and 96 hours. The expected results for a well-behaved bait are given in Table 18-7 and are summarized below.
    - Optimally, at 12–24 hours after streaking to CM(Gal, X-gal)-Ura, the **d** + **e** transformants should be discernibly lighter in color than **f**.
    - At 48 hours after streaking to CM(Glu, X-gal)-Ura, **b** transformants should be bright blue, **c** should be white, and **a** should be white or very light blue.
    - At 48 hours after streaking, **b** transformants should be as well grown on CM(Glu)-Ura-His-Leu or CM(Gal)-Ura-His-Leu as on a CM(Glu)-Ura-His master plate, whereas **a** and **c** should show no growth.
    - Ideally, **a** transformants will still display no apparent growth at 96 hours after streaking.
9. Select the appropriate candidate colonies, based on the results of the repression and activation assays.

In an optimal experiment, colonies assayed from each transformation **a–f** would all possess equivalent phenotypes in activation and repression assays. For a small number of baits, this is not the case. Typically, some colonies are white on X-gal and do not grow on –Leu medium, whereas the remaining colonies display some degree of blueness and growth. *Do not* select the white, nongrowing colonies as the starting point in a library screen; generally, these colonies possess these phenotypes because they are synthesizing little or no bait protein (as determined by western blot, Step 17). Although the reasons for this are not clear, it appears to be a bait-specific phenomenon and may be linked to some degree of toxicity of continued expression of particular proteins in yeast. It will be necessary to adjust the sensitivity of the assay to allow work with blue/growing colonies (see below). For a small percentage of baits, the repression assay does not work, although the bait protein is clearly made at high levels. In these cases, it is generally reasonable to proceed with the library screen.

## Detection of Bait Protein Expression

10. On the master plate, mark the colonies that are to be assayed for protein expression. Use the colony that has been shown to express bait appropriately as the founder to grow a culture for transformation of a library (in Stage 2).
11. Analyze at least two primary transformants for each novel bait construct. Include two transformants as positive controls for protein expression (e.g., pRFHMI).
  - a. Use a sterile toothpick to pick colonies from the CM(Glu)-Ura-His master plate into CM(Glu)-Ura-His liquid medium.
 

If gloves are worn, the toothpick can be dropped into the culture tube and left there without fear of contamination.
  - b. Grow the cultures overnight on a roller drum or other shaker at 30°C.
  - c. In the morning, dilute the saturated cultures into fresh tubes containing 3–5 ml of CM(Glu)-Ura-His, with a starting density of  $OD_{600}$  of ~0.15. Incubate the cultures for 4–6 hours at 30°C until the optical density has doubled approximately twice ( $OD_{600}$  ~0.45–0.7).
12. Transfer 1.5 ml of each culture to a microfuge tube, and centrifuge the cells at maximum speed for 3–5 minutes in a microfuge. The volume of the visible pellet should be 2–5  $\mu$ l. Carefully decant or aspirate the supernatant.
 

Some (although not all) LexA fusion proteins exhibit sharp decreases in detectable levels of protein with the onset of stationary phase of growth. Thus, it is not desirable to allow the cultures to proceed to saturation in the hopes of increasing the yield of protein to assay.

It may be helpful to freeze duplicate samples at this stage if more than one round of assay is anticipated.
13. Add 50  $\mu$ l of 2X SDS gel-loading buffer to the tube, and vortex the tube rapidly to resuspend the pellet. Immediately place the tube either on dry ice or in a dry ice/ethanol bath.
 

Samples may be either used for immediate assay or frozen at –70°C, where they will remain stable for at least 4–6 months.
14. Transfer the samples from the dry ice or –70°C directly to 100°C and boil them for 5 minutes.
 

A PCR machine set to 100°C is most convenient, although a water bath or heat block can also be used.
15. Chill the samples on ice and centrifuge them at maximum speed for 5–30 seconds in a microfuge to pellet large cell debris. Load 20–50  $\mu$ l into each lane of a SDS-polyacrylamide gel.
16. Run the gel and analyze the products to determine whether bait protein of the expected size is expressed at reasonable levels.
17. To anticipate and forestall potential problems, analyze the lysates of yeast containing LexA-fused baits by immunoblotting (please see the note to this step).

Immunoblotting may be performed as described in Appendix 8. LexA fusions can be visualized using antibody to the fusion domain, if available, or alternatively, using antibody to LexA.

An important step in the characterization of a bait protein is direct assay of whether the bait is detectably expressed and whether the bait is of the correct size. In most cases, both of the above will be true. However, some proteins (especially where the fusion domain is ~60–80 kD or larger) will either be synthesized at very low levels or be posttranslationally clipped by yeast proteases. Either of these two outcomes can lead to problems in library screens. Proteins expressed at low levels, and apparently inactive in transcriptional activation assays, can be up-regulated to much higher levels under leucine selection and then suddenly demonstrate a high background of transcriptional activation. Where proteins are proteolytically clipped, screens may be performed inadvertently with LexA fused only to the amino-terminal end of the larger intended bait.

**TROUBLESHOOTING AND MODIFICATIONS OF BAITS**

Some basic bait problems can be identified and corrected before screening:

- **The bait activates transcription.** This problem can be addressed by constructing a series of truncations of the protein in an attempt to eliminate the activation domain. If the bait activates transcription very strongly, i.e., as efficiently as the positive control, this step will probably be necessary.  
If the bait activates moderately, the simplest approach is to redo the control experiments using less-stringent reporter plasmids and strains (please see Table 18-5), to determine if activation is reduced to an acceptable level. Alternatively, the protein can be truncated, as for a strong activator. Finally, it is possible to use an integrating form of bait vector (see Table 18-1), which will result in a stable reduction of protein levels.  
If the bait is a weak activator, one option is to use less-stringent reporter plasmids; alternatively, the investigator may choose to proceed with the tested reagents, accepting the risk that a background of false positives may be identified. In general, it is a good idea to use the most sensitive screening conditions possible; in some cases, use of very stringent interaction strains eliminates detection of biologically relevant interactions (Estojak et al. 1995).
- **The bait plasmid produces an inappropriate level or size of protein.** If the protein is poorly expressed or is very large, it may be subdivided into two or three overlapping constructs, each of which can be tested independently. Alternatively, the vector pJK202 incorporates a nuclear localization sequence, which increases the concentration of the bait in the nucleus, where it is useful; this approach may make the best of a situation where a protein cannot readily be expressed at higher levels.
- **Very few transformants containing the bait plasmid express the bait protein, or yeasts expressing the bait protein grow noticeably more poorly than control yeast in the absence of any selection.** These results would suggest that the bait protein is somewhat toxic to the yeast. Because toxicity can cause difficulties in library screening, it may be desirable to reclon the protein of interest into pGilda, which allows inducible expression of the protein from the GAL1 promoter, thus limiting time of expression of the protein to actual selection. Note, however, that tests with a pGilda construct should be performed on medium containing galactose as a carbon source.

**ALTERNATIVE PROTOCOL: ASSAY OF  $\beta$ -GALACTOSIDASE ACTIVITY BY CHLOROFORM OVERLAY**

For each combination of plasmids transformed in Step 2, a series of independent colonies are tested for activation using the chloroform overlay assay (adapted from Duttweiler 1996). Although somewhat laborious, this technique is generally more sensitive than the standard X-gal plate assay described in Steps 5–8 above. The following sequence is to be performed in place of Steps 5–8 of the main protocol.

**CAUTION:** Please see Appendix 12 for appropriate handling of materials marked with <!.>.

**Additional Materials**

*Chloroform* <!.>

1% low-melting agarose in 100 mM  $\text{KHPO}_4$  (pH 7.0), melted and cooled to 60°C

20 mg/ml X-gal

Yeast selective agar plates (please see Table 18-4 for recipes)

CM(Glu)-Ura-His

CM(Glu)-Ura

CM(Gal)-Ura (use the analogous recipe containing glucose, but substitute 20 g of galactose)

CM(Gal)-Ura-His-Leu

Microtiter plate (96-well)

Multichannel pipettor or Inoculating manifold/frogger (e.g., DANKAR Scientific)

**Method**

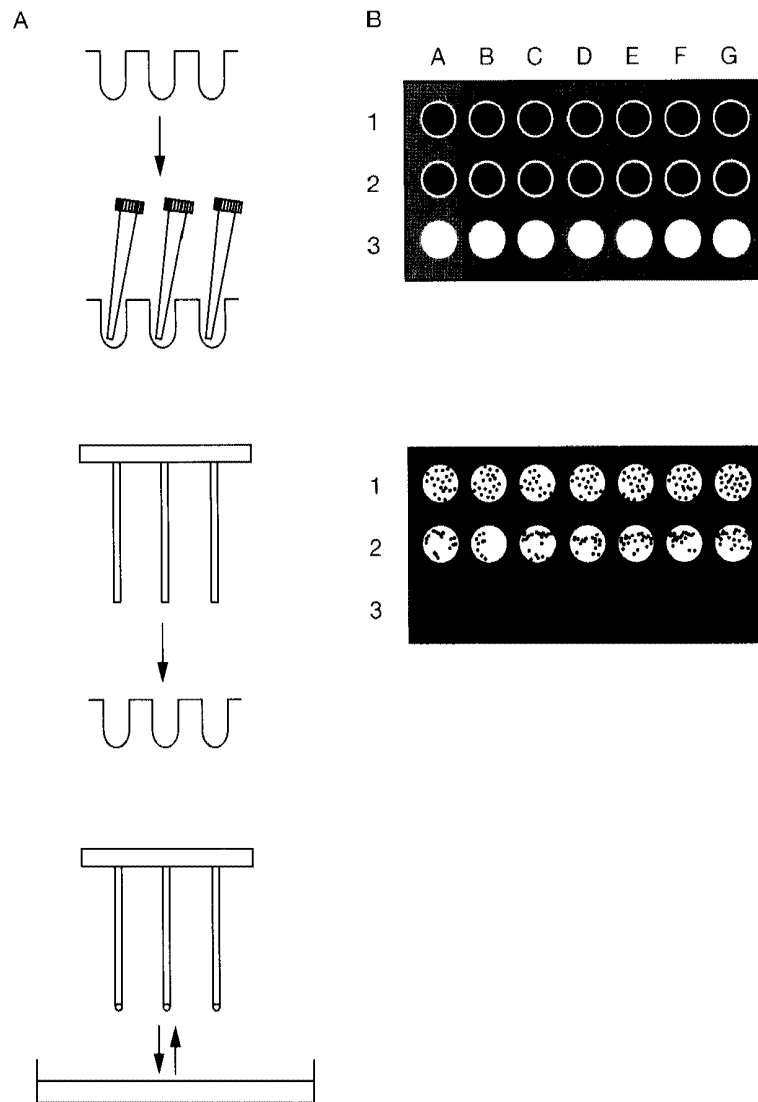
- Deliver 25–30  $\mu\text{l}$  of sterile  $\text{H}_2\text{O}$  into 48 wells of a 96-well microtiter plate.
- For each set of transformations **a–f** from Step 2 of the main protocol, use a sterile toothpick to transfer and disperse eight colonies, individually, into wells containing sterile  $\text{H}_2\text{O}$  (one half of the 96-well microtiter plate).
- Use a multichannel pipettor or an inoculating manifold/frogger to plate an approximately equal volume (~3  $\mu\text{l}$ ) of each yeast suspension onto the following plates:
 

CM(Glu)-Ura-His	2 plates
CM(Glu)-Ura	1 plate
CM(Gal)-Ura	1 plate
CM(Gal)-Ura-His-Leu	1 plate
- Using the second half of the microtiter plate, make a 1:10 dilution of yeast suspension into sterile  $\text{H}_2\text{O}$  for use in the activation assay. Plate the dilution on additional CM(Gal)-Ura-His and CM(Gal)-Ura-His-Leu plates. Incubate the cultures overnight at 30°C (-Ura-His or -Ura plates) before assaying for  $\beta$ -galactosidase activity, or for 3–4 days (-Leu plates) to monitor for growth.
- Add chloroform to the transformants.
  - Select one CM(Gal)-Ura plate and one CM(Glu)-Ura-His plate containing yeast transformants.
  - Gently overlay each plate with chloroform (~5 ml). Pipette the chloroform slowly in from the side so as not to smear any colonies.
  - Leave the colonies completely covered with chloroform for 5 minutes. Aspirate the chloroform.
- Briefly rinse the plates with 5 ml of chloroform and let the plates dry for 5 minutes in a chemical fume hood.
- For each plate, take ~7 ml of 1% agarose in 100 mM  $\text{KHPO}_4$  (pH 7.0), melted and cooled to ~60°C, and add X-gal to 0.25 mg/ml. Overlay the plate with the agarose, making sure that all yeast spots are completely covered.
 

Plates will become chilled during evaporation of chloroform, so it may be difficult to spread <7 ml of top agarose. Work quickly!
- Incubate the plates at 30°C and monitor them for color changes. It is generally useful to check the plates after 20 minutes, and again after 1–3 hours.
 

For the activation assay, strong activators such as the LexA-GAL4 control (pSH17-4) will produce a blue color in 5–10 minutes, and a bait protein (LexA fusion protein) that does so is likely to be unsuitable for use in an interactor hunt. Weak activators will produce a blue color in 1–6 hours (compare with the negative control pRFHM1) and may or may not be suitable (for typical results, please see Figure 18-10).

The repression assay should be monitored within 1–2 hours if using overlay assay/filters, as the high basal LacZ activity will make activation of JK101 impossible to see after longer incubation. A good result (i.e., true repression) will generally reflect a two- to threefold reduction in the degree of blue color detected for JK101 + bait versus JK101 alone on plates containing galactose. Use of X-gal plates, with inspection at 12–24 hours after streaking, is generally somewhat easier.
- Return to the main protocol and continue with Stage 1, Step 9.



**FIGURE 18-10** Replica Technique/Gridding Yeast

(A) Replica technique. Yeast colonies (1–2-mm diameter) picked from transformation plates are resuspended in 25–30  $\mu$ l of sterile distilled  $H_2O$  in wells of a 96-well microtiter plate using sterile toothpicks, plastic pipette tips, or a frogger. When all yeast colonies are resuspended, print replicas onto the appropriate plates. When making prints on a plate, place the frogger on the surface of the solidified medium, tilt it slightly using a circular motion, and then lift the frogger. Make sure that the drops left on the surface are of approximately the same size. Let the liquid absorb to the agar before putting the plates upside down in the incubator. In subsequent transfer between master plates, invert the frogger on the lab bench, and then place the master plate upside down on the spokes, making sure that a proper alignment of the spokes and the colonies is made. (B) Typical results. Patches obtained after printing the yeast suspension on CM(Gal/X-gal)-Ura (top) and CM(Gal)-Ura-His-Trp-Leu (bottom) plates. Seven independent transformants are shown for each LexA fusion. (1A–1G) EGY48 with pMW112 plus strongly activating LexA fusion; (2A–2G) EGY48 with pMW112 plus moderately activating LexA fusion; (3A–3G) EGY48 with pMW112 plus nonactivating LexA fusion. (Redrawn from Spector et al. 1998.)

## STAGE 2: Selecting an Interactor

Screening for interactors generally involves two sequential first platings of yeast. In a first round, yeast strains containing pBait and the *lexAop-lacZ* reporter are plated to select for the library plasmid. Libraries are generally cloned in the vector pJG4-5 (Figure 18-8) or a related plasmid that expresses cDNAs as a cassette with activation domain and other moieties under the control of the inducible GAL1 promoter: The first plating is performed under noninducing conditions, on CM(Glu)-Ura-His-Trp. In the second round, expression of library-encoded proteins is induced with galactose, and yeast that contain interacting proteins are selected by plating on CM(Gal/Raff)-Ura-His-Trp-Leu dropout plates. Finally, library plasmids encoding cDNAs that appear positive on selective media are purified by passage through bacteria, and subsequently retransformed into yeast cells to test the specificity of interaction with the pBait, as described in Stage 3 of this protocol.

A two-step selection is thought to be advantageous for a number of reasons. Most important, many biologically interesting cDNA-encoded proteins have been found to be toxic when constitutively expressed in yeast, and hence might be selected against in an initial mass plating on inducing medium. Additionally, immediately after simultaneous transformation and Gal induction, some interacting proteins may not be expressed at adequate levels to associate effectively with a LexA-fused partner and support growth on medium lacking leucine.

On rare occasions, baits that pass initial controls give rise to large numbers of "positives" during an actual screen. On analysis, these positives appear to arise by de novo acquisition by the bait of the ability to activate transcription. The mechanism by which this occurs is currently unknown. To avoid wasting time and reagents, some investigators test new baits by performing scaled-down screens (only 5–10 plates of transformants) and assessing initial results before proceeding to a full screen: If the background is unacceptably high, the investigator can switch to lower-sensitivity reporter strains and/or plasmids.

A list of available libraries that are compatible with the interaction trap is provided at [www.fccc.edu/research/labs/golemis/librarysources/](http://www.fccc.edu/research/labs/golemis/librarysources/). In addition, other libraries prepared by CLONTECH, OriGene, and Invitrogen are commercially available. The following protocols are designed for saturation screening of a cDNA library derived from a genome of mammalian complexity. Fewer plates are required for screens with libraries derived from organisms with less complex genomes.

### MATERIALS

**CAUTION:** Please see Appendix 12 for appropriate handling of materials marked with <!>.

#### Buffers and Solutions

Please see Appendix 1 for components of stock solutions, buffers, and reagents.  
Dilute stock solutions to the appropriate concentrations.

*Dimethylsulfoxide (DMSO)* <!>

*Ethanol*

Optional, please see Step 9.

*Sterile glycerol solution for freezing transformants*

65% sterile glycerol

0.1 M MgSO<sub>4</sub>

25 mM Tris-HCl (pH 8.0)

TE (pH 7.5) (sterile)

TE (pH 7.5) containing 0.1 M lithium acetate

TE (pH 7.5) containing 40% PEG 4000 and 0.1 M lithium acetate (sterile)

## Nucleic Acids and Oligonucleotides

### Carrier DNA

Sheared salmon sperm DNA is typically used as carrier. It is extremely important that this DNA be of very high quality; use of a poor-quality preparation can drop transformation frequencies one to two orders of magnitude. For a simple procedure for generating high-quality salmon sperm DNA, please see Schiestl and Gietz (1989) and Chapter 6, Protocol 10; alternatively, a number of companies sell such preparations commercially.

### Library to be screened for interaction

Interaction trap libraries are available commercially from, for example, CLONTECH (MatchMaker System), Invitrogen, OriGene, Display, MoBiTech (for a comprehensive listing of libraries from various species and tissue sources, please see [www.fccc.edu/research/labs/golemis/lib\\_sources.html](http://www.fccc.edu/research/labs/golemis/lib_sources.html)).

## Media

**Please see Appendix 2 for components of yeast media.**

### CM selective medium

Use Table 18-3 to estimate the amount of media required and Table 18-8 to prepare the necessary selective media.

Yeast nitrogen base without amino acids (YNB) is sold either with or without ammonium sulfate. Table 18-8 assumes that the YNB contains ammonium sulfate. If the bottle of yeast nitrogen base instructs that 1.7 g/liter be added to make media, then it *does not* contain ammonium sulfate and 5 g of ammonium sulfate per liter of media should be added.

### Yeast selective X-gal medium

- i. Prepare the base medium in 900 ml of H<sub>2</sub>O, according to Table 18-8. Autoclave the base medium and cool it to 55°C.
- ii. In a separate bottle, autoclave 7 g of sodium phosphate (dibasic) and 3 g of sodium phosphate (monobasic) in 100 ml of distilled H<sub>2</sub>O.
- iii. Mix the two autoclaved solutions together, and add 0.8 ml of 100 mg/ml X-gal (in *N,N*-dimethyl formamide <math>\langle ! \rangle</math>). Pour the plates.

## Centrifuges and Rotors

*Sorvall GSA rotor or equivalent*

*Sorvall RT6000 centrifuge and H1000B rotor or equivalent*

## Special Equipment

*Culture plates (24 x 24 cm) for selective media (see Table 18-3)*

These plates are quite expensive, but they can be reused many times (see Step 9).

*Falcon tubes (50 ml, sterile)*

*Glass beads (0.45-mm diameter, sterile; Sigma)*

Optional, please see Step 9.

*Heat block preset to 42°C*

*Microtiter plate (96-well)*

Optional, please see Step 21.

*Multichannel pipettor or Inoculating manifold/frogger (e.g., Dankar Scientific)*

Optional, please see Step 21.

A frogger for the transfer of multiple colonies can be purchased or easily homemade; it is important that all of the spokes have a flat surface and that the spoke ends are level. The frogger can be sterilized by autoclaving or by flaming in alcohol.

## Vectors and Bacterial or Yeast strains

*S. cerevisiae candidate strains carrying vectors expressing the bait and lexAop-lacZ reporter (from Stage 1)*



TABLE 18-8 Yeast CM Selective Media for Two-hybrid Analysis

INGREDIENTS	CM (GLU) -U-H	CM (GLU) -U-H-T	CM (GLU) -U-H-T-L	CM (GLU, X-GAL) -U-H-T	CM (GAL) -U-H-T	CM (GAL, RAFF) -U-H-T	CM (GAL, RAFF) -U-H-T-L	CM (GAL, RAFF, X-GAL) -U-H-T
	MEDIUM	AGAR	AGAR	AGAR <sup>a</sup>	AGAR	MEDIUM	AGAR	AGAR <sup>a</sup>
YNB	6.7 g	6.7 g	6.7 g	6.7 g	6.7 g	6.7 g	6.7 g	6.7 g
Glucose	20 g	20 g	20 g	20 g				
Galactose					20 g	20 g	20 g	20 g
Raffinose						10 g	10 g	10 g
Dropout mix	2 g	2 g	2 g	2 g	2 g	2 g	2 g	2 g
Leucine	15 ml	15 ml		15 ml	15 ml	15 ml		15 ml
Tryptophan	10 ml							
Agar		20 g	20 g	20 g	20 g		20 g	20 g

To prepare medium or agar, mix the ingredients together in a final volume of 1 liter of H<sub>2</sub>O. Autoclave for 20 minutes. Cool the agar medium to 50°C before pouring plates: Leucine stock = 4 mg/ml; Tryptophan stock = 4 mg/ml; Histidine stock = 4 mg/ml.

<sup>a</sup>For media containing X-gal, prepare the appropriate base medium in 900 ml of H<sub>2</sub>O, and use it in the recipe for yeast selective X-gal medium.

## METHOD

### Transforming the Library

1. Select a yeast colony, expressing the bait and *lexAop-lacZ* reporter, that was shown in Stage 1 to be optimal in the initial control experiments. From this colony, grow a 20-ml culture in CM(Glu)-Ura-His liquid dropout medium overnight at 30°C on a roller drum.
 

▲ **IMPORTANT** The bait and *lexAop-lacZ* reporter plasmids should have been transformed into the yeast <7–10 days before retransformation with the library. It is important to maintain sterile conditions throughout.
2. Dilute the 20-ml overnight culture into 300 ml of CM(Glu)-Ura-His liquid dropout medium such that the diluted culture has an OD<sub>600</sub> of ~0.10–0.15. Incubate the culture at 30°C on an orbital shaker until the culture has gone through 1.5 doublings, to reach an OD<sub>600</sub> of ~0.50.
3. Transfer the culture to sterile 250-ml centrifuge bottles, and centrifuge them at 1000–1500g (2500–3000 rpm in a Sorvall GSA rotor) for 5 minutes at room temperature. Remove the supernatant and add 30 ml of sterile H<sub>2</sub>O to the pellet. Resuspend the pellet by gently rapping the bottle against a countertop. Transfer the slurry to a sterile 50-ml Falcon tube.
4. Centrifuge the cells at 1000–1500g (2500–3000 rpm in a Sorvall GSA rotor) for 5 minutes. Pour off the H<sub>2</sub>O and resuspend the yeast cells in 1.5 ml of TE (pH 7.5) containing 0.1 M lithium acetate.
5. Add 1 µg of library DNA and 50 µg of freshly denatured carrier DNA to each of 30 sterile 1.5-ml microfuge tubes. Immediately add 50 µl of the yeast suspension (from Step 4) to each of the 30 tubes.

A good transformation should yield ~10<sup>5</sup> transformants/µg of library DNA. The use of small volumes of DNA (optimally, <10 µl/transformation tube) generally enhances transformation efficiency.

Transformation of yeast in multiple small aliquots in parallel helps reduce the likelihood of contamination, and it frequently results in significantly better transformation efficiency than that obtained by using larger volumes in a smaller number of tubes. Do not use an excess of transforming library DNA per aliquot of competent yeast cells, or each competent cell may take up multiple library plasmids, complicating subsequent analysis.

6. To each tube of the cell suspensions, add 300  $\mu$ l of sterile TE (pH 7.5) containing 40% PEG 4000 and 0.1 M lithium acetate. Mix by gently inverting the tubes a number of times (do not vortex). Incubate the tubes for 30–60 minutes at 30°C.
7. To each tube, add 40  $\mu$ l of DMSO, and mix the suspensions by inversion. Place the tubes in a heating block for 10 minutes at 42°C.
8. Plate the transformation mixtures as follows:

**FOR 28 OF THE TUBES TO BE USED SOLELY TO GENERATE TRANSFORMANTS**

- a. Pipette the contents of each tube onto 24  $\times$  24-cm CM(Glu)-Ura-His-Trp dropout plates.
- b. Spread the cells evenly and incubate the plates at 30°C until colonies appear.

24  $\times$  24-cm plates will each require 250–300 ml of medium, and should be allowed to dry at room temperature for 1–2 days after pouring, before being used. To reduce the chance of contamination, flame the surface of plates after pouring. Some investigators take the additional step of placing the open plates and inverted lids under UV light in a standard tissue culture hood for ~10 minutes.

**FOR THE 2 REMAINING TUBES TO BE USED TO ASSESS TRANSFORMATION EFFICIENCY**

- a. Pipette 350  $\mu$ l from each tube to 24  $\times$  24-cm CM(Glu)-Ura-His-Trp dropout plates.
- b. Spread the cells evenly and incubate the plates at 30°C until colonies appear.
- c. Pipette the remaining 40  $\mu$ l from each tube to make a series (at least 3) of 1:10 dilutions in sterile TE (pH 7.5) or H<sub>2</sub>O.
- d. Plate 100  $\mu$ l of each dilution on 100-mm CM(Glu)-Ura-His-Trp dropout plates, and incubate the plates at 30°C until colonies appear.

Analysis of the dilution series will provide an estimation of the number of transformants obtained. Occasionally, the number of predicted transformant colonies arising on the 100-mm indicator plates differs significantly from the number on the 24  $\times$  24-cm plates, particularly if the plates are from different batches. A good transformation should yield 20,000–40,000 colonies/large plate.

## Harvesting and Pooling of Primary Transformants

Steps 9–14 generate a frozen stock representative of the complete set of primary transformants, which can be used in subsequent selection. In this process, a homogenized slurry is prepared from the pool of primary transformants ( $\sim 10^6$  cells), from which aliquots can be used to plate on to selective medium. This technique substitutes for more conventional methods of transferring yeast (e.g., replica plating), which transfer such large numbers of cells that some degree of growth is observed on selective plates, resulting in spurious background. If visible molds or other contaminants are observed on the plates, use a sterile razor blade to carefully excise them and the surrounding region before harvesting library transformants.

In Step 9, the first technique (by agitation) is faster to perform, and allows induction of the library and screening on selective plates to be carried out on the same day, and it also minimizes the time the plates are open, thus avoiding contamination from airborne molds and bacteria. About one third of the yeast slurry will be left on the plates; however, normally no more than 2% of the collected slurry is used, so it is important to ensure that colonies are washed from the plates with approximately equal efficiency. The second technique (by scraping) in Step 9 is more eco-

nomical of reagents and may be easier to use on plates from which molds and contaminants have been excised.

9. Harvest the library using one of the following methods.

#### TO HARVEST THE LIBRARY BY AGITATION

- a. Pour 10 ml of sterile H<sub>2</sub>O and approximately 30 sterile glass beads on each of five 24 x 24-cm plates containing transformants.
- b. Stack the five plates on top of one another, and, holding the plates tightly, shake the stack until all the colonies are resuspended (1–2 minutes).
- c. Use a sterile pipette to collect 5 ml of yeast slurry from each plate (tilt the plate). Pool the slurry into sterile 50-ml conical tubes.
- d. Proceed to the next five plates and repeat Steps a–c. Continue harvesting yeast cells from all 30 plates, resulting in a total volume of 150 ml of liquid contained in three 50-ml tubes.

The same glass beads can be transferred to the fresh plates or new ones may be used. More than five plates can be washed off simultaneously, as many as can be held in the hands and shaken.

The plates can be reused many times. After cells have been harvested, remove the remaining agar, wash the plates, wipe with alcohol, expose to UV for 10 minutes, and store until needed.

#### TO HARVEST THE LIBRARY BY SCRAPING

- a. Wearing gloves, place the 30 24 x 24-cm plates containing transformants at 4°C to harden the agar (generally, 2 hours to overnight is acceptable).
- b. Sterilize a glass microscope slide by immersing it in ethanol and flaming; use this slide to scrape yeast cells gently from the transformation plates into 50-ml conical tubes. Reflame or use a fresh slide at intervals (every 5–10 plates).
 

Cells from all 30 plates can generally be pooled into one or two sterile 50-ml conical tubes.

The plates can be reused many times. After cells have been harvested, remove the remaining agar, wash the plates, wipe with alcohol, expose to UV for 10 minutes, and store until needed.
10. If necessary, fill each conical tube containing yeast to the 40–45-ml mark with sterile TE (pH 7.5) or H<sub>2</sub>O, and vortex or invert the tubes to suspend cells.
11. Centrifuge the tubes in a benchtop centrifuge at 1000–1500g (2200–2700 rpm using a Sorvall H1000B rotor) for 5 minutes at room temperature, and discard the supernatant.
12. Repeat Steps 10 and 11.
 

After the second wash, the total volume of the cell pellet derived from  $1.5 \times 10^6$  transformants should be 25 ml of cells.
13. Resuspend the packed cell pellet in 1 volume of sterile glycerol solution. Combine the contents of the different Falcon tubes and mix thoroughly.
14. Transfer 1-ml aliquots into a series of sterile microfuge tubes, and freeze at –70°C (cells remain stable for at least 1 year).

If proceeding directly to plating on selective medium (which requires 5 hours to complete), leave one aliquot unfrozen and carry out the next sequence of steps. Assume that the viability of the unfrozen culture is 100%. In general, for yeast frozen for <1 year, the expected viability will be >90%. If there is any cause for concern (i.e., particularly if no colonies are obtained following plating of the frozen aliquots on selective medium), measure the viability of the frozen cells by performing a series of limiting dilutions on CM(Glu)-Trp-His-Ura.

## Screening for Interacting Proteins

Aliquots of the transformed library are plated on  $-Leu$  selective media to test for the inability to promote *LEU2* transcription. Not all cells containing interacting proteins plate at 100% efficiency on  $-Leu$  selective medium (Estojak et al. 1995). To maximize the chance of detecting interaction, each primary colony obtained from the library transformation should be represented on the selection plate by three to ten viable yeast cells. For example, if  $5 \times 10^5$  colonies had been initially obtained, between  $1.5 \times 10^6$  and  $5 \times 10^6$  cells would be plated on two to five plates. Although this practice may result in redundant isolations of the same cDNA, it helps to ensure that all primary transformants are represented by at least one cell on the selective plate; in fact, reisolation of an identical cDNA among a relatively small set of "positives" can be taken as one sign of a specific protein-protein interaction.

15. Thaw one aliquot of library-transformed yeast (from Step 14), and dilute 1:10 with CM(Gal-Raff)-Ura-His-Trp dropout medium. Incubate the yeast with shaking for 4 hours at 30°C to induce transcription from the GAL1 promoter on the library.

16. Plate  $10^6$  cells (or 50  $\mu$ l of a culture at  $OD_{600} = 1.0$ ) on each of an appropriate number of 100-mm CM(Gal/Raff)-Ura-His-Trp-Leu dropout plates.

▲ **IMPORTANT** The value of  $10^6$  cells per plate is the highest plating density that generally can be effectively used. Plating at higher densities (e.g.,  $3 \times 10^6$ ) can result in cross-feeding between yeast cells, resulting in high background growth.

17. Incubate the plates for 5 days at 30°C.

Depending on the individual bait used, good candidates for positive interactors will generally produce colonies within 5 days, with the most of colonies appearing at 2–4 days.

18. Observe the plates for growth and mark colonies as they appear.

A good strategy (especially if a large number of colonies appear to be growing) is to observe the plates on a daily basis, but not necessarily to pick colonies immediately. Instead, on the first day that the colonies are visible by eye, mark their location on the plate with a dot of a given color from a lab marker (e.g., day 3 = red). Each day, mark nascent colonies with distinctive colors (day 4 = blue, etc).

19. At day 5, create a master plate (CM[Glu]-Ura-His-Trp) on which colonies are grouped by day of appearance.

If many apparent positives appear, it may be necessary to create separate plates with colonies obtained on day 2, on day 3, and on day 4. To generate a negative control for subsequent steps, pick at random 3–5 colonies from the plates used to determine viability (please see note to Step 14), and streak them in parallel on the master plates to be tested. If using a manifold/frogger for subsequent assay steps (see Step 21), make sure that the streaks are gridded in such a way that colonies will correspond to the spokes on a frogger (please see Figure 18-10).

20. Incubate the plates at 30°C until patches/colonies form.

### TROUBLESHOOTING

- Colonies arising more than 1 week after plating are not likely to represent bona fide positives. In tests of master plates, true interactors tend to come up in a window of time specific for a given bait, with false positives clustering at a different time point; hence, grouping the colonies as they grow by their date of appearance facilitates the decision of which clones to analyze first. If using a replica technique, it is worthwhile making an extra master plate containing glucose (please see note to Step 19).
- Contamination that has occurred at an early step (i.e., during plate scraping) is generally manifest by the rapid growth (24 hours or less) of many (>500) colonies per plate. If contamination can be confirmed to be bacterial, one option is to prepare new selective plates that contain 15  $\mu$ g/ml tetracycline, and repeat the library induction and plating.

### First Confirmation of Positive Interactions: Test for $\beta$ -galactosidase Activity and for Leu Requirement

Steps 21 and 22 test for galactose-inducible transcriptional activation of both the *lexAop-LEU2* and *lexAop-lacZ* reporters. Simultaneous activation of both reporters in a galactose-specific manner generally indicates that the transcriptional phenotype is due to expression of library-encoded proteins, rather than mutation of the yeast host. A master plate containing glucose and leucine is used as a source for test colonies.

#### 21. Assay for transcription activation.

The assays can be performed by either restreaking colonies with a toothpick or utilizing a manifold/frogger, which is particularly useful when analyzing a large number of positive colonies (for details on the use of a frogger, please see Figure 18-10).

#### TO ASSAY BY DIRECT STREAKING

- a. On each of the four following plates, use a flat-edged toothpick to replicate the grid from the master plate. Use the same toothpick to streak an individual colony across the four plates. Try to get a thick streak of yeast on plates containing X-gal, and a thin streak of yeast on plates lacking leucine.

CM(Glu/Xgal)-Ura-His-Trp	1 plate
CM(Gal/Raff/Xgal)-Ura-His-Trp	1 plate
CM(Glu)-Ura-His-Trp-Leu	1 plate
CM(Gal/Raf)-Ura-His-Trp-Leu	1 plate

- b. Incubate the plates for 3–4 days at 30°C.

X-gal plates will yield results within 48 hours, with the strongest interactions appearing as early as 18 hours. Differential growth on leucine will generally be apparent between 48 and 72 hours.

#### TO ASSAY USING A MANIFOLD/FROGGER

- a. Deliver 25–30  $\mu$ l of sterile H<sub>2</sub>O into 48 wells of a 96-well microtiter plate.
- b. Use a frogger to transfer patches simultaneously from a pregridded master plate to the wells of a microtiter plate. Agitate the plate gently.
- c. Use the frogger to transfer yeast from the microtiter plate to each of the following plates. This approach allows approximately equal quantities of cells to be transferred to each plate.

CM(Glu)-Ura-His-Trp	2 plates
CM(Gal)-Ura-His-Trp	1 plate
CM(Glu)-Ura-His-Trp-Leu	1 plate
CM(Gal/Raff)-Ura-His-Trp-Leu	1 plate

- d. Incubate the plates for 3–4 days at 30°C. After 1 day of incubation, use one CM(Glu)-Ura-His-Trp plate and one CM(Gal)-Ura-His-Trp plate to assay for activation of the *lacZ* reporter, using the chloroform overlay assay (please see the panel on **ALTERNATIVE PROTOCOL: ASSAY OF  $\beta$ -GALACTOSIDASE ACTIVITY BY CHLOROFORM OVERLAY** at the end of Stage 1).

- e. Continue to monitor growth: Differential growth on leucine will generally be apparent between 48 and 72 hours on the -Leu plates. The second CM(Glu)-Ura-His-Trp plate can be taken as a fresh master plate.
22. Interpret the results. Colonies and the library plasmids they contain are designated as first-round positives if:
- X-Gal analysis indicates blue color following culture on CM(Gal)-Ura-His-Trp plates.
  - X-Gal analysis indicates white, or only faintly blue, following culture on CM(Glu)-Ura-His-Trp plates.
  - Colonies grow well on CM(Gal/Raff)-Ura-His-Trp-Leu plates.
  - Colonies grow poorly or not at all on CM(Glu)-Ura-His-Trp-Leu plates.

#### TROUBLESHOOTING/ANALYSIS

In very rare cases, if an interaction occurs with high affinity, and both proteins are stable in yeast, a weak enhancement of growth and X-gal activity will occur on glucose as well as galactose medium. This occurs because low levels of transcription from the GAL1 promoter on glucose medium allow accumulation of sufficient levels of strongly interacting, stable activation domain fusions for an interaction to be detected.

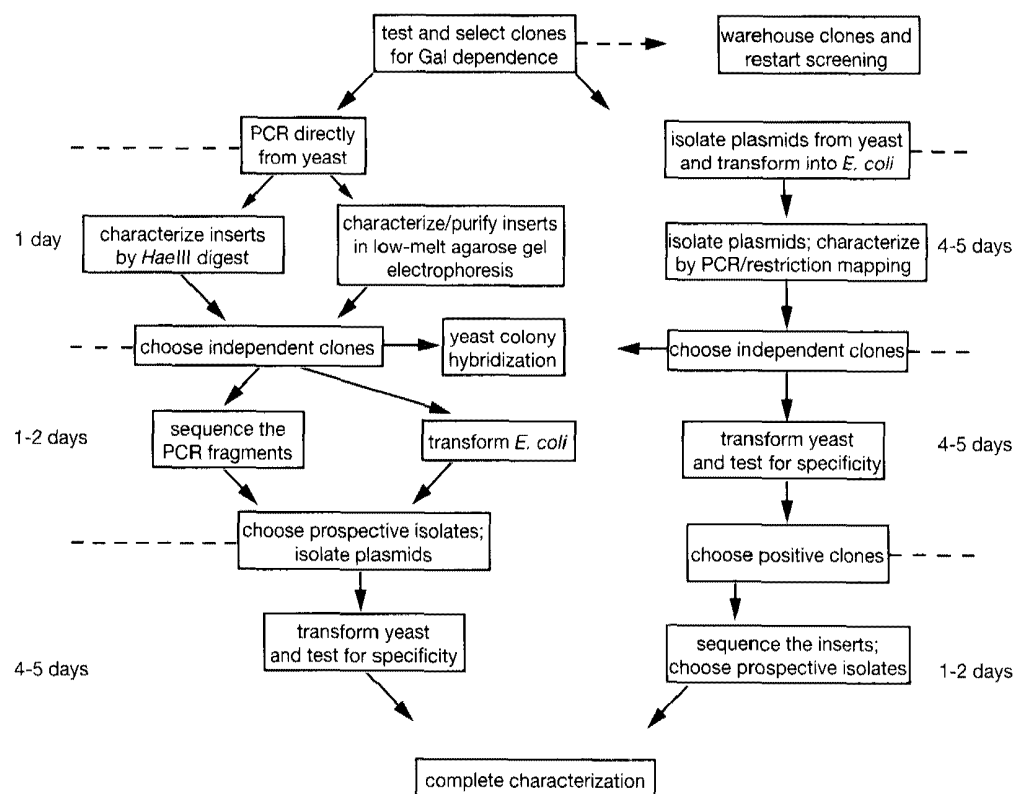
In some cases, strong activation of one of the two *lexAop* reporters will be observed, whereas only poor activation will be observed of the other. Some bait-interactor combinations preferentially activate *lacZ* versus *LEU2*, or vice versa (Estojak et al. 1995). In general, the confidence level for such system-specific interactors is substantially lower than for interactors that strongly activate both reporters. This is particularly the case when strong growth is observed on medium lacking leucine, and virtually no blue color is observed with X-gal. Whether these isolates are pursued is the decision of the investigator.

If no positives are obtained for a given bait, there are several points to consider: (1) The library source is inappropriate or an insufficient number of colonies have been screened; (2) the bait does not interact with any single partner protein with sufficient affinity to be detected (Estojak et al. 1995); and (3) the bait is not in a native conformation, either because of a truncation or because of steric interactions with the fusion domain, or it is not interacting well with the *lexA* operator since some moiety on the fusion protein is sequestering the protein (Golemis and Brent 1992). It is sometimes possible to modify the bait and screening conditions in order to obtain interactors; however, some baits simply do not generate interactors. It is left to the discretion of the investigator as to how much effort to apply in such instances.

### STAGE 3: Second Confirmation of Positive Interactions

The number of positives obtained in an interactor hunt depends on the individual bait and the suitability of the library. Anywhere from zero to several hundred positive interactors might be identified; advanced predictions are generally difficult. If a reasonably small number (1–30) of interactors are obtained, the steps detailed below can be followed essentially as written. In cases where a very large number of interactors are obtained, it may or may not be desirable to work up all of them at once. An alternative strategy is to “warehouse” most of the positives, and work up 24–48 of the faster-growing clones, which frequently contain the strongest interactors. These clones can be screened for specificity of interaction and grouped by restriction digest analysis and/or sequenced to determine whether they are all unique cDNAs or whether they are repeated isolates of a limited number of cDNAs. In the former case (especially if the isolated cDNAs do not make sense biologically in the context of the bait), it is sometimes advisable to reconfigure the initial screen conditions and try again, using a less-sensitive combination of strain and plasmid. Obtaining many different interactors can be a sign of a low-affinity nonspecific interaction. The approach taken depends on the goals and resources of the investigator.

Plasmids isolated from yeast must be transformed into a strain of bacteria suitable for manipulations such as sequencing. Standard laboratory strains such as DH5 $\alpha$  work well. If using the plasmids recommended above (pMW112, pMW102, etc.), which contain drug resistance markers different from those of JG4-5, the only step required is to transform *E. coli* DH5 $\alpha$  by elec-



**FIGURE 18-11 Library Screening Flow Chart**

See text for details. (Redrawn from Spector et al. 1998.)

troporation with isolated plasmid DNA, and plate the transformants onto medium containing ampicillin. Only bacteria that have taken up a library plasmid will grow. Transformation by electroporation is important: In general, chemical transformation methods work poorly with DNA isolated from yeast.

Two methods for working up positives are described in Figure 18-11. The right-hand sequence of steps is more traditional and has been successfully used in many laboratories: The method emphasizes thorough characterization of specificity of bait-library protein interaction before sequencing. The panel on **ALTERNATIVE PROTOCOL: RAPID SCREEN FOR INTERACTION TRAP POSITIVES** at the end of this protocol relies on an "upside down" approach and is recommended when both PCR and automated sequencing are readily available and affordable. Under the latter conditions, the protocol is 2–3 days faster and minimizes the number of isolates that must be tested for specificity (thus reducing numbers of both *E. coli* and yeast transformations). A final series of specificity tests are described that may be used to verify the interaction-dependent phenotype.

## MATERIALS

---

**CAUTION:** Please see Appendix 12 for appropriate handling of materials marked with <!.>.

### Buffers and Solutions

Please see Appendix 1 for components of stock solutions, buffers, and reagents. Dilute stock solutions to the appropriate concentrations.

*Ammonium acetate (7.5 M)*

*Chloroform <!.>*

*Ethanol*

*Isopropanol*

*Lysis solution*

Zymolyase 100T dissolved to 2–5 mg/ml in rescue buffer

or

$\beta$ -glucuronidase 100,000 units/ml (Sigma) 1:50 in rescue buffer

Prepare fresh solution for each use.

*Phenol (equilibrated to pH 8.0) <!.>*

*Rescue buffer*

50 mM Tris-HCl (pH 7.5)

10 mM EDTA

0.3%  $\beta$ -mercaptoethanol <!.>

Prepare fresh solution for each use.

*SDS (10% w/v)*

*STES lysis solution*

100 mM NaCl

10 mM Tris-HCl (pH 8.0)

1 mM EDTA

0.1% (w/v) SDS

*TE (pH 8.0)*

### Enzymes and Buffers

*Restriction endonucleases EcoRI, XhoI, HaeIII*

### Gels

*Agarose gel*

Please see Step 5.



TABLE 18-9 Yeast CM Selective Media for Two-hybrid Analysis

INGREDIENTS	CM (GLU) -T MEDIUM	CM (GLU) -U-H AGAR	CM (GLU) -U-H-T AGAR	CM (GLU) -U-H-T-L AGAR	CM (GLU, X-GAL) -U-H-T AGAR <sup>a</sup>	CM(GAL, RAFF, X-GAL) -U-H-T AGAR <sup>a</sup>	CM (GAL,RAFF) -U-H-T-L AGAR
YNB	6.7 g	6.7 g	6.7 g	6.7 g	6.7 g	6.7 g	6.7 g
Glucose	20 g	20 g	20 g	20 g	20 g		
Galactose						20 g	20 g
Raffinose						10 g	10 g
Dropout mix	2 g	2 g	2 g	2 g	2 g	2 g	2 g
Leucine	15 ml	15 ml	15 ml		15 ml	15 ml	
Tryptophan		10 ml					
Histidine	5 ml						
Uracil	5 ml						
Agar		20 g	20 g	20 g	20 g	20 g	20 g

<sup>a</sup>For media containing X-gal, prepare the appropriate base medium in 900 ml of H<sub>2</sub>O, and use it in the recipe for yeast selective X-gal medium.

To prepare medium or agar, mix the ingredients together in a final volume of 1 liter of H<sub>2</sub>O. Autoclave for 20 minutes. Cool the medium to 50°C before pouring plates: Leucine stock = 4 mg/ml; Tryptophan stock = 4 mg/ml; Histidine stock = 4 mg/ml; Uracil stock = 4 mg/ml.

## Media

Please see Appendix 2 for components of yeast media.

### CM selective medium

Use Table 18-3 to estimate the amount of media required and Table 18-9 to prepare the necessary selective media.

Yeast nitrogen base without amino acids (YNB) is sold either with or without ammonium sulfate. Table 18-9 assumes that the YNB contains ammonium sulfate. If the bottle of yeast nitrogen base infracts that 1.7 g/liter be added to make media, then it *does not* contain ammonium sulfate and 5 g of ammonium sulfate per liter of media should be added.

### LB agar plates containing 50 µg/ml ampicillin

#### Minimal (-trp) medium for bacteria

Prepare the following autoclaved stocks:

- i. 20% (w/v) magnesium sulfate
- ii. 4 mg/ml uracil
- iii. 4 mg/ml histidine
- iv. 4 mg/ml leucine
- v. 20% (w/v) glucose

Prepare the following filter-sterilized solutions:

- vi. 50 mg/ml ampicillin
  - vii. 1% thiamine hydrochloride
- Autoclave the following two solutions separately:
- viii. 15 g of agar in 800 ml of distilled H<sub>2</sub>O
  - ix. 10.5 g of potassium phosphate (dibasic)  
4.5 g of potassium phosphate (monobasic)  
1 g of ammonium sulfate  
0.5 g of sodium citrate  
160 ml of distilled H<sub>2</sub>O

Cool Solutions **viii** and **ix** to 50°C, and mix them together. Quickly add 1 ml of Solution **i**, 10 ml of Solution **ii**, 10 ml of Solution **iii**, 10 ml of Solution **iv**, 10 ml of Solution **v**, 1 ml of Solution **vi**, and 0.5 ml of Solution **vii**. Mix the final solution well and pour the plates immediately.

### Yeast selective X-gal medium

- i. Prepare the base medium in 900 ml of H<sub>2</sub>O, according to Table 18-9. Autoclave the base medium and cool it to 55°C.
- ii. In a separate bottle, autoclave 7 g of sodium phosphate (dibasic) and 3 g of sodium phosphate (monobasic) in 100 ml of distilled H<sub>2</sub>O.
- iii. Mix the two autoclaved solutions together, and add 0.8 ml of 100 mg/ml X-gal (in *N,N*-dimethylformamide <math>\langle ! \rangle</math>). Pour the plates.

## Centrifuges and Rotors

Sorvall RT6000 centrifuge, H1000B MPC and H6000A MPC rotors (for centrifuging microtiter plates)

## Special Equipment

Glass beads (0.45-mm diameter, sterile; Sigma)

Microtiter plate (24-well or 96-well [optional])

Repeating pipettor

Optional, please see Step 1.

## Additional Reagents

Step 2 of this protocol requires the reagents for electroporation listed in Chapter 1, Protocol 26.

Steps 3 and 4 of this protocol require the reagents for the preparation of miniprep DNA from plasmids listed in Chapter 1, Protocol 1.

Step 10 of this protocol requires the reagents for sequencing of yeast DNA listed in Chapter 4, Protocol 13.

## Vectors and Bacterial and Yeast Strains

*E. coli* DH5 $\alpha$  or *E. coli* KC8 (pyrF leuB600 trpC hisB463; CLONTECH), competent for electroporation  
Please see Chapter 1, Protocol 26.

Nonspecific bait plasmid

Please see the note to Step 6.

pMW112, pRFHM-1

pBait (from Stage 1)

Yeast colonies with the appropriate phenotype growing on a CM(Glu)-Ura-His-Trp master plate (identified in Stage 2, Step 21)

Yeast strain EGY48

## METHOD

---

### Isolation of Positive Plasmids

Two approaches are given for the isolation of discrete library plasmids. For the isolation of a small number of colonies, cells are lysed in SDS. For the isolation of a large number of colonies, cells are lysed in Zymolyase.

1. Prepare cell lysates from positive colonies.

#### FOR ISOLATION OF A SMALL NUMBER OF COLONIES

Generally, this approach is most useful when working with ~24–36 positives or less, although some investigators prefer to use this approach to work up the entire set of positives initially obtained, even if such positives number in the hundreds. In this case, it is usually more effective to utilize the alternative protocol at the end of this protocol as a means to distinguish unique from commonly occurring positive clones.

- a. Starting from the CM(Glu)-Ura-His-Trp master plate (Stage 2, Step 21), pick colonies that display the appropriate phenotype on selective plates into 5 ml of –Trp glucose medium. Grow the cultures overnight at 30°C.  
Omitting the -Ura-His selection in this situation encourages loss of nonlibrary plasmids and facilitates isolation of the desired library plasmid.
- b. Centrifuge 1 ml of each culture at maximum speed for 1 minute at room temperature in a microfuge. Resuspend the pellets in 200  $\mu$ l of STES lysis solution, and add 100  $\mu$ l of 0.45-mm-diameter sterile glass beads. Vortex the tubes vigorously for 1 minute.

- c. Add 200  $\mu$ l of equilibrated phenol to each tube, and vortex the tubes vigorously for another minute.
- d. Centrifuge the emulsions at maximum speed for 2 minutes at room temperature in a microfuge, and transfer each aqueous phase to a fresh microfuge tube.
- e. Add 200  $\mu$ l of equilibrated phenol and 100  $\mu$ l of chloroform to each aqueous phase, and vortex for 30 seconds. Centrifuge the emulsions at maximum speed for 2 minutes at room temperature in a microfuge, and transfer each aqueous phase to a fresh tube.
- f. Add two volumes (400  $\mu$ l) of ethanol to each aqueous phase, mix by inversion, and chill the tubes for 20 minutes at  $-20^{\circ}\text{C}$ . Recover the nucleic acid by centrifugation at maximum speed for 15 minutes at  $4^{\circ}\text{C}$  in a microfuge.
- g. Pour off the supernatants. Wash the pellets with ice-cold 70% ethanol, and dry the pellets briefly under vacuum. Resuspend each pellet in 5–10  $\mu$ l of TE (pH 8.0). Proceed to Step 2.

#### FOR ISOLATION OF A LARGE NUMBER OF COLONIES

The following procedure for preparing DNA in batches was developed by Steve Kron (University of Chicago) as a scale-up of a protocol originally developed by Manuel Claros (Laboratoire Génétique Moléculaire, Paris). A refrigerated centrifuge with plate holders is required, and a repeating pipettor is helpful.

- a. Transfer 2 ml of 2x CM(Glu)-Trp medium into each well of a 24-well microtiter plate. Use a toothpick to pick a putative positive colony from a master plate into each well (Stage 2, Step 21). Grow the cultures overnight at  $30^{\circ}\text{C}$  with shaking.
 

The use of 2x minimal medium maximizes the yield of yeast. Four plates can generally be handled conveniently and spun simultaneously in a centrifuge.
- b. Centrifuge the plate(s) in a centrifuge with microplate holders at 1500g (3000 rpm in a Sorvall H1000B MPC rotor) for 5 minutes at  $4^{\circ}\text{C}$ . Shake off the supernatant with a snap of the wrist and return the plate to an upright position. Swirl or lightly vortex the plate to resuspend each cell pellet in the remaining liquid. Add 1 ml of  $\text{H}_2\text{O}$  to each well and swirl the plate gently.
 

Cell pellets can most easily be resuspended in residual liquid before adding new solutions. Addition of liquid can be accomplished using a repeating pipettor.
- c. Centrifuge as in Step b, shake off the supernatant, resuspend the cells in residual supernatant, and add 1 ml of rescue buffer.
- d. Centrifuge as in Step b, shake off the supernatant, and resuspend the cells in the small volume of liquid remaining in the plate. To each well, add 25  $\mu$ l of lysis solution. Swirl or vortex the plate. Incubate the plate (with the cover on) on a rotary shaker for  $\sim 1$  hour at  $37^{\circ}\text{C}$ .
 

The lysis solution need not be completely dissolved before use. By 1 hour, lysis should be obvious as yeast cells coagulate into a white precipitate. The susceptibility of yeast strains to lytic enzymes varies. If lysis occurs rapidly, then use less lytic enzyme. If the lysis step is allowed to proceed too far, too much of the partially dissolved cell wall may contaminate the final material. Lysis can be judged by examining cells in a phase microscope. Living cells are white with a dark halo, and dead cells are uniformly gray. Lysis leads to the release of granular cell contents into the medium. Once cells are mostly gray and many are disrupted, it can be assumed that much of the plasmid has been released.
- e. Add 25  $\mu$ l of 10% SDS to each well. Disperse the precipitates completely by swirling the plates. Allow the plates to rest on the bench for 1 minute at room temperature. After 1 minute, the wells should contain a clear, somewhat viscous solution.

- f. To each well, add 100  $\mu$ l of 7.5 M ammonium acetate. Swirl the plates gently, and then store them for 15 minutes at  $-70^{\circ}\text{C}$  or at  $-20^{\circ}\text{C}$  until the lysates are frozen.

Addition of acetate should result in the formation of a massive white precipitate of cell debris and SDS. The freezing step appears to improve removal of inhibitors of *E. coli* transformation.

- g. Remove the plates from the freezer. Once they begin to thaw, centrifuge the plates at 3000g (3800 rpm in a Sorvall H6000A MPC rotor) for 15 minutes at  $4^{\circ}\text{C}$ . Transfer 100–150  $\mu$ l of the resulting clear supernatants to fresh 24-well plates.

▲ **IMPORTANT** In general, some contamination of the supernatants with pelleted material cannot be avoided. However, it is better to sacrifice yield in order to maintain purity.

- h. To each well, add  $\sim 0.7$  volume of isopropanol. Mix the solutions by swirling and allow the nucleic acids to precipitate for 2 minutes at room temperature. Centrifuge as in Step g. Shake off the supernatants with a snap of the wrist.

A cloudy fine precipitate should form immediately after isopropanol is added.

- i. To each well, add 1 ml of cold 70% ethanol. Swirl the plates, and then centrifuge them at 3000g (3800 rpm in a Sorvall H6000A MPC rotor) for 5 minutes at  $4^{\circ}\text{C}$ . Shake off the supernatant with a snap of the wrist, invert the plates, and blot them well onto paper towels. Allow the plates to dry in the air.

- j. To each well, add 100  $\mu$ l of TE (pH 8.0). Swirl the plates and allow them to rest on the bench for several minutes, until the pellets appear fully dissolved. Transfer the preparations to microfuge tubes or the wells of a 96-well plate for storage at  $-20^{\circ}\text{C}$ . Proceed to Step 2.

1–5  $\mu$ l of each of the resulting preparations can be used to transform competent *E. coli* by electroporation. If insufficient numbers of colonies are obtained, reprecipitate the DNAs and dissolve them in 20  $\mu$ l rather than 100  $\mu$ l of TE, to concentrate the DNA stock.

### Transformation into *E. coli*

If the bait is cloned in one of the specialized LexA-fusion plasmids (Table 18-1) that carries an ampicillin resistance marker, a proportion of the *E. coli* DH5 $\alpha$  transformants will not contain the library plasmid. One option to resolve this problem is to analyze multiple transformants from each DNA preparation. Alternatively, it is possible to passage plasmids through a strain of *E. coli* possessing a *trpC* mutation, and select for a library plasmid by the ability of the yeast *TRP1* gene to complement the *E. coli trpC* mutation.

2. Introduce 1–5  $\mu$ l of each preparation of plasmid DNA into competent *E. coli* DH5 $\alpha$  or into strain KC8 (*pyrF leuB600 trpC hisB463*) by electroporation. Plate the bacteria on LB agar containing 50  $\mu\text{g}/\text{ml}$  of ampicillin, and incubate the plates overnight at  $37^{\circ}\text{C}$ .

3. If plasmid DNA was transformed into DH5 $\alpha$ , proceed to Step 4. If plasmid DNA was transformed into KC8:

- a. Use restreaking or replica plating to transfer colonies from LB/ampicillin plates to minimal (*-trp*) medium for bacteria. Incubate the bacteria overnight at  $37^{\circ}\text{C}$ .

Colonies that grow under these conditions contain the pJG4-5 library plasmid, as the *TRP1* gene carried by this plasmid efficiently complements the bacterial *trpC9830* mutation.

The initial plating of transformation mixtures on LB/ampicillin plates is less stressful than directly plating on to bacterial minimal medium and maximizes the number of colonies obtained.

- b. Prepare miniprep DNA from an isolated colony and use the DNA to transform DH5 $\alpha$  cells as described in Step 2.

Minipreparations of KC8 DNA can be used for restriction digests, PCR, and retransformation of yeast. It is, however, advisable to use the KC8 miniprep DNA to transform a more amenable *E. coli* strain, such as DH5 $\alpha$ , before sequencing is attempted. DNA prepared from KC8 is generally unsuitable for dideoxy or automated sequencing even after extensive purification.

4. Prepare miniprep DNA from DH5 $\alpha$  cells carrying the library plasmid.

▲ **IMPORTANT** In general, it is a good idea to prepare DNA from two or three separate bacterial colonies generated from each original positive interactor. By contrast to bacteria, yeast can tolerate multiple 2 $\mu$  plasmids with identical selective markers. If a single yeast cell contains two or three distinct library plasmids, only one of which encodes an interacting protein, the relevant cDNA clone can be lost at the stage of plasmid isolation. Again, in general, this is *not* a major problem; on average, perhaps 10% of yeast cells will contain two or more library plasmids.

5. Confirm by restriction endonuclease digestion that the duplicate samples prepared for each positive contain identical inserts, and/or determine whether a small number of cDNAs have been isolated repeatedly.

Digestion of library plasmids with *EcoRI* + *XhoI* will release cDNA inserts, whereas digestion with *EcoRI* + *XhoI* + *HaeIII* will "fingerprint" the inserts. Independent isolation of only a few cDNAs is generally a good indication that the clones have biological relevance. Do not despair if the cDNA clones are not identical. In cases where only a small number of total positive colonies have grown, or in cases where the interactor cDNA was poorly represented in the library, true interactors have been obtained as single positive clones.

▲ **IMPORTANT** Some investigators sequence DNAs at this stage. A lot of money can be wasted on sequencing nonspecific interactors: It is strongly recommended that the transformation into yeast and specificity tests, as described below, be completed before sequencing.

## Second Confirmation of Positive Interactions: Repeated Phenotype and Specificity Tests

The final test of the specificity of interacting proteins is the retransformation of library plasmids from *E. coli* into "virgin" *lexAop-LEU2/lexAop-lacZ/pBait*-containing strains. The aim is to verify that interaction-dependent phenotypes are still observed and are specific to the starting pBait. This test will eliminate false positives, including mutations in the initially transformed EGY48 yeast that favor growth or transcriptional activation on galactose medium; library-encoded cDNAs that interact with the LexA DNA-binding domain; and library-encoded proteins that are "sticky" and interact with multiple pBaits in a promiscuous manner.

6. Transform yeast strain EGY48 with the following sets of plasmids, and select colonies on CM(Glu)-Ura-His plates.
  - a. pMW112 and pBait
  - b. pMW112 and pRFHM-1
  - c. pMW112 and a nonspecific bait

If the pBait initially used in the screen was able to activate transcription, even slightly, we strongly recommend that a nonspecific control bait that can also weakly activate transcription be included as a control. In general, baits that activate transcription poorly are difficult to distinguish from the background of false positives. Some false positives interact generically with weakly activating LexA-fused proteins.

7. After 2–3 days, transformed yeast from Step 6 should be available. Use electroporation to introduce library plasmids prepared from *E. coli* KC8 or DH5 $\alpha$  into individual transformants a–c. Plate each transformation mixture on CM(Glu)-Ura-His-Trp dropout plates and incubate the plates at 30°C until colonies grow (2–3 days).

▲ **IMPORTANT** As a negative control, also electroporate examples of transformants a–c with the pJG4-5 library vector.

8. Create a CM(Glu)-Ura-His-Trp master dropout plate for each library plasmid being tested. It is generally helpful to streak transformants a–c for each library plasmid in close proximity on the plate to facilitate detection of nonspecific interactions.

▲ **IMPORTANT** Each plate should also contain the a–c series transformed with the pJG4-5 negative control.

9. Test for  $\beta$ -galactosidase activity and for leucine auxotrophy, exactly as described in Stage 2, Step 21.
10. Analyze the results of these specificity tests and sequence the positive isolates (please see Chapter 4, Protocol 13).

- True "positive" cDNAs should render yeast blue on CM(Gal, Raff)-Ura-His-Trp plates but not on CM(Glu, X-gal)-Ura-His-Trp plates, and permit growth on CM(Gal, Raff)-Ura-His-Trp-Leu dropout plates, but not CM(Glu)-Ura-His-Trp-Leu dropout plates, specifically with the original pBait but not **b** or **c**. These positive cDNAs are ready to be sequenced (if they have not been already) using primer FP1 (please see the panel on **ALTERNATIVE PROTOCOL: RAPID SCREEN FOR INTERACTION TRAP POSITIVES** on the following page). Those cDNAs that also encode proteins that interact with either **b** or **c** should be discarded.
- It is possible to quantify roughly the relative affinity of interactions using numbers generated by  $\beta$ -galactosidase assays. Whether this is desirable is left to the discretion of the individual investigator.
- As an additional control, a database of common false positives has been compiled and made available on the World Wide Web, at  
<http://www.fccc.edu/research/labs/golemis/InteractionTrapInWork.html>  
 Particularly for cDNAs isolated only once, or for cDNAs that do not appear to make biological sense in the context of the starting bait, it may be helpful to consult the database to make sure that the clone has not been reported to be a problem by other groups.

#### SUBSEQUENT CHARACTERIZATION

If all has gone well in the previous steps, the experiment will have generated a small set of sequenced cDNAs, encoding proteins that interact specifically with their starting bait. What next? In some cases, the subsequent characterization steps are obvious, with the isolated cDNA making clear biological sense in the context of a particular starting bait. However, in general, this is the point at which the bulk of the work really begins, with the obtained interactor either corresponding to a cDNA without a defined biological activity immediately relevant to the starting bait or corresponding to a novel sequence. There are many ways to approach the analysis of such novel interactors, and a complete discussion would go far beyond the scope of this chapter. For investigators not experienced in the characterization of novel proteins, the following questions cover a few issues that might be particularly helpful in getting started.

- **Is the cDNA full-length?** Many times, isolated interactors correspond to the carboxy-terminal end of incomplete cDNAs. Thus, some first steps would involve using a cDNA probe in northern analysis to establish transcript size. If the isolated cDNA is truncated, scanning sequence databases (those containing expressed sequence tags are useful) and subsequent screening of conventional cDNA libraries (Chapter 11, Protocol 2) or RACE (Chapter 8, Protocols 9 and 10) are used to obtain full-length clones.
- **Is the cDNA expressed in an appropriate cell type and/or tissue location to conceivably interact with the Bait protein?** For mammals, probing of a multitissue northern blot (many are commercially available from CLONTECH and other sources) will address this point.
- **Does the full-length bait associate with the full-length interactor? Do the bait and interactor associate in another assay system different from the two-hybrid system?** Ideally, investigators would like to coimmunoprecipitate the endogenous bait and interactor from their host organism. For mammals, an intermediate step while the antibody is forthcoming is to synthesize an epitope-tagged version of the interactor, transfect it into cells normally expressing the bait, and coimmunoprecipitate with this combination.
- **Intracellularly, are bait and interactor expressed in overlapping or identical compartments?** Cell fractionation and/or immunofluorescence performed with antibody either to a native or tagged interactor may be used to address these points (for details on these methods, please refer to Spector et al. [1998, Chapters 71 and 98]).
- **Above all, do bait and interactors affect each other's biological activity?** Some further assays may ultimately be useful in yeast, for example, mapping the domain of interaction using a series of truncated bait proteins. First and foremost, the main goal is to establish biological relevance of the interaction in the organism of origin.

**ALTERNATIVE PROTOCOL: RAPID SCREEN FOR INTERACTION TRAP POSITIVES**

This protocol is an alternative approach to screening for positive library plasmids. A major strength of this approach is that it will identify redundant clones before plasmid isolation and bacterial transformation, which in some cases greatly reduces the amount of work required. However, accurate records should be maintained detailing how many of each class of cDNAs are obtained. If there is any doubt whether a particular cDNA is part of a set or is unique, investigators should err on the side of caution. This rapid screening method is most advantageous when the number of selected colonies exceeds 23.

**CAUTION:** Please see Appendix 12 for appropriate handling of materials marked with <!>.

**Additional Materials**

2% Agarose gel

$\beta$ -glucuronidase lysis solution

50 mM Tris-HCl (pH 7.5)

10 mM EDTA

0.3% (v/v)  $\beta$ -mercaptoethanol (prepare fresh) <!>

1:50  $\beta$ -glucuronidase type HP-2, crude solution from *H. pomatia* (Sigma)

Glass beads (150–212  $\mu$ m diameter; Sigma)

0.7% Low-melting-temperature agarose gel

Oligonucleotides primers (20 mM in TE [pH 8.0])

Forward primer (FP1) 5'-CTG AGT GGA GAT GCC TCC

Reverse primer (FP2) 5'-CTG GCA AGG TAG ACA AGC CG

Microtiter plate (96-well)

Reagents for analyzing yeast colonies by PCR (Chapter 4, Protocol 13)

Reagents for purifying DNA fragments from low-melting-temperature agarose (Chapter 5, Protocol 6 or 7)

Restriction endonuclease *Hae*III

Thermocycler

Thin-walled microfuge tubes (0.5-ml, sterile)

**Method**

1. Add 25  $\mu$ l of  $\beta$ -glucuronidase lysis solution into the individual wells of a 96-well microtiter plate.
2. Starting from the CM(Glu)-Ura-His-Trp master plate (Stage 2, Step 21), transfer and resuspend individual positive candidate yeast colonies in each of the wells containing  $\beta$ -glucuronidase solution. Use tape to seal the wells, and incubate the plate on a horizontal shaker for 1.5–3.5 hours at 37°C.
  - ▲ **IMPORTANT** Transfer approximately the volume of one middle-sized yeast colony (2–3- $\mu$ l packed pellet); do not take more, or the quality of the isolated DNA will suffer. The master plate does not need to be absolutely fresh: Plates stored for 5 days at 4°C have been used successfully. If appropriate, a multicolony replicator/frogger can be used.
3. Remove the tape and add ~25  $\mu$ l of glass beads (150–212  $\mu$ m) to each well, and seal the wells again. Attach the microtiter plate to a vortex with a flat top surface (e.g., using rubber bands) and mix vigorously for 5 minutes.
4. Add 100  $\mu$ l of sterile distilled H<sub>2</sub>O to each well. Transfer 0.8–2  $\mu$ l from each well to a fresh microfuge tube to be used as a template for each PCR. Reseal the plate with tape, and keep the remainder of the lysate frozen at –20°C.

5. In a series of sterile 0.5-ml thin-walled microfuge tubes (equal to the number of colonies to be analyzed), mix in the following order:

10x colony PCR buffer	2 $\mu$ l
25 mM MgCl <sub>2</sub>	1.2 $\mu$ l
10 mM dNTPs	0.4 $\mu$ l
oligonucleotide primers (FP1 and FP2)	10 pmoles of each
<i>Taq</i> polymerase	5 units (0.2 $\mu$ l)
H <sub>2</sub> O	to 20 $\mu$ l

6. Add 0.8–2  $\mu$ l of template (from Step 4) to each PCR tube.  
 7. Transfer the PCR tubes to the thermocycler, programmed as follows, and start the program.

Cycle Number	Denaturation	Annealing	Polymerization
1	2 min at 94°C		
2–32	45 sec at 94°C	45 sec at 56°C	45 sec at 72°C

Modified versions of this protocol with extended elongation times have also been found to work; the variant given above has amplified fragments of as much as 1.8 kb in reasonable quantity.

8. Analyze the PCR products:
- Remove 10  $\mu$ l of the PCR products into fresh microfuge tubes, and perform a restriction digest with *Hae*III in a total volume of 20  $\mu$ l.
  - Load the digestion products onto a 2% agarose gel, and run the DNAs a sufficient distance to resolve the digestion products in the 200–1000 bp size range.  
 Analysis by electrophoresis will generally yield distinctive and unambiguous groups of inserts, indicating whether multiple isolates of a small number of cDNAs have been obtained.
9. In parallel with the *Hae*III digestion, run the remainder of each PCR (~10  $\mu$ l) on a 0.7% low-melting-temperature agarose gel. Confirm that groups of inserts predicted on the basis of the *Hae*III digest appear to be compatible with groups predicted by analysis of the nondigested PCR products.
- ▲ **IMPORTANT** Sometimes a single yeast colony contains two or more different library plasmids. This will be immediately revealed by PCR, so following bacterial transformation, check several independent clones to reduce the possibility of losing the “real” interactor.
10. Purify fragments from the low-melting-temperature agarose gel (Chapter 5, Protocol 6 or 7).  
 In cases where a very large number of isolates of a small number of cDNAs have been obtained, the investigator may choose to sequence the PCR product directly. Only the forward primer, FP1, works well in sequencing of PCR fragments; the reverse primer only works in sequencing from purified plasmids. In general, the TA-rich nature of the ADH terminator sequences downstream from the polylinker in the pJG4-5 vector makes it difficult to design high-quality primers in this region.
11. Transform *E. coli* (either DH5 $\alpha$  or KC8) with DNA from selected positives, using electroporation as described in the main protocol (Steps 2–5). Use 2–4  $\mu$ l of the  $\beta$ -glucuronidase-treated frozen yeast (Step 4) as the source of DNA.
12. Proceed with the second confirmation of positive interactions, as outlined in the main protocol, commencing with Step 6.



# Protocol 2

---

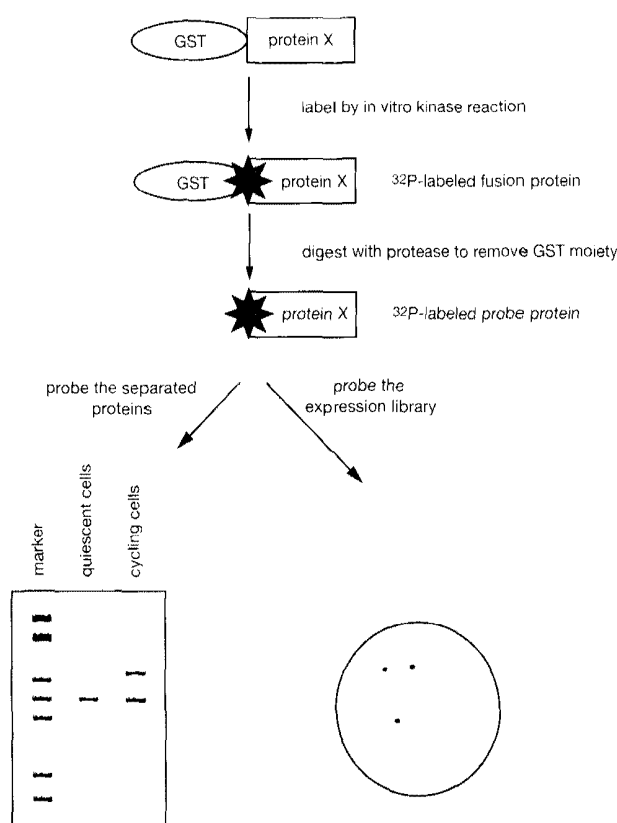
## Detection of Protein-Protein Interactions Using Far Western with GST Fusion Proteins

Margret B. Einarson

*Fox Chase Cancer Center, Philadelphia, Pennsylvania 19111*

**G**ST FUSION PROTEINS HAVE BEEN USED IN THOUSANDS OF PROJECTS since their introduction as components of recombinant proteins expressed in bacteria (Smith and Johnson 1988). They are now routinely used to generate antibodies to study protein-protein interactions and to analyze biochemical reactions. Protocols 2 and 3 describe the use of GST fusion proteins as probes for the identification of protein-protein interactions, although other systems are available for the production of recombinant proteins (for detailed discussions, please see Chapter 15). The techniques used are fundamentally similar to analogous techniques developed for detection of proteins by antibodies. For example, in western blots, an antibody is used to detect a candidate protein bound to a membrane. In a far western blot, the antibody has been replaced by a recombinant GST fusion protein produced in and purified from bacteria. The interaction of this probe protein and a target protein on the membrane can be detected by GST pulldown, which relies on the ability of glutathione agarose beads to precipitate GST fusion proteins that have previously bound to specific partner proteins in solution. GST pulldowns can be initiated prior to the availability of antibodies to the protein of interest, or when antibodies have been found to interfere with protein-protein interactions. It should be noted that these methods characterize *in vitro* interactions, which should subsequently be substantiated *in vivo* by independent means such as coimmunoprecipitation (Protocol 4). Although Protocols 2 and 3 yield results that are qualitative, GST fusion proteins also can be used in highly quantitative and sophisticated assays (e.g., please see Posern et al. 1998; McDonald et al. 1999).

Far western analysis was originally developed to screen expression libraries with a  $^{32}\text{P}$ -labeled GST fusion protein (Blackwood and Eisenman 1991; Kaelin et al. 1992). The schema of a typical far western experiment is depicted in Figure 18-12. The probe protein is first synthesized and purified from bacteria (please see Chapter 15, Protocol 5). In the figure, the probe protein is a GST fusion containing the GST moiety followed by a protease cleavage site and a target site for a known protein kinase in-frame with the protein of interest. The purified fusion protein bound to glutathione beads is radiolabeled with  $^{32}\text{P}$  using a commercially available protein kinase. The fusion protein is washed to remove unincorporated nucleotide, and the radiolabeled protein is cleaved with a protease (e.g., Factor X or thrombin) or eluted with glutathione to release the radiolabeled protein probe. The sample to be probed is prepared either by resolving the target proteins on an SDS-polyacrylamide gel and transferring the proteins to a membrane (e.g., please see Posern et al. 1998; Grgurevich et al. 1999; Hunter et al. 1999) or by plating a protein expression



**FIGURE 18-12 Outline of a Far Western**

The purified recombinant GST-fusion protein is radiolabeled at a kinase consensus site contained in the fusion portion of the protein. The  $^{32}\text{P}$ -labeled probe protein is separated from the GST moiety by protease digestion. The labeled protein can be used to probe membranes generated either by transfer of proteins separated by SDS-polyacrylamide gel electrophoresis (*left*) or plating an expression library (*right*). Variations on this procedure are described in the text.

library and transferring the proteins to a membrane (Macgregor et al. 1990; Blackwood and Eisenman 1991; Kaelin et al. 1991; Blanar and Rutter 1992; Ayer et al. 1993; Einarson and Chao 1995). The membrane is washed and blocked before addition of the radioactive protein probe. After incubation with the probe protein, the membrane is washed and subjected to autoradiography. Radiolabeling the fusion protein is rapid and easy, and generally has little impact on the subsequent activity of the protein, because the phosphorylation site is in the fusion portion of the protein. A variety of protein kinase sites have been integrated into fusion protein vectors (Blanar and Rutter 1992; Kaelin et al. 1992; Ron and Dressler 1992) to allow for  $^{32}\text{P}$  labeling of recombinant proteins expressed in bacteria. The most commonly used kinases are protein kinase A, cAMP-dependent protein kinase, and enterokinase. An early variation on this technique utilized endogenous phosphorylation sites in the protein of interest for  $^{32}\text{P}$  phosphorylation (Skolnick et al. 1991; Ayer et al. 1993). An alternative method of radiolabeling the probe without the need to generate a fusion protein is to label it with  $^{35}\text{S}$  in an in vitro transcription/translation reaction (Lee et al. 1991).

Two other methods are commonly used to detect interactions between GST fusions and target proteins: Anti-GST antibodies can be used to locate unlabeled fusions proteins on far western

blots. Alternatively, biotinylated GST can be detected histochemically by streptavidin-conjugated enzymes. Biotinylation of proteins is now relatively easy due to the availability of kits (Amersham Pharmacia Biotech). However, biotinylation may have an impact on the ability of the probe protein to associate with other proteins. The use of commercially available anti-GST antibodies is a good option for detecting interactions on membranes of cell lysates. The latter two methods have the advantage of being nonradioactive. However, if a library screen is planned, the cost of the anti-GST antibody and detection reagents may be excessive.

The design of the fusion protein depends on the chosen detection method and on the type of screen that is planned. One issue to consider is using cleaved versus full-length GST fusion proteins. The GST moiety is known to dimerize and can generate background. Most fusion vectors contain cleavage sites to separate the GST portion from the protein of interest. Note, however, that if the fusion protein is cleaved, the interaction with the target protein can no longer be detected with anti-GST antibodies. To choose which cleavage site to use, it is important to scan the protein and ensure that it does not contain the recognition site of the protease. A second issue to consider is what region of the probe protein ought to be incorporated into the GST fusion protein. For a library screen, including as much of the probe protein as possible increases the number of interactions detected. On the other hand, if the probe protein contains known interaction domains and these are being tested to confirm predicted interactions, then a fusion protein containing only these motifs would be preferred.

Perhaps the most important consideration in planning a far western experiment is the ability to synthesize the fusion protein without undue degradation and insolubility. If the fusion protein is excessively degraded during purification, the probe protein will be a mixture of degradation products. Variable results may be obtained from preparations of the different fusion proteins. It is therefore important to monitor the status of the fusion protein during and after purification and, if the protein has been stored, before use. Two controls that will help to confirm the specificity of the protein-protein interactions are (1) to probe with a mutated version of the fusion protein that interrupts the interaction and (2) to probe the membrane with labeled GST.

A final decision is whether to probe the membrane with or without a cycle of denaturation/renaturation, which is designed to allow misfolded proteins to refold into their native conformations. In general, proteins transferred to a membrane from an SDS-polyacrylamide gel do not require denaturation and renaturation. However, many investigators who probe filters housing imprints of an expression library find denaturation/renaturation to be an essential step. Thus, if probing an SDS-polyacrylamide gel yields no protein-protein interactions, incorporating a denaturation/renaturation procedure may yield positive results (for details, please see the panel on **ADDITIONAL PROTOCOL: REFOLDING OF MEMBRANE-BOUND PROTEINS** at the end of this protocol).

## MATERIALS

---

**CAUTION:** Please see Appendix 12 for appropriate handling of materials marked with <!>.

### Buffers and Solutions

Please see Appendix 1 for components of stock solutions, buffers, and reagents. Dilute stock solutions to the appropriate concentrations.

#### *Basic buffer*

- 20 mM HEPES (pH 7.5)
- 50 mM KCl
- 10 mM MgCl<sub>2</sub>
- 1 mM dithiothreitol
- 0.1% Nonidet P-40

*Blocking buffer*

5% nonfat dry milk in basic buffer.

*Interfer buffer*

1% nonfat dry milk in basic buffer.

*2x PK buffer*

100 mM KPO<sub>4</sub>

20 mM MgCl<sub>2</sub>

10 mM NaF <math>\langle ! \rangle</math>

9 mM dithiothreitol

*Reduced glutathione (20 mM) in 50 mM Tris-Cl (pH 8.0)*

Optional, please see Step 3.

*Wash buffer 1*

Phosphate-buffered saline containing 0.2% Triton X-100.

*Wash buffer 2*

Phosphate-buffered saline containing 0.2% Triton X-100 and 100 mM KCl.

## Enzymes and Buffers

*Protease*

Optional, please see Step 3.

*Protein kinase A*

Prepare fresh at each use according to the manufacturer's instructions.

## Radioactive Compounds

[ $\gamma$ -<sup>32</sup>P]ATP (6000 Ci/mmol) <math>\langle ! \rangle</math>

## Special Equipment

*Membranes or filters that will bind proteins to be screened*

Please see Step 5.

*Sephadex G-50 spun column*

Optional, please see Step 4.

## Additional Reagents

*Step 3 of this protocol requires reagents for cleavage of the fusion protein from its carrier or the fusion protein attached to glutathione-agarose beads in Chapter 15, Protocol 5.*

*Step 5 of this protocol requires either a polyacrylamide gel containing the proteins to be probed (please see Appendix 8) or plates containing a cDNA expression library (please see Chapter 14, Protocol 2), and reagents for immunoblotting described in Appendix 8.*

A negative control of GST alone or a nonspecific protein should be loaded onto the SDS-polyacrylamide gel with the target proteins. If the protein of interest is a member of a conserved family, the interaction of the protein of interest can be compared to other proteins from the same family.

## Vectors and Bacterial Strains

*GST fusion protein bound to glutathione-agarose beads*

This protocol is for proteins containing a protein kinase A phosphorylation site in the fusion protein (Ron and Dressler 1992). Also available is a vector that contains a cAMP-dependent protein kinase recognition sequence (Amersham Pharmacia Biotech). If using an unlabeled GST fusion protein, please see the panel on **ALTERNATIVE PROTOCOL: DETECTION OF PROTEIN-PROTEIN INTERACTIONS WITH ANTI-GST ANTIBODIES** at the end of this protocol.

## METHOD

### Preparation of the Radiolabeled Protein Probe

1. Prepare the following reaction mixture in a microfuge tube:
 

$[\gamma\text{-}^{32}\text{P}]\text{ATP}$ (6000 Ci/mmol)	5 $\mu\text{l}$
protein kinase A	1 unit/ $\mu\text{l}$
GST fusion protein on glutathione-agarose beads	1–3 $\mu\text{g}$
2x PK buffer	12.5 $\mu\text{l}$
$\text{H}_2\text{O}$	to 25 $\mu\text{l}$

Incubate the reaction mixture for 30 minutes at 37°C.

The fusion protein may be cleaved with a protease before the labeling reaction. In this case, substitute the cleaved protein for the protein bound to glutathione-agarose beads in the labeling reaction, incubate for 30 minutes at 37°C, and proceed to Step 4.

If the GST moiety is retained on the fusion protein, the experiment must be replicated with GST alone (bound to glutathione-agarose beads) as a negative control. In the case of a library screen where this would be impractical, it is important to test positive plaques for their ability to bind GST alone. This control is usually carried out after quaternary purification, before clone characterization.

2. After the labeling reaction is complete, wash the beads by adding 200  $\mu\text{l}$  of 1x PK buffer to the tube, and centrifuge the tube at maximum speed for 1 minute in a microfuge. Discard the supernatant containing the free radiolabeled nucleotide in an appropriate manner. Repeat the wash one more time.
3. Either cleave the labeled protein with a protease or elute the labeled GST fusion protein from the beads with 20 mM reduced glutathione in 50 mM Tris (pH 8.0) (please see Chapter 15, Protocol 5). Store the radiolabeled protein probe in an ice bucket and use it on the same day it is made.
4. If the labeled protein was cleaved from the GST moiety before the labeling reaction (please see the note to Step 1), then load the radiolabeled protein onto a Sephadex G-50 column equilibrated with 1x PK buffer to remove the free radiolabeled nucleotide. Once the probe protein is separated from the free nucleotide, it is ready for use. Store the radiolabeled protein probe in an ice bucket and use it on the same day it is made.

### Probing the Membranes

5. Prepare the membrane to be probed by transferring proteins to the membrane according to standard techniques.
 

Proteins transferred from an SDS-polyacrylamide gel (Appendix 8) can generally be probed directly. If proteins are transferred from a cDNA expression library, it may be necessary to carry out the **ADDITIONAL PROTOCOL: REFOLDING OF MEMBRANE-BOUND PROTEINS** before proceeding to Step 6.
6. Cover the membrane completely with basic buffer and wash it for 10 minutes at 4°C with gentle agitation.
7. Discard the basic buffer. Cover the membrane completely with blocking buffer and incubate it with gentle agitation for 4 hours to overnight at 4°C.
8. Prepare a solution of labeled protein by adding 1–3  $\mu\text{g}$  of the stock probe (from either Step 3 or 4) to enough interaction buffer to make a final concentration of 1–5 nM. Transfer the membrane to a dish containing the diluted probe. Make sure that the probe solution contacts the entire surface of the membrane evenly. Incubate the membrane for 4–5 hours at 4°C with gentle agitation.

9. Discard the radioactive probe solution in an appropriate manner. Cover the membrane completely with Wash buffer 1, and incubate the membrane for 10 minutes at 4°C with gentle agitation. Repeat the wash three more times.
10. Cover the membrane completely with Wash buffer 2, and wash the membrane for 10 minutes at 4°C with gentle agitation. Repeat this once.
11. Wrap the membrane carefully in plastic wrap and expose it to X-ray film.

#### INTERPRETATION OF THE RESULTS AND TROUBLESHOOTING THE EXPERIMENT

- The failure to detect any protein interactions could be a correct result. However, if there is supporting evidence that this is not the predicted result, try the **ADDITIONAL PROTOCOL: REFOLDING OF MEMBRANE-BOUND PROTEINS** and then probe the membrane again with the radiolabeled protein.
- The presence of an excessive number of signals can result from a number of causes. Degraded or impure probe dimerization is one possibility. Check the integrity of the probe on an SDS-polyacrylamide gel. GST homodimerization can be another source of background. In this case, try cleaving the GST moiety from the fusion protein. If this is not practical, add an excess of unlabeled GST before blocking the membrane or during incubation of the probe (this approach cannot be used if anti-GST antibodies are being used to detect the interaction). The incubation time can be shortened to reduce possible nonspecific interactions. Alternatively, if the probe is in excess, carry out the experiment using several different probe concentrations to determine the optimal concentration.
- The best control for establishing specificity of the observed protein interactions is to generate a probe protein with a mutation in the interaction domain. Demonstrating loss of interaction in an experiment performed with the mutant probe compared to a parallel experiment run with the wild-type probe is convincing evidence that the interaction(s) is relevant.

#### ADDITIONAL PROTOCOL: REFOLDING OF MEMBRANE-BOUND PROTEINS

In some instances, the proteins on the membrane are unable to interact with the probe protein, possibly due to improper folding during expression or transfer. Denaturation and slow renaturation of the dilutes may be necessary. This is accomplished by washing the membrane in a denaturation buffer that is diluted serially to allow for slow renaturation during subsequent washing. Start with a stock solution of 6 M guanidinium hydrochloride prepared in basic buffer and dilute it serially as the membrane is washed.

**CAUTION:** Please see Appendix 12 for appropriate handling of materials marked with <!>.

#### Additional Materials

##### Denaturation buffer

Prepare 6 M guanidine hydrochloride <!> in basic buffer (for recipe of basic buffer, please see the main protocol).

#### Method

1. After protein transfer, wash the membrane twice, each time in 50 ml of denaturation buffer for 10 minutes at 4°C with gentle agitation.
 

The exact volume of buffer to use in this and subsequent steps depends on the size and number of membranes under study. Use enough buffer to cover the membrane(s) completely.
2. Remove the denaturation buffer from the container and retain 25 ml of it. Add 25 ml of basic buffer to the 25 ml of denaturation buffer to make a total volume of 50 ml. This is the first 1:1 dilution of the denaturation buffer. Return the diluted denaturation buffer to the container and wash the blot for 10 minutes at 4°C with gentle agitation.
3. Repeat this dilution and wash cycle (Step 2) four more times. The final wash therefore contains 187 mM guanidinium hydrochloride.
4. Return to the main protocol and proceed with Step 6.

**ALTERNATIVE PROTOCOL: DETECTION OF PROTEIN-PROTEIN INTERACTIONS WITH ANTI-GST ANTIBODIES**

A nonradioactive version of the far western uses an unlabeled GST fusion protein. Commercially available anti-GST sera are then used to detect protein-protein interactions. The use of this approach when screening a cDNA expression library is substantially more expensive (due to the cost of the antibody and detection reagents) than radiolabeling the proteins. In addition, care must be taken to control for nonspecific interactions between the GST moiety and the membrane-bound proteins.

**Additional Materials***Anti-GST antibody*

This antibody is available commercially from Amersham Pharmacia Biotech, Santa Cruz Biotech, Upstate Biotechnology, and Constance/Babco.

*Incubation buffer*

10% (w/v) nonfat dry milk  
1x phosphate-buffered saline  
0.3% (v/v) Tween-20

*Secondary antibody*

The secondary antibody should be an anti-IgG directed against the species used to prepare the anti-GST serum (e.g., use anti-goat IgG if the anti-GST antibody was obtained from goat serum). In addition, the secondary antibody should be part of a detection system that will permit the protein-protein interactions of interest to be visualized. For example, the secondary antibody could be conjugated to an enzyme such as horseradish peroxidase, which can be used in a chemiluminescent detection system. For additional details, please see Appendix 9.

*Wash buffer*

1x phosphate-buffered saline  
0.3% (v/v) Tween-20

**Method**

1. Begin the main protocol at Step 2 and proceed through Step 10.
2. Incubate the membrane with anti-GST antibodies according to the manufacturer's recommendations.
3. Remove the anti-GST antibody solution. Rinse the membrane twice, each time with 25 ml of wash buffer to remove residual unbound antibody.
4. Wash the membrane twice, each time with 20–30 ml of wash buffer for 10 minutes at room temperature with gentle mixing.
5. Dilute the secondary antibody with incubation buffer according to the manufacturer's recommendations.
6. Pour the antibody-buffer mixture into the container with the membrane. Incubate the membrane for 1 hour at room temperature with gentle mixing.
7. Discard the antibody solution. Rinse the membrane twice, each time with 25 ml of wash buffer to remove the majority of unbound antibody.
8. Wash the membrane twice, each time with 20–30 ml of wash buffer for 10 minutes at room temperature with gentle mixing.
9. Develop the blot with the appropriate substrate for the conjugated secondary antibody.

# Protocol 3

---

## Detection of Protein-Protein Interactions Using the GST Fusion Protein Pulldown Technique

Margret B. Einarson

*Fox Chase Cancer Center, Philadelphia, Pennsylvania 19111*

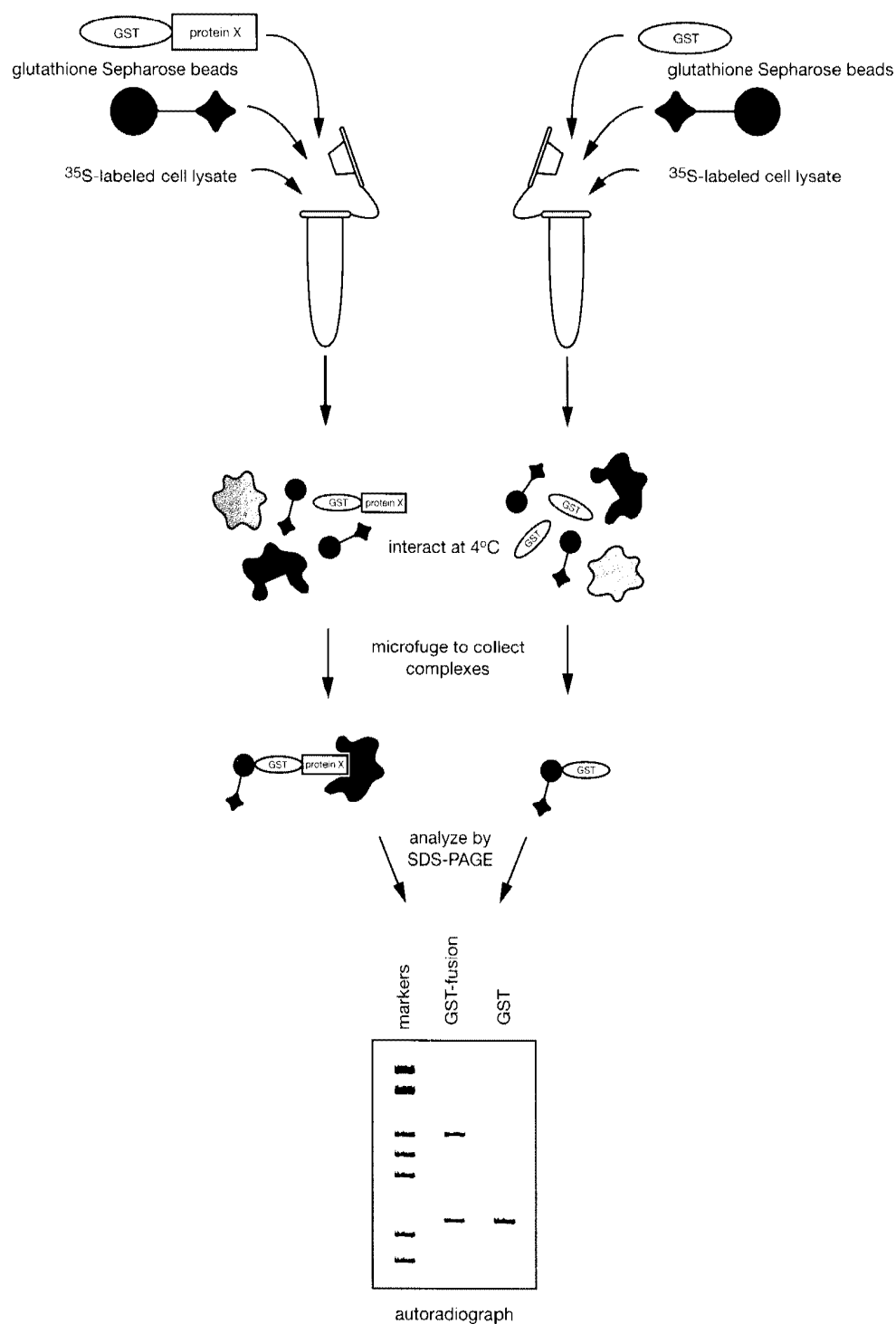
**T**HE GST FUSION PROTEIN PULLDOWN TECHNIQUE (KAELIN ET AL. 1991) uses the affinity of GST for glutathione-coupled beads to purify interacting proteins from a solution of noninteracting proteins. The schema of a GST pulldown experiment is depicted in Figure 18-13. The GST fusion probe protein is expressed and purified from bacteria (please see Chapter 15, Protocol 5). In parallel, a cell lysate (which can be  $^{35}\text{S}$ -labeled or unlabeled) is prepared. The GST fusion protein probe and the cell lysate are mixed in the presence of glutathione-agarose beads and incubated to allow protein associations to occur. The GST fusion probe protein and any associated molecules are collected by centrifugation and the complexes are washed. The complexes can be eluted from the beads with excess free glutathione or boiled directly in SDS-PAGE gel-loading buffer. The proteins are resolved by SDS-polyacrylamide gel electrophoresis and processed for further analysis by western blotting, autoradiography, or protein staining. The GST pulldown technique is especially useful for probing protein interactions in solution that might go undetected in a membrane-based assay.

Two general uses of the GST pulldown experiment are to identify novel interactions between a fusion (or probe) protein and unknown (or target) proteins (Kaelin et al. 1991; Orkinick and Chao 1996) and to confirm suspected interactions between the probe protein and a known protein (e.g., please see Posern et al. 1998; Grgurevich et al. 1999; Hunter et al. 1999; Sun et al. 1999). These two experiments are designed and executed differently.

When attempting to identify novel interactions between a probe and unknown proteins, it is possible that the unknown proteins will be in limiting concentrations. To identify a novel interaction, the unknown protein must be present in sufficient quantities to allow the interaction to be visualized with the chosen method of detection. Radiolabeled cell lysates are the most frequently used source of protein for experiments of this type. Some important questions to ask before choosing the source of test proteins are: Is the probe protein normally expressed in that particular cell or tissue? If not, the physiologically relevant target proteins may not be present either. Is the goal to compare different types of cell populations (e.g., quiescent cells versus cycling cells or growth-factor-treated cells versus untreated cells)? Contemplating such variables at an early stage can mean the difference between success and failure.

If a predicted interaction between the probe protein and another protein is being tested, the experimental design is more straightforward. A wide variety of protein sources can be used to identify and map the interaction. The method used to detect the interaction is determined by the





**FIGURE 18-13 Outline of a GST Pulldown**

The recombinant GST fusion protein (*left*) or control GST (*right*) is incubated with a cell lysate in the presence of glutathione-agarose beads. The proteins are allowed to associate during end-over-end mixing at 4°C, and the reaction is then centrifuged to collect the GST or GST fusion proteins and associated proteins. The proteins are resolved on an SDS-polyacrylamide gel and subjected to autoradiography. The signals on the gel that are specific to the GST fusion protein (and not GST) represent potential interacting proteins. Variations of this protocol are described in the text.

availability of antibodies to the target protein. If none are available, then  $^{35}\text{S}$ -labeled in-vitro-translated protein can be utilized or the target protein can be tagged with an epitope. If necessary, cells in culture can be transfected with a plasmid encoding the target protein to increase the abundance of that protein for analysis. However, it is important to control for effects of mass action (e.g., nonspecific aggregation) and to ensure the specificity of the association between the probe protein and its putative partner. The best control for specificity of binding is the inclusion of a GST fusion protein with a mutated interaction domain. Loss of binding with this mutated probe protein suggests that the normal association between target and probe is specific. It is also important to test for binding between the putative target protein and GST.

The GST pulldown technique must be optimized for each protein complex being assayed. One important variable is the buffer in which the interactions will take place. This is often the buffer in which the potential partner proteins are prepared and can vary from a cell lysis buffer (such as RIPA) to an in vitro translation reaction mixture. A wide variety of buffers work; however, the efficiency of the interaction may be affected by the buffers used. Another variable to consider is the amount of target protein mixed with the fusion (probe) protein. The amount of material required is determined chiefly by the abundance of the target protein and the affinity of the interaction (both parameters are generally unknown when the experiment is initiated). Finally, the conditions used to wash the beads should be optimized. In this protocol, the cell lysis buffer is used to wash the GST-pulldown complexes; however, buffers of varying salt and detergent concentrations can be used at this step to eliminate nonspecific interactions. GST pulldown experiments have an advantage over far westerns (Protocol 2): The probe protein is incubated with potential partner proteins in a more native environment, thereby enhancing the efficiency of interactions.

## MATERIALS

**CAUTION:** Please see Appendix 12 for appropriate handling of materials marked with <!>.

### Buffers and Solutions

Please see Appendix 1 for components of stock solutions, buffers, and reagents. Dilute stock solutions to the appropriate concentrations.

#### *Lysis buffer*

20 mM Tris-Cl (pH 8.0)

200 mM NaCl

1 mM EDTA (pH 8.0)

0.5% Nonidet P-40

Just before use, add protease inhibitors to the following final concentrations: 2  $\mu\text{g}/\mu\text{l}$  aprotinin, 1  $\mu\text{g}/\mu\text{l}$  leupeptin, 0.7  $\mu\text{g}/\text{ml}$  pepstatin, and 25  $\mu\text{g}/\text{ml}$  phenylmethylsulfonyl fluoride (PMSF) <!>.

#### *Reduced glutathione (20 mM) in 50 mM Tris-Cl (pH 8.0)*

Optional, please see Step 8.

#### *2x SDS-PAGE gel-loading buffer*

### Gels

#### *SDS polyacrylamide gel <!>*

For details on SDS-polyacrylamide gel electrophoresis, please see Appendix 8.

### Special Equipment

#### *Boiling water bath*

#### *End-over-end sample rotator*

#### *Glutathione agarose beads*

Prepare as a 50% slurry in lysis buffer.

## Probes

*GST protein*

*GST fusion protein carrying the "bait" or probe sequence*

Construct as described in Chapter 15, Protocol 1.

## Cells and Tissues

*Cell lysate in which the proteins are <sup>35</sup>S-labeled*

It is possible to use unlabeled cell lysates depending on the goals of the experiment and the desired detection method. For additional details, please see the protocol introduction.

## Additional Reagents

*Step 11 of this protocol requires reagents for immunoblotting and staining proteins separated by SDS-polyacrylamide gel electrophoresis as listed in Appendix 8.*

## METHOD

---

### Preclearing the Cell Lysate

1. Incubate the cell lysate with 50  $\mu$ l of a 50% slurry of glutathione agarose beads and 25  $\mu$ g of GST for 2 hours at 4°C with end-over-end mixing. The amount of lysate needed to detect an interaction is highly variable. Start with a volume of lysate equivalent to  $1 \times 10^6$  to  $1 \times 10^7$  cells.

Because the aim of the experiment is to compare GST with a GST fusion protein, it is necessary to prepare enough precleared lysate for each reaction. Efficient mixing of reagents is the key to success. This is best achieved if the reaction is carried out in a reasonable volume: 500–1000  $\mu$ l is a good starting point.

This preclearing step is designed to remove proteins from the lysate that interact nonspecifically with the GST moiety or the beads alone. It is not always necessary to preclear the lysates with GST or glutathione agarose beads if the interaction will be detected primarily with antibodies directed to a candidate interacting protein. However, when <sup>35</sup>S-labeled cell lysates are used to identify novel protein-protein interactions, these steps can help to reduce background. If the interaction will be detected with antibodies to a candidate interacting protein, it is important to include two controls: GST plus beads and only beads.

If the interacting protein of interest is known to be confined to a specific cellular compartment, the probe can be mixed with a fraction of the cell lysate corresponding to that compartment.

2. Centrifuge the mixture at maximum speed for 2 minutes at 4°C in a microfuge.
3. Transfer the supernatant (i.e., the precleared cell lysate) to a fresh microfuge tube.

### Probing the Cell Lysate

4. Set up two microfuge tubes containing equal amounts of precleared cell lysate and 50  $\mu$ l of glutathione agarose beads. To one tube add ~10  $\mu$ g of GST protein; to the other tube add ~10  $\mu$ g of the GST fusion probe protein. The amount of probe and control protein added should be equimolar in the two reactions (i.e., the final molar concentration of GST should be the same as the GST fusion probe protein). Incubate the tubes for 2 hours at 4°C with end-over-end mixing.

▲ **IMPORTANT** If the bound proteins will be removed from the beads by boiling (Step 10), it is important to include a control tube containing only glutathione agarose beads and cell lysate. This allows the detection of proteins that bind nonspecifically to the beads.

5. Centrifuge the samples at maximum speed for 2 minutes in a microfuge.

6. Save the supernatants at 4°C in fresh microfuge tubes. These samples will be analyzed by SDS-polyacrylamide gel electrophoresis analysis in Step 10.
7. Wash the beads with 1 ml of ice-cold lysis buffer. Centrifuge the tubes at maximum speed for 1 minute in a microfuge. Discard the supernatants. Repeat the washes three times.
8. (Optional) Elute the GST fusion protein and any proteins bound to it by adding 50 µl of 20 mM reduced glutathione in 50 mM Tris-Cl (pH 8.0) to the beads. Centrifuge the tubes at maximum speed for 2 minutes in a microfuge.
9. Mix the beads (from Step 7) or the eluted proteins (from Step 8) with an equal volume of 2X SDS-PAGE gel-loading buffer.

### Detecting Interacting Proteins

10. Boil the samples for 4 minutes and analyze them by SDS-polyacrylamide gel electrophoresis.
11. The method of detecting proteins associated with the GST fusion protein will depend on whether or not the cell lysate was radiolabeled and on the goal of the experiment.
  - If the goal is to detect all of the <sup>35</sup>S-labeled proteins associated with the fusion protein, dry the gel on a gel dryer and expose it to X-ray film to produce an autoradiograph.
  - If the goal is to detect specific associated proteins, transfer the proteins from the SDS-polyacrylamide gel to a membrane and perform immunoblotting (Appendix 8).
  - If the goal is to determine the sizes and abundance of proteins associated with the fusion protein from a nonradioactive lysate, stain the gel with Coomassie Blue or silver nitrate (Appendix 8).

#### TROUBLESHOOTING GST PULLDOWN EXPERIMENTS

Troubleshooting a GST pulldown experiment is facilitated by analyzing and comparing aliquots from various stages of the experiment using SDS-polyacrylamide gel electrophoresis. For example, separate the following samples by electrophoresis through an SDS-polyacrylamide gel, loading approximately equivalent amounts (e.g., 1%) of the total cell lysate from each sample:

- the total cell lysate (Step 1)
- the supernatant saved at Step 6
- the eluate (Step 8)
- the eluate from the control containing GST (Step 8)
- the eluate from the control containing beads and cell lysate (Step 8)
- the beads after elution (Step 9)

Comparing each of these samples for the quantity of a target protein that binds to the GST fusion protein may suggest the causes and remedies of various problems. For example, a low signal, even though the target protein is abundant in the total cell lysate, may indicate that the binding conditions are not optimal. A change in salt and detergent concentrations, in addition to increasing the time allowed for association, may improve the result. By contrast, the complex may be retained on the glutathione agarose beads due to inefficient elution. This can be determined by SDS-polyacrylamide gel electrophoresis analysis of the "fusion-protein-beads post elution" fraction. The problem may be remedied by pooling multiple elutions. Preclearing a lysate with GST and/or beads can help to reduce nonspecific interactions. Decreasing the amount of lysate added and increasing the stringency of the wash conditions can also reduce background.

Finally, if the interaction is analyzed by western blotting, it is important to probe the membrane with anti-GST antibodies after probing with antibody specific for the target protein. This control will reveal whether all samples were incubated with the same amount of GST fusion protein and will help to determine whether the fusion protein is degraded during incubation with the cell lysate.

# Protocol 4

---

## Identification of Associated Proteins by Coimmunoprecipitation

Peter D. Adams

*Fox Chase Cancer Center, Philadelphia, Pennsylvania 19111*

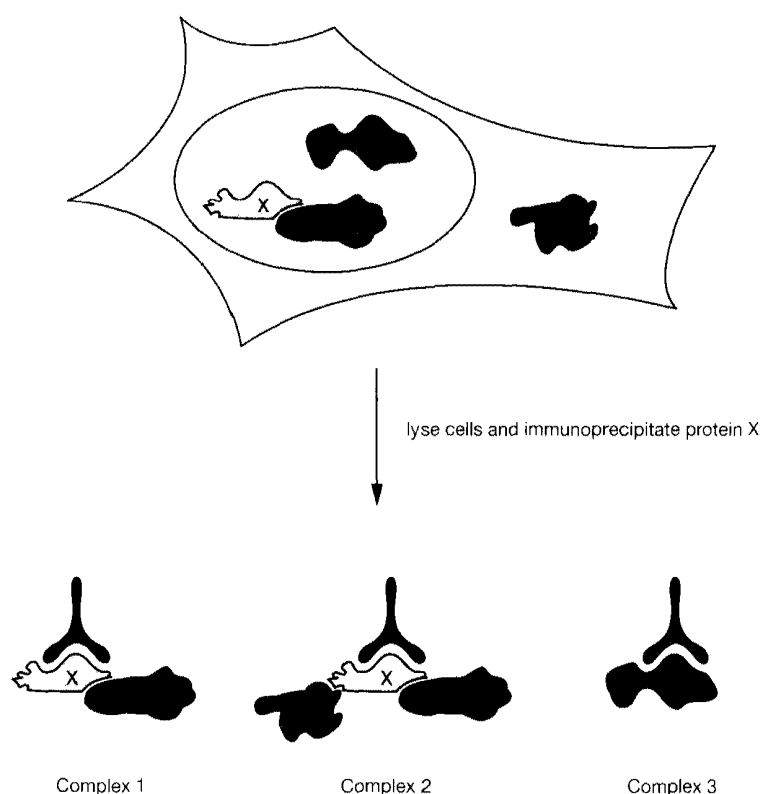
Michael Ohh

*Dana-Farber Cancer Institute and Harvard Medical School, Boston, Massachusetts 02115*

**W**HEN A CELL IS LYSED UNDER NONDENATURING CONDITIONS, many of the protein-protein associations that exist within the intact cell are conserved. This fact can be used to advantage to detect and identify physiologically relevant protein-protein interactions. As illustrated in Figure 18-14, if protein X is immunoprecipitated with an antibody to X, then protein Y, which is stably associated with X *in vivo*, may also precipitate (please see Figure 18-14, Complex 1). The immunoprecipitation of protein Y, based on a physical interaction with X, is referred to as coimmunoprecipitation. This approach is most commonly used to test whether two proteins of interest are associated *in vivo*, but it can also be used to identify novel interacting partners of a particular protein. Examples of the latter approach include the identification of p21cip1 as a protein that interacts with cyclin D/Cdk4 kinase (Xiong et al. 1993); elongins B and C, Cul2, and fibronectin as partners with the von Hippel-Lindau tumor suppressor protein (pVHL) (Duan et al. 1995; Kibel et al. 1995; Pause et al. 1997; Lonergan et al. 1998; Ohh et al. 1998); and transformation/transcription domain-associated protein (TRRAP) as a protein that interacts with the E2F1 and c-Myc transcription factors (McMahon et al. 1998).

Perhaps the most rigorous demonstration of a physiological interaction between two proteins is their coimmunoprecipitation from cell extracts. A putative interaction might first be identified by use of a powerful high-throughput approach such as a yeast two-hybrid screen and subsequently shown by coimmunoprecipitation of the two proteins to be a true physiological interaction. Detection of a protein-protein interaction in this manner can often be facilitated by transient transfection of cells with plasmids encoding the relevant proteins, followed by expression of the proteins. However, overexpression of the proteins from the plasmids might drive interactions between the two proteins that are not physiological. Thus, it is always preferable to demonstrate the interaction of the two proteins within their native untransfected cells.

The use of coimmunoprecipitation to search for novel proteins that interact with a known protein is a powerful way to identify physiological interactions within the intact cell. The major disadvantages of the method, however, are that it is relatively laborious, time-consuming, often requires a very large number of cultured cells, and may not detect low-affinity and transient protein-protein interactions. Moreover, coimmunoprecipitation only works with proteins that per-



**FIGURE 18-14 Principle and Pitfalls of Detection of Proteins by Coimmunoprecipitation**

In the intact cell, protein X is present in a complex with protein Y. This complex is preserved after cell lysis and allows protein Y to be coimmunoprecipitated with protein X (Complex 1). However, the disruption of subcellular compartmentalization could allow artifactual interactions to occur between some proteins, for example, protein X and protein B (Complex 2). Furthermore, the antibody that is used for the immunoprecipitation may cross-react nonspecifically with other proteins, for example, protein A (Complex 3). The key to identification of protein:protein interactions by coimmunoprecipitation is to perform the proper controls so as to identify protein Y but not proteins A and B.

sist in physiological complexes after they have been solubilized from the cell. Thus, coimmunoprecipitation may not be appropriate for the detection of protein-protein interactions that make up large, insoluble macromolecular structures of the cell, such as the nuclear matrix.

## OUTLINE OF THE PROCEDURE

Whether the goal is to test for a specific interaction between two known proteins or to identify novel proteins that interact with a known protein, the principle of coimmunoprecipitation is the same. The cells are harvested and lysed under conditions that preserve protein-protein interactions, a protein of interest is specifically immunoprecipitated from the cell extracts, and the immunoprecipitates are then fractionated by polyacrylamide gel electrophoresis. In the past, this has generally been by one-dimensional SDS-polyacrylamide gel electrophoresis. However, two-dimensional gels using isoelectric focusing (IEF) and SDS-polyacrylamide gel electrophoresis offer improvements in both resolution and sensitivity, and the development of proteomics technologies is making such gels more commonplace.

Coprecipitation of a protein of known identity is most commonly detected by western blotting with an antibody directed against that protein. Alternatively, if the cells are metabolically

labeled with [ $^{35}\text{S}$ ]methionine before lysis, then coprecipitating proteins can be visualized by autoradiography. The identity of certain radiolabeled proteins can be determined using immunological techniques (e.g., reimmunoprecipitation of the protein in question with a relevant antibody) (Beijersbergen et al. 1994; Ginsberg et al. 1994; Vairo et al. 1995) or by comparative peptide mapping.

If the goal is to identify novel interacting proteins, then the putative associated protein is first detected in the gel, usually as a  $^{35}\text{S}$ -labeled or stained band. Subsequently, coimmunoprecipitation is carried out on a scale large enough to obtain sufficient material for identification of the associated protein by Edman degradation or mass spectrometry.

The remainder of this introduction serves as a guide for optimizing and troubleshooting coimmunoprecipitation reactions and the subsequent identification of the precipitated proteins. Also included is a discussion of the controls that should be performed to ensure that a coprecipitating protein is truly a physiologically relevant partner. For detailed discussions and protocols on cell lysis, immunoprecipitation, and related techniques, please see Harlow and Lane (1988, 1999). The coimmunoprecipitation protocol, which follows the introduction, is based on one that was used to identify Cul2 and fibronectin as proteins associated with pVHL, a tumor suppressor protein whose loss of function is responsible for tumor formation in von Hippel-Lindau disease. The protocol was originally performed using 786-O renal carcinoma cells that were stably transfected with a plasmid expressing hemagglutinin-tagged pVHL (786-O/HA-pVHL). Control cells, that were stably transfected with the empty vector alone, were processed in parallel.

#### VHL GENE PRODUCT AND VON HIPPEL-LINDAU DISEASE

von Hippel-Lindau disease is a hereditary cancer syndrome that is characterized by the development of renal carcinomas, pheochromocytomas, and vascular tumors of the central nervous system and retina (Ohh and Kaelin 1999). Tumors result from functional inactivation of both copies of the VHL gene. The protein product of the VHL gene, pVHL, interacts with a number of cellular proteins, including elongins B and C, Rbx1, and a member of the Cullin family of proteins, Cul2 (Duan et al. 1995; Kibel et al. 1995; Pause et al. 1997; Lonergan et al. 1998; Kamura et al. 1999b). Recent work suggests that the pVHL/elongin B and C/Rbx1/Cul2 complex serves as an E3 ubiquitin ligase and targets certain proteins for degradation (Iwai et al. 1999; Kamura et al. 1999a,b; Lisztwan et al. 1999; Tyers and Willems 1999). This activity of pVHL is thought, at least in part, to underlie its tumor suppressor function. The pVHL protein also interacts stably with the extracellular matrix protein, fibronectin (Ohh et al. 1998).

## CELL LYSIS AND IMMUNOPRECIPITATION

When lysing cells, a major consideration is that the conditions used for solubilization extract the protein to be immunoprecipitated, but do not disrupt all of the protein-protein interactions that exist within the cell. Thus, it is best to determine in advance the mildest lysis conditions that efficiently solubilize the majority of the protein of interest. These pilot experiments can generally be performed on a small scale, requiring cell extract derived from  $10^6$  to  $10^7$  cells for each immunoprecipitation. In general, a higher salt concentration (200–1000 mM NaCl) and the presence of an ionic detergent (0.1–1% SDS or sodium deoxycholate) are more disruptive than lower amounts of salt (120 mM NaCl) and the presence of a nonionic detergent (0.1–1% Nonidet P-40 or Triton X-100). Similarly, mechanical processes, such as sonication, tend to denature and disrupt protein-protein interactions. However, it is important to note that the lysis conditions that solubilize and yet do not dissociate a particular protein complex should be determined empirically.

Once the lysis conditions have been determined, the cleared cell lysate is subjected to a standard immunoprecipitation with an antibody directed against the protein of interest. It is impor-

tant to perform a parallel immunoprecipitation with the relevant control antibodies (please see Controls for Coimmunoprecipitation, below). When establishing the conditions for cell lysis and protein solubilization, bear in mind that high concentrations of ionic detergent (e.g., >0.2% SDS) and the presence of reducing agents will tend to denature the antibody and interfere with the immunoprecipitation.

## DETECTION OF ASSOCIATED PROTEINS

---

If the purpose of the experiment is to test whether two particular proteins interact *in vivo*, then the presence of the second protein is usually detected by western blotting or, if the cells were metabolically labeled with [<sup>35</sup>S]methionine before lysis, by autoradiography. Western blotting is straightforward and, assuming that the antibody used for the western blot is well-characterized (please see below), relatively unambiguous. Autoradiography has the advantage that the <sup>35</sup>S-labeled protein of interest can be compared by tryptic mapping with <sup>35</sup>S-labeled protein derived from *in vitro* transcription and translation of a defined cDNA, resulting in unambiguous confirmation of the protein's identity (Xiong et al. 1992, 1993; Kibel et al. 1995).

If the purpose is to identify novel associated proteins, then these can be detected by direct staining of the proteins in the gel. At this stage, before scaling up the procedure, only the more sensitive stains, such as silver staining (Appendix 8) and imidazole-zinc negative staining, generally have the required level of sensitivity (Matsui et al. 1999). Alternatively, if the cells are labeled before lysis with [<sup>35</sup>S]methionine, then radiolabeled associated proteins can be visualized by autoradiography or with a phosphorimager.

## CONTROLS FOR COIMMUNOPRECIPITATION

---

The major pitfall associated with identification of novel associated proteins by coimmunoprecipitation is the identification of false positives. These false positives arise from the presence of proteins in the washed immunoprecipitate that are not normally associated with the protein of interest in the intact cell. Such contaminants result from formation of nonphysiological protein-protein interactions after cell lysis (Figure 18-14, Complex 2) or as a result of cross-reactivity and nonspecific binding of the antibody to cellular proteins (Figure 18-14, Complex 3). Fortunately, much can be done to eliminate or control for such confounding interactions.

### Using Well-characterized Antibodies

Any antibody that is used for the immunoprecipitation should be well-defined (e.g., Hu et al. 1991; Marin et al. 1998), i.e., it should be proven to immunoprecipitate from crude cell extracts, the protein against which it was raised. There are a number of ways that this ability can be demonstrated:

- Showing that multiple antibodies, independently raised to the same protein, recognize the *same* polypeptide.
- Showing that the antibodies fail to detect their target protein in a cell line that lacks that protein. Cell lines lacking a particular protein are commonly available as human cell lines derived from individuals with cancer predisposition syndromes (e.g., 786-O renal carcinoma cells lack the pVHL tumor suppressor protein) or from mice with a targeted knock-out of a particular gene.



- Comparing the peptide map generated by proteolytic digestion of  $^{35}\text{S}$ -labeled protein immunoprecipitated from metabolically labeled cells with that derived from  $^{35}\text{S}$ -labeled in vitro translation of a defined cDNA. In the latter approach, the  $^{35}\text{S}$ -labeled protein is digested with a protease, such as V8 protease or chymotrypsin, and the peptides are fractionated by SDS-polyacrylamide gel electrophoresis. The  $^{35}\text{S}$ -labeled peptide map is compared with the map obtained from a  $^{35}\text{S}$ -labeled protein derived from in vitro transcription and translation of a known cDNA. If the protein immunoprecipitated from the cell extracts is identical to the protein encoded by the cDNA, then the peptide maps should be essentially identical (Xiong et al. 1992, 1993; Kibel et al. 1995).

### Using Control Antibodies

Even mouse monoclonal antibodies interact nonspecifically with proteins that are distinct from the immunogen (Figure 18-14, Complex 3). Any putative associated protein that immunoprecipitates with a control antibody as well as the specific antibody is, by definition, nonspecifically binding to the antibody. The more the control antibody and the specific antibody match, the less the chance of erroneously identifying a nonspecifically interacting protein. For a mouse monoclonal antibody, the proper control is another monoclonal antibody of the same subclass; for a rabbit serum, it is the preimmune serum from the same rabbit, and for a purified rabbit polyclonal, it is another purified rabbit polyclonal antibody.

### Using Multiple Antibodies

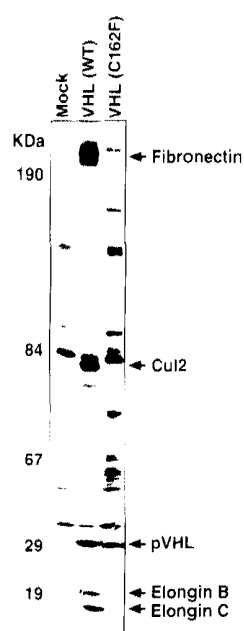
The ability to coprecipitate a protein (such as protein Y in Figure 18-14) using more than one antibody against protein X increases the level of confidence that proteins X and Y are associated in vivo. A caveat here is that different antibodies recognize different epitopes, some of which might be obscured in a particular protein complex. Thus, not all antibodies should be expected to coprecipitate the same panel of associated proteins.

### Using Cell Lines Lacking the Target Protein

A coprecipitating protein should not be precipitated from lysates of a cell line lacking the protein that is the primary target of the antibody (Kibel et al. 1995). Thus, control immunoprecipitates should be performed from cell lines known to lack the target protein.

### Testing Biologically Relevant Mutants

A protein that associates with the immunoprecipitated protein in a functionally significant way might fail to interact with biologically inactive mutants of the protein and consequently may not coprecipitate. Thus, if possible, obtain or generate cell lines containing biologically inactive mutants of the target protein. Such mutants might be naturally expressed in certain human cell lines (e.g., tumor-derived cell lines containing mutant versions of a protein) or, alternatively, can be expressed as epitope-tagged proteins by transient transfection of cells. The epitope-tagged mutant proteins can then be specifically immunoprecipitated with antibodies directed against the epitope tag. For example, the Cullin family member, Cul2, and other physiologically relevant pVHL-binding proteins, such as fibronectin and elongins B and C, failed to interact with a naturally occurring point mutant of pVHL derived from a tumor (Figure 18-15).



**FIGURE 18-15 Coimmunoprecipitation of pVHL-associated Proteins**

786-O renal carcinoma cells stably transfected with a backbone expression plasmid (*left lane*), a plasmid encoding HA-epitope-tagged wild-type pVHL (*middle lane*), and a plasmid encoding HA-epitope-tagged tumor-derived pVHL (C162F) were labeled with [ $^{35}\text{S}$ ]methionine, lysed, and immunoprecipitated with anti-HA antibody. Coimmunoprecipitates were washed with NETN+900 mM NaCl. Bound proteins were resolved by electrophoresis in a 7.5–15% discontinuous SDS-polyacrylamide gel and detected by fluorography.

### Testing Whether Association Occurs Before or After Cell Lysis

Cell lysis involves a massive disruption of cellular compartmentalization, bringing into proximity proteins that might never normally be in the same subcellular location. This provides an opportunity for nonphysiological complexes to form after cell lysis (Figure 18-14, Complex 2). In principle, it is possible to suppress such postlysis interactions by inclusion of the relevant protein in the cell lysis buffer. For example, Ohh et al. (1998) included purified, nonradiolabeled fibronectin in the cell lysis buffer and showed that it was unable to prevent coprecipitation with pVHL of the endogenous  $^{35}\text{S}$ -labeled fibronectin present in the cell before lysis. From this, and other cell lysate mixing experiments, these authors concluded that the  $^{35}\text{S}$ -labeled fibronectin was associated with pVHL before cell lysis.

### Reducing the Background of Nonspecific Proteins

The number of proteins that coprecipitate by virtue of nonspecific interaction with the antibody (Figure 18-14, Complex 3) or nonphysiological association with the protein to which the antibody is raised (Figure 18-14, Complex 2) can be reduced by careful optimization of the conditions for immunoprecipitation. Three procedures are commonly adopted.

- **Increase the ionic strength of the immunoprecipitate wash buffer.** Just as a higher concentration of salt in the lysis buffer is generally more disruptive of protein-protein associations, so a higher concentration of salt in the wash buffer will, in general, reduce nonspecific protein-protein interactions. The salt concentration in the wash buffer should be titrated from 120 to 1000 mM NaCl. However, high concentrations of salt can perturb SDS-polyacrylamide gel electrophoresis. Therefore, the immunoprecipitates should be washed with a standard salt buffer (120 mM NaCl) immediately before loading on the gel.

- **Decrease the amount of primary antibody in the immunoprecipitation.** Decreasing the concentration of the primary antibody in the immunoprecipitate will decrease the total number of proteins that nonspecifically coprecipitate. The concentration of the antibody should be decreased to a point where the signal obtained from any specific protein is maximized relative to any nonspecific protein.
- **Preclear the cell lysate with the control antibody.** Before performing the immunoprecipitation with the specific antibody directed against the protein of interest, carry out an immunoprecipitation of the cell lysate with an excess of the control antibody and protein A–Sepharose (Harlow and Lane 1988).

## PROTEIN IDENTIFICATION

---

If a novel coprecipitated protein was originally detected by silver staining or labeling with [<sup>35</sup>S]methionine, then it can be identified by obtaining primary sequence information, either by direct Edman degradation (Aebersold et al. 1987; Kamo and Tsugita 1999; Loo and Muenster 1999) or by mass spectrometry (Courchesne and Patterson 1999; Jensen et al. 1999; Wilkins et al. 1999; Yates et al. 1999). Usually, sequence information is obtained on the peptides that result from internal proteolytic cleavage of the protein with trypsin.

The minimum amount of protein required to obtain useful information by either Edman sequencing or mass spectrometry depends on a number of factors, including the properties and character of the protein concerned and the method of sample preparation. In general, Edman sequencing requires ~10 pmoles of protein for sequencing of internal proteolytic fragments (500 ng of a 50-kD protein). State-of-the-art mass spectrometry methods are more sensitive and can be used for sequencing at picomole or subpicomole amounts. As a result, mass-spectrometry-based approaches are increasingly the method of choice. *Matrix-assisted laser desorption ionization–time of flight* (MALDI-TOF) mass spectrometry can be used to obtain a peptide “mass map,” which contains the masses of all of the peptides derived from digestion of the protein (Courchesne and Patterson 1999). This mass map provides a unique “fingerprint” of that protein, which can be compared against the predicted mass maps of all known proteins to aid in identifying the protein. Once the Human Genome Project is completed, the predicted sequence and therefore the predicted mass maps of all human proteins will be available in databases. Alternatively, *liquid chromatography–tandem MS* (LC-MS/MS) can be used to obtain primary sequence information on peptides within the digest (Jensen et al. 1999; Yates et al. 1999). This sequence information can also be used to identify a protein. At least until the completion of the Human Genome Project, there will still be a place for traditional Edman sequencing as a tool for protein identification.

Although sequence data can be obtained using picomole amounts of protein, larger quantities of protein consistently provide better and more unambiguous data. Thus, a significant scaling-up from the initial immunoprecipitation is generally required. For example, to obtain enough protein (2 µg) to generate primary sequence information of the cyclin D/Cdk4-associated p21cip1, Beach and co-workers started with 400 15-cm plates of human WI38 cells (Xiong et al. 1993). Obviously, the number of cells required depends on the abundance of the proteins concerned and the efficiency of the immunoprecipitation, underscoring the importance of optimizing the immunoprecipitation protocol for the particular protein of interest.

## MATERIALS

CAUTION: Please see Appendix 12 for appropriate handling of materials marked with <!.>.

### Buffers and Solutions

Please see Appendix 1 for components of stock solutions, buffers, and reagents. Dilute stock solutions to the appropriate concentrations.

*Acetonitrile (50%) <!.>*

*Coomassie Blue R-250*

*EBC lysis buffer*

50 mM Tris-Cl (pH 8.0)

120 mM NaCl

0.5% (v/v) Nonidet P-40

5 µg/ml leupeptin

10 µg/ml aprotinin

50 µg/ml PMSF <!.>

0.2 mM sodium orthovanadate

100 mM NaF <!.>

*NETN*

20 mM Tris-Cl (pH 8.0)

1 mM EDTA

100 mM NaCl

0.5% (v/v) Nonidet P-40

*NETN containing 900 mM NaCl*

*Phosphate-buffered saline*

*1x SDS gel-loading buffer*

*Trifluoroacetic acid (TFA) (0.1% w/v, sequencing grade) <!.>*

### Enzymes and Buffers

*Trypsin*

Prepare bovine trypsin at 250 µg/ml in 200 mM ammonium bicarbonate (pH 8.9) (sequencer grade; Boehringer Mannheim)

*Trypsin digestion buffer*

0.02% (v/v) Tween-20

200 mM ammonium bicarbonate (pH 8.9)

### Antibodies

*Antibody or antibodies that will precipitate the target protein*

*Control antibody*

### Gels

*Discontinuous SDS-PAGE gradient gel <!.>*

The separation gel (a discontinuous 7.5–15% gel at pH 8.8) should be 20–30 cm long, the stacking gel (5% at pH 6.8) should be 10 cm long, and the well itself should be 1–2-cm deep (the % of the gel will vary with the protein of interest). Pour the stacking gel without a multiwell comb, and construct the wells by inserting spacers vertically between the glass plates, so that they form a well that is large enough for the sample. For further details on SDS-PAGE gels, please see Appendix 8.

### Special Equipment

*Boiling water bath*

*Protein A-Sepharose*

Prepare the protein A-Sepharose as a 1:1 slurry in NETN buffer.

*Rocking platform*

## Additional Reagents

Steps 10 and 11 of this protocol require the reagents and equipment for mapping, purification, and sequencing of peptides (please see Spector et al. 1998, Chapters 62 and 63).

## Cells and Tissues

Appropriate cell line(s) growing in culture

## METHOD

---

▲ **IMPORTANT** This protocol was used to identify pVHL-associated proteins. Conditions should be optimized for the protein of interest.

1. Wash 30 10-cm plates of the appropriate cells (a total of  $\sim 6 \times 10^7$  cells) in phosphate-buffered saline. Scrape each plate of cells into 1 ml of ice-cold EBC lysis buffer.
2. Transfer each milliliter of cell suspension into a microfuge tube, and centrifuge the tubes at maximum speed for 15 minutes at 4°C in a microfuge.
3. Pool the supernatants ( $\sim 30$  ml) and add 30  $\mu$ g of the appropriate antibody. Rock the immunoprecipitate for 1 hour at 4°C.
4. Add 0.9 ml of the protein A–Sepharose slurry. Rock the immunoprecipitate for another 30 minutes at 4°C.
5. Wash the protein A–Sepharose mixture in NETN containing 900 mM NaCl. Repeat this wash five more times. Finally, wash the mixture once in NETN.
6. Remove the liquid portion of the mixture by aspiration. Add 800  $\mu$ l of 1x SDS gel-loading buffer to the beads, and boil them for 4 minutes.
7. Load the sample into the large well of the discontinuous SDS-PAGE gradient gel, and run the gel at 10 mA constant current overnight.
8. Visualize the protein bands by staining with Coomassie Blue (Appendix 8).
9. Excise the band of interest from the gel, place it in a microfuge tube, and wash it twice for 3 minutes each in 1 ml of 50% acetonitrile.
10. Digest the protein with trypsin while it is still in the gel, and electroelute the peptides.
  - a. Remove the gel slice to a clean surface and allow it to partially dry.
  - b. Add 5  $\mu$ l of trypsin digestion buffer and 2  $\mu$ l of trypsin solution.
  - c. After the gel absorbs the trypsin solution, add 5- $\mu$ l aliquots of trypsin buffer until the gel slice regains its original size.
  - d. Place the gel slice in a microfuge tube, immerse it in trypsin digestion buffer, and incubate it for 4 hours at 30°C. Stop the reaction by addition of 1.5  $\mu$ l of 0.1% trifluoroacetic acid.

Procedures for visualization and digestion of the protein vary greatly. In particular, digestion can be performed while the protein is still in the polyacrylamide gel or after it has been transferred to a nitrocellulose or PVDF membrane.
11. Fractionate the peptides by narrow-bore high-performance liquid chromatography. Subject the collected peptides to automated Edman degradation sequencing on an ABI 477A or 494A machine.

Processing of the samples for Edman sequencing or MS analysis also varies and this is best discussed with the individual who is operating the machinery. For a review of methods, please see Matsudaira (1993), Link (1999), and Spector et al. (1998, Chapters 62 and 63).

# Protocol 5

---

## Probing Protein Interactions Using GFP and Fluorescence Resonance Energy Transfer

Alisa G. Harpur and Philippe I.H. Bastiaens

*Imperial Cancer Research Fund, London*

**F**OLLOWING THE DISCOVERY AND CLONING OF THE GREEN FLUORESCENT PROTEIN (GFP) from the jellyfish, *Aequorea victoria* (Prasher et al. 1992), many opportunities for the analysis of gene function and protein-protein interactions have emerged. Such opportunities range from the visual tracking of proteins in a spatial and temporal manner to the quantitation of the intrinsic photophysical properties of the GFPs themselves, allowing them to be used as indicators or sensors of biological activities/processes and protein interactions.

### **GFP: IMPACT ON MOLECULAR AND CELLULAR BIOLOGY AND APPLICATION TO PROTEIN INTERACTIONS**

---

GFP is intrinsically fluorescent and does not require exogenous cofactors or substrates, a property that renders it highly useful as a genetically encoded reporter tag (please see the information panel on **GREEN FLUORESCENT PROTEIN** in Chapter 17). This is particularly valuable for analysis of gene expression in embryonic and intact organisms using either endogenously regulated (gene trapping) or tissue-specific promoters (Chalfie et al. 1994; Moss et al. 1996). The utility of GFP has also been demonstrated in establishing the subcellular localization of fusion proteins (Chalfie et al. 1994; Moss et al. 1996; Arnone et al. 1997). Organelle-specific localization signals have been successfully fused to GFP mutants, thus targeting the GFP to locations such as the endoplasmic reticulum, the Golgi apparatus (Dayel et al. 1999), mitochondria (Niwa et al. 1999), and the plasma membrane (Okada et al. 1999). In addition to localization of proteins, GFP has been used as an intracellular sensor of biological activity by exploiting its photophysical properties. For example, GFP can be used as an indicator of protein proximity by detection of the excited-state reaction, fluorescence resonance energy transfer (FRET). To date, this technique has been used in the analysis of calcium-sensitive constructs (Miyawaki et al. 1997, 1999) and protease substrates (Heim and Tsien 1996; Mitra et al. 1996; Xu et al. 1998; Mahajan et al. 1999) and for detecting the interaction between a number of proteins (Day 1998; Mahajan et al. 1998). Additionally, FRET between GFP and Cy3 has been used to image cellular processes such as the phosphorylation of intracellular and transmembrane proteins (Ng et al. 1999; Wouters and Bastiaens 1999). In this protocol, a detailed description of the latter type of experiment is given using fluorescence lifetime imaging microscopy (FLIM).

## FLUORESCENCE RESONANCE ENERGY TRANSFER

### Photophysical Principles of FRET

Until recently, molecular and cellular biologists have had to address the question of specific protein-protein interactions with a limited number of techniques that rely heavily upon the use of chemical cross-linking agents and antibodies (please see Protocols 2 through 4 of this chapter). However, techniques such as immunoprecipitation or affinity chromatography do not preserve the physiological conditions under which proteins may normally interact in the cell. In addition, these approaches do not provide information on the spatial distribution of the interacting proteins. Immunocytochemical colocalization, while providing indirect evidence of the presence of two particular proteins within the same cellular compartment, fails to confirm whether the suspected components actually interact directly. FRET can be measured to address such questions of specificity in intact cells (Bastiaens and Squire 1999).

FRET is a nonradiative, dipole-dipole coupling process whereby energy from an excited donor fluorophore is transferred to an acceptor fluorophore in close proximity (typically within 10 nm). Excitation of the donor will thus produce sensitized emission from the acceptor that ordinarily would not occur in the absence of FRET. If proteins are fused to genetically encoded GFP variants or chemically modified by covalent attachment of synthetic fluorophores with appropriate characteristics to allow visualization of donor-acceptor interactions (Bastiaens and Jovin 1998; Griffin et al. 1998), then the molecular interaction of the proteins in question can be inferred by FRET between the fluorophores. The rate ( $k_t$ ; ns<sup>-1</sup>) at which Förster-type energy transfer occurs is given by the equation:

$$k_t = \tau_D^{-1} \left( \frac{R_0}{R} \right)^6 \quad (1)$$

such that

$$R_0 = (\kappa^2 \cdot J(\lambda) \cdot n^{-4} \cdot Q)^{1/6} \cdot 9.7 \cdot 10^2 \quad (2)$$

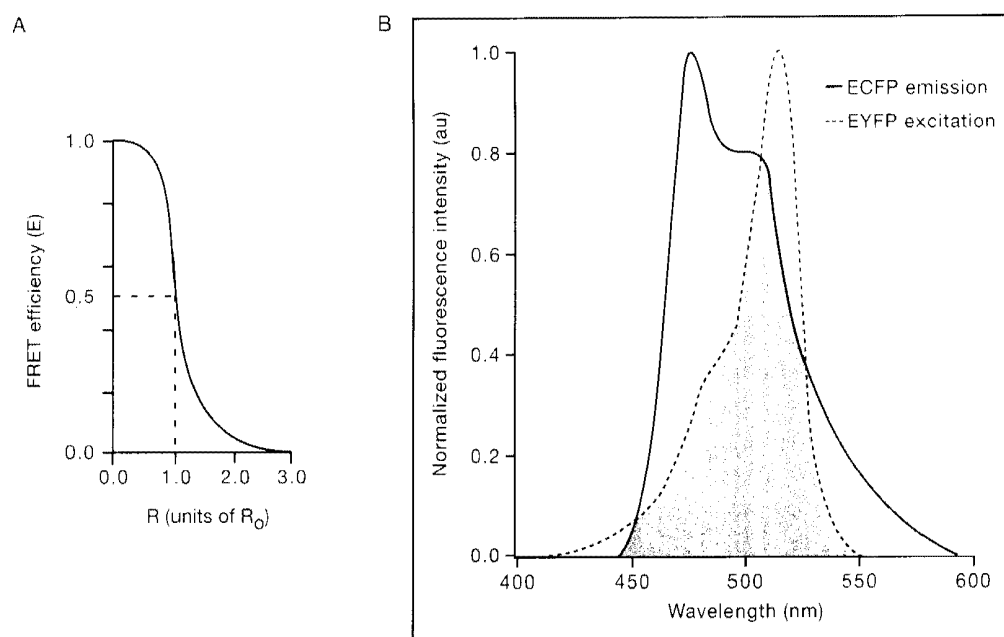
where  $R$  (nm) is the actual distance between the centers of the fluorophores,  $R_0$  (nm) is the distance at which energy transfer efficiency ( $E$ ) is 50% (Figure 18-16), and  $\tau_D$  (ns) is the fluorescence lifetime of the donor in the absence of the acceptor. Substitution of Equation 1 into the definition of energy transfer efficiency (Equation 3) shows that there is also a steep distance-dependence in the FRET efficiency ( $E$ ):

$$E = \frac{k_t}{(k_t + \tau_D^{-1})} = \frac{R_0^6}{(R_0^6 + R^6)} \quad (3)$$

Factors such as the quantum yield ( $Q$ ) of the donor, the relative orientation of the transition dipoles of the fluorophores ( $\kappa^2$ ), the refractive index of the intervening medium ( $n$ ), and the overlap integral ( $J(\lambda)$ ; cm<sup>6</sup> mole<sup>-1</sup>) of the donor emission and acceptor absorption spectra will affect  $R_0$  (Clegg 1996). The overlap integral ( $J(\lambda)$ ; cm<sup>6</sup> mole<sup>-1</sup>) is given by:

$$J(\lambda) = \frac{\int_0^\infty F(\lambda)\epsilon(\lambda)\lambda^4 d\lambda}{\int_0^\infty F(\lambda) d\lambda} \quad (4)$$

where  $\epsilon(\lambda)$  (M<sup>-1</sup>cm<sup>-1</sup>) is the extinction coefficient of the acceptor, and  $F(\lambda)$  is the fluorescence intensity of the donor, at wavelength  $\lambda$ .


**FIGURE 18-16 Fluorescence Emission and Absorption Spectra**

(A) FRET efficiency ( $E$ ) as a function of interchromophore distance in units of  $R_0$ . (B) Spectral overlap (*shaded area*) between the fluorescence emission spectrum of ECFP and the absorption spectrum of EYFP.

To select a suitable chromophore pair for FRET-based protein interaction detection, two main factors must be considered in order to optimize  $R_0$ ; (1) the quantum yield of the donor  $Q$  and (2) the spectral overlap between donor emission and acceptor absorption determined by the overlap integral  $J(\lambda)$ , which is dependent on the acceptor extinction coefficient  $\epsilon(\lambda)$ . In addition to these considerations, the choice also depends on the pair being spectrally distinct enough to facilitate unambiguous detection of the donor with an appropriate band pass filter. Final considerations are practicalities such as the feasibility of the construction of functional fusion proteins or fluorophore conjugates and their delivery into cells. Therefore, the optimal  $R_0$  must be considered bearing in mind the examined protein system.

The engineering of blue- and red-shifted variants of GFP, such as cyan (CFP) and red (DsRed) fluorescent protein, has facilitated the measurement of FRET between GFP mutants (for review, please see Heim and Tsien 1996; Tsien 1998; Matz et al. 1999; Pollok and Heim 1999) (these variants are available commercially from CLONTECH). An example of a genetically encoded, spectrally compatible, chromophore combination is the enhanced cyan fluorescent pro-

**TABLE 18-10  $R_0$  Values (nm) for GFP and Cy Dyes**

ACCEPTOR $\Rightarrow$	ECFP	EGFP	EYFP	CY3	CY3.5	CY5
$\Downarrow$ DONOR						
ECFP	n.d.	4.7	4.9	n.d.	n.d.	n.d.
EGFP		4.6	5.5	6.0	5.7	n.d.
EYFP			5.1	n.d.	n.d.	n.d.
Cy3				4.4	5.1	5.3
Cy3.5					4.6	6.4

The values were calculated as described by Bastiaens and Jovin (1996), using published extinction coefficients for GFP variants (Tsien 1998) and those supplied by the manufacturer for the Cy dyes (Amersham Pharmacia Biotech). n.d. indicates not determined.



tein (ECFP) as a donor to enhanced yellow fluorescent protein (EYFP). The  $R_0$  value for this pair is 4.9 nm (Table 18-10) which enables FRET detection over distances of  $\sim 1.6 \times R_0 = 7.8$  nm corresponding to a detection limit of 5% FRET efficiency (Figure 18-16). The application for genetically encoded fluorescent FRET pairs is evident: It allows the analysis of protein interactions without the need to conjugate fluorophores to purified proteins and reintroduce them into cells. If, however, the use of sulfoindocyanine dye conjugates is feasible, the large extinction coefficient and spectral overlap makes Cy3 (Amersham Pharmacia Biotech) a suitable acceptor for energy transfer from the donor EGFP (Ng et al. 1999; Wouters and Bastiaens 1999). The  $R_0$  of this pair is 6 nm enabling efficient FRET detection over a distance up to 9.6 nm. Obviously, the higher the  $R_0$ , the greater the distance over which FRET can be detected. However, even under optimal donor/acceptor spectral conditions,  $R_0$  will generally not exceed 7 nm, which confers an upper distance limit of  $\sim 11$  nm for the detection of FRET. In practical terms, these factors may be considered in relation to average protein sizes. Assuming that the specific volume of a protein is  $\sim 0.74$  cm<sup>3</sup>/g, the radius of a 100-kD molecular-mass globular protein can be calculated by substitution of the following equation, where  $R$  is the radius (nm):

$$R = 6.76 \times 10^{-2} \sqrt[3]{MW} \quad (5)$$

resulting in a radius of 3.1 nm. A protein of 200 kD has a calculated radius of 3.95 nm. These calculations of radii demonstrate that FRET is likely to occur between fluorophores on two interacting proteins with molecular masses below 100 kD, whereas the likelihood of FRET between dyes on proteins of molecular masses above 200 kD is low.

## FRET DETECTION METHODS

---

### Steady-state Fluorescence Intensity Measurements

FRET is detectable and quantifiable using a range of techniques, typically by analyzing the donor/acceptor emission ratios of steady-state fluorescence (Adams et al. 1991; Miyawaki et al. 1997). Preferential excitation of a donor fluorophore that is located in molecular proximity to an appropriate acceptor fluorophore will result in sensitized emission from the acceptor and quenching of the donor fluorescence. The change in the ratio of the donor and acceptor emissions can be measured following an event that induces protein association. This measurement has a number of limitations. For instance, because the ratio is not an absolute determination of the FRET efficiency, such measurements must be performed over a time course whereby a change in ratio is detected that can be ascribed to protein association. Since fluorescence intensity is proportional to concentration, the donor/acceptor intensity ratio will depend on local concentrations of labeled proteins. This is particularly problematic when there is differential redistribution of the fluorescent proteins as a result of biological activity during the measurement. Ratiometric concentration effects are not an issue with the use of reporter probes that encode the donor and acceptor GFPs on the same polypeptide, as is the case with molecules such as the calcium sensing "cameleons" (Miyawaki et al. 1997, 1999). These types of probes consist of a donor and acceptor flanking an "activity"-specific module. The stoichiometry of the donor/acceptor is constant for all pixels, and any change in emission ratio, therefore, can be ascribed to changes in FRET efficiency. However, care should be taken to ensure that observed changes in ratio are not due to alterations in pH, which differentially affect the intensity of GFP variants (Llopis et al. 1998). Alternatively, the detection of acceptor-sensitized emission alone can be used as a measure of FRET (Mahajan et al. 1998; Xu et al. 1998). This approach is useful in situations where donor intensities are low and/or there is contamination with high background (auto)fluorescence in the donor channel. However, absorption spectra characteristically exhibit long tails in the shorter

wavelength (blue) region, which may cause the direct excitation of both donor and acceptor molecules, thus resulting in mixing of direct and sensitized emission. Conversely, fluorescence emission tends to tail into the red part of the spectrum, causing donor fluorescence bleedthrough into the acceptor detection channel. Corrections for these effects have been documented (Gordon et al. 1998) and involve the acquisition of fluorescence images of samples containing the donor, the acceptor, and both for three different filter settings. A quantity that is proportional to the FRET efficiency can then be derived.

## Donor Quenching and Acceptor Photobleaching

FRET detection is also possible by examining quenching of the donor emission (Bastiaens and Squire 1999). Should FRET occur, then the intensity of detectable donor emission is reduced in proportion to the efficiency of the energy transfer:

$$E_i = 1 - \left( \frac{I_i}{I_{i0}} \right) \quad (6)$$

where  $I_i$  and  $I_{i0}$  represent the steady-state donor fluorescence intensity in the presence and absence of FRET. The intensity ( $I_i$ ) at each pixel  $i$  is proportional to the donor concentration and requires calibration with the intensity in the absence of acceptor ( $I_{i0}$ ) in order to calculate the FRET efficiency at each pixel using Equation 6. This reference measurement ( $I_{i0}$ ) is made on the same specimen by specifically photobleaching the acceptor by excitation at its absorption maximum (Bastiaens et al. 1996; Bastiaens and Jovin 1998; Wouters et al. 1998). In practice, this approach involves (1) the acquisition of a donor image, (2) photobleaching of the acceptor, and then (3) acquisition of a second donor image. The FRET efficiency map is calculated as one minus the ratio of the donor images before and after photobleaching of the acceptor. By contrast to sensitized emission measurements, photobleaching can be performed with high selectivity of the acceptor since absorption spectra tend to tail in the blue part of the spectrum but are steep at their red edge. Care should be taken with acceptor photobleaching FRET measurements that the photochemical product of the bleached acceptor does not have residual absorption at the donor emission and, more importantly, that it does not fluoresce in the donor spectral region. Because of mass movement of protein during the extended time required for photobleaching (typically 1–20 minutes), this type of FRET determination is preferably performed on fixed cell samples. Live-cell FRET measurements are more feasible using fluorescence lifetime imaging because lifetimes are independent of probe concentration and light path length.

## Fluorescence Lifetime

FRET reduces the fluorescence lifetime of the donor fluorophore ( $\tau$ , a measure of the excited-state duration), since it depopulates its excited state (Clegg 1996). This effect is also manifest as a reduction in the donor *quantum yield* (the ratio of the number of fluorescence photons emitted compared to the number of photons absorbed). Given that  $\tau$  is an intrinsic fluorescence parameter — that it is independent of probe concentration and light path length, but dependent on excited state processes — FRET can be detected purely via donor fluorescence. Since the acceptor fluorescence is not detected, specificity of the acceptor probe is not an issue. Experiments can therefore be carried out using saturating amounts of acceptor molecules or pools of acceptor-labeled protein with nonfunctional subpopulations. By imaging donor fluorescence lifetimes using fluorescence lifetime imaging, it is possible to calculate FRET efficiencies at each pixel of an image:

$$E_i = 1 - \frac{\tau_i}{\langle \tau_R \rangle} \quad (7)$$

The FRET efficiency is calculated at every pixel  $i$  from the lifetime  $\tau_i$  scaled by the average donor reference lifetime  $\langle \tau_R \rangle$  in absence of acceptor. This reference lifetime can be obtained at the end of an experiment by acceptor photobleaching.

## FLUORESCENCE LIFETIME IMAGING MICROSCOPY

### Frequency versus Time-Domain FLIM

Fluorescence lifetime imaging microscopy (FLIM) is well-established as a nondestructive, noninvasive method for the localization and behavior of fluorescent probes or cellular components. By extending such detection methods to fluorescence lifetime determination, it has become possible to resolve biochemical processes and activities. FLIM enables the quantitation of fluorescence lifetimes on a pixel-by-pixel basis (Lakowicz and Berndt 1991; Clegg et al. 1992; Gadella et al. 1993, 1994) and the calculation of a FRET efficiency map from that image (Wouters and Bastiaens 1999). Broadly speaking, determination of fluorescence lifetimes can be performed by two general approaches

- **In the time domain**, a delayed, gated measurement of the fluorescence intensity is made following excitation of the sample with a short pulse of light (Sytsma et al. 1998). The fluorescence intensity is sampled at sequential time points along the exponential fluorescence decay. Where a sample contains a single fluorescence species, the fluorescence lifetime is given as the time over which the fluorescence intensity falls to ~37% of its initial value. In this scenario, repetition of excitation ensures an adequate ratio of signal to noise. In practice, an average lifetime ( $\tau$ ) can be calculated from the ratio of the integrated intensities ( $R$ ) for two equally time-gated segments ( $\Delta t$ ) of the fluorescence decay such that

$$\tau = \frac{\Delta t}{\ln R} \quad (8)$$

- **In the frequency domain** (Lakowicz and Berndt 1991; Gadella et al. 1993; please see the panel on AN EXPERIMENTAL SETUP FOR FREQUENCY DOMAIN FLIM), a sample is excited by a sinusoidally modulated light source. The resultant fluorescence emission is sinusoidally modulated at the same frequency as the excitation source, but is phase-shifted and has a reduced modulation depth. The phase ( $\tau_i^\phi$ ) and modulation ( $\tau_i^M$ ) fluorescence lifetimes can be calculated from this phase shift and demodulation according to:

$$\tau_i^\phi = \frac{\tan(\Delta\phi_i)}{\omega} \quad (9)$$

$$\tau_i^M = \frac{\sqrt{\frac{1}{M_i^2} - 1}}{\omega} \quad (10)$$

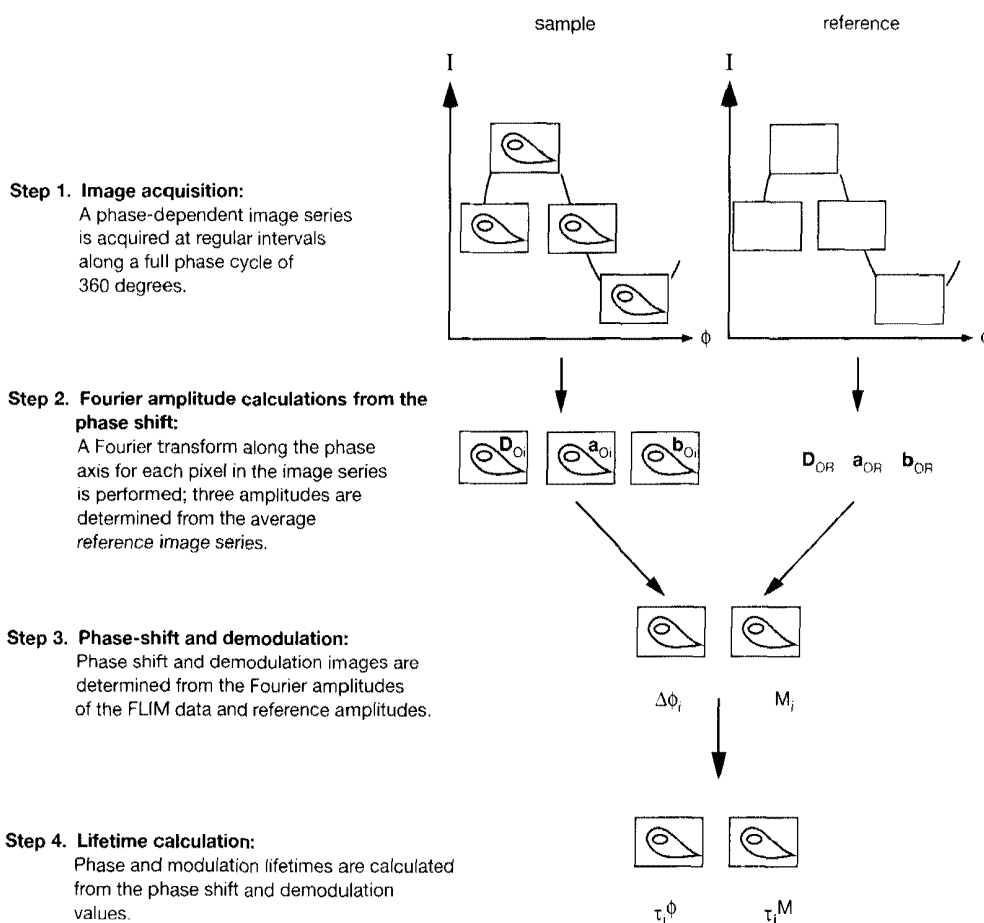
where  $\Delta\phi_i$  and  $M_i$  represent the phase shift and demodulation, respectively, at each pixel  $i$ , and  $\omega$  is the angular modulation frequency.

### Image Processing

FLIM data consist of a sequence of phase-dependent images over a full cycle ( $2\pi$  radians) of a sinus (Figure 18-17, Step 1). From these data, the phase shifts ( $\Delta\phi_i$ ), and modulations ( $M_i$ ) of each sinus at each pixel ( $i$ ) are extracted in order to calculate the fluorescence lifetimes using Equations 9 and 10. Standard Fourier transformations are used to calculate these parameters from the raw data. Formally, the phase-dependent raw FLIM data  $D_i(k)$  can be written as a Fourier series:

$$D_i(k) = D_{0i} + \sum_{n=1}^{N/2} [a_{ni} \cos(kn\Delta\psi) + b_{ni} \sin(kn\Delta\psi)] \quad (11)$$

The signal is sampled by acquiring an image at each sequential step ( $k = 0, 1, 2, 3 \dots N-1$ ) of  $\Delta\psi$  in the phase of the image intensifier modulation. The critical parameters  $D_{0i}$ ,  $a_{ni}$  and  $b_{ni}$  at the harmonic frequency ( $n$ ) are calculated with discrete sine and cosine transformations using standard computer algorithms (such as those described by Press et al. 1990) (Figure 18-17, Step 2):



**FIGURE 18-17 Image Processing Flow Diagram**

See text for details.

**AN EXPERIMENTAL SETUP FOR FREQUENCY DOMAIN FLIM**

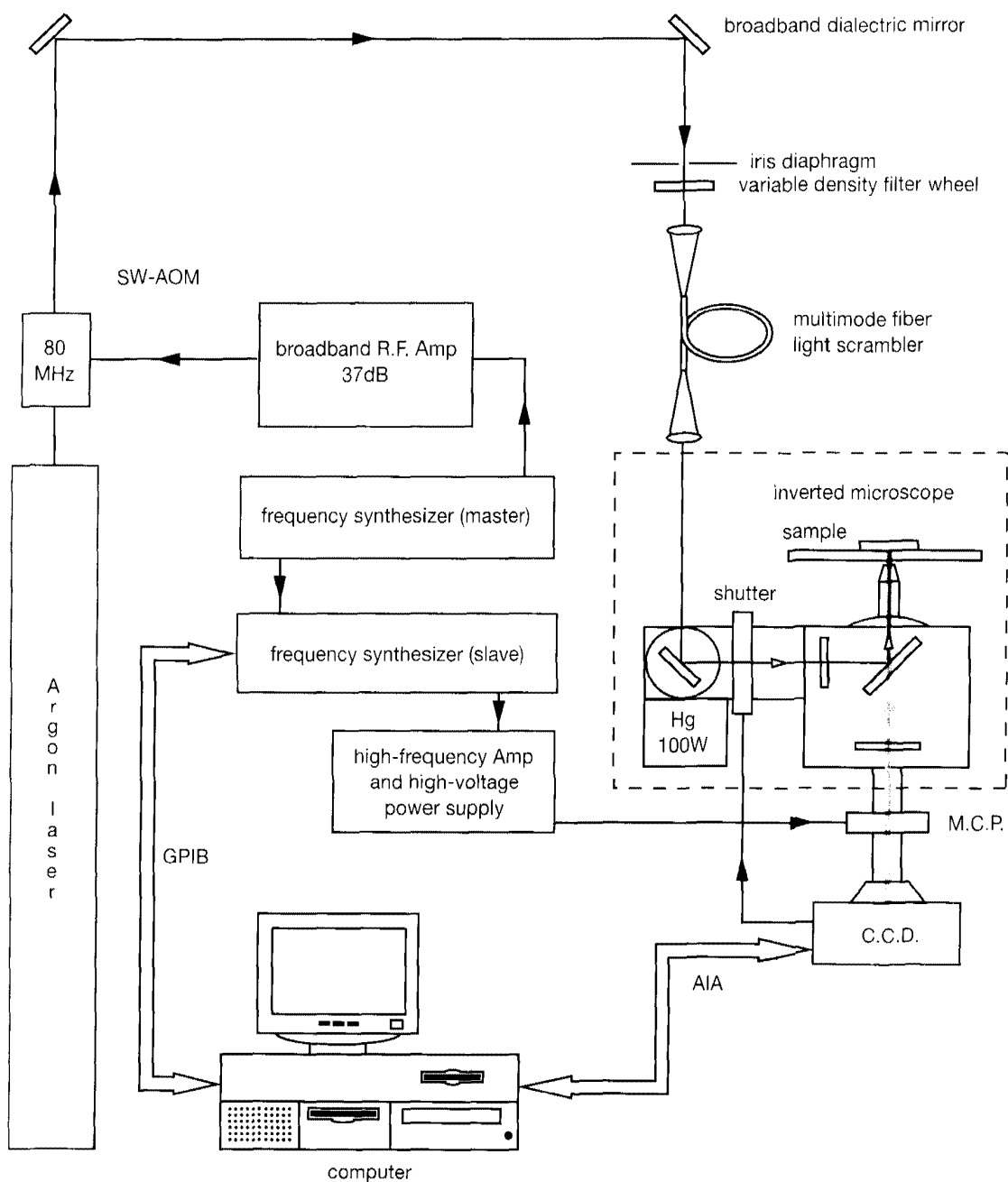
The key elements of a frequency domain fluorescence lifetime imaging system are (1) a standing wave acousto-optic modulator (SW-AOM) that modulates the intensity of the excitation light source at high frequency and (2) a frequency mixing device such as an image intensifier to perform phase-sensitive detection of the fluorescence emission.

Figure 18-18 is a schematic of a single-frequency FLIM configuration. The instrument is based on a vibrationally isolated, inverted microscope (e.g., Zeiss Axiovert 135 TV). The basic light source requirement is an argon laser with sufficient output power ( $>100$  mW per line). The 457.9-nm, 488.0-nm, and 514.5-nm lines are ideal for excitation of the GFP variants, ECFP, EGFP, and EYFP, respectively. The output of this light source is sinusoidally modulated by the SW-AOM (Intra-Action Corp. Belwood). A minimal setup requires a single SW-AOM with a central resonant frequency at 80 MHz (optimal for GFP fluorescence lifetimes  $\sim 2$  nsec). An iris diaphragm placed  $\sim 1.5$  meters from the SW-AOM is used selectively to isolate the central (zero-order) modulated beam from the higher-order diffracted beams. To minimize thermal phase drift, the SW-AOM is coupled to a thermostatic water bath/circulator, and the microscopy room is temperature-stabilized. This keeps the SW-AOM to within  $\pm 0.1^\circ\text{C}$  of a set temperature that is essential for phase coherence between the fluorescent signal and the modulated gain of the detector. The modulated central light beam is then directed into a 1.5-meter step index silica fiber with a 1-mm core and numerical aperture of 0.37 (Technical Video Ltd.) using a 12-cm focal length lens. The coherence of the laser light is disrupted by vibrating the fiber at frequencies of  $\sim 100$  Hz, resulting in a randomly moving speckled illumination of the specimen, which is integrated during detection.

Koehler illumination at the sample plane is achieved by incorporating an achromatic lens (7.6-cm focal length) just before the epi-illumination port of the microscope to collect and collimate the laser light. This focal length is sufficient for the fiber core to appear as a point source, thus giving a collimated beam resulting in flat illumination in the sample plane. A 100-W mercury arc lamp (Zeiss HBO 100 W/2) attached to the second epi-illumination port provides an alternate illumination source. A rotating mirror facilitates rapid switching between the laser and the lamp. The laser illumination is used for donor fluorescence lifetime imaging, whereas the lamp is used for imaging and bleaching the acceptor. A large part of the microscope is enclosed within a perspex thermostatic chamber heated to  $37^\circ\text{C}$  to facilitate live-cell experiments. Enclosing most of the microscope in this chamber eliminates temperature gradients between the microscope components (such as objectives) and the sample.

The provision of a  $\text{CO}_2$  source to the chamber is optional. The TV port situated directly below the sample and objectives is used for coupling the detector, thus providing the shortest route for fluorescence emission with minimal losses. Light from the sample is imaged onto the photocathode of a high-frequency-modulated image intensifier head (Hamamatsu C5825 or LaVision Picostar HR). This device uses proximity focusing of photoelectrons ejected from the photocathode onto the face of a micro-channel plate (MCP). The electron image at the output of the MCP strikes a phosphor screen to generate an intensified light image. For homodyne detection, the effective gain of the image intensifier is modulated at a frequency equal to that of the SW-AOM (80 MHz) by the application of a biased sinusoidal voltage to the photocathode. The amplified, phase-locked outputs from high-frequency synthesizers (2023 Marconi) provide highly stable sinusoidal voltage sources for modulating both the excitation field via the SW-AOM and the gain of the image intensifier unit. Using a telescopic lens with a magnification of 0.5, the amplified image at the phosphor screen of the MCP is projected onto the chip of a scientific-grade CCD camera (Quantix, Photometrics). Magnification of 0.5 matches the full surface area of the CCD chip to that of the phosphor on the MCP. The 12-bit CCD camera houses a Kodak KAF1400 chip with a  $1317 \times 1035$  array of  $6.8\text{-}\mu\text{m}$  square pixels. Typically, two-by-two binning is applied during image acquisition on the CCD in order to accommodate the lower resolution (12 lp/mm) of the MCP. A phase-dependent signal at each pixel of the image is achieved by sequentially phase stepping the gain source and recording a series of images throughout an entire cycle (0–360°).

Fourier analysis is applied to each pixel in the image sequence in order to obtain the phase and modulation images, from which the fluorescence lifetimes are calculated. Typically, 16 phase-dependent images of  $\sim 300 \times 300$  pixels are acquired in a FLIM sequence. With a maximal readout rate of  $5$  Mpixels  $\text{s}^{-1}$ , each phase-dependent image can be read in  $\sim 20$  msec. Photobleaching is minimized by illuminating the sample only during image acquisition. This is achieved with an external high-speed shutter (UNIBLITZ VS25 and D122 shutter and driver, Vincent Associates) located between the filter block and the epi-illumination port of the microscope. Synchronous triggering of the shutter is controlled with a BNC output on the CCD, indicating shutter status. The phase setting of the frequency synthesizer modulating the image intensifier gain is precisely stepped via commands sent over a GPIB interface housed in a PC. The incorporation of extensions into IPLab Spectrum (Scanalytics Inc.) for phase-stepping control and downloading images from the CCD provides the software interface for the collection of FLIM data.



**FIGURE 18-18** Schematic of a Single-frequency FLIM Configuration

See text for details.

$$D_{0i} = \frac{1}{N} \sum_{k=0}^{N-1} D_i(k) \quad (12)$$

$$a_{ii} = \frac{2}{N} \sum_{k=0}^{N-1} D_i(k) \cos(kn\Delta\psi) \quad (13)$$

$$b_{ii} = \frac{2}{N} \sum_{k=0}^{N-1} D_i(k) \sin(kn\Delta\psi) \quad (14)$$

The phase shifts and modulations at each pixel ( $i$ ) are found from these parameters (Figure 18-17, Step 3):

$$\Delta\phi_i = \arctan(b_{ii}/a_{ii}) - \Delta\phi_R \quad (14)$$

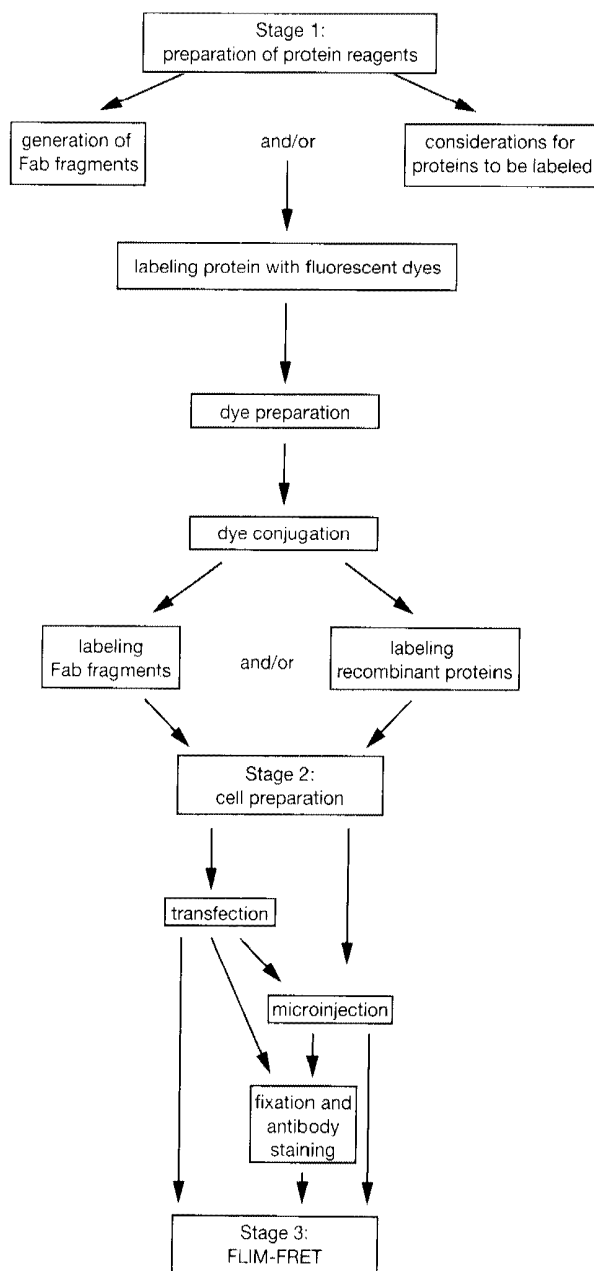
$$M_i = \sqrt{a_{ii}^2 + b_{ii}^2}/D_{0i} M_R \quad (15)$$

where  $\Delta\phi_R$  and  $M_R$  are the calculated phase shift and modulation, respectively, of a reflective reference sample (foil) that has a zero lifetime value. The phase and modulation lifetime images can now be calculated by substitution of the phase shifts and demodulations into Equations 9 and 10, respectively (Figure 18-17, Step 4).

## Imaging Protein Phosphorylation with FLIM-FRET

FRET can be used as a highly specific indicator of protein modifications, such as phosphorylation, through the interaction of a target protein with an antibody recognizing the modified residues. Signal specificity for protein modification is achieved by FRET between chromophores present upon the phosphorylated protein and an antibody. Typically, this type of experiment is generally carried out using a GFP moiety, fused to the phosphoprotein as the donor, and Cy3 conjugated to an antibody as the acceptor. The antibody-Cy3 conjugate is introduced by either microinjection into live cells or by incubation with permeabilized, fixed cells. In this approach, FRET can only be detected by changes in the quantum yield of the donor, typically measured by changes in fluorescence lifetime. FLIM is particularly suited to live-cell FRET measurements, since the acceptor-bearing antibody is present in large molar excess over the donor fusion protein. In addition, the antibody need not necessarily be uniquely specific for the epitope, as is often the case. Semipurified antibody preparations are accommodated that possess only minor quantities of specific IgG molecules. We describe the detection of interactions with (1) one genetically encoded donor component and one microinjected, labeled acceptor component and (2) two labeled donor/acceptor components. These procedures are equally compatible with the detection of interactions between two genetically encoded probes such as ECFP and EYFP, or EGFP and DsRed. Although we present here a specific protocol for measuring the activation state of protein kinase  $C\alpha$  (PKC $\alpha$ ) by following the phosphorylation of Thr-250 (Ng et al. 1999), the approach is generic for measuring covalent protein modification(s) and can also be applied to the detection of protein interactions per se. Examples are described for both a live- and a fixed-cell experiment using EGFP-tagged PKC $\alpha$  and a labeled antibody specific for phosphorylated Thr-250, and also for a fixed-cell experiment using two labeled antibodies (one to PKC $\alpha$  and the other to phospho-Thr-250).

For any FLIM-FRET experiment, the sample and reagent preparation follow a basic order. The various alternatives at each point in the sequence are outlined in a flow chart (please see Figure 18-19). We have divided the protocol into three stages: Stage 1 describes the preparation of proteins and their labeling with fluorescent dyes; Stage 2, the delivery of the appropriate probe components into cells by transfection or microinjection; and Stage 3, the process of image collection and analysis.



**FIGURE 18-19 A Flow Diagram Representing the Possible Protocol Options for Performing the Three Stages of a FLIM-FRET Experiment**

See text for full details.



## STAGE 1: Labeling Proteins with Fluorescent Dyes

The first stage of this protocol describes the preparation of labeled components (usually antibodies or other proteins) that may be introduced into the cells of interest in Stage 2. Fab fragments (if they are required) must be produced before the fluorescence labeling, as described in Steps 1–7. Fab fragments are preferred for FRET experiments in live cells in order to prevent potential cross-linking of antigen by intact antibodies. Although this procedure may be used to prepare Fab fragments from most types of antibodies, the example given here describes conditions for preparing Fab fragments of the polyclonal phospho-Thr-250 antibody (T[p]250). The second sequence of steps (10–16) describes labeling the amino groups of these fragments or other purified proteins with fluorescent sulfoindocyanine (Cy) dyes. If antibodies or proteins are to be labeled directly, omit Steps 1–7 and proceed to Step 8. If the probe components are encoded in a plasmid DNA, proceed directly to Stage 2.

### MATERIALS

**CAUTION:** Please see Appendix 12 for appropriate handling of materials marked with <!.>.

#### Buffers and Solutions

Please see Appendix 1 for components of stock solutions, buffers, and reagents. Dilute stock solutions to the appropriate concentrations.

*Bicine (0.1 M, pH 7.5) adjusted with NaOH*

*Bicine (1 M, pH 9.0–9.5) adjusted with NaOH*

*Digestion buffer*

20 mM Na-phosphate

10 mM EDTA

20 mM cysteine/HCl buffer (pH 7.0)

*N,N-Dimethylformamide (DMF) <!.>*

DMF is dried with the addition of ~1/3 volume of hygroscopic resin to the storage vessel. For example, AG 501-X8 mixed bed resin (from Bio-Rad) can be placed permanently in the stock DMF bottle. If there is any doubt as to the integrity of the DMF, either add further fresh resin or replace with fresh resin. This issue is a consideration should problems be encountered labeling proteins to a desired ratio. The presence of H<sub>2</sub>O in the labeling reaction (potentially from the DMF) will compete for the free dye.

*Na-phosphate (20 mM) with 10 mM EDTA (pH 7.0)*

*Phosphate-buffered saline (PBS)*

*TE (pH 7.0)*

#### Enzymes and Buffers

*Papain immobilized to agarose beads (50% slurry in digestion buffer; Sigma)*

#### Labeled Compounds

*Cy3 and Cy5 OSu monofunctional sulfoindocyanine succinimide esters (Amersham)*

Succinimide esters of sulfoindocyanine (Cy) dyes covalently bind to free amino groups (the  $\alpha$ -amino terminal or  $\epsilon$ -amino groups on lysine side chains). Cy dyes are provided as lyophilized samples that must be maintained in a desiccated environment at all times to prevent reaction with H<sub>2</sub>O. The amount of dye in each vial must be individually quantitated as there can be variations between batches. In the example given here, the succinimide ester of Oregon Green (Molecular Probes) is used to label the MC5 PKC $\alpha$  antibody.

## Antibodies

*Purified antibody such as MC5, monoclonal or T250, polyclonal or protein to be labeled*

The labeling reaction must be performed in a buffer free of amine groups. Many commercial antibody preparations are provided with stabilizing agents that contain free amino groups (such as bovine serum albumin or gelatin) which will compete for the Cy dye. A number of suppliers provide the antibody preparations free of these compounds upon request; in this case, request that they are provided at 1 mg/ml in phosphate-buffered saline.

## Gels

*SDS-polyacrylamide gel <!>*

For preparation of SDS-polyacrylamide gels for resolution of proteins, please see Appendix 8.

## Special Equipment

*Centricon concentrators, YM10, YM30, and YM100 (10-, 30-, and 100-kD molecular-mass cut-off, respectively; Amicon)*

*Gel filtration/size exclusion chromatography columns (prepacked Econo-Pac 10DG disposable; Bio-Rad)*

*Protein A-Sepharose column (Econo-Pac 2-ml column from Bio-Rad)*

Equilibrate the column by washing with 20 bed volumes of 20 mM Na-phosphate. Protein G is recommended for purifying mouse antibodies.

*UV/visible absorption spectrophotometer*

## Additional Reagents

*Step 7 of this protocol requires the reagents for determining protein concentration (e.g., Bradford assay reagents) (Spector et al. 1998, Chapter 56).*

## METHOD

---

### Generation and Purification of Fab Fragments

1. Concentrate the antibodies to 15–20 mg/ml in 20 mM Na-phosphate, 10 mM EDTA (pH 7.0), by centrifugation using a disposable concentrator such as a Centricon YM100.
2. To 250  $\mu$ l of the concentrated antibody preparation (~4–5 mg), add 500  $\mu$ l of digestion buffer and 500  $\mu$ l of a 50% slurry (in digestion buffer) of papain immobilized on agarose beads. Allow the digestion to proceed for 6–10 hours at 37°C with shaking (300–400 rpm in a shaking incubator).

▲ **IMPORTANT** Excessive digestion (i.e., in excess of 16 hours) will result in the cleavage of the Fab fragments into smaller polypeptides. It is therefore advisable to perform a pilot experiment where small aliquots of the digestion (~5  $\mu$ l) are withdrawn at 1-hour intervals for analysis by reducing SDS-polyacrylamide gel electrophoresis. Under reducing conditions, the heavy and light chains of IgG migrate as 50-kD and 25-kD polypeptides. The papain-digested antibody migrates at ~25 kD.

3. Purify the Fab fragments from the Fc portion and nondigested antibodies by passage through a protein A-Sepharose column. Apply the digestion mixture to the equilibrated column and immediately begin collecting 1-ml fractions of the flowthrough.

Protein A will bind the Fc portion of the antibody, thereby removing both the whole antibody and the Fc fragments from the digestion mixture. The resultant flowthrough should contain Fab fragments alone. Beware! A number of subclasses of IgG molecules do not bind to protein A (please see Appendix 9). Use protein G when generating Fab fragments of mouse monoclonal antibodies.

4. To identify which fraction contains the purified Fab fragments, measure the  $OD_{280}$  of each fraction. Collect and pool three or four fractions containing the highest concentration of Fab.  
Typically, the Fab fragments are found in approximately three to four fractions.
5. Concentrate the pooled fractions by centrifugation through a Centricon YM10 (10-kD cut-off; Amicon) to a volume of <0.5 ml.
6. Apply the sample to a low-molecular-mass (6-kD exclusion) gel filtration chromatography column equilibrated in PBS. Elute the Fab fragments with PBS (according to manufacturers instructions).  
To label the Fab fragments, they must be exchanged into a buffer that does not contain free amino groups (i.e., the free cysteine must be removed from the digestion buffer).
7. Following elution, concentrate the Fab fragments through a Centricon concentrator and determine the protein concentration. Add 1/10 volume of 1 M bicine (pH 9.0).  
The IgG concentration determined by Bradford assay, using bovine serum albumin as a standard, must be multiplied by a factor of 2.  
The concentrated preparation of Fabs is now ready to be labeled with fluorescent sulfoindocyanine (Cy) dyes.

## Dye Preparation

8. Resuspend the contents of a single vial of lyophilized dye in 20  $\mu$ l of dry *N,N*-dimethylformamide, to give a Cy solution with a concentration of ~10 mM.
9. Dilute 1  $\mu$ l of the dye mixture 1:10,000 in PBS and calculate the dye concentration from the visible peak absorption.  
The extinction coefficients for Cy3 and Cy5 are 150,000  $\text{mM}^{-1}$  and 250,000  $\text{mM}^{-1}$  at 554 nm and 650 nm, respectively.

## Dye Conjugation

10. To label the proteins, suspend them in a buffer that does not contain free amino groups. If the protein solution is not in an appropriate buffer, perform Steps 6–7.  
If the protein has a special buffer requirement for stability, the gel filtration column can be equilibrated with that particular buffer. Take care that no buffer component has free amino groups or factors that are inhibitory to the labeling reaction. It is worth noting that reducing agents such as dithiothreitol or  $\beta$ -mercaptoethanol interfere with the labeling reaction. However, if a reducing agent must be included to maintain biological/protein function,  $\beta$ -mercaptoethanol has the lower interference and is the reducing agent of choice. Both T(p)250 and MC5 are exchanged into PBS before labeling in 0.1 M bicine (pH 9.0).  
It is advisable to maintain an alkaline pH (while maintaining protein integrity) in the labeling reaction to promote deprotonation of  $\epsilon$ -amino groups of lysines and thereby efficient coupling.
11. React the protein sample (antibody, Fab fragment, or protein) with a 10–40-fold molar excess of Cy3 for 30 minutes at room temperature (prepared as described in Steps 8–9). Add the dye very slowly while stirring the solution with a pipette tip (carefully avoiding direct dye contact with the microfuge tube).  
To avoid protein denaturation by DMF, the volume of Cy3/DMF added must not exceed 10% of the total volume.  
The determination of the optimal molar excess and reaction time is empirical. The goal is to label each protein with 1–3 dye molecules (for a discussion of labeling ratio criteria, please see the introduction to this protocol). The level of labeling will vary greatly with individual proteins or antibodies. If the final labeling ratio is too low, it is possible to re-label the antibody. Monoclonal antibodies such as T(p)250 and MC5 have been labeled successfully with a 40-fold molar excess of dye.

12. Terminate the labeling reaction by the addition of a free-amine-containing buffer such as Tris, to a final concentration of 10 mM.
13. Remove the excess unreacted dye by exchanging the buffer using gel filtration column chromatography (10DG, Bio-Rad), and eluting the protein into PBS.
  - a. Equilibrate the column with three bed volumes of PBS or the buffer of choice (~30 ml).
  - b. To maximize separation, load the labeling reaction mixture directly onto the resin, taking care to apply it in as small a volume as possible.
  - c. Wash the column with 2.5 ml of buffer (~3.3 ml is void) and discard.
  - d. Add a further 2 ml of buffer and collect the visible protein fraction, discarding the remainder. The labeled product will run at the leading front and should be visible. Free dye migrates more slowly through the column.
14. Concentrate the labeled protein once again using a Centricon concentrator (of the appropriate molecular-mass cut-off).
15. Analyze the labeled product by electrophoresis through an SDS-acrylamide gel to verify successful covalent labeling of the protein. Following electrophoresis, examine the gel directly on a UV transilluminator (302 nm) to visualize the labeled product.
 

A fluorescent band should migrate at the expected molecular weight of the protein. There should be no fluorescence from free dye at the migration front.

UV excitation at 302 nm is suboptimal for most dyes. Consider using shorter-wavelength excitation if no bands are visible upon gel illumination.
16. Following the labeling reaction, calculate the labeling ratio using the following formula:

$$A_{\lambda} \times M / [(A_{280} - f \times A_{\lambda}) \times \epsilon_{\lambda}]$$

Where  $A_{\lambda}$  is the absorption of the dye at its absorption maximum at wavelength  $\lambda$ ,  $A_{280}$  is the absorption of the protein at 280 nm,  $M$  is the molecular mass of the protein in kD,  $\epsilon_{\lambda}$  is the molar extinction coefficient of the dye at wavelength  $\lambda$  in  $\text{mM}^{-1}\text{cm}^{-1}$ . The equation also corrects for absorption of the dye at 280 nm. This factor  $f$  is the ratio between absorption of the dye at 280 nm and its maximal visible absorption at wavelength  $\lambda$ . For example, the labeling ratio formula for Cy3-labeled antibody becomes:

$$A_{554} \times 170 / [(A_{280} - 0.05 \times A_{554}) \times 150]$$

To verify that dye coupling has not damaged the biological function of the Fab, whole antibody, or protein, compare the specific activity of the labeled product with its unlabeled counterpart. Specific activity may represent either catalytic activity or a protein-binding activity. These types of protein-binding assays can be performed on agarose-immobilized peptide ligand or phosphotyrosine beads. Standard protocols for testing such binding activities may be found in *Using Antibodies* (Harlow and Lane 1999).

## STAGE 2: Cell Preparation for FLIM-FRET Analysis

In preparation for FLIM-FRET analysis, the appropriate donor and acceptor components must be introduced into the live or fixed cells under study. The selected method of introduction depends on the nature of the components as well as the state of the cells, i.e., whether the component is plasmid DNA encoding the protein of interest fused to a GFP variant or whether it is a protein or antibody labeled as described in Stage 1. For live cells, the introduction of plasmid DNA is accomplished using either transfection or nuclear microinjection, whereas protein or antibody is delivered by microinjection. For studies on fixed cells, plasmid DNA is introduced into cells by transfection or microinjection, and the cells are subsequently fixed in paraformaldehyde before staining with labeled protein or antibody. The following method describes the introduction of plasmid DNA into live cells by transfection. The first alternative protocol at the end of this protocol describes the processing of fixed cells and treatment with antibodies in preparation for FLIM-FRET analysis. A second alternative protocol describes the delivery of either plasmid DNA or protein into cells by microinjection. Each approach is outlined independently and can be applied as appropriate to a specific experimental regime.

### GFP CLONING VECTORS

A wide range of GFP variants are now commercially available from CLONTECH (details can be found on the Web Site: <http://www.clontech.com/techinfo/vectors/catlc.html>) including various spectrally optimized versions (enhanced green, yellow, and cyan fluorescent protein); a red-shifted isolate from the coral species, *Anthozoa*; and forms fused to intracellular compartment targeting sequences (such as the farnesylation sequence of Ha-ras for plasma membrane localization, a nuclear localization sequence, and Golgi complex or endoplasmic reticulum retention sequences). These cloning vectors contain promoter sequences compatible with high-level mammalian expression, and the GFP variants have been modified to contain human codon preferences for further enhancement of expression in mammalian cells. Standard molecular cloning protocols (Chapter 1) may be used to generate amino- or carboxy-terminal fusions of the protein of interest with the various GFP mutants (please see the information panel on **GREEN FLUORESCENT PROTEIN** in Chapter 17).

## MATERIALS

### Buffers and Solutions

**Please see Appendix 1 for components of stock solutions, buffers, and reagents. Dilute stock solutions to the appropriate concentrations.**

#### *Gelatin solution (0.1%)*

Optional, please see Step 1.

Dissolve 0.5 g of gelatin (Porcine, Sigma) in 500 ml of 1x phosphate-buffered saline. Sterilize by autoclaving.

#### *Phosphate-buffered saline (PBS)*

#### *Poly-L-lysine*

Optional, please see Step 1.

Available commercially from Sigma as a 0.1% (w/v) solution in H<sub>2</sub>O; dilute 1:10 in H<sub>2</sub>O before use.

### Nucleic Acids and Oligonucleotides

#### *Plasmid DNA carrying the probe*

GFP fusion vector (CLONTECH) encoding the protein of interest.

## Media

### *CO<sub>2</sub>-independent imaging medium*

This low-background fluorescence medium is commercially available from Life Technologies or adjust the standard formulation of Dulbecco's modified Eagle's medium by omitting each of the following: pH indicator phenol red, penicillin, streptomycin, folic acid, and riboflavin. Just before use, supplement the medium with sterile HEPES (final concentration 50 mM) adjusted with NaOH to pH 7.4.

The imaging medium must not contain components that are autofluorescent.

## Special Equipment

*Tissue culture plates (6- or 12-well) (Nunc) or*

*Glass bottomed tissue culture dishes (35-mm, MatTek Corporation) or*

*Glass chamber slides or coverglass chamber slides (Labtek, Nunc)*

## Additional Reagents

*Step 2 of this protocol requires the reagents for a transfection method as described in Chapter 16.*

## Cells and Tissues

### *Cell line (adherent or suspension culture) to be transfected*

The only consideration for the choice of cell type, other than their suitability for the system to be investigated, is that a facility be available to immobilize them in some manner (see notes to Step 1 for suggestions).

## METHOD

---

1. Seed the cells onto an appropriate surface for microscopy:

*For live cell preparations:* Seed cells onto glass-bottomed dishes or coverglass chamber slides.

*For cell preparations to be fixed after transfection:* Seed the cells onto glass coverslips placed in 6- or 12-well tissue culture dishes.

The final choice of vessel depends on whether the cells are to be microinjected after transfection; if so, consider the shape and clearance space for needle access.

For suspension cells, immobilization can be facilitated with the use of media such as gelatin (0.1% w/v in PBS; autoclaved) or poly-L-lysine (0.01% w/v in H<sub>2</sub>O). In either case, coat the surface by covering either the wells, coverslips, or coverglass slides for ~30 minutes with the chosen medium and then aspirate the excess. Cells can then be directly seeded onto the coated surface. The cells can also be maintained in suspension throughout the transfection procedure and then immobilized immediately before imaging. Once immobilized, microinjection is also possible.

Plate cells at a density such that the cells are ~40% confluent the following day.

2. Transfect the cells with the plasmid(s) encoding the GFP-tagged protein(s) of interest, using any one of the transfection methods described in Chapter 16.
3. Incubate the transfected cells under the appropriate conditions for 16–24 hours to allow the cells to express the protein of interest.

In some cases, the level of protein expression must be controlled accurately. If this is the case, it is advisable to consider optimizing transfection efficiencies as well as the expression period before the FLIM measurement, using a regulated promoter to drive expression of the protein (please see

Chapter 17) or using nuclear microinjection rather than transfection (please see the panel on **ALTERNATIVE PROTOCOL: MICROINJECTION OF LIVE CELLS** at the end of this protocol).

4. Identify cells that are expressing the protein of interest.
5. (*Optional*) If appropriate for the experimental design, introduce another probe (e.g., labeled protein) using one of the alternative protocols following Step 6: microinjection (for live cells) or fixation and staining (for fixed cells).
6. Immediately before performing an experiment at the microscope, replace the culture medium with CO<sub>2</sub>-independent imaging medium (commercial medium or Dulbecco's modified Eagle's medium adjusted as described in the Materials list).

If the experimental design requires serum starvation of the cells before the relevant treatment, starve the cells for the prescribed time frame before imaging. If, however, the cells undergo apoptosis in response to serum deprivation, then maintain the cells in 0.5% fetal calf serum for this period and replace with serum-free medium immediately before imaging.

**ALTERNATIVE PROTOCOL: PREPARATION OF FIXED CELLS FOR FLIM-FRET ANALYSIS**

The reagents used for the preparation of fixed cells for FLIM-FRET experiments have been optimized to minimize the quenching of GFP mutants and fluorescent dyes. This protocol can be applied easily to the preparation of fixed cell samples that do not require treatment with labeled antibodies, for example, samples that have both the donor and acceptor fluorophores expressed as fluorescent fusion proteins. If this is the case, omit the Triton X-100 permeabilization step (Step 5 below) and proceed with the remainder of the protocol for fixing and mounting. Paraformaldehyde is the fixative of choice when performing FRET experiments, as it is a cross-linking agent that preserves the integrity of protein interactions and does not precipitate cellular proteins.

**CAUTION:** Please see Appendix 12 for appropriate handling of materials marked with <!>.

**Additional Materials**

*Cy3-labeled Fab fragments or whole antibody diluted in 1% (w/v) bovine serum albumin in PBS*

Labeled protein is prepared as described in Stage 1.

*Mowiol mounting medium*

Mowiol is the desired mounting medium as it does not quench GFP fluorescence.

- i. Mix 6 ml of glycerol, 2.4 g of Mowiol 4-88 (Calbiochem, 475904), and 6 ml of distilled deionized H<sub>2</sub>O.
- ii. Shake the mixture for 2 hours at room temperature, then add 12 ml of 200 mM Tris-HCl (pH 8.5), and incubate at 50°C with occasional shaking until the Mowiol dissolves (~3 hours).
- iii. Filter the solution through a 0.45- $\mu$ m membrane filter and store in aliquots for weeks at 4°C or for months at -20°C.

*Paraformaldehyde (4%) fixative solution <!>*

- i. Dissolve 4 g of paraformaldehyde (Sigma) in 50 ml of distilled deionized H<sub>2</sub>O, and then add 1 ml of 1 M NaOH solution.
- ii. Stir the mixture gently on a heating block (~65°C) until the paraformaldehyde is dissolved.
- iii. Next add 10 ml of 10x PBS and allow the mixture to cool to room temperature. Adjust the pH to 7.4 using 1 M HCl (~1 ml is needed) and then adjust the final volume to 100 ml with distilled deionized H<sub>2</sub>O.
- iv. Filter the solution through a 0.45- $\mu$ m membrane filter to remove any particulate matter, and store in aliquots at -20°C for several months. Avoid repeated freeze/thawing of the paraformaldehyde solution.

*Permeabilization solution*

0.1% (w/v) Triton X-100 (Sigma) in PBS

*Quenching solution*

50 mM Tris-Cl (pH 8.0)

100 mM NaCl

*Rubber cement or molten 1% (w/v) agarose*

Optional, please see Step 10.

*Stimulus for biological activity to be monitored*

**Method**

1. Seed the cells onto either glass coverslips or glass chamber slides and, if necessary, transfect as described in the preceding protocol.
2. Following transfection and incubation to allow expression of the transfected gene, treat the cells with the desired stimulus for an appropriate period of time.
3. Wash the cells twice in PBS, aspirate the fluid, and add 4% paraformaldehyde to fix the cells. Incubate the cells for 10 minutes at room temperature.
4. Quickly wash the cells with quenching solution to rinse the excess fixative and then wash again for 5 minutes to quench the remaining aldehyde groups.  
If it is not necessary to introduce labeled protein into the cells, proceed to Step 8.
5. Incubate the cells in permeabilization solution for 15–20 minutes.
6. Wash the cells twice with PBS to remove the permeabilization solution.
7. Incubate the coverslips or chamber slides in a labeling solution of Cy3-labeled Fab fragments or whole antibody diluted in 1% bovine serum albumin in PBS for 1 hour at room temperature in a humidified chamber.

To minimize the quantity of antibody or Fab used, place the coverslips cell-side down on 25- $\mu$ l droplets of the antibody solution. This can be performed on a sheet of Parafilm or other clean, nonstick surface. To retrieve the cov-



erslips at the end of the incubation, place a 100- $\mu$ l droplet of PBS at the edge of the coverslip; this will raise the coverslip sufficiently to grasp the edge with jeweler's forceps.

Typical concentration ranges for incubation are between 1 and 100 nM corresponding to 0.15–15  $\mu$ g/ml for a whole antibody. It is advisable to perform a titration to determine the optimal dilution that results in epitope saturation. For example, to detect the activation state of PKC $\alpha$ , incubate MCF10A cells with 10  $\mu$ g/ml Cy3-labeled T250 antibody ( $\alpha$ T250-Cy3) and 10  $\mu$ g/ml Oregon-Green-labeled anti-PKC $\alpha$  (MC5-OG) in PBS containing 1% bovine serum albumin.

8. Wash the coverslips five times in PBS.
9. Blot off excess PBS with a tissue at the edge of the coverslip, taking care not to allow the cells to dry out.
10. Mount the coverslips on 10  $\mu$ l of Mowiol on glass microscope slides, and allow the mounting medium to harden overnight at 4°C. The Mowiol must solidify before imaging or the coverslip must be secured by rubber cement or molten agarose (1% in H<sub>2</sub>O).

Alternatively, if glass chamber slides have been used to prepare the cells, place 10- $\mu$ l drops of Mowiol over each well of cells and then place a long, square coverslip over the entire slide, taking care to minimize air bubbles. The slides are now ready to image; proceed to Stage 3.

▲ **IMPORTANT** Do not use nail polish as this has been shown to quench GFP fluorescence.

#### ALTERNATIVE PROTOCOL: MICROINJECTION OF LIVE CELLS

The introduction of DNA into cells by microinjection is the method of choice when a high level of controlled protein expression is required (for a detailed technical description of microinjection, please see Pepperkok et al. [1998] and Spector et al. [1998, Chapter 83]). When live-cell FRET experiments are to be performed, labeled proteins, such as Fab fragments or recombinant proteins, must also be microinjected. Labeled proteins are injected into the cytoplasm at its highest point near the nucleus. Conversely, DNA is injected directly into the nucleus.

The number of cells to be injected must be determined empirically for each experiment. If single cells are to be imaged in a time course, only a few cells will need to be injected; however, allowances must be made for unsuccessful injections and cell damage or death as a result of injection.

#### Additional Materials

*Cells of interest seeded onto glass-bottomed cell culture vessels*

*GELoader tips (Eppendorf)*

*HEPES (1 M)/NaOH (pH 7.4)*

*High-purity (e.g., HPLC-grade) H<sub>2</sub>O*

*Inverted microscope with 10x and 40x air objectives*

*Microinjector (Eppendorf model 5246)*

*Microinjection needles*

If a needle-pulling device is available, pull needles that have an opening of  $\sim$ 0.25- $\mu$ m diameter. The opening varies with the filament temperature setting and can be determined empirically using a syringe-operated bubble meter by measuring the air pressure required to expel air bubbles from the pipette into a liquid. Alternately, Eppendorf supplies commercially produced microinjection needles (Femtotip).

*Micromanipulator (Eppendorf model 5171)*

*Micropipette bubble meter (Clark Electromedical Instruments)*

*Micropipettes (Eppendorf, Femtotip)*

*Millex-GV4 (0.22  $\mu$ m) syringe filtration units*

*Millipore syringe filter units (0.22  $\mu$ m, Millex-GV4)*

*Sample to be injected (plasmid DNA or labeled protein)*

Successful microinjection depends on the purity of the DNA used and on the removal of aggregates from protein solutions. Therefore, we recommend that DNA be purified by either double cesium chloride–ethidium bromide gradients (Chapter 1, Protocol 10) or Qiagen ion-exchange columns (midiprep or maxiprep) (Chapter 1, Protocol 9) and that both the DNA and protein solutions be filtered of particulate matter as described in Step 2.

(Continued on following page.)

**Method**

1. For plasmid samples, dilute the purified DNA in HPLC-grade H<sub>2</sub>O to a concentration appropriate for the experimental design. For optimal expression overnight, dilute to 1 µg/ml and for expression after a few hours, dilute to 100 µg/ml.
2. To avoid blockage of the microinjection needle, clear the DNA or protein solution of particulate matter.
  - a. Place a 0.22-µm Millipore syringe filter unit within a 0.5-ml microfuge tube, and place this inside a 1.5-ml microfuge tube.
  - b. Filter the DNA or protein solution by centrifugation at maximum speed for 1 minute in a microfuge.

As little as 10 µl may be filtered this way. If filter units are unavailable, clarification may also be performed by centrifugation of the DNA solution at 25,000g for 20 minutes.

We favor the use of 0.22-µm Millipore syringe filter units (Millex-GV4) for their ease of use and low-protein-binding characteristics.
3. Load the glass needle with 2 µl of the DNA or protein solution using GEL loader pipette tips. Avoid air bubbles (which interrupt and prevent microinjection) by placing the end of the pipette as close to the needle opening as possible when loading the solution. Fit the needle directly into the holder of the microinjection device.
4. Adjust the settings for microinjection.

The optimal pressure and injection time settings will vary with cell type and needle diameter; however, a typical range would be 0.3 second and 150–400 hPa injection pressure. A back pressure of ~20 hPa is needed to prevent the medium from entering the needle by capillary action. During optimization of injection conditions, try to achieve injection without disruption of the integrity of the cellular structure (i.e., without excessive pressure). Injection is ideally performed on an inverted microscope using either 40x or 10x air objectives.

A visual indication of excessive pressure during nuclear injection is an apparent separation of the nucleus from the surrounding cellular material visible by a light ring around the nucleus.
5. Carry out injection at room temperature in standard CO<sub>2</sub>-dependent growth medium for intervals of ~10 minutes to avoid acidification of the medium. If prolonged periods of injection are necessary, substitute a CO<sub>2</sub>-independent medium.
6. If protein or antibody was injected, proceed to Step 7. If plasmid DNA was injected, incubate the transfected cells under the appropriate conditions for 16–24 hours to allow the cells to express the protein of interest.

The time frame for expression is determined empirically for the protein under study.
7. Immediately before performing an experiment at the microscope, replace the culture medium with CO<sub>2</sub>-independent imaging medium (commercial medium or Dulbecco's modified Eagle's medium adjusted as described in the Materials list of the main protocol).

## STAGE 3: FLIM-FRET Measurements

Stage 3 presents a basic plan for capturing a fluorescence lifetime imaging microscopy (FLIM) series of images using the microscopy setup described in the introduction to this protocol (please see the panel on **AN EXPERIMENTAL SETUP FOR FREQUENCY DOMAIN FLIM**, p. 18.76). The protocol specifically describes the data acquisition for EGFP or Oregon Green as a donor fluorophore; however, it can be adapted for image acquisition of other chromophore systems by adjusting the excitation wavelength and filter sets (please see Table 18-11). For further details on immunofluorescence microscopy, please see Spector et al. (1998, Chapter 102).

### MATERIALS

---

**CAUTION:** Please see Appendix 12 for appropriate handling of materials marked with <!.>.

#### Special Equipment

*Amplifier (ENI 403LA or Intra-action PA-4)*  
*Argon laser (Coherent, Innova 70C) <!.>*  
*Broad-band dielectric mirrors (2; Newport Corporation)*  
*Detectors*  
 MCP, Hamamatsu C5825 or LaVision Picostat HR  
 CCD, Photometrics Quantix with Kodak KAF 1400 chip  
*Filters*  
 GFP, OG (Q495LP, HQ510/20; Chroma)  
 Cy3 (HQ545/30, Q565LP, HQ610/75; Chroma)  
 half-silvered mirror (Zeiss)  
*Flexure mirror mounts (2), lens holders (2), posts (5), and post holders (5) (Newport)*  
*Inverted microscope (Zeiss 135TV)*  
*IPLab Spectrum (Signal Analytics)*  
*Iris diaphragm (Comar)*  
*Lenses (12 and 7.6 cm focal length, 2.5 and 3.8 cm focal length, respectively; Newport)*  
*Mercury arc lamp (100 W Zeiss; HBO 100 AttoArc)*  
*Multimode fiber step-indexed 1-mm core (Newport)*  
*Oil objective (100×/1.4 NA; Zeiss Fluor)*  
*Optical breadboard (2 × 1 m; TMC)*  
*Power meter and head (Ophir, Nova Display and 2A-SH)*  
*Power PC (Macintosh) equipped with PCI-GPIB card (National Instruments)*  
*Shutter (high-speed, Vincent Associates, Uniblitz VS25)*  
*Shutter driver (Vincent Associates, Uniblitz D122)*  
*Standing wave acousto-optic modulator (AOM) (Intra-action, 80 MHz)*  
*Two-frequency synthesizers (IFR 2023)*  
*Variable density filter wheel (Laser Components)*  
*Water circulating cooler (Grant)*

#### Cells and Tissues

*Cells (live or fixed) expressing the probe proteins, prepared as described in Stage 2*

TABLE 18-11 Filter Specifications for FLIM-FRET Using Selected Donor and Acceptor Pairs

FRET PAIR DONOR AND ACCEPTOR	DONOR FILTER SET			ACCEPTOR FILTER SET		
	EXCITATION	DICHOIC	EMISSION	EXCITATION	DICHOIC	EMISSION
EGFP and EYFP	laser line	455DRLP	480DF30	HQ500/40	Q525LP	HQ555/50
	457.9 nm	(Omega)	(Omega)	(Chroma)	(Chroma)	(Chroma)
EGFP and DsRed	laser line	Q495LP	HQ510/20	HQ545/30	HQ565LP	HQ610/75
	488 nm	(Chroma)	(Chroma)	(Chroma)	(Chroma)	(Chroma)
Cy3 and Cy5	laser line	HQ565LP	HQ610/75	HQ620/60	HQ660LP	HQ700/75
	514.5 nm	(Chroma)	(Chroma)	(Chroma)	(Chroma)	(Chroma)
EGFP and Cy3	laser line	Q495LP	HQ510/20	HQ545/30	HQ565LP	HQ610/75
	488 nm	(Chroma)	(Chroma)	(Chroma)	(Chroma)	(Chroma)

## METHOD

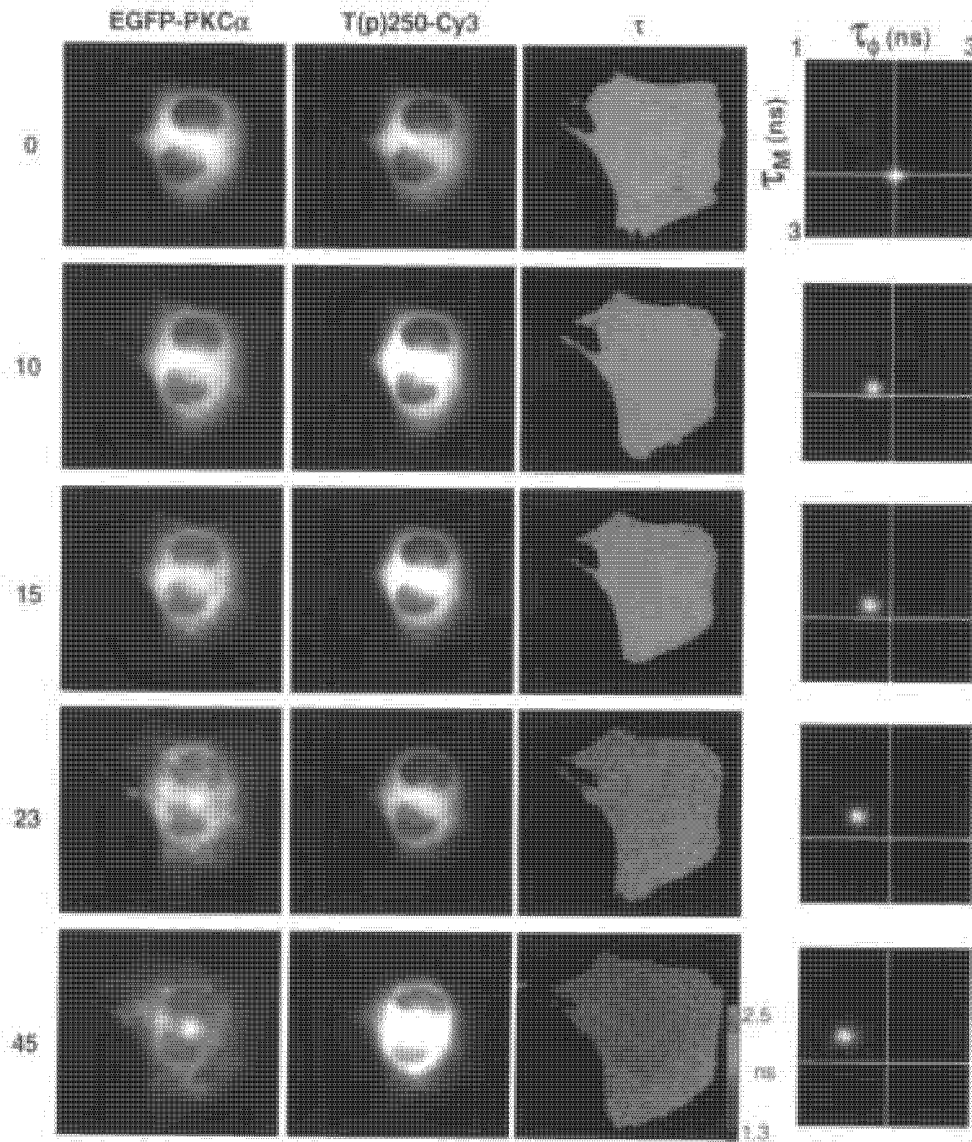
1. Select the 488-nm excitation wavelength on the argon laser by adjusting the wavelength selector prism. Optimize the output power by fine tuning the position of the high-reflector mirror using the control knobs at the back of the laser.
2. Set the frequency synthesizer to drive the AOM to ~40 MHz at a resonance frequency (for the experiments described herein, a driving frequency of 40.112 MHz is used). This gives rise to intensity oscillations in the laser light beam at twice the driving frequency (80.224 MHz).
3. Optimize the diffraction in the AOM and thereby the modulation depth by adjusting the angle of incidence and monitoring the intensity of the undiffracted zero order beam with a power meter. The optimal angle of diffraction (corresponding to maximal diffraction) gives rise to a minimum in the output power of the zero-order beam.
4. Turn on the MCP and the CCD. Set the bias of the photocathode voltage to -2 V and adjust the gain to match the full dynamic range on the CCD. This is dependent on the fluorescence intensity of the sample and must be determined empirically. Ideally, keep the gain as low as possible to reduce noise. Typically, the gain is set at 1 for the Hamamatsu C5825, with the gain of the Photometrics Quantix CCD set at 3. Set the readout of the CCD to 2 × 2 binning.
5. Set the master frequency synthesizer driving the MCP to a value exactly double (for the above example: 80.224 MHz) that driving the AOM.
6. Choose the most suitable objective for the experiment. For this example, a Zeiss Fluor 100x/1.4 NA oil objective is used.
7. To obtain a zero lifetime reference image, record a cycle of 16 phase-dependent images, each separated by 22.5° from a strong scatterer (e.g., a small piece of aluminum foil placed on the imaging surface of a coverslip or glass bottom dish).
  - a. Exchange the fluorescence filter set for a half-silvered mirror and reduce the intensity of the incident beam to a minimum with a variable density filter wheel. Adjust the focus on the foil surface.

▲ **WARNING** When setting up the foil image, take extreme care not to look directly into the microscope ocular until the incident laser source has been reduced to a minimum.

- b. Take a single image of the aluminum foil with an exposure time of ~100 msec. This image is taken to select an ROI and to gauge the likely exposure time required. Because the phase of the master frequency synthesizer may not be at a maximum, and to avoid saturation of the detector, select an exposure time that generates ~1000 counts.
  - c. Record a cycle of 16 phase images, each separated by 22.5°. Determine the phase setting at which maximum intensity is reached in the image series. Reset this phase to zero degrees on the master frequency synthesizer.
  - d. Record another cycle of 16 phase images from the foil to save as a zero lifetime reference.

While performing lifetime imaging, we recommend that phase stability be monitored over time. In our setup, the phase is stable within 0.3° during a period of 1 hour. For our set-up, a reference foil sequence is recorded and saved each hour.
8. Restore the incident excitation source to a maximum (using the variable density filter wheel); the system is now ready for the acquisition of cell imaging data.
  9. Acquire a donor image using the GFP filter set (Dichroic: Q495LP, emission: HQ510/20). Select an exposure time such that 75% of the dynamic range of the CCD (3000 counts for a 12-bit CCD) is filled. Select a region of interest in the image on which to measure fluorescence lifetimes.
  10. Create a donor fluorescence lifetime map:
    - a. Take two contiguous series of 16 phase-dependent images (45° phase-stepped), one forward and one reverse cycle to correct for photobleaching. Optimize the set exposure time for each phase image as in Step 9.
    - b. Take an additional image in the absence of sample illumination. This background offset image is subtracted from all phase images in the series. Each of the pairs of equivalent phase images of the forward and reverse cycles are then summed to first-order to correct for bleaching of the donor.
    - c. From these data and the zero lifetime reference (foil), calculate a donor fluorescence lifetime map as described in the discussion on Image Processing in the protocol introduction.
  11. Record an image of the acceptor, and then photobleach the acceptor by changing to the 100-W mercury arc lamp (Zeiss Attoarc) as a source of illumination. Move the Cy3 filter set (excitation: HQ545/30, dichroic: Q565LP, emission: HQ610/75 chroma) into the detection path. Take an image of the acceptor by optimizing the exposure time to occupy the full dynamic range of the CCD. Close the detector port and illuminate the acceptor until there is no discernible Cy3 fluorescence.

**▲ IMPORTANT** When performing acceptor photobleaching experiments, it is crucial to establish that there is no fluorescence from the photoproduct of the photobleached acceptor in the donor channel.



**FIGURE 18-20 FLIM Experiment on Live Cells Monitoring the Activation Status of PKC $\alpha$  following PMA Treatment**

COS-7 cells transfected with donor EGFP-PKC $\alpha$  were microinjected with acceptor antibodies, T(p)250-Cy3. FLIM data at 101.118 MHz were acquired before (0 minutes) and after (10, 15, 23, 45 minutes) treatment with 100 nM PMA. Average fluorescence lifetime maps were calculated ( $\tau$ ) for each cell and these are depicted as a pseudo-color map corresponding to average lifetimes ranging from 1.3 nsec (dark blue) to 2.5 nsec (red). Phase and modulation lifetimes (before and after treatment) are also plotted as two-dimensional histograms. The change from higher lifetimes (green and red, 0 minutes) to lower lifetimes (blue, 45 minutes) in this cell demonstrates the progressive phosphorylation of Thr-250, and hence an induction of FRET resulting in a reduction in the donor fluorescence lifetimes. We thank Tony Ng and Sandra Schmidt (Protein Phosphorylation and Cell Biophysics Laboratories, Imperial Cancer Research Fund) for the experimental results presented in this figure.

**EXAMPLE: FLIM-FRET EXPERIMENT ON LIVE CELLS**

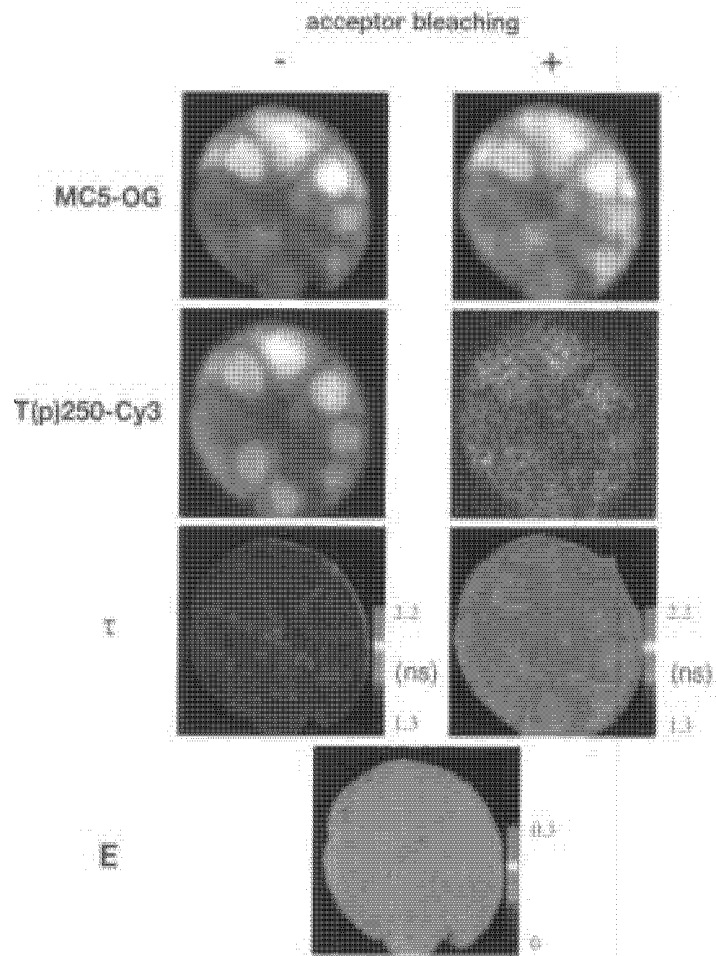
An example of a FLIM-FRET experiment to monitor the activation status of PKC $\alpha$  in live cells via its phosphorylation on Thr-250 is shown in Figure 18-20. The donor in this experiment is EGFP fused to the amino terminus of PKC $\alpha$ , and the acceptor is Cy3 conjugated to Fab fragments against phosphorylated Thr-250 ( $\alpha$ T(p)250-Cy3). This protocol can be adapted to other protein systems in live cells.

1. Prepare the cells by transfection of the GFP-PKC $\alpha$  fusion construct as described in Stage 2.
2. Identify the transfected cells that are expressing GFP-tagged PKC $\alpha$  and microinject selected cells with  $\alpha$ T(p)250-Cy3 (0.5 mg/ml) as described in the panel **ALTERNATIVE PROTOCOL: MICROINJECTION OF LIVE CELLS** in Stage 2.
3. Following microinjection, acquire a phase image series of the foil as a zero lifetime reference.
4. Proceed to acquire fluorescence phase image sequences of the donor (GFP filter set) as described in Stage 3, before and after treatment with the desired stimulus (100 nM PMA for PKC $\alpha$ ). Include at least one uninjected cell in the imaged region of interest as a donor reference lifetime measurement in the absence of acceptor.
5. Calculate fluorescence lifetime maps as described in the discussion on Image Processing in the protocol introduction.

**EXAMPLE: FLIM-FRET EXPERIMENT ON FIXED CELLS**

An example of a fixed-cell FLIM-FRET experiment to monitor the activation status of PKC $\alpha$  via its phosphorylation on Thr-250 is shown in Figure 18-21. In this experiment, the donor and acceptor components are carried on two different antibodies; the donor Oregon Green is conjugated to the PKC $\alpha$ -specific monoclonal antibody (MC5-OG) and the acceptor Cy3 is conjugated to the polyclonal antibody directed against phosphorylated Thr-250 ( $\alpha$ T(p)250-Cy3). This protocol can be adapted for analysis of other protein interaction systems in fixed cells.

1. Prepare the cells as described in the panel in Stage 2 on **ALTERNATIVE PROTOCOL: PREPARATION OF FIXED CELLS FOR FLIM-FRET ANALYSIS**, completing the desired stimulus and time regime. Modify the antibody incubation to incorporate 1:1 (10  $\mu$ g/ml) mix of donor (MC5-OG) and acceptor-labeled ( $\alpha$ T(p)250-Cy3) antibodies.
2. Acquire a phase-image series of the foil as a zero lifetime reference.
3. Use the GFP filter set (dichroic: Q495LP, emission: HQ510/20) to acquire an Oregon Green donor phase-image sequence for a region of interest as described above.
4. Record an image of the acceptor, and then photobleach the acceptor by changing to the 100-W mercury arc lamp (Zeiss AttoArc) as a source of illumination. Move the Cy3 filter set (excitation: HQ545/30, dichroic: Q565LP, emission: HQ610/75 chroma) into the detection path. Take an image of the acceptor by optimizing the exposure time to occupy the full dynamic range of the CCD. Close the detector port and illuminate the acceptor until there is no discernible Cy3 fluorescence.
5. Return to the donor filter set and acquire a second, postbleach donor phase image series. This constitutes the donor reference lifetime image, in the absence of acceptor.
6. Proceed to calculate fluorescence lifetime maps as described in the discussion on Image Processing in the protocol introduction.
7. Calculate FRET efficiency maps by taking the ratio ( $R_f$ ) of the lifetime maps acquired before and after acceptor photobleaching. The FRET efficiency equals  $1 - R_f$ .



**FIGURE 18-21 FLIM Experiment on Fixed Cells Demonstrating the Activation Status of PKC $\alpha$**

MCF 10A cells were fixed and incubated with the donor, Oregon-Green-labeled anti-PKC $\alpha$  antibodies (MC5-OG, 10  $\mu$ g/ml) and the acceptor, Cy3-labeled PKC $\alpha$  phospho-Thr-250 antibodies (T(p)250-Cy3, 10  $\mu$ g/ml). FLIM data at 80.244 MHz were acquired from which average fluorescence lifetime maps ( $\tau$ ) were calculated before (*left panels*) and after (*right panels*) acceptor photobleaching; a calculated FRET efficiency image map (E) is shown. The data presented here represent a cluster of cells, and the nuclei of these cells are visible in the Cy3 and OG images. It is apparent in the lifetime maps ( $\tau$ ) that each cell prior to acceptor photobleaching has lower fluorescence lifetimes than following acceptor photobleaching, thus demonstrating the presence of FRET as a result of phosphorylation of Thr-250. We thank Tony Ng and Sandra Schmidt (Phosphorylation and Cell Biophysics Laboratories, Imperial Cancer Research Fund) for the experimental results presented in this figure.



# Protocol 6

---

## Analysis of Interacting Proteins with Surface Plasmon Resonance Spectroscopy Using BIAcore

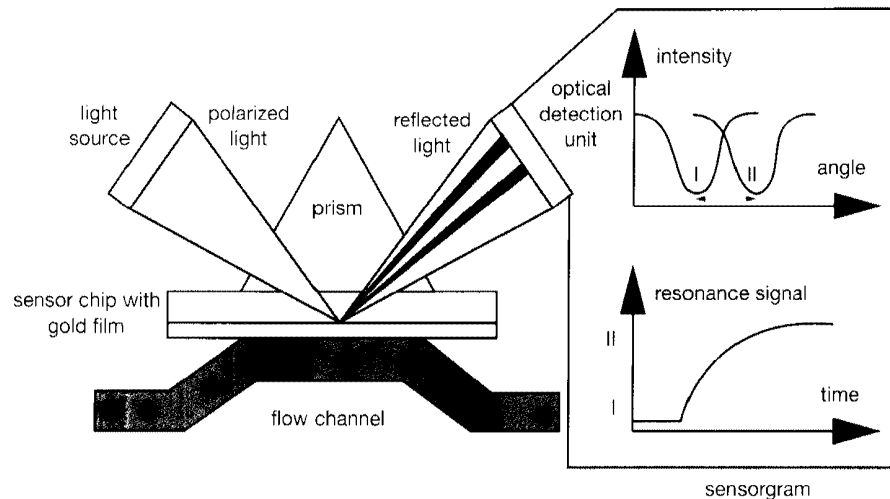
Maxine V. Medaglia and Robert J. Fisher\*

*National Cancer Institute-FCRDC, Frederick, Maryland 21702*

**P**ROTEIN-TO-PROTEIN BINDING INTERACTIONS HAVE BEEN STUDIED using many different methods, both qualitative (gel filtration) and quantitative (calorimetry and ultracentrifugation). The introduction of commercial instruments, such as BIAcore (Jonsson et al. 1991), that are capable of measuring surface plasmon resonance (SPR) has simplified the study of macromolecular interactions by providing a format that may be used to measure molecular interactions in real time with small analytical amounts of material. Several SPR instruments are available, ranging from very simple and inexpensive models to more integrated instruments with attendant robotics, optical interfaces, and software. The simplest device, called a Spreeta chip, was developed by Texas Instruments ([www.ti.com/spreeta](http://www.ti.com/spreeta)). Texas Instruments maintains an informative Web Site with an interesting description of the physical basis of SPR. A somewhat more sophisticated instrument is the IBIS Biosensor, which is offered by XanTec Instruments ([www.xantec.com](http://www.xantec.com)). The IBIS Biosensor uses cuvettes, but it is also compatible with BIAcore sensor chips. Two instruments utilize cuvettes rather than chips. One is a programmable biosensor called Plasmoon, which is manufactured by BioTul ([www.biotul.de](http://www.biotul.de)). The other, Iasys, is an optical biosensor that uses a stirred cuvette ([www.affinity-sensors.com/iasys.htm](http://www.affinity-sensors.com/iasys.htm)).

Three major quantitative approaches are used to study the interaction between macromolecules: analytical ultracentrifugation, isothermal titration calorimetry, and SPR spectroscopy. The strength of SPR spectroscopy is the ability to obtain kinetic data, i.e., the microscopic rate constants for an interaction between macromolecules. Analytical ultracentrifugation provides the best evidence for the aggregation state of a protein, and isothermal titration calorimetry provides a complete thermodynamic profile including the equilibrium constant, reaction stoichiometry, enthalpy, and entropy. Ideally, these methods should be used together to characterize a molecular interaction completely. Calorimetry and analytical ultracentrifugation require milligram amounts of pure protein, and SPR spectroscopy requires microgram amounts of protein.

\*The authors prepared this protocol with the help of M. Fivash, C. Hixson, and L. Wilson (National Cancer Institute-FCRDC, Frederick, Maryland).



**FIGURE 18-22 Schematic of SPR**

BIAtechnology relies on the phenomenon of surface plasmon resonance (SPR), which occurs when surface plasmon waves are excited at a metal/liquid interface. Light is directed at, and reflected from, the side of the surface not in contact with sample, and SPR causes a reduction in the reflected light intensity at a specific combination of angle and wavelength. Biomolecular binding events cause changes in the refractive index at the surface layer, which are detected as changes in the SPR signal. (Redrawn, with permission, from BIAcore, Inc.)

## SURFACE PLASMON RESONANCE SPECTROSCOPY

SPR is an optical resonance effect in which the backside of a thin conductive mirror affects the angle at which there is a minimum of reflected light (Figure 18-22). The SPR response is extremely sensitive to any change in the dielectric constant of the medium adjacent to the gold surface of a sensor chip. Changes in the SPR signal are monitored by recording the angular changes where the reflected light is minimum. A resonance unit (RU) is arbitrarily defined as 1/3000 of a degree in the BIAcore instrument. The BIAtechnology Handbook includes a chapter that discusses the phenomenon of SPR and how the SPR signal relates to the interactions between the analyte (free) and ligand (bound) molecules. Another discussion of SPR can be found in the *Encyclopedia of Life Sciences* ([www.els.net](http://www.els.net)). There are four major components of a BIAcore instrument:

- an optical interface unit to mount the sensor chip
- a microfluidics system (Sjolander and Urbaniczky 1991) to deliver analyte (molecule of interest) precisely to the ligand (molecule attached to the surface of the chip)
- an autosampler to transfer samples from the sample rack to the microfluidics delivery system
- data collection and data analysis software

It is difficult to predict how long it should take to perform a BIAcore experiment and analyze the data obtained. After preparing the appropriate sensor chip and optimizing conditions for the interaction between the ligand and analyte, the regeneration conditions must be determined. Once these preliminary studies are completed, the actual experiment is run, and the data are analyzed using the BIAevaluation software. For some systems, such as epitope mapping, once the optimal conditions have been estimated, the experimental design and analysis of the results are quite straightforward. However, experiments designed to elucidate the kinetics of an interaction

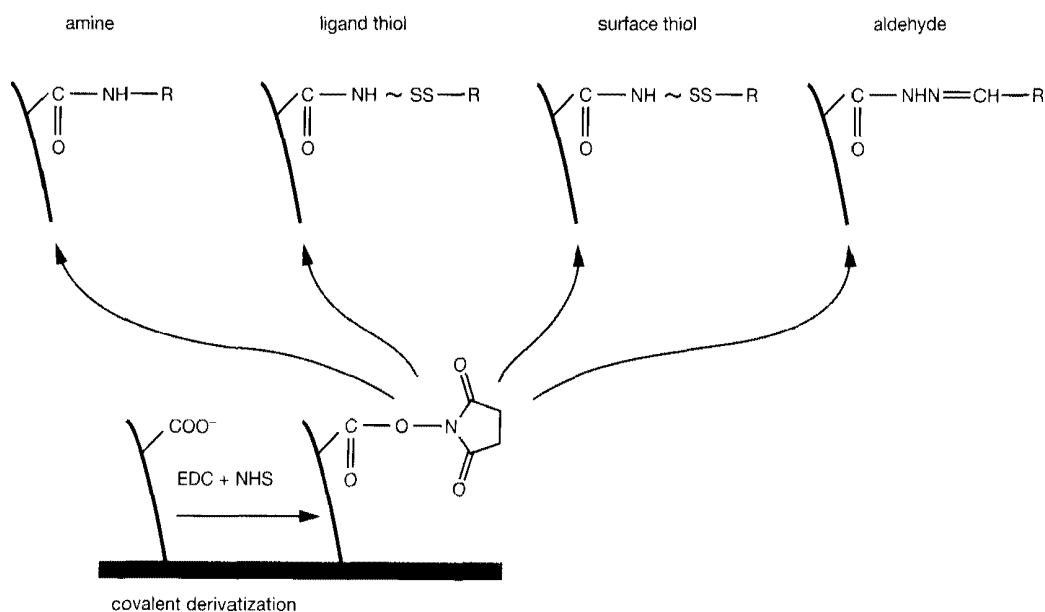
may lead to the development of kinetic pathways that are more complex than the initial model. The BIASimulation software (available on the Web Site) provides a means to predict what the results of the interaction would look like with different kinetic models.

BIAcore analysis has been used for protein–protein, protein–small molecule, protein–nucleic acid, and protein–lipid interactions (Celia et al. 1999; Raut et al. 1999; Saenko et al. 1999). More than 1300 references to these applications as well as others can be found in a reference list kept at [www.biocore.com](http://www.biocore.com). These references illustrate the wide range of experimental designs that have utilized BIAcore SPR technology. In addition, the site can be used to learn more about the technology and applications of SPR and BIAcore instrumentation. The company offers instruction in the use of BIAcore and the BIAevaluation software, and BIAcore application scientists are available to help with questions or problems that may arise.

## THE SENSOR CHIP

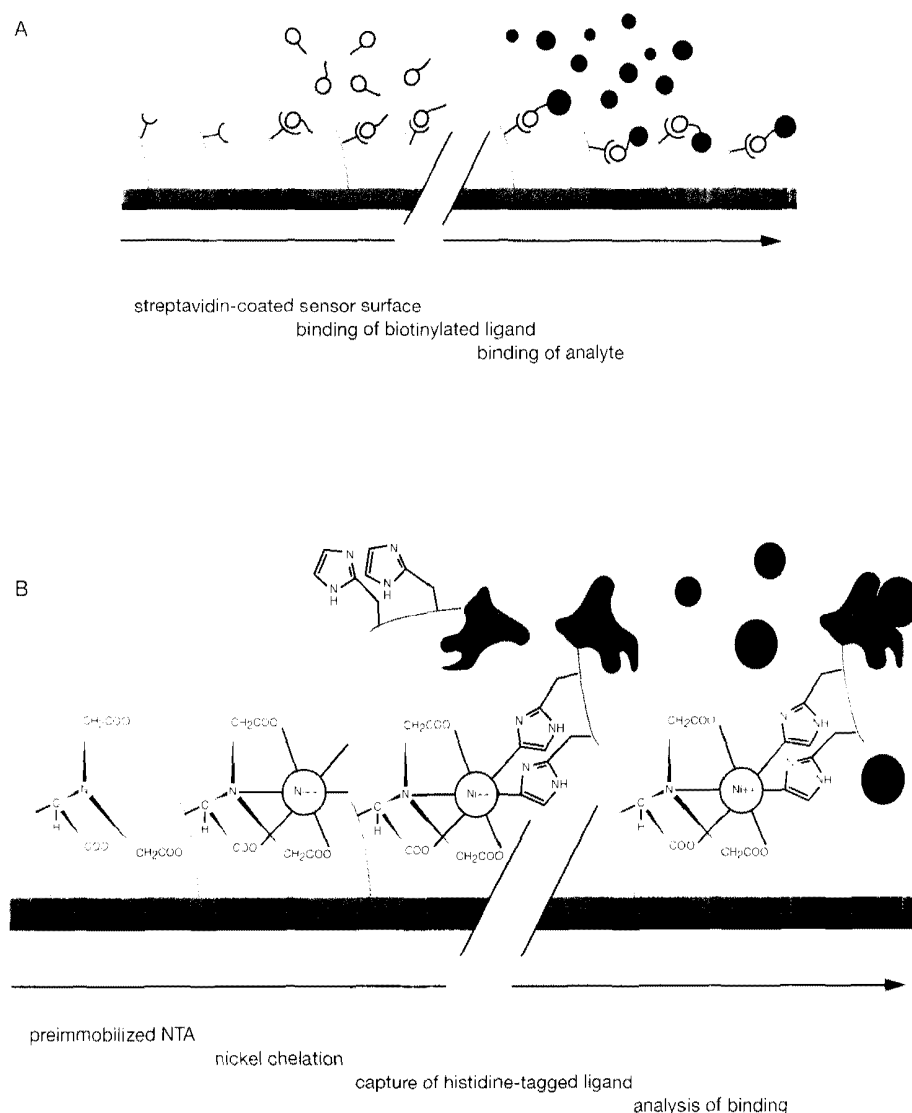
The chip technology introduced by BIAcore consists of a 1-cm<sup>2</sup> glass slide coated with gold and embedded in a plastic support for ease of handling. The standard is the CM-5 sensor chip, but several varieties of chips are available for specialized purposes ([www.biocore.com](http://www.biocore.com)). The CM-5 sensor chip has the equivalent of 2% carboxymethylated dextran covalently attached to the gold surface. A number of protocols have been developed for attaching ligand molecules to the dextran surface (O'Shannessy et al. 1992); these create active groups on the carboxymethyl dextran that are capable of reacting covalently with the ligand molecule. The choice of coupling chemistry to be used depends on the characteristics of the ligand molecule (Figure 18-23). Each chip has four different flow cells so that ligand density may be varied on three of the surfaces and the fourth may be used for a control or blank surface.

It is important to give careful consideration to the method used to immobilize the ligand to the CM-5 sensor chip. Whenever possible, the method of choice should minimize the hetero-



**FIGURE 18-23** Ligand Immobilization via Native -NH<sub>2</sub> -SH<sub>2</sub> -CHO and COOH

(Redrawn, with permission, from BIAcore, Inc.)

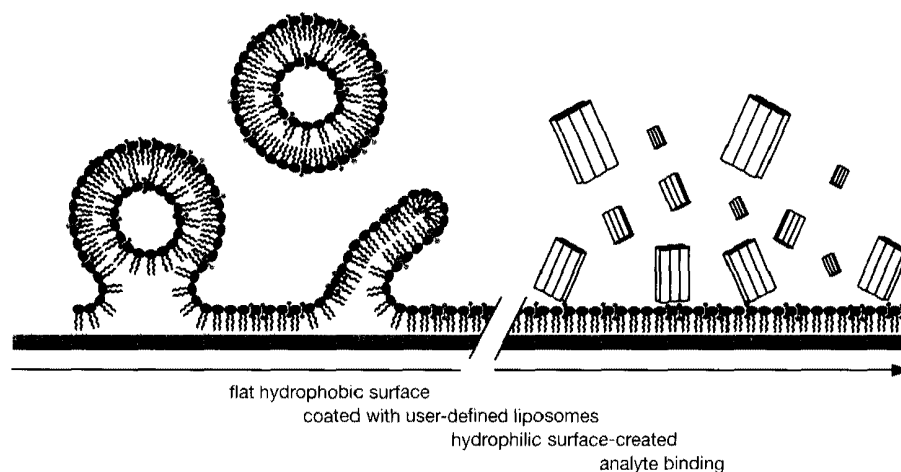


**FIGURE 18-24 Capture of Target Molecules**

(A) Capture of biotinylated macromolecules. (B) Capture of histidine-tagged protein. (Redrawn, with permission, from BIAcore, Inc.)

generality of the bound ligand. Techniques that allow capture of the ligand by another molecule covalently bound to the carboxymethyl dextran are useful because they result in uniform orientation of the ligand and are preferred over direct coupling of the ligand to the chip surface. Examples of such capture surfaces are streptavidin (Morgan and Taylor 1992; O’Shannessy et al. 1992), nickel-chelate (NTA) (Nieba et al. 1997), rabbit anti-mouse C domain (RAMc), and anti-GST. Chips can be purchased with the streptavidin (Figure 18-24A) or NTA (Figure 18-24B) already coupled to the carboxymethyl dextran. Capture molecules such as antibodies and streptavidin can be coupled to the surface through primary amine groups (as described in the protocol below). When a capture molecule is used, surface heterogeneity is not an issue, as it would be if a heterogeneous ligand were directly coupled to the carboxymethyl dextran.

Chips are available that offer additional features. For example, certain chips promote the formation of a lipid bilayer (HPA) (Figure 18-25); others have shorter dextran molecules (Pioneer



**FIGURE 18-25 Membrane Biochemistry and Membrane-bound Receptor Studies**

(Redrawn, with permission, from BIAcore, Inc.)

Chip F1), dextran molecules with a lower charge (Pioneer Chip B1), a carboxymethylated surface with no dextran matrix (Pioneer Chip C1), or a flat gold surface without any attached molecules (Pioneer Chip J1).

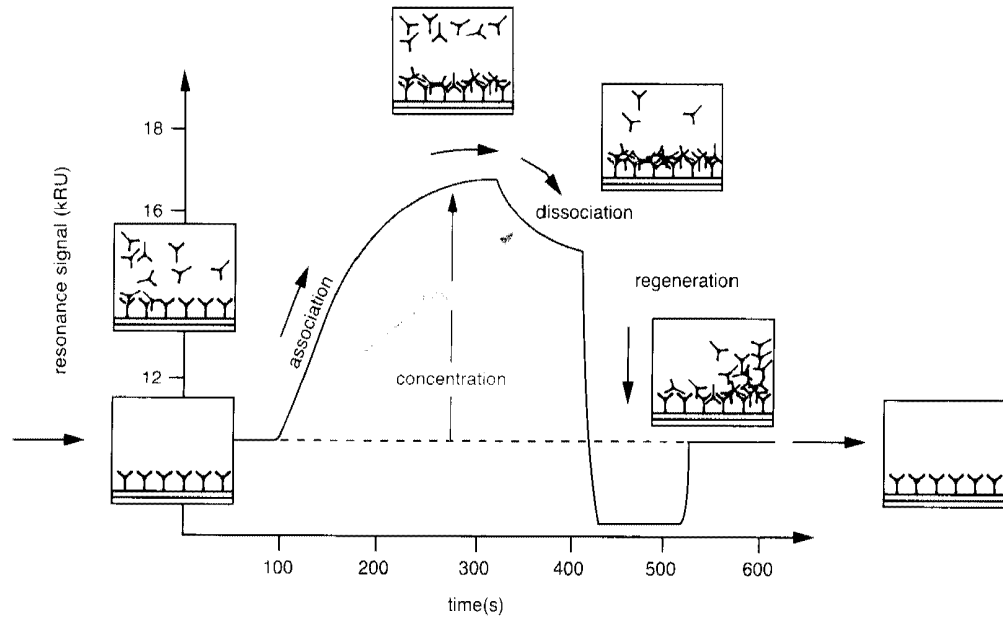
## REGENERATION OF THE CHIP SURFACE

To take full advantage of the CM-5 sensor chip, it is important to develop a robust regeneration system so that the chip surfaces may be reused. A wide variety of materials (acid, base, solvents, salt, detergents, or combinations of these reagents) may be used for regeneration. To determine if the ligand remains bound to the surface, an experiment should be designed to test the robustness of the regeneration by repeated injections of analyte and regeneration solution in order. It should be possible to reuse a surface for up to 100 regeneration cycles.

## COLLECTION OF DATA

The instrumentation uses a flow system and a sensor chip to which a ligand has been attached (immobilized). The analyte solution is injected through the system and moves by diffusion from the buffer flow to the chip surface, where it interacts with the ligand. Figure 18-26 illustrates the progress of an interaction as monitored by a BIAcore sensorgram. The interaction between the ligand and analyte molecules is followed in real time as a change of the SPR angle. Regeneration is accomplished by removal of noncovalently bound material from the surface in as gentle a manner as possible, allowing reuse of the ligand in subsequent binding/regeneration cycles.

The process of diffusion of the analyte is called material transport, and all binding systems are affected to some degree by this phenomenon. Part of the experimental design for BIAcore studies involves finding a low enough surface density of ligand and a high enough flow rate to minimize transport effects. After satisfying the minimal criteria for an experiment, data are collected for subsequent fitting to an appropriate binding model. We strongly recommend that three channels (also referred to as flow cells) of the sensor chip be modified to contain different levels of ligand and that the fourth channel be used as an appropriately modified control surface.



**FIGURE 18-26 Progress of an Interaction Monitored as a Sensorgram**

Analyte binds to the surface-attached ligand during sample injection, resulting in an increase in signal. At the end of the injection, the sample is replaced by a continuous flow of buffer and the decrease in signal now reflects dissociation of interactant from the surface-bound complex. A response of 1000 RU corresponds to a change in surface concentration of 1 ng/mm<sup>2</sup>. (Redrawn, with permission, from BIAcore, Inc.)

Myszka (1999) has suggested that results obtained from a low-density ligand surface should be corrected by double referencing. The signal from the analyte injection over a reference channel is subtracted from the specific binding signal of the analyte injection over the active surface. A further subtraction of a buffer injection from each of the injections of analyte is used to reduce machine effects in the data. Care must be taken when applying any of these techniques, especially when the signal noise is greater than the binding signal itself. If there is nonspecific binding to the reference channel (the control surface), this technique of subtracting the reference channel's signal from that of the active surface must be used cautiously.

The resulting sensorgram or series of sensorgrams may be modeled using one of several binding models provided with the BIAevaluation software or by user-defined models. When analyzing data from the BIAcore, it must be remembered that the sensitivity of the instrument returns a very low noise signal that is profoundly sensitive to machine effects, such as the opening and closing of valves, injection noise, temperature, and pressure, as well as refractive index mismatch between the running buffer and the sample itself. The interpretation of the binding signal can be complicated by the presence of these frequently unavoidable disturbances. Basic training in the use of the BIAcore and specialized training in the BIAevaluation software are excellent resources for learning instrument operation, experimental design, and data evaluation.

## KINETIC MEASUREMENTS

When BIAcore instruments were first introduced, they had few applications and only a rudimentary method for analysis of the data. This situation generated discussions as to whether data should be analyzed using nonlinear methods (O'Shannessy et al. 1993) or linear methods

(Karlsson et al. 1991; Altschuh et al. 1992; Pellequer and Van Regenmortel 1993). The models now used are nonlinear, and they utilize actual data rather than replotted data as do the linear models. The modeling of kinetic data was much improved after Fisher and Fivash (1994) proposed a two-compartment model to describe the delivery of analyte from the flow buffer (compartment 1) to the binding region of the chip (compartment 2). Their work also introduced a new method of analysis to be applied to BIAcore data. In this method, known as global analysis, a series of sensorgrams scaled by different surface ligand densities and different analyte concentrations are solved with a single set of association and dissociation rate constants (Fisher and Fivash 1994; Fisher et al. 1994). The two-compartment model (Myszka et al. 1998b) and global modeling (Roden and Myszka 1996; Karlsson and Falt 1997) have been widely accepted in the field.

The consensus on appropriate modeling of BIAcore data has led to improvements in the BIAcore evaluation software that allow data grooming (baseline adjustment, time zeroing, and subtraction of a blank injection for a set of sensorgrams), and kinetic analysis using a set of models included in the software. This allows calculation of  $k_t$  ( $k$  transport-delivery of analyte to the chip surface), and the microscopic rate constants  $k_a$  ( $k$  association-association rate constant), and  $k_d$  ( $k$  dissociation-dissociation rate constant). The ratio of  $k_a$  to  $k_d$  can be used to estimate  $K_d$ , the equilibrium constant. The possibility of obtaining these microscopic rate constants for a molecular interaction (sometimes referred to as the on and off rates) excites the imagination of researchers. However, the kinetic constants obtained using BIAcore analysis should be regarded as tentative until verified using other methods. The Molecular Interactions Research Group (MIRG) within the Association of Biomolecular Resource Facilities (ABRF) plans to address this issue by sending samples for analysis by SPR spectroscopy, analytical ultracentrifugation, and isothermal titration calorimetry. These results should provide a direct comparison of these different methodological approaches.

Finally, an SPR measurement is derived from an analyte that comes out of solution and binds to a surface matrix, which involves mixed phases (solid phase and solution phase). The relationship of measurements made using mixed phases to those made using single phase has been and will continue to be a source of controversy (Ladbury et al. 1995; Nieba et al. 1996; Muller et al. 1998).

## MEASUREMENT OF CONCENTRATION

---

Under conditions where binding is limited by material (mass) transport, the initial slope of the binding curve should be linearly related to the concentration of analyte (Karlsson et al. 1993; Nieba et al. 1996; Christensen 1997). When the analyte and free ligand molecules are incubated before injection (to allow the system to reach equilibrium), the initial slope shows the amount of free (un-complexed) analyte. This concept is particularly useful because it allows the calculation of an equilibrium constant for a ligand-analyte interaction without any assumptions about a particular binding model. This technique also allows the use of a calibrated system to determine the concentration of an analyte in solution.

The equilibrium association constant may be calculated, without resorting to modeling, in at least three ways. One useful method is finding the concentration of analyte in a competition experiment (see above). The constant found in this way is a solution constant. For a surface constant, one may inject sufficient analyte to show about half of the saturation signal. Then a second injection with the correct analyte concentration will keep the signal steady, and thus demonstrate the equilibrium association constant. An alternative to this method is to actually circulate the analyte in the flow buffer over long periods of time to attain equilibrium (Myszka et al. 1998a; Schuck et al. 1998).

## DESIGNING A PROTOCOL

---

Developing a well-behaved experimental protocol can require some care and include several preliminary experiments to characterize the reagents. We present here the sequence of steps for analyzing a typical antibody-antigen system and illustrate several details involved in the development of a BIAcore experiment. The antibody and antigen are available commercially and could be used to reproduce the results shown below for optimizing the parameters of the system under study.

The protocol is divided into two stages: Stage 1 describes the preparation of a RAMc capture surface, followed by tests for the binding of a specific antibody (anti-TSH) to the RAMc surface, and binding of the antigen (TSH) to the antibody (anti-TSH). Stage 2 presents a series of method blocks or analysis programs that allow the determination of the equilibrium constants for the interaction. In summary,

### **Stage 1:**

1. Prepare RAMc capture surface on CM5 chip.
2. Test binding of the anti-TSH to the RAMc surface.
3. Test binding of TSH to the anti-TSH surface; regenerate and repeat.

### **Stage 2:**

1. Run analysis programs for preparing three levels of anti-TSH and binding concentration series of TSH.
2. Determine equilibrium constants of the interaction.



## STAGE 1: Preparation of the Capture Surface and Test Binding

The following protocol describes a method to capture antithyroid-stimulating hormone (anti-TSH) on a rabbit anti-mouse C domain (RAMc) surface, to prepare the anti-TSH surface for later use in the kinetic analysis of the binding of thyroid-stimulating hormone (TSH) with anti-TSH. The RAMc is immobilized to the carboxymethyl dextran of the sensor chip by primary amine coupling, and, when used as the capture molecule for the antibody, results in the divalent antibody molecules being oriented in a manner that allows binding of two antigen molecules to each antibody molecule. An alternative method of preparing a surface for kinetic analysis would be to couple one of the reactants directly to the sensor chip with the primary amine. If this method were to be used with an antibody, the heterogeneity of the resulting surface would result in less than two antigen molecules binding to each of the antibody molecules.

### MATERIALS

**CAUTION:** Please see Appendix 12 for appropriate handling of materials marked with <!.>.

#### Buffers and Solutions

Please see Appendix 1 for components of stock solutions, buffers, and reagents. Dilute stock solutions to the appropriate concentrations.

*EDC (0.2 M N-ethyl-N'-(dimethylaminopropyl)-carbodiimide in H<sub>2</sub>O) <!.>*

*Ethanolamine (1 M ethanolamine hydrochloride, adjusted to pH 8.5 with NaOH) <!.>*

*Extraclean*

Extraclean is a solution for surface regeneration and is commercially available from BIAcore.

*HEPES-buffered saline buffer*

10 mM HEPES pH (7.4)

150 mM NaCl

3 mM EDTA

0.005% (v/v) Tween-20

This buffer is commercially available from BIAcore.

*HCl (20 mM) <!.>*

*NHS (0.05 M N-hydroxysuccinimide in H<sub>2</sub>O)*

*EDC, Ethanolamine, and NHS are commercially available as part of the Amine-Coupling Kit from BIAcore.*

#### Antibodies

The Molecular Interactions Research Group (MIRG) within the Association of Biomolecular Resource Facilities (ABRF) ([www.abrf.org](http://www.abrf.org)) recommends that protein samples be prepared for BIAcore analysis by buffer exchange dialysis (3 times in 500 volumes) against HEPES-buffered saline, and then centrifuged at maximum speed in a refrigerated microfuge and finally passed through a 0.22- $\mu$ m filter. The resulting protein concentration is determined by absorbance at 280 nm using the calculated extinction coefficient for the particular protein or peptide.

*Mouse anti-TSH monoclonal antibody (1 mg/ml in HEPES-buffered saline)*

This antibody is commercially available from Alexon Trend, Inc.

*Rabbit anti-mouse Fc domain (RAMc) (30  $\mu$ g/ml in 10 mM Na-acetate pH 5.0)*

This antibody is commercially available from BIAcore.

*TSH (20  $\mu$ M in HEPES-buffered saline)*

TSH is commercially available from Alexon Trend, Inc.

## Special Equipment

### *BIAcore instrument*

The instrument includes the BIAcore control software and the BIAevaluation software.

The equipment and software are available from BIAcore, Inc. Information is available at [www.biacore.com](http://www.biacore.com).

### *Sensor Chip CM-5*

## METHOD

---

### Primary Amine Coupling of RAMc to Sensor Chip CM-5 Surface

This procedure takes ~45 minutes. The commands are accessed through the pulldown menus or by the icons of the toolbar of the BIAcore control software.

1. Dock Sensor Chip CM-5 in the BIAcore instrument.
2. Prime using filtered and degassed HEPES-buffered saline.
3. Place tubes containing 100  $\mu$ l each of NHS, EDC, ethanolamine, and RAM Fc and 20 mM HCl in appropriate positions in the autosampler rack in the BIAcore.
4. Place an empty tube in the autosampler rack in the BIAcore.
 

The Immobilization Wizard, if available, can be used to perform this procedure. (The Wizards are standard with BIAcore control software versions 3.0 and higher for the BIA2000 and BIA3000.) If using the Wizard, dispense the volumes specified. The target number of RUs of bound RAM Fc is 13,000.
5. Start the instrument at a flow of 5  $\mu$ l/minute over one flow cell.
6. Transfer 75  $\mu$ l of NHS to the empty tube.
7. Transfer 75  $\mu$ l of EDC to the same tube.
8. Mix the contents of the tube containing the NHS and EDC.
9. Inject 35  $\mu$ l of the NHS/EDC mixture to activate the surface.
10. Inject 35  $\mu$ l of the RAM Fc to couple the antibody to the activated surface.
11. Inject 35  $\mu$ l of ethanolamine to deactivate excess reactive groups.
12. Quickinject 10  $\mu$ l of 20 mM HCl followed by Extraclean to remove noncovalently bound material.
13. Determine the level of RAMc bound by placing a baseline report point before the start of the RAMc injection and a second report point 2 minutes after the end of the 20 mM HCl injection.
 

The final RUs of RAMc immobilized should be between 10,000 and 13,000; if a lower level is obtained, it could be due to a lower concentration of RAMc used, or using NHS and EDC solutions that have been stored for longer than 2 months. A surface with fewer RUs of RAMc is useable, but the volumes of anti-TSH used will need to be adjusted empirically; in general, more will be required to achieve the desired level of binding.
14. Stop the flow, close the command queue window, and save the report file.
 

The BIAcore can be left on Standby (Continue) at this point, or the surface can be used directly in the next section. The RAMc surface is quite stable left in the machine with buffer flowing through the instrument. Alternately, the chip can be undocked and stored at 4°C in a 50-ml conical tube containing a small amount of H<sub>2</sub>O; the surface will be stable for several weeks stored in this way.

### Testing Binding of the Anti-TSH to the RAMc Surface

This procedure takes ~20 minutes. The commands are accessed through the pulldown menus or by the icons of the toolbar of the BIAcore control software.

15. Start the instrument at a flow of 10  $\mu\text{l}/\text{minute}$  over the flow cell with the coupled RAMc.
16. Inject 10  $\mu\text{l}$  of 2  $\mu\text{g}/\text{ml}$  anti-TSH (this requires a total of 40  $\mu\text{l}$  of anti-TSH solution).  
10  $\mu\text{l}$  of the anti-TSH should result in an increase of ~250 RUs. If this level of binding to the RAMc surface is not obtained, regenerate (see Step 17) and repeat the injection of anti-TSH using different volumes until the necessary injection volume is determined.
17. Quickinject 10  $\mu\text{l}$  of 20 mM HCl followed by Extraclean to regenerate the RAMc surface.
18. To test the reproducibility of the binding to the RAMc surface, repeat the injection using the volume of anti-TSH required to give 250 RUs bound to anti-TSH.
19. Quickinject 10  $\mu\text{l}$  of 20 mM HCl followed by Extraclean to regenerate the RAMc surface.
20. Stop the flow, close the command queue window, and save the report file.

### Testing Binding of TSH to the Captured Anti-TSH Surface

This procedure takes ~20 minutes. The commands are accessed through the pulldown menus or by the icons of the toolbar of the BIAcore control software.

21. Start the instrument at a flow of 10  $\mu\text{l}/\text{minute}$  over the flow cell with the coupled RAMc.
22. Inject 10  $\mu\text{l}$  of 2  $\mu\text{g}/\text{ml}$  anti-TSH (or the volume determined to give 250 RUs bound anti-TSH as determined in Steps 15–20).
23. Inject 25  $\mu\text{l}$  of 200 nM TSH, specifying a 120-second dissociation time (this requires a total of 65  $\mu\text{l}$  of TSH solution). The 120-second dissociation time allows the rate at which the antibody-antigen complex dissociates to be gauged.  
After ~20  $\mu\text{l}$  of 200 nM TSH has been injected, the curve should flatten (the slope should approach zero), representing a stochastic steady state of the interaction between the antibody and antigen molecules. If the curve does not flatten, regenerate the surface and repeat Steps 21–23 using 400 nM TSH in Step 23 (Figures 18-26 and 18-27).
24. Quickinject 10  $\mu\text{l}$  of 20 mM HCl followed by Extraclean to regenerate the RAMc surface.
25. Stop the flow, close the command queue window, and save the report file.

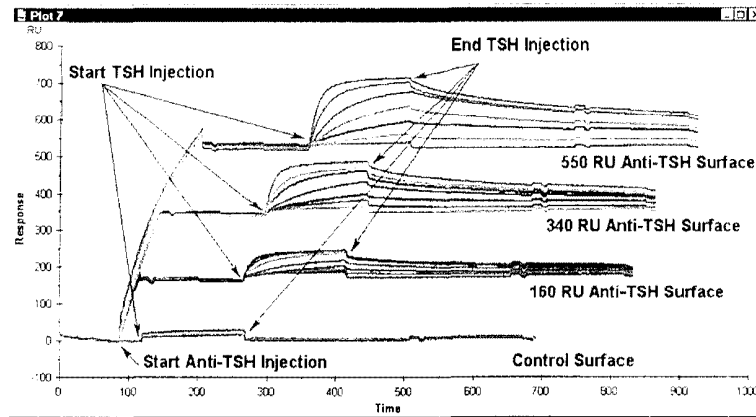
#### DISCUSSION OF THEORY

The binding of the TSH to the anti-TSH is expected to have a 2:1 stoichiometry due to the bivalent nature of the antibody. To determine the efficiency of the binding of the TSH ( $M_r = 50,000$ ) to the anti-TSH ( $M_r = 150,000$ ), calculate the maximum number of resonance units (RUs) of analyte that can bind to the captured antibody.

$$= (\text{MW}_{\text{analyte}})/(\text{MW}_{\text{ligand}}) \times (\text{RUs}_{\text{ligand}}) \times 2$$

$$= 2/3 \times \text{RUs}_{\text{anti-TSH bound}}$$

In the case of 250 RUs of anti-TSH captured by the RAMc surface, 167 RUs of TSH would be expected to bind if all of the antibody were active.



**FIGURE 18-27 Anti-TSH Binding to RAM Fc**

This plot shows the results when the same concentration series of TSH is injected over three levels of anti-TSH captured by a RAM Fc surface as well as over the RAM Fc surface itself. The data have been Y-transformed and the regeneration injection has been removed from each cycle. The high level of reproducibility of the anti-TSH binding to the RAM Fc is apparent, as is the stability of the interaction of these two molecules. The low level of interaction between the TSH and the RAM Fc surface is also illustrated in this diagram.

## STAGE 2: Kinetic Analysis of the Antibody-Antigen Interaction

### Running the Experiment

This experiment is designed to allow capture of a known number of resonance units (RUs) of anti-TSH by the RAMc surface at the start of each cycle, followed by an injection of TSH. The RAMc surface is regenerated at the end of each cycle by the injection of 20 mM HCl. A total of six different concentrations of TSH (prepared by serial dilution) are injected over identically prepared anti-TSH surfaces. The high degree of reproducibility of the binding of the antibody to the capture surface results in essentially the same anti-TSH surface being available for the interaction of the different concentrations of TSH injected in each cycle.

The Interaction Wizard (available with BIAcontrol software version 3.0 and higher for the BIA2000 and BIA3000) can be used to design this type of experiment under the Kinetic Analysis, Concentration Series, Binding Using Capture Molecule choices. If the Wizard is used, however, only one surface density of anti-TSH can be used in the experiment. An advantage of writing a method directly is that different anti-TSH surface densities can be created that are then exposed to the same concentration series of TSH, thus satisfying the data requirements of global analysis. The BIAcore Instrument Handbook gives a thorough discussion of writing methods using the BIAcore Method Definition Language (MDL). The increased flexibility in experimental design realized by writing BIAcore methods directly is worth the time spent becoming familiar with MDL.

### Preparation and Injection of Samples

The following protocol consists of four different analysis programs (aprog), each of which requires that a different volume of mouse anti-TSH monoclonal antibody be injected over the same RAMc surface. The injection of each volume of anti-TSH is followed by the injection of a series of TSH dilutions. If replicate injections of the TSH samples are desired, the appropriate lines of the sample loops should be added. As the method is written, 1000  $\mu$ l of the anti-TSH dilution is required: 400  $\mu$ l for APROG1 (eight 20- $\mu$ l injections, each requiring 50  $\mu$ l), 320  $\mu$ l for APROG2 (eight 10- $\mu$ l injections, each requiring 40  $\mu$ l), and 280  $\mu$ l for APROG3 (eight 5- $\mu$ l injections, each requiring 35  $\mu$ l). If a different volume of the anti-TSH is needed to achieve the target RUs, the aprog will need to be modified and the total volume of antibody required will differ. It is important to remember that each INJECT command requires the specified volume plus an additional 30  $\mu$ l for each injection. There are two buffer injections before the TSH series is injected over each anti-TSH level, to allow the binding level of antibody to stabilize.

## MATERIALS

---

### Buffers and Solutions

Please see Appendix 1 for components of stock solutions, buffers, and reagents. Dilute stock solutions to the appropriate concentrations.

*HEPES-buffered saline buffer or appropriate running buffer*

10 mM HEPES pH (7.4)

150 mM NaCl

3 mM EDTA

0.005% (v/v) Tween-20

This buffer is commercially available from BIAcore.

## Antibodies

### Mouse anti-TSH monoclonal antibody (1 mg/ml in HEPES-buffered saline)

This antibody is commercially available from Alexon Trend, Inc.

Dilute the antibody to 2 µg/ml and prepare 1000 µl (or the volume required) to achieve the target resonance units as determined in Steps 15–20 of Stage 1.

### TSH (20 µM in HEPES-buffered saline)

TSH is commercially available from Alexon Trend, Inc.

Prepare serial dilutions of TSH for injection:

- i. Prepare serial dilutions of 200, 100, 50, 25, 10, and 5 nM TSH, each in 280 µl of the running buffer used for the experiment.
- ii. Dispense 70 µl of each concentration into four plastic 7-mm vials and cap each vial.
- iii. Place the vials in the appropriate position in the BIAcore rack, as directed by the sample loop parameters.

## Special Equipment

### BIAcore instrument

This includes the BIAcore control software and the BIAevaluation software.

The equipment is available from BIAcore Inc. Information is available at [www.biachore.com](http://www.biachore.com).

Sensor Chip CM-5, coupled to RAMc as described in Stage 1

## METHOD

The sequence below consists of three method blocks or sections: the MAIN, the DEFINE APROG, and the DEFINE SAMPLE. Note that there are four DEFINE APROG blocks, one for each of the four APROGs referred to in the MAIN (bind1, bind2, bind3, and bind4). When the BIAcore software edits a method, the method commands will be written in capitals and the user-defined parameters will be in lowercase letters.

The comments following an exclamation point (!) are seen by the instrument as text rather than command code, and are inserted to explain the significance of the preceding command.

1.

```

MAIN
RACK      1 thermo_a

LOOP sample1 STEP
  APROG   bind1 %p1 %conc
ENDLOOP

LOOP sample3 STEP
  APROG   bind3 %p3 %conc
ENDLOOP

LOOP sample2 STEP
  APROG   bind2 %p2 %conc
ENDLOOP

LOOP sample4 STEP
  APROG   bind4 %p4 %conc
ENDLOOP

APPEND   continue

END
    
```

```

!Specifies instrument block to be used.

!anti-TSH; final RUs = 500-600

!anti-TSH; final RUs = 100-200

!anti-TSH; final RUs = 250-350

!Reference surface

!Keeps the running buffer flowing through
!instrument after the the end of the run.
    
```

2.1. **DEFINE APROG bind1**  
 PARAM %p1 %conc  
 KEYWORD CONC %conc  
 FLOW 10  
 \* INJECT r2a1 20  
 -0:05 RPOINT Baseline -b  
 1:55 RPOINT Anti-TSH\_Peak  
 \* KINJECT %p1 25 240  
 -0:05 RPOINT Anti-TSH\_bound -b  
 2:25 RPOINT TSH\_Peak  
 \* QUICKINJECT R2f3 10  
 EXTRACLEAN  
 -0:05 RPOINT TSH\_Washout  
 3:00 RPOINT Regeneration  
**END**

!anti-TSH ; final RUs = 500-600  
 !sets a baseline report point  
 !sets a response report point  
 !TSH  
  
 !20mM HCl to regenerate RAMc surface

2.2. **DEFINE APROG bind2**  
 PARAM %p2 %conc  
 KEYWORD CONC %conc  
 FLOW 10  
 \* INJECT r2b1 10  
 -0:05 RPOINT Baseline -b  
 0:55 RPOINT Anti-TSH\_Peak  
 \* KINJECT %p2 25 240  
 -0:05 RPOINT Anti-TSH\_bound -b  
 2:25 RPOINT TSH\_Peak  
 \* QUICKINJECT R2f3 10  
 EXTRACLEAN  
 -0:05 RPOINT TSH\_Washout  
 3:00 RPOINT Regeneration  
**END**

!anti-TSH ; final RUs = 250-350  
  
 !20mM HCl to regenerate RAMc surface

2.3. **DEFINE APROG bind3**  
 PARAM %p3 %conc  
 KEYWORD CONC %conc  
 FLOW 10  
 \* INJECT r2c1 5  
 -0:05 RPOINT Baseline -b  
 0:25 RPOINT Anti-TSH\_Peak  
 \* KINJECT %p3 25 240  
 -0:05 RPOINT Anti-TSH\_bound -b  
 2:25 RPOINT TSH\_Peak  
 \* QUICKINJECT R2f3 10  
 EXTRACLEAN  
 -0:05 RPOINT TSH\_Washout  
 3:00 RPOINT Regeneration  
**END**

!anti-TSH ; final RUs = 100-200  
  
 !20mM HCl to regenerate RAMc surface

2.4. **DEFINE APROG bind4**  
 PARAM %p4 %conc  
 KEYWORD CONC %conc  
 FLOW 10  
 \* KINJECT %p4 25 240  
 -0:05 RPOINT Baseline -b  
 2:25 RPOINT TSH\_Peak  
 \* QUICKINJECT R2f3 10  
 EXTRACLEAN  
 -0:05 RPOINT TSH\_Washout  
 3:00 RPOINT Regeneration  
**END**

!20mM HCl to regenerate RAMc surface

3.1.

```

DEFINE LOOP sample1
  LPARAM %p1 %conc
    r1a9 0n
    r1a10 0n
    r1a1 200n
    r1a6 5n
    r1a2 100n
    r1a5 10n
    r1a3 50n
    r1a4 25n

  END
    
```

```

!buffer
!buffer
!200nM TSH
    
```

3.2.

```

DEFINE LOOP sample2
  LPARAM %p2 %conc
    r1b9 0n
    r1b10 0n
    r1b1 200n
    r1b6 5n
    r1b2 100n
    r1b5 10n
    r1b3 50n
    r1b4 25n

  END
    
```

```

!buffer
!buffer
    
```

3.3.

```

DEFINE LOOP sample3
  LPARAM %p3 %conc
    r1c9 0n
    r1c10 0n
    r1c1 200n
    r1c6 5n
    r1c2 100n
    r1c5 10n
    r1c3 50n
    r1c4 25n

  END
    
```

```

!buffer
!buffer
    
```

3.4.

```

DEFINE LOOP sample4
  LPARAM %p4 %conc
    r1d9 0n
    r1d10 0n
    r1d1 200n
    r1d6 5n
    r1d2 100n
    r1d5 10n
    r1d3 50n
    r1d4 25n

  END
    
```

```

!buffer
!buffer
    
```



**ANALYSIS OF DATA**

After the run is completed, open the BIAevaluation software and import the cycles from the report file. If the method was run as presented above, the file will consist of 64 cycles. For a preliminary evaluation of the data, bring all the cycles (sensorgrams) into one plot, and Y-transform the curves just before the start of the injection of the anti-TSH. This should show the results of the injections of the different concentrations of TSH over the three different surface densities of anti-TSH and the control surface (Figure 18-27).

To perform a more detailed evaluation, select the cycles corresponding to each of the surface densities of anti-TSH into separate plots; there should be four plots corresponding to the three different levels of anti-TSH captured by the RAMc surface and the control surface. Working with one plot at a time, remove the regeneration injection and any air spikes that may be present. It may also be helpful to remove the region corresponding to the binding of the anti-TSH. The sensorgrams (curves) should then be Y-transformed before the TSH injection start. Finally, the sensorgrams should be X-transformed so that each of the injections starts at the same time. When examining these plots, it is apparent that the level of binding of the TSH to the antibody surface is lower than anticipated from the stoichiometry and ratio of molecular weights of the molecules. For example, for the plot corresponding to the TSH concentration series injected over 340 RUs of captured anti-TSH (Figure 18-28), the maximum response is ~140 RUs, whereas 230 RUs is expected ( $2/3 \times 340 = 227$ ). This difference reflects a lower degree of interaction between the antigen and antibody than 2:1.

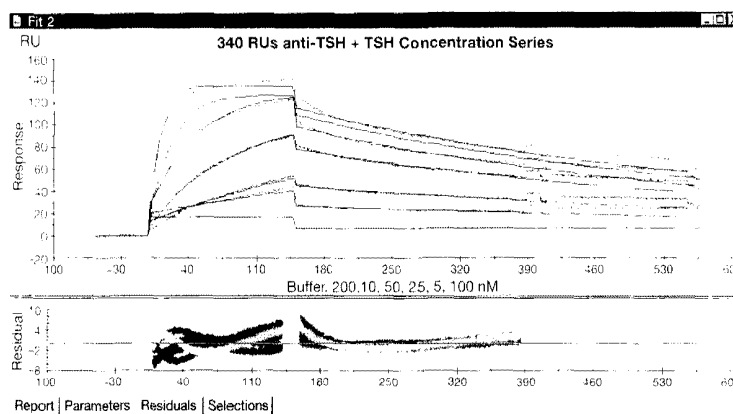
Once these procedures are completed, the data can be reference-corrected by *subtracting* the sensorgram resulting from the injection of each concentration of TSH over the RAMc surface *from* the sensorgram resulting from the injection of the same concentration of TSH over the anti-TSH surfaces. This subtraction is valid because the TSH does not bind to the RAMc control surface. Care must be exercised when using the inline subtraction feature of the BIA2000 and BIA3000, and the response of the individual flow cells must be examined before the subtracted data are analyzed further. For each of the three plots representing the anti-TSH interacting with TSH, a further correction can be made by subtracting the buffer injection sensorgram from those resulting from the TSH concentration series (Figure 18-29). This subtraction will remove any changes that are common in all the curves such as drift or a machine effect.

The resulting plots are now ready to fit to the kinetic model that best describes the reaction kinetics for the determination of the  $k_a$  and  $k_d$ . The BIAevaluation software comes with a number of models and allows the user to make modifications to these or to add others. In the case of TSH in the flow binding to the anti-TSH captured by the RAMc surface, although each antibody is bivalent, the binding of each of the two TSH molecules is independent of the other. Therefore, the appropriate models to use are the 1:1 (Langmuir) binding models ( $A + B \leftrightarrow AB$ ). Other predefined models provided in the BIAevaluation software should be tested to see what differences the various modifications make in the fitting of the data.

The model selected to illustrate the fitting was Langmuir binding with a correction for mass transport and refractive index differences at both the start and end of the injection. This model was used to fit data from both uncorrected (raw) data (Figure 18-28) and double-referenced data (Figure 18-29) using global settings for  $k_a$  and  $k_d$ . The only difference in the analysis of the raw and corrected data was that the value of  $k_i$  for the raw data was kept constant at  $1 \times 10^8$  (the default value); this ensured a reasonable value for this parameter. The actual value for  $k_i$  depends on the molecular mass and the flow rate; for TSH at a flow of 10  $\mu$ l/minute, the value is  $5.4 \times 10^8$ . If  $k_i$  is not kept constant, the value obtained is greater than the maximum possible rate of diffusion. The model fits the corrected data more closely than it does the raw data, as the lines representing the fit data more closely follow the lines from the actual data (Figure 18-28) than the lines of the raw data (Figure 18-29). The residual plot shows the difference between the experimental and fitted data for each curve and is another means of assessing the goodness of the fit. The residual plot for the corrected data (Figure 18-29) shows less deviation than that of the raw data (Figure 18-28), confirming the appropriateness of the double referencing.

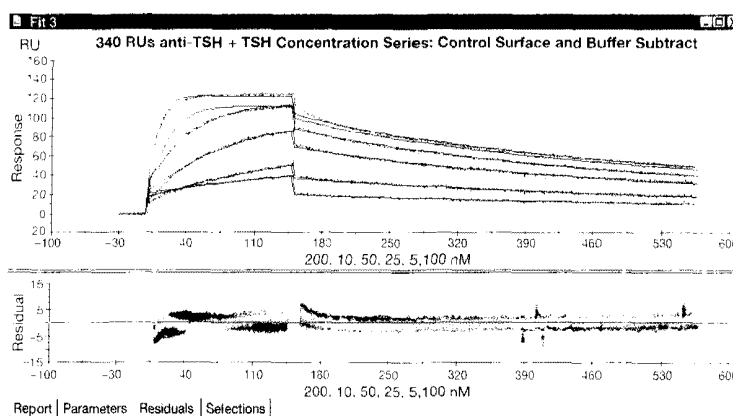
For a test of the global fitting of the data, the curves resulting from the injections of 5, 50, and 100 nM TSH over the three anti-TSH surfaces were combined for analysis. The model fits the combined corrected sensorgrams similarly to the fit seen for the individual corrected surfaces (Figure 18-30).

In Table 18-12, the values obtained for the kinetic rate constants for all three levels of anti-TSH are compared for the data before and after the corrections were performed, as well as those obtained from the combined data. For the 340 RU surface, the values obtained for the constants for both sets of data are within 30% of each other, indicating that the model fits both sets of data similarly. When the values for the combined data are examined, the constants for the raw and corrected data are within 20% of each other. The high degree of consistency between the rate constants for the combined and individual anti-TSH surfaces reflects the appropriateness of the selected model.



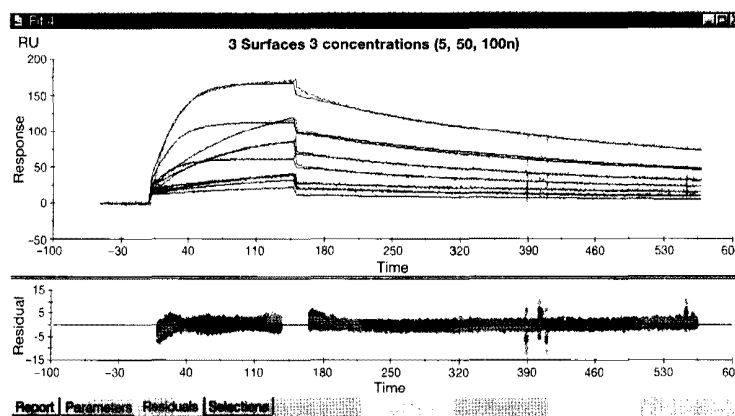
**FIGURE 18-28 Langmuir-binding Model**

This plot shows the results of fitting the sensorgrams resulting from the raw data to a 1:1 (Langmuir) binding model with a correction for mass transport and refractive index differences at both the start and end of the injection. The data in the analysis only included the first 380 seconds because of apparent machine effects resulting in higher RUs for the latter part of the dissociation part of the sensorgrams. Differences between the experimental and fitted data are apparent both in the curves and in the residual plot. Both show systematic deviations in the association and dissociation phases.



**FIGURE 18-29 Corrected Langmuir-binding Model**

This plot shows the results of fitting the double reference subtracted data to the same model as used in Figure 18-28 (1:1 [Langmuir] binding with a correction for mass transport and refractive index differences at both the start and end of the injection). The corrected data show better fitting to the curves and in the residual plot.



**FIGURE 18-30** Global Fitting of the Binding Model

To illustrate an approximation of global fitting, this plot combines the corrected sensorgrams obtained when the same three concentrations of TSH (5, 50, and 100 nM) were injected over the three different surface levels of anti-TSH (160, 340, and 550 RUs). The values for  $R_{\max}$  obtained from the fits of the individual surfaces were used as constant parameters in the fit. The values obtained for the combined data are quite close to those obtained for each individual surface, indicating that the rate constants for interaction between the antigen and antibody are constant for different ligand and analyte concentrations.

**TABLE 18-12** Kinetic Rate Constants for All Three Levels of Anti-TSH

ANTI-TSH								
SURFACE	SOURCE	$R_{\max}$	$K_A \text{ M}^{-1} \text{ S}^{-1}$	$K_D \text{ S}^{-1}$	$K_T \text{ S}^{-1}$	$K_A \text{ M}^{-1}$	$K_D \text{ M}$	$\chi^2$
160 RUs	Raw data <sup>a</sup>	62.8	$4.42\text{e}^5$	$1.81\text{e}^{-3}$	$1.00\text{e}^8$	$2.44\text{e}^8$	$4.10\text{e}^{-9}$	1.18
	Corrected data	43.9	$7.01\text{e}^5$	$3.80\text{e}^{-3}$	$3.37\text{e}^7$	$1.85\text{e}^8$	$5.41\text{e}^{-9}$	1.08
340 RUs	Raw data <sup>a</sup>	111	$5.02\text{e}^5$	$2.25\text{e}^{-3}$	$1.00\text{e}^8$	$2.23\text{e}^8$	$4.48\text{e}^{-9}$	2.71
	Corrected data	89.9	$6.23\text{e}^5$	$3.19\text{e}^{-3}$	$6.51\text{e}^7$	$1.95\text{e}^8$	$5.12\text{e}^{-9}$	1.74
550 RUs	Raw data <sup>a</sup>	166	$4.90\text{e}^5$	$2.58\text{e}^{-3}$	$1.00\text{e}^8$	$1.90\text{e}^8$	$5.26\text{e}^{-9}$	3.35
	Corrected data	142	$5.73\text{e}^5$	$3.06\text{e}^{-3}$	$8.08\text{e}^7$	$1.87\text{e}^8$	$5.34\text{e}^{-9}$	2.28
Combined	Raw data <sup>a</sup>		$5.35\text{e}^5$	$2.34\text{e}^{-3}$	$1.00\text{e}^8$	$2.29\text{e}^8$	$4.37\text{e}^{-9}$	2.06
	Corrected data		$5.72\text{e}^5$	$2.82\text{e}^{-3}$	$8.34\text{e}^7$	$2.03\text{e}^8$	$4.93\text{e}^{-9}$	1.45

Shown here are the values for the kinetic constants and  $\chi^2$  for both the raw and corrected data for all three surface levels of anti-TSH, as well as the combined values representing a global fit. For the raw data fits, the  $k_t$  was held constant at  $1\text{e}^8$ , which provides a good estimate and eliminates numerical difficulties based on the sum-squared algorithm. The high degree of consistency between the rate constants for the combined and individual anti-TSH surfaces reflects the appropriateness of the selected model. Despite the improvement seen in the fit and in the residuals when the data were double-reference subtracted, the kinetic constants are quite close, again indicating that the selected model is appropriate. The  $\chi^2$  values are on the same order of magnitude as instrument noise (typically  $<2$  RU), which is consistent with a good fit.

<sup>a</sup>For fitting the raw data, the material transport value ( $k_t$ ) was held constant at  $1\text{e}^8$ .

## FILAMENTOUS PHAGE DISPLAY

Since the method was first described by George Smith (1985), the display of foreign peptides and proteins on the surface of filamentous bacteriophages has become a cornerstone of techniques to investigate molecular interactions — in particular, those involving surface structures of proteins. Phage display is used:

- **To identify and analyze features on the surfaces of proteins** that interact with other proteins.
- **To isolate new ligands that bind to particular amino acid sequences.** These ligands may be antigenic epitopes, inhibitors, antagonists, agonists, or substrates.
- **To improve the affinity and specificity of the interaction** between ligands and their target structures.

The strength of the phage display system results from the powerful combination of affinity selection and biological amplification. Because filamentous bacteriophages can be exposed to ligand at concentrations in excess of  $10^{13}$  particles/ml, a vast number of foreign peptides can be displayed on the surface of the viral particles and surveyed for their ability to interact with a target ligand. Although bacteriophages that bind to the target may be very rare in the original population, they can be recovered and enriched by repeating rounds of affinity selection and growth.

### Filamentous Bacteriophages

In filamentous phage display, a segment of foreign DNA is inserted into a phagemid or an infectious filamentous bacteriophage genome, between the sequences encoding the leader peptide and the mature sequences of protein gpIII or gpVIII. As discussed in detail in the introduction to Chapter 3, the protein encoded by gene III of bacteriophage fd is only a minor component of the virus particle: Between three and five copies of the protein ( $M_r = 43,000$ ) are present at one end of the filamentous virion (Pratt et al. 1969; Grant et al. 1981; Zaman et al. 1992), where they are involved in absorption of the bacteriophage particle to a receptor located on the tip of F pili (Armstrong et al. 1981; for reviews, please see Model and Russel 1988; Russel 1991). Mature pIII is derived from a 424-residue precursor containing an 18-residue hydrophobic amino-terminal signal sequence that is cleaved posttranslationally by bacterial signal peptidase I. The mature protein folds into a stem and knob structure composed of three domains: The amino-terminal knob (Crissman and Smith 1984) is required for attachment to and penetration of the F pili; the central, linker domain contains several glycine-rich regions, stabilized by disulfide bonds; and the carboxy-terminal domain anchors the mature protein in the envelope of the particle (Hollinger and Riechmann 1997; Lubkowski et al. 1998).

Gene VIII of bacteriophage f1 (pVIII) encodes the major capsid protein of the virus particle. Mature pVIII, which is just 50 amino acids long, is derived from a precursor that carries a 23-residue, amino-terminal leader sequence. After translocation across the bacterial membrane, the leader sequence is removed by bacterial signal peptidase I. Bacteriophage f1 particles contain ~2700 copies of pVIII, which assemble around the single-stranded viral DNA with their basic carboxy-terminal residues in contact with the nucleic acid. The central hydrophobic residues of the pVIII are involved in contacts with neighboring pVIII molecules, whereas their acidic amino termini are exposed to solvent (Marvin 1990). The amino acid residues at the amino terminus of pVIII are not critical for translocation, but they are important for phage assembly.

### Vectors Used for Phage Display

In the **bacteriophage display system**, a segment of foreign DNA is inserted into gene III or gene VIII, a few nucleotides downstream from the cleavage site. *E. coli* transfected with the recombinant viral DNA synthesize and secrete a pure population of infectious “fusion phage” particles that display on their surface the amino acids encoded by the foreign DNA (Smith 1985; Parmley and Smith 1988). Every copy of pIII or pVIII on the surface of an infectious bacteriophage particle carries the sequences encoded by the foreign DNA, which are therefore displayed in a densely packed, “multivalent” fashion.

The **phagemid display system** consists of a plasmid that carries a single copy of gene III or gene VIII and the viral origin of DNA replication. In phagemid display, as in conventional phage display, a segment of foreign DNA is inserted into gene III or gene VIII just downstream from the cleavage site that separates the hydrophobic signal sequence from the mature protein. The recombinant plasmid is then used to transform an appropriate strain of *E. coli*. Bacteriophage particles displaying the amino acid sequences encoded

by the segment of foreign DNA are obtained by superinfecting the transformed cells with helper phages (e.g., VCSM13 or M13KO7; for details, please see Chapter 3 and Appendix 3). Because replication and packaging of the helper is less efficient than that of the phagemid, the population of bacteriophages secreted from the superinfected cells consists overwhelmingly of particles that display the cloned target sequence. However, the form of the display is slightly different from that obtained by cloning into the genomes of conventional infectious bacteriophages. The surface of noninfectious particles generated from phagemids contains two types of pIII or pVIII — one encoded by the phagemid containing the foreign sequences and another, which lacks foreign sequences, encoded by the helper virus. The population of virus particles secreted from superinfected cells are therefore phenotypically mixed and their surfaces are mosaic. At least some of the foreign sequences will therefore be displayed in a “monovalent” fashion, which may have advantages when selecting for ligands that bind to the target sequences with high affinity.

Specialized phagemid display vectors have been developed for particular purposes. The best known of these are phagemid vectors that contain an amber (UAG) chain-terminating mutation immediately downstream from the inserted segment of foreign DNA and upstream of the body of pIII or pVIII. When the recombinant phagemid is used to transform nonsuppressing strains of *E. coli* (e.g., HB2151), the protein encoded by the foreign DNA terminates at the amber codon and is secreted into the culture medium. In the case of phagemids that carry fragments of immunoglobulin genes, the supernatant medium from individual suppressor-minus transformants can be screened for soluble antibody fragments with the capacity to bind antigen (for review, please see Winter et al. 1994). However, when the phagemid is used to transform cells expressing an amber suppressor, the entire fusion protein is synthesized and fragments of antibody are displayed on the surface of secreted bacteriophage particles in the normal way.

## Phage Display of Peptides

By inserting into gene III or VIII populations of synthetic oligonucleotides that differ in sequence but are of equal length, it is possible to generate large libraries of recombinant bacteriophages that display tens of millions of peptides (Cwirla et al. 1990; Devlin et al. 1990; Scott and Smith 1990; Houghten et al. 1991; for reviews, please see Hoess 1993; Schatz 1994; Cortese et al. 1995; Rader and Barbas 1997; Smith and Petrenko 1997; Rodi and Makowski 1999). As discussed above, bacteriophages bearing a specific target peptide for a receptor, an antibody, or another protein can be purified from the library by alternating rounds of affinity enrichment and bacteriophage growth. Since the gene encoding the target peptide is part of the bacteriophage genome, bacteriophage peptide display can be used to isolate a specific DNA sequence by affinity selection of its protein product. Among the wide variety of biological systems that have benefited from bacteriophage peptide display are epitope mapping, analysis of protein-protein interaction, and the isolation of inhibitors, agonists, and antagonists.

### SUBSTRATE PHAGES

Substrate phages, which are used to analyze and improve protease cleavage sites, display random peptide sequences between pIII and a tag. The library of phage particles are first captured on an immobilized ligand that binds to the tag and then incubated with a protease. The small number of bacteriophages carrying a peptide cleaved by the protease are released from the matrix and amplified. After two or three rounds of selection/amplification, the sequences encoding the peptides in individual bacteriophages are determined. By this means, it has been possible to identify new or improved cleavage sites for proteases such as tissue plasminogen activators (Ke et al. 1997; Coombs et al. 1998), collagenase (Deng et al. 2000), and stromelysin (Smith et al. 1995).

## Random Peptides Libraries

Most random peptide libraries have been constructed at or near the amino terminus of the mature gene III protein while larger proteins have been expressed in a flexible hinge between the amino- and carboxy-terminal domains (Smith 1985; Cwirla et al. 1990; Devlin et al. 1990; Scott and Smith 1990; for reviews, please see Gallop et al. 1994; Gordon et al. 1994; Schatz 1994). Because signal cleavage is required to produce infectious bacteriophage particles and because the residues downstream from the cleavage site may influence the efficiency of processing, it is preferable to insert random peptides a few residues downstream from the

mature amino terminus. In the fd bacteriophage gene III display system described by Devlin et al. (1990), synthetic oligonucleotides are cloned into a site two to three amino acid residues downstream from the cleavage site. Peptides encoded by the inserted oligonucleotides are therefore displayed near the amino terminus of mature pIII ( $\text{NH}_2\text{-Ala-Glu-(XXX)}_n\text{-Pro-Ala-Glu}^{\text{COOH}}$ ) in knob-like structures that extend from the surface of the virus particle (Crissman and Smith 1984) and are accessible to antibodies and other large ligands. Although the gene III protein interacts directly with F pili, the presence of short foreign peptides at or near its amino terminus does not automatically bring about a systematic reduction in either bacteriophage yield or infectivity (Parmley and Smith 1988; Cwirla et al. 1990; Devlin et al. 1990; Houghten et al. 1991).

In an ideal world, there should be no selection pressure for or against bacteriophages that express particular peptides on their surfaces. However, sampling of peptide libraries constructed in the pIII protein suggests that cysteine and glutamine are underrepresented, whereas proline is absent from the position immediately carboxy-terminal of the signal sequence cleavage site (Cwirla et al. 1990; Blond-Elguindi et al. 1993; DeGraaf et al. 1993; Kay et al. 1993). Furthermore, bacteriophages that encode recombinant pIII proteins containing a high proportion of positively charged residues grow very poorly — presumably because of a lowered efficiency of the insertion of the pIII preprotein into the bacterial membrane (Peters et al. 1994).

Molecules of pVIII carrying a foreign pentapeptide at the mature amino terminus are able to form a complete bacteriophage capsid (Ilyichev et al. 1992), while at least some of those carrying an octapeptide cannot (Felici et al. 1991). These results suggest that peptides consisting of eight or more residues may deform the pVIII protein to such an extent that it becomes nonfunctional. This problem can be circumvented by forming a mixed capsid composed predominantly of wild-type pVIII (supplied by a helper phagemid) and partly of hybrid pVIII that carries a foreign peptide at its amino terminus (Felici et al. 1991; Greenwood et al. 1991; Kang et al. 1991). The ratio of wild-type:hybrid pVIII in these phenotypically mixed particles varies from 30 to 300, depending on the sequence of the foreign peptide (Felici et al. 1991). An alternative solution is provided by a vector carrying a second copy of gene VIII inserted into a sequence of the intergenic region (Haaparanta and Huse 1995). Because insertion in this region of the vector and subsequent expression of the cloned sequence do not adversely affect replication, the recombinant vector appears to grow normally, producing wild-type plaques.

Bacteriophages displaying foreign peptides at the amino terminus of either pIII or pVIII react with specific polyclonal or monoclonal antibodies directed against the coat proteins. These antibodies can be used to detect recombinant bacteriophages that express a specific ligand and have been captured on appropriate affinity matrices. This assay has been used successfully to study, for example, the interaction of phages displaying IgG-binding domains of staphylococcal protein A with various subclasses of human IgG (Kushwaha et al. 1994; Bhardwaj et al. 1995). In summary:

- Foreign peptides can be expressed at the amino termini of both minor and major coat proteins of filamentous bacteriophages.
- These altered proteins can be incorporated into infectious virions that display the foreign peptide on their surfaces. In both cases, these peptides can be recognized by antibodies, enzymes, and other specific ligands.
- Gene III protein is a minor component of the bacteriophage coat, but its functions in morphogenesis and infection are not compromised by the presence of foreign peptides at its amino terminus. By contrast, peptides of six or more residues inserted into the amino terminus of pVIII can disturb its conformation and thereby prevent assembly of the viral coat (Ilyichev et al. 1989, 1992; Greenwood et al. 1991). Foreign peptides can, however, be displayed on phenotypically mixed particles whose coat consists predominantly of wild-type pVIII and also contains a small proportion of hybrid pVIII molecules.

The features of various vectors derived from filamentous bacteriophage commonly used for peptide display are summarized in Table 18-13 and are described in detail in a review by Smith and Petrenko (1997).

### Construction of Peptide Display Libraries

The steps involved in generating peptide display libraries are simple in principle: Random populations of oligonucleotides of the correct length are synthesized, converted to double-stranded molecules by PCR, digested with a restriction enzyme, and ligated into a compatible restriction site that has been previously engineered at an appropriate location in bacteriophage genes III or VIII. The ligation products are trans-

TABLE 18-13 Classification of Phage-display Vectors

VECTOR TYPE <sup>a</sup>	COAT PROTEIN FOR DISPLAY	NO. OF GENES	DISPLAY ON COPIES	EXAMPLE	REFERENCES
Type 3 (phage)	pIII	1	All	M13KE	Cwirla et al. (1990); Scott and Smith (1990); Kay et al. (1993)
Type 8 (phage)	pVIII	1	All	fl	Ilyichev et al. (1992); Petrenko et al. (1996)
Type 33 (phage)	pIII	2	Some	—	(not commonly used)
Type 88 (phage)	pVIII	2	Some	f88-4	McLafferty et al. (1993); Haaparanta and Huse (1995); Blancafort et al. (1999)
Type 3+3 (phagemid)	pIII	2	Some	pCOMB3H	Barbas et al. (1991)
Type 8+8 (phagemid)	pVIII	2	Some	pCOMB8	Kang et al. (1991); Wrighton et al. (1996)

<sup>a</sup>The classification system is based on that described by Smith (1993). Libraries may be constructed such that the inserted sequence is either carried in Gene III and displayed on pIII (Type 3), or carried in Gene VIII and displayed on pVIII (Type 8); in these cases, the inserted sequence is displayed on all copies of the coat protein. Alternatively, a second coat protein gene may be introduced, resulting in display of the foreign protein on only some of the copies of the coat protein. If both the native coat protein gene and the gene carrying an inserted sequence reside in the phage genome, these libraries (or vectors) are designated type "33" or "88." If the recombinant coat protein gene is carried on a phagemid and the native gene is carried on a helper phage, these systems are termed type "3+3" or "8+8."

(Modified, with permission, from Scott and Barbas 2001.)

ected into *E. coli* and the bacteriophages produced by the culture are collected. Many bacteriophage display vectors, for example, those of the fUSE series (Parmley and Smith 1988; Scott and Smith 1990), carry a tetracycline resistance gene ( $Tc^R$ ) that allows the infected cells to be selected and maintained as colonies on medium containing the antibiotic. The phage genome can then be propagated as if it were a plasmid. This selection minimizes the demand on pIII function that occurs during multiple rounds of infection. Bacteriophage particles can be collected at any time by growing the cells for a few hours in liquid medium.

The pools of synthetic nucleotides inserted into the display vectors consist of mixtures of oligonucleotides whose heterogeneous central portions are flanked at the 5' and 3' ends by sequences recognized by restriction enzymes. Completely random populations of oligonucleotides of defined length and composition can be synthesized by utilizing mixtures of all four nucleoside precursors during synthesis of the degenerate region. This approach will generate a population of oligonucleotides that contains approximately equal ratios of all 64 codons at every position of degeneracy. However, this approach has two disadvantages. First, there is a 3 in 64 chance that any one codon will be a chain terminator. This problem is not serious as long as the random oligomers are small in size. However, more than one third of 24-mers (coding for random octapeptides) and two thirds of 48-mers (coding for random hexadecapeptides) will contain at least one chain-terminating codon. Second, because of the degeneracy in the genetic code, amino acids will be represented in the displayed peptides with different frequencies. For example, leucine, serine, and arginine, with six codons apiece, will appear six times more frequently than tryptophan and methionine. At present, the only practicable method of synthesizing pools of degenerate oligonucleotides is to use mixtures of deoxynucleosides as precursors. Yet by using such mixtures, it becomes impossible to synthesize a set of degenerate oligonucleotides that code for peptides in which all 20 amino acids are displayed in each position with equal frequencies.

Because the number of potential peptides is so large (see Table 18-14), it is important to keep the sequence complexity of the pool of degenerate oligonucleotides to a minimum so that peptide "sequence space" can be searched more efficiently. There are two possible ways to reduce the sequence complexity of the oligonucleotide pool: (1) by accepting a limited set of amino acids at some or all of the positions in the peptide; (2) by employing nucleotide "doping" schemes that restrict the third nucleotide in each codon to G or C (Reidhaar-Olson et al. 1991), or G or T (Scott and Smith 1990). These restrictions produce truncated versions of the genetic code (see Table 18-15) that encode the entire set of amino acids using only half as many codons. Only 1 of the 32 codons in the truncated code is a chain terminator, and the maximum ratio between codon-rich and codon-poor amino acids is reduced from six to three.

**TABLE 18-14 The Number of Oligonucleotides Required to Code for All Possible Peptides of Various Lengths**

LENGTH OF PEPTIDE (AMINO ACID RESIDUES)	NUMBER OF OLIGONUCLEOTIDES IN THE DEGENERATE POOL
4	$20^4 = 1.6 \times 10^5$
5	$20^5 = 3.2 \times 10^6$
6	$20^6 = 6.4 \times 10^7$
7	$20^7 = 1.28 \times 10^9$
8	$20^8 = 2.56 \times 10^{10}$
10	$20^{10} = 1.024 \times 10^{13}$
12	$20^{12} = 2.028 \times 10^{14}$

Algorithms and computer programs have been developed to formulate more complex doping schemes to synthesize degenerate pools of oligonucleotides that encode specific subsets of amino acids and exclude others (Arkin and Youvan 1992). In theory, the overall amino acid composition of the displayed peptides should match the distribution of amino acids in the code predicted by the doping algorithms. This can (and should) be checked by sequencing a statistically significant number of randomly chosen bacteriophages (Cwirla et al. 1990; Blond-Elguindi et al. 1993). Significant deviation from the predicted amino acid composition is a sign either of imperfections in the doping scheme, of selection for or against certain classes of peptides during propagation of the bacteriophages, or of both.

So far, bacteriophage display libraries have been produced using only the simplest doping protocols. Devlin et al. (1990) have described the generation and use of a library of  $2 \times 10^7$  bacteriophages that express random 15-residue peptides; Scott and Smith (1990) have generated a library displaying approximately  $4 \times 10^7$  different hexapeptide epitopes; and Cwirla et al. (1990) have described a library of  $3 \times 10^8$  recombinants that also expresses hexapeptides. The peptides displayed in these last two display libraries probably cover most of the hexapeptide sequence space. Clones selected from them by affinity panning have already been used to define and explore specific antigenic epitopes and other ligands. However, the potential of the bacteriophage display system cannot be fully exploited until larger libraries have been constructed that explore the sequence space of longer peptides. Complete heptapeptide display libraries can be constructed and screened with present-day technology. For example, New England Biolabs offers a library kit consisting of randomized heptapeptides; the libraries contain  $\sim 3 \times 10^9$  independent clones, a sufficient number to encode most, if not all, of the  $20^7$  possible 7-mer sequences ( $1.28 \times 10^9$ ). Methods to construct bacteriophage display libraries and to assess their completeness are discussed in Christian et al. (1992) and reviewed by Smith and Petrenko (1997) and Rodi and Makowski (1999).

**TABLE 18-15 A Restricted Genetic Code with Only G or C in the Third Position of Each Codon**

	T		C		A		G	
T	TTC	Phe	TCC	Ser	TAC	Tyr	TGC	Cys
	TTG	Leu	TCG	Ser	TAG	Stop	TGG	Trp
C	CTC	Leu	CCC	Pro	CAC	His	CGC	Arg
	CTG	Leu	CCG	Pro	CAG	Gln	CGG	Arg
A	ATC	Ile	ACC	Thr	AAC	Asn	AGC	Ser
	ATG	Met	ACG	Thr	AAG	Lys	AGG	Arg
G	GTC	Val	GCC	Ala	GAC	Asp	GGC	Gly
	GTG	Val	GCG	Ala	GAG	Glu	GGG	Gly

An identical genetic code is obtained if codons are restricted to NN $\setminus$ (G,T) instead of NN $\setminus$ (G,C).



TABLE 18-16 Commercial Phage Display Systems

RESOURCE/COMPANY	PHAGE DISPLAY SYSTEM/KIT	VECTOR/SYSTEM COMPONENTS	COMMENTS
<b>Amersham-Pharmacia Biotech</b> www.apbiotech.com	Recombinant Phage Antibody System	pCANTAB 5 phagemid.	The system includes a series of modules provided for cloning, screening, and expression of single-chain fragment variable (ScFv) antibodies.
<b>Display Systems Biotech</b> www.displaysystems.com	displayPHAGE System	pSKAN (pIII phage coat fusion proteins).	Display Systems provides three <i>E. coli</i> libraries (6-, 7-, 8-mers), three to four rounds of bio-panning, and positive clone identification by ELISA and DNA sequencing.
<b>Invitrogen</b> www.invitrogen.com	FliTrx Random Peptide Display Library	pFliTrx vector (flagella [Fli]-thioredoxin [Trx] fusion proteins are exported and assembled in partially functional flagella).	The bait or protein of interest is screened in successive rounds against peptide clones; positive clones are rescreened and sequenced.
	pDisplay Expression Vector	pDisplay (mammalian expression vector) contains the SV40 origin of replication, T7 promoter/priming sites, and the neomycin resistance marker for stable selection in mammalian cells.	The vector is designed to target recombinant proteins to the surface of mammalian cells. Recombinant proteins encoded by the vector carry an amino-terminal cell surface targeting signal and the carboxy-terminal transmembrane anchoring domain of PDGF.
	pYD1 Yeast Display Vector Kit	pYD1 (yeast expression vector) carries the GAL1 promoter, T7 promoter/priming sites.	The vector is designed to target recombinant proteins to the surface of <i>S. cerevisiae</i> via the $\alpha$ -agglutinin yeast adhesion receptor. Recombinant proteins encoded by the vector carry the Aga2 subunit, which associates with Aga1 expressed by the host cell.
<b>New England Biolabs</b> www.neb.com	Ph.D. Phage Display Peptide Library Kits	M13KE vector (pIII phage coat fusion proteins with Gly-Gly-Gly-Ser linker).	Three random peptide libraries are available: 2 of 7 and 1 of 12 residues. One of the 7-mer libraries (C7C) expresses the randomized insert sequence with flanking cysteine residues.
<b>Novagen</b> www.novagen.com	T7 Select Phage Display System	T7 (expresses peptides/proteins as fusions to the carboxyl terminus of the 10B capsid protein).	The system is particularly useful for cDNA source material. Displayed products on mature phage particles are released by cell lysis.
<b>Syncomm Biotechnology Development Labs</b> www.syncommdbd.com	Phage Display System/Service	Filamentous phage cloning vector; libraries generated upon request.	Consultation service; customers provide the bait (target of interest), Syncomm provides libraries (if needed); complete three rounds of panning and amplification, and positive clone identification by ELISA and DNA sequencing.

### Constrained Libraries

Linear peptides displayed on the surface of bacteriophages may be identical to a "natural" peptide in amino acid sequence but may adopt a completely different three-dimensional configuration. One solution to this problem is to constrain the mobility and configuration of the displayed peptide by including cysteine residues in the sequences flanking the randomized peptide sequence. The idea is that the cysteine residues will form a rigid disulfide scaffold that will stabilize the peptide in a favorable structure (Felici et al. 1991; McLafferty et al. 1993). Using this strategy, several groups have been able to select peptides that bind to a selector molecule from constrained libraries but not from unconstrained libraries of equivalent complexity (e.g., please see Folgori et al. 1994; Hoess et al. 1994). However, this approach may not be a universal panacea for structural difficulties since the inclusion of cysteine residues in the displayed peptides markedly reduces the infectivity of filamentous phages and so greatly lowers the titer of constrained display libraries.

The search to identify alternative scaffolding systems that allow a proper secondary or tertiary display of constrained peptides has included the use of  $\alpha$  helices (Wu et al. 1989; Bianchi et al. 1995; Nord et al. 1995), the  $\beta$ -sheet structure of the amylose inhibitor tendamistat (McConnell and Hoess 1995), the zinc-finger protein (Wu et al. 1989; Rebar and Pabo 1994), and even the use of synthetic supports, known as "peptides on beads" (Needels et al. 1993). The review by Smith and Petrenko (1997) provides a reasonably comprehensive list of constrained peptide libraries.

### Affinity Selection and Purification of Bacteriophages

Most of the schemes to select bacteriophages expressing a specific peptide involve screening the display library with a target protein or another ligand, a process known as "panning." In a typical protocol, libraries are exposed overnight to biotinylated antibody or ligand and then panned for a few minutes on plastic surfaces (plates or immunobeads) or paramagnetic beads coated with streptavidin (Parmley and Smith 1988). Unbound bacteriophages are washed away in buffer containing a detergent and the bound bacteriophages are then recovered either by elution with a buffer such as glycine-HCl buffer (pH 2.2) or with a magnetic separator. In principle, it is possible to improve the specificity of recovery by using a buffer containing a ligand or cofactor that will promote dissociation of a particular type of interaction. For example, Blond-Elguindi et al. (1993) screened display libraries for bacteriophages expressing peptides with an ability to bind to an immobilized mammalian chaperone. The bacteriophages were eluted by adding ATP, which causes dissociation of chaperones from their denatured protein substrates.

Whatever the method of dissociation, bacteriophages expressing high-affinity ligands can be expected to elute more slowly from the target protein than those expressing ligands of low affinity. However, the presence of "multivalent" copies of the peptide on the bacteriophage surface fosters the formation of multiple contacts between the bacteriophage particle and the target protein. Nearly all of these contacts would need to be broken at the same time for the bacteriophage to be recovered in the eluate. Recovery of bacteriophages that bind with high affinity may be facilitated by using a "monovalent" 3 + 3 or 8 + 8 display system (please see Table 18-13). In practical terms, however, it is often impossible to distinguish between bacteriophages that bind to the target with different affinities (Barrett et al. 1992; Hawkins et al. 1992).

After neutralization and concentration, the eluted bacteriophages are generally amplified and panned several more times. Depending on the ligand, the fold-overall enrichment after two rounds of panning and amplification can be  $10^6$  or greater. Eventually, small populations of plaques or, in case of phagemid vectors, transformed bacterial colonies can be screened with ligand, essentially as described by Young and Davis (1983). Single-stranded DNA of individual clones of bacteriophages can then be prepared and sequenced to determine the amino acid sequence of the peptide that binds to the antibody or ligand.

### Commercial Display Systems and Kits

A number of commercial systems are now available that provide a variety of resources for construction, display, and analysis of peptide libraries using systems ranging from bacteriophage to yeast to mammalian cells. These systems are summarized in Table 18-16. Unless there is a strong scientific reason to choose a more esoteric display system, we recommend using standard, filamentous phage display libraries (e.g., those sold by New England Biolabs) to work out conditions for panning, screening, and amplification. The manufacturers have accumulated a fund of useful knowledge about these libraries and will be able to suggest possible solutions to most problems that arise.

### Bacteriophage Display of Foreign Proteins

Foreign proteins, like peptides, can be displayed in a functional form on the surface of filamentous bacteriophage particles by fusing the coding sequence to gene III or gene VIII (for review, please see Hoess 1993).

Insertion into gene VIII has the advantage that thousands of copies of the protein of interest are expressed on each bacteriophage particle, but it has the marked disadvantage of placing severe constraints on the size of the insert. However, inserts encoding  $>6$  amino acids do not form viable bacteriophage particles (Greenwood et al. 1991) unless the cell is also infected with a helper bacteriophage that codes for wild-type gene VIII protein (Willis et al. 1993). This results in the production of phenotypically mixed particles in which only a minority of the gene VIII coat protein molecules carry the desired insertion.

A cloning site located near the amino terminus of gIII protein has been used to express domains of several mammalian secretory proteins without compromising infectivity of the recombinant bacteriophages. The resulting fusion proteins retain at least some of their original biochemical and enzymatic properties. Bacteriophage particles that display fusion proteins on their surface can be captured by affinity panning or chromatography using specific ligands that bind to the cognate protein with high affinity. These ligands can include inhibitors and substrates in the case of displayed enzymes, antigenic epitopes in the case of antibodies, and receptors in the case of displayed polypeptide ligands.

#### PHAGE DISPLAY OF ANTIBODIES

Filamentous phage particles and phagemids can be used to display antibodies (usually in the form of scFv or Fab' fragments). If phagemids are used as vectors, either the  $V_H$ -CH1 or  $V_L$ -CL chain is fused to pIII, whereas the other chain is expressed without fusion to pIII. Using libraries containing naive and semisynthetic germline variable genes, antibodies with affinities comparable to those in a secondary immune response can be generated against foreign and self antigens. The affinity of single antibodies displayed on bacteriophages can be further improved by random mutagenesis, site-directed mutagenesis (Gram et al. 1992; W.-P. Yang et al. 1995), and fragment or chain shuffling (Burton and Barbas 1994; Winter et al. 1994). For an excellent description of the construction and assay of libraries of antibodies in filamentous bacteriophages, please see Barbas et al. (2001).

Filamentous bacteriophage display systems offer a powerful means to select rare genes encoding proteins with ligand-binding activities. For example, antigen-binding bacteriophages have been selected by affinity chromatography from populations of bacteriophage expressing fragments of single-chain Fv antibodies (McCafferty et al. 1990; Verhaar et al. 1995) and two-chain Fab libraries (Kang et al. 1991). Other uses of this system include the selection of variants of human growth hormone that have a high affinity for the human growth hormone receptor (Bass et al. 1990; Lowman et al. 1991); the assembly of combinatorial Fab libraries on bacteriophage surfaces (Hoogenboom et al. 1991; Kang et al. 1991; for review, please see Johnson and Chiswell 1993; Winter et al. 1994); the selection of bacteriophages expressing potent inhibitors of elastase (Roberts et al. 1992a,b); the selection of DNA-binding proteins with altered specificities (for review, please see Choo and Klug 1995); and the expression of a variety of functionally active proteins on the bacteriophage surface. These include alkaline phosphatase (McCafferty et al. 1991), BPTI (Roberts et al. 1992a,b), the B chain of ricin (Swimmer et al. 1992), trypsin (Corey et al. 1993), plasminogen activator inhibitor-I (Pannekoek et al. 1993; van Meijer et al. 1996), and ciliary neurotrophic factor (Saggio et al. 1995).

#### INTERACTION RESCUE

As discussed above, bacteriophages lacking the amino-terminal domain of pIII are unable to penetrate F pili and are not infectious. However, infectivity can be restored if the domain is reintroduced to the phage. In interaction rescue, the amino-terminal domain of pIII is fused to a soluble protein whose dimerization partner is fused to the truncated pIII and displayed on the surface of the bacteriophage. When interacting domains (e.g., leucine zippers) of heterologous proteins are cloned into the two parts of the gIIIp gene, the resulting fusion proteins are able to associate and thereby to restore activity to gIIIp and infectivity of the progeny bacteriophage (Dueñas and Borrebaeck 1994; Gramatikoff et al. 1994). Interaction rescue has promise as a method to select clones encoding functionally interacting protein domains from cDNA libraries.

So far, filamentous bacteriophage systems have been successful chiefly for the display of small and moderately sized secretory proteins — presumably because these proteins can be efficiently secreted through the inner membrane of *E. coli*, can fold into their correct three-dimensional structures in the periplasmic space, and can maintain their correct configuration on the surface of the bacteriophage particle after exposure to an oxidizing environment. Whether bacteriophage display can be successfully applied to larger intracellular proteins is therefore rather doubtful.

---

## GENOMICS AND THE INTERACTION TRAP

---

At this point in the progress of the genome projects, vast quantities of sequence data for genes and proteins have been generated. An extremely high percentage of this information corresponds to novel sequences, with no available hints about potential cellular function to be gleaned from patterns of homology. Of the multiple complementary approaches under development to assign function to the great number of predicted proteins, a systematic use of the two-hybrid system to establish direct physical interactions between novel genes and previously characterized proteins promises to be particularly useful. To this end, a number of strategies have been developed.

### Interaction Mating, Arrayed Libraries, and Libraries of Baits

An early entry to the field of genomic analysis for two-hybrid studies was the description of interaction mating (Finley and Brent 1994). This idea exploited the fact that yeast containing panels of baits or panels of preys could be mated in defined grids, allowing the rapid assessment of interactions between a relatively large number of defined baits of interest; furthermore, because the panels could be arrayed conveniently in microtiter plates, the technique was amenable to high-throughput analyses on a scale required for genomic studies. This idea evolved rapidly into the formatting of complete cDNA libraries into pooled subsets, which enables electronic handling of the data (e.g., including tracing back the identity of clones derived from the arrayed high-complexity normalized EST [Hua et al. 1998] or Unigen libraries [Weiner 1998]); allows functional subtraction of the "promiscuous positive" class of interactor from the library; and facilitates the automated handling of samples, which should promote large-scale proteome analysis (Buckholz et al. 1999).

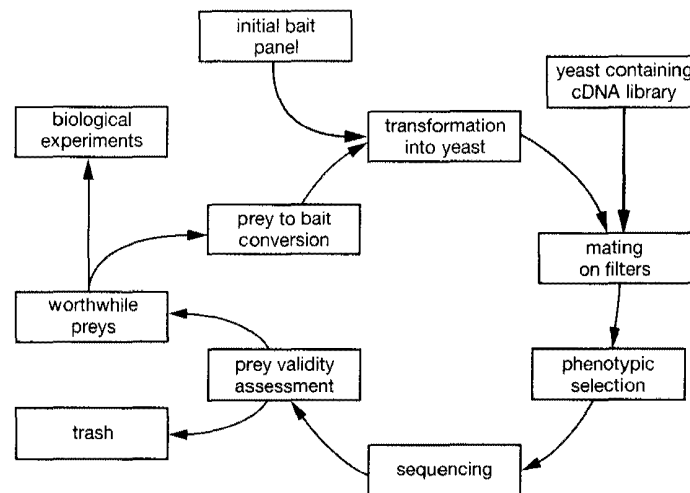
A second development has been the use of libraries of bait proteins, in conjunction with the standard libraries of prey. In general, use of randomly generated bait libraries had been avoided because a high percentage of inserted cDNAs (estimated at 5–10%) possessed the intrinsic ability to activate transcription, leading to high background in conventional two-hybrid screening assays. However, by adapting approaches in which such activating fusions could be avoided (e.g., please see Bartel et al. 1996) or potentially counterselected in a prescreening step (Vidal et al. 1996a,b; Walhout and Vidal 1999), such libraries could be used in interaction mating approaches on the large scale desired for analysis of genome-complexity groups of cDNAs (Figure 18-31).

### A Map of All Possible Interactions

Some investigators have begun pilot projects to explore the utility of two-hybrid genomic analysis. The goals of such attempts are in some cases immense in scope, with the objective of solving all possible protein-protein interactions for a given genome. In other cases, a more circumscribed set of goals involve the mapping of interactions between all proteins involved in discrete multiprotein complexes that regulate specific cellular processes.

Two primary papers exemplify the two strategies. In the first, Bartel et al. (1996) attempted to solve the complete protein interaction networks of the ~55 known proteins of *E. coli* bacteriophage T7, using a series of approaches that combined interaction mating and library screening of defined and randomly generated bait and prey fusions. This effort yielded a wealth of information about interactions among different proteins, as well as interactions taking place between separate domains of a single protein that might be taken to be predictive of homomeric interactions occurring during protein folding. However, given that a number of interactions known to occur between T7 proteins were not detected, and given the laboriousness of the general approach, it is not yet clear the degree to which this brute-force interaction solution will be translatable to organisms of higher genome complexity.

In an alternative approach, Fromont-Racine et al. (1997) focused their efforts on identifying a comprehensive set of proteins involved in a discrete part of the cellular machinery, the spliceosome. To this end, these authors built ten targeted baits from discrete *Saccharomyces cerevisiae* proteins implicated in pre-mRNA splicing, each of which was used for a library screen. Preys isolated in the screens were "rated" on a scale that considered the nature of the cDNA and the frequency of isolation; those receiving the highest ratings were used in reiterative screens to isolate new preys. Finally, baits and preys were systematically examined for cross-interactions within the complete group; additionally, sequences of previously undefined open



**FIGURE 18-31 Strategies for Genomic Analysis**

Genomic strategies involve reiterative screening and cross-screening between baits and preys to identify interaction networks. One potential path is shown, in which a panel of baits is initially mated en masse against an activation-domain-fused cDNA library; positives are selected, ranked, and used both as starting point for a second round screen and for directed biological experiments suggested by the interactions.

reading frames were disrupted, followed by genetic analysis of relevance to known splicing factors. This approach was extremely successful in predicting a network of interactions between known and novel splicing factors and may offer a particularly useful paradigm for studies of other cellular “machines” complementary to direct physical assay systems such as mass spectrophotometric analysis.

A larger-scale experiment is under way to map interactions among all the proteins encoded by the *S. cerevisiae* genome, based on the creation of complete sets of DNA-binding domain and activation domain fusions to each of ~6000 yeast genes (Hudson et al. 1997; Uetz et al. 2000). Both libraries are arrayed to be mated to each other, and this approach is meant to be a prototype for even more high-throughput applications, such as mapping interaction of the human proteome. A recent report has demonstrated the possibility of coupling such functionally targeted two-hybrid genomic analysis with the use of oligonucleotide arrays representing the full complement of genes in *S. cerevisiae* (Cho et al. 1998), a development that should greatly speed the general analysis. Finally, another model project to annotate functionally large numbers of uncharacterized proteins predicted by complete genome sequences using large-scale two-hybrid analysis is ongoing for *Caenorhabditis elegans*. Starting with 27 proteins involved in vulval development, a functional annotation for ~100 uncharacterized gene products has been obtained. The resulting map of interacting sequence tags (or ISTs) revealed both known and new potential interactions (Walhout et al. 2000) and has been integrated productively with other forms of annotation available for *C. elegans* through the ACeDB database project.

### Detection of Inactivating Mutations in Human Genes

In a peripheral approach, the yeast two-hybrid system is being adapted as an additional means of screening (e.g., of clinical samples) for human genes implicated in disease. A simple method detects functional mutations by virtue of their ability to abolish a protein-protein interactions. A high-throughput approach involving use of direct recombinational cloning in yeast of a reverse transcription PCR product is followed by a simple growth selection for the interaction with a functional partner (Schwartz et al. 1998). This method should be able to distinguish both homozygous and heterozygous mutations in any human genes whose encoded proteins have suitable partners in the two-hybrid assay. It has been used successfully to detect mutations in the p53 tumor suppressor gene (Schwartz et al. 1998).

## INTERACTION TRAP AND RELATED TECHNOLOGIES

Although the yeast two-hybrid system and its derivatives have clearly been fruitful, a number of complementary technologies have been developed. In particular, nontranscription-based systems (discussed below) circumvent several intrinsic limitations of the two-hybrid applications, including the inability to deal easily with self-activators and proteins excluded from the nucleus. A number of these systems are still in early stages of evaluation.

### One-hybrid, One-and-a-half Hybrid, and One-Two Hybrid

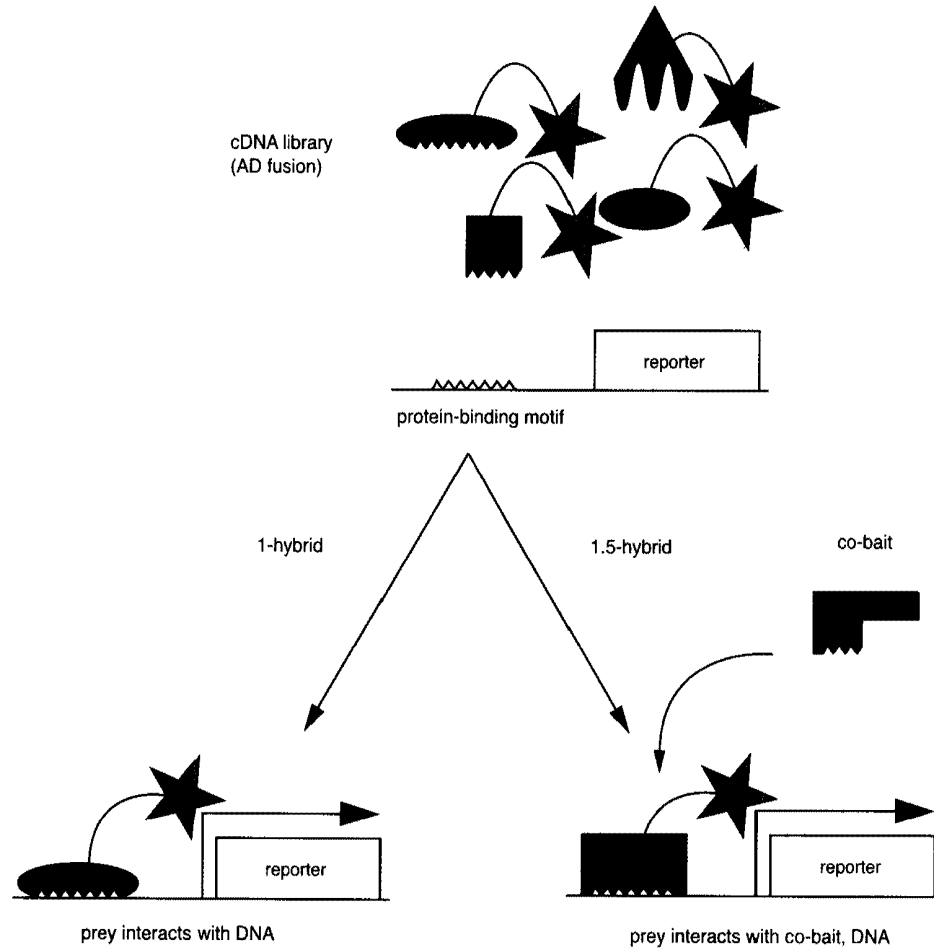
The two-hybrid technologies discussed in the introduction to Protocol 1 of this chapter address the interactions of proteins with proteins, peptides, drugs, and RNA. The one-hybrid system allows the identification of proteins that interact with DNA. A number of groups independently described the development of such an approach (Wilson et al. 1991; Li and Herskowitz 1993; Wang and Reed 1993; Dowell et al. 1994; Inouye et al. 1994; Chong et al. 1995). In a general strategy, a DNA sequence of biological interest (known to encompass a specific binding motif for a protein) is cloned as a single copy or multimer upstream of reporter genes, similar to those used in a two-hybrid system (Figure 18-32). Specific selection strains are then generated with the binding-motif-reporter integrated or encompassed in a plasmid, and an activation-domain library essentially equivalent to those used in two-hybrid screening is then used to identify proteins that can bind and activate transcription. Although the need to construct specific motif-reporter strains makes development of screening reagents more laborious, one-hybrid screens work well for a number of proteins. Reflecting the growing popularity of this strategy, Wolf et al. (1996) reported the generation of a series of reporter constructs that allow greater flexibility in the use of a one-hybrid approach with libraries from either the GAL4 or LexA two-hybrid systems.

A related approach combines elements of the one-hybrid and two-hybrid systems to screen for DNA-binding proteins. This approach, termed one-and-a-half hybrid, is intended to identify proteins that bind DNA only when complexed as a heterodimer with a second, known partner or that fail to bind DNA autonomously, but make a stable ternary complex in the presence of an accessory protein. A reporter is first constructed using a heterodimer-binding site to direct transcription, and library transformations are then performed in yeast expressing the known heterodimeric partner. This approach was first used to identify SAP-1, which associates with serum response factor (SRF) to bind the *c-fos* serum response element (SRE) (Dalton and Treisman 1992), and it has been successfully used by other groups (Naya et al. 1995). A somewhat similar approach was used in the double interaction screen (DIS). DIS was successfully used (Yu et al. 1999) to identify simultaneously DNA-binding transregulators of *ftz* gene expression (which would bind to the *ftz* proximal enhancer, placed upstream of reporter genes) and cofactors that directly interact with Ftz protein.

Finally, Luo et al. (1996) has proposed that in some specialized cases, involving identification of proteins that both bind DNA independently and dimerize with a known partner, it may be productive to screen for both parameters simultaneously to eliminate false positives and generally increase specificity of the assay. In this strategy, termed one-two hybrid, yeast selection strains are engineered to contain one reporter driven by binding sites for p53, a second standard reporter strain for the two-hybrid system, and a bait fused to the p53 homodimerization sequence. Supertransformation of this strain with wild-type p53 results in simultaneous activation of both reporters, proving that the concept is practicable; it has not yet been broadly tested by library screening.

### Split-Ubiquitin

The ubiquitin-based split-protein sensor (USPS) method has been proposed as a means of assaying transient protein-protein associations in real time, unconstrained by considerations of intracellular localization (Johnsson and Varshavsky 1994). In this strategy, a protein is fused to a carboxy-terminal fragment of ubiquitin, and a second protein is fused to a mutated amino-terminal fragment of ubiquitin. If the two test proteins interact, the amino- and carboxy-terminal fragments of ubiquitin are brought into proximity, targeting the carboxy-terminal fusion protein for cleavage. This degradation, monitored by western blot analysis, constitutes the reporter for the system (Johnsson and Varshavsky 1994; Dunnwald et al. 1999). This system has not yet attained broad use in the scientific community, and information about its performance with a variety of proteins is lacking. Some features, including the ability to switch between assays *in vivo* or *in vitro*,



**FIGURE 18-32 One Hybrid, One-and-a-Half Hybrid**

A specialized yeast strain is constructed with one or more reporters that are transcriptionally responsive to a particular protein-binding motif. In the one-hybrid screen, an activation domain-fused cDNA library is transformed into the selection strain, and preys with the ability to activate transcription of reporters are directly selected (*bottom left*). The one-and-a-half hybrid screen relies on the use of known preys that bind only in the presence of a cofactor that contains the DNA-binding domain and dimerization domain (termed co-bait in figure). In this case, preys from an activation domain library are selected for their ability to activate the transcription of reporters in the presence of the co-bait.

are attractive in some applications. To create a more practical incarnation, a system was devised (Stagljar et al. 1998) where, upon interaction-mediated ubiquitin reconstitution, the cleavage releases a transcription factor, which activates reporter genes in the nucleus. As a result, interaction between membrane proteins can be analyzed by means of auxotrophic selection and a colorimetric assay.

### Sos/Ras Recruitment

The recently developed Sos recruitment system (SRS) is designed to study protein-protein interactions of proteins that are not suitable for two-hybrid screens, either because they strongly activate transcription or because they associate strongly with membranes, and cannot be effectively localized to the nucleus (Aronheim 1997; Aronheim et al. 1997). This strategy exploits basic properties of signal transduction as a selective strategy. Yeast require Ras function to be viable; Ras activity depends on the activity of a guanyl nucleotide exchange factor (GEF), which allows conversion to the active GTP-bound form. The normal *S. cerevisiae* GEF for Ras is Cdc25; mutations in Cdc25 can be complemented by the mammalian Cdc25 homolog, Sos, if Sos is effectively localized to the cell membrane. In the SRS strategy (commercially available from Stratagene), the *S. cerevisiae* strains used for selection contain a temperature-sensitive mutation of

Cdc25. Bait proteins are expressed as fusions to a myristylation (membrane-targeting) signal, whereas interacting partners, either defined or from a cDNA library, are expressed as fusions to Sos. If the two protein components interact, Sos is brought to the membrane, allowing viability at the Cdc25 restrictive temperature.

Some difficulties have been encountered with this technique, and in an attempt to overcome a number of problems using SRS, the developers have improved the protein recruitment system, designated the Ras recruitment system (RRS), based on the absolute requirement that Ras be localized to the plasma membrane for its function (Broder et al. 1998). Ras membrane localization and activation can be again achieved through interaction between two-hybrid proteins. Both the SRS and RRS systems have been used effectively both in tests of known interactions and to isolate novel interacting proteins from a library (Aronheim et al. 1997, 1998; Broder et al. 1998; Yu et al. 1998); they are a promising addition to the available panel of interaction assay strategies.

### Non-Yeast Two-Hybrid Systems

Because of its genetic robustness and ease of use, yeast has been the organism of choice for development of two-hybrid systems, and will probably remain so. Nevertheless, some applications, foremost among them assay of pharmacological compounds, would benefit from a mammalian counterpart to the yeast two-hybrid system, and a number of groups have developed basic reagents toward this end (Dang et al. 1991; Vasavada et al. 1991; Fearon et al. 1992; Luo et al. 1997). To improve the sensitivity of mammalian two-hybrid assays, allowing interactions between poorly expressed proteins to be detected, a strategy of "bundling" activators has been developed recently. Incorporation of a tetramerization domain (derived from lactose repressor) allowed activation domain fusion proteins to be expressed as noncovalent tetrameric "bundles," which are significantly more potent than simple monomeric activators at similar levels of expression (Natesan et al. 1999). In general, these systems have proven to be most useful in assay of interactions between pre-defined proteins.

Rossi et al. (1997) have recently described a mammalian strategy utilizing two-hybrid principles, but with a very different readout, intended to allow assessment of dimerization in a biologically relevant context. This system exploits a phenomenon called  $\alpha$ -complementation, which was been used for many years in prokaryotes (e.g., in the blue-white selection vectors used for cloning). Cells that bear either the  $\alpha$  (amino-terminal) fragment or  $\omega$  (carboxy-terminal) fragment of  $\beta$ -galactosidase (encoded by 3' or 5' deletions of the bacterial *lacZ* gene, respectively) show no enzyme activity. However, if a cell expresses  $\alpha$  and  $\omega$  fragments in combination, they can assemble to form an active enzyme (Ullmann et al. 1967). Some  $\beta$ -galactosidase mutants that reduce the affinity of  $\alpha$  and  $\omega$  fragments for each other fail to reconstitute an active enzyme; however, this can be overcome if the interaction is artificially enforced. Fusion of interacting proteins to such noninteracting  $\alpha$  and  $\omega$  mutant fragments provides a tool for enforcement, and the  $\beta$ -galactosidase activity of the reconstituted enzyme serves as measure of protein-protein interaction (Rossi et al. 1997). This application was tested by expressing FRAP and FKBP12 (which are known to form a complex in the presence of rapamycin) as chimeras with *lacZ* deletions and monitoring  $\beta$ -galactosidase activity reflecting FRAP-FKBP12 complex formation.

Although bacterial systems would clearly possess the genetic power and cost-effectiveness of yeast two-hybrid systems, until quite recently, much less effort has gone into developing *E. coli*-based screening technologies. This may derive in part from the fact that the vast majority of proteins studied are derived from higher eukaryotes, which may be expected to be posttranslationally modified or folded more appropriately in yeast than in bacteria, enhancing the chance of obtaining biological results. However, some reagents suitable for studying protein-protein interactions by two-hybrid-related approaches have been developed and may be particularly useful for investigators working with prokaryotic proteins: Some of these systems have been described previously (Hu et al. 1990; Bunker and Kingston 1995; Hu 1995; Dmitrova et al. 1998; Kornacker et al. 1998; Di Lallo et al. 1999). Probably the most sophisticated system currently available (Karimova et al. 1998) is based on reconstitution of adenyl cyclase signaling functions in *E. coli*. cAMP produced by this enzyme activated CAP and in turn enabled transcription from the *lac* or *mal* operons, which resulted in growth on selective plates and specific color on indicator media. The involvement of a signal transduction pathway step in this system allows spatial separation between interacting hybrid proteins and the transcriptional activation readout. So far, however, only a "model screening" has been performed.

A more dynamic system, based on selection for histidine heterotrophy, is designed to detect either protein-protein or protein-DNA interactions (Joung et al. 2000). In this case, the bait is a modified version of the  $\alpha$ -subunit of the *E. coli* RNA polymerase. Prey are selected from libraries encoding either variant protein or DNA-binding domains.



## REFERENCES

- Adams S.R., Harootunian A.T., Buechler Y.J., Taylor S.S., and Tsien R.Y. 1991. Fluorescence ratio imaging of cyclic AMP in single cells. *Nature* **349**: 694–697.
- Aebbersold R.H., Leavitt J., Saavedra R.A., Hood L.E., and Kent S.B.H. 1987. Internal amino acid sequence analysis of proteins separated by one- or two-dimensional electrophoresis after in situ protease digestion on nitrocellulose. *Proc. Natl. Acad. Sci.* **84**: 6970–6974.
- Aho S., Arffman A., Pummi T., and Uitto J. 1997. A novel reporter gene MEL1 for the yeast two-hybrid system. *Anal. Biochem.* **253**: 270–272.
- Aitken A. 1999. Protein consensus sequence motifs. *Mol. Biotechnol.* **12**: 241–253.
- Altschuh D., Dubs M.C., Weiss E., Zeder-Lutz G., and Van Regenmortel M.H. 1992. Determination of kinetic constants for the interaction between a monoclonal antibody and peptides using surface plasmon resonance. *Biochemistry* **31**: 6298–6304.
- Arkin A.P. and Youvan D.C. 1992. Optimizing nucleotide mixtures to encode specific subsets of amino acids for semi-random mutagenesis. *Bio/Technology* **10**: 297–300.
- Armstrong J., Perham R.N., and Walker J.E. 1981. Domain structure of bacteriophage fd adsorption protein. *FEBS Lett.* **135**: 167–172.
- Arnone M.I., Bogarad L.D., Collazo A., and Kirchner C.V. 1997. Green fluorescent protein in the sea urchin: New experimental approaches to transcriptional regulatory analysis in embryos and larvae. *Gene* **124**: 4649–4659.
- Aronheim A. 1997. Improved efficiency sos recruitment system: Expression of the mammalian GAP reduces isolation of Ras GTPase false positives. *Nucleic Acids Res.* **25**: 3373–3374.
- Aronheim A., Zandi E., Hennemann H., Elledge S.J., and Karin M. 1997. Isolation of an AP-1 repressor by a novel method for detecting protein-protein interactions. *Mol. Cell Biol.* **17**: 3094–3102.
- Aronheim A., Broder Y.C., Cohen A., Fritsch A., Belisle B., and Abo A. 1998. Chp, a homologue of the GTPase Cdc42Hs, activates the JNK pathway and is implicated in reorganizing the actin cytoskeleton. *Curr. Biol.* **8**: 1125–1128.
- Ayer D.E., Kretzner L., and Eisenman R.N. 1993. Mad: A heterodimeric partner for Max that antagonizes Myc transcriptional activity. *Cell* **72**: 211–222.
- Bannasch D. and Schwab M. 1999. A versatile bait vector allowing rapid isolation of prey vectors in Gal4-dependent yeast two-hybrid screens. *Plasmid* **42**: 139–143.
- Barbas III, C.F., Burton D.R., Scott J.K., and Silverman G.J., eds. 2001. *Phage display: A laboratory manual*. Cold Spring Harbor Laboratory Press, Cold Spring Harbor, New York.
- Barbas III, C.F., Kang A.S., Lerner R.A., and Benkovic S.J. 1991. Assembly of combinatorial antibody libraries on phage surfaces: The gene III site. *Proc. Natl. Acad. Sci.* **88**: 7978–7982.
- Barrett R.W., Cwirla S.E., Ackerman M.S., Olson A.E., Peters E.A., and Dower W.J. 1992. Selective enrichment and characterization of high affinity ligands from collections of random peptides on filamentous phage. *Anal. Biochem.* **204**: 357–364.
- Bartel P.L., Roecklein J.A., SenGupta D., and Fields S. 1996. A protein linkage map of *Escherichia coli* bacteriophage T7. *Nat. Genet.* **12**: 72–77.
- Bass S., Greene R., and Wells J.A. 1990. Hormone phage: An enrichment method for variant proteins with altered binding properties. *Proteins* **8**: 309–314.
- Bastiaens P.I.H. and Jovin T.M. 1996. Microspectroscopic imaging tracks the intracellular processing of a signal-transduction protein fluorescently labeled protein kinase C beta I. *Proc. Natl. Acad. Sci.* **93**: 8407–8412.
- . 1998. Fluorescence resonance energy transfer microscopy. In *Cell biology: A laboratory handbook*, 2nd edition (ed. J.E. Celis), vol. 3, pp. 136–146. Academic Press, New York.
- Bastiaens P.I.H. and Squire A. 1999. Fluorescence lifetime imaging microscopy: Spatial resolution of biochemical processes in the cell. *Trends Cell Biol.* **9**: 48–52.
- Bastiaens P.I.H., Majoul I.V., Verveer P.J., Soling H.D., and Jovin T.M. 1996. Imaging the intracellular trafficking and state of the AB(5) quaternary structure of cholera-toxin. *EMBO J.* **15**: 4246–4253.
- Beijersbergen R.L., Kerkhoven R.M., Zhu L., Carlee L., Voorhoeve P.M., and Bernards R. 1994. E2F-4, a new member of the E2F gene family, has oncogenic activity and associates with p107 in vivo. *Genes Dev.* **8**: 2680–2690.
- Beranger E., Aresta S., de Gunzburg J., and Camonis J. 1997. Getting more from the two-hybrid system: N-terminal fusions to LexA are efficient and sensitive baits for two-hybrid studies. *Nucleic Acids Res.* **25**: 2035–2036.
- Bhardwaj D., Singh S.S., Abrol S., and Chaudhary V.K. 1995. Monoclonal antibodies against a minor and the major coat proteins of filamentous phage M13: Their application in phage display. *J. Immunol. Methods.* **179**: 165–175.
- Bianchi E., Folgori A., Wallace A., Nicotra M., Acali S., Phalipon A., Barbato G., Bazzo R., Cortese R., Felici F., et al. 1995. A conformationally homogeneous combinatorial peptide library. *J. Mol. Biol.* **247**: 154–160.
- Blackwood E.M. and Eisenman R.N. 1991. Max: A helix-loop-helix zipper protein that forms a sequence-specific DNA-binding complex with Myc. *Science* **251**: 1211–1217.
- Blancar M.A. and Rutter W.J. 1992. Interaction cloning: Identification of a helix-loop-helix zipper protein that interacts with c-Fos. *Science* **256**: 1014–1018.
- Blancafort P., Steinberg S.V., Paquin B., Klinck R., Scott J.K., and Cedergren R. 1999. The recognition of a noncanonical RNA base pair by a zinc finger protein. *Chem. Biol.* **6**: 585–597.
- Blond-Elguindi S., Cwirla S.E., Dower W.J., Lipschutz R.J., Sprang S., Sambrook J.F., and Gething M.-J.H. 1993. Affinity panning of a library of peptides reveals the binding specificity of BiP. *Cell* **75**: 717–728.
- Brent R. and Ptashne M. 1984. A bacterial repressor protein or a yeast transcriptional terminator can block upstream activation of a yeast gene. *Nature* **312**: 612–615.
- . 1985. A eukaryotic transcriptional activator bearing the DNA specificity of a prokaryotic repressor. *Cell* **43**: 729–736.
- Broder Y.C., Katz S., and Aronheim A. 1998. The ras recruitment system, a novel approach to the study of protein-protein interactions. *Curr. Biol.* **8**: 1121–1124.
- Brown M.A. and MacGillivray R.T. 1997. Vectors for expressing proteins at the amino-terminus of an activation domain for use in the yeast two-hybrid system. *Anal. Biochem.* **247**: 451–452.
- Buckholz R.G., Simmons C.A., Stuart J.M., and Weiner M.P. 1999. Automation of yeast two-hybrid screening. *J. Mol. Microbiol. Biotechnol.* **1**: 135–140.
- Bunker C.A. and Kingston R.E. 1995. Identification of a cDNA for SSRP1, an HMG-box protein, by interaction with the c-Myc oncoprotein in a novel bacterial expression screen. *Nucleic Acids Res.* **23**: 269–276.

- Burton D.R. and Barbas III, C.F. 1994. Human antibodies from combinatorial libraries. *Adv. Immunol.* **57**: 191–280.
- Celia H., Wilson-Kubalek E., Milligan R.A., and Teyton L. 1999. Structure and function of a membrane-bound murine MHC class I molecule. *Proc. Natl. Acad. Sci.* **96**: 5634–5639.
- Chalfie M., Tu Y., Fuskirchen G., Ward W.W., and Prasher D.C. 1994. Green fluorescent protein as a marker for gene expression. *Science* **263**: 802–805.
- Chien C.T., Bartel P.L., Sternglanz R., and Fields S. 1991. The two-hybrid system: A method to identify and clone genes for proteins that interact with a protein of interest. *Proc. Natl. Acad. Sci.* **88**: 9578–9582.
- Chiu M.L., Katz H., and Berlin V. 1994. RAPT1, a mammalian homolog of yeast Tor, interacts with the FKBP12/rapamycin complex. *Proc. Natl. Acad. Sci.* **91**: 12574–12578.
- Cho R.J., Fromont-Racine M., Wodicka L., Feierbach B., Stearns T., Legrain P., Lockhart D.J., and Davis R.W. 1998. Parallel analysis of genetic selections using whole genome oligonucleotide arrays. *Proc. Natl. Acad. Sci.* **95**: 3752–3757.
- Chong J.A., Tapia-Ramirez J., Kim S., Toledo-Aral J.J., Zheng Y., Boutros M.C., Altshuler Y.M., Frohman M.A., Kraner S.D., and Mandel G. 1995. REST: A mammalian silencer protein that restricts sodium channel expression to neurons. *Cell* **80**: 949–957.
- Choo Y. and Klug A. 1995. Designing DNA-binding proteins on the surface of filamentous phage. *Curr. Opin. Biotechnol.* **6**: 431–436.
- Christensen L.L. 1997. Theoretical analysis of protein concentration determination using biosensor technology under conditions of partial mass transport limitation. *Anal. Biochem.* **249**: 153–164.
- Christian R.B., Zuckermann R.N., Kerr J.M., Wang L., and Malcolm B.A. 1992. Simplified methods for construction, assessment and rapid screening of peptide libraries in bacteriophage. *J. Mol. Biol.* **227**: 711–718.
- Clegg R.M. 1996. Fluorescence resonance energy transfer spectroscopy and microscopy. In *Fluorescence imaging spectroscopy and microscopy* (ed. X.F. Wang and B. Herman), pp. 179–251. Wiley, New York.
- Clegg R.M., Feddersen B.A., Gratton E., and Jovin T.M. 1992. Time resolved imaging fluorescence microscopy. *Proc. SPIE* **1640**: 448–460.
- Colas P., Cohen B., Jessen T., Grishina I., McCoy J., and Brent R. 1996. Genetic selection of peptide aptamers that recognize and inhibit cyclin-dependent kinase 2. *Nature* **380**: 548–550.
- Coombs G.S., Bergstrom R.C., Madison E.L., and Corey D.R. 1998. Directing sequence-specific proteolysis to new targets. The influence of loop size and target sequence on selective proteolysis by tissue-type plasminogen activator and urokinase-type plasminogen activator. *J. Biol. Chem.* **273**: 4323–4328.
- Corey D.R., Shiau A.K., Yang Q., Janowski B.A., and Craik C.S. 1993. Trypsin display on the surface of bacteriophage. *Gene* **128**: 129–134.
- Cormack R.S., Hahlbrock K., and Somssich I.E. 1998. Isolation of putative plant transcriptional coactivators using a modified two-hybrid system incorporating a GFP reporter gene. *Plant J.* **14**: 685–692.
- Cortese R., Monaci P., Nocosia A., Luzzago A., Felici F., Galfré G., Pessi A., Tramontano A., and Sollazzo M. 1995. Identification of biologically active peptides using random libraries displayed on phage. *Curr. Opin. Biotechnol.* **6**: 73–80.
- Courchesne P.L. and Patterson S.D. 1999. Identification of proteins by matrix-assisted laser desorption/ionization mass spectrometry using peptide and fragment ion masses. *Methods Mol. Biol.* **112**: 487–511.
- Crissman J.W. and Smith G.P. 1984. Gene III protein of filamentous phages: Evidence for a carboxyl-terminal domain with a role in morphogenesis. *Virology* **132**: 445–455.
- Cwirla S.E., Peters E.A., Barrett R.W., and Dower W.J. 1990. Peptides on phage: A vast library of peptides for identifying ligands. *Proc. Natl. Acad. Sci.* **87**: 6378–6382.
- Dagher M.C. and Filhol-Cochet O. 1997. Making hybrids of two-hybrid systems. *BioTechniques* **22**: 916–922.
- Dalton S. and Treisman R. 1992. Characterization of SAP-1, a protein recruited by serum response factor to the *c-fos* serum response element. *Cell* **68**: 597–612.
- Dang C.V., Barrett J., Villa-Garcia M., Resar L.M.S., Kato G.J., and Fearon E.R. 1991. Intracellular leucine zipper interactions suggest *c-Myc* hetero-oligomerization. *Mol. Cell. Biol.* **11**: 954–962.
- Day R.N. 1998. Visualization of Pit-1 transcription factor interactions in the living cell nucleus by fluorescence resonance energy transfer microscopy. *Mol. Endocrinol.* **12**: 1410–1419.
- Dayel M.J., Hom E.F., and Verkman A.S. 1999. Diffusion of green fluorescent protein in the aqueous-phase lumen of endoplasmic reticulum. *Biophys. J.* **76**: 2843–2851.
- DeGraaf M.E., Miceli R.M., Mott J.E., and Fisher H.D. 1993. Biochemical diversity in a phage display library of random decapeptides. *Gene* **128**: 13–17.
- Deng S.-J., Bickett D.M., Mitchell I.L., Lambert M.H., Blackburn R.K., Carter III, H.L., Neugebauer J., Pahel G., Weiner M.P., and Moss M.L. 2000. Substrate specificity of human collagenase-3 assessed using a phage displayed peptide library. *J. Biol. Chem.* (in press).
- Devlin J.J., Panganiban L.C., and Devlin P.E. 1990. Random peptide libraries: A source of specific protein binding molecules. *Science* **249**: 404–406.
- Di Lallo G., Ghelardini P., and Paolozzi L. 1999. Two-hybrid assay: Construction of an *Escherichia coli* system to quantify homodimerization ability in vivo. *Microbiology* **145**: 1485–1490.
- Dmitrova M., Younes-Cauet G., Oertel-Buchheit P., Porte D., Schnarr M., and Granger-Schnarr M. 1998. A new LexA-based genetic system for monitoring and analyzing protein heterodimerization in *Escherichia coli*. *Mol. Gen. Genet.* **257**: 205–212.
- Dowell S.J., Romanowski P., and Diffley J.E. 1994. Interaction of Dbf4, the Cdc7 protein kinase regulatory subunit, with yeast replication origins in vivo. *Science* **265**: 1243–1246.
- Du W., Vidal M., Xie J.E., and Dyson N. 1996. RBF, a novel RB-related gene that regulates E2F activity and interacts with cyclin E in *Drosophila*. *Genes Dev.* **10**: 1206–1218.
- Duan D.R., Pause A., Burgess W.H., Aso T., Chen D.Y., Garrett K.P., Conaway R.C., Conaway J.W., Linehan W.M., and Klausner R.D. 1995. Inhibition of transcription elongation by the VHL tumor suppressor protein. *Science* **269**: 1402–1406.
- Dueñas M. and Borrebaeck C.A.K. 1994. Clonal selection and amplification of phage displayed antibodies by linking antigen recognition and phage replication. *Bio/Technology* **12**: 999–1002.
- Dunnwald M., Varshavsky A., and Johnsson N. 1999. Detection of transient in vivo interactions between substrate and transporter during protein translocation into the endoplasmic reticulum. *Mol. Biol. Cell* **10**: 329–344.
- Durfee T., Draper O., Zupan J., Conklin D.S., and Zambryski P.C. 1999. New tools for protein linkage mapping and general two-hybrid screening. *Yeast* **15**: 1761–1768.
- Durfee T., Becherer K., Chen P.L., Yeh S.H., Yang Y., Kilburn A.E., Lee W.H., and Elledge S.J. 1993. The retinoblastoma protein

- associates with the protein phosphatase type I catalytic subunit. *Genes Dev.* **7**: 555–569.
- Duttweiler H.M. 1996. A highly sensitive and non-lethal  $\beta$ -galactosidase plate assay for yeast. *Trends Genet.* **12**: 340–341.
- Einarson M.B. and Chao M.V. 1995. Regulation of Id1 and its association with basic helix-loop-helix proteins during nerve growth factor-induced differentiation of PC12 cells. *Mol. Cell. Biol.* **15**: 4175–4183.
- Enright A.J., Iliopoulos I., Kyripides N.C., and Ouzounis C.A. 1999. Protein interaction maps for complete genomes based on gene fusion events. *Nature* **402**: 86–90.
- Estojak J., Brent R., and Golemis E.A. 1995. Correlation of two-hybrid affinity data with *in vitro* measurements. *Mol. Cell. Biol.* **15**: 5820–5829.
- Fearon E.R., Finkel T., Gillison M.L., Kennedy S.P., Casella J.F., Tomaselli G.F., Morrow J.S., and Dang C.V. 1992. Karyoplasmic interaction selection strategy: A general strategy to detect protein-protein interactions in mammalian cells. *Proc. Natl. Acad. Sci.* **89**: 7958–7962.
- Felici F., Castagnoli L., Musacchio A., Jappelli R., and Cesareni G. 1991. Selection of antibody ligands from a large library of oligopeptides expressed on a multivalent exposition vector. *J. Mol. Biol.* **222**: 301–310.
- Fields S. and Song O. 1989. A novel genetic system to detect protein-protein interaction. *Nature* **340**: 245–246.
- Finley R. and Brent R. 1994. Interaction mating reveals binary and ternary connections between *Drosophila* cell cycle regulators. *Proc. Natl. Acad. Sci.* **91**: 12980–12984.
- Fisher R.J. and Fivash M. 1994. Surface plasmon resonance based methods for measuring the kinetics and binding affinities of biomolecular interactions. *Curr. Opin. Biotechnol.* **5**: 389–395.
- Fisher R.J., Fivash M., Casas-Finet J., Erickson J.W., Kondoh A., Bladen S.V., Fisher C., Watson D.K., and Papas T. 1994. Real-time DNA binding measurements of the ETS1 recombinant oncoproteins reveal significant kinetic differences between the p42 and p51 isoforms. *Protein Sci.* **3**: 257–266.
- Folgori A., Tafi R., Meola A., Felici F., Galfré G., Cortese R., Monaci P., and Nicosia A. 1994. A general strategy to identify mimotopes of pathological antigens using only random peptide libraries and human sera. *EMBO J.* **13**: 2236–2243.
- Fromont-Racine M., Rain J.-C., and Legrain P. 1997. Toward a functional analysis of the yeast genome through exhaustive two-hybrid screens. *Nat. Genet.* **16**: 277–282.
- Fujita A., Tonouchi A., Hiroko T., Inose F., Nagashima T., Satoh R., and Tanaka S. 1999. Hsl7p, a negative regulator of Ste20 p protein kinase in the *Saccharomyces cerevisiae* filamentous growth-signaling pathway. *Proc. Natl. Acad. Sci.* **96**: 8522–8527.
- Fuller K.J., Mors M.A., White J.H., Dowell S.J., and Sims M.J. 1998. Development of a yeast trihybrid screen using stable yeast strains and regulated protein expression. *BioTechniques* **25**: 85–92.
- Fusco C., Guidotti E., and Zervos A.S. 1999. *In vivo* construction of cDNA libraries for use in the yeast two-hybrid system. *Yeast* **15**: 715–720.
- Gadella T.W.J., Clegg R.M., and Jovin T.M. 1994. Fluorescence lifetime imaging microscopy: Pixel-by-pixel analysis of phase-modulation data. *Bioimaging* **2**: 139–159.
- Gadella T.W.J., Jovin T.M., and Clegg R.M. 1993. Fluorescence lifetime imaging microscopy (FLIM) — Spatial-resolution of microstructures on the nanosecond time-scale. *Biophys. Chem.* **48**: 221–239.
- Gallop M.A., Barrett R.W., Dower W.J., Fodor S.P.A., and Gordon E.M. 1994. Applications of combinatorial technologies to drug discovery. 1. Background and peptide combinatorial libraries. *J. Med. Chem.* **37**: 1233–1251.
- Geyer C.R., Colman-Lerner A., and Brent R. 1999. “Mutagenesis” by peptide aptamers identifies genetic network members and pathway connections. *Proc. Natl. Acad. Sci.* **96**: 8567–8572.
- Ginsberg D., Vairo G., Chittenden T., Xiao Z.X., Xu G., Wydner K.L., DeCaprio J.A., Lawrence J.B., and Livingston D.M. 1994. E2F-4, a new member of the E2F transcription factor family interacts with p107. *Genes Dev.* **8**: 2665–2679.
- Golemis E.A. and Brent R. 1992. Fused protein domains inhibit DNA binding by LexA. *Mol. Cell. Biol.* **12**: 3006–3014.
- Golemis E.A., Gyuris J., and Brent R. 1995. Interaction trap/two-hybrid system to identify interacting proteins. In *Current protocols in molecular biology* (ed. F.A. Ausubel et al.), pp. 20.1.1–20.1.28. Wiley, New York.
- Gordon E.M., Barrett R.W., Dower W.J., Fodor S.P.A., and Gallop M.A. 1994. Applications of combinatorial technologies to drug discovery. 2. Combinatorial organic synthesis, library screening strategies and future directions. *J. Med. Chem.* **37**: 1385–1401.
- Gordon G.W., Berry G., Liang X.H., Levine B., and Herman B. 1998. Quantitative fluorescence resonance energy transfer measurements using fluorescence microscopy. *Biophys. J.* **74**: 2702–2713.
- Gram H., Marconi L.A., Barbas III, C.F., Collet T.A., Lerner R.A., and Kang A.S. 1992. *In vitro* selection and affinity maturation of antibodies from a naive combinatorial immunoglobulin library. *Proc. Natl. Acad. Sci.* **89**: 3576–3580.
- Gramatikoff K., Georgiev O., and Schaffner W. 1994. Direct interaction rescue, a novel filamentous phage technique to study protein-protein interactions. *Nucleic Acids Res.* **22**: 5761–5762.
- Grant R.A., Lin T.C., Konigsberg W., and Webster R.E. 1981. Structure of the filamentous bacteriophage  $\phi$ 1. Location of the A, C, and D minor coat proteins. *J. Biol. Chem.* **256**: 539–546.
- Greenwood J., Willis A.E., and Perham R.N. 1991. Multiple display of foreign peptides on a filamentous bacteriophage. Peptides from *Plasmodium falciparum* circumsporozoite protein as antigens. *J. Mol. Biol.* **220**: 821–827.
- Grgurevich S., Mikhael A., and McVicar D.W. 1999. The Csk homologous kinase, Chk, binds tyrosine phosphorylated paxillin in human blastic T cells. *Biochem. Biophys. Res. Commun.* **256**: 668–675.
- Griffin A.B., Adams S.R., and Tsien R.Y. 1998. Specific covalent labeling of recombinant protein molecules inside live cells. *Science* **281**: 269–272.
- Grossel M.J., Wang H., Gadea B., Yeung W., and Hinds P.W. 1999. A yeast two-hybrid system for discerning differential interactions using multiple baits. *Nat. Biotechnol.* **17**: 1232–1233.
- Gyuris J., Golemis E.A., Chertkov H., and Brent R. 1993. Cdi1, a human G1 and S phase protein phosphatase that associates with Cdk2. *Cell* **75**: 791–803.
- Haaparanta T. and Huse W.D. 1995. A combinatorial method for constructing libraries of long peptides displayed by filamentous phage. *Mol. Divers.* **1**: 39–52.
- Harlow E. and Lane D. 1988. *Antibodies: A laboratory manual*. Cold Spring Harbor Laboratory, Cold Spring Harbor, New York.
- . 1999. *Using antibodies: A laboratory manual*. Cold Spring Harbor Laboratory Press, Cold Spring Harbor, New York.
- Hawkins R.E., Russell S.J., and Winter G. 1992. Selection of phage antibodies by binding affinity: Mimicking affinity maturation. *J. Mol. Biol.* **226**: 889–896.
- Heim R. and Tsien R.Y. 1996. Engineering green fluorescent pro-

- tein for improved brightness, longer wavelengths and fluorescence resonance energy transfer. *Curr. Biol.* **6**: 178–182.
- Hemenway C.S., Halligan B.W., and Gould G.C. 1999. A method to generate full-length cDNA molecules from yeast two-hybrid clones and RACE products. *Anal. Biochem.* **268**: 161–162.
- Hirt H. 1991. A novel method for in situ screening of yeast colonies with the  $\beta$ -glucuronidase reporter gene. *Curr. Genet.* **20**: 437–439.
- Hoess R.H. 1993. Phage display of peptides and protein domains. *Curr. Opin. Struct. Biol.* **3**: 572–579.
- Hoess R.H., Mack A.J., Walton H., and Reilly T.M. 1994. Identification of a structural epitope using a peptide library displayed on filamentous bacteriophage. *J. Immunol.* **153**: 724–729.
- Hollinger P. and Riechmann L. 1997. A conserved infection pathway for filamentous bacteriophages is suggested by the structure of the membrane penetration domain of the minor coat protein g3p from phage fd. *Structure* **5**: 265–275.
- Hoogenboom H.R., Griffiths A.D., Johnson K.S., Chiswell D.J., Hudson P., and Winter G. 1991. Multi-subunit proteins on the surface of filamentous phage: Methodologies for displaying antibody (Fab) heavy and light chains. *Nucleic Acids Res.* **19**: 4133–4137.
- Hope I.A. and Struhl K. 1986. Functional dissection of a eukaryotic transcriptional activator protein, GCN4 of yeast. *Cell* **46**: 885–894.
- Houghten R.A., Pinilla C., Blondell S.E., Appel J.R., Dooley C.T., and Cuervo J.H. 1991. Generation and use of synthetic peptide combinatorial libraries for basic research and drug discovery. *Nature* **354**: 84–86.
- Hu J.C. 1995. Repressor fusions as a tool to study protein-protein interactions. *Structure* **3**: 431–433.
- Hu J.C., O'Shea E.K., Kim P.S., and Sauer R.T. 1990. Sequence requirements for coiled-coils: Analysis with lambda repressor-GCN4 leucine zipper fusions. *Science* **250**: 1400–1403.
- Hu Q.J., Bautista C., Edwards G.M., Defeo-Jones D., Jones R.E., and Harlow E. 1991. Antibodies specific for the human retinoblastoma protein identify a family of related polypeptides. *Mol. Cell. Biol.* **11**: 5792–5799.
- Hua S.B., Luo Y., Qiu M., Chan E., Zhou H., and Zhu L. 1998. Construction of a modular yeast two-hybrid cDNA library from human EST clones for the human genome protein linkage map. *Gene* **215**: 143–152.
- Huang J. and Schreiber S.L. 1997. A yeast genetic system for selecting small molecule inhibitors of protein-protein interactions in nanodroplets. *Proc. Natl. Acad. Sci.* **94**: 13396–13401.
- Hudson Jr., J.R., Dawson E.P., Rushing K.L., Jackson C.H., Lockshon D., Conover D., Lanciault C., Harris J.R., Simmons S.L., Rothstein R., and Fields S. 1997. The complete set of predicted genes from *Saccharomyces cerevisiae* in a readily usable form. *Genome Res.* **7**: 1169–1173.
- Hunter S., Burton E.A., Wu S.C., and Anderson S.M. 1999. Fyn associates with Cbl and phosphorylates tyrosine 731 in Cbl, a binding site for phosphatidylinositol 3-kinase. *J. Biol. Chem.* **274**: 2097–2106.
- Ilyichev A.A., Minenkova O.O., Tat'kov S.I., Karpyshev N.N., Eroshkin A.M., Petrenko V.A., and Sandakhchiev L.S. 1989. Production of a viable variant of the M13 phage with a foreign peptide inserted into the basic coat protein. *Dokl. Akad. Nauk SSSR* **307**: 481–483.
- Ilyichev A.A., Minenkova O.O., Kishchenko G.P., Tat'kov S.I., Karpyshev N.N., Eroshkin A.M., Ofitserov V.I., Akimenko Z.A., Petrenko V.A., and Sandakhchiev L.S. 1992. Inserting foreign peptides into the major coat protein of bacteriophage M13. *FEBS Lett.* **301**: 322–324.
- Inouye C., Remondelli P., Karin M., and Elledge S. 1994. Isolation of a cDNA encoding a metal response element binding protein using a novel expression cloning procedure: The one hybrid system. *DNA Cell Biol.* **13**: 731–742.
- Inouye C., Dhillon N., Durfee T., Zambryski P.C., and Thorner J. 1997. Mutational analysis of STE5 in the yeast *Saccharomyces cerevisiae*: Application of a differential interaction trap assay for examining protein-protein interactions. *Genetics* **147**: 479–492.
- Iwai K., Yamanaka K., Kamura T., Minato N., Conaway R.C., Conaway J.W., Klausner R.D., and Pause A. 1999. Identification of the von Hippel-Lindau tumor-suppressor protein as part of an active E3 ubiquitin ligase complex. *Proc. Natl. Acad. Sci.* **96**: 12436–12441.
- James P., Halladay J., and Craig E.A. 1996. Genomic libraries and a host strain designed for highly efficient two-hybrid selection in yeast. *Genetics* **144**: 1425–1436.
- Jensen O.N., Wilm M., Shevchenko A., and Mann M. 1999. Peptide sequencing of 2D gel isolated nanoelectrospray tandem mass spectrometry. *Methods Mol. Biol.* **112**: 571–588.
- Jiang R. and Carlson M. 1996. Glucose regulates protein interactions within the yeast SNF1 protein kinase complex. *Genes Dev.* **10**: 3105–3115.
- Johnson K.S. and Chiswell D.J. 1993. Human antibody engineering. *Curr. Opin. Struct. Biol.* **3**: 564–571.
- Johnsson N. and Varshavsky A. 1994. Split ubiquitin as a sensor of proteins interactions in vivo. *Proc. Natl. Acad. Sci.* **91**: 10340–10344.
- Jonsson U., Fagerstam L., Ivarsson B., Johnsson B., Karlsson R., Lundh K., Lofas S., Persson B., Roos H., Ronnberg L., Sjolander S., Stenberg E., Sahlberg R., Urbaniczky C., Ostlin H., and Malmqvist M. 1991. Real-time biospecific interaction analysis using surface plasmon resonance and a sensor chip technology. *BioTechniques* **11**: 620–627.
- Joung J.K., Ramm E.L., and Pabo C.O. 2000. A bacterial two-hybrid selection system for studying protein-DNA and protein-protein interactions. *Proc. Natl. Acad. Sci.* **97**: 7382–7387.
- Kaelin Jr., W.G., Pallas D.C., DeCaprio J.A., Kaye F.J., and Livingston D.M. 1991. Identification of cellular proteins that can interact specifically with the T/E1A-binding region of the retinoblastoma gene product. *Cell* **64**: 521–532.
- Kaelin Jr., W.G., Krek W., Sellers W.R., DeCaprio J.A., Ajchenbaum E., Fuchs C.S., Chittenden T., Li Y., Farnham P.J., Blanas M.A., Livingston D.M., and Flemington E.K. 1992. Expression cloning of a cDNA encoding a retinoblastoma-binding protein with E2F-like properties. *Cell* **70**: 351–364.
- Kaiser C., Michaelis S., and Mitchell A. 1994. *Methods in yeast genetics: A laboratory course manual*. Cold Spring Harbor Laboratory Press, Cold Spring Harbor, New York.
- Kamada S., Kusano H., Fujita H., Ohtsu M., Koya R.C., Kuzumaki N., and Tsujimoto Y. 1998. A cloning method for caspase substrates that uses the yeast two-hybrid system: Cloning of the antiapoptotic gene gelsolin. *Proc. Natl. Acad. Sci.* **95**: 8532–8537.
- Kamo M. and Tsugita A. 1999. N-terminal amino acid sequencing of 2-DE spots. *Methods Mol. Biol.* **112**: 461–466.
- Kamura T., Conrad M.N., Yan Q., Conaway R.C., and Conaway J.W. 1999a. The Rbx1 subunit of SCF and VHL E3 ubiquitin ligase activates Rub1 modification of cullins Cdc53 and Cul2. *Genes Dev.* **13**: 2928–2933.
- Kamura T., Koepp D.M., Conrad M.N., Skowrya D., Moreland R.J., Iliopoulos O., Lane W.S., Kaelin Jr., W.G., Elledge S.J., Conaway R.C., Harper J.W., and Conaway J.W. 1999b. Rbx1, a component of the VHL tumor suppressor complex and

- SCF ubiquitin ligase. *Science* **284**: 657–661.
- Kang A.S., Barbas C.F., Janda K.D., Benkovic S.J., and Lerner R.A. 1991. Linkage of recognition and replication functions by assembling combinatorial Fab libraries along phage surfaces. *Proc. Natl. Acad. Sci.* **88**: 4363–4366.
- Karimova G., Pidoux J., Ullmann A., and Ladant D. 1998. A bacterial two-hybrid system based on a reconstituted signal transduction pathway. *Proc. Natl. Acad. Sci.* **95**: 5752–5756.
- Karlsson R. and Falt A. 1997. Experimental design for kinetic analysis of protein-protein interactions with surface plasmon resonance biosensors. *J. Immunol. Methods* **200**: 121–133.
- Karlsson R., Michaelsson A., and Mattsson L. 1991. Kinetic analysis of monoclonal antibody-antigen interactions with a new biosensor based analytical system. *J. Immunol. Methods* **145**: 229–240.
- Karlsson R., Fagerstam L., Nilshans H., and Persson B. 1993. Analysis of active antibody concentration. Separation of affinity and concentration parameters. *J. Immunol. Methods* **166**: 75–84.
- Kay B.K., Adey N.B., He Y.-S., Manfredi J.P., Mataragnon A.H., and Fowlkes D.M. 1993. An M13 phage library displaying random 38-amino acid peptides as a source of novel sequences with affinity to selected targets. *Gene* **128**: 59–65.
- Ke S.H., Coombs G.S., Tachias K., Corey D.R., and Madison E.L. 1997. Optimal sunsite occupancy and design of a selective inhibitor or urokinase. *J. Biol. Chem.* **272**: 20456–20462.
- Kibel A., Iliopoulos O., DeCaprio J.A., and Kaelin Jr., W.G. 1995. Binding of the von Hippel-Lindau tumor suppressor protein to Elongin B and C. *Science* **269**: 1444–1446.
- Klebanow E.R. and Weil P.A. 1999. A rapid technique for the determination of unknown plasmid library insert DNA sequence directly from intact yeast cells. *Yeast* **15**: 527–531.
- Kornacker M.G., Remsburg B., and Menzel R. 1998. Gene activation by the AraC protein can be inhibited by DNA looping between AraC and a LexA repressor that interacts with AraC: Possible applications as a two-hybrid system. *Mol. Microbiol.* **30**: 615–624.
- Kushwaha A., Choudhury P.S., Arora K., Abrol S., and Chaudhary V.K. 1994. Construction and characterization of M13 bacteriophages displaying functional IgG-binding domains of staphylococcal A protein. *Gene* **151**: 45–51.
- Kuster B. and Mann M. 1998. Identifying proteins and post-translational modifications by mass spectrometry. *Curr. Opin. Struct. Biol.* **8**: 393–400.
- Ladbury J.E., Lemmon M.A., Zhou M., Green J., Botfield M.C., and Schlessinger J. 1995. Measurement of the binding of tyrosyl phosphopeptides to SH2 domains: A reappraisal. *Proc. Natl. Acad. Sci.* **92**: 3199–3203.
- Lakowicz J.R. and Berndt K. 1991. Lifetime-selective fluorescence imaging using an rf phase-sensitive camera. *Rev. Sci. Instrum.* **62**: 1727–1734.
- Lazarides E. and Weber K. 1974. Actin antibody: The specific visualization of actin filaments in non-muscle cells. *Proc. Natl. Acad. Sci.* **71**: 2268–2272.
- Lee J.W., Choi H.S., Gyuris J., Brent R., and Moore D.D. 1995. Two classes of proteins dependent on either the presence or absence of thyroid hormone for interaction with the thyroid hormone receptor. *Mol. Endocrinol.* **9**: 243–254.
- Lee W.S., Kao C.C., Bryant G.O., Liu X., and Berk A.J. 1991. Adenovirus E1A activation domain binds the basic repeat in the TATA box transcription factor. *Cell* **67**: 365–376.
- Li J.J. and Herskowitz I. 1993. Isolation of ORC6, a component of the yeast origin recognition complex by a one-hybrid system. *Science* **262**: 1870–1874.
- Liberles S.D., Diver S.T., Austin D.J., and Schreiber S.L. 1997. Inducible gene expression and protein translocation using nontoxic ligands identified by a mammalian three-hybrid screen. *Proc. Natl. Acad. Sci.* **94**: 7825–7830.
- Licitra E.J. and Liu J.O. 1996. A three-hybrid system for detecting small ligand-protein receptor interactions. *Proc. Natl. Acad. Sci.* **93**: 12817–12821.
- Link A.J., ed. 1999. 2D proteome analysis protocols. *Methods Mol. Biol.*, vol. 112.
- Lisztwan J., Imbert G., Wirbelauer C., Gstaiger M., and Krek W. 1999. The von Hippel-Lindau tumor suppressor protein is a component of an E3 ubiquitin-protein ligase activity. *Genes Dev.* **13**: 1822–1833.
- Llopis J., McCaffery J.M., Miyawaki A., Farquhar M.G., and Tsien R.Y. 1998. Measurement of cytosolic, mitochondrial, and Golgi pH in single living cells with green fluorescent proteins. *Proc. Natl. Acad. Sci.* **95**: 6803–6808.
- Lonergan K.M., Iliopoulos O., Ohh M., Kamura T., Conaway R.C., Conaway J.W., and Kaelin Jr., W.G. 1998. Regulation of hypoxia-inducible mRNAs by the von Hippel-Lindau tumor suppressor protein requires binding to complexes containing elongins B/C and Cul2. *Mol. Cell. Biol.* **18**: 732–741.
- Loo J.A. and Muenster H. 1999. Magnetic sector-ion trap mass spectrometry with electrospray ionization for high sensitivity peptide sequencing. *Rapid Commun. Mass Spectrom.* **13**: 54–60.
- Lowman H.B., Bass S.H., Simpson N., and Wells J.A. 1991. Selecting high-affinity binding proteins by monovalent phage display. *Biochemistry* **30**: 10832–10838.
- Lubkowski J., Hennecke F., Pluckthun A., and Wlodawer A. 1998. The structural basis of phage display elucidated by the crystal structure of the N-terminal domains of g3p. *Nat. Struct. Biol.* **5**: 140–147.
- Luo Y., Batalao A., Zhou H., and Zhu L. 1997. Mammalian two-hybrid system: A complementary approach to the yeast two-hybrid system. *BioTechniques* **22**: 350–352.
- Luo Y., Vijaychander S., Stile J., and Zhu L. 1996. Cloning and analysis of DNA-binding proteins by yeast one-hybrid and one-two-hybrid systems. *BioTechniques* **20**: 564–568.
- Macgregor P.F., Abate C., and Curran T. 1990. Direct cloning of leucine zipper proteins: Jun binds cooperatively to the CRE with CRE-BP1. *Oncogene* **5**: 451–458.
- Mahajan N.P., Harrison-Shostak D.C., Michaux J., and Herman B. 1999. Novel mutant green fluorescent protein protease substrates reveal the activation of specific caspases during apoptosis. *Chem. Biol.* **6**: 401–409.
- Mahajan N.P., Linder K., Berry G., Gordon G.W., Heim R., and Herman B. 1998. Bcl-2 and bax interactions in mitochondria probed with green fluorescent protein and fluorescence energy transfer. *Nat. Biotechnol.* **16**: 547–552.
- Mancini A., Niedenthal R., Joos H., Koch A., Trouliaris S., Niemann H., and Tamura T. 1997. Identification of a second Grb2 binding site in the v-Fms tyrosine kinase. *Oncogene* **15**: 1565–1572.
- Marcotte E.M., Pellegrini M., Ng H.L., Rice D.W., Yeates T.O., and Eisenberg D. 1999. Detecting protein function and protein-protein interactions from genome sequences. *Science* **285**: 751–753.
- Marin M.C., Jost C.A., Irwin M.S., DeCaprio J.A., Caput D., and Kaelin Jr., W.G. 1998. Viral oncoproteins discriminate between p53 and the p53 homolog p73. *Mol. Cell. Biol.* **18**: 6316–6324.
- Marsolier M.C. and Sentenac A. 1999. RNA polymerase III-based two-hybrid system. *Methods Enzymol.* **303**: 411–422.
- Marsolier M.C., Prioleau M.N., and Sentenac A. 1997. A RNA poly-

- merase III-based two-hybrid system to study RNA polymerase II transcriptional regulators. *J. Mol. Biol.* **268**: 243–249.
- Marvin D.A. 1990. Model-building studies of Inovirus: Genetic variations on a geometric theme. *Int. J. Biol. Macromol.* **12**: 125–138.
- Marykwas D.L. and Passmore S.E. 1995. Mapping by multifragment cloning in vivo. *Proc. Natl. Acad. Sci.* **92**: 11701–11705.
- Matsudaira P., ed. 1993. *A practical guide to protein and peptide purification for microsequencing*. Academic Press, San Diego, California.
- Matsui N.M., Smith-Beckerman D.M., and Epstein L.B. 1999. Staining of preparative 2D gels. *Methods Mol. Biol.* **112**: 307–311.
- Matz M.V., Fradkov A.F., Labas Y.A., Savitsky A.P., Zaraisky A.G., Markelov M.L., and Lukyanov S.A. 1999. Fluorescent proteins from nonbioluminescent Anthozoa species. *Nat. Biotechnol.* **17**: 969–973.
- Mayer G., Launhardt H., and Munder T. 1999. Application of the green fluorescent protein as a reporter for AceI-based, two-hybrid studies. *BioTechniques* **27**: 86–94.
- McCafferty J., Jackson R.H., and Chiswell D.J. 1991. Phage-enzymes: Expression and affinity chromatography of functional alkaline phosphatase on the surface of bacteriophage. *Protein Eng.* **4**: 955–961.
- McCafferty J., Griffiths A.D., Winter G., and Chiswell D.J. 1990. Phage antibodies: Filamentous phage displaying antibody variable domains. *Nature* **348**: 552–554.
- McConnell S.J. and Hoess R.H. 1995. Tendamistat as a scaffold for conformationally constrained phage peptide libraries. *J. Mol. Biol.* **250**: 460–470.
- McDonald O.B., Chen W.J., Ellis B., Hoffman C., Overton L., Rink M., Smith A., Marshall C.J., and Wood E.R. 1999. A scintillation proximity assay for the Raf/MEK/ERK kinase cascade: High-throughput screening and identification of selective enzyme inhibitors. *Anal. Biochem.* **268**: 318–329.
- McCafferty M.A., Kent R.B., Ladner R.C., and Markland W. 1993. M13 bacteriophage displaying disulfide-constrained microproteins. *Gene* **128**: 29–36.
- McMahon S.B., Van Buskirk H.A., Dugan K.A., Copeland T.D., and Cole M.D. 1998. The novel ATM-related protein TRRAP is an essential cofactor for the c-Myc and E2F oncoproteins. *Cell* **94**: 363–374.
- Mitra R.D., Silva C.M., and Youvan D.C. 1996. Fluorescence resonance energy transfer between blue-emitting and red-shifted excitation derivatives of the green fluorescent protein. *Gene* **173**: 13–17.
- Miyawaki A., Griesbeck O., Heim R., and Tsien R.Y. 1999. Dynamic and quantitative  $Ca^{2+}$  measurements using improved cameleons. *Proc. Natl. Acad. Sci.* **6**: 2135–2140.
- Miyawaki A., Llopis J., Heim R., McCafferty J.M., Adams J.A., Ikura M., and Tsien R.Y. 1997. Fluorescent indicators for  $Ca^{2+}$  based on green fluorescent proteins and calmodulin. *Nature* **388**: 882–887.
- Model P. and Russel M. 1988. Filamentous bacteriophage. In *The bacteriophages* (ed. R. Calendar), vol. 2, pp. 375–456. Plenum Press, New York.
- Moon R.T. and Lazarides E. 1983. Synthesis and post-translational assembly of intermediate filaments in avian erythroid cells: Vimentin assembly limits the rate of synemin assembly. *Proc. Natl. Acad. Sci.* **80**: 5495–5499.
- Morgan H. and Taylor D.M. 1992. A surface plasmon resonance immunosensor based on the streptavidin-biotin complex. *Biosens. Bioelectron.* **7**: 405–410.
- Moss J.B., Price A.L., Raz E., Driever W., and Rosenthal N. 1996. Green fluorescent protein marks skeletal muscle in murine cell lines and zebrafish. *Gene* **173**: 89–98.
- Muller K.M., Arndt K.M., and Pluckthun A. 1998. Model and simulation of multivalent binding to fixed ligands. *Anal. Biochem.* **261**: 149–158.
- Myszka D.G. 1999. Improving biosensor analysis. *J. Mol. Recognit.* **12**: 1–6.
- Myszka D.G., Jonsen M.D., and Graves B.J. 1998a. Equilibrium analysis of high affinity interactions using BIACORE. *Anal. Biochem.* **265**: 326–330.
- Myszka D.G., He X., Dembo M., Morton T.A., and Goldstein B. 1998b. Extending the range of rate constants available from BIACORE: Interpreting mass transport-influenced binding data. *Biophys. J.* **75**: 583–594.
- Natesan S., Molinari E., Rivera V.M., Rickles R.J., and Gilman M. 1999. A general strategy to enhance the potency of chimeric transcriptional activators. *Proc. Natl. Acad. Sci.* **96**: 13898–13903.
- Naya F.J., Stellrecht C.M.M., and Tsai M.-J. 1995. Tissue-specific regulation of the insulin gene by a novel basic helix-loop-helix transcription factor. *Genes Dev.* **9**: 1009–1019.
- Needels M.C., Jones D.G., Tate E.H., Heinkel G.L., Kochersperger L.M., Dower W.J., Barrett R.W., and Gallop M.A. 1993. Generation and screening of an oligonucleotide-encoded synthetic peptide library. *Proc. Natl. Acad. Sci.* **90**: 10700–10704.
- Ng T., Squire A., Hansra G., Bornancin E., Prevostel C., Hanby A., Harris W., Barnes D., Schmidt S., Mellor H., Bastiaens P.I.H., and Parker P.J. 1999. Imaging protein kinase C alpha activation in cells. *Science* **283**: 2085–2089.
- Nieba L., Krebber A., and Pluckthun A. 1996. Competition BIACore for measuring true affinities: Large differences from values determined from binding kinetics. *Anal. Biochem.* **234**: 155–165.
- Nieba L., Nieba-Axmann S.E., Persson A., Hamalainen M., Edebratt F., Hansson A., Lidholm J., Magnusson K., Karlsson A.F., and Pluckthun A. 1997. BIACORE analysis of histidine-tagged proteins using a chelating NTA sensor chip. *Anal. Biochem.* **252**: 217–228.
- Niwa Y., Hirano T., Yoshimoto K., Shimizu M., and Kobayashi H. 1999. Non-invasive quantitative detection and applications of non-toxic, S65T-type green fluorescent protein in living plants. *Plant J.* **18**: 455–463.
- Nord K., Nilsson J., Nilsson B., Uhlén M., and Nygren P.A. 1995. A combinatorial library of an alpha-helical bacterial receptor domain. *Protein Eng.* **8**: 601–608.
- Norman T.C., Smith D.L., Sorger P.K., Drees B.L., O'Rourke S.M., Hughes T.R., Roberts C.J., Friend S.H., Fields S., and Murray A.W. 1999. Genetic selection of peptide inhibitors of biological pathways. *Science* **285**: 591–595.
- Ohh M. and Kaelin Jr., W.G. 1999. The von Hippel-Lindau tumour suppressor protein: New perspectives. *Mol. Med. Today* **5**: 257–263.
- Ohh M., Yauch R.L., Lonergan K.M., Whaley J.M., Stemmer-Rachamimov A.O., Louis D.N., Gavin B.J., Kley N., Kaelin Jr., W.G., and Iliopoulos O. 1998. The von Hippel-Lindau tumor suppressor protein is required for proper assembly of an extracellular fibronectin matrix. *Mol. Cell* **1**: 959–968.
- Okada A., Lansford R., Weimann J.M., Fraser S.E., and McConnell S.K. 1999. Imaging cells in the developing nervous system with retrovirus expressing modified green fluorescent protein. *Exp. Neurol.* **156**: 394–406.
- Orlinick J.R. and Chao M.V. 1996. Interactions of the cellular polypeptides with the cytoplasmic domain of the mouse Fas antigen. *J. Biol. Chem.* **271**: 8627–8632.

- Osborne M., Dalton S., and Kochan J.P. 1995. The yeast tribrid system: Genetic detection of *trans*-phosphorylated ITAM-SH2 interactions. *Bio/Technology* **13**: 1474–1478.
- Osborne M.A., Zenner G., Lubinus M., Zhang X., Songyang Z., Cantley L.C., Majerus P., Burn P., and Kochan J.P. 1996. The inositol 5'-phosphatase SHIP binds to immunoreceptor signaling motifs and responds to high affinity IgE receptor aggregation. *J. Biol. Chem.* **271**: 29271–29278.
- O'Shannessy D.J., Brigham-Burke M., and Peck K. 1992. Immobilization chemistries suitable for use in the BIAcore surface plasmon resonance detector. *Anal. Biochem.* **205**: 132–136.
- O'Shannessy D.J., Brigham-Burke M., Soneson K.K., Hensley P., and Brooks I. 1993. Determination of rate and equilibrium binding constants for macromolecular interactions using surface plasmon resonance: Use of nonlinear least squares analysis methods. *Anal. Biochem.* **212**: 457–468.
- Pannekoek H., van Meijer M., Schleeff R.R., Loskutoff D.J., and Barbas III, C.F. 1993. Functional display of human plasminogen activator-inhibitor 1 (PAI-1) on phages: Novel perspectives for structure-function analysis by error-prone DNA synthesis. *Gene* **128**: 129–134.
- Park Y.W., Tan S.L., and Katze M.G. 1999a. Differential sensitivity to 5-fluoro-orotic acid as a screen for bait RNA-independent false positives in a yeast three-hybrid system. *BioTechniques* **26**: 1102–1106.
- Park Y.W., Wilusz J., and Katze M.G. 1999b. Regulation of eukaryotic protein synthesis: Selective influenza viral mRNA translation is mediated by the cellular RNA-binding protein GRSF-1. *Proc. Natl. Acad. Sci.* **96**: 6694–6699.
- Parmley S.F. and Smith G.P. 1988. Antibody-selectable filamentous fd phage vectors: Affinity purification of target genes. *Gene* **73**: 305–318.
- Pause A., Peterson B., Schaffar G., Stearman R., and Klausner R.D. 1999. Studying interactions of four proteins in the yeast two-hybrid system: Structural resemblance of the pVHL/elongin BC/hCUL-2 complex with the ubiquitin ligase complex SKP1/cullin/F-box protein. *Proc. Natl. Acad. Sci.* **96**: 9533–9538.
- Pause A., Lee S., Worrell R.A., Chen D.Y., Burgess W.H., Linehan W.M., and Klausner R.D. 1997. The von Hippel-Lindau tumor-suppressor gene product forms a stable complex with human CUL-2, a member of the Cdc53 family of proteins. *Proc. Natl. Acad. Sci.* **94**: 2156–2161.
- Pellequer J.L. and Van Regenmortel M.H. 1993. Measurement of kinetic binding constants of viral antibodies using a new biosensor technology. *J. Immunol. Methods* **166**: 133–143.
- Pepperkok R., Saffrich R., and Ansorge W. 1998. Computer-automated and semiautomated capillary microinjection of macromolecules into living cells. In *Cell biology: A laboratory handbook*, 2nd edition (ed. J.E. Celis), vol. 4, pp. 23–30. Academic Press, New York.
- Petermann R., Mossier B.M., Aryee D.N., and Kovar H. 1998. A recombination based method to rapidly assess specificity of two-hybrid clones in yeast. *Nucleic Acids Res.* **26**: 2252–2253.
- Peters E.A., Schatz P.J., Johnson S.S., and Dower W.J. 1994. Membrane insertion defects caused by positive charges in the early mature region of protein pIII of filamentous phage fd can be corrected by *prlA* suppressors. *J. Bacteriol.* **176**: 4296–4305.
- Petrenko V.A., Smith G.P., Gong X., and Quinn T. 1996. A library of organic landscapes on filamentous phage. *Protein Eng.* **9**: 797–801.
- Phizicky E.M. and Fields S. 1995. Protein-protein interactions: Methods for detection and analysis. *Microbiol. Rev.* **59**: 94–123.
- Place J.F., Sutherland R.M., and Dahne C. 1985. Opto-electronic immunosensors: A review of optical immunoassay at continuous surfaces. *Biosensors* **1**: 321–353.
- Pollok B.A. and Heim R. 1999. Using GFP in FRET-based applications. *Trends Cell Biol.* **9**: 57–60.
- Posern G., Zheng J., Knudsen B.S., Kardinal C., Muller K.B., Voss J., Sishido T., Cowburn D., Cheng G., Wang B., Kruh G.D., Burrell S.K., Jacobson C.A., Lenz D.M., Zamborelli T.J., Adermann K., Hanafusa H., and Feller S.M. 1998. Development of highly selective SH3 binding peptides for Crk and CRKL which disrupt Crk-complexes with DOCK180, SoS, and C3G. *Oncogene* **16**: 1903–1912.
- Prasher D.C., Eckenrode V.K., Ward W.W., and Prendergast F.G. 1992. Primary structure of the *Aequorea victoria* green-fluorescent protein. *Gene* **111**: 229–233.
- Pratt D., Tzagoloff H., and Beaudoin J. 1969. Conditional lethal mutants of the small filamentous coliphage M13. II. Two genes for coat proteins. *Virology* **39**: 42–53.
- Press W.H., Flannery B.P., Teukolky S.A., and Vetterling W.T. 1990. *Numerical recipes in C: The art of scientific computing*. Academic Press, Cambridge, Massachusetts.
- Putz U., Skehel P., and Kuhl D. 1996. A tri-hybrid system for the analysis and detection of RNA-protein interactions. *Nucleic Acids Res.* **24**: 4838–4840.
- Rader C. and Barbas III, C.F. 1997. Phage display of combinatorial antibody libraries. *Curr. Opin. Biotechnol.* **8**: 503–508.
- Raut S., Weller L., and Barrowcliffe T.W. 1999. Phospholipid binding of factor VIII in different therapeutic concentrates. *Br. J. Haematol.* **107**: 323–329.
- Rebar E.J. and Pabo C.O. 1994. Zinc phage finger: Affinity selection of fingers with new DNA-binding specificities. *Science* **263**: 671–673.
- Reidhaar-Olson J.F., Bowie J.U., Breyer R.M., Hu J.C., Knight K.L., Lim W.A., Mossing M.C., Parsell D.A., Shoemaker K.R., and Sauer R.T. 1991. Random mutagenesis of protein sequences using oligonucleotide cassettes. *Methods Enzymol.* **208**: 564–586.
- Rigaut G., Shevchenko A., Rutz B., Wilm M., Mann M., and Seraphin B. 1999. A generic protein purification method for protein complex characterization and proteome exploration. *Nat. Biotechnol.* **17**: 1030–1032.
- Roberts B.L., Markland W., Siranosian K., Saxena M.J., Guterman S.K., and Ladner R.C. 1992a. Protease inhibitor display M13 phage: Selection of high-affinity neutrophil elastase inhibitors. *Gene* **121**: 9–15.
- Roberts B.L., Markland W., Ley A.C., Kent R.B., White D.W., Guterman S.K., and Ladner R.C. 1992b. Directed evolution of a protein: Selection of potent neutrophil elastase inhibitors displayed on M13 fusion phage. *Proc. Natl. Acad. Sci.* **89**: 2429–2433.
- Roden L.D. and Myszkowski D.G. 1996. Global analysis of a macromolecular interaction measured on BIAcore. *Biochem. Biophys. Res. Commun.* **225**: 1073–1077.
- Roder K.H., Wolf S.S., and Schweizer M. 1996. Refinement of vectors for use in the yeast two-hybrid system. *Anal. Biochem.* **241**: 260–262.
- Rodi D.J. and Makowski L. 1999. Phage-display technology — Finding a needle in a vast molecular haystack. *Curr. Opin. Biotechnol.* **10**: 87–93.
- Ron D. and Dressler H. 1992. PGSTag — A versatile bacterial expression plasmid for enzymatic labeling of recombinant proteins. *BioTechniques* **13**: 866–869.
- Rossi F., Charlton C.A., and Blau H.M. 1997. Monitoring protein-

- protein interactions in intact eukaryotic cells by  $\beta$ -galactosidase complementation. *Proc. Natl. Acad. Sci.* **94**: 8405–8410.
- Russel M. 1991. Filamentous phage assembly. *Mol. Microbiol.* **5**: 1607–1613.
- Saenko E., Sarafanov A., Greco N., Shima M., Loster K., Schwinn H., and Josic D. 1999. Use of surface plasmon resonance for studies of protein-protein and protein-phospholipid membrane interactions. Application to the binding of factor VIII to von Willebrand factor and to phosphatidylserine-containing membranes. *J. Chromatogr. A* **852**: 59–71.
- Saggio I., Gloaguen I., and Laufer R. 1995. Functional phage display of ciliary neurotrophic factor. *Gene* **152**: 35–39.
- Schatz P.J. 1994. Construction and screening of biological peptide libraries. *Curr. Opin. Biotechnol.* **5**: 487–494.
- Schiestl R.H. and Gietz R.D. 1989. High efficiency transformation of intact yeast cells using single stranded nucleic acids as a carrier. *Curr. Genet.* **16**: 339–346.
- Schuck P., Millar D.B., and Kortt A.A. 1998. Determination of binding constants by equilibrium titration with circulating sample in a surface plasmon resonance biosensor. *Anal. Biochem.* **265**: 79–91.
- Schwartz H., Alvarez C.P., White M.B., and Fields S. 1998. Mutation detection by a two-hybrid assay. *Hum. Mol. Genet.* **7**: 1029–1032.
- Scott J.K. and Barbas III, C.F. 2001. Phage-display vectors. In *Phage display: A laboratory manual* (eds. C.F. Barbas III et al.), pp. 2.1–2.19. Cold Spring Harbor Laboratory Press, Cold Spring Harbor, New York.
- Scott J.K. and Smith G.P. 1990. Searching for peptide ligands with an epitope library. *Science* **249**: 386–390.
- SenGupta D.J., Wickens M., and Fields S. 1999. Identification of RNAs that bind to a specific protein using the yeast three-hybrid system. *RNA* **5**: 596–601.
- SenGupta D.J., Zhang B., Kraemer B., Pochart P., Fields S., and Wickens M. 1996. A three-hybrid system to detect RNA-protein interactions in vivo. *Proc. Natl. Acad. Sci.* **93**: 8496–8501.
- Serebriiskii I., Khazak V., and Golemis E.A. 1999. A two-hybrid dual bait system to discriminate specificity of protein interactions. *J. Biol. Chem.* **274**: 17080–17087.
- Serebriiskii I., Estojak J., Berman M., and Golemis E. 2000. Approaches to detecting false positives in yeast two-hybrid systems. *BioTechniques* **28**: 328–336.
- Shih H.M., Goldman P.S., DeMaggio A.J., Hollenberg S.M., Goodman R.H., and Hoekstra M.F. 1996. A positive genetic selection for disrupting protein-protein interactions: Identification of CREB mutations that prevent association with the coactivator CBP. *Proc. Natl. Acad. Sci.* **93**: 13896–13901.
- Siolander S. and Urbaniczky C. 1991. Integrated fluid handling system for biomolecular interaction analysis. *Anal. Chem.* **63**: 2338–2345.
- Skolnick E.Y., Margolis B., Mohammadi M., Lowenstein E., Fischer R., Drepps A., Ullrich A., and Schlessinger J. 1991. Cloning of PI3 kinase associated p85 utilizing a novel method for expression/cloning of target proteins for receptor tyrosine kinases. *Cell* **65**: 83–90.
- Smith D.B. and Johnson K.S. 1988. Single-step purification of polypeptides expressed in *Escherichia coli* as fusions with glutathione-S-transferase. *Gene* **67**: 31–40.
- Smith G.P. 1985. Filamentous fusion phage: Novel expression vectors that display cloned antigens on the virion surface. *Science* **228**: 1315–1317.
- Smith G.P. 1993. Surface display and peptide libraries. *Gene* **128**: 1–2.
- Smith G.P. and Petrenko V.A. 1997. Phage display. *Chem. Rev.* **97**: 391–410.
- Smith M.M., Shi L., and Navre M. 1995. Rapid identification of highly active and selective substrates for stromelysin and matrilysin using bacteriophage peptide display libraries. *J. Biol. Chem.* **270**: 6440–6449.
- Spector D.L., Goldman R.D., and Leinwand L.A. 1998. *Cells: A laboratory manual*, vols. 1–4. Cold Spring Harbor Laboratory Press, Cold Spring Harbor, New York.
- Stagljar I., Bourquin J.P., and Schaffner W. 1996. Use of the two-hybrid system and random sonicated DNA to identify the interaction domain of a protein. *BioTechniques* **21**: 430–432.
- Stagljar I., Korostensky C., Johnsson N., and te Heesen S. 1998. A genetic system based on split-ubiquitin for the analysis of interactions between membrane proteins in vivo. *Proc. Natl. Acad. Sci.* **95**: 5187–5192.
- Sun Y., Liu X., Ng-Easton E., Lodish H.F., and Weinberg R.A. 1999. SnoN and Ski protooncoproteins are rapidly degraded in response to transforming growth factor  $\beta$  signaling. *Proc. Natl. Acad. Sci.* **96**: 12442–12447.
- Swimmer C., Lehar S.M., McCafferty J., Chiswell D.J., Blattler W.A., and Guild B.C. 1992. Phage display of ricin B chain and its single binding domains: System for screening galactose-binding mutants. *Proc. Natl. Acad. Sci.* **89**: 3756–3760.
- Sytsma J., Vroom J.M., Degrauw C.J., and Gerritsen H.C. 1998. Time-gated fluorescence lifetime imaging and microvolume spectroscopy using two-photon excitation. *J. Microsc.* **191**: 39–51.
- Tirode F., Malaguti C., Romero F., Attar R., Camonis J., and Egly J.M. 1997. A conditionally expressed third partner stabilizes or prevents the formation of a transcriptional activator in a three-hybrid system. *J. Biol. Chem.* **272**: 22995–22999.
- Tomashek J.J., Sonnenburg J.L., Artimovich J.M., and Klionsky D.J. 1996. Resolution of subunit interactions and cytoplasmic subcomplexes of the yeast vacuolar proton-translocating ATPase. *J. Biol. Chem.* **271**: 10397–10404.
- Tsien R.Y. 1998. The green fluorescent protein. *Annu. Rev. Biochem.* **67**: 509–544.
- Tyers M. and Willems A.R. 1999. One ring to rule a superfamily of E3 ubiquitin ligases. *Science* **284**: 601–604.
- Uetz P., Giot L., Cagney G., Mansfield T.A., Judson R.S., Knight J.R., Lockshon D., Narayan V., Srinivasan M., Pochart P., Qureshi-Emili A., Li Y., Godwin B., Conover D., Kalbfleish T., Vijayadmodar G., Yang M., Johnston M., Fields S., and Rothberg J.M. 2000. A comprehensive analysis of protein-protein interactions in *Saccharomyces cerevisiae*. *Nature* **403**: 623–627.
- Ullmann A., Jacob F., and Monod J. 1967. Characterization by *in vitro* complementation of a peptide corresponding to an operator-proximal segment of the  $\beta$ -galactosidase structural gene of *Escherichia coli*. *J. Mol. Biol.* **24**: 339–343.
- Vairo G., Livingston D.M., and Ginsberg D. 1995. Functional interaction between E2F-4 and p130: Evidence for distinct mechanisms underlying growth suppression by different retinoblastoma protein family members. *Genes Dev.* **9**: 869–881.
- Van Crielinghe W., van Gurp M., Decoster E., Schotte P., Van de Craen M., Fiers W., Vandenaabeele P., and Beyaert R. 1998. Use of the yeast three-hybrid system as a tool to study caspases. *Anal. Biochem.* **263**: 62–66.
- van Meijer M., Roelofs Y., Neels J., Horrevoets A.J., van Zonnefeld A.J., and Pannekoek H. 1996. Selective screening of a large phage display library of plasminogen activator inhibitor 1 mutants to localize interaction sites with either thrombin or the variable region of tissue-type plasminogen activator. *J. Biol. Chem.* **271**: 7423–7428.



- Vasavada H.A., Ganguly S., Germino F.J., Wang Z.X., and Weissman S.M. 1991. A contingent replication assay for the detection of protein-protein interactions in animal cells. *Proc. Natl. Acad. Sci.* **88**: 10686–10690.
- Verhaar M.J., Chester K.A., Keep P.A., Robson L., Pedley R.B., Boden J.A., Hawkins R.E., and Begent R.H. 1995. A single chain Fv derived from a filamentous phage library has distinct tumor targeting advantages over one derived from a hybridoma. *Int. J. Cancer* **61**: 497–501.
- Vidal M., Brachmann R.K., Fattaey A., Harlow E., and Boeke J.D. 1996a. Reverse two-hybrid and one-hybrid systems to detect dissociation of protein-protein and DNA-protein interactions. *Proc. Natl. Acad. Sci.* **93**: 10315–10320.
- Vidal M., Braun P., Chen E., Boeke J.D., and Harlow E. 1996b. Genetic characterization of a mammalian protein-protein interaction domain by using a yeast reverse two-hybrid system. *Proc. Natl. Acad. Sci.* **93**: 10321–10326.
- Vojtek A.B., Hollenberg S.M., and Cooper J.A. 1993. Mammalian Ras interacts directly with the serine/threonine kinase Raf. *Cell* **74**: 205–214.
- Walhout A.J. and Vidal M. 1999. A genetic strategy to eliminate self-activator baits prior to high-throughput yeast two-hybrid screens. *Genome Res.* **9**: 1128–1134.
- Walhout A.J., Sordella R., Lu X., Hartley J.L., Temple G.F., Brasch M.A., Thierry-Mieg N., and Vidal M. 2000. Protein interaction mapping in *C. elegans* using proteins involved in vulval development. *Science* **287**: 116–122.
- Wang M.M. and Reed R.R. 1993. Molecular cloning of the olfactory neuronal transcription factor Olf-1 by genetic selection in yeast. *Nature* **364**: 121–126.
- Wang Z.F., Whitfield M.L., Ingledue III, T.C., Dominski Z., and Marzluff W.F. 1996. The protein that binds the 3' end of histone mRNA: A novel RNA-binding protein required for histone pre-mRNA processing. *Genes Dev.* **10**: 3028–3040.
- Watson M.A., Buckholz R., and Weiner M.P. 1996. Vectors encoding alternative antibiotic resistance for use in the yeast two-hybrid system. *BioTechniques* **21**: 255–259.
- Weber E., Roth K.A., and Barchas J.D. 1982. Immuno-histochemical distribution of alpha-neo-endorphin/dynorphin neuronal systems in rat brain: Evidence for colocalization. *Proc. Natl. Acad. Sci.* **79**: 3062–3066.
- Weiner M.P. 1998. Use of a high-throughput yeast two-hybrid system in a pharmaceutical setting. In *Exploiting yeast molecular biology for therapeutics*. Cambridge Healthtech Institute, Orlando, Florida.
- Wilkins M.R., Gasteiger E., Bairoch A., Sanchez J.-C., Williams K.L., Appel R.D., and Hochstrasser D.F. 1999. Protein identification and analysis tools in the ExPASy server. *Methods Mol. Biol.* **112**: 531–552.
- Willis A.E., Perham R.N., and Wraith D. 1993. Immunological properties of foreign peptides in multiple display on a filamentous bacteriophage. *Gene* **128**: 79–83.
- Wilson T.E., Fahrner T.J., Johnston M., and Milbrandt J. 1991. Identification of the DNA binding site for NGFI-B by genetic selection in yeast. *Science* **252**: 1296–1300.
- Winter G., Griffiths A.D., Hawkins E., and Hoogenboom H.R. 1994. Making antibodies by phage display technology. *Annu. Rev. Immunol.* **12**: 433–455.
- Wolf S.S., Roder K., and Schweizer M. 1996. Construction of a reporter plasmid that allows expression libraries to be exploited for the one-hybrid system. *BioTechniques* **20**: 568–574.
- Wouters F.S. and Bastiaens P.I.H. 1999. Fluorescence lifetime imaging of receptor tyrosine kinase activity in cells. *Curr. Biol.* **9**: 1127–1130.
- Wouters F.S., Bastiaens P.I.H., Wirtz K.W.A., and Jovin T.M. 1998. FRET microscopy demonstrates molecular association of non-specific lipid transfer protein (nsL-TP) with fatty acid oxidation enzymes in peroxisomes. *EMBO J.* **17**: 7179–7189.
- Wrighton N.C., Farrell F.X., Chang R., Kashyap A.K., Barbone F.P., Mulcahy L.S., Johnson D.L., Barrett R.W., Jolliffe L.K., and Dower W.J. 1996. Small peptides as potent mimetics of the protein hormone erythropoietin. *Science* **273**: 458–463.
- Wu J.Y., Newton S., Judd A., Stocker B., and Robinson W.S. 1989. Expression of immunogenic epitopes of hepatitis B surface antigen with hybrid flagellin proteins by a vaccine strain of *Salmonella*. *Proc. Natl. Acad. Sci.* **86**: 4726–4730.
- Xiong Y., Zhang H., and Beach D. 1992. D type cyclins associate with multiple protein kinases and the DNA replication and repair factor PCNA. *Cell* **71**: 505–514.
- Xiong Y., Hannon G.J., Zhang H., Casso D., Kobayashi R., and Beach D. 1993. p21 is a universal inhibitor of cyclin kinases. *Nature* **366**: 701–704.
- Xu C.W., Mendelsohn A.R., and Brent R. 1997. Cells that register logical relationships among proteins. *Proc. Natl. Acad. Sci.* **94**: 12473–12478.
- Xu X., Gerard A.L., Huang B.C., Anderson D.C., Payan D.G., and Luo Y. 1998. Detection of programmed cell death using fluorescence energy transfer. *Nucleic Acids Res.* **26**: 2034–2035.
- Yang M., Wu Z., and Fields S. 1995. Protein-peptide interactions analyzed with the yeast two-hybrid system. *Nucleic Acids Res.* **23**: 1152–1156.
- Yang W.-P., Green K., Pinz-Sweeney S., Briones A.T., Burton D.R., and Barbas III, C.F. 1995. CDR walking mutagenesis for the affinity maturation of a potent human anti-HIV-1 antibody into the picomolar range. *J. Mol. Biol.* **254**: 392–403.
- Yasugi T., Vidal M., Sakai H., Howley P.M., and Benson J.D. 1997. Two classes of human papillomavirus type 16 E1 mutants suggest pleiotropic conformational constraints affecting E1 multimerization, E2 interaction, and interaction with cellular proteins. *J. Virol.* **71**: 5942–5951.
- Yates III, J.R. 2000. Mass spectrometry. From genomics to proteomics. *Trends Genet.* **16**: 5–8.
- Yates III, J.R., Carmack E., Hays L., Link A.J., and Eng J.K. 1999. Automated protein identification using microcolumn liquid chromatography-tandem mass spectrometry. *Methods Mol. Biol.* **112**: 553–569.
- Young R.A. and Davis R.W. 1983. Efficient isolation of genes by using antibody probes. *Proc. Natl. Acad. Sci.* **80**: 1194–1198.
- Yu X., Wu L.C., Bowcock A.M., Aronheim A., and Baer R. 1998. The C-terminal (BRCT) domains of BRCA1 interact in vivo with CtIP, a protein implicated in the CtBP pathway of transcriptional repression. *J. Biol. Chem.* **273**: 25388–25392.
- Yu Y., Yussa M., Song J., Hirsch J., and Pick L. 1999. A double interaction screen identifies positive and negative ftz gene regulators and ftz-interacting proteins. *Mech. Dev.* **83**: 95–105.
- Zaman Jr., G., Kaan A.M., Schoenmakers J.G.G., and Konings R.N.H. 1992. Gene-V-protein-mediated translational regulation of the synthesis of gene-II protein of the filamentous bacteriophage M13 — A dispensable function of the filamentous phage genome. *J. Bacteriol.* **174**: 595–600.
- Zhang J. and Lautar S. 1996. A yeast three-hybrid method to clone ternary protein complex components. *Anal. Biochem.* **242**: 68–72.

# Appendices

---

- 1 Preparation of Reagents and Buffers Used in Molecular Cloning, A1.1
  - 2 Media, A2.1
  - 3 Vectors and Bacterial Strains, A3.1
  - 4 Enzymes Used in Molecular Cloning, A4.1
  - 5 Inhibitors of Enzymes, A5.1
  - 6 Nucleic Acids, A6.1
  - 7 Codons and Amino Acids, A7.1
  - 8 Commonly Used Techniques in Molecular Cloning, A8.1
  - 9 Detection Systems, A9.1
  - 10 DNA Array Technology, A10.1
  - 11 Bioinformatics, A11.1
  - 12 Cautions, A12.1
  - 13 Suppliers, A13.1
  - 14 Trademarks, A14.1
- Appendix References, R1



# Appendix 1

---

## Preparation of Reagents and Buffers Used in Molecular Cloning

<b>BUFFERS</b>	A1.2
Tris Buffers	A1.2
Good Buffers	A1.3
Phosphate Buffers (Gomori Buffers)	A1.5
<b>ACIDS AND BASES</b>	A1.6
<b>PREPARATION OF BUFFERS AND STOCK SOLUTIONS FOR USE IN MOLECULAR BIOLOGY</b>	A1.7
pH Buffers	A1.7
Enzyme Stocks and Buffers	A1.8
Enzyme Stocks	A1.8
Enzyme Dilution Buffers	A1.9
Enzyme Reaction Buffers	A1.9
Hybridization Buffers	A1.12
Prehybridization and Hybridization Solutions	A1.13
Blocking Agents	A1.14
Blocking Agents Used for Nucleic Acid Hybridization	A1.14
Blocking Agents Used for Western Blotting	A1.16
Extraction/Lysis Buffers and Solutions	A1.16
Electrophoresis and Gel-loading Buffers	A1.17
Commonly Used Electrophoresis Buffers	A1.17
Specialized Electrophoresis Buffers	A1.17
Gel-loading Buffers	A1.18
Special Buffers and Solutions	A1.20
<b>PREPARATION OF ORGANIC REAGENTS</b>	A1.23
Phenol	A1.23
Equilibration of Phenol	A1.23
Phenol:Chloroform:Isoamyl Alcohol (25:24:1)	A1.23
Deionization of Formamide	A1.24
Deionization of Glyoxal	A1.24
<b>CHEMICAL STOCK SOLUTIONS</b>	A1.25
<b>PERIODIC TABLE</b>	A1.29
<b>REAGENTS AND BUFFERS INDEX</b>	A1.30
	<b>A1.1</b>

## BUFFERS

---

### Tris Buffers

Biological reactions work well only within a narrow concentration range of hydrogen ions. Paradoxically, however, many of these reactions themselves generate or consume protons. Buffers are substances that undergo reversible protonation within a particular pH range and therefore maintain the concentration of hydrogen ions within acceptable limits. Perfect buffers are, like the Holy Grail, always beyond reach. An ideal biological buffer should

- have a  $pK_a$  between pH 6.0 and pH 8.0
- be inert to a wide variety of chemicals and enzymes
- be highly polar, so that it is both exquisitely soluble in aqueous solutions and also unlikely to diffuse across biological membranes and thereby affect intracellular pH
- be nontoxic
- be cheap
- not be susceptible to salt or temperature effects
- not absorb visible or ultraviolet light

None of the buffers used in molecular biology fulfill all of these criteria. Very few weak acids are known that have dissociation constants between  $10^{-7}$  and  $10^{-9}$ . Among inorganic salts, only borates, bicarbonates, phosphates, and ammonium salts lie within this range. However, they are all incompatible in one way or another with physiological media.

In 1946, George Gomori (Gomori 1946) suggested that organic polyamines could be used to control pH in the range 6.5–9.7. One of the three compounds he investigated was Tris(2-amino-2-hydroxymethyl-1,3-propanediol), which had been first described in 1897 by Piloty and Ruff. Tris turned out to be an extremely satisfactory buffer for many biochemical purposes and today is the standard buffer used for most enzymatic reactions in molecular cloning.

**TABLE A1-1 Preparation of Tris Buffers of Various Desired pH Values**

DESIRED pH (25°C)	VOLUME OF 0.1 N HCl (ml)
7.10	45.7
7.20	44.7
7.30	43.4
7.40	42.0
7.50	40.3
7.60	38.5
7.70	36.6
7.80	34.5
7.90	32.0
8.00	29.2
8.10	26.2
8.20	22.9
8.30	19.9
8.40	17.2
8.50	14.7
8.60	12.4
8.70	10.3
8.80	8.5
8.90	7.0

Tris buffers (0.05 M) of the desired pH can be made by mixing 50 ml of 0.1 M Tris base with the indicated volume of 0.1 N HCl and then adjusting the volume of the mixture to 100 ml with water.

**TRIS BUFFERS**

One of Tris' first commercial successes, which received wide attention, was the reduction of mortality during handling and hauling of fish. In the 1940s, live fish were carried to market in tanks of seawater. Unfortunately, many of the fish died because of the decline in pH resulting from an accumulation of  $\text{CO}_2$ . This problem was only partially alleviated by including anesthetics in the water that minimized the fishes' metabolic activities. What these anesthetics did to the people who ate the fish is not recorded. Tris certainly reduced the mortality rate of the fish (McFarland and Norris 1958) by stabilizing the pH of the seawater and may also have kept the fish eaters more alert. Tris also turned out to be an extremely satisfactory buffer for many biochemical purposes and today is the standard buffer used for most enzymatic reactions in molecular cloning.

Tris [Tris(hydroxymethyl)aminomethane] has a very high buffering capacity, is highly soluble in water, and is inert in a wide variety of enzymatic reactions. However, Tris also has a number of deficiencies:

- **The  $pK_a$  of Tris is pH 8.0 (at 20°C)**, which means that its buffering capacity is very low at pHs below 7.5 and above 9.0.
- **Temperature has a significant effect on the dissociation of Tris.** The pH of Tris solutions decreases  $\sim 0.03$  pH units for each 1°C increase in temperature. For example, a 0.05 M solution has pH values of 9.5, 8.9, and 8.6 at 5°C, 25°C, and 37°C, respectively. By convention, the pH of Tris solutions given in the scientific literature refers to the pH measured at 25°C. When preparing stock solutions of Tris, it is best to bring the pH into the desired range and then allow the solution to cool to 25°C before making final adjustments to the pH.
- **Tris reacts with many types of pH electrodes** that contain linen-fiber junctions, apparently because Tris reacts with the linen fiber. This effect is manifested in large liquid-junction potentials, electromotive force (emf) drift, and long equilibration times. Electrodes with linen-fiber junctions, therefore, cannot accurately measure the pH of Tris solutions. Use only those electrodes with ceramic or glass junctions that are warranted by the manufacturer to be suitable for Tris.
- **Concentration has a significant effect on the dissociation of Tris.** For example, the pHs of solutions containing 10 mM and 100 mM Tris will differ by 0.1 of a pH unit, with the more concentrated solution having the higher pH.
- **Tris is toxic to many types of mammalian cells.**
- **Tris, a primary amine, cannot be used with fixatives** such as glutaraldehyde and formaldehyde. Tris also reacts with glyoxal. Phosphate or MOPS buffer is generally used in place of Tris with these reagents.

**Good Buffers**

Tris is a poor buffer at pH values below 7.5. In the mid 1960s, Norman Good and his colleagues responded to the need for better buffers in this range by developing a series of *N*-substituted aminosulfonic acids that behave as strong zwitterions at biologically relevant pH values (Good et al. 1966; Ferguson et al. 1980). Without these buffers, several techniques central to molecular cloning either would not exist at all or would work at greatly reduced efficiency. These techniques include high-efficiency transfection of mammalian cells (HEPES, Tricine, and BES), gel electrophoresis of RNA (MOPS), and high-efficiency transformation of bacteria (MES).

Table A1-2 Properties of Good Buffers

ACRONYM	CHEMICAL NAME	FW	pK <sub>a</sub>	USEFUL RANGE (IN pH UNITS)
MES	2-( <i>N</i> -morpholino)ethanesulfonic acid	195.2	6.1	5.5–6.7
<i>Bis-Tris</i>	<i>bis</i> (2-hydroxyethyl)iminotris(hydroxymethyl)methane	209.2	6.5	5.8–7.2
ADA	<i>N</i> -(2-acetamido)-2-iminodiacetic acid	190.2	6.6	6.0–7.2
ACFS	2-[(2-amino-2-oxoethyl)amino]ethanesulfonic acid	182.2	6.8	6.1–7.5
PIPES	piperazine- <i>N,N'</i> - <i>bis</i> (2-ethanesulfonic acid)	302.4	6.8	6.1–7.5
MOPSO	3-( <i>N</i> -morpholino)-2-hydroxypropanesulfonic acid	225.3	6.9	6.2–7.6
<i>Bis-Tris</i> Propane	1,3- <i>bis</i> [ <i>tris</i> (hydroxymethyl)methylamino]propane	282.3	6.8 <sup>a</sup>	6.3–9.5
BES	<i>N,N'</i> - <i>bis</i> (2-hydroxyethyl)-2-aminoethanesulfonic acid	213.2	7.1	6.4–7.8
MOPS	3-( <i>N</i> -morpholino)propanesulfonic acid	209.3	7.2	6.5–7.9
HEPES	<i>N</i> -(2-hydroxyethyl)piperazine- <i>N'</i> -(2-ethanesulfonic acid)	238.3	7.5	6.8–8.2
TES	<i>N</i> - <i>tris</i> (hydroxymethyl)methyl-2-aminoethanesulfonic acid	229.2	7.4	6.8–8.2
DIPSO	3-[ <i>N,N'</i> - <i>bis</i> (2-hydroxyethyl)amino]-2-hydroxypropanesulfonic acid	243.3	7.6	7.0–8.2
TAPSO	3-[ <i>N</i> - <i>tris</i> (hydroxymethyl)methylamino]-2-hydroxypropanesulfonic acid	259.3	7.6	7.0–8.2
TRIZMA	<i>tris</i> (hydroxymethyl)aminomethane	121.1	8.1	7.0–9.1
HEPPSO	<i>N</i> -(2-hydroxyethyl)piperazine- <i>N'</i> -(2-hydroxypropanesulfonic acid)	268.3	7.8	7.1–8.5
POPSO	piperazine- <i>N,N'</i> - <i>bis</i> (2-hydroxypropanesulfonic acid)	362.4	7.8	7.2–8.5
EPPS	<i>N</i> -(2-hydroxyethyl)piperazine- <i>N'</i> -(3-propanesulfonic acid)	252.3	8.0	7.3–8.7
TEA	triethanolamine	149.2	7.8	7.3–8.3
Tricine	<i>N</i> - <i>tris</i> (hydroxymethyl)methylglycine	179.2	8.1	7.4–8.8
Bicine	<i>N,N'</i> - <i>bis</i> (2-hydroxyethyl)glycine	163.2	8.3	7.6–9.0
TAPS	<i>N</i> - <i>tris</i> (hydroxymethyl)methyl-3-aminopropanesulfonic acid	243.3	8.4	7.7–9.1
AMPSO	3-[(1,1-dimethyl-2-hydroxyethyl)amino]-2-hydroxypropanesulfonic acid	227.3	9.0	8.3–9.7
CHES	2-( <i>N</i> -cyclohexylamino)ethanesulfonic acid	207.3	9.3	8.6–10.0
CAPSO	3-(cyclohexylamino)-2-hydroxy-1-propanesulfonic acid	237.3	9.6	8.9–10.3
AMP	2-amino-2-methyl-1-propanol	89.1	9.7	9.0–10.5
CAPS	3-(cyclohexylamino)-1-propanesulfonic acid	221.3	10.4	9.7–11.1

Data compiled from various sources, including *Biochemical and Reagents for Life Science Research* 1994 (Sigma-Aldrich) and references therein.

<sup>a</sup>pK<sub>a</sub> = 9.0 for the second dissociation stage.

## Phosphate Buffers (Gomori Buffers)

The most commonly used phosphate buffers are named after their inventor: Gomori (Gomori 1955). They consist of a mixture of monobasic dihydrogen phosphate and dibasic monohydrogen phosphate. By varying the amount of each salt, a range of buffers can be prepared that buffer well between pH 5.8 and pH 8.0 (please see Tables A1-3A and A1-3B). Phosphates have a very high buffering capacity and are highly soluble in water. However, they have a number of potential disadvantages:

- Phosphates inhibit many enzymatic reactions and procedures that are the foundation of molecular cloning, including cleavage of DNA by many restriction enzymes, ligation of DNA, and bacterial transformation.
- Because phosphates precipitate in ethanol, it is not possible to precipitate DNA and RNA from buffers that contain significant quantities of phosphate ions.
- Phosphates sequester divalent cations such as  $\text{Ca}^{2+}$  and  $\text{Mg}^{2+}$ .

**TABLE A1-3A Preparation of 0.1 M Potassium Phosphate Buffer at 25°C**

pH	VOLUME OF 1 M $\text{K}_2\text{HPO}_4$ (ml)	VOLUME OF 1 M $\text{KH}_2\text{PO}_4$ (ml)
5.8	8.5	91.5
6.0	13.2	86.8
6.2	19.2	80.8
6.4	27.8	72.2
6.6	38.1	61.9
6.8	49.7	50.3
7.0	61.5	38.5
7.2	71.7	28.3
7.4	80.2	19.8
7.6	86.6	13.4
7.8	90.8	9.2
8.0	94.0	6.0

Data from Green (1933).

Dilute the combined 1 M stock solutions to 1 liter with distilled  $\text{H}_2\text{O}$ . pH is calculated according to the Henderson-Hasselbalch equation:

$$\text{pH} = \text{pK}' + \log \left\{ \frac{\text{proton acceptor}}{\text{proton donor}} \right\}$$

where  $\text{pK}' = 6.86$  at 25°C.

**TABLE A1-3B Preparation of 0.1 M Sodium Phosphate Buffer at 25°C**

pH	VOLUME OF 1 M $\text{Na}_2\text{HPO}_4$ (ml)	VOLUME OF 1 M $\text{NaH}_2\text{PO}_4$ (ml)
5.8	7.9	92.1
6.0	12.0	88.0
6.2	17.8	82.2
6.4	25.5	74.5
6.6	35.2	64.8
6.8	46.3	53.7
7.0	57.7	42.3
7.2	68.4	31.6
7.4	77.4	22.6
7.6	84.5	15.5
7.8	89.6	10.4
8.0	93.2	6.8

Data from ISCO (1982).

Dilute the combined 1 M stock solutions to 1 liter with distilled  $\text{H}_2\text{O}$ . pH is calculated according to the Henderson-Hasselbalch equation:

$$\text{pH} = \text{pK}' + \log \left\{ \frac{\text{proton acceptor}}{\text{proton donor}} \right\}$$

where  $\text{pK}' = 6.86$  at 25°C.



## ACIDS AND BASES

TABLE A1-4 Concentrations of Acids and Bases: Common Commercial Strengths

SUBSTANCE	FORMULA	M.W.	MOLES/ LITER <sup>a</sup>	GRAMS/ LITER	% BY WEIGHT	SPECIFIC GRAVITY	ml/LITER TO PREPARE 1 M SOLUTION
Acetic acid, glacial	CH <sub>3</sub> COOH	60.05	17.4	1045	99.5	1.05	57.5
Acetic acid		60.05	6.27	376	36	1.045	159.5
Formic acid	HCOOH	46.02	23.4	1080	90	1.20	42.7
Hydrochloric acid	HCl	36.5	11.6	424	36	1.18	86.2
			2.9	105	10	1.05	344.8
Nitric acid	HNO <sub>3</sub>	63.02	15.99	1008	71	1.42	62.5
			14.9	938	67	1.40	67.1
			13.3	837	61	1.37	75.2
Perchloric acid	HClO <sub>4</sub>	100.5	11.65	1172	70	1.67	85.8
			9.2	923	60	1.54	108.7
Phosphoric acid	H <sub>3</sub> PO <sub>4</sub>	80.0	18.1	1445	85	1.70	55.2
Sulfuric acid	H <sub>2</sub> SO <sub>4</sub>	98.1	18.0	1766	96	1.84	55.6
Ammonium hydroxide	NH <sub>4</sub> OH	35.0	14.8	251	28	0.898	67.6
Potassium hydroxide	KOH	56.1	13.5	757	50	1.52	74.1
			1.94	109	10	1.09	515.5
Sodium hydroxide	NaOH	40.0	19.1	763	50	1.53	52.4
			2.75	111	10	1.11	363.6

<sup>a</sup>With some acids and bases, stock solutions of different molarity/normality are in common use. These are often abbreviated "conc" for concentrated stocks and "dil" for dilute stocks.

TABLE A1-5 Approximate pH Values for Various Concentrations of Stock Solutions

SUBSTANCE	1 N	0.1 N	0.01 N	0.001 N
Acetic acid	2.4	2.9	3.4	3.9
Hydrochloric acid	0.10	1.07	2.02	3.01
Sulfuric acid	0.3	1.2	2.1	
Citric acid		2.1	2.6	
Ammonium hydroxide	11.8	11.3	10.8	10.3
Sodium hydroxide	14.05	13.07	12.12	11.13
Sodium bicarbonate		8.4		
Sodium carbonate		11.5	11.0	

**PREPARATION OF BUFFERS AND STOCK SOLUTIONS FOR USE IN MOLECULAR BIOLOGY**

**CAUTION:** Please see Appendix 12 for appropriate handling of materials marked with <!.>.

**pH Buffers****Phosphate-buffered Saline (PBS)**

137 mM NaCl  
2.7 mM KCl  
10 mM Na<sub>2</sub>HPO<sub>4</sub>  
2 mM KH<sub>2</sub>PO<sub>4</sub>

Dissolve 8 g of NaCl, 0.2 g of KCl, 1.44 g of Na<sub>2</sub>HPO<sub>4</sub>, and 0.24 g of KH<sub>2</sub>PO<sub>4</sub> in 800 ml of distilled H<sub>2</sub>O. Adjust the pH to 7.4 with HCl. Add H<sub>2</sub>O to 1 liter. Dispense the solution into aliquots and sterilize them by autoclaving for 20 minutes at 15 psi (1.05 kg/cm<sup>2</sup>) on liquid cycle or by filter sterilization. Store the buffer at room temperature.

PBS is a commonly used reagent that has been adapted for different applications. Note that the recipe presented here lacks divalent cations. If necessary, PBS may be supplemented with 1 mM CaCl<sub>2</sub> and 0.5 mM MgCl<sub>2</sub>.

**10x Tris EDTA (TE)****pH 7.4**

100 mM Tris-Cl (pH 7.4)  
10 mM EDTA (pH 8.0)

**pH 7.6**

100 mM Tris-Cl (pH 7.6)  
10 mM EDTA (pH 8.0)

**pH 8.0**

100 mM Tris-Cl (pH 8.0)  
10 mM EDTA (pH 8.0)

Sterilize solutions by autoclaving for 20 minutes at 15 psi (1.05 kg/cm<sup>2</sup>) on liquid cycle. Store the buffer at room temperature.

**Tris-Cl (1 M)**

Dissolve 121.1 g of Tris base in 800 ml of H<sub>2</sub>O. Adjust the pH to the desired value by adding concentrated HCl <!.>.

<b>pH</b>	<b>HCl</b>
7.4	70 ml
7.6	60 ml
8.0	42 ml

Allow the solution to cool to room temperature before making final adjustments to the pH. Adjust the volume of the solution to 1 liter with H<sub>2</sub>O. Dispense into aliquots and sterilize by autoclaving.

If the 1 M solution has a yellow color, discard it and obtain Tris of better quality. The pH of Tris solutions is temperature-dependent and decreases ~0.03 pH units for each 1°C increase in temperature. For example, a 0.05 M solution has pH values of 9.5, 8.9, and 8.6 at 5°C, 25°C, and 37°C, respectively.

**Tris Magnesium Buffer (TM)**

50 mM Tris-Cl (pH 7.8)  
10 mM MgSO<sub>4</sub>

**Tris-buffered Saline (TBS)**

Dissolve 8 g of NaCl, 0.2 g of KCl, and 3 g of Tris base in 800 ml of distilled H<sub>2</sub>O. Add 0.015 g of phenol red and adjust the pH to 7.4 with HCl. Add distilled H<sub>2</sub>O to 1 liter. Dispense the solution into aliquots and sterilize them by autoclaving for 20 minutes at 15 psi (1.05 kg/cm<sup>2</sup>) on liquid cycle. Store the buffer at room temperature.

**Enzyme Stocks and Buffers**

**Enzyme Stocks**

**Lysozyme (10 mg/ml)**

Dissolve solid lysozyme at a concentration of 10 mg/ml in 10 mM Tris-Cl (pH 8.0) immediately before use. Make sure that the pH of the Tris solution is 8.0 before dissolving the protein. Lysozyme will not work efficiently if the pH of the solution is less than 8.0.

**Lyticase (67 mg/ml)**

Purchase from Sigma. Dissolve at 67 mg/ml (900 units/ml) in 0.01 M sodium phosphate containing 50% glycerol just before use.

**Pancreatic DNase I (1 mg/ml)**

Dissolve 2 mg of crude pancreatic DNase I (Sigma or equivalent) in 1 ml of

10 mM Tris-Cl (pH 7.5)  
150 mM NaCl  
1 mM MgCl<sub>2</sub>

When the DNase I is dissolved, add 1 ml of glycerol to the solution and mix by gently inverting the closed tube several times. Take care to avoid creating bubbles and foam. Store the solution in aliquots of -20°C.

**Pancreatic RNase (1 mg/ml)**

Dissolve 2 mg of crude pancreatic RNase I (Sigma or equivalent) in 2 ml of TE (pH 7.6).

**Proteinase K (20 mg/ml)**

Purchase as a lyophilized powder and dissolve at a concentration of 20 mg/ml in sterile 50 mM Tris (pH 8.0), 1.5 mM calcium acetate. Divide the stock solution into small aliquots and store at -20°C. Each aliquot can be thawed and refrozen several times but should then be discarded. Unlike much cruder preparations of protease (e.g., pronase), proteinase K need not be self-digested before use. (Please see entry on Proteinase K in Appendix 4.)

**Trypsin**

Prepare bovine trypsin at a concentration of 250 µg/ml in 200 mM ammonium bicarbonate (pH 8.9) (Sequencer grade; Boehringer Mannheim). Store the solution in aliquots at -20°C.

**Zymolyase 5000 (2 mg/ml)**

Purchase from Kirin Breweries. Dissolve at 2 mg/ml in 0.01 M sodium phosphate containing 50% glycerol just before use.

**Enzyme Dilution Buffers****DNase I Dilution Buffer**

10 mM Tris-Cl (pH 7.5)  
 150 mM NaCl  
 1 mM MgCl<sub>2</sub>

**Polymerase Dilution Buffer**

50 mM Tris-Cl (pH 8.1)  
 1 mM dithiothreitol  
 0.1 mM EDTA (pH 8.0)  
 0.5 mg/ml bovine serum albumin  
 5% (v/v) glycerol

Prepare solution fresh for each use.

**Sequenase Dilution Buffer**

10 mM Tris-Cl (pH 7.5)  
 5 mM dithiothreitol  
 0.5 mg/ml bovine serum albumin

Store the solution at -20°C.

**Taq Dilution Buffer**

25 mM Tris (pH 8.8)  
 0.01 mM EDTA (pH 8.0)  
 0.15% (v/v) Tween-20  
 0.15% (v/v) Nonidet P-40

**Enzyme Reaction Buffers**

▲ **IMPORTANT** Wherever possible, use the 10x reaction buffer supplied by the manufacturer of the enzyme used. Otherwise, use the recipes given here.

**10x Amplification Buffer**

500 mM KCl  
 100 mM Tris-Cl (pH 8.3 at room temperature)  
 15 mM MgCl<sub>2</sub>

Autoclave the 10x buffer for 10 minutes at 15 psi (1.05 kg/cm<sup>2</sup>) on liquid cycle. Divide the sterile buffer into aliquots and store them at -20°C.

**10x Bacteriophage T4 DNA Ligase Buffer**

200 mM Tris-Cl (pH 7.6)  
 50 mM MgCl<sub>2</sub>  
 50 mM dithiothreitol  
 0.5 mg/ml bovine serum albumin (Fraction V; Sigma) (*optional*)

Divide the buffer in small aliquots and store at -20°C. Add ATP when setting up the reaction. Add ATP to the reaction to an appropriate concentration (e.g., 1 mM).

**10x Bacteriophage T4 DNA Polymerase Buffer**

330 mM Tris-acetate (pH 8.0)  
660 mM potassium acetate  
100 mM magnesium acetate  
5 mM dithiothreitol  
1 mg/ml bovine serum albumin (Fraction V; Sigma)

Divide the 10x stock into small aliquots and store frozen at  $-20^{\circ}\text{C}$ .

**10x Bacteriophage T4 Polynucleotide Kinase Buffer**

700 mM Tris-Cl (pH 7.6)  
100 mM  $\text{MgCl}_2$   
50 mM dithiothreitol

Divide the 10x stock into small aliquots and store frozen at  $-20^{\circ}\text{C}$ .

**5x BAL 31 Buffer**

3 M NaCl  
60 mM  $\text{CaCl}_2$   
60 mM  $\text{MgCl}_2$   
100 mM Tris-Cl (pH 8.0)  
1 mM EDTA (pH 8.0)

**10x Dephosphorylation Buffer (for Use with CIP)**

100 mM Tris-Cl (pH 8.3)  
10 mM  $\text{MgCl}_2$   
10 mM  $\text{ZnCl}_2$

**10x Dephosphorylation Buffer (for Use with SAP)**

200 mM Tris-Cl (pH 8.8)  
100 mM  $\text{MgCl}_2$   
10 mM  $\text{ZnCl}_2$

**1x EcoRI Methylase Buffer**

50 mM NaCl  
50 mM Tris-Cl (pH 8.0)  
10 mM EDTA  
80  $\mu\text{M}$  S-adenosylmethionine

Store the buffer in small aliquots at  $-20^{\circ}\text{C}$ .

**10x Exonuclease III Buffer**

660 mM Tris-Cl (pH 8.0)  
66 mM  $\text{MgCl}_2$   
100 mM  $\beta$ -mercaptoethanol <!>

Add  $\beta$ -mercaptoethanol just before use.

**10x Klenow Buffer**

0.4 M potassium phosphate (pH 7.5)  
66 mM  $\text{MgCl}_2$   
10 mM  $\beta$ -mercaptoethanol <!>

**10X Linker Kinase Buffer**

600 mM Tris-Cl (pH 7.6)  
100 mM MgCl<sub>2</sub>  
100 mM dithiothreitol  
2 mg/ml bovine serum albumin

Prepare fresh just before use.

**Nuclease S1 Digestion Buffer**

0.28 M NaCl  
0.05 M sodium acetate (pH 4.5)  
4.5 mM ZnSO<sub>4</sub>·7H<sub>2</sub>O

Store aliquots of nuclease S1 buffer at -20°C, and add nuclease S1 to a concentration of 500 units/ml just before use.

**10X Proteinase K Buffer**

100 mM Tris-Cl (pH 8.0)  
50 mM EDTA (pH 8.0)  
500 mM NaCl

**10X Reverse Transcriptase Buffer**

500 mM Tris-Cl (pH 8.3)  
750 mM KCl  
30 mM MgCl<sub>2</sub>

**RNase H Buffer**

20 mM Tris-Cl (pH 7.6)  
20 mM KCl  
0.1 mM EDTA (pH 8.0)  
0.1 mM dithiothreitol

Prepare fresh just before use.

**5X Terminal Transferase Buffer**

Most manufacturers supply a 5X reaction buffer, which typically contains:

500 mM potassium cacodylate (pH 7.2) <!  
10 mM CoCl<sub>2</sub>·6H<sub>2</sub>O  
1 mM dithiothreitol

5X terminal transferase (or tailing) buffer may be prepared according to the following method (Eschenfeldt et al. 1987):

1. Equilibrate 5 g of Chelex 100 (Bio-Rad) with 10 ml of 3 M potassium acetate at room temperature.
2. After five minutes, remove excess liquid by vacuum suction. Wash the Chelex three times with 10 ml of deionized H<sub>2</sub>O.
3. Prepare a 1 M solution of potassium cacodylate. Equilibrate the cacodylate solution with the treated Chelex resin.
4. Recover the cacodylate solution by passing it through a Buchner funnel fitted with Whatman No. 1 filter paper.

5. To the recovered cacodylate add in order: H<sub>2</sub>O, dithiothreitol, and cobalt chloride to make the final concentrations of 500 mM potassium cacodylate, 1 mM dithiothreitol, and 20 mM CoCl<sub>2</sub>.

Store the buffer in aliquots at -20°C.

#### **10x Universal KGB (Restriction Endonuclease) Buffer**

- 1 M potassium acetate
- 250 mM Tris-acetate (pH 7.6)
- 100 mM magnesium acetate tetrahydrate
- 5 mM β-mercaptoethanol <!-->
- 0.1 mg/ml bovine serum albumin

Store the 10x buffer in aliquots at -20°C.

### **Hybridization Buffers**

#### **Alkaline Transfer Buffer (for Alkaline Transfer of DNA to Nylon Membranes)**

- 0.4 N NaOH <!-->
- 1 M NaCl

#### **Church Buffer**

- 1% (w/v) bovine serum albumin
- 1 mM EDTA
- 0.5 M phosphate buffer\*
- 7% (w/v) SDS

\*0.5 M phosphate buffer is 134 g of Na<sub>2</sub>HPO<sub>4</sub>·7H<sub>2</sub>O, 4 ml of 85% H<sub>3</sub>PO<sub>4</sub> <!--> (concentrated phosphoric acid), H<sub>2</sub>O to 1 liter.

#### **Denaturation Solution (for Neutral Transfer, Double-stranded DNA Targets Only)**

- 1.5 M NaCl
- 0.5 M NaOH <!-->

#### **HCl (2.5 N)**

Add 25 ml of concentrated HCl <!--> (11.6 N) to 91 ml of sterile H<sub>2</sub>O. Store the diluted solution at room temperature.

#### **Hybridization Buffer with Formamide (for RNA)**

- 40 mM PIPES (pH 6.8)
- 1 mM EDTA (pH 8.0)
- 0.4 M NaCl
- 80% (v/v) deionized formamide <!-->

Use the disodium salt of PIPES to prepare the buffer, and adjust the pH to 6.4 with 1 N HCl.

#### **Hybridization Buffer without Formamide (for RNA)**

- 40 mM PIPES (pH 6.4)
- 0.1 mM EDTA (pH 8.0)
- 0.4 M NaCl

Use the disodium salt of PIPES to prepare the buffer, and adjust the pH to 6.4 with 1 N HCl.

**Neutralization Buffer I (for Transfer of DNA to Uncharged Membranes)**

1 M Tris-Cl (pH 7.4)

1.5 M NaCl

**Neutralization Buffer II (for Alkaline Transfer of DNA to Nylon Membranes)**

0.5 M Tris-Cl (pH 7.2)

1 M NaCl

**Neutralizing Solution (for Neutral Transfer, Double-stranded DNA Targets Only)**

0.5 M Tris-Cl (pH 7.4)

1.5 M NaCl

**Prehybridization Solution (for Dot, Slot, and Northern Hybridization)**

0.5 M sodium phosphate (pH 7.2)\*

7% (w/v) SDS

1 mM EDTA (pH 7.0)

\*0.5 M phosphate buffer is 134 g of  $\text{Na}_2\text{HPO}_4 \cdot 7\text{H}_2\text{O}$ , 4 ml of 85%  $\text{H}_3\text{PO}_4$  (concentrated phosphoric acid),  $\text{H}_2\text{O}$  to 1 liter.

**Prehybridization and Hybridization Solutions****Prehybridization/Hybridization Solution (for Plaque/Colony Lifts)**

50% (v/v) formamide (optional) &lt;!--&gt;

6x SSC (or 6x SSPE)

0.05x BLOTTO

As an alternative to the above solution, use Church Buffer (please see recipe on p. A1.12). For advice on which hybridization solution to use, please see the panel on **PREHYBRIDIZATION AND HYBRIDIZATION SOLUTIONS** in Step 5 of Protocol 32 in Chapter 1. For advice on the use of formamide, please see the information panel on **FORMAMIDE AND ITS USES IN MOLECULAR CLONING** in Chapter 6.

**Prehybridization/Hybridization Solution (for Hybridization in Aqueous Buffer)**

6x SSC (or 6x SSPE)

5x Denhardt's reagent (see p. A1.15)

0.5% (w/v) SDS

1  $\mu\text{g}/\text{ml}$  poly(A)100  $\mu\text{g}/\text{ml}$  salmon sperm DNA**Prehybridization/Hybridization Solution (for Hybridization in Formamide Buffers)**

6x SSC (or 6x SSPE)

5x Denhardt's reagent (see A1.15)

0.5% (w/v) SDS

1  $\mu\text{g}/\text{ml}$  poly(A)100  $\mu\text{g}/\text{ml}$  salmon sperm DNA

50% (v/v) formamide &lt;!--&gt;

After a thorough mixing, filter the solution through a 0.45- $\mu\text{m}$  disposable cellulose acetate membrane (Schleicher & Schuell Uniflow syringe membrane or equivalent). To decrease background when hybridizing under conditions of reduced stringency (e.g., 20–30% formamide), it is important to use formamide that is as pure as possible.



**Prehybridization/Hybridization Solution (for Hybridization in Phosphate-SDS Buffer)**

- 0.5 M phosphate buffer (pH 7.2)\*
- 1 mM EDTA (pH 8.0)
- 7% (w/v) SDS
- 1% (w/v) bovine serum albumin

Use an electrophoresis grade of bovine serum albumin. No blocking agents or hybridization rate enhancers are required with this particular prehybridization/hybridization solution.

\*0.5 M phosphate buffer is 134 g of  $\text{Na}_2\text{HPO}_4 \cdot 7\text{H}_2\text{O}$ , 4 ml of 85%  $\text{H}_3\text{PO}_4$  (concentrated phosphoric acid),  $\text{H}_2\text{O}$  to 1 liter.

**20x SSC**

Dissolve 175.3 g of NaCl and 88.2 g of sodium citrate in 800 ml of  $\text{H}_2\text{O}$ . Adjust the pH to 7.0 with a few drops of a 14 N solution of HCl. Adjust the volume to 1 liter with  $\text{H}_2\text{O}$ . Dispense into aliquots. Sterilize by autoclaving. The final concentrations of the ingredients are 3.0 M NaCl and 0.3 M sodium acetate.

**20x SSPE**

Dissolve 175.3 g of NaCl, 27.6 g of  $\text{NaH}_2\text{PO}_4 \cdot \text{H}_2\text{O}$ , and 7.4 g of EDTA in 800 ml of  $\text{H}_2\text{O}$ . Adjust the pH to 7.4 with NaOH (~6.5 ml of a 10 N solution). Adjust the volume to 1 liter with  $\text{H}_2\text{O}$ . Dispense into aliquots. Sterilize by autoclaving. The final concentrations of the ingredients are 3.0 M NaCl, 0.2 M  $\text{NaH}_2\text{PO}_4$ , and 0.02 M EDTA.

**Blocking Agents**

Blocking agents prevent ligands from sticking to surfaces. They are used in molecular cloning to stop nonspecific binding of probes in Southern, northern, and western blotting. If left to their own devices, these probes would bind tightly and nonspecifically to the supporting nitrocellulose or nylon membrane. Without blocking agents, it would be impossible to detect anything but the strongest target macromolecules.

No one knows for sure what causes nonspecific binding of probes. Hydrophobic patches, lignin impurities, excessively high concentrations of probe, overbaking or underbaking of nitrocellulose filters, and homopolymeric sequences in nucleic acid probes have all been blamed from time to time, together with a host of less likely culprits. Whatever the cause, the solution is generally simple: Treat the filters with a blocking solution containing a cocktail of substances that will compete with the probe for nonspecific binding sites on the solid support. Blocking agents work by brute force. They are used in high concentrations and generally consist of a cocktail of high-molecular-weight polymers (heparin, polyvinylpyrrolidone, nucleic acids), proteins (bovine serum albumin, nonfat dried milk), and detergents (SDS or Nonidet P-40). The following recommendations apply only to nylon and nitrocellulose filters. Charged nylon filters should be treated as described by the individual manufacturer.

**Blocking Agents Used for Nucleic Acid Hybridization.** Two blocking agents in common use in nucleic acid hybridization are Denhardt's reagent (Denhardt 1966) and BLOTTO (Bovine Lacto Transfer Technique Optimizer; Johnson et al. 1984). Usually, the filters carrying the immobilized target molecules are incubated with the blocking agents for an hour or two before the probe is added. In most cases, background hybridization is completely suppressed when filters are incubated with a blocking agent consisting of 6x SSC or SSPE containing 5x Denhardt's reagent, 1.0% SDS, and 100 mg/ml denatured, sheared salmon sperm DNA. This mixture should be used

whenever the ratio of signal to noise is expected to be low, for example, when carrying out northern analysis of low-abundance RNAs or Southern analysis of single-copy sequences of mammalian DNA. However, in most other circumstances (Grunstein-Hogness hybridization, Benton-Davis hybridization, Southern hybridization of abundant DNA sequences, etc.), a less expensive alternative is 6x SSC or SSPE containing 0.25–0.5% nonfat dried milk (BLOTTO; Johnson et al. 1984).

Blocking agents are usually included in both prehybridization and hybridization solutions when nitrocellulose filters are used. However, when the target nucleic acid is immobilized on nylon membranes, the blocking agents are often omitted from the hybridization solution. This is because high concentrations of protein are believed to interfere with the annealing of the probe to its target. Quenching of the hybridization signal by blocking agents is particularly noticeable when oligonucleotides are used as probes. This problem can often be solved by carrying out the hybridization step in a solution containing high concentrations of SDS (6–7%), sodium phosphate (0.4 M), bovine serum albumin (1%), and EDTA (0.02 M) (Church and Gilbert 1984).

Heparin is sometimes used instead of Denhardt's solution or BLOTTO when hybridization is carried out in the presence of the accelerator, dextran sulfate. It is used at a concentration of 500 µg/ml in hybridization solutions containing dextran sulfate. In hybridization solutions that do not contain dextran sulfate, heparin is used at a concentration of 50 µg/ml (Singh and Jones 1984). Heparin (Sigma porcine grade II or equivalent) is dissolved at a concentration of 50 mg/ml in 4x SSPE or SSC and stored at 4°C.

#### DENHARDT'S REAGENT

Denhardt's reagent is used for

- northern hybridization
- single-copy Southern hybridization
- hybridizations involving DNA immobilized on nylon membranes

Denhardt's reagent is usually made up as a 50x stock solution, which is filtered and stored at –20°C. The stock solution is diluted tenfold into prehybridization buffer (usually 6x SSC or 6x SSPE containing 1.0% SDS and 100 µg/ml denatured salmon sperm DNA). 50x Denhardt's reagent contains in H<sub>2</sub>O (Denhardt 1966):

- 1% (w/v) Ficoll 400
- 1% (w/v) polyvinylpyrrolidone
- 1% (w/v) bovine serum albumin (Sigma, Fraction V)

#### BLOTTO <!>

BLOTTO is used for

- Grunstein-Hogness hybridization
- Benton-Davis hybridization
- all Southern hybridizations other than single-copy dot blots and slot blots

1x BLOTTO is 5% (w/v) nonfat dried milk dissolved in H<sub>2</sub>O containing 0.02% sodium azide <!>. 1x BLOTTO is stored at 4°C and is diluted 10–25-fold into prehybridization buffer before use. BLOTTO should not be used in combination with high concentrations of SDS, which will cause the milk proteins to precipitate. If background hybridization is a problem, Nonidet P-40 may be added to a final concentration of 1% (v/v).

BLOTTO may contain high levels of RNase and should be treated with diethylpyrocarbonate (Siegel and Bresnick 1986) or heated overnight to 72°C (Monstein et al. 1992) when used in northern hybridizations and when RNA is used as a probe. BLOTTO is not as effective as Denhardt's solution when the target DNA is immobilized on nylon filters.

**Blocking Agents Used for Western Blotting.** The best and least expensive blocking reagent is non-fat dried milk (Johnson et al. 1984). It is easy to use and is compatible with all of the common immunological detection systems. The only time nonfat dried milk should not be used is when western blots are probed for proteins that may be present in milk.

One of the following recipes may be used to prepare blocking buffer. A blocking solution for western blots is phosphate-buffered saline containing 5% (w/v) nonfat dried milk, 0.01% Antifoam, and 0.02% sodium azide.

**Blocking Buffer (TNT Buffer Containing a Blocking Agent)**

10 mM Tris-Cl (pH 8.0)  
150 mM NaCl  
0.05% (v/v) Tween-20  
blocking agent (1% [w/v] gelatin, 3% [w/v] bovine serum albumin, or  
5% [w/v] nonfat dried milk)

Opinion about which of these blocking agents is best varies from laboratory to laboratory. We recommend carrying out preliminary experiments to determine which of them works best. Blocking buffer can be stored at 4°C and reused several times. Sodium azide <!> should be added to a final concentration of 0.05% (w/v) to inhibit the growth of microorganisms.

## Extraction/Lysis Buffers and Solutions

**Alkaline Lysis Solution I (Plasmid Preparation)**

50 mM glucose  
25 mM Tris-Cl (pH 8.0)  
10 mM EDTA (pH 8.0)

Prepare Solution I from standard stocks in batches of ~100 ml, autoclave for 15 minutes at 15 psi (1.05 kg/cm<sup>2</sup>) on liquid cycle, and store at 4°C.

**Alkaline Lysis Solution II (Plasmid Preparation)**

0.2 N NaOH (freshly diluted from a 10 N stock) <!>  
1% (w/v) SDS

Prepare Solution II fresh and use at room temperature.

**Alkaline Lysis Solution III (Plasmid Preparation)**

5 M potassium acetate	60.0 ml
glacial acetic acid <!>	11.5 ml
H <sub>2</sub> O	28.5 ml

The resulting solution is 3 M with respect to potassium and 5 M with respect to acetate. Store the solution at 4°C and transfer it to an ice bucket just before use.

**STET**

10 mM Tris-Cl (pH 8.0)  
0.1 M NaCl  
1 mM EDTA (pH 8.0)  
5% (v/v) Triton X-100

Make sure that the pH of STET is 8.0 after all ingredients are added. There is no need to sterilize STET before use.

## Electrophoresis and Gel-loading Buffers

### Commonly Used Electrophoresis Buffers

Buffer	Working Solution	Stock Solution/Liter
TAE	<b>1x</b> 40 mM Tris-acetate 1 mM EDTA	<b>50x</b> 242 g of Tris base 57.1 ml of glacial acetic acid <math>\langle ! \rangle</math> 100 ml of 0.5 M EDTA (pH 8.0)
TBE <sup>a</sup>	<b>0.5x</b> 45 mM Tris-borate 1 mM EDTA	<b>5x</b> 54 g of Tris base 27.5 g of boric acid 20 ml of 0.5 M EDTA (pH 8.0)
TPE	<b>1x</b> 90 mM Tris-phosphate 2 mM EDTA	<b>10x</b> 108 g of Tris base 15.5 ml of phosphoric acid <math>\langle ! \rangle</math> (85%, 1.679 g/ml) 40 ml of 0.5 M EDTA (pH 8.0)
Tris-glycine <sup>b</sup>	<b>1x</b> 25 mM Tris-Cl 250 mM glycine 0.1% SDS	<b>5x</b> 15.1 g of Tris base 94 g of glycine (electrophoresis grade) 50 ml of 10% SDS (electrophoresis grade)

<sup>a</sup>TBE is usually made and stored as a 5x or 10x stock solution. The pH of the concentrated stock buffer should be ~8.3. Dilute the concentrated stock buffer just before use and make the gel solution and the electrophoresis buffer from the same concentrated stock solution. Some investigators prefer to use more concentrated stock solutions of TBE (10x as opposed to 5x). However, 5x stock solution is more stable because the solutes do not precipitate during storage. Passing the 5x or 10x buffer stocks through a 0.22- $\mu$ m filter can prevent or delay formation of precipitates.

<sup>b</sup>Use Tris-glycine buffers for SDS-polyacrylamide gels (see Appendix 8).

### Specialized Electrophoresis Buffers

#### 10x Alkaline Agarose Gel Electrophoresis Buffer

500 mM NaOH <math>\langle ! \rangle</math>  
10 mM EDTA

Add 50 ml of 10 N NaOH and 20 ml of 0.5 M EDTA (pH 8.0) to 800 ml of H<sub>2</sub>O and then adjust the final volume to 1 liter. Dilute the 10x alkaline agarose gel electrophoresis buffer with H<sub>2</sub>O to generate a 1x working solution immediately before use. Use the same stock of 10x alkaline agarose gel electrophoresis buffer to prepare the alkaline agarose gel and the 1x working solution of alkaline electrophoresis buffer.

#### 10x BPTE Electrophoresis Buffer

100 mM PIPES  
300 mM Bis-Tris  
10 mM EDTA

The final pH of the 10x buffer is ~6.5. The 10x buffer can be made by adding 3 g of PIPES (free acid), 6 g of Bis-Tris (free base), and 2 ml of 0.5 M EDTA to 90 ml of distilled H<sub>2</sub>O and then treating the solution with diethylpyrocarbonate <math>\langle ! \rangle</math> (final concentration 0.1%; for more details, please see the information panel on **DIETHYLPYROCARBONATE** in Chapter 7).

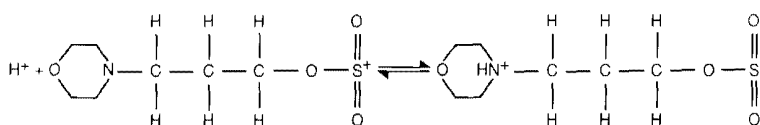
**10x MOPS Electrophoresis Buffer**

0.2 M MOPS (pH 7.0) <math>\langle ! \rangle</math>  
 20 mM sodium acetate  
 10 mM EDTA (pH 8.0)

Dissolve 41.8 g of MOPS in 700 ml of sterile DEPC-treated <math>\langle ! \rangle</math> H<sub>2</sub>O. Adjust the pH to 7.0 with 2 N NaOH. Add 20 ml of DEPC-treated 1 M sodium acetate and 20 ml of DEPC-treated 0.5 M EDTA (pH 8.0). Adjust the volume of the solution to 1 liter with DEPC-treated H<sub>2</sub>O. Sterilize the solution by passing it through a 0.45- $\mu$ m Millipore filter, and store it at room temperature protected from light. The buffer yellows with age if it is exposed to light or is autoclaved. Straw-colored buffer works well, but darker buffer does not.

**MOPS (3[N-MORPHOLINO]PROPANESULFONIC ACID**

FW	pK <sub>a</sub> (20°C)	$\Delta$ pK <sub>a</sub> /°C	Molar strength of saturated solution at 0°C
209.3	7.15	-0.013	3.1



MOPS is one of the buffers developed by Robert Good's laboratories in the 1970s to facilitate isolation of chloroplasts and other plant organelles (for reviews, please see Good and Izawa 1972; Ferguson et al. 1980; please also see figure above). In molecular cloning, MOPS is a component of buffers used for the electrophoresis of RNA through agarose gels (Lehrach et al. 1977; Goldberg 1980).

**TAFE Gel Electrophoresis Buffer**

20 mM Tris-acetate (pH 8.2)  
 0.5 mM EDTA

Use acetic acid to adjust the pH of the Tris solution to 8.2, and use the free acid of EDTA, not the sodium salt. Concentrated solutions of TAFE buffer can also be purchased (e.g., from Beckman).

▲ **IMPORTANT** The TAFE gel electrophoresis buffer must be cooled to 14°C before use.

**Gel-loading Buffers****6x Alkaline Gel-loading Buffer**

300 mM NaOH <math>\langle ! \rangle</math>  
 6 mM EDTA  
 18% (w/v) Ficoll (Type 400, Pharmacia)  
 0.15% (w/v) bromocresol green  
 0.25% (w/v) xylene cyanol

**Bromophenol Blue Solution (0.4%, w/v)**

Dissolve 4 mg of solid bromophenol blue in 1 ml of sterile H<sub>2</sub>O. Store the solution at room temperature.

TABLE A1-6 6× Gel-loading Buffers

BUFFER TYPE	6× BUFFER	STORAGE TEMPERATURE
I	0.25% (w/v) bromophenol blue 0.25% (w/v) xylene cyanol FF 40% (w/v) sucrose in H <sub>2</sub> O	4°C
II	0.25% (w/v) bromophenol blue 0.25% (w/v) xylene cyanol FF 15% (w/v) Ficoll (Type 400; Pharmacia) in H <sub>2</sub> O	room temperature
III	0.25% (w/v) bromophenol blue 0.25% (w/v) xylene cyanol FF 30% (v/v) glycerol in H <sub>2</sub> O	4°C
IV	0.25% (w/v) bromophenol blue 40% (w/v) sucrose in H <sub>2</sub> O	4°C

**Bromophenol Blue Sucrose Solution**

0.25% (w/v) bromophenol blue  
40% (w/v) sucrose

**Cresol Red Solution (10 mM)**

Dissolve 4 mg of the sodium salt of cresol red (Aldrich) in 1 ml of sterile H<sub>2</sub>O. Store the solution at room temperature.

**10× Formaldehyde Gel-loading Buffer**

50% (v/v) glycerol (diluted in DEPC-treated <math>H\_2O</math>)  
10 mM EDTA (pH 8.0)  
0.25% (w/v) bromophenol blue  
0.25% (w/v) xylene cyanol FF

**Formamide-loading Buffer**

80% (w/v) deionized formamide <math>H\_2O</math>  
10 mM EDTA (pH 8.0)  
1 mg/ml xylene cyanol FF  
1 mg/ml bromophenol blue

Purchase a distilled deionized preparation of formamide and store in small aliquots under nitrogen at -20°C. Alternatively, deionize reagent-grade formamide as described in Appendix 8.

**RNA Gel-loading Buffer**

95% (v/v) deionized formamide <math>H\_2O</math>  
0.025% (w/v) bromophenol blue  
0.025% (w/v) xylene cyanol FF  
5 mM EDTA (pH 8.0)  
0.025% (w/v) SDS

#### 2x SDS Gel-loading Buffer

100 mM Tris-Cl (pH 6.8)  
4% (w/v) SDS (electrophoresis grade)  
0.2% (w/v) bromophenol blue  
20% (v/v) glycerol  
200 mM dithiothreitol or  $\beta$ -mercaptoethanol <!>

1x and 2x SDS gel-loading buffer lacking thiol reagents can be stored at room temperature. Add the thiol reagents from 1 M (dithiothreitol) or 14 M ( $\beta$ -mercaptoethanol) stocks just before the buffer is used.

#### 2.5x SDS-EDTA Dye Mix

0.4% (v/v) SDS  
30 mM EDTA  
0.25% bromophenol blue  
0.25% xylene cyanol FF  
20% (w/v) sucrose

### Special Buffers and Solutions

#### Elution Buffer (Qiagen)

50 mM Tris-Cl (pH 8.1–8.2)  
1.4 M NaCl  
15% (v/v) ethanol

#### KOH/Methanol Solution

This solution is for cleaning the glass plates used to cast sequencing gels. It is prepared by dissolving 5 g of KOH <!> pellets in 100 ml of methanol <!>. Store the solution at room temperature in a tightly capped glass bottle.

#### $\lambda$ Annealing Buffer

100 mM Tris-Cl (pH 7.6)  
10 mM  $MgCl_2$

#### LB Freezing Buffer

36 mM  $K_2HPO_4$  (anhydrous)  
13.2 mM  $KH_2PO_4$   
1.7 mM sodium citrate  
0.4 mM  $MgSO_4 \cdot 7H_2O$   
6.8 mM ammonium sulfate  
4.4% (v/v) glycerol  
in LB broth

LB freezing buffer (Zimmer and Verrinder Gibbins 1997) is best made by dissolving the salts in 100 ml of LB to the specified concentrations. Measure 95.6 ml of the resulting solution into a fresh container and then add 4.4 ml of glycerol. Mix the solution well and then sterilize by passing it through a 0.45- $\mu$ m disposable Nalgene filter. Store the sterile freezing medium at a controlled room temperature (15–25°C).

**MgCl<sub>2</sub>-CaCl<sub>2</sub> Solution**

80 mM MgCl<sub>2</sub>  
20 mM CaCl<sub>2</sub>

**P3 Buffer (Qiagen)**

3 M potassium acetate (pH 5.5)

**PEG-MgCl<sub>2</sub> Solution**

40% (w/v) polyethylene glycol (PEG 8000)  
30 mM MgCl<sub>2</sub>

Dissolve 40 g of PEG 8000 in a final volume of 100 ml of 30 mM MgCl<sub>2</sub>. Sterilize the solution by passing it through a 0.22- $\mu$ m filter, and store it at room temperature.

**QBT Buffer (Qiagen)**

750 mM NaCl <!  
50 mM MOPS (pH 7.0) <!  
15% (v/v) isopropanol  
0.15% (v/v) Triton X-100

**Radioactive Ink <!**

Radioactive ink is made by mixing a small amount of <sup>32</sup>P with waterproof black drawing ink. We find it convenient to make the ink in three grades: very hot (>2000 cps on a hand-held minimonitor), hot (>500 cps on a hand-held minimonitor), and cool (>50 cps on a hand-held minimonitor). Use a fiber-tip pen to apply ink of the desired activity to the pieces of tape. Attach radioactive-warning tape to the pen, and store it in an appropriate place.

**Sephacryl Equilibration Buffer**

50 mM Tris-Cl (pH 8.0)  
5 mM EDTA  
0.5 M NaCl

**SM and SM Plus Gelatin**

Per liter:

NaCl	5.8 g
MgSO <sub>4</sub> ·7H <sub>2</sub> O	2 g
1 M Tris-Cl (pH 7.5)	50 ml
2% (w/v) gelatin solution	5 ml
H <sub>2</sub> O	to 1 liter

Sterilize the buffer by autoclaving for 20 minutes at 15 psi (1.05 kg/cm<sup>2</sup>) on liquid cycle. After the solution has cooled, dispense 50-ml aliquots into sterile containers. SM may be stored indefinitely at room temperature. Discard each aliquot after use to minimize the chance of contamination.

**Sorbitol Buffer**

1 M sorbitol  
0.1 M EDTA (pH 7.5)



**STE**

10 mM Tris-Cl (pH 8.0)  
0.1 M NaCl  
1 mM EDTA (pH 8.0)

Sterilize by autoclaving for 15 minutes at 15 psi (1.05 kg/cm<sup>2</sup>) on liquid cycle. Store the sterile solution at 4°C.

**10x TEN Buffer**

0.1 M Tris-Cl (pH 8.0)  
0.01 M EDTA (pH 8.0)  
1 M NaCl

**TES**

10 mM Tris-Cl (pH 7.5)  
1 mM EDTA (pH 7.5)  
0.1% (w/v) SDS

**Triton/SDS Solution**

10 mM Tris-Cl (pH 8.0)  
2% (v/v) Triton X-100  
1% (w/v) SDS  
100 mM NaCl  
1 mM EDTA (pH 8.0)

Sterilize the solution by passing it through a 0.22- $\mu$ m filter, and store it at room temperature.

**Tris-Sucrose**

50 mM Tris-Cl (pH 8.0)  
10% (w/v) sucrose

Sterilize the solution by passing it through a 0.22- $\mu$ m filter, and store it at room temperature. Solutions containing sucrose should not be autoclaved since the sugar tends to carbonize at high temperatures.

**Wash Buffer (Qiagen)**

50 mM MOPS-KOH <math>\text{pH } 7.5\text{--}7.6</math>  
0.75 M NaCl  
15% (v/v) ethanol

When making this buffer, adjust the pH of a MOPS/NaCl solution before adding the ethanol.

**Yeast Resuspension Buffer**

50 mM Tris-Cl (pH 7.4)  
20 mM EDTA (pH 7.5)

## PREPARATION OF ORGANIC REAGENTS

**CAUTION:** Please see Appendix 12 for appropriate handling of materials marked with <!.>.

### Phenol

Most batches of commercial liquefied phenol <!.> are clear and colorless and can be used in molecular cloning without redistillation. Occasionally, batches of liquefied phenol are pink or yellow, and these should be rejected and returned to the manufacturer. Crystalline phenol is not recommended because it must be redistilled at 160°C to remove oxidation products, such as quinones, that cause the breakdown of phosphodiester bonds or cause cross-linking of RNA and DNA.

### Equilibration of Phenol

Before use, phenol must be equilibrated to a pH of >7.8 because the DNA partitions into the organic phase at acid pH. Wear gloves, full face protection, and a lab coat when carrying out this procedure.

1. Store liquefied phenol at -20°C. As needed, remove the phenol from the freezer, allow it to warm to room temperature, and then melt it at 68°C. Add hydroxyquinoline to a final concentration of 0.1%. This compound is an antioxidant, a partial inhibitor of RNase, and a weak chelator of metal ions (Kirby 1956). In addition, its yellow color provides a convenient way to identify the organic phase.
2. To the melted phenol, add an equal volume of buffer (usually 0.5 M Tris-Cl [pH 8.0] at room temperature). Stir the mixture on a magnetic stirrer for 15 minutes. Turn off the stirrer, and when the two phases have separated, aspirate as much as possible of the upper (aqueous) phase using a glass pipette attached to a vacuum line equipped with appropriate traps (please see Appendix 8, Figure A8-2).
3. Add an equal volume of 0.1 M Tris-Cl (pH 8.0) to the phenol. Stir the mixture on a magnetic stirrer for 15 minutes. Turn off the stirrer and remove the upper aqueous phase as described in Step 2. Repeat the extractions until the pH of the phenolic phase is >7.8 (as measured with pH paper).
4. After the phenol is equilibrated and the final aqueous phase has been removed, add 0.1 volume of 0.1 M Tris-Cl (pH 8.0) containing 0.2%  $\beta$ -mercaptoethanol <!.>. The phenol solution may be stored in this form under 100 mM Tris-Cl (pH 8.0) in a light-tight bottle at 4°C for periods of up to 1 month.

### Phenol:Chloroform:Isoamyl Alcohol (25:24:1)

A mixture consisting of equal parts of equilibrated phenol and chloroform:isoamyl alcohol <!.> (24:1) is frequently used to remove proteins from preparations of nucleic acids. The chloroform denatures proteins and facilitates the separation of the aqueous and organic phases, and the isoamyl alcohol reduces foaming during extraction. Neither chloroform nor isoamyl alcohol requires treatment before use. The phenol:chloroform:isoamyl alcohol mixture may be stored under 100 mM Tris-Cl (pH 8.0) in a light-tight bottle at 4°C for periods of up to 1 month.

### Deionization of Formamide

Many batches of reagent-grade formamide are sufficiently pure to be used without further treatment. However, if any yellow color is present, deionize the formamide by stirring on a magnetic stirrer with Dowex XG8 mixed bed resin for 1 hour and filtering it twice through Whatman No. 1 paper. Store deionized formamide in small aliquots under nitrogen at  $-70^{\circ}\text{C}$ .

### Deionization of Glyoxal

Commercial stock solutions of glyoxal (40% or 6 M) contain various hydrated forms of glyoxal, as well as oxidation products such as glyoxylic acid, formic acid, and other compounds that can degrade RNA. These contaminants must be removed by treatment with a mixed-bed resin such as Bio-Rad AG-510-X8 until the indicator dye in the resin is exhausted. To deionize the glyoxal:

1. Immediately before use, mix the glyoxal with an equal volume mixed-bed ion-exchange resin (Bio-Rad AG-510-X8). Alternatively, pass the glyoxal through a small column of mixed bed resin, and then proceed to Step 3.
2. Separate the deionized material from the resin by filtration (e.g., through a Uniflow Plus filter; Schleicher & Schuell).
3. Monitor the pH of the glyoxal by mixing 200  $\mu\text{l}$  of glyoxal with 2  $\mu\text{l}$  of a 10 mg/ml solution of bromocresol green in  $\text{H}_2\text{O}$ , and observing the change in color. Bromocresol green is yellow at  $\text{pH} < 4.8$  and blue-green at  $\text{pH} > 5.2$ .
4. Repeat the deionization process (Steps 1–2) until the pH of the glyoxal is  $> 5.5$ .

Deionized glyoxal can be stored indefinitely at  $-20^{\circ}\text{C}$  under nitrogen in tightly sealed microfuge tubes. Use each aliquot only once and then discard.

## CHEMICAL STOCK SOLUTIONS

**CAUTION:** Please see Appendix 12 for appropriate handling of materials marked with <!.>.

### Acrylamide Solution (45% w/v)

acrylamide (DNA-sequencing grade) <!.>	434 g
<i>N,N'</i> -methylenebisacrylamide <!.>	16 g
H <sub>2</sub> O	to 600 ml

Heat the solution to 37°C to dissolve the chemicals. Adjust the volume to 1 liter with distilled H<sub>2</sub>O. Filter the solution through a nitrocellulose filter (e.g., Nalge, 0.45-micron pore size), and store the filtered solution in dark bottles at room temperature.

### Actinomycin D (5 mg/ml)

Dissolve actinomycin D <!.> in methanol <!.> at a concentration of 5 mg/ml. Store the stock solution at -20°C in the dark. Please see the information panel on ACTINOMYCIN D in Chapter 7.

### Adenosine Diphosphate (ADP) (1 mM)

Dissolve solid adenosine diphosphate in sterile 25 mM Tris-Cl (pH 8.0). Store small aliquots (~20 µl) of the solution at -20°C.

### Ammonium Acetate (10 M)

To prepare a 1-liter solution, dissolve 770 g of ammonium acetate in 800 ml of H<sub>2</sub>O. Adjust volume to 1 liter with H<sub>2</sub>O. Sterilize by filtration. Alternatively, to prepare a 100-ml solution, dissolve 77 g of ammonium acetate in 70 ml of H<sub>2</sub>O at room temperature. Adjust the volume to 100 ml with H<sub>2</sub>O. Sterilize the solution by passing it through a 0.22-µm filter. Store the solution in tightly sealed bottles at 4°C or at room temperature. Ammonium acetate decomposes in hot H<sub>2</sub>O and solutions containing it should not be autoclaved.

### Ammonium Persulfate (10% w/v)

ammonium persulfate <!.>	1 g
H <sub>2</sub> O	to 10 ml

Dissolve 1 g ammonium persulfate in 10 ml of H<sub>2</sub>O and store at 4°C. Ammonium persulfate decays slowly in solution, so replace the stock solution every 2–3 weeks. Ammonium persulfate is used as a catalyst for the copolymerization of acrylamide and bisacrylamide gels. The polymerization reaction is driven by free radicals generated by an oxido-reduction reaction in which a diamine (e.g., TEMED) is used as the adjunct catalyst (Chrambach and Rodbard 1972).

### ATP (10 mM)

Dissolve an appropriate amount of solid ATP in 25 mM Tris-Cl (pH 8.0). Store the ATP solution in small aliquots at -20°C.

### Calcium Chloride (2.5 M)

Dissolve 11 g of CaCl<sub>2</sub>·6H<sub>2</sub>O in a final volume of 20 ml of distilled H<sub>2</sub>O. Sterilize the solution by passing it through a 0.22-µm filter. Store in 1-ml aliquots at 4°C.

**Coomassie Staining Solution**

Dissolve 0.25 g of Coomassie Brilliant Blue R-250 in 90 ml of methanol:H<sub>2</sub>O (1:1, v/v) and 10 ml of glacial acetic acid. Filter the solution through a Whatman No. 1 filter to remove any particulate matter. Store at room temperature. Please see the entry on Coomassie Staining in Appendix 8.

**Deoxyribonucleoside Triphosphates (dNTPs)**

Dissolve each dNTP in H<sub>2</sub>O at an approximate concentration of 100 mM. Use 0.05 M Tris base and a micropipette to adjust the pH of each of the solutions to 7.0 (use pH paper to check the pH). Dilute an aliquot of the neutralized dNTP appropriately, and read the optical density at the wavelengths given in the table below. Calculate the actual concentration of each dNTP. Dilute the solutions with H<sub>2</sub>O to a final concentration of 50 mM dNTP. Store each separately at -70°C in small aliquots.

Base	Wavelength (nm)	Extinction Coefficient (E)(M <sup>-1</sup> cm <sup>-1</sup> )
A	259	1.54 × 10 <sup>4</sup>
G	253	1.37 × 10 <sup>4</sup>
C	271	9.10 × 10 <sup>3</sup>
T	267	9.60 × 10 <sup>3</sup>

For a cuvette with a path length of 1 cm, absorbance = EM. 100 mM stock solutions of each dNTP are commercially available (Pharmacia).

For polymerase chain reactions (PCRs), adjust the dNTP solution to pH 8.0 with 2 N NaOH. Commercially available solutions of PCR-grade dNTPs require no adjustment.

**Dimethylsulfoxide (DMSO)**

Purchase a high grade of DMSO (HPLC grade or better). Divide the contents of a fresh bottle into 1-ml aliquots in sterile tubes. Close the tubes tightly and store at -20°C. Use each aliquot only once and then discard.

**Dithiothreitol (DTT, 1 M)**

Dissolve 3.09 g of dithiothreitol in 20 ml of 0.01 M sodium acetate (pH 5.2) and sterilize by filtration. Dispense into 1-ml aliquots and store at -20°C. Under these conditions, dithiothreitol is stable to oxidation by air.

**EDTA (0.5 M, pH 8.0)**

Add 186.1 g of disodium EDTA·2H<sub>2</sub>O to 800 ml of H<sub>2</sub>O. Stir vigorously on a magnetic stirrer. Adjust the pH to 8.0 with NaOH (~20 g of NaOH pellets). Dispense into aliquots and sterilize by autoclaving. The disodium salt of EDTA will not go into solution until the pH of the solution is adjusted to ~8.0 by the addition of NaOH.

**EGTA (0.5 M, pH 8.0)**

EGTA is ethylene glycol bis(β-aminoethyl ether) N,N,N',N'-tetraacetic acid. A solution of EGTA is made up essentially as described for EDTA above and sterilized by either autoclaving or filtering. Store the sterile solution at room temperature.

**Ethidium Bromide (10 mg/ml)**

Add 1 g of ethidium bromide to 100 ml of H<sub>2</sub>O. Stir on a magnetic stirrer for several hours to ensure that the dye has dissolved. Wrap the container in aluminum foil or transfer the solution to a dark bottle and store at room temperature.

**Gelatin (2% w/v)**

Add 2 g of gelatin to a total volume of 100 ml of H<sub>2</sub>O and autoclave the solution for 15 minutes at 15 psi (1.05 kg/cm<sup>2</sup>) on liquid cycle.

**Glycerol (10% v/v)**

Dilute 1 volume of molecular-biology-grade glycerol in 9 volumes of sterile pure H<sub>2</sub>O. Sterilize the solution by passing it through a prerinsed 0.22- $\mu$ m filter. Store in 200-ml aliquots at 4°C.

**IPTG (20% w/v, 0.8 M)**

IPTG is isopropylthio- $\beta$ -D-galactoside. Make a 20% solution of IPTG by dissolving 2 g of IPTG in 8 ml of distilled H<sub>2</sub>O. Adjust the volume of the solution to 10 ml with H<sub>2</sub>O and sterilize by passing it through a 0.22- $\mu$ m disposable filter. Dispense the solution into 1-ml aliquots and store them at -20°C.

**KCl (4 M)**

Dissolve an appropriate amount of solid KCl in H<sub>2</sub>O, autoclave for 20 minutes on liquid cycle and store at room temperature. Ideally, this solution should be divided into small (~100  $\mu$ l) aliquots in sterile tubes and each aliquot thereafter used one time.

**Lithium Chloride (LiCl, 5 M)**

Dissolve 21.2 g of LiCl in a final volume of 90 ml of H<sub>2</sub>O. Adjust the volume of the solution to 100 ml with H<sub>2</sub>O. Sterilize the solution by passing it through a 0.22- $\mu$ m filter, or by autoclaving for 15 minutes at 15 psi (1.05 kg/cm<sup>2</sup>) on liquid cycle. Store the solution at 4°C.

**MgCl<sub>2</sub>·6H<sub>2</sub>O (1 M)**

Dissolve 203.3 g of MgCl<sub>2</sub>·6H<sub>2</sub>O in 800 ml of H<sub>2</sub>O. Adjust the volume to 1 liter with H<sub>2</sub>O. Dispense into aliquots and sterilize by autoclaving. MgCl<sub>2</sub> is extremely hygroscopic. Buy small bottles (e.g., 100 g) and do not store opened bottles for long periods of time.

**MgSO<sub>4</sub> (1 M)**

Dissolve 12 g of MgSO<sub>4</sub> in a final volume of 100 ml of H<sub>2</sub>O. Sterilize by autoclaving or filter sterilization. Store at room temperature.

**Maltose (20% w/v)**

Dissolve 20 g of maltose in a final volume of 100 ml of H<sub>2</sub>O and sterilize by passing it through a 0.22- $\mu$ m filter. Store the sterile solution at room temperature.

**NaOH (10 N)**

The preparation of 10 N NaOH involves a highly exothermic reaction, which can cause breakage of glass containers. Prepare this solution with extreme care in plastic beakers. To 800 ml of H<sub>2</sub>O, slowly add 400 g of NaOH pellets, stirring continuously. As an added precaution, place the beaker on ice. When the pellets have dissolved completely, adjust the volume to 1 liter with H<sub>2</sub>O. Store the solution in a plastic container at room temperature. Sterilization is not necessary.

**NaCl (Sodium Chloride, 5 M)**

Dissolve 292 g of NaCl in 800 ml of H<sub>2</sub>O. Adjust the volume to 1 liter with H<sub>2</sub>O. Dispense into aliquots and sterilize by autoclaving. Store the NaCl solution at room temperature.

**PEG 8000**

Working concentrations of PEG <math>\langle ! \rangle</math> range from 13% to 40% (w/v). Prepare the appropriate concentration by dissolving PEG 8000 in sterile  $H_2O$ , warming if necessary. Sterilize the solution by passing it through a 0.22- $\mu m$  filter. Store the solution at room temperature.

Polyethylene glycol (PEG) is a straight-chain polymer of a simple repeating unit  $H(OCH_2 CH_2)_n OH$ . PEG is available in a range of molecular weights whose names reflect the number ( $n$ ) of repeating units in each molecule. In PEG 400, for example,  $n = 8-9$ , whereas in PEG 4000,  $n$  ranges from 68 to 84. PEG induces macromolecular crowding of solutes in aqueous solution (Zimmerman and Minton 1993) and has a range of uses in molecular cloning, including:

- **Precipitation of DNA molecules according to their size.** The concentration of PEG required for precipitation is in inverse proportion to the size of the DNA fragments (Lis and Schleif 1975a,b; Ogata and Gilbert 1977; Lis 1980); please see Chapter 1, Protocol 8, and Chapter 2, Protocol 6.
- **Precipitation and purification of bacteriophage particles** (Yamamoto et al. 1970).
- **Increasing the efficiency of reassociation of complementary chains** of nucleic acids during hybridization, blunt-end ligation of DNA molecules, and end-labeling of DNA with bacteriophage T4 polynucleotide kinase (Zimmerman and Minton 1993; please see the information panel on **CONDENSING AND CROWDING REAGENTS** in Chapter 1).
- **Fusion of cultured cells with bacterial protoplasts** (Schaffner 1980; Rassoulzadegan et al. 1982).

**Potassium Acetate (5 M)**

5 M potassium acetate	60 ml
glacial acetic acid <math>\langle ! \rangle</math>	11.5 ml
$H_2O$	28.5 ml

The resulting solution is 3 M with respect to potassium and 5 M with respect to acetate. Store the buffer at room temperature.

**SDS (20% w/v)**

Also called sodium lauryl sulfate. Dissolve 200 g of electrophoresis-grade SDS <math>\langle ! \rangle</math> in 900 ml of  $H_2O$ . Heat to 68°C and stir with a magnetic stirrer to assist dissolution. If necessary, adjust the pH to 7.2 by adding a few drops of concentrated HCl <math>\langle ! \rangle</math>. Adjust the volume to 1 liter with  $H_2O$ . Store at room temperature. Sterilization is not necessary. Do not autoclave.

**Silver Stain.** Please see staining section (Appendix 8).

**Sodium Acetate (3 M, pH 5.2 and pH 7.0)**

Dissolve 408.3 g of sodium acetate·3 $H_2O$  in 800 ml of  $H_2O$ . Adjust the pH to 5.2 with glacial acetic acid <math>\langle ! \rangle</math> or adjust the pH to 7.0 with dilute acetic acid. Adjust the volume to 1 liter with  $H_2O$ . Dispense into aliquots and sterilize by autoclaving.

**Spermidine (1 M)**

Dissolve 1.45 g of spermidine (free-base form) in 10 ml of deionized  $H_2O$  and sterilize by passing it through a 0.22- $\mu m$  filter. Store the solution in small aliquots at -20°C. Make a fresh stock solution of this reagent every month.

### SYBR Gold Staining Solution

SYBR Gold <!> (Molecular Probes) is supplied as a stock solution of unknown concentration in dimethylsulfoxide. Agarose gels are stained in a working solution of SYBR Gold, which is a 1:10,000 dilution of SYBR Gold nucleic acid stain in electrophoresis buffer. Prepare working stocks of SYBR Gold daily and store in the dark at regulated room temperature. For a discussion of staining agarose gels, please see Chapter 5, Protocol 2.

### Trichloroacetic Acid (TCA; 100% solution)

To a previously unopened bottle containing 500 g of TCA <!>, add 227 ml of H<sub>2</sub>O. The resulting solution will contain 100% (w/v) TCA.

### X-gal Solution (2% w/v)

X-gal is 5-bromo-4-chloro-3-indolyl-β-D-galactoside. Make a stock solution by dissolving X-gal in dimethylformamide <!> at a concentration of 20 mg/ml solution. Use a glass or polypropylene tube. Wrap the tube containing the solution in aluminum foil to prevent damage by light and store at -20°C. It is not necessary to sterilize X-gal solutions by filtration. Please see the information panel on X-GAL in Chapter 1.

																VII 17		VIII 18																													
I 1											III 13	IV 14	V 15	VI 16	H 1	He 2																															
1.00 H 1											10.81 B 5	12.01 C 6	14.00 N 7	15.99 O 8	18.99 F 9	20.17 Ne 10																															
6.94 Li 3	9.01 Be 4	Transition Metals										26.98 Al 13	28.08 Si 14	30.97 P 15	32.06 S 16	35.45 Cl 17	39.94 Ar 18																														
22.98 Na 11	24.3 Mg 12	3	4	5	6	7	8	9	10	11	12	69.72 Ga 31	72.59 Ge 32	74.92 As 33	78.96 Se 34	79.90 Br 35	83.80 Kr 36																														
39.09 K 19	40.08 Ca 20	44.95 Sc 21	47.88 Ti 22	50.94 V 23	51.99 Cr 24	54.93 Mn 25	55.84 Fe 26	58.93 Co 27	58.69 Ni 28	63.54 Cu 29	65.38 Zn 30	114.82 In 49	118.69 Sn 50	121.75 Sb 51	127.60 Te 52	126.90 I 53	131.29 Xe 54																														
85.46 Rb 37	87.62 Sr 38	86.90 Y 39	91.22 Zr 40	92.90 Nb 41	95.94 Mo 42	(96) Tc 43	101.07 Ru 44	102.90 Rh 45	106.42 Pd 46	107.86 Ag 47	112.41 Cd 48	200.59 Hg 80	204.38 Tl 81	207.2 Pb 82	208.98 Bi 83	(209) Po 84	(210) At 85	210.7 Rn 86																													
132.90 Cs 55	137.33 Ba 56	138.90 La 57-71	178.49 Hf 72	180.94 Ta 73	183.85 W 74	186.20 Re 75	190.2 Os 76	192.22 Ir 77	195.08 Pt 78	196.96 Au 79	200.59 Hg 80	204.38 Tl 81	207.2 Pb 82	208.98 Bi 83	(209) Po 84	(210) At 85	210.7 Rn 86																														
223 Fr 87	226.02 Ra 88	227.02 Ac 89-103	(261) Unq 104	(236) Unp 105	(261) Unh 106	(261) Uns 107																																									
<table border="1"> <tr> <td>140.12 Ce 58</td> <td>140.90 Pr 59</td> <td>144.24 Nd 60</td> <td>(145) Pm 61</td> <td>150.36 Sm 62</td> <td>151.96 Eu 63</td> <td>157.25 Gd 64</td> <td>158.92 Tb 65</td> <td>162.50 Dy 66</td> <td>164.93 Ho 67</td> <td>167.26 Er 68</td> <td>168.93 Tm 69</td> <td>173.04 Yb 70</td> <td>174.96 Lu 71</td> <td>Lanthanides</td> </tr> <tr> <td>232.03 Th 90</td> <td>231.03 Pa 91</td> <td>238.02 U 92</td> <td>237.04 Np 93</td> <td>(244) Pu 94</td> <td>(243) Am 95</td> <td>(247) Cm 96</td> <td>(247) Bk 97</td> <td>(251) Cf 98</td> <td>(252) Es 99</td> <td>(257) Fm 100</td> <td>(258) Md 101</td> <td>(259) No 102</td> <td>(260) Lr 103</td> <td>Actinides</td> </tr> </table>																		140.12 Ce 58	140.90 Pr 59	144.24 Nd 60	(145) Pm 61	150.36 Sm 62	151.96 Eu 63	157.25 Gd 64	158.92 Tb 65	162.50 Dy 66	164.93 Ho 67	167.26 Er 68	168.93 Tm 69	173.04 Yb 70	174.96 Lu 71	Lanthanides	232.03 Th 90	231.03 Pa 91	238.02 U 92	237.04 Np 93	(244) Pu 94	(243) Am 95	(247) Cm 96	(247) Bk 97	(251) Cf 98	(252) Es 99	(257) Fm 100	(258) Md 101	(259) No 102	(260) Lr 103	Actinides
140.12 Ce 58	140.90 Pr 59	144.24 Nd 60	(145) Pm 61	150.36 Sm 62	151.96 Eu 63	157.25 Gd 64	158.92 Tb 65	162.50 Dy 66	164.93 Ho 67	167.26 Er 68	168.93 Tm 69	173.04 Yb 70	174.96 Lu 71	Lanthanides																																	
232.03 Th 90	231.03 Pa 91	238.02 U 92	237.04 Np 93	(244) Pu 94	(243) Am 95	(247) Cm 96	(247) Bk 97	(251) Cf 98	(252) Es 99	(257) Fm 100	(258) Md 101	(259) No 102	(260) Lr 103	Actinides																																	

FIGURE A1-1 Periodic Table

Numbers in parentheses are the mass numbers of the most stable isotope of that element.



## REAGENTS AND BUFFERS INDEX

- $\lambda$  Annealing buffer, A1.20  
 Acids and bases, general, A1.6  
 Acrylamide solution, A1.25  
 Actinomycin D, A1.25  
 Adenosine diphosphate (ADP), A1.25  
 Alkaline agarose gel electrophoresis buffer, A1.17  
 Alkaline gel loading buffer, A1.18  
 Alkaline lysis solution I (plasmid preparation), A1.16  
 Alkaline lysis solution II (plasmid preparation), A1.16  
 Alkaline lysis solution III (plasmid preparation), A1.16  
 Alkaline transfer buffer (for alkaline transfer of DNA to nylon membranes), A1.12  
 Ammonium acetate, A1.25  
 Ammonium persulfate, A1.25  
 Amplification buffer, A1.9  
 ATP, A1.25  
 Bacteriophage T4 DNA ligase buffer, A1.9  
 Bacteriophage T4 DNA polymerase buffer, A1.10  
 Bacteriophage T4 polynucleotide kinase buffer, A1.10  
 BAL 31 buffer, A1.10  
 Blocking agents, general, A1.14  
 Blocking buffer (TNT buffer containing a blocking agent), A1.12  
 BLOTTO, A1.15  
 BPTE electrophoresis buffer, A1.17  
 Bromophenol blue solution, A1.18  
 Bromophenol blue sucrose solution, A1.19  
 Calcium chloride,  $\text{CaCl}_2$ , A1.25  
 Church buffer, A1.12  
 Coomassie staining solution, A1.26  
 Cresol red solution, A1.19  
 Denaturation solution (for neutral transfer, double-stranded DNA targets only), A1.12  
 Denhardt's reagent, A1.15  
 Deoxyribonucleoside triphosphate (dNTPs), A1.26  
 Dephosphorylation buffer, for use with CIP, A1.10  
 Dephosphorylation buffer, for use with SAP, A1.10  
 Dimethylsulfoxide (DMSO), A1.26  
 Dithiothreitol (DTT), A1.26  
 DNase I dilution buffer, A1.9  
 EcoRI methylase buffer, A1.10  
 EDTA, A1.26  
 EGTA, A1.26  
 Elution buffer (Qiagen), A1.20  
 Ethidium bromide, A1.26  
 Exonuclease II buffer, A1.10  
 Formaldehyde gel-loading buffer, A1.19  
 Formamide loading buffer, A1.19  
 Formamide, deionization of, A1.24  
 Gel loading buffers, 6X, A1.18  
 Gelatin, A1.27  
 Glycerol, A1.27  
 Glyoxal, deionization of, A1.24  
 Good buffers, general, A1.3  
 HCl, A1.12  
 Hybridization buffer with formamide (for RNA), A1.13  
 Hybridization buffer without formamide (for RNA), A1.13  
 IPTG (isopropylthio- $\beta$ -D-galactoside), A1.27  
 KCl, A1.27  
 Klenow buffer, A1.10  
 KOH/methanol solution, A1.20  
 LB freezing buffer, A1.20  
 Linker kinase buffer, A1.11  
 Lithium chloride (LiCl), A1.27  
 Lysozyme, A1.8  
 Lyticase, A1.8  
 Maltose, A1.27  
 $\text{MgCl}_2$ - $\text{CaCl}_2$  solution, A1.21  
 $\text{MgCl}_2 \cdot 6\text{H}_2\text{O}$  solution, A1.27  
 $\text{MgSO}_4$ , A1.27  
 MOPS electrophoresis buffer, A1.18  
 NaCl (sodium chloride), A1.27  
 NaOH, A1.27  
 Neutralization buffer I (for transfer of DNA to uncharged membranes), A1.13  
 Neutralization buffer II (for alkaline transfer of DNA to nylon membranes), A1.13  
 Neutralizing solution (for neutral transfer, double-stranded DNA targets only), A1.13  
 Nuclease S1 digestion buffer, A1.11  
 P3 buffer (Qiagen), A1.21  
 Pancreatic DNase I, A1.8  
 Pancreatic RNase, A1.8  
 PEG 8000, A1.28  
 PEG- $\text{MgCl}_2$  solution, A1.21  
 Phenol, A1.23  
   equilibration of, A1.23  
 Phenol:chloroform:Isoamyl alcohol (25:24:1), A1.23  
 Phosphate buffers, Gomori, A1.5  
 Phosphate-buffered saline (PBS), A1.7  
 Polymerase dilution buffer, A1.9  
 Potassium acetate, A1.28  
 Prehybridization solution (for dot, slot, and northern hybridization), A1.13  
 Prehybridization/hybridization solution (for hybridization in aqueous buffer), A1.13  
 Prehybridization/hybridization solution (for hybridization in formamide buffers), A1.13  
 Prehybridization/hybridization solution (for hybridization in phosphate-SDS buffer), A1.14  
 Prehybridization/hybridization solution (for plaque/colony lifts), A1.13  
 Proteinase K, A1.8  
 Proteinase K buffer, A1.11  
 QBT buffer (Qiagen), A1.21  
 Radioactive ink, A1.21  
 Reverse transcriptase buffer, A1.11  
 RNA gel-loading buffer, A1.19  
 RNase H buffer, A1.11  
 SDS, A1.28  
 SDS gel-loading buffer, A1.20  
 SDS-EDTA dye mix, A1.20  
 Sephacryl equilibration buffer, A1.21  
 Sequenase dilution buffer, A1.9  
 Silver stain, see staining section, A1.28  
 SM, A1.21  
 SM plus gelatin, A1.21  
 Sodium acetate, A1.28  
 Sorbitol buffer, A1.21  
 Spermidine, A1.28  
 SSC, A1.14  
 SSPE, A1.14  
 STE, A1.22  
 STET, A1.16  
 SYBR Gold staining solution, A1.29  
 TAE, A1.16  
 TAFE gel electrophoresis buffer, A1.18  
*Taq* dilution buffer, A1.9  
 TBE, A1.17  
 TEN buffer, A1.22  
 Terminal transferase buffer, A1.11  
 Terminal transferase (tailing) buffer, A1.11  
 TES, A1.22  
 TPE, A1.17  
 Trichloroacetic acid (TCA), A1.29  
 Tris buffers, general, A1.2  
 Tris Cl, A1.7  
 Tris EDTA (TE), A1.7  
 Tris magnesium buffer (TM), A1.8  
 Tris-buffered saline (TBS), A1.8  
 Tris-glycine, A1.17  
 Tris-sucrose, A1.22  
 Triton/SDS solution, A1.22  
 Tpsin, A1.8  
 Universal KGB (restriction endonuclease buffer), A1.12  
 Wash buffer (Qiagen), A1.22  
 X-gal solution, A1.29  
 Yeast resuspension buffer, A1.22  
 Zymolyase 5000, A1.8

# Appendix 2

---

## Media

<b>LIQUID MEDIA FOR <i>E. COLI</i></b>	A2.2
GYT Medium	A2.2
LB Medium (Luria-Bertani Medium)	A2.2
M9 Minimal Medium	A2.2
NZCYM Medium	A2.3
NZYM Medium	A2.3
NZM Medium	A2.3
SOB Medium	A2.3
SOC Medium	A2.3
Terrific Broth (TB)	A2.4
2x YT Medium	A2.4
<b>MEDIA CONTAINING AGAR OR AGAROSE</b>	A2.5
<b>STORAGE MEDIA</b>	A2.6
Liquid Cultures	A2.6
Stab Cultures	A2.6
<b>ANTIBIOTICS</b>	A2.6
<b>SOLUTIONS FOR WORKING WITH BACTERIOPHAGE <math>\lambda</math></b>	A2.8
Maltose	A2.8
SM	A2.8
TM	A2.8
<b>MEDIA FOR THE PROPAGATION AND SELECTION OF YEAST</b>	A2.9
CM or SC and Drop-out Media	A2.9
Drop-out Mix	A2.9
Supplemented Minimal Medium (SMM)	A2.9
Synthetic Dextrose Minimal Medium (SD)	A2.10
X-Gal Indicator Plates for Yeast	A2.10
X-Gal Plates for Lysed Yeast Cells on Filters	A2.12
YPD (YEPD) Medium	A2.12

## LIQUID MEDIA FOR *E. COLI*

---

▲ **IMPORTANT** Use distilled deionized H<sub>2</sub>O in all recipes. Unless otherwise stated, sterile media can be stored at room temperature.

### GYT Medium (Tung and Chow 1995)

10% (v/v) glycerol  
0.125% (w/v) yeast extract  
0.25% (w/v) tryptone

Sterilize the medium by passing it through a prerinsed 0.22- $\mu$ m filter. Store in 2.5-ml aliquots at 4°C.

### LB Medium (Luria-Bertani Medium)

Per liter:

To 950 ml of deionized H<sub>2</sub>O, add:

tryptone	10 g
yeast extract	5 g
NaCl	10 g

Shake until the solutes have dissolved. Adjust the pH to 7.0 with 5 N NaOH (~0.2 ml). Adjust the volume of the solution to 1 liter with deionized H<sub>2</sub>O. Sterilize by autoclaving for 20 minutes at 15 psi (1.05 kg/cm<sup>2</sup>) on liquid cycle.

### M9 Minimal Medium

Per liter:

To 750 ml of sterile H<sub>2</sub>O (cooled to 50°C or less), add:

5x M9 salts*	200 ml
1 M MgSO <sub>4</sub>	2 ml
20% solution of the appropriate carbon source (e.g., 20% glucose)	20 ml
1 M CaCl <sub>2</sub>	0.1 ml
sterile deionized H <sub>2</sub> O	to 980 ml

If necessary, supplement the M9 medium with stock solutions of the appropriate amino acids and vitamins.

\*5x M9 salts is made by dissolving the following salts in deionized H<sub>2</sub>O to a final volume of 1 liter:

Na <sub>2</sub> HPO <sub>4</sub> ·7H <sub>2</sub> O	64 g
KH <sub>2</sub> PO <sub>4</sub>	15 g
NaCl	2.5 g
NH <sub>4</sub> Cl	5.0 g

Divide the salt solution into 200-ml aliquots and sterilize by autoclaving for 15 minutes at 15 psi (1.05 kg/cm<sup>2</sup>) on liquid cycle.

Prepare the MgSO<sub>4</sub> and CaCl<sub>2</sub> solutions separately, sterilize by autoclaving, and add the solutions after diluting the 5x M9 salts to 980 ml with sterile H<sub>2</sub>O. Sterilize the glucose by passing it through a 0.22- $\mu$ m filter before it is added to the diluted M9 salts.

When using *E. coli* strains that carry a deletion of the proline biosynthetic operon [ $\Delta(lac-proAB)$ ] in the bacterial chromosome and the complementing *proAB* genes on the F' plasmid, supplement the M9 minimal medium with the following:

0.4% (w/v) glucose (dextrose)  
5 mM MgSO<sub>4</sub>·7H<sub>2</sub>O  
0.01% thiamine

**NZCYM Medium**

Per liter:

To 950 ml of deionized H<sub>2</sub>O, add:

NZ amine	10 g
NaCl	5 g
yeast extract	5 g
casamino acids	1 g
MgSO <sub>4</sub> ·7H <sub>2</sub> O	2 g

Shake until the solutes have dissolved. Adjust the pH to 7.0 with 5 N NaOH (~0.2 ml). Adjust the volume of the solution to 1 liter with deionized H<sub>2</sub>O. Sterilize by autoclaving for 20 minutes at 15 psi (1.05 kg/cm<sup>2</sup>) on liquid cycle.

NZ amine: Casein hydrolysate enzymatic (ICN Biochemicals). NZCYM, NZYM, and NZM are also available as dehydrated media from BD Biosciences.

**NZYM Medium**

NZYM medium is identical to NZCYM medium, except that casamino acids are omitted.

**NZM Medium**

NZM medium is identical to NZYM medium, except that yeast extract is omitted.

**SOB Medium**

Per liter:

To 950 ml of deionized H<sub>2</sub>O, add:

tryptone	20 g
yeast extract	5 g
NaCl	0.5 g

Shake until the solutes have dissolved. Add 10 ml of a 250 mM solution of KCl. (This solution is made by dissolving 1.86 g of KCl in 100 ml of deionized H<sub>2</sub>O.) Adjust the pH of the medium to 7.0 with 5 N NaOH (~0.2 ml). Adjust the volume of the solution to 1 liter with deionized H<sub>2</sub>O. Sterilize by autoclaving for 20 minutes at 15 psi (1.05 kg/cm<sup>2</sup>) on liquid cycle. Just before use, add 5 ml of a sterile solution of 2 M MgCl<sub>2</sub>. (This solution is made by dissolving 19 g of MgCl<sub>2</sub> in 90 ml of deionized H<sub>2</sub>O. Adjust the volume of the solution to 100 ml with deionized H<sub>2</sub>O and sterilize by autoclaving for 20 minutes at 15 psi [1.05 kg/cm<sup>2</sup>] on liquid cycle.)

**SOC Medium**

SOC medium is identical to SOB medium, except that it contains 20 mM glucose. After the SOB medium has been autoclaved, allow it to cool to 60°C or less. Add 20 ml of a sterile 1 M solution of glucose. (This solution is made by dissolving 18 g of glucose in 90 ml of deionized H<sub>2</sub>O. After the sugar has dissolved, adjust the volume of the solution to 100 ml with deionized H<sub>2</sub>O and sterilize by passing it through a 0.22- $\mu$ m filter.)

**Terrific Broth (also known as TB; Tartof and Hobbs 1987)**

Per liter:

To 900 ml of deionized H<sub>2</sub>O, add:

tryptone	12 g
yeast extract	24 g
glycerol	4 ml

Shake until the solutes have dissolved and then sterilize by autoclaving for 20 minutes at 15 psi (1.05 kg/cm<sup>2</sup>) on liquid cycle. Allow the solution to cool to 60°C or less, and then add 100 ml of a sterile solution of 0.17 M KH<sub>2</sub>PO<sub>4</sub>, 0.72 M K<sub>2</sub>HPO<sub>4</sub>. (This solution is made by dissolving 2.31 g of KH<sub>2</sub>PO<sub>4</sub> and 12.54 g of K<sub>2</sub>HPO<sub>4</sub> in 90 ml of deionized H<sub>2</sub>O. After the salts have dissolved, adjust the volume of the solution to 100 ml with deionized H<sub>2</sub>O and sterilize by autoclaving for 20 minutes at 15 psi [1.05 kg/cm<sup>2</sup>] on liquid cycle.)

**2× YT Medium**

Per liter:

To 900 ml of deionized H<sub>2</sub>O, add:

tryptone	16 g
yeast extract	10 g
NaCl	5 g

Shake until the solutes have dissolved. Adjust the pH to 7.0 with 5 N NaOH <!>. Adjust the volume of the solution to 1 liter with deionized H<sub>2</sub>O. Sterilize by autoclaving for 20 minutes at 15 psi (1.05 kg/cm<sup>2</sup>) on liquid cycle.

## MEDIA CONTAINING AGAR OR AGAROSE

---

▲ **IMPORTANT** Use distilled deionized H<sub>2</sub>O in all recipes.

Prepare liquid media according to the recipes given above. Just before autoclaving, add one of the following:

Bacto Agar (for plates)	15 g/liter
Bacto Agar (for top agar)	7 g/liter
agarose (for plates)	15 g/liter
agarose (for top agarose)	7 g/liter

Sterilize by autoclaving for 20 minutes at 15 psi (1.05 kg/cm<sup>2</sup>) on liquid cycle. When the medium is removed from the autoclave, swirl it gently to distribute the melted agar or agarose evenly throughout the solution. *Be careful!* The fluid may be superheated and may boil over when swirled. Allow the medium to cool to 50–60°C before adding thermolabile substances (e.g., antibiotics). To avoid producing air bubbles, mix the medium by swirling. Plates can then be poured directly from the flask; allow ~30–35 ml of medium per 90-mm plate. To remove bubbles from medium in the plate, flame the surface of the medium with a Bunsen burner before the agar or agarose hardens. Set up a color code (e.g., two red stripes for LB-ampicillin plates; one black stripe for LB plates, etc.) and mark the edges of the plates with the appropriate colored markers.

When the medium has hardened completely, invert the plates and store them at 4°C until needed. The plates should be removed from storage 1–2 hours before they are used. If the plates are fresh, they will “sweat” when incubated at 37°C. When this condensation drops on the agar/agarose surface, it allows bacterial colonies or bacteriophage plaques to spread and increases the chances of cross-contamination. This problem can be avoided by wiping off the condensation from the lids of the plates and then incubating the plates for several hours at 37°C in an inverted position before they are used. Alternatively, remove the liquid by shaking the lid with a single, quick motion. To minimize the possibility of contamination, hold the open plate in an inverted position while removing the liquid from the lid.

## STORAGE MEDIA

▲ **IMPORTANT** Use distilled deionized H<sub>2</sub>O in all recipes.

### Liquid Cultures

Bacteria growing on plates, or in liquid culture, can be stored in aliquots of LB medium containing 30% (v/v) sterile glycerol. Aliquots of 1 ml of LB with glycerol should be prepared and vortexed to ensure that the glycerol is completely dispersed. Alternatively, bacterial strains may be stored in LB freezing buffer:

*LB freezing buffer:*

- 36 mM K<sub>2</sub>HPO<sub>4</sub> (anhydrous)
- 13.2 mM KH<sub>2</sub>PO<sub>4</sub>
- 1.7 mM sodium citrate
- 0.4 mM MgSO<sub>4</sub>·7H<sub>2</sub>O
- 6.8 mM ammonium sulfate
- 4.4% (v/v) glycerol
- in LB

LB freezing buffer (Zimmer and Verrinder Gibbins 1997) is best made by dissolving the salts in 100 ml of LB to the specified concentrations. Measure 95.6 ml of the resulting solution into a fresh container, and then add 4.4 ml of glycerol. Mix the solution well and then sterilize by passing it through a 0.45- $\mu$ m disposable Nalgene filter. For more information on storage of bacterial cultures, please see Appendix 8.

### Stab Cultures

Prepare stab cultures in glass vials (2–3 ml) with screw-on caps fitted with rubber gaskets. Add molten LB agar until the vials are two-thirds full. Autoclave the partially filled vials (with their caps loosely screwed on) for 20 minutes at 15 psi (1.05 kg/cm<sup>2</sup>) on liquid cycle. Remove the vials from the autoclave, let them cool to room temperature, and then tighten the caps. Store the vials at room temperature until needed.

## ANTIBIOTICS

**TABLE A2-1** Commonly Used Antibiotic Solutions

	STOCK SOLUTION <sup>a</sup>		WORKING CONCENTRATION	
			STRINGENT PLASMIDS	RELAXED PLASMIDS
	CONCENTRATION	STORAGE		
Ampicillin	50 mg/ml in H <sub>2</sub> O	-20°C	20 $\mu$ g/ml	50 $\mu$ g/ml
Carbenicillin	50 mg/ml in H <sub>2</sub> O	-20°C	20 $\mu$ g/ml	60 $\mu$ g/ml
Chloramphenicol	34 mg/ml in ethanol	-20°C	25 $\mu$ g/ml	170 $\mu$ g/ml
Kanamycin	10 mg/ml in H <sub>2</sub> O	-20°C	10 $\mu$ g/ml	50 $\mu$ g/ml
Streptomycin	10 mg/ml in H <sub>2</sub> O	-20°C	10 $\mu$ g/ml	50 $\mu$ g/ml
Tetracycline <sup>b</sup>	5 mg/ml in ethanol	-20°C	10 $\mu$ g/ml	50 $\mu$ g/ml

<sup>a</sup>Magnesium ions are antagonists of tetracycline. Use media without magnesium salts (e.g., LB medium) for selection of bacteria resistant to tetracycline.

<sup>b</sup>Sterilize stock solutions of antibiotics dissolved in H<sub>2</sub>O by filtration through a 0.22- $\mu$ m filter.

<sup>c</sup>Antibiotics dissolved in ethanol need not be sterilized. Store solutions in light-tight containers.

TABLE A2-2 Antibiotic Modes of Action

ANTIBIOTIC	MOLECULAR WEIGHT	MODE OF ACTION	FURTHER INFORMATION
Actinomycin C <sub>1</sub> (actinomycin D)	1255.4	Inhibits synthesis of RNA by binding to double-stranded DNA.	
Amphotericin	924.1	Broad-spectrum antifungal agent from <i>Streptomyces</i> .	
Ampicillin	349.4	Inhibits cell-wall synthesis by interfering with peptidoglycan cross-linking.	Please see the information panel on <b>AMPICILLIN AND CARBENICILLIN</b> at the end of Chapter 1.
Bleomycin	n.a. <sup>4</sup>	Inhibits DNA synthesis; cleaves single-stranded DNA.	
Carbenicillin (disodium salt)	422.4	Inhibits bacterial wall synthesis.	
Chloramphenicol	323.1	Inhibits translation by blocking peptidyl transferase on the 50S ribosomal subunit; at higher concentrations can inhibit eukaryotic DNA synthesis.	Please see the information panel on <b>CHLORAMPHENICOL</b> at the end of Chapter 1.
Geneticin (G418 geneticin disulfate)	692.7	Aminoglycoside is toxic to a broad range of cell types (bacterial, higher plant, yeast, mammalian, protozoans, helminths); used in selection of eukaryotic cells transformed with neomycin resistance genes.	
Gentamycin	692.7	Inhibits protein synthesis by binding to L6 protein of the 50S ribosomal subunit.	
Hygromycin B	527.5	Inhibits protein synthesis.	
Kanamycin monosulfate	582.6	Broad-spectrum antibiotic; binds to 70S ribosomal subunit and inhibits growth of gram-positive and gram-negative bacteria and mycoplasmas.	Please see the information panel on <b>KANAMYCINS</b> at the end of Chapter 1.
Methotrexate	454.45	A folic acid analog; a powerful inhibitor of the enzyme dihydrofolate reductase.	
Mitomycin C	334.33	Inhibits DNA synthesis; antibacterial to gram-positive, gram-negative, and acid-fast bacilli.	
Neomycin B sulfate	908.9	Binds to 30S ribosomal subunit and inhibits bacterial protein synthesis.	
Novobiocin sodium salt	634.62	Bacteriostatic antibiotic; inhibits growth of gram-positive bacteria.	
Penicillin G sodium salt	356.4	Inhibits peptidoglycan synthesis in bacterial cell walls.	
Puromycin dihydrochloride	544.4	Inhibits protein synthesis by acting as an analog of aminoacyl tRNA (causes premature chain termination).	
Rifampicin	823.0	Strongly inhibits prokaryotic RNA polymerase and mammalian RNA polymerase to a lesser degree.	
Streptomycin sulfate	1457.4	Inhibits protein synthesis; binds to 30S ribosomal subunit.	
Tetracycline hydrochloride	480.9	Inhibits bacterial protein synthesis; blocks ribosomal binding of aminoacyl-tRNA.	Please see the information panel on <b>TETRACYCLINE</b> at the end of Chapter 1.

<sup>4</sup>n.a. indicates not available.



## SOLUTIONS FOR WORKING WITH BACTERIOPHAGE $\lambda$

---

▲ **IMPORTANT** Use distilled deionized H<sub>2</sub>O in all recipes.

### Maltose

Maltose, an inducer of the gene (*lamB*) that encodes the bacteriophage  $\lambda$  receptor, is often added to the medium during growth of bacteria that are to be used for plating bacteriophage  $\lambda$ . Add 1 ml of a sterile 20% maltose solution for every 100 ml of medium. For a further discussion of the use of maltose, please see the Materials list in Chapter 2, Protocol 1. Make up a sterile 20% stock solution of maltose as follows:

maltose	20 g
H <sub>2</sub> O	to 100 ml

Sterilize the solution by passing it through a 0.22- $\mu$ m filter. Store the sterile solution at room temperature.

### SM

This buffer is used for storage and dilution of bacteriophage  $\lambda$  stocks.

Per liter:

NaCl	5.8 g
MgSO <sub>4</sub> ·7H <sub>2</sub> O	2 g
1 M Tris-Cl (pH 7.5)	50 ml
2% gelatin solution	5 ml
H <sub>2</sub> O	to 1 liter

Sterilize the buffer by autoclaving for 20 minutes at 15 psi (1.05 kg/cm<sup>2</sup>) on liquid cycle. After the solution has cooled, dispense 50-ml aliquots into sterile containers. SM may be stored indefinitely at room temperature.

A 2% gelatin solution is made by adding 2 g of gelatin to a total volume of 100 ml of H<sub>2</sub>O and autoclaving the solution for 15 minutes at 15 psi (1.05 kg/cm<sup>2</sup>) on liquid cycle.

### TM

Per liter:

1 M Tris-Cl (pH 7.5)	50 ml
MgSO <sub>4</sub> ·7H <sub>2</sub> O	2 g
H <sub>2</sub> O	to 1 liter

Sterilize the buffer by autoclaving for 20 minutes at 15 psi (1.05 kg/cm<sup>2</sup>) on liquid cycle. After the solution has cooled, dispense 50-ml aliquots into sterile containers. TM may be stored indefinitely at room temperature.

**MEDIA FOR THE PROPAGATION AND SELECTION OF YEAST\***

- ▲ **CAUTION** Please see Appendix 12 for appropriate handling of materials marked with <!>,  
 ▲ **IMPORTANT** Use distilled deionized H<sub>2</sub>O in all recipes. Unless otherwise stated, media and solutions are sterilized by autoclaving at 15 psi (1.05 kg/cm<sup>2</sup>) for 15–20 minutes.

**Complete Minimal (CM) or Synthetic Complete (SC) and Drop-out Media**

To test the growth requirements of strains, it is useful to have media in which each of the commonly encountered auxotrophies is supplemented except the one of interest (drop-out media). Dry growth supplements are stored premixed. CM (or SC) is a medium in which the drop-out mix contains all possible supplements (i.e., nothing is “dropped out”).

yeast nitrogen base without amino acids*	6.7 g
glucose	20 g
Bacto Agar	20 g
drop-out mix	2 g
H <sub>2</sub> O	to 1000 ml

\*Yeast nitrogen base without amino acids (YNB) is sold either with or without ammonium sulfate. This recipe is for YNB with ammonium sulfate. If the bottle of YNB is lacking ammonium sulfate, add 5 g of ammonium sulfate and only 1.7 g of YNB.

**Drop-out Mix**

Combine the appropriate ingredients, minus the relevant supplements, and mix in a sealed container. Turn the container end-over-end for at least 15 minutes; add a few clean marbles to help mix the solids.

Adenine	0.5 g
Alanine	2.0 g
Arginine	2.0 g
Asparagine	2.0 g
Aspartic acid	2.0 g
Cysteine	2.0 g
Glutamine	2.0 g
Glutamic acid	2.0 g
Glycine	2.0 g
Histidine	2.0 g
Inositol	2.0 g
Isoleucine	2.0 g
Leucine	10.0 g
Lysine	2.0 g
Methionine	2.0 g
<i>para</i> -Aminobenzoic acid	0.2 g
Phenylalanine	2.0 g
Proline	2.0 g
Serine	2.0 g
Threonine	2.0 g
Tryptophan	2.0 g
Tyrosine	2.0 g
Uracil	2.0 g
Valine	2.0 g

\*Reprinted from Adams et al. (1998).

**TABLE A2-3 Components of Supplemented Minimal Media**

CONSTITUENT	STOCK CONCENTRATION (G/100 ML)	VOLUME FOR 1 LITER OF STOCK OF MEDIUM (ML)	FINAL CONCENTRATION IN MEDIUM (MG/LITER)	VOLUME OF STOCK TO SPREAD ON PLATE (ML)
Adenine sulfate	0.2 <sup>a</sup>	10	20	0.2
Uracil	0.2 <sup>a</sup>	10	20	0.2
L-Tryptophan	1	2	20	0.1
L-Histidine HCl	1	2	20	0.1
L-Arginine LiCl	1	2	20	0.1
L-Methionine	1	2	20	0.1
L-Tyrosine	0.2	15	30	0.2
L-Leucine	1	10	100	0.1
L-Isoleucine	1	3	30	0.1
L-Lysine HCl	1	3	30	0.1
L-Phenylalanine	1 <sup>a</sup>	5	50	0.1
L-Glutamic acid	1 <sup>a</sup>	10	100	0.2
L-Aspartic acid	1 <sup>a,b</sup>	10	100	0.2
L-Valine	3	5	150	0.1
L-Threonine	4 <sup>a,b</sup>	5	200	0.1
L-Serine	8	5	400	0.1

<sup>a</sup>Store at room temperature.

<sup>b</sup>Add after autoclaving the medium.

### Supplemented Minimal Medium (SMM)

SMM is SD (please see below) to which various growth supplements have been added. These solutions can then be stored for extended periods. Some should be stored at room temperature, in order to prevent precipitation, whereas the other solutions may be refrigerated. Wherever applicable, HCl salts of amino acids are preferred.

Prepare the medium by adding the appropriate volumes of the stock solutions to the ingredients of SD medium and then adjusting the total volume to 1 liter with distilled H<sub>2</sub>O. Add threonine and aspartic acid solutions separately to the medium after it is autoclaved.

Alternatively, it is often more convenient to prepare the medium by spreading a small quantity of the supplement(s) on the surface of an SD plate. Allow the solution(s) to then dry thoroughly onto the plate before inoculating it with yeast strains.

Table A2-3 provides the concentrations of the stock solutions, the volume of stock solution necessary for mixing 1 liter of medium, the volume of stock solution to spread on SD plates, and the final concentration of each constituent in SMM.

### Synthetic Dextrose Minimal Medium (SD)

SD is a synthetic minimal medium containing salts, trace elements, vitamins, a nitrogen source (yeast nitrogen base without amino acids), and glucose.

yeast nitrogen base without amino acids*	6.7 g
glucose	20 g
Bacto Agar	20 g
H <sub>2</sub> O	1000 ml

\*Please see note to recipe for CM on p. A2.9.

### X-Gal Indicator Plates for Yeast

Because 5-bromo-4-chloro-3-indolyl- $\beta$ -D-galactoside (X-gal <math>\beta</math>) does not work for yeast at the normal acidic pH of SD medium, a medium at neutral pH medium is used. This

choice is clearly a trade-off as many yeast strains will not grow well at neutral pH. For each liter of X-gal indicator plates, prepare the following solutions:

**Solution I**

10x phosphate-buffered stock solution	100 ml
1000x mineral stock solution (see recipe below)	1 ml
drop-out mix (see Drop-out Mix above)	2 g

Adjust the volume to 450 ml with distilled H<sub>2</sub>O if the medium is to contain glucose or to 400 ml if it is to contain galactose.

*10x Phosphate-buffered Stock Solution*

KH <sub>2</sub> PO <sub>4</sub> (1 M)	136.1 g
(NH <sub>4</sub> ) <sub>2</sub> SO <sub>4</sub> (0.15 M)	19.8 g
KOH (0.75 N) <!>	42.1 g
H <sub>2</sub> O	1000 ml

Adjust the pH to 7.0 and autoclave.

*1000x Mineral Stock Solution*

FeCl <sub>3</sub> (2 mM)	32 mg
MgSO <sub>4</sub> ·7H <sub>2</sub> O (0.8 M)	19.72 g
H <sub>2</sub> O	100 ml

Autoclave and store. This solution will develop a fine yellow precipitate, which should be resuspended before use.

**Solution II**

Mix in a 2-liter flask:

Bacto Agar	20 g
H <sub>2</sub> O	500 ml

- Autoclave Solutions I and II separately.
- After cooling to below 65°C, add the following components to Solution I:
 

glucose or other sugar to a final concentration of 2%	
X-gal (20 mg/ml dissolved in dimethylformamide <!>)	2 ml
100x vitamin stock solution	10 ml
- Include any other heat-sensitive supplements at this point.
- Mix Solutions I and II together and pour ~30 ml/plate.

*100x Vitamin Stock Solution*

thiamine (0.04 mg/ml)	4 mg
biotin (2 µg/ml)	0.2 mg
pyridoxine (0.04 mg/ml)	4 mg
inositol (0.2 mg/ml)	20 mg
pantothenic acid (0.04 mg/ml)	4 mg
H <sub>2</sub> O	100 ml

Sterilize by passing the solution through a 0.22-µm filter.

**X-Gal Plates for Lysed Yeast Cells on Filters**

These plates are used for checking  $\beta$ -galactosidase activity in cells that have been lysed and are immobilized on Whatman 3MM filters.

Bacto Agar	20 g
1 M $\text{Na}_2\text{HPO}_4$	57.7 ml
1 M $\text{NaH}_2\text{PO}_4$	42.3 ml
$\text{MgSO}_4$	0.25 g
$\text{H}_2\text{O}$	900 ml

After autoclaving, add 6 ml of X-gal solution (20 mg/ml in dimethylformamide).

**YPD (YEED) Medium**

YPD is a complex medium for routine growth of yeast.

yeast extract	10 g
peptone	20 g
glucose	20 g
$\text{H}_2\text{O}$	to 1000 ml

To prepare plates, add 20 g of Bacto Agar (2%) before autoclaving.

# Appendix 3

---

## Vectors and Bacterial Strains

<b>TABLE A3-1 VECTORS</b>	A3.2
Plasmids/Phagemids	A3.2
$\lambda$ Vectors	A3.3
Mammalian Vectors	A3.3
Yeast Vectors	A3.4
Shuttle Vectors	A3.4
Other Vectors	A3.5
<b>TABLE A3-2 BACTERIAL STRAINS</b>	A3.6

TABLE A3-1 Vectors

PLASMIDS/PHAGEMIDS	SUPPLIER	APPLICATION	SELECTION	PROMOTERS
pACYC	NEB	Cloning (low copy number)	Kan, Amp	
pBC KS +/-	Stratagene	DNA sequencing; in vitro transcription	Cam	T3, T7
pBluescript II	Stratagene	DNA sequencing; in vitro transcription	Amp	T3, T7
pBluescript SK <sup>-</sup> (Chapter 11, Figure 11-7)	Stratagene	Cloning; expression; in vitro transcription	Amp	T3, T7
pBR313	ATCC	Cloning	Amp	
pBR322 (Chapter 8, Figure 8-11)	Various (NEB)	Molecular-weight markers; subcloning (low copy number)	Amp/Tet	
pBR327	ATCC	Cloning	Amp	(derived pBR322)
pBS	Stratagene	DNA rescue; DNA sequencing; expression of fusion proteins	Amp	T7, T3
pCR1000	Invitrogen	Cloning	Amp	(derived pUC19)
pET series (Chapter 15)	Various (Novagen)	Protein expression; protein purification	Amp	T7
pGEM series	Promega	DNA sequencing; in vitro mutagenesis		T7/SP6
pGEM T	Promega	Cloning PCR products	Amp	T7/SP6
PGEM-3Z (Chapter 17, Figure 17-5)	Promega	General cloning; in vitro transcription	Amp	
pGEMZF	Promega	General cloning; in vitro transcription; production of single-stranded DNA	Amp	
pGEX series	ATCC	Cloning; GST fusion vector	Amp	<i>P<sub>tac</sub></i>
pMAL series (Chapter 15)	NEB	Protein expression	Amp	<i>P<sub>tac</sub></i>
pMB1	-	Cloning	Tet	
pMB1/colE1	-	Cloning	Tet	
pMOB45	ATCC	Cloning	Cam	
pPCR-Script Direct	Stratagene			
pSC101	ATCC	Cloning	Tet	
pSE280	Invitrogen			
PSP18/19	-	Cloning	Amp	T7/SP6
pSPORT1	Life Technologies	cDNA cloning; in vitro transcription; and subtraction library procedures	Amp	T7/SP6, <i>lacI</i>
pTrx (Chapter 15)	-	<i>E. coli</i> expression; thioredoxin fusion vector	$\beta$ -lactamase	$\lambda p_L$
pTrxFus (Chapter 15)	-	<i>E. coli</i> expression; thioredoxin fusion vector	$\beta$ -lactamase	$\lambda p_L$
pTZ18	Pharmacia, USB	Cloning; mutagenesis; transcription	B/w screen	
pUC vectors	Various	General cloning	Amp	
pUC17	Stratagene	General cloning	Amp	

pUC19 (Chapter 1, Figure 1-11)	Various	General cloning	Amp	
pXf3	ATCC	Cloning	Amp	
pZL1 (Chapter 11, Figure 11-9)	Life Technologies	Cloning; cDNA expression; transcription	Amp	
R6K	ATCC	Cloning	Amp	
<b>λ VECTORS</b>	<b>SUPPLIER</b>	<b>APPLICATION</b>	<b>CAPACITY</b>	<b>FEATURES</b>
λ2001	ATCC	Cloning (replacement vector)	10–23 kb	Generates Spi <sup>+</sup> CI <sup>-</sup> Gam <sup>-</sup> Int <sup>-</sup> Red recombinants
λDASH	Stratagene	Genomic libraries; restriction mapping; chromosome walking	9–23 kb	T3/T7 promoters
λ EMBL series	Various	Cloning; library construction		Spi/P2 selection against non- recombinants
λFIX	Stratagene	Genomic libraries; restriction mapping; chromosome walking	9–23 kb	T3/T7 promoters
λgt10	NEB, Stratagene	cDNA libraries	7.6 kb	Carries <i>imm434 cl</i> (disrupted by insertion)
λgt11-23	Various (NEB, Stratagene)	cDNA libraries	7.6 kb	Fusion protein under control of <i>lac</i> promoter
λZAP Express	Stratagene	cDNA libraries	12 kb	
λZipLox	Life Technologies	cDNA libraries	7 kb	<i>lac</i> promoter; <i>loxP</i> sequences
φX174	NEB	Best molecular-weight standard for electron microscopy	n.a. <sup>a</sup>	
Charon 32-35 and 40	–	Cloning recombinogenic sequences		<i>red gam</i> <sup>+</sup> recombinants
SurfZAP	Stratagene	Peptide display; expression; in vitro transcription		T3/T7, <i>lac</i> promoters
<b>MAMMALIAN VECTORS</b>	<b>SUPPLIER</b>	<b>APPLICATION</b>	<b>FEATURES</b>	
pBK-CMV (Chapter 11, Figure 11-8)	Stratagene	Construction of cDNA libraries	CMV promoter, T3/T7 promoters	
pβ-gal series (Chapter 17, Figure 17-5)	CLONTECH	Expression: β-galactosidase reporter; analysis of cloned regulatory elements	SV40 early promoter and enhancer	
pCAT3 series (Chapter 17, Figure 17-3)	Stratagene	Expression: chloramphenicol acetyltransferase reporter; analysis of cloned regulatory elements	SV40 promoter and enhancer	
pcDNA3.1 (+/–) (Chapter 11, Figure 11-13)	Invitrogen	High-level expression	CMV promoter, Neo selection	
pCMV1,2,3,4,5,6	ATCC	Construction of cDNA expression libraries; high- level expression	CMV promoter, SV40 early promoter and enhancer	
pCMVScript (Chapter 11, Figure 11-12)	Stratagene	Expression	CMV immediate early promoter	

(Continued on the following pages.)



TABLE A3-1 (Continued)

MAMMALIAN VECTORS	SUPPLIER	APPLICATION	FEATURES	
pCMV-SPORT- $\beta$ -gal (Chapter 16, Figure 16-2)	Life Technologies	Reporter vector used to monitor transfection efficiency	CMV promoter preceding the <i>E. coli</i> $\beta$ -galactosidase gene	
p $\lambda$ 2EGFP series (Chapter 17, Figure 17-13)	CLONTECH	Expression: GFP reporter; analysis of cloned regulatory elements	SV40 early promoter and enhancer	
pGL3 series (Chapter 17, Figure 17-4)	Promega	Expression: luciferase reporter; analysis of cloned regulatory elements	SV40 early promoter and enhancer	
pIND(SP1)/V5-His A (Chapter 17, Figure 17-10)	Invitrogen	Inducible expression: ecdysone regulation; expression of target gene controlled by modified ecdysone (glucocorticoid) receptor	Heat shock minimal and SV40 promoter; ecdysone/glucocorticoid response elements; SP1 enhancer	
pSPI.3 (Chapter 11, Figure 11-17)	Life Technologies	Exon trapping	Splice donor/splice acceptor sequences	
pTet-Splice (Chapter 17, Figure 17-9)	Life Technologies	Inducible expression: tetracycline regulation	Tet promoter	
pTet-tTak (Chapter 17, Figure 17-9)	Life Technologies	Inducible expression: produces tetracycline <i>trans</i> -activator	Basal CMV promoter and Tet operator	
pVgRXR	Invitrogen	Inducible expression: ecdysone regulation; produces the modified ecdysone (glucocorticoid) receptor	RSV, CMV, and SV40 promoters	
YEAST VECTORS	SUPPLIER	APPLICATION	SELECTION	REGULATORY ELEMENTS
pB42AD (pJG-4)	CLONTECH	Two-hybrid selection: library construction of genes fused to the B42 activation domain	<i>TRP1</i>	GAL1 promoter
PEG202	OriGene, CLONTECH	Two-hybrid selection: fusion of LexA DNA-binding domain to bait	<i>HIS3</i>	ADH1 promoter
pGILDA	CLONTECH	Two-hybrid selection: fusion of LexA DNA-binding domain to bait	<i>HIS3</i>	GAL1 promoter
pRFHM1	OriGene	Two-hybrid (control): nonactivating fusion of bicoid homeodomain to LexA	<i>HIS3</i>	ADH1 promoter
pSH17-4	OriGene	Two-hybrid (control): activating fusion of GAL4 domain to LexA	<i>HIS3</i>	ADH1 promoter
YAC (e.g., pYAC4) (Chapter 4, Figure 4-12)	ATCC, Sigma	Artificial chromosome cloning vector	Amp, <i>ARS1</i>	<i>Tetrahymena</i> telomere sequence
SHUTTLE VECTORS (REPLICATE IN BOTH <i>E. COLI</i> AND <i>S. CEREVISIAE</i> )	SUPPLIER	APPLICATION	SELECTION	REGULATORY ELEMENTS
YIp (yeast integrating plasmid; e.g., pRS303, 304, 305, 306)	ATCC	Plasmid must integrate into yeast chromosome to be maintained	Yeast: <i>HIS3</i> , <i>TRP1</i> , <i>LEU2</i> , <i>URA3</i> , respectively; <i>E. coli</i> : Amp	<i>E. coli</i> : pBluescript backbone (f1 +/- origin; colE1 origin)

YCp (yeast centromere plasmid; e.g., pRS313, 314, 315, 316)	ATCC	Maintained at low copy number; very stable propagation	Yeast: <i>HIS3</i> , <i>TRP1</i> , <i>LEU2</i> , <i>URA3</i> , respectively; <i>E. coli</i> : Amp	Yeast: low copy number due to centromere <i>E. coli</i> : pBluescript backbone (f1 +/- origin; colE1 origin)
YEp (yeast episomal plasmid; e.g., pRS323, 324, 325, 326)	ATCC	High-copy-number propagation of cloned genes	Yeast: <i>HIS3</i> , <i>TRP1</i> , <i>LEU2</i> , <i>URA3</i> , respectively; <i>E. coli</i> : Amp	<i>E. coli</i> : pBluescript backbone (f1 +/- origin; colE1 origin)
YRp (yeast replicating plasmid)	ATCC	Yeast genetic analysis		
pJK101	Origene	Two hybrid selection: test in repression assay	Yeast: <i>URA3</i> <i>E. coli</i> : Amp	
pSH18-34 (or pMW111, 112)	OriGene, Invitrogen, CLONTECH	Two hybrid selection: test for transcriptional activation assay	Yeast: <i>URA3</i> <i>E. coli</i> : Amp (pMW-Kan)	

OTHER VECTORS	SUPPLIERS	APPLICATION	SELECTION	FEATURES
BAC (e.g., pBeloBAC11) (Chapter 4, Figure 4-2)	NEB	Genomic cloning: 120–300 kb	Cam	<i>loxP</i> , <i>cosN</i> sites
Cosmid (e.g., SuperCos1) (Chapter 4, Figures 4-4 and 4-8)	Stratagene	Genomic cloning: 30–45 kb	Amp, Neo	T3, T7 promoters, <i>SV40 ori</i>
Cosmid (e.g., pJB8) (Chapter 4, Figure 4-7)	ATCC	Genomic cloning: 30–45 kb	Amp	
M13 (Phagescript SK) (Chapter 3, Figure 3-1)	Stratagene	Cloning; sequencing; mutagenesis		T3, T7 promoters
P1 (e.g., pAD10SacBII) (Chapter 4, Figure 4-3)	–	Genomic cloning: 70–100 kb	Kan	<i>loxP</i> sites
PAC: (e.g., pCYPAC1) (Chapter 4, Figure 4-4)	–	Genomic cloning: 130–150 kb	Kan, <i>sacB</i>	<i>loxP</i> sites

The details of Table A3-1 have been assembled from various sources, including the American Type Culture Collection (ATCC) Web Site ([www.atcc.org](http://www.atcc.org)), the Vector Database ([www.vectordb.atcc.com](http://www.vectordb.atcc.com)), and various company (supplier) Web Sites. Please note that vectors sold by different companies, even with the same name, may vary slightly. Figures for vectors that are included in this manual are cited; for other vector figures, please see appropriate supplier.

“n.a.” indicates not available.

TABLE A3-2 Bacterial Strains

STRAIN	RELEVANT GENOTYPE	REMARKS
71/18	<i>supE thi Δ(lac-proAB)</i> F' [ <i>ProAB<sup>+</sup> lac<sup>N</sup> lacZ ΔM15</i> ]	A strain used for growth of phagemids. The F' in this strain carries <i>lacZ</i> ΔM15, which permits α-complementation with the amino terminus of β-galactosidase encoded in λZAP. The strain makes high levels of Lac repressor and can be used for inducible expression of genes that are under the control of the <i>lac</i> promoter and for detection of recombinants expressing β-galactosidase fusion proteins (Messing et al. 1977; Dente et al. 1983; Rütther and Müller-Hill 1983).
BB4	<i>supE58 supE44 hsdR514 galK2 galT22</i> <i>trpR55 metB1 tonA ΔlacU169</i> F' [ <i>ProAB<sup>+</sup> lac<sup>N</sup> lacZ ΔM15 Tn10(ter<sup>r</sup>)</i> ]	A <i>recA<sup>+</sup></i> strain used for growth of λZAP and other λ bacteriophages. The F' in this strain carries <i>lacZ</i> ΔM15, which permits α-complementation with the amino terminus of β-galactosidase encoded in λZAP. The F' allows superinfection with an M13 helper bacteriophage, a step required for converting a recombinant λZAP to a pBluescript plasmid (Bullock et al. 1987).
BHB2688	(N205 <i>recA</i> [ <i>λimm434 cIts b2 red Eam</i> Sam/λ])	A bacteriophage λ lysogen used to prepare packaging extracts (Hohn and Murray 1977; Hohn 1979).
BHB2690	(N205 <i>recA</i> [ <i>λimm434 cIts b2 red Dam</i> Sam/λ])	A bacteriophage λ lysogen used to prepare packaging extracts (Hohn and Murray 1977; Hohn 1979).
BL21 (DE3 a.k.a. "Origami")	<i>hsdS gal (λcIts857 ind1 Sam7 nin5</i> <i>lacUV5-T7 gene 1)</i>	A strain used for high-level expression of genes cloned into expression vectors containing the bacteriophage T7 promoter (e.g., the pET series). The gene encoding bacteriophage T7 RNA polymerase is carried on the bacteriophage λDE3, which is integrated into the chromosome of BL21 (Studier and Moffatt 1986).
BNN102 (C600/ <i>hflA</i> )	<i>supE44 hsdR thi-1 thr-1 leuB6 lacY1</i> <i>tonA21 hflA150 [chr::Tn10(ter<sup>r</sup>)]</i>	An <i>hflA</i> strain used to select λgt10 recombinants. The <i>hflA</i> mutation suppresses plaque formation by <i>cI<sup>+</sup></i> bacteriophages but allows plaque formation by recombinant <i>cI<sup>-</sup></i> bacteriophages (Young and Davis 1983a).
C-1a	Wild-type strain	A wild-type clone of <i>E. coli</i> strain C that has been maintained on minimal medium for several years. <i>E. coli</i> C is F <sup>-</sup> and lacks host restriction and modification activity. It is a nonsuppressing host strain used in complementation tests with amber mutants of bacteriophage λ (Bertani and Weigle 1953; Borck et al. 1976).
C600 (BNN93)	<i>supE44 hsdR thi-1 thr-1 leuB6 lacY1</i> <i>tonA21</i>	An amber suppressing strain often used for making lysates (Appleyard 1954) and for propagation of λgt10 (Young and Davis 1983a).
CES200	<i>sbcB15 recB21 recC22 hsdR</i>	A strain used for growth of Spi <sup>-</sup> bacteriophages (Nader et al. 1985).
CES201	<i>recA sbcB15 recB21 recC22 hsdR</i>	A recombination-deficient strain used for growth of Spi <sup>-</sup> bacteriophages (Wyman and Wertman 1987).
CJ236	<i>dut1 ung1 thi-1 relA1/pCJ105(cam<sup>r</sup> F')</i>	A <i>dut ung</i> strain used to prepare uracil-containing DNA for use as templates in in vitro mutagenesis (Kunkel et al. 1987). pCJ105 carries an F' and <i>cam<sup>r</sup></i> ; growth of CJ236 in the presence of chloramphenicol selects for retention of the F'.
CSH18	<i>supE thi Δ(lac-pro)</i> F' [ <i>ProAB<sup>+</sup> lacZ</i> ]	An amber suppressing strain used to screen recombinants made in bacteriophage λ vectors carrying a <i>lacZ</i> gene in the stuffer fragments. These vectors give rise to blue plaques in the presence of the chromogenic substrate X-gal; recombinants in which the stuffer fragment has been replaced by foreign DNA give rise to white plaques (Miller 1972; Williams and Blattner 1979).
DE3 (Origami)	Please see BL21	
DH1	<i>supE44 hsdR17 recA1 endA1 gyrA96</i> <i>thi-1 relA1</i>	A recombination-deficient amber suppressing strain used for plating and growth of bacteria transformed by plasmids and cosmids (Low 1968; Meselson and Yuan 1968; Hanahan 1983).
DH5	<i>supE44 hsdR17 recA1 endA1 gyrA96</i> <i>thi-1 relA1</i>	A recombination-deficient amber suppressing strain used for plating and growth of plasmids and cosmids (Low 1968; Meselson and Yuan 1968; Hanahan 1983). This strain has a higher transformation efficiency than DH1.

DH5 $\alpha$	<i>supE44 lacU'169 (o80 lacZ <math>\Delta</math>M15) hsdR17 recA1 endA1 gyrA96 thi-1 relA1</i>	A recombination-deficient amber suppressing strain used for plating and growth of plasmids and <i>hsdR17 recA1 endA1 gyrA96 thi-1 relA1</i> cosmids. The o80 <i>lacZ</i> $\Delta$ M15 mutation permits $\alpha$ -complementation with the amino terminus of $\beta$ -galactosidase encoded in pUC vectors (Hanahan 1983).
DH5 $\alpha$ MICR	<i>F' mcrA <math>\Delta</math>(mrr-hsdRMS-mcrBC) o80 lacZ <math>\Delta</math>M15 (lacZYA-argF)supE44 hsdR17 recA1 endA1 gyrA96 thi-1 relA1</i>	A host for pUC and other $\alpha$ -complementation vectors; used for generating genomic libraries containing methylated cytosine or adenine residues.
DH110B	<i><math>\Delta</math>(mrr-hsdRMS-mcrBC) mcrA recA1</i>	A recombination-defective strain used for the propagation of BACs.
DH11S	<i><math>\Delta</math>(lac-proAB) <math>\Delta</math>(recA1398) <math>\Delta</math>(mrr-hsdRMS-mcrBC) mcrA deoR rpsL srl'</i>	A recombination-deficient strain used for growth of phagemids; the strain facilitates cloning of methylated genomic DNA and enhances transformation by large plasmids (Lin et al. 1992).
DP50 <i>supF</i>	<i>F'[proAB lacI<sup>q</sup> lacZ <math>\Delta</math>M15] supE44 supF58 hsdS3(r<sub>B</sub><sup>-</sup>m<sub>B</sub><sup>-</sup>) dapI<math>\Delta</math>8 lacY1 glnV44 <math>\Delta</math>(gal-twrB)47 tyrT58 gyrA29 tonA <math>\Delta</math>(thyA57)</i>	A strain used for isolation and propagation of bacteriophage $\lambda$ recombinants (Leder et al. 1977; B. Bachmann, pers. comm.).
ED8654	<i>supE supF hsdR metB lacY gal trpR</i>	An amber suppressing strain commonly used to propagate bacteriophage $\lambda$ vectors and their recombinants (Borck et al. 1976; Murray et al. 1977).
ED8767	<i>supE44 supF58 hsdS3(r<sub>B</sub><sup>-</sup>m<sub>B</sub><sup>-</sup>) recA56 galK2 galT22 metB1</i>	A recombination-deficient suppressing strain used for propagation of bacteriophage $\lambda$ vectors (Murray et al. 1977).
HB101	<i>supE44 hsdS20(r<sub>B</sub><sup>-</sup>m<sub>B</sub><sup>-</sup>) recA13 ara-14 proA2 lacY1 galK2 rpsL20 xyl-5 mtl-1</i>	An amber suppressing strain commonly used for large-scale production of plasmids. The hybrid strain is isolated from an <i>E. coli</i> K12 $\times$ <i>E. coli</i> B cross, and can be transformed efficiently by plasmids (Boyer and Roulland-Dussoix 1969; Bolivar and Backman 1979).
HMS174	<i>recA1 hsdR rif<sup>r</sup></i>	A recombination-deficient nonsuppressing strain used for high-level expression of genes cloned into expression vectors containing bacteriophage T7 promoter. Bacteriophage T7 RNA polymerase is provided by infection with a bacteriophage $\lambda$ that carries bacteriophage T7 gene 1 (Campbell et al. 1978; Studier and Moffatt 1986).
JM101 <sup>a</sup>	<i>supE thi <math>\Delta</math>(lac-proAB) F'[traD36 proAB<sup>+</sup> lacI<sup>q</sup> lacZ <math>\Delta</math>M15]</i>	An amber suppressing F' strain that will support growth of bacteriophage M13 vectors (Messing 1979).
JM105	<i>supE endA sbcB15 hsdR4 rpsL thi <math>\Delta</math>(lac-proAB) F'[traD36 proAB<sup>+</sup> lacI<sup>q</sup> lacZ <math>\Delta</math>M15]</i>	An amber suppressing F' strain that will support growth of bacteriophage M13 vectors and will modify but not restrict transfected DNA (Yanisch-Perron et al. 1985). The F' in this strain carried <i>lacZ</i> $\Delta$ M15, which permits $\alpha$ -complementation with the amino terminus of $\beta$ -galactosidase encoded in $\lambda$ ZAP.
JM107 <sup>b</sup>	<i>supE44 endA1 hsdR17 gyrA96 relA1 thi <math>\Delta</math>(lac-proAB) F'[traD36 proAB<sup>+</sup> lacI<sup>q</sup> lacZ <math>\Delta</math>M15]</i>	An amber suppressing F' strain that will support growth of bacteriophage M13 vectors and will modify but not restrict transfected DNA (Yanisch-Perron et al. 1985). The F' in this strain carried <i>lacZ</i> $\Delta$ M15, which permits $\alpha$ -complementation with the amino terminus of $\beta$ -galactosidase encoded in $\lambda$ ZAP.
JM109 <sup>b,c</sup>	<i>recA1 supE44 endA1 hsdR17 gyrA96 relA1 thi <math>\Delta</math>(lac-proAB) F'[traD36 proAB<sup>-</sup> lacI<sup>q</sup> lacZ <math>\Delta</math>M15]</i>	An amber suppressing F' recombination-deficient strain that will support growth of bacteriophage M13 vectors and will modify but not restrict transfected DNA (Yanisch-Perron et al. 1985). The F' in this strain carried <i>lacZ</i> $\Delta$ M15, which permits $\alpha$ -complementation with the amino terminus of $\beta$ -galactosidase encoded in $\lambda$ ZAP.
JM110	<i>dam dem supE44 hsdR17 thi leu rpsL lacY galK galT ara tonA thr tsx <math>\Delta</math>(lac-proAB) F'[traD36 proAB<sup>-</sup> lacI<sup>q</sup> lacZ <math>\Delta</math>M15]</i>	An amber suppressing F' strain that will not methylate adenine in GATC sequences and will support growth of bacteriophage M13 vectors (Yanisch-Perron et al. 1985). The F' in this strain carried <i>lacZ</i> $\Delta$ M15, which permits $\alpha$ -complementation with the amino terminus of $\beta$ -galactosidase encoded in $\lambda$ ZAP.

(Continued on following pages.)

TABLE A3-2 (Continued)

STRAIN	RELEVANT GENOTYPE	REMARKS
K802	<i>supE hsdR gal metB</i>	An amber suppressing strain used to propagate bacteriophage $\lambda$ vectors and their recombinants (Wood 1966).
KC8	<i>hsdR leuB600 trpC9830 pyrF::Tn5 hisB463 lac<math>\Delta</math>X74 strA galU galK</i>	A strain for selective rescue of yeast plasmids carrying either the activation domain or DNA-binding domain derived from a GAL4 or LexA two-hybrid screening. KC8 carries the <i>trpC</i> , <i>leuB</i> , and <i>hisB</i> mutations that may be used for complementation with yeast <i>TRP1</i> , <i>LEU2</i> , and <i>HIS3</i> wild-type markers. Note that the Tn5 transposon confers kanamycin resistance.
KK2186	<i>supE sbcB15 hsdR4 rpsL thi <math>\Delta</math>(lac-proAB)</i>	A strain that will support growth of vectors carrying amber mutations and will modify but not restrict transfected DNA (Zagursky and Berman 1984).
KW251	<i>F' [traD36 proAB<sup>+</sup> lac<sup>0</sup> lacZ <math>\Delta</math>M15] supE hsdR mcrB mcrA recD</i>	A recombination-deficient strain that is permissive for vectors carrying amber mutations. Used for propagation of high-titer lysates of bacteriophage $\lambda$ . Will modify but not restrict DNA at <i>EcoRI</i> sites; permits propagation of cytosine-methylated DNA.
LE392	<i>supE44 supF58 hsdR514 galK2 galT22 metB1 trpR55 lacY1</i>	An amber suppressing strain commonly used to propagate bacteriophage $\lambda$ vectors and their recombinants. LE392 is a derivative of ED8654 (Borck et al. 1976; Murray et al. 1977).
LG90	$\Delta$ (lac-proAB)	A strain from which <i>lacZ</i> is deleted that is used for detection of recombinants expressing $\beta$ -galactosidase fusion proteins (Guarente and Ptashne 1981).
M5219	<i>lacZ trpA rpsL (<math>\lambda</math>bio252 cts857 <math>\Delta</math>H1)</i>	A strain used for regulated expression of genes cloned downstream from the bacteriophage $\lambda$ $p_L$ promoter. It contains a defective $\lambda$ prophage that encodes the bacteriophage $\lambda$ <i>cts857</i> repressor and N protein, which is an antagonist of transcription termination (Remaut et al. 1981; Simatake and Rosenberg 1981).
MBM7014.5	<i>hsdR2 mcrB1 zjj202::Tn10 (tet<sup>r</sup>) araD139 araCU25am <math>\Delta</math>lacU169</i>	An <i>mcrB</i> strain used for construction of libraries in $\lambda$ ORF8. Libraries are made with DNA treated with methylases to protect <i>HindIII</i> and <i>BamHI</i> sites. <i>M</i> <i>AluI</i> methylase is used to protect <i>HindIII</i> sites since <i>M</i> <i>HindIII</i> methylase is not available commercially. This strain is defective in the restriction system that recognizes <i>AluI</i> -methylated DNA sites (Raleigh and Wilson 1986).
MC1061	<i>hsdR mcrB araD139 <math>\Delta</math>(araABC-leu)7697 <math>\Delta</math>lacX74 galU galK rpsL thi</i>	An <i>mcrB</i> strain used for $\lambda$ ORF8 primary libraries as described for the strain MBM7014.5 (Meissner et al. 1987).
MM294	<i>supE44 hsdR endA1 pro thi</i>	An amber suppressing strain used for large-scale production of plasmids. It is transformed efficiently by plasmids (Meselson and Yuan 1968).
MV1184 <sup>d</sup>	<i>ara <math>\Delta</math>(lac-proAB) rpsL thi (<math>\phi</math>80 lacZ <math>\Delta</math>M15) <math>\Delta</math>(srl-recA)306::Tn10 (tet<sup>r</sup>) F' [traD36 proAB<sup>+</sup> lac<sup>0</sup> lacZ <math>\Delta</math>M15]</i>	A recombination-deficient strain used to propagate phagemids pUC118/pUC119 and to obtain single-stranded copies of phagemids (Vieira and Messing 1987).
MV1193	<i><math>\Delta</math>(lac-proAB) rpsL thi endA spcB15 hsdR4 <math>\Delta</math>(srl-recA)306::Tn10 (tet<sup>r</sup>) F' [traD36 proAB<sup>+</sup> lac<sup>0</sup> lacZ <math>\Delta</math>M15]</i>	A recombination-deficient strain used to propagate phagemids pUC118/pUC119 and to obtain single-stranded copies of phagemids (Zoller and Smith 1984, 1987).
MZ-1	<i>galK<math>\Delta</math>8att1<math>\Delta</math>BamN<sub>7</sub>N<sub>33</sub> cts857<math>\Delta</math>H1 his ilv bio N<sup>+</sup></i>	A temperature-sensitive $\lambda$ -lysogenic strain used as a host for plasmids containing the bacteriophage $\lambda$ $p_L$ promoter (Nagai and Thøgersen 1984).
NM519	<i>hsdR recBC sbcA</i>	A recombination-deficient strain used for growth of <i>Spi</i> <sup>+</sup> $\lambda$ bacteriophages; will modify but not restrict DNA at <i>EcoRI</i> sites (Arber et al. 1983).

NM522	<i>supE</i> $\Delta$ ( <i>lac proAB</i> ) $\Delta$ ( <i>mcrB</i> ) <i>hsdSM15</i> F' [ <i>proAB lacI<sup>q</sup> lacZ</i> $\Delta$ M15]	A strain deficient in modification and restriction used for the growth of phagemids; allows enhanced cloning of methylated genomic DNA (Gough and Murray 1983).
NM531	<i>supE supF hsdR trpR lacY recA13 metB gal</i>	A recombination-deficient suppressing strain used for propagation of bacteriophage $\lambda$ vectors (Arber et al. 1983).
NM538	<i>supE hsdR trpR lacY</i>	A strain used for assay and propagation of bacteriophage $\lambda$ (Frischauf et al. 1983).
NM539	<i>supE hsdR lacY</i> (P2cox)	A strain used for selection of Spi <sup>-</sup> $\lambda$ bacteriophages. NM539 is a derivative of NM538 (Frischauf et al. 1983).
NM554	<i>AraD139 galK galU hsd R2 (rK<sup>-</sup> Km<sup>r</sup>) recA13 rpsL thi-1 <math>\Delta</math>(<i>ara-leu</i>)7696 <math>\Delta</math><i>lacX74 F</i><sup>-</sup></i>	A strain used for plating an unamplified cosmid library for screening.
NS3516	<i>Cre</i> parent of NS3529	A Cre <sup>-</sup> host strain used to prepare large quantities of recombinant DNA cloned in bacteriophage P1 (Sternberg et al. 1994).
NS3529	<i>recA mcrA</i> $\Delta$ ( <i>mrr-hsdRMS-mcrBC</i> ) ( $\lambda$ <i>imm434 nin5X1-Cre</i> ) ( $\lambda$ <i>imm</i> $\lambda$ LP1)	A host strain for preparing bacteriophage P1 libraries. The <i>imm434</i> prophage produces Cre constitutively; the <i>imm</i> $\lambda$ prophage produces the <i>lacI<sup>q</sup></i> repressor constitutively (Sternberg et al. 1994).
Q358	<i>supE hsdR</i> $\phi$ 80 <sup>r</sup>	An amber suppressing host used for growth of bacteriophage $\lambda$ vectors (Karn et al. 1980).
Q359	<i>supE hsdR</i> $\phi$ 80 <sup>r</sup> (P2)	An amber suppressing host used to select Spi <sup>-</sup> $\lambda$ recombinants (Karn et al. 1980).
R594	<i>galK2 galT122 rpsL179 lac</i>	A nonsuppressing strain used as a nonpermissive host for bacteriophage $\lambda$ vectors containing amber or ochre mutations (Campbell 1965).
RB791	W3110 <i>lacI<sup>q</sup>L8</i>	A strain that makes high levels of Lac repressor and is used for inducible expression of genes under the control of the <i>lac</i> and <i>tac</i> promoters (Brent and Ptashne 1981).
RR1	<i>supE44 hsdS20</i> ( $r_b^- m_b^-$ ) <i>ara-14 proA2 lacY1 galK2 rpsL20 xyl-5 mtl-1</i>	A <i>recA<sup>+</sup></i> derivative of HB101 that can be transformed with high efficiency (Bolivar et al. 1977; Peacock et al. 1981; B. Bachmann, pers. comm.).
SMR10	<i>E. coli C</i> ( $\lambda$ <i>cos2</i> $\Delta$ B <i>xis1 reI3 gam am210 c1s857 nin5 Sam71</i> $\lambda$ )	A bacteriophage $\lambda$ lysogen used to prepare packaging extracts (Rosenberg 1985).
TAP90	<i>supE44 supF58 hsdR pro leuB thi-1 rpsL lacY1 tonA1 recD1903::mini-tet</i>	A strain used for production of high-titer bacteriophage $\lambda$ lysates. This restriction-deficient <i>supE supF</i> strain has a mini- <i>tet</i> insertion in <i>recD</i> , which improves growth of Spi <sup>-</sup> $\lambda$ bacteriophages (Patterson and Dean 1987).
TG1	<i>supE hsd</i> $\Delta$ 5 <i>thi</i> $\Delta$ ( <i>lac-proAB</i> ) F' [ <i>traD36 proAB<sup>+</sup> lacI<sup>q</sup> lacZ</i> $\Delta$ M15]	An <i>EcoK<sup>-</sup></i> derivative of JM101 that neither modifies nor restricts transfected DNA (Gibson 1984).
TG2	<i>supE hsd</i> $\Delta$ 5 <i>thi</i> $\Delta$ ( <i>lac-proAB</i> ) $\Delta$ ( <i>srl-recA</i> )306::Tn10 ( <i>ter<sup>r</sup></i> ) F' [ <i>traD36 proAB<sup>+</sup> lacI<sup>q</sup> lacZ</i> $\Delta$ M15]	A recombination-deficient derivative of TG1 (M. Biggin, pers. comm.).
XL1-Blue	<i>supE44 hsdR17 recA1 endA1 gyrA46 thi relA1 lac<sup>-</sup></i> F' [ <i>proAB<sup>+</sup> lacI<sup>q</sup> lacZ</i> $\Delta$ M15 Tn10 ( <i>ter<sup>r</sup></i> )]	A recombination-deficient strain that will support the growth of vectors carrying some amber mutations, but not those with the Sam100 mutation (e.g., $\lambda$ ZAP). Transfected DNA is modified but not restricted. XL1-Blue is used to propagate $\lambda$ ZAPII recombinants, which are unstable in BB4. The F' in this strain allows blue white screening on X-gal and permits superinfection with bacteriophage M13 (Bullock et al. 1987).

(Continued on following page.)

TABLE A3-2 (Continued)

STRAIN	RELEVANT GENOTYPE	REMARKS
XL1-Blue MRF <sup>c</sup>	<i>supE44 hsdR17 recA1 endA1 gyrA46 thi relA1 lac Δ(mcrA)183 Δ(mcrCB- hsd SMR-mrr)173</i> F <sup>+</sup> [ <i>proAB<sup>+</sup> lac<sup>P</sup> lacZ ΔM15 Tn10 (tet<sup>r</sup>)</i> ]	A recombination-deficient strain that is permissive for growth of vectors carrying amber mutations. Will modify but not restrict DNA at <i>EcoRI</i> sites; permits $\alpha$ -complementation of $\beta$ -galactosidase in a <i>recA<sup>-</sup></i> strain (Jerpseth et al. 1992). It is resistant to tetracycline.
XS101	<i>recA1 hsdR rpoB331</i> F <sup>+</sup> [ <i>kan</i> ]	A recombination-deficient strain that modifies but does not restrict transfected DNA. It carries an episome conferring resistance to kanamycin and is used for growth of phagemids (Levinson et al. 1984).
XS127	<i>gyrA thi rpoB331 Δ(lac-proAB) argE</i> F <sup>+</sup> [ <i>traD36 proAB<sup>+</sup> lac<sup>P</sup> lacZ ΔM15</i> ]	A strain used for growth of phagemids (Levinson et al. 1984).
Y1089	<i>araD139 ΔlacU169 proA<sup>+</sup> Δlon rpsL hfIA150 [chr::Tn10 (tet<sup>r</sup>)] pMC9</i>	A strain used for protein production from $\lambda$ gt11 and $\lambda$ gt18-23 recombinants. Expression of the foreign protein is controlled by high levels of Lac repressor made by pMC9, which carries <i>lac<sup>P</sup></i> . Y1089 is deficient in the <i>lon</i> protease, which may enhance stability of the foreign proteins. Lysogens are formed at a high frequency in this strain (Young and Davis 1983b).
Y1090hsdR	<i>supF hsdR araD 139 Δlon ΔlacU169 rpsL trpC22::Tn10 (tet<sup>r</sup>) pMC9</i>	A strain used for immunological screening of expression libraries and propagation of $\lambda$ gt11 and $\lambda$ gt18-23 (Young and Davis 1983b; Jendrisak et al. 1987). Expression of the foreign protein is controlled by the high levels of Lac repressor made by pMC9, which carries <i>lac<sup>P</sup></i> . Detection of proteins toxic to <i>E. coli</i> can be achieved by adding IPTG several hours after initiation of plaque formation. Some proteins are unstable in <i>E. coli</i> . Y1090 <i>hsdR</i> is deficient in the <i>lon</i> protease, which may enhance stability of antigens and facilitate antibody screening. The <i>supF</i> marker suppresses Sam100 to allow cell lysis (Young and Davis 1983b).
YK537	<i>supE44 hsdR hsdM recA1 phoA8 leuB6 thi lacY rpsL20 galK2 ara-14 xyl-5 mtl-1</i>	A recombination-deficient suppressing strain used for regulated expression of genes cloned downstream from the <i>phoA</i> promoter (Oka et al. 1985).

<sup>a</sup>Strain JM103 (Messing et al. 1981) is a restrictionless derivative of JM101 that has been used to propagate bacteriophage M13 recombinants. However, some cultivars of JM103 have lost the *hsdR4* mutation (Felton 1983) and are lysogenic for bacteriophage P1 (which codes for its own restriction/modification system). JM103 is therefore no longer recommended as a host for bacteriophage M13 vectors. Strain KK2186 (Zagursky and Berman 1984) is genetically identical to JM103 except that it is nonlysogenic for bacteriophage P1.

<sup>b</sup>Strains JM106 and JM108 are identical to JM107 and JM109, respectively, except that they do not carry an F<sup>+</sup> episome. These strains will not support the growth of bacteriophage M13 but may be used to propagate plasmids. However, JM106 and JM108 do not carry the *lac<sup>P</sup>* marker (normally present on the F<sup>+</sup> episome) and are therefore unable effectively to suppress the synthesis of potentially toxic products encoded by foreign DNA sequences cloned into plasmids carrying the *lacZ* promoter.

<sup>c</sup>Strains JM108 and JM109 are defective for synthesis of bacterial cell walls and form mucoid colonies on minimal media. This trait does not affect their ability to support the growth of bacteriophage M13.

<sup>d</sup>The original strain of MV1184, constructed by M. Volkert (pers. comm.), did not carry an F<sup>+</sup> episome. However, the strain of MV1184 distributed by the Messing laboratory clearly carries an F<sup>+</sup> episome. It is therefore advisable to check strains of MV1184 on their arrival in the laboratory for their ability to support the growth of male-specific bacteriophages.

# Appendix 4

---

## Enzymes Used in Molecular Cloning

<b>MODIFICATION/RESTRICTION SYSTEMS IN <i>E. COLI</i></b>	A4.3
Methylating Enzymes in <i>E. coli</i>	A4.3
<i>dam</i> Methyltransferase	A4.3
<i>dcm</i> Methyltransferase	A4.3
The Modification Component of Modification/Restriction Systems	A4.4
Methylation-dependent Restriction Systems in <i>E. coli</i>	A4.4
Modification of Restriction Sites by DNA Methylation	A4.5
Influence of Methylation on DNA Mapping	A4.6
Restriction Endonucleases	A4.9
<b>DNA POLYMERASES</b>	A4.10
DNA Polymerase I (Holoenzyme)	A4.12
Large Fragment of DNA Polymerase I (Klenow Fragment)	A4.15
Bacteriophage T4 DNA Polymerase	A4.18
Bacteriophage T7 DNA Polymerase	A4.22
Thermostable DNA-dependent DNA Polymerase	A4.22
Reverse Transcriptase (RNA-dependent DNA Polymerase)	A4.24
Terminal Transferase (Terminal Deoxynucleotidyl Transferase)	A4.27
<b>DNA-DEPENDENT RNA POLYMERASES</b>	A4.28
Bacteriophage SP6 and Bacteriophages T7 and T3 RNA Polymerases	A4.28
<b>LIGASES, KINASES, AND PHOSPHATASES</b>	A4.30
Bacteriophage T4 DNA Ligase	A4.31
<i>E. coli</i> DNA Ligase	A4.33
Bacteriophage T4 RNA Ligase	A4.34
Thermostable DNA Ligases	A4.34
Bacteriophage T4 DNA Polynucleotide Kinase	A4.35
Alkaline Phosphatases	A4.37
<b>NUCLEASES</b>	A4.38
Ribonuclease H	A4.38
Ribonuclease A (Pancreatic)	A4.39
Preparation of RNase That Is Free of DNase	A4.39
Ribonuclease T1	A4.39
	<b>A4.1</b>



## A4.2 Appendix 4: Enzymes Used in Molecular Cloning

Deoxyribonuclease I (Pancreatic)	A4.40
Preparation of DNase That Is Free of RNase	A4.42
BAL 31 Nuclease	A4.43
Nuclease S1	A4.46
Mung Bean Nuclease	A4.47
Exonuclease III	A4.47
Bacteriophage $\lambda$ Exonuclease	A4.49
<b>PROTEOLYTIC ENZYMES</b>	A4.50
Proteinase K	A4.50
<b>OTHER ENZYMES</b>	A4.51
Lysozymes	A4.51
Agarase	A4.51
Uracil DNA Glycosylase	A4.51
Topoisomerase I	A4.52

## MODIFICATION/RESTRICTION SYSTEMS IN *E. COLI*

Modification of DNA is used by *Escherichia coli* to distinguish between its own genome and foreign DNAs introduced by bacteriophage infection, plasmid transfer, or transfection. DNAs with familiar patterns of methylation on adenosine or cytosine residues are immune to attack, whereas unmethylated DNAs or DNAs with unfamiliar patterns of methylation are earmarked for degradation by endogenous restriction enzymes.

### Methylating Enzymes in *E. coli*

Wild-type strains of *E. coli* express DNA methyltransferases that transfer a methyl group from S-adenosylmethionine to an adenine or cytosine residue within a defined target sequence. Described below are several types of methylating enzymes.

#### *dam* Methyltransferase

In *dam*<sup>+</sup> strains of *E. coli*, adenine residues embedded in the sequence 5'...GATC...3' carry a methyl group attached to the N<sup>6</sup> atom (Hattman et al. 1978). More than 99% of these modified adenine bases, which are found on both strands of the palindromic recognition sequence, are formed by action of DNA adenine methylase, the product of the *dam* gene. DNA adenine methylase is a single-subunit nucleotide-independent (type II) DNA methyltransferase that transfers a methyl group from S-adenosylmethionine to adenine residues in the recognition sequence 5'.....GATC.....3' (for review, please see Marinus 1987; Palmer and Marinus 1994). In *E. coli*, *dam* methylation is required for efficient DNA mismatch repair, for accurate initiation of DNA replication at *oriC*, for segregation and partition of chromosomes carrying *oriC*, and for modulation of gene expression (for review, please see Palmer and Marinus 1994). The transfer of a methyl group to the N<sup>6</sup> atom of adenine places a bulky alkyl residue in the major groove of B-form DNA and prevents cleavage in vitro by some restriction enzymes whose recognition sites contain the sequence 5'.....GATC.....3'. By contrast, other restriction enzymes require methylation at -GATC-residues to cleave DNA.

The recognition sites of several restriction enzymes (*PvuII*, *BamHI*, *BclI*, *BglII*, *XhoII*, *MboI*, and *Sau3AI*) contain this sequence, as do a proportion of the sites recognized by *Clal* (1 site in 4), *XbaI* (1 site in 16), *TaqI* (1 site in 16), *MboII* (1 site in 16), and *HphI* (1 site in 16). The inhibition of *MboI* digestion of prokaryotic DNA presents no practical problem because the restriction enzyme *Sau3AI* recognizes exactly the same sequence as *MboI* but is unaffected by *dam* methylation. (Note: Mammalian DNA is not methylated at the N<sup>6</sup> position of adenine, and thus, either *MboI* or *Sau3AI* can be used effectively.) However, when it is necessary to cleave prokaryotic DNA at every possible site with *Clal*, *XbaI*, *TaqI*, *MboII*, or *HphI* or to cleave it at all with *BclI*, the DNA must be prepared from strains of *E. coli* that are *dam*<sup>-</sup> (Backman 1980; Roberts et al. 1980; McClelland 1981).

Lists of restriction enzymes whose pattern of cleavage is affected by *dam* methylation have been assembled by Kessler and Manta (1990) and McClelland and Nelson (1992); additional information is available in the brochures of most commercial suppliers of enzymes and in a database of restriction and modification enzymes (REBASE) that is accessible at [rebase.neb.com/rebase](http://rebase.neb.com/rebase).

#### *dcm* Methyltransferase

*dcm* introduces methyl groups at the C<sup>5</sup> position of the internal cytosine in the sequence 5'...CCAGG...3' or 5'...CCTGG...3' and therefore prevents or suppresses cleavage by restriction

enzymes such as *EcoRI* (Marinus and Morris 1973; May and Hattman 1975). For most purposes, this problem can be avoided by using *BstNI*, which recognizes exactly the same sequence as *EcoRII* (although it cuts the DNA at a different location within the sequence). If *BstNI* cannot be substituted for *EcoRII*, the DNA must be prepared from strains of *E. coli* that are *dcm*<sup>-</sup> (Marinus 1973; Backman 1980; Roberts et al. 1980). Certain other enzymes may cleave at sequences that partially overlap the modified *dcm* recognition sequence. Detailed information on the methylation sensitivity of individual restriction enzymes is provided by the REBASE Web Site ([rebase.neb.com/rebase](http://rebase.neb.com/rebase)). *dcm*<sup>-</sup> mutants of *E. coli* show no phenotype, and the biological significance of *dcm* methylation is obscure (for review, please see Palmer and Marinus 1994).

### The Modification Component of Modification/Restriction Systems

- Type I modification/restriction systems.** The classical type I modification/restriction system in many wild-type strains of *E. coli* is encoded by the three *hsd* (*EcoK*) genes. Two of the polypeptides encoded by these genes (*hsdM* and *hsdS*) are needed to transfer methyl groups to the N<sup>6</sup> position of two adenines in the recognition sequence <sup>5</sup>AAC(N<sub>6</sub>)GTGC<sup>3</sup> (Kan et al. 1979). This type of modification, which accounts for ~1% of N<sup>6</sup> adenine methylation in *E. coli*, protects DNA against cleavage by the heterotrimeric *EcoK* restriction endonuclease (encoded by the *hsdRMS* genes), a type I restriction endonuclease which, at the expense of ATP hydrolysis, produces double-stranded breaks at a variable distance from the recognition site (Bickle 1987). Many strains of *E. coli* used for molecular cloning carry mutations in the *hsd* genes.
- Type II modification/restriction systems.** Classical (type II) modification/restriction systems have two components, a restriction endonuclease and a DNA methyltransferase; both components recognize the same target sequence. In vivo, type II restriction endonucleases cleave unmethylated sequences, whereas methyltransferases prefer hemimethylated substrates generated during DNA replication. The modifying enzymes of many prokaryotic type II modification/restriction systems are monomers that transfer a methyl group to the 5-carbon of the pyrimidine ring of cytosine, creating 5-methylcytosine. The catalytic mechanism of this reaction involves nucleophilic attack on C<sup>6</sup> of the target cytosine by a cysteine residue to generate a covalent intermediate. The addition of the nucleophile allows the transfer of a methyl group from S-adenosylmethionine to the activated 5-carbon. Abstraction of the proton at the 5-position yields an enzyme that undergoes conjugative elimination to yield the product 5-methylcytosine (Wu and Santi 1987; for reviews, please see Kumar et al. 1994; Verdine 1994; Winkler 1994).

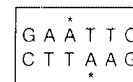
Contacts between type II restriction enzymes and their recognition sequence involve amino acids that are widely separated in the primary protein sequence, resulting in bending and kinking of the target DNA (Kim et al. 1990; Winkler et al. 1993). Type II methylases produce a more radical change in DNA structure by forcing the target cytosine to flip out of the plane of the DNA helix and into the active site of the enzyme. This flipping mechanism, which was first established for *M-HhaI* (Klimasauskas et al. 1994), is believed to be universal among 5-methylcytosine transferases, all of which share a well-conserved set of sequence motifs and a common architecture (for review, please see Winkler 1994).

### Methylation-dependent Restriction Systems in *E. coli*

*E. coli* K contains at least three different methylation-dependent restriction systems that recognize different target sequences only when methylated: *mrr* (6-methyladenine [<sup>m6</sup>A]), *mcrA* (<sup>m5</sup>CG [<sup>m5</sup>C = 5-methylcytosine]), and *mcrB* (PU<sup>m5</sup>C) (Raleigh and Wilson 1986; Heitman and Model

1987; Raleigh et al. 1988). DNAs that are methylated at such sites are inefficiently cloned into wild-type strains of *E. coli* (Whittaker et al. 1988). For example, human DNA, which is extensively methylated in vivo at  $m^5CG$ , is restricted by *mcrA*. Nonrestricting strains of *E. coli* (Raleigh and Wilson 1986; Raleigh et al. 1988) are therefore preferred for transformation and cloning of methylated DNA.

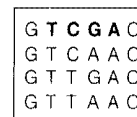
*M·EcoRI* methylase catalyzes the transfer of methyl groups from *S*-adenosyl *L*-methionine (SAM) to the adenines marked with a star (\*) in the *EcoRI* recognition sequence in the figure at the right. The modification of adenine to 6-methylaminopurine protects the DNA from cleavage by *EcoRI* (Greene et al. 1975).



## Modification of Restriction Sites by DNA Methylation

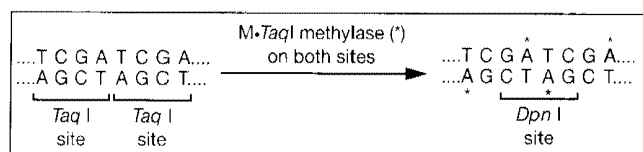
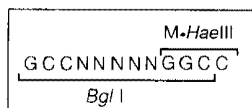
For many of the type II restriction enzymes, a corresponding methylase has been isolated that modifies the cognate recognition sequence and renders it resistant to cleavage. These methylases, a number of which are available from commercial suppliers, are useful in a number of tasks in molecular cloning. For example, in the construction of genomic DNA libraries (Maniatis et al. 1978), random fragments of genomic DNA generated by partial cleavage with the restriction enzymes *AhaI* and *HaeIII* can be treated with *M·EcoRI* methylase prior to the addition of synthetic *EcoRI* linkers. When the linkers attached to genomic DNA are subsequently digested with *EcoRI*, the natural restriction sites within the genomic DNA are protected from cleavage. The same strategy may be used to spare natural restriction sites when preparing double-stranded cDNA for cloning.

Methylases can also be used to alter the apparent cleavage specificity of certain restriction enzymes (Nelson et al. 1984; Nelson and Schildkraut 1987). These alterations are accomplished in vitro by methylation of a subset of the sequences recognized by certain restriction enzymes. Only the methylated subsets will be resistant to cleavage. For example, the restriction enzyme *HincII* recognizes the degenerate sequence GTPyPuAC and will therefore cleave the four sequences shown at the right.



The *M·TaqI* methylase recognizes only the sequence TCGA and methylates the adenine residue (McClelland 1981). The subset of *HincII* recognition sequences that contains the internal sequence TCGA will therefore be resistant to cleavage after methylation by *M·TaqI*, whereas the other three recognition sequences will remain sensitive to *HincII*.

A second class of overlapping methylation and restriction sites occurs at the boundaries of the recognition sequences of a restriction enzyme and a methylase. For example, a *BamHI* site (GGATCC) that happens to be preceded by CC or followed by GG partially overlaps a site (CCGG) that can be methylated by the enzyme *M·MspI*. Because *M·MspI* methylates the 5' cytosine of its recognition sequence ( $m^5CCGG$ ), the *BamHI* site becomes methylated at an internal cytosine residue (GGAT $m^5$ CCGG) and therefore is resistant to cleavage by *BamHI*. Another example is provided by *BglI* and *M·HaeIII* illustrated at the left. As in the cases of *HincII/M·TaqI* and *BamHI/M·MspI*, the methylation blocks the cleavage of a previously existing restriction site. Finally, certain adenine methylases can be used in conjunction with the methylation-dependent restriction enzyme *DpnI* to produce highly specific cleavages at sequences 8–12 bp in length (McClelland et al. 1984; McClelland and Nelson 1987; Weil and McClelland 1989).



**TABLE A4-1 Isoschizomer Pairs That Differ in Their Sensitivity to Sequence-specific Methylation**

METHYLATED SEQUENCE <sup>b</sup>	ISOSCHIZOMER PAIRS <sup>a</sup>	
	CUT BY	NOT CUT BY
T <sup>m5</sup> CCGGA	<i>AccII</i>	<i>BspMII</i>
TC <sup>m5</sup> CGGA	<i>AccII</i>	<i>BspMII</i>
GGWC <sup>m5</sup> C	<i>AflI</i>	<i>AvaII</i> ( <i>Eco47I</i> )
TCCGG <sup>m6</sup> A	<i>BspMII</i>	<i>AccII</i>
C <sup>m5</sup> CWGG	<i>BstNI</i> ( <i>MvaI</i> )	<i>EcoRII</i>
GGTAC <sup>m5</sup> C	<i>KpnI</i>	<i>Asp718I</i>
C <sup>m5</sup> CGG	<i>MspI</i>	<i>HpaII</i> ( <i>HapII</i> )
C <sup>m4</sup> CGG	<i>MspI</i>	<i>HpaII</i>
G <sup>m6</sup> ATC	<i>Sau3AI</i> ( <i>FnuEI</i> )	<i>MboI</i> ( <i>NdeII</i> )
TCGCG <sup>m6</sup> A	<i>Sbo13I</i>	<i>NruI</i>
RG <sup>m6</sup> ATCY	<i>XhoII</i>	<i>MflI</i>
CC <sup>m5</sup> CGGG	<i>XmaI</i> ( <i>Cfr9I</i> )	<i>SmaI</i>

In each row, the first column lists a methylated sequence, the second column lists an isoschizomer that cuts this sequence, and the third column lists an isoschizomer that does not cut this sequence. For references, please see McClelland and Nelson (1988). (Reprinted, with permission, from McClelland and Nelson 1988.)

<sup>a</sup>An enzyme is classified as insensitive to methylation if it cuts the methylated sequence at a rate that is at least one tenth the rate at which it cuts the unmethylated sequence. An enzyme is classified as sensitive to methylation if it is inhibited at least 20-fold by methylation relative to the unmethylated sequence.

<sup>b</sup>Sequences are in 5'→3' order. R = G or A; Y = C or T; W = A or T; <sup>m4</sup>C = 4-methylcytosine, <sup>m5</sup>C = 5-methylcytosine, and <sup>m6</sup>A = 6-methyladenine.

This example differs from those above in that the strategy *creates* a site in DNA that otherwise would not be cleaved by *DpnI*. This general strategy of using specific methylases in conjunction with restriction enzymes has produced >60 new cleavage specificities and many more are possible (for references, please see McClelland and Nelson 1988). A compilation of the sensitivities of individual restriction enzymes to site-specific modifications may be found at the REBASE Web Site: [rebase.neb.com/rebase](http://rebase.neb.com/rebase).

Several pairs of isoschizomers differ in their sensitivity to site-specific methylation (see Table A4-1). Such endonuclease pairs are useful for studying the level and distribution of site-specific methylation in cellular DNA, for example, <sup>m5</sup>CG in mammals, <sup>m5</sup>CG and <sup>m5</sup>CNG in plants, and G<sup>m6</sup>ATC in enterobacteria (Waalwijk and Flavell 1978; McClelland 1983; Bird et al. 1985).

Sensitivity to site-specific DNA methylation is clearly not limited to restriction enzymes but is a property of DNA-binding proteins in general (see Sternberg 1985; Wang et al. 1986). <sup>m4</sup>C, <sup>m5</sup>C, <sup>hm5</sup>C, and <sup>m6</sup>A site-specific modification at "noncanonical" sites will block several type II methylases. The data are summarized in Table A4-2.

## Influence of Methylation on DNA Mapping

Mammalian DNA contains <sup>m5</sup>C residues in addition to the four normal bases. These residues are found primarily at the 5' side of G residues. Although only a portion of CpG doublets are methylated, the pattern of methylation is highly cell-type-specific (Bird and Southern 1978); any given CpG doublet is methylated in the majority of cells of a given population or in only a few of them.

Nearly all restriction enzymes used for long-range mapping of mammalian chromosomal DNA recognize sequences that contain CpG. Because this dinucleotide occurs approximately five-

TABLE A4-2 Methylation Sensitivity of Type II DNA Methylases

METHYLASE (SPECIFICITY) <sup>a</sup>	NOT BLOCKED BY PRIOR MODIFICATION AT <sup>b</sup>	BLOCKED BY PRIOR MODIFICATION AT <sup>b</sup>
M· <i>AclI</i> (AG <sup>m5</sup> CT)		AG <sup>m4</sup> CT
M· <i>Bam</i> HI (GGAT <sup>m4</sup> CC)	GG <sup>m6</sup> ATCC	GGATC <sup>m5</sup> C
M· <i>Cfr</i> 6I (CAG <sup>m4</sup> CTG)		CAG <sup>m5</sup> CTG
M· <i>Clal</i> (ATCG <sup>m6</sup> AT)	<sup>m6</sup> ATCGAT AT <sup>m5</sup> CGAT	
M· <i>Cvi</i> BIII (TCG <sup>m6</sup> A)	T <sup>m5</sup> CGA	
M· <i>Eco</i> RI (GA <sup>m6</sup> ATTC)	GAATT <sup>m5</sup> C	G <sup>m6</sup> AATTC
M· <i>Eco</i> RII (C <sup>m5</sup> CWGG)		C <sup>m4</sup> CWGG
<i>E. coli dam</i> (G <sup>m6</sup> ATC)	GAT <sup>m5</sup> C <sup>c</sup> GAT <sup>hm5</sup> C	
M· <i>Fok</i> IA (GG <sup>m6</sup> ATG)	CATC <sup>m5</sup> C	CAT <sup>m5</sup> CC
M· <i>Hha</i> I (G <sup>m5</sup> CGC)	GCG <sup>m5</sup> C	
M· <i>Hha</i> II (G <sup>m6</sup> ANTC)	GANT <sup>m5</sup> C	
M· <i>Hpa</i> II (C <sup>m5</sup> CGG)		<sup>m5</sup> CCGG
M· <i>Hph</i> I (T <sup>m5</sup> CACC)	GGTG <sup>m6</sup> A	
M· <i>Mbo</i> I (G <sup>m6</sup> ATC)	GAT <sup>m5</sup> C	
M· <i>Mbo</i> II (GAAG <sup>m5</sup> A)	T <sup>m5</sup> CTT <sup>m5</sup> C	
M· <i>Msp</i> I ( <sup>m5</sup> CCGG)		C <sup>m5</sup> CGG
M· <i>Mva</i> I (C <sup>m4</sup> CWGG)	C <sup>m5</sup> CWGG	
M· <i>Pvu</i> II (CAG <sup>m4</sup> CTG)		CAG <sup>m5</sup> CTG
M·T2 <i>dam</i> (G <sup>m6</sup> ATC)	GAT <sup>hm5</sup> C	
M·T4 <i>dam</i> (G <sup>m6</sup> ATC)	GAT <sup>hm5</sup> C	
M· <i>Taq</i> I (TCG <sup>m6</sup> A)	T <sup>m5</sup> CGA	

Reprinted, with permission, from McClelland and Nelson (1988). For references, please see McClelland and Nelson (1988).

<sup>a</sup>Sequences are in 5'→3' order. W = A or T; N = A or C or G or T; <sup>m4</sup>C = 4-methylcytosine, <sup>m5</sup>C = 5-methylcytosine, <sup>hm5</sup>C = 5-hydroxymethylcytosine, and <sup>m6</sup>A = 6-methyladenine.

<sup>b</sup>An enzyme is classified as insensitive to methylation if it methylates the methylated sequence at a rate that is at least one tenth the rate at which it methylates the unmethylated sequence. An enzyme is classified as sensitive to methylation if it is inhibited at least 20-fold by methylation relative to the unmethylated sequence.

<sup>c</sup>*E. coli dam* modifies GAT<sup>m5</sup>C at a reduced rate.

fold less frequently in mammalian DNA than expected (Normore 1976; Setlow 1976; Shapiro 1976), restriction enzyme recognition sites that contain the CpG dinucleotide are extremely rare (Lindsay and Bird 1987; McClelland and Nelson 1987). Furthermore, most of these dinucleotides are methylated, and almost all enzymes with CpG in the recognition sequence fail to cleave <sup>m5</sup>CpG-methylated DNA (Nelson and McClelland 1987); for example, *Bsp*MII, *Clal*, *Csp*I, *Eag*I, *Mlu*I, *Nae*I, *Nar*I, *Not*I, *Nru*I, *Pvu*I, *Rsa*II, *Sal*I, *Xho*I, and *Xor*II are all sensitive to <sup>m5</sup>CpG methylation. Finally, methylation of CpG dinucleotides in preparations of mammalian DNA is rarely complete. This variability in methylation of sites that are recognized by rarely cutting restriction enzymes can be a serious problem in mapping of mammalian DNAs by pulsed-field gel electrophoresis. Among the known restriction enzymes suitable for generating very large fragments of mammalian DNA, only a handful are capable of cleaving DNA modified at <sup>m5</sup>CpG doublets. These include *Acc*III, *Asu*II, *Cfr*9I, *Sfi*I, and *Xma*I. Propagation of mammalian DNAs in *E. coli* will free CpG dinucleotides from methylation. The pattern of cleavage of the same segment of mammalian genomic DNA will therefore differ in cloned and uncloned preparations.

The CpG dinucleotide is not as rare in many other species as it is in mammalian DNA, and it is not methylated in *Drosophila* and *Caenorhabditis* DNAs. Thus, the fragments produced by digestion of these DNAs with rarely cutting restriction enzymes are less than half the size of those produced from mammalian DNA (see Table A4-3). Enzymes that are not sensitive to certain site-specific methylations are particularly useful for achieving complete digestion of modified DNA. For procedures such as the physical mapping of heavily methylated plant DNA, it is desirable to

**TABLE A4-3 Average Sizes of DNA Fragments Generated by Cleavage with Restriction Enzymes**

ENZYME	SEQUENCE	CEL	DRO	ECO	HUM	MUS	YSC	XEL
<i>Apa</i> I	GGGCCC	40,000	6,000	15,000	2,000	3,000	20,000	5,000
<i>Asc</i> I	GGCGCGCC	400,000	60,000	20,000	80,000	100,000	500,000	200,000
<i>Avr</i> II	CCTAGG	20,000	20,000	150,000	8,000	7,000	20,000	15,000
<i>Bam</i> HI	GGATTC	9,000	4,000	5,000	5,000	4,000	9,000	5,000
<i>Bgl</i> I	GCCN <sub>5</sub> GCC	25,000	4,000	3,000	3,000	4,000	15,000	6,000
<i>Bgl</i> II	GCGCGC	4,000	4,000	6,000	3,000	3,000	4,000	3,000
<i>Bss</i> III	GCGCGC	30,000	6,000	2,000	10,000	15,000	30,000	20,000
<i>Dra</i> I	TTTAAA	1,000	1,000	2,000	2,000	3,000	1,000	2,000
<i>Eag</i> I	CGGCCG	20,000	3,000	4,000	10,000	15,000	20,000	15,000
<i>Eco</i> RI	GAATTC	2,000	4,000	5,000	5,000	5,000	3,000	4,000
<i>Hind</i> III	AAGCTT	3,000	4,000	5,000	4,000	3,000	3,000	3,000
<i>Nae</i> I	GCCGGC	15,000	3,000	2,000	4,000	6,000	15,000	6,000
<i>Nar</i> I	GGCGCC	15,000	3,000	2,000	4,000	6,000	15,000	7,000
<i>Nhe</i> I	GCTAGC	30,000	10,000	25,000	10,000	10,000	10,000	10,000
<i>Not</i> I	GCGGCCGC	600,000	30,000	200,000	100,000	200,000	450,000	200,000
<i>Pac</i> I	TTAATTA	20,000	25,000	50,000	60,000	100,000	15,000	50,000
<i>Pme</i> I	GTTTAAAC	40,000	40,000	40,000	70,000	80,000	50,000	50,000
<i>Rsr</i> II	CGGWCCG	50,000	15,000	10,000	60,000	60,000	60,000	70,000
<i>Sac</i> I	GAGCTC	4,000	4,000	10,000	3,000	3,000	9,000	4,000
<i>Sac</i> II	CCGCGG	20,000	5,000	3,000	6,000	8,000	20,000	15,000
<i>Sal</i> I	GTCGAC	8,000	5,000	5,000	20,000	20,000	10,000	15,000
<i>Sfi</i> I	GGCCN <sub>5</sub> GGCC	1,000,000	60,000	150,000	30,000	40,000	350,000	100,000
<i>Sgr</i> AI	CXCCGGXG	100,000	20,000	8,000	70,000	80,000	90,000	90,000
<i>Sma</i> I	CCCGGG	30,000	10,000	6,000	4,000	5,000	50,000	5,000
<i>Spe</i> I	ACTAGT	8,000	9,000	60,000	10,000	15,000	6,000	8,000
<i>Sph</i> I	GCATGC	15,000	5,000	4,000	6,000	6,000	10,000	6,000
<i>Srf</i> I	GCCCGGGC	1,000,000	90,000	50,000	50,000	90,000	600,000	100,000
<i>Sse</i> I	CCTGCAGG	200,000	50,000	40,000	15,000	15,000	150,000	30,000
<i>Ssp</i> I	AATATT	1,000	1,000	2,000	2,000	3,000	1,000	2,000
<i>Swa</i> I	ATTTAAAT	9,000	15,000	40,000	30,000	60,000	15,000	30,000
<i>Xba</i> I	TCTAGA	4,000	9,000	70,000	5,000	8,000	4,000	6,000
<i>Xho</i> I	CTCGAG	5,000	4,000	15,000	7,000	7,000	15,000	10,000

Average size fragments predicted for *Caenorhabditis elegans* (CEL), *Drosophila melanogaster* (DRO), *Escherichia coli* (ECO), human (HUM), mouse (MUS), *Saccharomyces cerevisiae* (YSC), and *Xenopus laevis* (XEL).

Listed are those restriction enzymes that are known or predicted to cleave infrequently in seven commonly studied genomes. Factors affecting the ability of restriction enzymes to cleave a particular genome include (1) percentage G+C content, (2) specific dinucleotide, trinucleotide, and/or tetranucleotide frequencies, and (3) methylation. Using available information on percentage G+C content, dinucleotide frequencies, and a few kilobases of DNA sequence, predictions can be made about potential cleavage with restriction enzymes.

Modified, with permission, from New England Biolabs.

choose restriction enzymes that are insensitive to  $m^5CG$  and  $m^5CNG$ . Examples of such enzymes are *BclI*, *BstEII*, *BstNI*, *CviQI*, *EcoRV*, *HincII*, *HpaI*, *KpnI*, *MboII*, *NdeI*, *NdeII*, *RsaI*, *SpeI*, *SphI*, *TaqI*, *TthHBI*, and *XmnI*. The *AseI*, *DraI*, *MseI*, and *SspI* enzymes have recognition sequences that do not contain cytosine, so they can be used to cleave heavily cytosine-methylated DNA.

## Restriction Endonucleases

Restriction enzymes bind specifically to and cleave double-stranded DNA at specific sites within, or adjacent to, a particular sequence known as the recognition sequence. These enzymes have been classified into three groups or types. Type I and type III enzymes carry modification (methylation) and ATP-dependent restriction activities in the same protein. Type III enzymes cut the DNA at the recognition site and then dissociate from the substrate. However, type I enzymes bind to the recognition sequence but cleave at random sites when the DNA loops back to the bound enzyme. Neither type I nor type III restriction enzymes are widely used in molecular cloning.

Type II modification/restriction systems are binary systems consisting of a restriction endonuclease that cleaves a specific sequence of nucleotides and a separate methylase that modifies the same recognition sequence. An increasingly large number of type II restriction endonucleases have been isolated and characterized, a great many of which are useful for cloning and other molecular manipulations.

The vast majority of type II restriction endonucleases recognize specific sequences that are four, five, or six nucleotides in length and display twofold symmetry. A few enzymes, however, recognize longer sequences or sequences that are degenerate. The location of cleavage sites within the axis of dyad symmetry differs from enzyme to enzyme: Some cleave both strands exactly at the axis of symmetry, generating fragments of DNA that carry blunt ends, whereas others cleave each strand at similar locations on opposite sides of the axis of symmetry, creating fragments of DNA that carry protruding single-stranded termini.

The restriction enzyme database, REBASE, contains a complete listing of all known restriction endonucleases, including the recognition sequences, methylation sensitivity, commercial availability, and references. The database, updated daily, is available at [rebase.neb.com/rebase](http://rebase.neb.com/rebase).



## DNA POLYMERASES

---

Many steps in molecular cloning involve the synthesis of DNA in *in vitro* reactions catalyzed by DNA polymerases. Most of these enzymes require a template and synthesize a product whose sequence is complementary to that of the template. Most polymerases strongly prefer DNA templates, but they will also copy RNA, albeit at lower efficiencies. The most frequently used DNA-dependent DNA polymerases are *E. coli* DNA polymerase I (holoenzyme), the large fragment of *E. coli* DNA polymerase I (Klenow fragment), the DNA polymerases encoded by bacteriophages T4 and T7, modified bacteriophage T7 DNA polymerases (Sequenase and Sequenase version 2.0), and thermostable DNA polymerases. One polymerase, reverse transcriptase (RNA-dependent DNA polymerase), prefers to copy RNA; it will also accept DNA templates and can therefore be used to synthesize double-stranded DNA copies of RNA templates. Finally, one DNA polymerase does not copy a template at all but adds nucleotides only to the termini of existing DNA molecules. This DNA polymerase is called terminal transferase (terminal deoxynucleotidyl transferase).

The properties of the template-dependent polymerases are summarized in Table A4-4 and are described in greater detail in the following pages. The data presented in this table have been collected from several publications. The values serve as accurate guidelines for using the enzymes, but optimal conditions will always vary slightly with the enzyme preparation (degree of purity) and the DNA preparation or when carrying out a sequence of enzymatic reactions in one mixture. For a discussion of the relative advantages of various DNA polymerases used in sequencing reactions, please see Chapter 12.

**TABLE A4-4 Comparison of Template-dependent DNA Polymerases**

	<i>E. COLI</i> DNA POLYMERASE I (HOLOENZYME)	KLENOW FRAGMENT OF <i>E. COLI</i> DNA POLYMERASE I	BACTERIOPHAGE T4 DNA POLYMERASE	SEQUENASE <sup>a</sup> (BACTERIOPHAGE T7 DNA POLYMERASE)	TAQ DNA POLYMERASE (AMPLITAQ)	REVERSE TRANSCRIPTASE
<b>Reactions</b>						
DNA polymerase 5'→3'	+	+	+	+	+	+
Exonuclease						
double-stranded DNA 5'→3'	+	-	-	-	+ <sup>b</sup>	-
single-stranded DNA 3'→5'	+	+	+	-	-	-
double-stranded DNA 3'→5'	+	+	+	-	-	-
RNase H activity	+	-	-	-	n.i. <sup>c</sup>	+
Displacement of strand from double-stranded fragment	+	+	-	-	n.i.	n.i.
Nick translation	+	-	-	-	n.i.	-
Exchange	+	+	+	-	-	-
<b>Template</b>						
Intact double-stranded DNA	-	-	-	-	-	-
Primed single strands of DNA	+	+	+	+	+	+
Duplex with gaps or single-stranded protruding 5' termini	+	+	+	+	+	+
Nicked double-stranded DNA	+	+	-	-	n.i.	-
Unprimed single-stranded DNA (hairpin)	+	+	n.i.	n.i.	n.i.	+
Single-stranded RNA	+ <sup>d</sup>	+ <sup>d</sup>	-	-	n.i.	+
<b>Requirements</b>						
Divalent cation	Mg <sup>2+</sup>	Mg <sup>2+</sup>	Mg <sup>2+</sup>	Mg <sup>2+</sup> <sup>e</sup>	Mg <sup>2+</sup> <sup>e</sup>	Mg <sup>2+</sup>
pH optimum	7.4	7.4 (phosphate) 8.4 (Tris)	8.0-9.0 (50% as active at pH 7.5)	7.6-7.8	8.3 at room temp. (Tris) (50% as active in phosphate [pH 7])	7.6 (Mo-MLV) 8.3 (AMV)
Sulfhydryl reagents	+	+	+	+	-	+
<b>Structure</b>						
Molecular mass (kD)	109	76	114	92	94	84 (Mo-MLV) 170 (AMV)
Number of subunits	1	1	1	2	1	1 (Mo-MLV) 2 (AMV)

Reprinted, with permission, from Kornberg and Kornberg (1974) and Lehman (1981).

<sup>a</sup>Sequenase is a derivative of bacteriophage T7 DNA polymerase that has been modified by chemical treatment (Sequenase) or by genetic engineering (Sequenase version 2.0) to suppress 3'→5' exonuclease activity that is a potent component of wild-type bacteriophage T7 DNA polymerase. Consequently, neither version of Sequenase can be used in exchange reactions.

<sup>b</sup>AmpliTaq and Taq DNA polymerase have a polymerization-dependent 5'→3' exonuclease activity.

<sup>c</sup>n.i. indicates no information available.

<sup>d</sup>Greater activity in the presence of Mn<sup>2+</sup> instead of Mg<sup>2+</sup>.

<sup>e</sup>Mn<sup>2+</sup> may substitute for Mg<sup>2+</sup>, although rates are lower and the specificity of the polymerases may be changed.

## DNA Polymerase I (Holoenzyme)

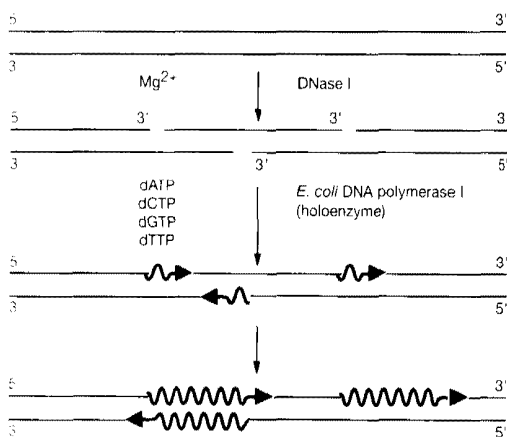
(*E. coli*)

DNA polymerase I consists of a single polypeptide chain ( $M_r = 109,000$ ) that can function as a 5'→3' DNA polymerase, a 5'→3' exonuclease, and a 3'→5' exonuclease (Kelley and Stump 1979) and that has an inherent RNase H activity. The RNase H activity is essential for cell viability in *E. coli* but has not been used in molecular cloning. For further details, please see the information panel on *E. COLI DNA POLYMERASE I AND THE KLENOW FRAGMENT* in Chapter 9.

### USES

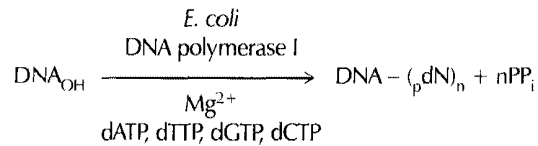
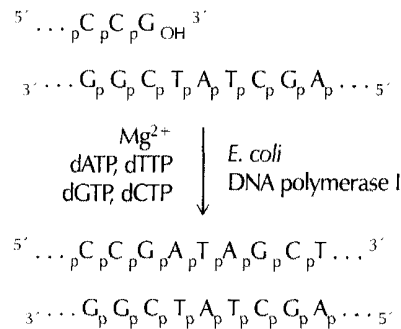
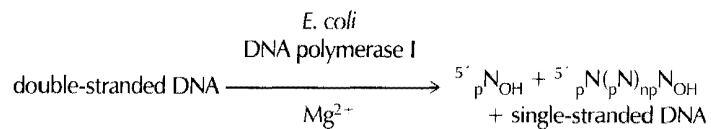
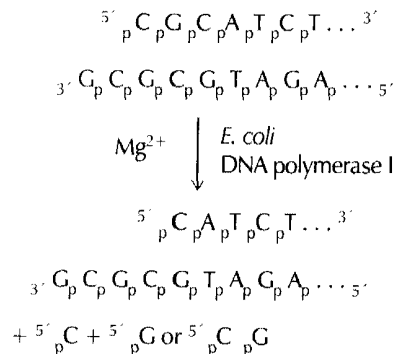
1. Labeling of DNA by nick translation (please see Figure A4-1). Of all the polymerases, only *E. coli* DNA polymerase I can carry out this reaction, since it alone has a 5'→3' exonuclease activity that can remove nucleotides from the DNA strand ahead of the advancing enzyme.
2. The holoenzyme was originally used for synthesis of the second strand of cDNA in cDNA cloning (Efstratiadis et al. 1976), but it has since been superseded by reverse transcriptase and the Klenow fragment of *E. coli* DNA polymerase I, which do not have 5'→3' exonuclease activities. The 5'→3' exonuclease of *E. coli* DNA polymerase I degrades oligonucleotides that may serve as primers for the synthesis of the second strand of cDNA.
3. End-labeling of DNA molecules with protruding 3' tails. This reaction works in two stages. First, the 3'→5' exonuclease activity removes protruding 3' tails from the DNA and creates a recessed 3' terminus. Then, in the presence of high concentrations of one radiolabeled precursor, exonucleolytic degradation is balanced by incorporation of dNTPs at the 3' terminus. This reaction, which consists of cycles of removal and replacement of the 3'-terminal nucleotides from recessed or blunt-ended DNA, is sometimes called an exchange or replacement reaction. If this type of reaction is used for the end-labeling, bacteriophage T4 DNA polymerase is the enzyme of choice. Although both *E. coli* DNA polymerase I and bacteriophage T4 DNA polymerase can carry out this type of reaction, the bacteriophage enzyme carries a more potent 3'→5' exonuclease activity.

In many cases, a single buffer can be used both for cleavage of DNA with a restriction enzyme and for the subsequent end-labeling. However, not all restriction enzymes work in buffers used for DNA polymerase reactions, and it is advisable to carry out pilot reactions with the particular batch of enzyme on hand. If the restriction enzyme does not work in the DNA polymerase buffer, it will be necessary to carry out the restriction enzyme digestion and end-labeling in two separate steps. In this case, cleave the DNA in the appropriate restriction enzyme buffer, remove the restriction enzyme by extraction with phenol:chloroform, precipitate the DNA with ethanol, dissolve it in TE, and add the appropriate volume of a 10x DNA polymerase buffer.



**FIGURE A4-1 Nick Translation Using *E. coli* DNA Polymerase**

Single-stranded nicks are introduced into the DNA by treatment with DNase I. *E. coli* DNA polymerase (Pol I) binds to the nick or short gap in duplex DNA, and the 5'→3' exonuclease activity of DNA polymerase I then removes nucleotides from the one strand of the DNA, creating a template for simultaneous synthesis of the growing strand of DNA. The original nick is therefore translated along the DNA molecule by the combined action of the 5'→3' exonuclease and the 5'→3' polymerase. In the reaction presented here, the nick in the upper strand of the duplex DNA is translated from left to right by *E. coli* DNA polymerase in the presence of dNTPs. In the lower strand of duplex DNA, nick translation occurs from right to left. The stretches of newly synthesized DNA are represented by the colored arrows.

**E. COLI DNA POLYMERASE I (HOLOENZYME)****Activity:** 5'→3' DNA polymerase**Substrate:** Single-stranded DNA template with a DNA primer bearing a 3'-hydroxyl group.**Reaction:****For example:****Activity:** 5'→3' Exonuclease**Substrate:** Double-stranded DNA or RNA-DNA hybrids. Degrades double-stranded DNA from the 5' terminus; also degrades the RNA component of an RNA-DNA hybrid (i.e., this nuclease possesses inherent RNase H activity).**Reaction:****For example:**

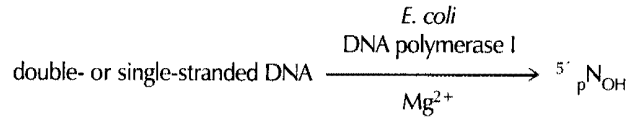
(Continued on following page.)

**E. COLI DNA POLYMERASE I (HOLOENZYME)**

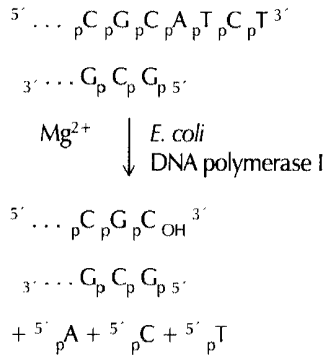
**Activity:** 3'→5' Exonuclease

**Substrate:** Double-stranded or single-stranded DNA containing 3'-hydroxyl termini. Degrades DNA from 3'-hydroxyl termini. Exonuclease activity on double-stranded DNA is blocked by 5'→3' polymerase activity and is inhibited by dNMPs with 5' phosphates.

**Reaction:**



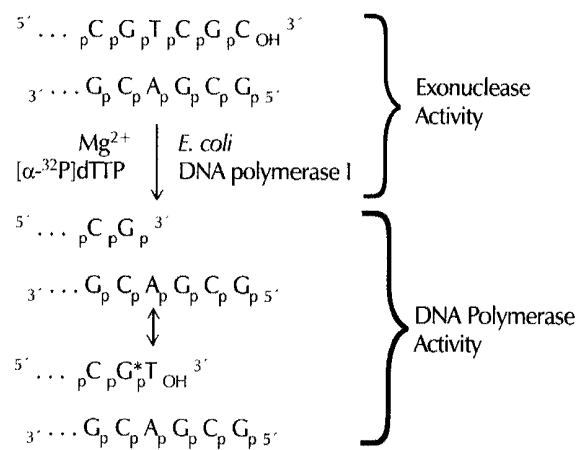
**For example:**



**Activity:** Exchange (replacement) reaction

**Substrate:** If only one dNTP is present, the 3'→5' exonuclease activity will degrade double-stranded DNA from the 3'-hydroxyl terminus until a base is exposed that is complementary to the dNTP. A continuous series of synthesis and exchange reactions will then occur at that position.

**Reaction:**



## Large Fragment of DNA Polymerase I (Klenow Fragment)

(*E. coli*)

The 5'→3' exonuclease activity of *E. coli* DNA polymerase I is often troublesome because it degrades the 5' terminus of primers that are bound to DNA templates and removes 5' phosphates from the termini of DNA fragments that are to be used as substrates for ligation. The 5'→3' exonuclease activity can be removed proteolytically from the holoenzyme without affecting either the polymerase activity or the 3'→5' exonuclease activity (Klenow and Henningsen 1970). The Klenow fragment of *E. coli* DNA polymerase I that is available today from commercial sources consists of a single polypeptide chain ( $M_r = 76,000$ ) produced by cleavage of intact DNA polymerase I with subtilisin or by cloning (Jacobsen et al. 1974; Joyce and Grindley 1983). For further details, please see the information panel on *E. COLI* DNA POLYMERASE I AND THE KLENOW FRAGMENT in Chapter 9.

### USES

1. Filling the recessed 3' termini created by digestion of DNA with restriction enzymes. In many cases, a single buffer can be used both for cleavage of DNA with a restriction enzyme and for the subsequent filling of recessed 3' termini (or end-labeling of DNA molecules with protruding 3' tails [please see Use 3]). The Klenow fragment works well in virtually all buffers used for digestion of DNA with restriction enzymes. However, not all restriction enzymes work in buffers used for DNA polymerase reactions, and it is advisable to carry out pilot reactions with the particular batch of enzyme on hand. If the restriction enzyme does not work in the DNA polymerase buffer, it will be necessary to carry out the restriction enzyme digestion and filling of recessed 3' termini in two separate steps. In this case, cleave the DNA in the appropriate restriction enzyme buffer, remove the restriction enzyme by extraction with phenol:chloroform, precipitate the DNA with ethanol, dissolve it in TE, and add the appropriate volume of a 10X DNA polymerase buffer.
2. Labeling the termini of DNA fragments by using [<sup>32</sup>P]dNTPs to fill recessed 3' termini (end-labeling).
3. End-labeling of DNA molecules with protruding 3' tails. This reaction works in two stages. First, the 3'→5' exonuclease activity removes protruding 3' tails from the DNA and creates a recessed 3' terminus. Then, in the presence of high concentrations of one radiolabeled precursor, exonucleolytic degradation is balanced by incorporation of dNTPs at the 3' terminus. This reaction, which consists of cycles of removal and replacement of the 3'-terminal nucleotides from recessed or blunt-ended DNA, is sometimes called an exchange or replacement reaction. If this type of reaction is used for end-labeling, bacteriophage T4 DNA polymerase is the enzyme of choice. Although both the Klenow fragment of *E. coli* DNA polymerase I and bacteriophage T4 DNA polymerase can carry out an exchange reaction, the bacteriophage enzyme carries a more potent 3'→5' exonuclease activity.
4. Synthesis of the second strand of cDNA in cDNA cloning.
5. Synthesis of double-stranded DNA from single-stranded templates during in vitro mutagenesis. The Klenow fragment can displace hybridized oligonucleotide primers from the template, leading to low frequencies of mutagenesis. This problem can be avoided by using bacteriophage T4 DNA polymerase, which does not cause strand displacement (Nossal 1974).
6. Sequencing of DNA using the Sanger dideoxy-mediated chain-termination method (Sanger et al. 1977).

7. At one time, the 3'→5' exonuclease activity of the Klenow fragment was used to digest protruding 3' termini created by some restriction enzymes. Lately, bacteriophage T4 DNA polymerase has become the enzyme of choice for this purpose because of its greater 3'→5' exonuclease activity.
8. The Klenow fragment has also been used in the polymerase chain reaction to amplify genomic DNA sequences in vitro that are to be used as probes or for direct cloning of mutant alleles of known genes. However, the *Taq* DNA polymerase has now become the enzyme of choice for this purpose because it is stable in heat and therefore need not be freshly added after each round of synthesis and denaturation.

**NOTES**

- End-labeling with the Klenow fragment provides an alternative to the use of bacteriophage T4 polynucleotide kinase for generating labeled DNA fragments that can be used as size markers during gel electrophoresis. Because DNA fragments are labeled in proportion to their molar concentrations and not their sizes, both small and large fragments in a restriction digest become labeled to an equal extent. It is therefore possible to use autoradiography to locate bands of DNA that are too small to be visualized by staining with ethidium bromide or SYBR dyes.
- The end-filling and end-labeling reactions work well on relatively crude DNA preparations (e.g., minipreparations of plasmids).

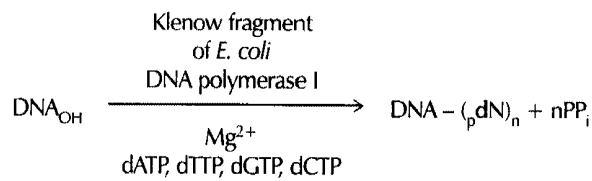
**E. COLI DNA POLYMERASE I KLENOW FRAGMENT**

---

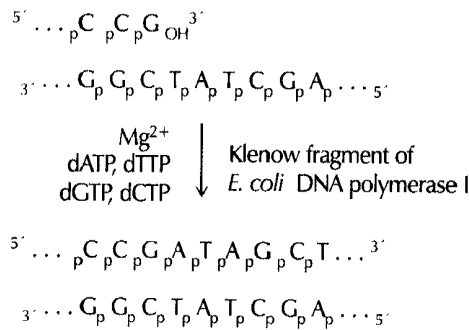
**Activity:** 5'→3' DNA polymerase

**Substrate:** Single-stranded DNA template with a primer containing a free 3'-hydroxyl group.

**Reaction:**



**For example:**

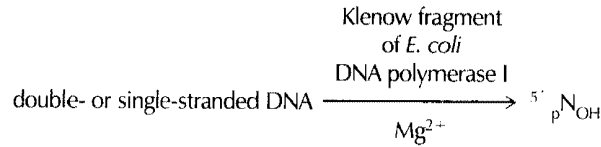


**E. COLI DNA POLYMERASE I KLENOW FRAGMENT**

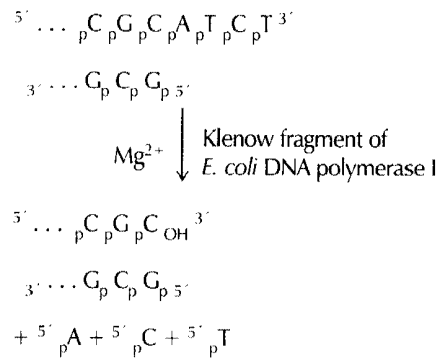
**Activity:** 3'→5' Exonuclease

**Substrate:** Double-stranded or single-stranded DNA degrades from free 3'-hydroxyl termini; exonuclease activity on double-stranded DNAs is blocked by 5'→3' polymerase activity.

**Reaction:**



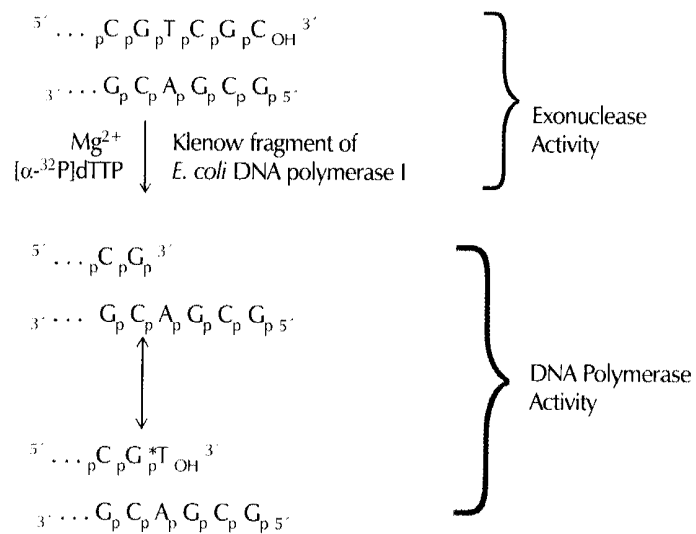
**For example:**



**Activity:** Exchange (replacement) reaction

**Substrate:** If only one dNTP is present, 3'→5' exonuclease activity will degrade double-stranded DNA from the 3'-hydroxyl terminus until a base is exposed that is complementary to the dNTP. A continuous series of synthesis and exchange reactions will then occur at that position.

**Reaction:**





## Bacteriophage T4 DNA Polymerase

(Bacteriophage T4-infected *E. coli*)

Bacteriophage T4 DNA polymerase ( $M_r = 114,000$ ) and the Klenow fragment of *E. coli* polymerase I are similar in that each possesses a 5'→3' polymerase activity and a 3'→5' exonuclease activity that is more active on single-stranded DNA than on double-stranded DNA. However, the exonuclease activity of bacteriophage T4 DNA polymerase is more than 200 times that of the Klenow fragment. Because it does not displace oligonucleotide primers from single-stranded DNA templates (Nossal 1974), bacteriophage T4 DNA polymerase works more efficiently than the Klenow fragment in mutagenesis reactions *in vitro*.

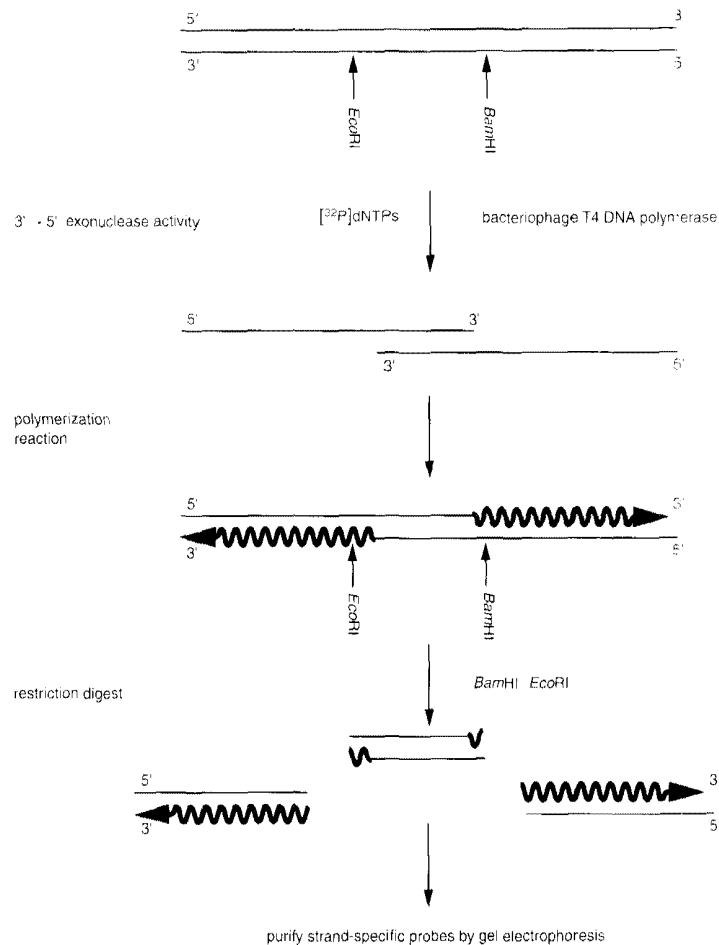
### USES

1. Filling or labeling the recessed 3' termini created by digestion of DNA with restriction enzymes. Labeling reactions must be carried out in the presence of high concentrations of dNTPs in order for the polymerization (filling) reaction to overwhelm the powerful 3'→5' exonuclease activity.
2. End-labeling of DNA molecules with protruding 3' tails. This reaction works in two stages. First, the potent 3'→5' exonuclease activity removes protruding 3' tails from the DNA and creates a recessed 3' terminus. Then, in the presence of high concentrations of one radiolabeled precursor, exonucleolytic degradation is balanced by incorporation of dNTPs at the 3' terminus. This reaction, which consists of cycles of removal and replacement of the 3'-terminal nucleotides from recessed or blunt-ended DNA, is sometimes called an exchange or replacement reaction.

In many cases, a single buffer can be used both for cleavage of DNA with a restriction enzyme and for the subsequent end-labeling. Bacteriophage T4 DNA polymerase will function at ~50% of maximal activity in many buffers that are commonly used for digestion of DNA with restriction enzymes. However, not all restriction enzymes work in buffers used for DNA polymerase reactions, and it is advisable to carry out pilot reactions with the particular batch of enzyme on hand. If the restriction enzyme does not work in the DNA polymerase buffer, it will be necessary to carry out the restriction enzyme digestion and end-labeling in two separate steps. In this case, cleave the DNA in the appropriate restriction enzyme buffer, remove the restriction enzyme by extraction with phenol:chloroform, precipitate the DNA with ethanol, dissolve it in TE, and add the appropriate volume of a 10x DNA polymerase buffer. Filling and end-labeling reactions with bacteriophage T4 DNA polymerase can be carried out at 12°C to maximize the ratio of polymerase activity to exonuclease activity. However, these reactions are often carried out at room temperature or at 37°C without adverse effects.

3. Labeling DNA fragments for use as hybridization probes. The recessed 3' termini created by partial digestion of double-stranded DNA with the 3'→5' exonuclease activity are filled with [<sup>32</sup>P]dNTPs (replacement synthesis) (O'Farrell et al. 1980). Hybridization probes prepared by this technique have two advantages over probes prepared by nick translation. First, they lack the artifactual hairpin structures that can be produced during nick translation. Second, they can easily be converted into strand-specific probes by cleavage with suitable restriction enzymes (please see Figure A4-2).

By contrast to nick translation, however, this method does not produce a uniform distribution of label along the length of the DNA. Furthermore, 3' exonuclease activity degrades single-stranded DNA much faster than it degrades double-stranded DNA, so that after a molecule has been digested to its midpoint, it will dissociate into two half-length single strands that will



**FIGURE A4-2 Production of Strand-specific Hybridization Probes**

be rapidly degraded. It is therefore important to stop the exonuclease reaction before the enzyme reaches the center of the molecule. Consequently, the replacement synthesis method yields a population of molecules that are fully labeled at their termini but contain progressively decreasing quantities of label toward their centers.

4. Conversion of termini of double-stranded DNA to blunt-ended molecules. Protruding 3' termini will be removed from double-stranded DNA by the potent 3'→5' exonuclease activity of bacteriophage T4 DNA polymerase. In the presence of high concentrations of dNTPs, further degradation of the double-stranded region of the template will be balanced by synthesis. The ability to convert protruding 3' termini to blunt ends is an extremely valuable reaction that is frequently used when preparing DNAs for addition of synthetic linkers. As described above, molecules with recessed 3' termini can be repaired by bacteriophage T4 DNA polymerase in a filling reaction similar to that catalyzed by the Klenow fragment. Thus, DNAs with a mixture of protruding 5' and 3' termini (e.g., double-stranded cDNAs synthesized from RNA templates) can be converted to blunt-ended molecules (polished) by bacteriophage T4 DNA polymerase in the presence of high concentrations of dNTPs.
5. Extension of mutagenic oligonucleotide primers that are bound to single-stranded DNA templates. Bacteriophage T4 DNA polymerase is preferred in this reaction to the Klenow fragment because it cannot displace the short oligonucleotide from the template. The efficiency of mutagenesis is therefore increased approximately twofold.

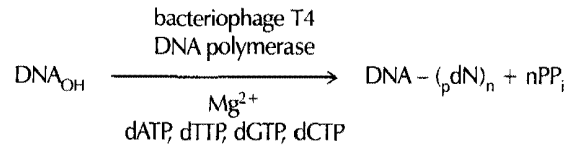
**BACTERIOPHAGE T4 DNA POLYMERASE**

---

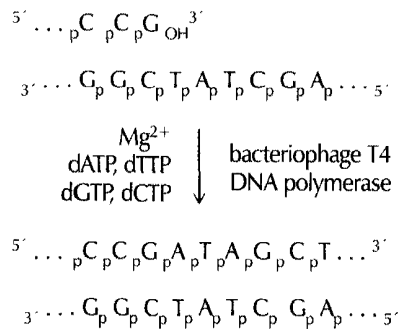
**Activity:** 5' → 3' DNA polymerase

**Substrate:** 3'-hydroxyl, single-stranded DNA template-primer complex. The enzyme cannot displace the strand ahead of the nick. However, addition of bacteriophage T4 gene 32 protein allows the enzyme to begin synthesis at a nick in buffers of low ionic strength.

**Reaction:**



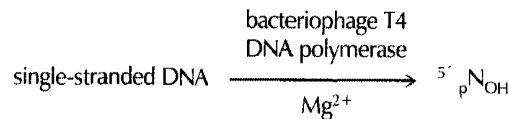
**For example:**



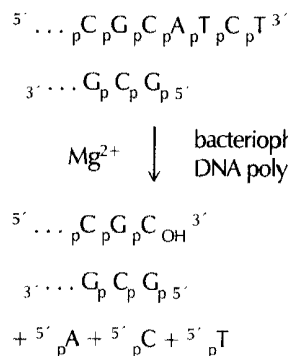
**Activity:** 3' → 5' Exonuclease

**Substrate:** Considerably more active on single-stranded DNA than on double-stranded DNA; exonuclease activity on double-stranded DNAs is blocked by 5' → 3' DNA polymerase activity.

**Reaction:**



**For example:**

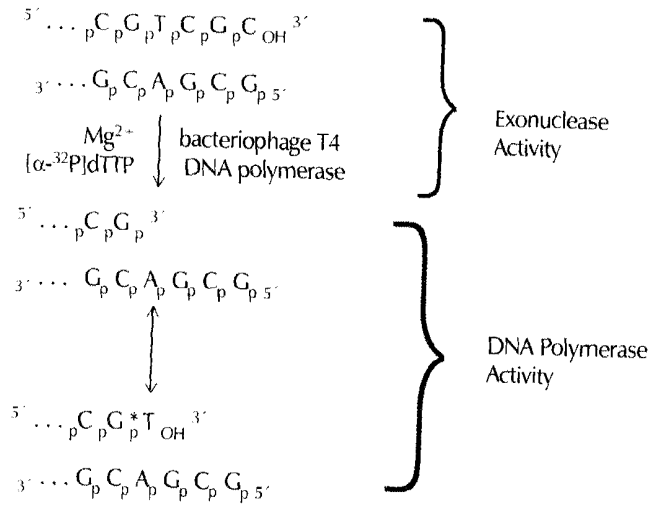


**BACTERIOPHAGE T4 DNA POLYMERASE**

**Activity:** Exchange (replacement) reaction

**Substrate:** If only one dNTP is present, 3'→5' exonuclease activity will degrade double-stranded DNA from the 3'-hydroxyl terminus until a base is exposed that is complementary to the dNTP. A continuous series of synthesis and exchange reactions will then occur at that position.

**Reaction:**



## Bacteriophage T7 DNA Polymerase

(Bacteriophage T7-infected *E. coli*)

The DNA polymerase synthesized after infection of *E. coli* by bacteriophage T7 is a complex of two tightly bound proteins, the bacteriophage T7 gene 5 protein and the host protein thioredoxin. This complex is the most processive of all known DNA polymerases. In other words, the average length of DNA synthesized by a single molecule of bacteriophage T7 DNA polymerase is greater than that of DNAs synthesized by other thermolabile DNA polymerases. This property has considerable advantages, for example, when sequencing DNA by the Sanger dideoxy chain-termination method (Sanger et al. 1977) (please see Chapter 12). Bacteriophage T7 DNA polymerase, like the Klenow fragment and the holoenzyme of *E. coli* DNA polymerase I and bacteriophage T4 DNA polymerase, has a 3'→5' exonuclease activity (encoded by bacteriophage T7 gene 5). As in bacteriophage T4 DNA polymerase, the 3'→5' exonuclease activity is potent. The degree of activity of the 3'→5' exonuclease of bacteriophage T7 DNA polymerase is ~1000 times that of the Klenow fragment. Bacteriophage T7 DNA polymerase does not have a 5'→3' exonuclease activity (Tabor et al. 1987). For illustrations of the 5'→3' DNA polymerase and 3'→5' exonuclease activities and exchange reaction encoded by bacteriophage T7 DNA polymerase, please see the panel on **BACTERIOPHAGE T4 DNA POLYMERASE** (p. A4.20). For more information on wild-type and modified T7 DNA polymerase (Sequenase and Sequenase version 2.0), please see the information panel on **SEQUENASE** in Chapter 12.

### USES

1. Primer-extension reactions that require the copying of long stretches of template.
2. Rapid end-labeling by either filling or exchange (replacement) reactions such as those described for bacteriophage T4 DNA polymerase.

## Thermostable DNA-dependent DNA Polymerases

Thermostable DNA-dependent DNA polymerases have been purified and characterized from a number of organisms, primarily from the thermophilic and hyperthermophilic eubacteria Archaeobacteria, whose most abundant DNA polymerases are reminiscent of DNA polymerase I of mesophilic bacteria, and thermophilic Archaea, whose chief DNA polymerases belong to the polymerase  $\alpha$  family. Although there is considerable structural variation among thermostable DNA polymerases, all are monomeric with molecular mass values ranging from 60 kD to 100 kD. The significant properties and activities of thermostable DNA polymerases are given in Table A4-5.

The first well-characterized thermostable DNA polymerases were isolated from the extreme thermophile *Thermus aquaticus* (Chien et al. 1976). One of these early isolates, *Taq* DNA polymerase, has, along with a number of genetically engineered variants, become an indispensable component of reactions to amplify specific sequences of DNA in vitro by polymerase chain reaction and in DNA sequencing (please see the introductions to Chapters 8 and 12, respectively). *Taq* and its derivatives have a 5'→3' polymerization-dependent exonuclease activity. For nucleotide incorporation, the enzyme works best at 75–80°C, depending on the target sequence; its polymerase activity is reduced by a factor of 2 at 60°C and by a factor of 10 at 37°C. In many cases, however, it is necessary to initiate polymerization reactions at suboptimal temperatures in order to prevent dissociation of the primer from the template. For further information on *Taq* and other thermostable polymerases, please see the introduction to Chapter 8 and the information panel on **TAQ DNA POLYMERASE** in Chapter 8.

TABLE A4-5 Properties of Thermostable DNA Polymerases

ENZYME	MANUFACTURER <sup>a</sup>	ORGANISM	OPTIMUM TEMPERATURE (°C)	EXONUCLEASE ACTIVITY	ERROR RATE ×10 <sup>-6</sup>	STABILITY (MINUTES AT SPECIFIED TEMPERATURE)	K <sub>m</sub> dNTP (μM)	K <sub>m</sub> DNA (nM)
<i>Taq</i>	BM, LT, Pro, Strat, P-E, T	<i>T. aquaticus</i>	75–80	5'–3'	20–100	9 min at 97.5°C	10–16	2
<i>Taq</i> Stoffel fragment	P-E	<i>T. aquaticus</i>	75–80	none	50	21 min at 97.5°C	–	2
<i>rTth</i>	BM, ET, P-E	<i>T. thermophilus</i>	75–80	5'–3'	~20	20 min at 95°C	115	–
<i>Tfl</i>	Pro	<i>T. flavus</i>	70	none	100	120 min at 70°C	63	–
<i>Hot Tub</i>	Amr	<i>T. ubiquitus</i>	–	none	–	–	–	–
<i>Tbr</i>	Amr, Finnz	<i>T. brockianus</i>	75–80	5'–3'	–	150 min at 96°C	–	–
<i>Ultima</i>	P-E, Roche	<i>Thermotoga maritima</i>	75–80	3'–5'	–	50 min at 95°C	–	–
<i>rBst</i>	ET	<i>Bacillus sterothermophilus</i>	60–65	5'–3' (3'–5') <sup>b</sup>	–	–	–	–
Isotherm <i>Bst</i> large fragment	ET, Bio-Rad	<i>Bacillus sterothermophilus</i>	60–65	none	–	–	7–85	–
<i>Pwo</i>	BM	<i>Pyrococcus woesei</i>	60–65	3'–5'	3.2	>2 hr at 100°C	–	–
<i>Tli</i>	Pro	<i>Thermococcus litoralis</i>	70–80	3'–5'	20–45	100 min at 100°C	66	0.1
<i>DeepVent</i>	NEB	<i>Pyrococcus</i> (strain GB-D)	70–80	3'–5'	20–45	480 min at 100°C	50	0.01
<i>Pfu</i>	Strat	<i>Pyrococcus furiosus</i>	72–78	3'–5'	1.6	240 min at 95°C	–	–

Data for this table were taken from reviews by Perler et al. (1996) and Bej and Mahbubani (1994), from Internet sources, and from literature distributed by commercial manufacturers. For details of the reaction conditions that are optimal for each enzyme, please consult the instructions supplied with the enzyme by the manufacturer.

<sup>a</sup>(BM) Boehringer Mannheim; (ET) Epicentre Technologies; (LT) Life Technologies; (Pro) Promega; (NEB) New England Biolabs; (P-E) Perkin-Elmer; (T) TaKaRa; (Strat) Stratagene; (Amr) Amresco; (Finnz) Finnzymes OY.

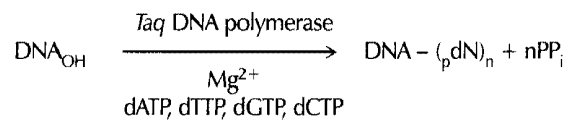
<sup>b</sup>Suspected activity.

### TAQ DNA POLYMERASE

**Activity:** 5'→3' DNA polymerase

**Substrate:** Single-stranded template, primer with 3'-hydroxyl.

**Reaction:**



### Reverse Transcriptase (RNA-dependent DNA Polymerase)

(Murine and avian retroviruses)

Two forms of reverse transcriptases are commercially available: a preparation made from purified avian myeloblastosis virus (AMV) and an enzyme isolated from a strain of *E. coli* that expresses a cloned copy of the reverse transcriptase gene of the Moloney murine leukemia virus (Mo-MLV). Both enzymes lack a 3'→5' exonuclease active on DNA and catalyze the reactions shown below in the panel on **REVERSE TRANSCRIPTASE**. The murine and avian reverse transcriptases differ from each other in a number of respects:

- The avian enzyme consists of two polypeptide chains that carry both a polymerase activity and a powerful RNase H activity (Verma 1981). The murine enzyme, a single polypeptide chain of  $M_r = 84,000$ , has a polymerase activity and a comparatively weak RNase H activity (Gerard 1983). This weak RNase activity is a considerable advantage when attempting to synthesize

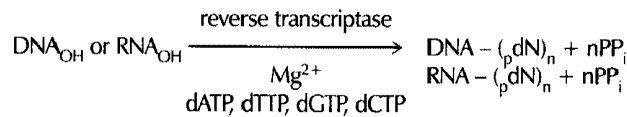
#### REVERSE TRANSCRIPTASE

---

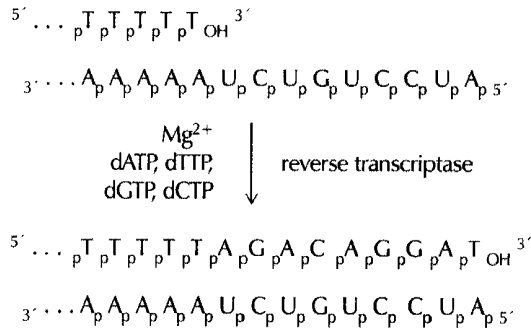
**Activity:** 5'→3' DNA polymerase

**Substrate:** RNA or DNA template with an RNA or DNA primer bearing a 3'-hydroxyl group.

**Reaction:**



**For example:**



**Activity:** RNase H (5'→3' and 3'→5' exoribonuclease)

**Substrate:** Reverse transcriptase specifically degrades RNA in an RNA-DNA hybrid by a processive mechanism.

**Reaction:** Degradation of substrates with free ends yielding ribonucleotide products that are 4–20 nucleotides in length and contain 5'-phosphate and 3'-hydroxyl termini.



cDNAs complementary to long mRNAs. At the beginning of the reaction, the hybrids formed between the primer and the template mRNA are substrates for RNase H. Thus, at the beginning of cDNA synthesis, there is a competition between degradation of the template mRNA and initiation of DNA synthesis (Berger et al. 1983). In addition, RNase H can cleave the template near the 3' terminus of the growing DNA strand if reverse transcriptase pauses during synthesis (Kotewicz et al. 1988). In consequence, the high level of RNase H activity in preparations of the avian enzyme tends to suppress the yield of cDNA and to restrict its length.

- The avian enzyme works efficiently at 42°C (the normal body temperature of chickens), whereas the wild-type murine enzyme is rapidly inactivated at this temperature. RNAs rich in secondary structure are therefore copied more efficiently by the avian enzyme than by the murine enzyme. However, preparations of the avian enzyme can be contaminated by an endonuclease that cleaves DNA. This is now less of a problem than it was in the early 1980s, when cDNA libraries generated with comparatively impure preparations of the avian enzyme seldom exceeded 1 kb in length.
- The avian enzyme works more efficiently at pH 8.3 than at pH 7.6, the pH preferred by the murine enzyme. The length of the cDNA synthesized by either enzyme is greatly reduced when reactions are carried out at a pH that differs from the optimum by as little as 0.2 unit. Since the pH of Tris changes with temperature, it is essential to check that the pH of the reaction mixture is correct at the temperature chosen for incubation.

For more information, please see the information panel on **Mo-MLV REVERSE TRANSCRIPTASE** in Chapter 11.

## USES

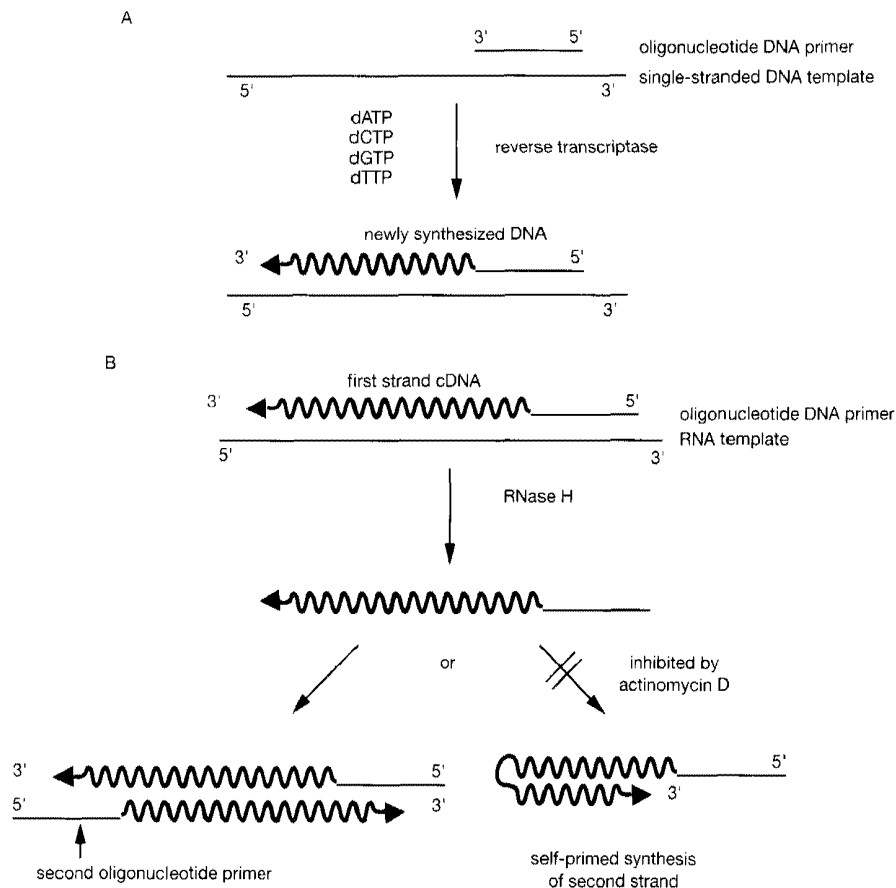
1. Reverse transcriptase is used chiefly to transcribe mRNA into double-stranded cDNA that can be inserted into prokaryotic vectors. However, reverse transcriptase can also be used with either single-stranded DNA or RNA templates to make probes for use in hybridization experiments. Three types of primers are used in these reactions:
  - *Oligo(dT)<sub>12-18</sub>* which binds to the poly(A) tract at the 3' terminus of mammalian mRNAs and primes the synthesis of the first strand of cDNA. Depending on the quality of the reverse transcriptase and the reaction conditions, the sequences at the 3' terminus of the template may be overrepresented in the cDNA.
  - *Oligonucleotides of random sequence* (Taylor et al. 1976). The aim is to use a population of oligonucleotides whose sequence diversity is so large that at least some individual oligonucleotides will anneal to the template and serve as primers for reverse transcriptase. Because different oligonucleotides bind to different sequences, a large proportion of the sequences of the template will be copied by the enzyme, and if all of the primers are present at equal concentrations, all sequences of the template should be copied at equal frequencies. Oligonucleotides of random sequence can be synthesized on an automated DNA synthesizer or can be generated by hydrolysis of high-molecular-weight DNA.
  - *Oligonucleotides of defined sequence*. Oligonucleotides of defined sequence can be used to prime the synthesis of cDNA corresponding to a particular mRNA. Because the newly synthesized DNA is complementary to the sequences of the mRNA that lie upstream of the primer, this method (primer extension) provides an accurate measurement of the distance between a fixed point on an mRNA and its 5' terminus.
2. Labeling the termini of DNA fragments with protruding 5' termini (filling reaction).



- The enzyme can also be used to sequence DNAs by the dideoxy chain termination method (Sanger et al. 1977) when other enzymes (e.g., the Klenow fragment or Sequenase) yield unsatisfactory results.

**NOTES**

- Reverse transcriptase lacks 3'→5' exonuclease activity, which acts as an editing function in *E. coli* DNA polymerase I, and is therefore prone to error. In the presence of high concentrations of dNTPs and Mn<sup>2+</sup>, ~1 base in every 500 is misincorporated.
- Because the  $K_m$  of reverse transcriptase for its dNTP substrates is very high — in the millimolar range — it is essential to include high concentrations of dNTPs in this reaction to prevent premature termination of newly synthesized DNA chains.
- Reverse transcriptase can be used to synthesize single-stranded copies of DNA templates using oligonucleotide primers (please see Figure A4-3, part A). However, both double-stranded and single-stranded cDNAs are generated from RNA templates (please see Figure A4-3, part B). Self-primed synthesis is much less efficient than synthesis from the added oligonucleotide primers. Therefore, self-complementary hairpin molecules usually constitute only a small fraction of the synthesized double-stranded cDNA (see Chapter 11). If necessary, both self-primed and exogenously primed second-strand synthesis can be inhibited by including actinomycin D in the reaction mixture at a final concentration of 50 µg/ml.



**FIGURE A4-3 Use of Reverse Transcriptase to Generate Probes from DNA (A) and RNA (B) Templates**

## Terminal Transferase (Terminal Deoxynucleotidyl Transferase)

(Calf thymus)

Terminal transferase ( $M_r = 60,000$ ) is an unusual DNA polymerase found only in prelymphocytes in early stages of lymphoid differentiation (Chang and Bollum 1986). In the presence of a divalent cation, the purified enzyme catalyzes the addition of dNTPs to the 3'-hydroxyl termini of DNA molecules (Bollum 1974). When the nucleotide to be added is a purine,  $Mg^{2+}$  is the preferred cation; when the nucleotide is a pyrimidine,  $Co^{2+}$  is used instead. The minimum chain length of the acceptor DNA is three dNTPs, and as many as several thousand dNTPs can be incorporated if the ratio of acceptor to nucleotide is adjusted correctly. Single nucleotides can be added to the 3' termini of DNA if modified nucleotides (e.g., ddNTPs or cordycepin triphosphate) are used as substrates. Homopolymers of rNTPs can also be synthesized at the 3' termini of DNA molecules in the presence of  $Co^{2+}$  (for references, please see Chang and Bollum 1986). The enzyme strongly prefers to use DNAs with protruding 3' termini as acceptors. However, blunt or recessed 3' termini are used, albeit less efficiently, in buffers of low ionic strength that contain  $Co^{2+}$  or  $Mn^{2+}$  (Roychoudhury et al. 1976; Nelson and Brutlag 1979; Roychoudhury and Wu 1980; Michelson and Orkin 1982; Deng and Wu 1983). For further information, please see the information panel on **TERMINAL TRANSFERASE** in Chapter 8.

### USES

1. Addition of complementary homopolymeric tails to vector and cDNA.
2. Labeling the 3' termini of DNA fragments with a  $^{32}P$ -labeled dNTP (Tu and Cohen 1980), a ddNTP (Cozzarelli et al. 1969), or an rNTP (Wu et al. 1976). For labeling with rNTPs, [ $\alpha$ - $^{32}P$ ]rNTP is used in the presence of  $Co^{2+}$ , followed by treatment with alkali (please see the panel on **TERMINAL TRANSFERASE** below).

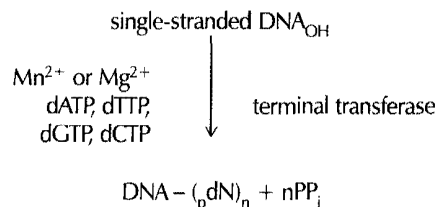
### TERMINAL TRANSFERASE

---

**Activity:** Terminal transferase

**Substrate:** Single-stranded DNA with a 3'-hydroxyl terminus or double-stranded DNA with a protruding 3'-hydroxyl terminus is preferred. Blunt-ended, double-stranded DNA or DNA with a recessed 3'-hydroxyl terminus serves as a template if  $Co^{2+}$  is supplied as a cofactor (Roychoudhury et al. 1976; Nelson and Brutlag 1979; Roychoudhury and Wu 1980; Michelson and Orkin 1982; Deng and Wu 1983).

**Reaction:**



## DNA-DEPENDENT RNA POLYMERASES

---

### Bacteriophage SP6 and Bacteriophages T7 and T3 RNA Polymerases

(Bacteriophage SP6-infected *Salmonella typhimurium* LT2 and bacteriophage T7- or T3-infected *E. coli*)

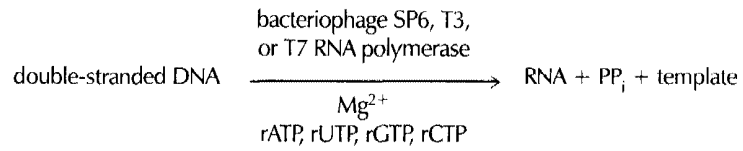
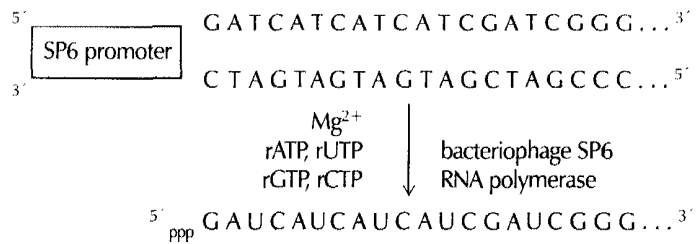
Bacteriophage SP6 synthesizes a DNA-dependent RNA polymerase that recognizes and initiates synthesis of RNA on double-stranded DNA templates carrying the appropriate bacteriophage-specific promoter. The polymerase is used *in vitro* to generate large quantities of RNA complementary to one strand of foreign DNA that has been placed immediately downstream from the promoter. Vectors carrying the promoter are available to synthesize RNA complementary to either strand of the template by changing the orientation of the promoter with respect to the cloned foreign DNA sequences (Butler and Chamberlin 1982; Melton et al. 1984). Alternatively, the promoter can be added to the target DNA during PCR primed by oligonucleotides equipped with a consensus promoter (please see Chapter 9, Protocol 6).

Bacteriophages T7 and T3 also synthesize DNA-dependent RNA polymerases that recognize and initiate synthesis of RNA on double-stranded DNA templates that carry the appropriate bacteriophage-specific promoter (for further details, please see the information panel on **PROMOTER SEQUENCES RECOGNIZED BY BACTERIOPHAGE-ENCODED RNA POLYMERASES** in Chapter 7). These polymerases are used *in vitro* just like the bacteriophage SP6 RNA polymerase. Bacteriophages T7 and T3 RNA polymerases have been cloned and expressed in *E. coli* (Davanloo et al. 1984; Tabor and Richardson 1985; Morris et al. 1986), and bacteriophage T7 RNA polymerase has been cloned and expressed in yeast (Chen et al. 1987). Vectors carrying the bacteriophage T7 promoter may therefore be used to express cloned genes *in vivo* (please see point 2 under Uses below).

### USES

1. Synthesis of single-stranded RNA for use as hybridization probes, functional mRNAs for *in vitro* translation systems, or substrates for *in vitro* splicing reactions. Each of the three RNA polymerases has a high degree of specificity for its cognate promoter.
2. The bacteriophage T7 transcription system has been used to express cloned genes in bacteria (Tabor and Richardson 1985; Studier and Moffatt 1986) and in yeast (Chen et al. 1987). Two types of bacteriophage T7 expression systems have been developed for *E. coli*. In the first system, stable lysogens are established with bacteriophage  $\lambda$  carrying the bacteriophage T7 RNA polymerase gene under the control of the *E. coli lacUV5* promoter. Plasmids containing the gene of interest under the control of the bacteriophage T7 promoter are then introduced into the lysogens containing the bacteriophage T7 RNA polymerase gene. Activation of the bacteriophage T7 promoter is then achieved by isopropylthio- $\beta$ -D-galactoside induction of the *lacUV5* promoter driving the bacteriophage T7 RNA polymerase gene. In the second system, the bacteriophage T7 promoter/plasmid carrying the gene of interest is introduced into bacteria, and the bacteriophage T7 promoter is activated by infecting the bacteria with bacteriophage  $\lambda$  containing the bacteriophage T7 RNA polymerase gene.

In yeast, the bacteriophage T7 RNA polymerase gene is placed under the control of a yeast promoter and stably introduced into yeast cells on an autonomously replicating vector. Expression is achieved by introducing into the yeast cells a second plasmid that contains the gene of interest under the control of the bacteriophage T7 promoter (Chen et al. 1987).

**BACTERIOPHAGES SP6, T3, AND T7 DNA-DEPENDENT RNA POLYMERASES****Activity:** 5'→3' RNA polymerase**Substrate:** Double-stranded DNA molecules containing bacteriophage SP6, T3, or T7 promoters.**Reaction:****For example:**

## LIGASES, KINASES, AND PHOSPHATASES

DNA ligases catalyze end-to-end joining of pieces of DNA. The ligases used most often in cloning are encoded by bacteriophage T4, although there is a less versatile enzyme available from uninfected *E. coli*. Both types of ligases are used primarily on DNA substrates with 5'-terminal phosphate groups.

RNA ligase is a bacteriophage T4 enzyme that is capable of covalently joining single-stranded RNA (or DNA) molecules containing 5'-phosphate and 3'-hydroxyl termini. However, the primary use of this enzyme has been in 3' end-labeling of RNA. This is accomplished using <sup>32</sup>P-labeled mononucleoside 3',5'-bisphosphate (pNp), which is added to the 3'-hydroxyl terminus of RNA.

The DNA ligases used in molecular cloning differ in their abilities to ligate noncanonical substrates, such as blunt-ended duplexes, DNA-RNA hybrids, or single-stranded DNAs. These and other properties are summarized in Table 1-12 in Chapter 1 and discussed below. For additional information on DNA ligases, please see the information panel on **DNA LIGASES** in Chapter 1.

DNAs that lack the required phosphate residues can be prepared for ligation by phosphorylation with bacteriophage T4 polynucleotide kinase. Conversely, DNAs can be rendered resistant to ligation by enzymatic removal of phosphate residues from their 5' termini with phosphatases. The properties of bacteriophage T4 polynucleotide kinase are summarized in Table A4-6 and described in greater detail below. The data in this table have been collected from numerous papers published over the years. The values serve as accurate guidelines for using the enzymes, but optimal conditions will always vary slightly with the enzyme preparation (degree of purity) and the DNA preparation, or when carrying out a sequence of enzymatic reactions (e.g., digestion, end-filling, and ligation) in one mixture.

**TABLE A4-6 Properties of Bacteriophage Polynucleotide Kinase**

	FORWARD REACTION	EXCHANGE REACTION
Nucleic acid substrate	double-stranded DNA single-stranded RNA or DNA nick or gap oligonucleotide 3' dNMP	double-stranded DNA single-stranded RNA or DNA nick or gap oligonucleotide
$K_m$	double-stranded DNA, 7.6 $\mu$ M 5' dNMP, 22–143 $\mu$ M ATP, 14–140 $\mu$ M <sup>b</sup>	ADP, 300 $\mu$ M <sup>a</sup> ATP, 10 $\mu$ M <sup>a</sup>
pH optimum	7.4–8.0 (Tris-Cl)	6.4 (imidazole)
Sulphydryl requirement	+	+
Mg <sup>2+</sup> requirement	+	+
Effect of ionic strength	stimulated by NaCl and KCl excess KCl inhibits on all substrates except single-stranded DNA	no information
Inhibitors (50% inhibition)	(NH <sub>4</sub> ) <sub>2</sub> SO <sub>4</sub> , 7 mM P <sub>i</sub> , 20 mM PP <sub>i</sub> , 5 mM	P <sub>i</sub> , 50 mM
Activators	polyamine, 2 mM, 300%	no information

<sup>a</sup>These are concentrations that give optimal activity at pH 6.4, not  $K_m$ s.

<sup>b</sup> $K_m$  for ATP varies with substrate.

## Bacteriophage T4 DNA Ligase (Bacteriophage T4-infected *E. coli*)

Bacteriophage T4 DNA ligase, a polypeptide of  $M_r = 68,000$ , catalyzes the formation of phosphodiester bonds between adjacent 3'-hydroxyl and 5'-phosphate termini in DNA (Weiss et al. 1968). The properties of the enzymes are summarized in Table 1-12 in Chapter 1.

### USES

1. Joining DNA molecules with compatible cohesive termini. Intermolecular ligation is stimulated by low concentrations of agents, such as polyethylene glycol, that promote the efficient interaction of macromolecules in aqueous solutions (please see the information panel on **CONDENSING AND CROWDING REAGENTS** in Chapter 1).
2. Joining blunt-ended double-stranded DNA molecules to one another or to synthetic linkers. This reaction is much slower than ligation of cohesive termini. However, the rate of blunt-end ligation is improved greatly by the addition of monovalent cations (150–200 mM NaCl) and low concentrations of polyethylene glycol (Pheiffer and Zimmerman 1983; Hayashi et al. 1986).

### NOTES

- At least three different assays are used to measure the activity of bacteriophage T4 DNA ligase. Most manufacturers (apart from New England Biolabs) now calibrate the enzyme in Weiss units (Weiss et al. 1968). One Weiss unit is the amount of enzyme that catalyzes the exchange of 1 nmole of  $^{32}\text{P}$  from pyrophosphate into  $[\gamma, \beta\text{-}^{32}\text{P}]\text{ATP}$  in 20 minutes at 37°C. One Weiss unit corresponds to 0.2 unit determined in the exonuclease resistance assay (Modrich and Lehman 1970) and to 60 cohesive-end units (as defined by New England Biolabs). 0.015 Weiss unit of bacteriophage T4 DNA ligase therefore will ligate 50% of the *Hind*III fragments of bacteriophage  $\lambda$  (5  $\mu\text{g}$ ) in 30 minutes at 16°C. Throughout this manual, bacteriophage T4 DNA ligase is given in Weiss units.
- Bacteriophage T4 DNA ligase is not inhibited by the presence of dNTPs and works adequately in virtually all buffers used for digestion of DNA with restriction enzymes.

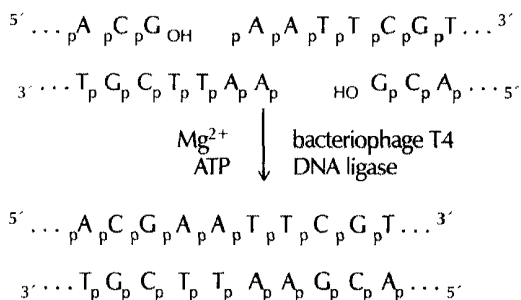
**BACTERIOPHAGE T4 DNA LIGASE**

---

**Activity:** Ligation of cohesive DNA termini or nicks

**Substrate:** Active on double-stranded DNA with complementary cohesive termini that base pair to bring together 3'-hydroxyl and 5'-phosphate termini. In addition, the enzyme is active on nicked DNA and active, albeit far less efficiently, on RNA substrates. (For a more complete description of substrates, see Engler and Richardson 1982.)

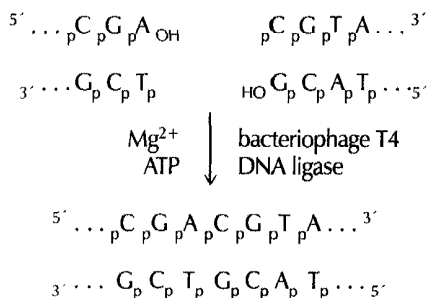
**Reaction:**



**Activity:** Ligation of blunt ends

**Substrate:** High concentrations of blunt-ended, double-stranded DNA containing 5'-phosphate and 3'-hydroxyl termini.

**Reaction:**



***E. coli* DNA Ligase**

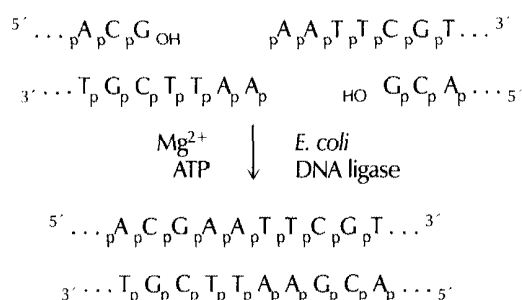
*E. coli* DNA ligase catalyzes the formation of phosphodiester bonds in double-stranded DNA containing complementary protruding 5' or 3' termini (Panasenko et al. 1977, 1978). The reaction requires NAD<sup>+</sup> as a cofactor. Initial studies indicated that this enzyme would not ligate blunt-ended double-stranded DNA, but subsequent studies revealed that blunt-end ligation can be achieved in the presence of polyethylene glycol or Ficoll, compounds that act as volume excluders (please see the information panel on **CONDENSING AND CROWDING REAGENTS** in Chapter 1). This effectively increases the concentration of DNA termini and enzyme (Zimmerman and Pfeiffer 1983). *E. coli* DNA ligase has been used in cDNA cloning methods based on replacement synthesis, as described by Okayama and Berg (1982), because of its inability to join adjacent RNA and DNA segments that arise during the synthesis of the second strand of cDNA. It is not, however, widely used in other molecular cloning procedures, since bacteriophage T4 DNA ligase is capable of efficiently joining blunt ends in the absence of volume excluders. *E. coli* DNA ligase does not ligate RNA.

***E. COLI* DNA LIGASE**

**Activity:** Ligation of cohesive DNA termini or nicks

**Substrate:** Active on double-stranded DNA with complementary cohesive termini that base pair to bring together 3'-hydroxyl and 5'-phosphate termini. In addition, the enzyme is active on nicked DNA. Blunt termini can be ligated in the presence of crowding reagents.

**Reaction:**





## Bacteriophage T4 RNA Ligase

(Bacteriophage T4-infected *E. coli*)

Bacteriophage T4 RNA ligase catalyzes the covalent joining of 5'-phosphate termini in single-stranded DNA or RNA to 3'-hydroxyl termini in single-stranded DNA or RNA (Uhlenbeck and Gumport 1982).

### USES

1. Because small molecules (e.g., pNp) are effective substrates, bacteriophage T4 RNA ligase can be used to radiolabel the 3' termini of RNA molecules in vitro (Uhlenbeck and Gumport 1982).
2. Ligation of oligodeoxyribonucleotides.
3. Bacteriophage T4 RNA ligase has been reported to stimulate the activity of bacteriophage T4 DNA ligase (Sugino et al. 1977). However, agents such as polyethylene glycol that increase macromolecular crowding are equally effective and much less expensive.

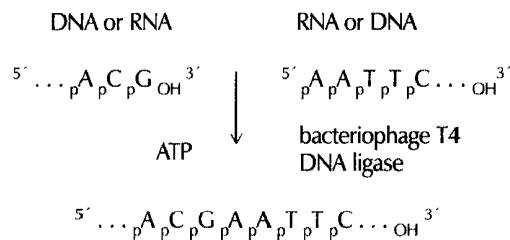
### BACTERIOPHAGE T4 RNA LIGASE

---

**Activity:** RNA ligase

**Substrate:** 5'-phosphate acceptors include single-stranded DNA and RNA. Phosphate donors include single-stranded DNA and RNA and nucleotides such as pNp.

**Reaction:**



## Thermostable DNA Ligases

The genes encoding thermostable ligases from several thermophilic bacteria have been cloned, sequenced, and expressed to high levels in *E. coli* (e.g., please see Takahashi et al. 1984; Barany and Gelfand 1991; Lauer et al. 1991; Jónsson et al. 1994). Several of these enzymes are available from commercial sources. Like the *E. coli* enzyme, almost all thermostable ligases use NAD<sup>+</sup> as a cofactor and work preferentially at nicks in double-stranded DNA. In addition, thermostable ligases, like their mesophilic homolog, can catalyze blunt-end ligation in the presence of crowding agents, even at elevated temperatures (Takahashi and Uchida 1986). Because thermostable ligases retain activity after multiple rounds of thermal cycling, they are used extensively in the ligase amplification reaction to detect mutations in mammalian DNAs.

## Bacteriophage T4 DNA Polynucleotide Kinase

(Bacteriophage T4-infected *E. coli*)

Bacteriophage T4 polynucleotide kinase catalyzes the transfer of the  $\gamma$ -phosphate of ATP to a 5' terminus of DNA or RNA (Richardson 1971). Two types of reactions are commonly used. In the *forward* reaction, the  $\gamma$ -phosphate is transferred to the 5' terminus of dephosphorylated DNA (Richardson 1971). In the *exchange* reaction, an excess of ADP causes bacteriophage T4 polynucleotide kinase to transfer the terminal 5'-phosphate from phosphorylated DNA to ADP; the DNA is then rephosphorylated by transfer of a radiolabeled  $\gamma$ -phosphate from [ $\gamma$ - $^{32}$ P]ATP (Berkner and Folk 1977). In addition to its phosphorylation activity, bacteriophage T4 polynucleotide kinase carries a 3' phosphatase activity (Richardson 1981). The properties of this enzyme are summarized in Table A4-6 and in Richardson (1981).

### USES

1. Radiolabeling 5' termini in DNA for sequencing by the Maxam-Gilbert technique (Maxam and Gilbert 1977), for nuclease S1 analysis, and for other uses requiring terminally labeled DNA.
2. Phosphorylating synthetic linkers and other fragments of DNA that lack terminal 5' phosphates in preparation for ligation.

### NOTES

- Bacteriophage T4 polynucleotide kinase is difficult to purify from infected cells, and impure preparations are not uncommon. Wherever possible, use bacteriophage T4 polynucleotide kinase that has been purified from cells expressing high levels of a cloned copy of the bacteriophage T4 gene.
- When setting up reactions involving the termini of nucleic acid molecules, the concentration of the reacting species can be calculated using Table A4-7 as a guide.
- Spermidine stimulates incorporation of [ $\gamma$ - $^{32}$ P]ATP and inhibits a nuclease present in some preparations of bacteriophage T4 polynucleotide kinase.
- ATP should be present at a concentration of at least 1  $\mu$ M in the forward reaction and at least 2  $\mu$ M in the exchange reaction. Maximum enzyme activity requires still higher concentrations (please see Table A4-6).
- The DNA to be phosphorylated should be rigorously purified by gel electrophoresis, density gradient centrifugation, or chromatography on columns of Sepharose CL-4B in order to remove low-molecular-weight nucleic acids. Although such contaminants may make up only a small fraction of the weight of the nucleic acids in the preparation, they provide a much larger proportion of the 5' termini. Unless steps are taken to remove them, contaminating low-molecular-weight DNAs and RNAs can be the predominant species of nucleic acids that are labeled in bacteriophage T4 polynucleotide kinase reactions.
- Ammonium ions are strong inhibitors of bacteriophage T4 polynucleotide kinase. Therefore, DNA should not be dissolved in, or precipitated from, buffers containing ammonium salts prior to treatment with the kinase.
- Low concentrations of phosphate also inhibit bacteriophage T4 polynucleotide kinase. Imidazole buffer (pH 6.4) is therefore the buffer of choice for the exchange reaction, and Tris buffer is the buffer of choice for the forward reaction.

**TABLE A4-7 Concentration of Ends in Kinasing Reactions**

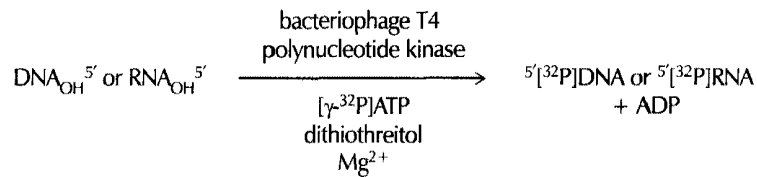
SIZE OF DOUBLE-STRANDED DNA (IN BASE PAIRS)	AMOUNT OF DNA REQUIRED TO CONTRIBUTE 1 $\mu$ MOLE OF 5' TERMINI (IN $\mu$ g)
50	$1.7 \times 10^{-2}$
100	$3.3 \times 10^{-2}$
250	$8.4 \times 10^{-2}$
500	$1.7 \times 10^{-1}$
1000	$3.3 \times 10^{-1}$
2500	$8.4 \times 10^{-1}$
5000	1.7

**BACTERIOPHAGE T4 POLYNUCLEOTIDE KINASE**

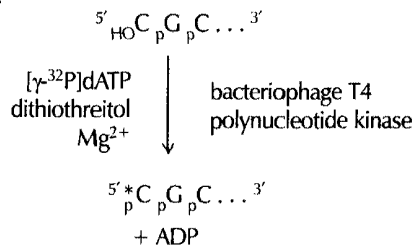
**Activity:** Kinase (forward reaction)

**Substrate:** Single- or double-stranded DNA with 5'-hydroxyl terminus; RNA with a 5'-hydroxyl terminus. The enzyme phosphorylates protruding 5' single-stranded termini more rapidly than blunt ends or recessed 5' termini; however, with sufficient enzyme and ATP, such termini can be completely phosphorylated. The reaction at nicks or gaps in double-stranded DNA is less efficient than for single-stranded termini; however, with sufficient concentrations of ATP and enzyme, gaps can be completely phosphorylated and nicks can be phosphorylated to 70%.

**Reaction:**



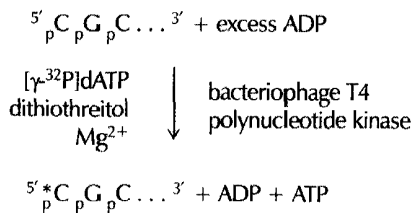
**For example:**



**Activity:** Kinase (exchange reaction)

**Substrate:** Single-stranded DNA with a 5'-phosphate terminus is most efficiently labeled (96%). Recessed 5'-phosphate termini are labeled to 70% with sufficient enzyme. 5'-phosphate groups at nicks are labeled 30-fold less efficiently than single-stranded 5'-phosphate termini.

**Reaction:**



## Alkaline Phosphatases

(*E. coli*, calf intestine, and shrimp)

The three alkaline phosphatases — bacterial alkaline phosphatase (BAP), calf intestinal alkaline phosphatase (CIP), and shrimp alkaline phosphatase (SAP) — catalyze the removal of 5′-phosphate residues from DNA, RNA, rNTPs, and dNTPs. For further details, please see the information panel on **ALKALINE PHOSPHATASE** in Chapter 9.

### USES

1. Removing 5′ phosphates from DNA or RNA prior to labeling 5′ termini with  $^{32}\text{P}$ .
2. Removing 5′ phosphates from fragments of DNA to prevent self-ligation.

### NOTES

- BAP is the most active of the three enzymes, but it is also far more resistant to heat and detergents. It is therefore difficult to inhibit BAP completely at the end of dephosphorylation reactions.
- Proteinase K is used to digest CIP, which must be completely removed if subsequent ligations are to work efficiently. An alternative method is to inactivate the CIP by heating to 65°C for 1 hour (or 75°C for 10 minutes) in the presence of 5 mM EDTA (pH 8.0) and then to purify the dephosphorylated DNA by extraction with phenol:chloroform.
- SAP is extremely heat-labile and can be denatured completely and irreversibly by heating to 65°C for 15 minutes.

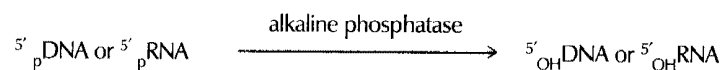
## ALKALINE PHOSPHATASES

---

**Activity:** Phosphatase

**Substrate:** Single- or double-stranded DNA and RNA; rNTPs and dNTPs.

**Reaction:**



## NUCLEASES

---

### Ribonuclease H

Ribonuclease H (RNase H) catalyzes the endonucleolytic degradation of the RNA moiety of DNA-RNA hybrids, generating oligoribonucleotides of varying chain lengths with 3'-hydroxyl and 5'-phosphate termini. RNase H was first recognized and isolated from calf thymus (Stein and Hausen 1969; Hausen and Stein 1970), but the enzyme is now known to be present in a wide variety of mammalian tissues, yeasts, prokaryotes, and virus particles. Many types of cells contain more than one RNase H.

In many retroviruses, RNase H is associated with the multifunctional enzyme reverse transcriptase and carries out important functions at several stages during the transcription of the viral genome into DNA. In eubacteria, RNase H is believed to be required for the removal of RNA primers from Okazaki fragments, for processing of transcripts into primers that are used by DNA polymerase I to initiate DNA synthesis, and to remove R-loops that provide sites for opportunistic initiation of unregulated DNA synthesis at the chromosomal origin of replication in *E. coli*. RNase H is presumed to carry out similar functions in eukaryotic cells.

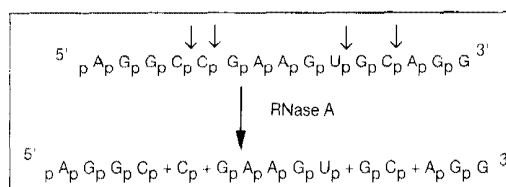
RNase H has been reported to increase markedly the inhibition of gene expression by anti-sense oligodeoxynucleotides. Hybrids between these oligonucleotides and specific sequences in mRNAs are sensitive to degradation by the enzyme. RNase H is required for initiation of replication at the origin (*ori*) of colicin E1 (*colE1*)-type plasmids *in vitro*. The enzyme also seems to suppress initiation of DNA synthesis at sites other than *ori*.

X-ray crystallographic analysis shows that *E. coli* RNase H consists of two domains, one of which contains an  $Mg^{2+}$ -binding site enmeshed in  $\beta$  strands, a fold previously recognized in DNase I. For further information and references, please see Crouch (1990), Wintersberger (1990), Hostomsky et al. (1993), Jung and Lee (1995), Kanaya and Ikehara (1995), Rice et al. (1996), Crooke (1998), and the information panel on **RIBONUCLEASE H** in Chapter 8.

## Ribonuclease A (Pancreatic)

(Bovine pancreas)

Ribonuclease A (RNase A) is an endoribonuclease that specifically attacks single-stranded RNA 3' to pyrimidine residues and cleaves the phosphate linkage to the adjacent nucleotide. The end products are pyrimidine 3' phosphates and oligonucleotides with terminal pyrimidine 3' phosphates (Davidson 1972). RNase A, which works in the absence of cofactors and divalent cations, can be inhibited by placental RNase inhibitor (Blackburn et al. 1977) or by vanadyl-ribonucleoside complexes (Puskas et al. 1982).



### USES

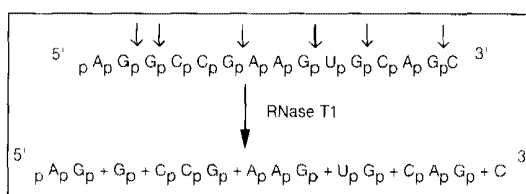
1. Removing unhybridized regions of RNA from DNA-RNA or RNA-RNA hybrids.
2. Mapping single-base mutations in DNA or RNA (Myers et al. 1985; Winter et al. 1985). In this method, single-base mismatches in RNA-DNA or RNA-RNA hybrids are recognized and cleaved by RNase A. A  $^{32}\text{P}$ -labeled RNA probe complementary to wild-type DNA or RNA is synthesized in vitro using a plasmid containing a bacteriophage SP6 or T7 promoter. The RNA probe is then annealed to test DNA or RNA containing a single-base substitution. The resulting single-base mismatch is cleaved by RNase A, and the location of the mismatch is then determined by analyzing the sizes of the cleavage products by gel electrophoresis; ~50% of all possible single-base mismatches can be detected by this method.

#### PREPARATION OF RNASE THAT IS FREE OF DNASE

Dissolve pancreatic RNase (RNase A) at a concentration of 10 mg/ml in 0.01 M sodium acetate (pH 5.2). Heat to 100°C for 15 minutes. Allow it to cool slowly to room temperature. Adjust the pH by adding 0.1 volume of 1 M Tris-Cl (pH 7.4). Dispense into aliquots and store at -20°C. RNase precipitates when concentrated solutions are heated to 100°C at neutral pH.

## Ribonuclease T1

Ribonuclease T1 (RNase T1) is an endoribonuclease that specifically attacks the 3'-phosphate groups of guanine nucleotides and cleaves the 5'-phosphate linkage to the adjacent nucleotide. The end products are guanosine 3' phosphates and oligonucleotides with terminal guanosine-3'-phosphate groups (Davidson 1972).



### USE

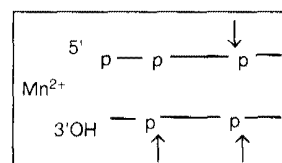
Removing unhybridized regions of RNA from DNA-RNA or RNA-RNA hybrids.

## Deoxyribonuclease I (Pancreatic)

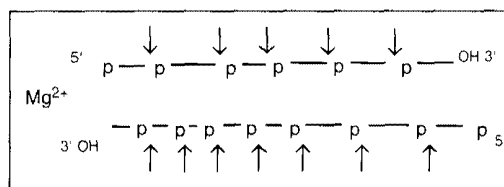
(Bovine pancreas)

The endonuclease DNase I from bovine pancreas is a glycoprotein that degrades double-stranded DNA by an in-line SN-2 mechanism involving nucleophilic attack on the scissile phosphodiester bond. The phosphate group remains attached to the new 5' terminus. DNase I requires divalent metal ions for DNA hydrolysis (Kunitz 1950) and displays maximal activity in the presence of  $\text{Ca}^{2+}$  and either  $\text{Mg}^{2+}$  or  $\text{Mn}^{2+}$  (Price 1972). These cations work synergistically; in the presence of both  $\text{Ca}^{2+}$  (0.1 mM) and  $\text{Mg}^{2+}$  (10 mM), the rate of hydrolysis is greater than the sum of the rates for either cation alone. However, high concentrations of  $\text{Mg}^{2+}$  (>50 mM), but not of  $\text{Ca}^{2+}$ , are inhibitory.

The mode of action and the specificity of the enzyme are affected by the type of divalent cations used. In the presence of  $\text{Mn}^{2+}$ , or when very high concentrations of the enzyme are used in the absence of monovalent cations, DNase I breaks both strands of superhelical double-stranded DNA simultaneously at approximately the same site (Melgar and Goldthwait 1968; Campbell and Jackson 1980).



In the presence of  $\text{Mg}^{2+}$ , DNase I works in a totally different fashion and introduces nicks into each strand of double-stranded DNA independently. As more and more nicks accumulate, the number of base pairs between adjacent nicks on opposite strands gradually decreases and is eventually insufficient to hold the molecule together. The terminal products of this reaction are a complex mixture of acid-soluble 5'-phosphorylated oligonucleotides.



Whether this nicking activity of DNase I displays sequence specificity remains a surprisingly murky topic, with conflicting data from several groups. On the one hand, biochemical analysis of the digestion products of bulk *E. coli* DNA shows only weak sequence specificity (Ehrlich et al. 1973; Bernardi et al. 1975). On the other hand, footprints generated by digestion of double-stranded DNA with DNase I often show evidence of preferential cleavage by the enzyme. In addition, Scheffler et al. (1968) showed that DNase I has a very marked preference for cleaving poly(d[A-T])·poly(d[A-T]) to the 5' side of T residues, a result that was confirmed with homopolymeric poly(d[A-T]) by Lomonosoff et al. (1981). However, this apparent specificity may be due more to a special alternating B conformation thought to be associated with the homopolymer, rather than to preference of the enzyme for particular sequences (Klug et al. 1979). Support for this idea comes from analysis of the crystal structure of complexes between DNase I and short double-stranded oligonucleotides (Suck et al. 1984; Suck and Oefner 1986). An exposed loop of the enzyme binds in the minor groove of B-DNA with both strands of the nucleic acid bending to make contact with the enzyme. Suck et al. (1988) have suggested that, in contrast to the results of Scheffler et al. (1968) and Lomonosoff et al. (1981), A-T tracts in double-stranded DNA might be relatively resistant to cleavage with DNase I.

In summary, whether DNase I nicks double-stranded DNA in a sequence-dependent fashion appears to be influenced by the structure of the template. The enzyme introduces nicks into complex DNAs with limited regard for sequence. However, on synthetic oligonucleotides of defined sequence, the enzyme shows a higher degree of preference, perhaps because the conformation of these substrates limits access of the enzyme to certain classes of phosphodiester bonds.

When very short double-stranded DNAs are used as substrates, DNase I also exhibits a topographical specificity that is manifested as “end-effects.” The probability that a particular phosphodiester bond will be cleaved increases as a function of its distance from the 5′ end of a DNA strand, at least as far as the eighth phosphodiester bond (Galas and Schmitz 1978; Lomonossoff et al. 1981). This preference exists because the enzyme efficiently cleaves only when it can interact with three or four nucleotides that are 5′ to the cleavage site. The predominant products of complete digestion of double-stranded DNA are therefore 5′-phosphorylated tetranucleotides (Bernardi et al. 1975). Two methods have been used in molecular cloning to limit the action of DNase I to a single endonucleolytic cleavage per molecule of template DNA:

- As discussed above, in the presence of a transition metal ion such as  $Mn^{2+}$ , DNase I cleaves both strands of superhelical DNA at approximately the same site (Melgar and Goldthwait 1968) to yield fragments that are blunt-ended or that have protruding termini only one or two nucleotides in length. The resulting linear molecules are relatively resistant to further cleavage by the nuclease. This reaction has been used to generate random deletions in a segment of target DNA cloned in a plasmid or bacteriophage M13 vector (Frischauf et al. 1980; Anderson 1981; Hong 1982). Because the sites of double-stranded cleavage are distributed in a statistically random fashion, the population of closed circular DNAs is converted into a permuted set of linear molecules. These are then digested with a restriction enzyme whose unique site of cleavage lies at one end of the target DNA. Recircularization of the resulting population generates clones that lack sequences lying between the site of DNase I cleavage and the restriction site.
- In the presence of subsaturating quantities of an intercalating dye such as ethidium bromide, DNase I randomly introduces a single nick into one strand of closed circular DNAs. The resulting relaxed circular molecules are then relatively resistant to further cleavage by the enzyme. DNase I can therefore be used to introduce a single nick into closed circular DNAs in preparation for resecting prior to bisulfite-mediated mutagenesis (Greenfield et al. 1975).

## USES

1. To remove DNA templates from *in vitro* transcription reactions and from preparations of mRNA. These RNAs are contaminated with large amounts of DNA that must be removed before analysis by northern hybridization, construction of cDNA libraries, reverse transcriptase (RT)-PCR, etc. Removal of contaminating DNA is particularly important when purifying RNAs from transfected cells or cells infected with DNA viruses. Unfortunately, many commercial preparations of pancreatic DNase I are contaminated with significant amounts of RNase. DNase I that is free of RNase can be obtained commercially but at great cost. If RNase-free DNase is used on a regular basis, please see the panel on **PREPARATION OF DNASE THAT IS FREE OF RNASE** on the following page.
2. To digest DNA that is left unprotected by interaction with proteins (DNA footprinting) (Galas and Schmitz 1978; Schmitz and Galas 1979). DNase I was the reagent originally used to develop DNA footprinting and despite the subsequent discovery of elegant chemical methods to cleave DNA in a sequence-independent fashion, DNA footprinting with DNase I remains by far the most popular way to localize specific interactions between proteins and DNA.
3. To introduce random single-stranded nicks into double-stranded DNA to generate templates for nick-translation reactions (Maniatis et al. 1975; Rigby et al. 1977). In this case, very small amounts of the enzyme are used to prevent wholesale destruction of the template DNA.



**PREPARATION OF DNASE THAT IS FREE OF RNASE**

mRNA prepared from uninfected mammalian cells contains only small amounts of DNA that generally do not compromise northern hybridization or other types of RNA analysis. However, mRNAs prepared from transfected mammalian cells or from cells infected with DNA viruses are contaminated with large amounts of DNA that must be removed by digestion with DNase I. Unfortunately, many commercial preparations of pancreatic DNase I, even those that claim to be RNase-free, are contaminated with significant amounts of RNase. In addition, the use of commercially prepared RNase-free DNase I can become expensive when many samples are prepared. DNase I can be treated by heating in the presence of iodoacetate to reduce RNase activity by ~98%. The resulting preparations of DNase are acceptable for all but the most stringent applications (e.g., this method should not be used to remove DNA from RNA to be used in construction of a cDNA library). DNase purified in this manner should always be used in the presence of a protein inhibitor of RNase (please see the information panel on **INHIBITORS OF RNASES** in Chapter 7).

1. Dissolve 10 mg of pancreatic DNase (Sigma) in 10 ml of 0.1 M iodoacetic acid, 0.15 M sodium acetate (pH 5.2).
2. Heat the solution to 55°C for 45 minutes. Cool the solution to 0°C, and add 1 M CaCl<sub>2</sub> to a final concentration of 5 mM.
3. Dispense the DNase I into small aliquots and store at -20°C.

## BAL 31 Nuclease

(*Alteromonas espejiana* BAL 31)

BAL 31 is predominantly a 3' exonuclease that removes mononucleotides from both 3' termini of the two strands of linear DNA. BAL 31 is also an endonuclease; thus, the single-stranded DNA generated by the 3' exonuclease activity is degraded by the endonuclease. The mechanisms of these reactions are complex and are summarized in the information panel on **BAL 31** in Chapter 13.

Degradation is absolutely dependent on the presence of calcium, and the reaction can therefore be stopped at different stages by the addition of the chelating agent EGTA. Because degradation occurs relatively uniformly from the termini of DNA, digestion with BAL 31 can be used to map restriction sites in small fragments of DNA (Legerski et al. 1978). DNA is digested with BAL 31, and samples are withdrawn at different times and placed in a solution containing EGTA. After digestion of these samples with the restriction enzyme of interest, restriction fragments can be seen to disappear in a defined order. By using a DNA consisting of vector sequences at one terminus (for which the restriction map is known) and unmapped sequences at the other, it is possible to distinguish fragments from the two termini and to deduce the order of the fragments in the unmapped DNA.

BAL 31 can also be used to remove unwanted sequences from the termini of DNAs before cloning. After treatment with the exonuclease/endonuclease, the termini of the DNA are repaired with bacteriophage T4 DNA polymerase or the Klenow fragment of *E. coli* DNA polymerase I. Synthetic linkers are added to the DNA, which is then inserted into a suitable vector. In this way, it is possible to generate a set of deletions from a defined endpoint in DNA. Although the enzyme is predominantly a 3' exonuclease, it also has a DNA endonuclease activity and cleaves internally in single-stranded regions of DNA or in double-stranded DNA that contains helical distortions (Lau and Gray 1979; Gray et al. 1981; Wei et al. 1983). BAL 31 will also digest RNA, albeit inefficiently.

### USES

1. Removing nucleotides from the termini of double-stranded DNA in a controlled manner. The shortened molecules can be used for a variety of purposes such as to produce deletions, to position a desired sequence next to a promoter or other controlling element, or to attach synthetic linkers at desired sites in the DNA.
2. Mapping restriction sites in DNA (Legerski et al. 1978).
3. Mapping secondary structure in DNA, for example, junctions between B-DNA and Z-DNA or sites of covalent or noncovalent modifications in double-stranded DNA (Gray et al. 1981; Wei et al. 1983).
4. Removing nucleotides from double-stranded RNA in preparing recombinant RNAs (Miele et al. 1983).

### NOTES

- When the products of BAL 31 digestion are to be ligated, it is important to consider that the 3' exonuclease activity of the enzyme works ~20-fold more efficiently than the DNA endonuclease. Thus, the average length of single-stranded tails created by digestion of linear double-stranded DNA is dependent on the enzyme concentration. At high enzyme concentrations (2–5 units/ml), an average of five nucleotides of single-stranded DNA remain per terminus and 10–20% of the molecules can be ligated to blunt-ended DNA without further treatment. At low enzyme concentrations (0.1–0.2 unit/ml), the single-stranded termini may be very long and the efficiency of blunt-end ligation is very low. Repair with bacteriophage T4 DNA poly-

merase (or, in some cases, the Klenow fragment) is almost obligatory before cloning DNAs treated with either high or low concentrations of BAL 31.

- Most commercial preparations of BAL 31 contain two kinetically distinct forms of the enzyme, a fast and a slow form. The slow form is a proteolytic degradation product of the fast form. Pure preparations of the fast form are available, but they are expensive (Wei et al. 1983). Results using mixed preparations will vary, depending on the relative amounts of the two forms in the initial preparation and the rate of conversion of the fast to the slow form during the assay.

Preparations rich in the fast form are preferred for such tasks as removal of long (>1000 bp) segments from the termini of double-stranded DNA; degradation of double-stranded RNA; and mapping of restriction sites, B-Z DNA junctions, and lesions in double-stranded DNA. The slow form of the enzyme is used to remove short segments (10–100 bp) from the termini of double-stranded DNA. Mixed preparations of the enzyme can be used for any of these tasks, although the results will vary as mentioned above.

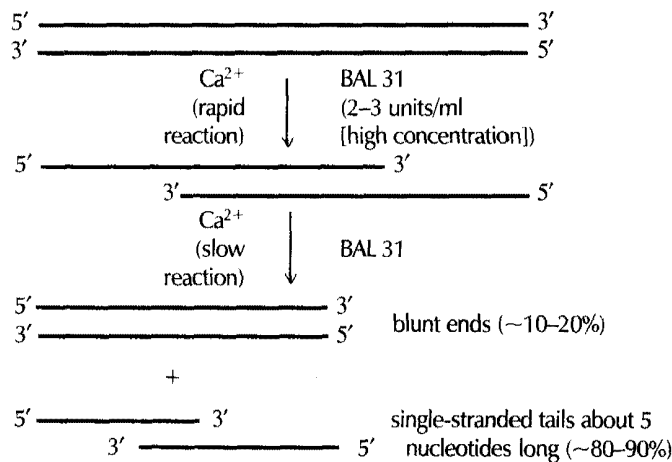
- BAL 31 works asynchronously, generating a population of DNA molecules whose termini have been resected to various extents and whose single-stranded tails vary in length. Following digestion with BAL 31 and repair with bacteriophage T4 DNA polymerase (or the Klenow fragment), it is often more efficient to isolate DNAs of the required size by gel electrophoresis rather than to screen very large numbers of randomly generated clones.
- BAL 31 degrades AT-rich sequences significantly more rapidly than it degrades GC-rich regions. Thus, molecules that terminate in AT-rich regions are underrepresented in populations of DNAs that have been digested with the enzyme.
- BAL 31 should not be frozen. Store the enzyme at 4°C.

### BAL 31 NUCLEASE

**Activity:** Exonuclease/endonuclease

**Substrate:** BAL 31 degrades double-stranded DNA sequentially from both termini. The mechanism is thought to involve a rapid exonucleolytic degradation followed by a slow endonucleolytic reaction on the complementary strand. Double-stranded DNA with blunt or protruding 3'-hydroxyl termini are degraded to shorter double-stranded molecules. The enzyme is also active at nicks, on single-stranded DNA with 3'-hydroxyl termini, and on double-stranded RNA molecules.

**Reaction:**

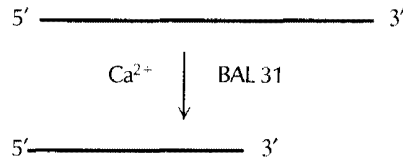


**BAL 31 NUCLEASE**

**Activity:** Exonuclease (shortens single-stranded DNA)

**Substrate:** Single-stranded DNA with 3'-hydroxyl termini.

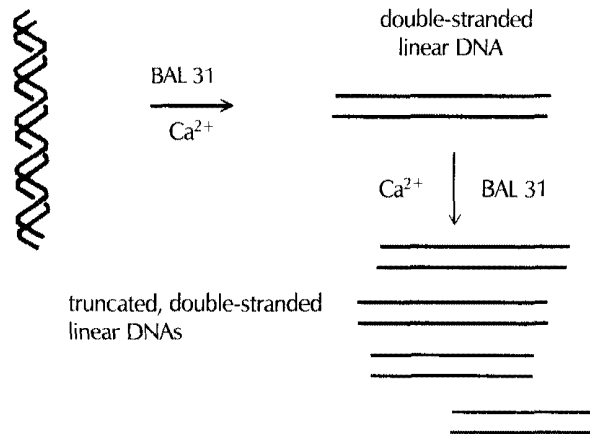
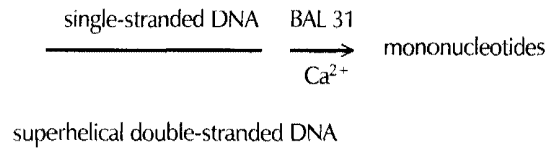
**Reaction:**



**Activity:** Endonuclease

**Substrate:** Single-stranded DNA; supercoiled DNA; DNA with B-DNA, Z-DNA junctions and other non-B-DNA conformations.

**Reaction:**



## Nuclease S1

(*Aspergillus oryzae*)

Nuclease S1 degrades single-stranded DNA or RNA (Vogt 1973) to yield 5'-phosphate mono- or oligonucleotides. Double-stranded DNA, double-stranded RNA, and DNA-RNA hybrids are relatively resistant to the enzyme. However, double-stranded nucleic acids are digested completely by nuclease S1 if they are exposed to very large amounts of the enzyme. Moderate amounts of the enzyme will cleave double-stranded nucleic acids at nicks or small gaps (Kroeker and Kowalski 1978). For further information, please see both the introduction to Protocol 10 and the information panel on **NUCLEASE S1** in Chapter 7.

### USES

1. Analyzing the structure of DNA-RNA hybrids (Berk and Sharp 1977; Favaloro et al. 1980).
2. Removing single-stranded tails from DNA fragments to produce blunt ends.
3. Opening the hairpin loop generated during synthesis of double-stranded cDNA.

### NOTE

- Since the enzyme works at low pH, depurination often occurs, which limits the usefulness of nuclease S1 for some applications.

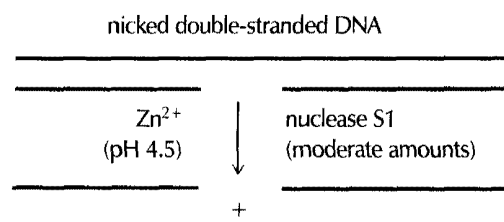
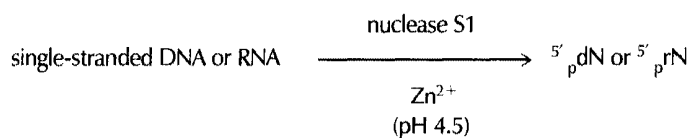
### NUCLEASE S1

---

**Activity:** Single-strand-specific nuclease

**Substrate:** Single-stranded DNA or RNA; more active on DNA than on RNA.

**Reaction:**



## Mung Bean Nuclease

(Mung bean sprouts)

Mung bean nuclease degrades single-stranded DNA to mono- or oligonucleotides with phosphate groups at their 5' termini (Laskowski 1980). Double-stranded DNA, double-stranded RNA, and DNA-RNA hybrids are relatively resistant to the enzyme. However, double-stranded nucleic acids are digested completely by mung bean nuclease if they are exposed to very large amounts of the enzyme (Kroeker and Kowalski 1978).

Although mung bean nuclease and nuclease S1 are similar to each other in their physical and catalytic properties, mung bean nuclease may be less severe in its action than nuclease S1. For example, nuclease S1 has been shown to cleave the DNA strand opposite a nick in a duplex, whereas mung bean nuclease will only attack the nick after it has been enlarged to a gap several nucleotides in length (Kroeker and Kowalski 1978). For further details, please see the information panel on **MUNG BEAN NUCLEASE** in Chapter 7.

### USES

1. Converting protruding termini of DNA to blunt ends.
2. Analyzing the structure of DNA-RNA hybrids.

## Exonuclease III

(*E. coli*)

Exonuclease III catalyzes the stepwise removal of 5' mononucleotides from the 3'-hydroxyl termini of double-stranded DNA (Weiss 1976). Linear double-stranded DNA and circular DNAs containing nicks or gaps are substrates. The activity of the enzyme results in the formation of long single-stranded regions in double-stranded DNA. The enzyme also carries three other activities: an endonuclease specific for apurinic DNA, an RNase H activity (Rogers and Weiss 1980), and a 3' phosphatase activity, which removes 3'-phosphate termini but does not cleave internal phosphodiester bonds. The exonuclease will not degrade single-stranded DNA or double-stranded DNA with a protruding 3' terminus (Rogers and Weiss 1980).

Exonuclease III is nonprocessive and typically generates populations of molecules that have been resected to similar extents. This property simplifies the task of isolating DNA molecules whose lengths have been reduced by the desired amount. For further details, please see the information panel on **EXONUCLEASE III** in Chapter 13.

### USES

1. Generating partially resected DNAs that can be used as substrates for the Klenow fragment (e.g., in the preparation of strand-specific probes) (for a similar application for bacteriophage T4 DNA polymerase, please see Figure A4-2 [p. A4.19]).
2. Generating nested sets of deletions of the terminal sequences of double-stranded linear DNAs. This reaction is usually carried out in conjunction with mung bean nuclease or nuclease S1 and is an alternative to using BAL 31. Because exonuclease III will degrade DNA with recessed 3' termini but not termini with protruding 3' single strands, it can be used to create unidirectional sets of deletions (Henikoff 1984). Thus, if the substrate molecule carries a protruding 3' terminus at one end (e.g., created by digestion with *Pst*I) and a recessed 3' terminus at the other, exonuclease III will digest only in one direction (from the recessed 3' terminus). After

removal of the resulting single-stranded segments (with nuclease S1 or mung bean nuclease) and repair with bacteriophage T4 DNA polymerase, the deleted molecules can be inserted into an appropriate vector by blunt-end ligation.

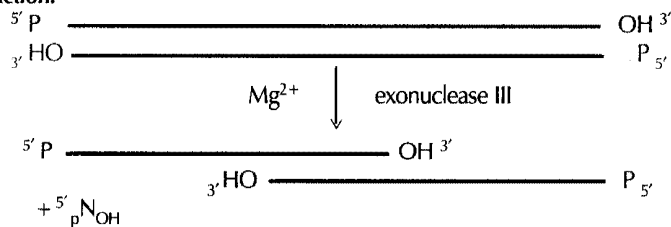
- Some methods of site-specific mutagenesis use thiophosphate derivatives of the dNTPs for second-strand synthesis primed by the mutagenic primer. The parental template strand can be preferentially degraded with exonuclease III, increasing the frequency of mutants obtained upon transformation of *E. coli*, since exonuclease III will not cleave thioester bonds (please see the information panel on **SELECTING AGAINST WILD-TYPE DNA IN SITE-DIRECTED MUTAGENESIS** in Chapter 13).

### EXONUCLEASE III

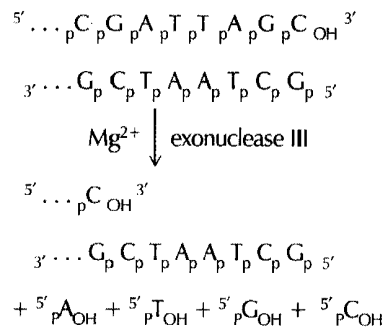
**Activity:** 3' Exonuclease

**Substrate:** This enzyme is active on 3'-hydroxyl termini of double-stranded DNA with blunt ends or with ends containing unpaired 5' termini and recessed 3' termini. 3'-hydroxyl termini at nicks in double-stranded DNA are also substrates. The DNA must contain phosphodiester bonds; thioesters are not cleaved.

**Reaction:**



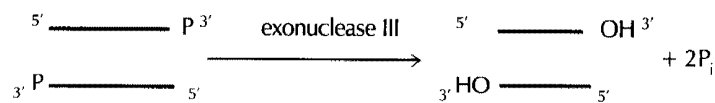
**For example:**



**Activity:** 3' Phosphatase

**Substrate:** Double- or single-stranded DNA with a 3'-phosphate terminus; internal phosphodiester bonds are not cleaved.

**Reaction:**



## Bacteriophage $\lambda$ Exonuclease

(Bacteriophage  $\lambda$ -infected *E. coli*)

Bacteriophage  $\lambda$  exonuclease catalyzes the processive, stepwise release of 5' mononucleotides from double-stranded DNA. Although the preferred substrate is double-stranded DNA with a terminal 5' phosphate (Little et al. 1967), the enzyme will also work, albeit 100-fold less efficiently on single-stranded DNA. Double-stranded DNAs with nicks or gaps will not serve as substrates.

### USE

Bacteriophage  $\lambda$  exonuclease was used for a wide variety of purposes in the early days of molecular cloning (for review, please see Little 1981). Today, it is used chiefly to modify the 5'-phosphate termini of DNAs that are to be used as substrates for other enzymes (e.g., terminal transferase).

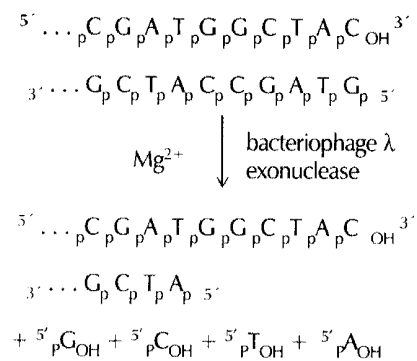
### BACTERIOPHAGE $\lambda$ EXONUCLEASE

---

**Activity:** 5' Exonuclease

**Substrate:** Double-stranded DNA with 5'-phosphate termini or with protruding 5' termini.

**Reaction:**





## PROTEOLYTIC ENZYMES

### Proteinase K

Proteinase K is a highly active serine protease of the subtilisin type (for reviews, please see Siezen et al. 1991; Siezen and Leunissen 1997) that is secreted by stationary cultures of the mold *Tritirachium album* var. Limber (Ebeling et al. 1974). The K in the enzyme's name indicates that the protease can supply the mold's total requirement for carbon and nitrogen by hydrolysis of keratin. Proteinase K catalyzes hydrolysis of a wide variety of peptide bonds but exhibits a preference for peptide bonds carboxy-terminal to aromatic and uncharged amino acids.

The mature enzyme consists of 279 amino acid residues ( $M_r = 28,930$ ) (Jany et al. 1986; Gunkel and Gassen 1989) and has two binding sites for  $Ca^{2+}$ , which lie some distance from the catalytic site. The  $Ca^{2+}$  ions are not directly involved in catalysis, but they contribute to structural stability of the enzyme (Betz et al. 1988; Müller et al. 1994). When  $Ca^{2+}$  is removed from the enzyme, some of the catalytic activity is lost because of long-range structural changes (Bajorath et al. 1988, 1989). Because the residual activity is sufficient to degrade most proteins, digestion with proteinase K is usually carried out in the presence of EDTA. In addition, proteinase K remains active in the presence of urea (1–4 M) and detergents that are routinely used to lyse mammalian cells (e.g., 0.5% SDS or 1% Triton X-100). Because proteinase K efficiently digests native proteins, it can rapidly inactivate DNases and RNases in cell lysates, which facilitates the isolation of high-molecular-weight DNA and intact RNA (Wiegers and Hilz 1971, 1972; Hilz et al. 1975).

Proteinase K is purchased as a lyophilized powder and should be dissolved at a concentration of 20 mg/ml in sterile 50 mM Tris-Cl (pH 8.0), 1.5 mM calcium acetate. The stock solution should be divided into small aliquots and stored at  $-20^\circ\text{C}$ . An aliquot can be thawed and refrozen several times, but it should then be discarded. Unlike much cruder preparations of protease (e.g., pronase), proteinase K need not be self-digested before use. The activity of proteinase K is severalfold higher at  $50^\circ\text{C}$  than at  $37^\circ\text{C}$ . Please see Table A4-8.

**TABLE A4-8 Proteolytic Enzymes**

	STOCK SOLUTION	STORAGE TEMPERATURE	CONCENTRATION IN REACTION	REACTION BUFFER	TEMPERATURE	PRETREATMENT
Pronase <sup>a</sup>	20 mg/ml in H <sub>2</sub> O	$-20^\circ\text{C}$	1 mg/ml	0.01 M Tris-Cl (pH 7.8) 0.01 M EDTA 0.5% SDS	$37^\circ\text{C}$	self-digestion <sup>b</sup>
Proteinase K	20 mg/ml in H <sub>2</sub> O	$-20^\circ\text{C}$	50 $\mu\text{g/ml}$	0.01 M Tris-Cl (pH 7.8) 0.005 M EDTA 0.5% SDS	$37\text{--}56^\circ\text{C}$	none required

<sup>a</sup>Pronase is a mixture of serine and acid proteases isolated from *Streptomyces griseus*.

<sup>b</sup>Self-digestion eliminates contamination with DNase and RNase. Self-digested pronase is prepared by dissolving powdered pronase in 10 mM Tris-Cl (pH 7.5), 10 mM NaCl to a final concentration of 20 mg/ml and incubating for 1 hour at  $37^\circ\text{C}$ . Store the self-digested pronase in small aliquots at  $-20^\circ\text{C}$  in tightly capped tubes.

## OTHER ENZYMES

---

### Lysozymes

Lysozymes are a family of enzymes that catalyze the acid-base hydrolysis of  $\beta$ -(1,4) linkages between *N*-acetylglucosamine and *N*-acetylmuramic acid residues in the proteoglycan of bacterial cell walls (Blake et al. 1967; Fursht 1985). They were discovered by Alexander Fleming (1922), who identified an enzyme activity that rapidly lysed suspensions of bacteria. The products of digestion by vertebrate lysozymes of the cell walls of bacteria were identified in the late 1950s, which allowed the structure and composition of the substrate to be deduced (for review, please see Jollés 1960).

Lysozymes are widely distributed in nature and are expressed wherever there is a need to lyse bacterial cells, for example, during release of bacteriophages from infected cells, on the surface of vertebrate mucosa, and in a great number of secretions of different animals, both vertebrate and invertebrate. There is no structural similarity between vertebrate and bacteriophage-encoded lysozymes such as bacteriophage  $\lambda$  endolysin and bacteriophage T4 endoacetylmuramidase.

In molecular cloning, vertebrate lysozymes (e.g., egg-white lysozyme) are used at pH 8.0 in combination with EDTA and detergents to liberate cosmid and plasmid DNAs from their bacterial hosts (Godson and Vapnek 1973). For further details, please see the information panel on **LYSOZYMES** in Chapter 1.

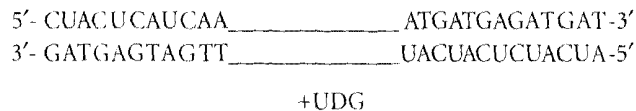
### Agarase

Agarase enzymatically digests molten agarose to produce soluble monomers and oligosaccharides. It is used in the isolation of DNA fragments from agarose gels. The enzyme is available from a number of manufacturers and is active in both Tris-acetate and Tris-borate buffers. Optimum activity is achieved at pH 6.0. Isolation of DNA using agarase is a very gentle method, which makes it suitable for the purification of large fragments. For a protocol on the purification of DNA from pulsed-field gels after agarase digestion, please see Chapter 5, Protocol 19.

### Uracil DNA Glycosylase

Uracil DNA glycosylase (UDG) cleaves the *N*-glycosidic bond between the uracil base and the phosphodiester backbone of DNA. UDG removes the uracil residues from the sugar moiety of single- and double-stranded DNAs without destroying the phosphodiester backbone, thus preventing its uses as a hybridization target or template for DNA polymerase. The resulting apyrimidinic DNA becomes susceptible to hydrolysis at high temperatures. UDG will not remove uracil from RNA, and it specifically attacks uracil-containing DNA.

Treatment of uracil-containing DNA with UDG disrupts base pairing in the DNA duplex. The use of dUTP in amplification reactions introduces uracil at the sites opposite to adenine. Subsequent treatment of the duplex with UDG results in single-stranded termini that may be used in cloning the amplified fragments of DNA.



## Topoisomerase I

Topoisomerase I (Topo I) is a crucial component of DNA replication. The enzyme works by introducing transient nicks into one strand of the backbone of both positively and negatively supercoiled DNAs, thus allowing the structure to untwist, and then resealing the breaks (for review, please see Wang 1996). During the course of the reaction catalyzed by topoisomerase I, a transient covalent intermediate is formed between a specific tyrosine residue of the enzyme and one end of the break in its DNA substrate. This bond between the enzyme and its substrate is broken by the activity of tyrosine-DNA phosphodiesterase, the gene for which has been cloned and shown to be highly conserved among higher eukaryotes (Pouliot et al. 1999).

In the absence of  $Mg^{2+}$ , topoisomerase I works to generate relaxed, covalently closed circles (for review, see Kornberg and Baker 1992). The enzyme is sometimes used in molecular cloning to enhance the electrophoretic separation of plasmid DNAs. Thus, fractionation by gel electrophoresis of closed circular DNAs that have been relaxed by treatment with topoisomerase I will resolve molecules that differ in length by a single nucleotide pair (Wang 1979; Luckow et al. 1987). Topoisomerase I is commercially available from Life Technologies, or it can be purified readily from calf thymus as described by Prell and Vosberg (1980).

# Appendix 5

## Inhibitors of Enzymes

**TABLE A5-1 Protease Inhibitors**

PROTEASE INHIBITORS	M.W.	INHIBITS	DOES NOT INHIBIT
Antipain dihydrochloride	677.6	Inhibits papain, trypsin, cathepsins A and B, and to a small extent plasmin.	
Antithrombin III	58,000	Inhibits all serine proteases of the blood coagulation system, as well as trypsin and chymotrypsin.	Does not inhibit cysteine proteases, aspartic proteases, or metalloproteases.
APMSF	252.7	Specific and irreversible inhibitor of serine proteases.	Does not inhibit chymotrypsin or acetylcholinesterase.
Aprotinin	~6500	Serine protease inhibitor; inhibits plasmin, chymotrypsin, kallikrein, and trypsin.	Does not inhibit thrombin or Factor X.
Bestatin	344.8	Inhibits metalloproteases, primarily aminopeptidases.	Does not inhibit carboxypeptidases.
Calpain inhibitor I	383.5	Strong competitive inhibitor of calpain I and to a lesser extent calpain II; also inhibits papain, cathepsins B and L, and to a small extent cathepsin H and $\alpha$ -chymotrypsin.	Does not inhibit trypsin.
Calpain inhibitor II	401.6	Strong competitive inhibitor of calpain I and to a lesser extent calpain II; also inhibits papain, cathepsins B and L, and to a small extent cathepsin H; weakly inhibits $\alpha$ -chymotrypsin.	Does not inhibit trypsin.
Chymostatin	607.7	Inhibits serine and cysteine proteases; specific inhibitor of $\alpha$ -, $\beta$ -, $\gamma$ -, $\delta$ -chymotrypsin, papain, and cathepsins A, B, and C.	
3,4-Dichloroisocoumarin	215.0	Inhibitor of serine proteases.	
Elastatinal	512.6	Irreversible inhibitor of elastase.	
Hirudin	6963.5	Inhibits thrombin.	
Iodoacetic acid	186.0	Inhibits cysteine proteases.	
Leupeptin	475.6	Inhibits serine and cysteine proteases	
$\alpha_2$ -Macroglobulin	~725,000	Universal protease inhibitor blocking all classes of endoproteinases.	Does not inhibit endoproteinases that are highly specific for one or a limited number of sequences, e.g., tissue kallikrein, urokinase, coagulation Factor XIIIa, and endoproteinase Lys-C.
Pefabloc SC, AEBSE, 4-(2-aminoethyl)-benzenesulfonyl fluoride hydrochloride	239.5	Inhibits serine proteases and prevents nonspecific covalent modification of proteins.	
Pepstatin A	685.9	Inhibits acid proteases, e.g., pepsin, renin, cathepsin D, chymosin, and many microbial acid proteases.	
PMSE (phenylmethylsulfonyl fluoride)	174.2	Inhibits serine proteases, e.g., chymotrypsin, thrombin, and papain.	
HMP-2		Inhibits matrix metalloproteinase activity in enzymatic assays and in vitro malignant invasion assays.	
ICCK; 1-chloro-3-tosylamido-7-amino-1,2-heptanone; N $\alpha$ -p-tosyl-L-lysine chloromethyl ketone hydrochloride	369.3	Irreversibly inhibits trypsin as well as many other serine and cysteine proteases, e.g., bromelain, ficin, or papain.	Does not inhibit chymotrypsin.
IPCK; 1-chloro-3-(4-tosylamido)-4-phenyl-2-butanone; N-tosyl-L-phenylalanine chloromethyl ketone	351.9	Irreversibly inhibits chymotrypsin, as well as many other serine and cysteine proteases, e.g., bromelain, ficin, or papain.	Does not inhibit trypsin.



# Appendix 6

---

## Nucleic Acids

<b>VITAL STATISTICS OF DNA</b>	A6.2
Table A6-1 Genome Comparisons	A6.2
Table A6-2 Frequency of Restriction Endonuclease Sites in the Human Genome	A6.3
Table A6-3 Restriction Endonuclease Cleavage at the End of a DNA Fragment	A6.4
Table A6-4 Concentration of Double-stranded DNA in Solution	A6.5
Figure A6-1 Numbering of Atoms on Purine and Pyrimidine Molecules	A6.5
Table A6-5 Adenine and Related Compounds	A6.6
Table A6-6 Cytosine and Related Compounds	A6.7
Table A6-7 Guanine and Related Compounds	A6.8
Table A6-8 Thymine and Related Compounds	A6.9
Table A6-9 Uracil and Related Compounds	A6.9
Table A6-10 Unusual Bases	A6.10
Table A6-11 Nucleoside Analogs Used as Chain Terminators in DNA Sequencing	A6.10
<b>OLIGONUCLEOTIDES</b>	A6.11
Table A6-12 Commonly Used Oligonucleotide Primers	A6.11
Table A6-13 Molecular Conversions for Oligonucleotides	A6.11
<b>NOMOGRAMS</b>	A6.12
Figure A6-2 Nomogram for Single-stranded DNA	A6.12
Figure A6-3 Nomogram for Double-stranded DNA	A6.13
<b>SIZE MARKERS</b>	A6.14
Figure A6-4 DNA Size Markers	A6.14

## VITAL STATISTICS OF DNA

TABLE A6-1 Genome Comparisons

ORGANISM	SIZE OF DNA (bp)	WEIGHT OF DNA (DALTONS)	REFERENCE
Mammals	$\sim 3.0 \times 10^9$	$\sim 1.9 \times 10^{12}$	
<i>Drosophila melanogaster</i>	$\sim 1.8 \times 10^8$	$\sim 7.8 \times 10^{10}$	Adams et al. (2000)
<i>Caenorhabditis elegans</i>	$\sim 9.70 \times 10^7$	$6.59 \times 10^6$	<i>C. elegans</i> Sequencing Consortium (1998)
<i>Saccharomyces cerevisiae</i>	$1.30 \times 10^7$	$8.44 \times 10^9$	Goffeau et al. (1996)
<i>Haemophilus influenzae</i> Rd	$1.83 \times 10^6$	$1.19 \times 10^9$	Fleischmann et al. (1995)
<i>Mycoplasma genitalium</i>	$0.58 \times 10^6$	$3.76 \times 10^8$	Fraser et al. (1995)
<i>Methanococcus jannaschii</i>	$1.66 \times 10^6$	$1.08 \times 10^9$	Bult et al. (1996)
<i>Synechocystis</i> sp.	$3.57 \times 10^6$	$2.32 \times 10^9$	Kaneko et al. (1996)
<i>Mycoplasma pneumoniae</i>	$8.10 \times 10^5$	$0.53 \times 10^8$	Himmelreich et al. (1996)
<i>Helicobacter pylori</i>	$1.66 \times 10^6$	$1.08 \times 10^9$	Tomb et al. (1997)
<i>Escherichia coli</i>	$4.60 \times 10^6$	$3.00 \times 10^9$	Blattner et al. (1997)
<i>Methanobacterium thermoautotrophicum</i>	$1.75 \times 10^6$	$1.14 \times 10^9$	Smith et al. (1997)
<i>Bacillus subtilis</i>	$4.20 \times 10^6$	$2.73 \times 10^9$	Kunst et al. (1997)
<i>Archaeoglobus fulgidus</i>	$2.18 \times 10^6$	$1.40 \times 10^9$	Klenk et al. (1997)
<i>Borrelia burgdorferi</i>	$1.44 \times 10^6$	$9.35 \times 10^8$	Fraser et al. (1997)
<i>Aquifex aeolicus</i>	$\sim 1.50 \times 10^6$	$9.74 \times 10^9$	Deckert et al. (1998)
<i>Pyrococcus horikoshii</i>	$1.80 \times 10^6$	$1.17 \times 10^9$	Kawarabayasi et al. (1998)
<i>Mycobacterium tuberculosis</i>	$4.40 \times 10^6$	$2.90 \times 10^9$	Cole et al. (1998)
<i>Treponema pallidum</i>	$1.14 \times 10^6$	$7.40 \times 10^8$	Fraser et al. (1998)
<i>Chlamydia trachomatis</i>	$1.05 \times 10^6$	$6.80 \times 10^8$	Stephens et al. (1998)
<i>Rickettsia prowazekii</i>	$1.10 \times 10^6$	$7.10 \times 10^8$	Andersson et al. (1998)
<i>Helicobacter pylori</i>	$1.64 \times 10^6$	$1.06 \times 10^9$	Alm et al. (1999)
<i>Chlamydia pneumoniae</i>	$1.23 \times 10^6$	$7.98 \times 10^8$	Kalman et al. (1999)
<i>Deinococcus radiodurans</i>	$3.28 \times 10^6$	$2.13 \times 10^9$	White et al. (1999)
<i>Thermotoga maritima</i>	$1.80 \times 10^6$	$1.17 \times 10^9$	Nelson et al. (1999)
Bacteriophage T2	$\sim 2.0 \times 10^5$	$\sim 1.3 \times 10^8$	
Bacteriophage $\lambda$	48,514	$3.1 \times 10^7$	Daniels et al. (1983)
pBR322	4,363	$2.8 \times 10^6$	Sutcliffe (1978, 1979)
pUC18/pUC19	2,686	$1.7 \times 10^6$	Yanisch-Perron et al. (1985)

Source: www.tigr.org For updates, see TIGR Web Site (www.tigr.org)

TABLE A6-2 Frequency of Restriction Endonuclease Sites in the Human Genome

ENZYME	SEQUENCE	AVERAGE FRAGMENT SIZE (kb)	ESTIMATED NUMBER OF SITES
<i>ApaI</i>	GGGCC	2	$1.5 \times 10^6$
<i>AscI</i>	GGCGCGCC	80	$3.75 \times 10^4$
<i>AvrII</i>	CCTAGG	8	$3.75 \times 10^5$
<i>BamHI</i>	GGATCC	5	$6 \times 10^5$
<i>BglI</i>	GCCN <sub>2</sub> GGC	3	$1 \times 10^6$
<i>BglII</i>	AGATCT	3	$1 \times 10^6$
<i>BssHII</i>	GCGCGC	10	$3 \times 10^5$
<i>DraI</i>	TTAAA	2	$1.5 \times 10^6$
<i>EagI</i>	CGGCCG	10	$3 \times 10^5$
<i>EcoRI</i>	GAATTC	5	$6 \times 10^5$
<i>HindIII</i>	AAGCTT	4	$7.5 \times 10^5$
<i>NaeI</i>	GCCGGC	4	$7.5 \times 10^5$
<i>NarI</i>	GGCGCC	4	$7.5 \times 10^5$
<i>NheI</i>	GCTAGC	10	$3 \times 10^5$
<i>NotI</i>	GCGGCCGC	100	$3 \times 10^4$
<i>PacI</i>	TTAATTAA	60	$5 \times 10^4$
<i>PmeI</i>	GTTTAAAC	70	$4.3 \times 10^4$
<i>RsrI</i>	CGGWCCG	60	$5 \times 10^4$
<i>SacI</i>	GAGCTC	3	$1 \times 10^6$
<i>SacII</i>	CCGCGG	6	$5 \times 10^5$
<i>SalI</i>	GTCGAC	20	$1.5 \times 10^5$
<i>SbfI</i>	CCTGCAGG	15	$5.33 \times 10^5$
<i>SfiI</i>	GGCCN <sub>3</sub> GGCC	30	$1 \times 10^5$
<i>SgrAI</i>	CRCCGGYC	70	$4.3 \times 10^4$
<i>SmaI</i>	CCCGGG	4	$7.5 \times 10^5$
<i>SpeI</i>	ACTAGT	10	$3 \times 10^5$
<i>SphI</i>	GCATGC	6	$5 \times 10^5$
<i>SrfI</i>	GCCCGGGC	50	$6 \times 10^4$
<i>SspI</i>	AATATT	2	$1.5 \times 10^6$
<i>SwaI</i>	ATTTAAAT	30	$1 \times 10^5$
<i>XbaI</i>	TCTAGA	5	$6 \times 10^5$
<i>XhoI</i>	CTCGAG	7	$4.3 \times 10^5$

(Adapted, with permission, from 1998/99 New England Biolabs Catalog [©NEB].)



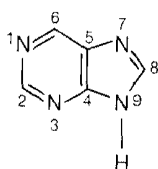
TABLE A6-3 Restriction Endonuclease Cleavage at the End of a DNA Fragment

ENZYME	BASE PAIRS FROM END	% CLEAVAGE EFFICIENCY	ENZYME	BASE PAIRS FROM END	% CLEAVAGE EFFICIENCY	
<i>AatII</i>	3	88	<i>KpnI</i>	2	100	
	2	100		2	100	
	1	95		1	99	
<i>Acc65</i>	2	99	<i>MluI</i>	2	99	
	1	75				
<i>AflII</i>	1	13	<i>MunI</i>	2	100	
<i>AgeI</i>	1	100	<i>NcoI</i>	2	100	
	1	100				
<i>ApaI</i>	2	100	<i>NgoM IV</i>	2	100	
<i>AscI</i>	1	97	<i>NheI</i>	1	100	
				2	82	
<i>AvrII</i>	1	100	<i>NotI</i>	7	100	
				4	100	
				1	98	
<i>BamHI</i>	1	97	<i>NsiI</i>	3	100	
				3	77	
				2	95	
<i>BglII</i>	3	100	<i>PacI</i>	1	76	
<i>BsWI</i>	2	100	<i>PmeI</i>	1	94	
<i>BspEI</i>	2	100	<i>PstI</i>	3	98	
	1	8		2	50	
<i>BsrGI</i>	2	99		1	37	
	1	88	<i>SacI</i>	1	99	
<i>BssHII</i>	2	100	<i>SalI</i>	3	89	
				2	23	
				1	61	
<i>EagI</i>	2	100	<i>SpeI</i>	2	100	
<i>EcoRI</i>	1	100	<i>SphI</i>	2	99	
	1	88		2	97	
	1	100		1	92	
<i>EcoRV</i>	1	100	<i>XbaI</i>	1	99	
				1	94	
<i>HindIII</i>	3	90	<i>XhoI</i>	1	97	
	2	91				
	1	0				
<i>KasI</i>	2	97	<i>XmaI</i>	2	98	
	1	93		2	92	

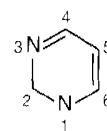
The results represent the ability of various restriction endonucleases to cleave close to the end of a DNA fragment. The cleavage efficiency is given for a particular recognition site placed at x bases from the end of a linearized vector. As a general rule, enzymes not listed above require 6 base pairs on either side of their recognition site to cleave efficiently. (Reproduced, with permission, 1998/99 New England Biolabs Catalog [©NEB].)

TABLE A6-4 Concentration of Double-stranded DNA in Solution

DOUBLE-STRANDED DNA (50 $\mu\text{g/ml}$ )	BP/MOLECULE	MOLECULAR MASS OF DNA (DALTONS)	50 $\mu\text{g/ml}$ SOLUTION				
			MOLECULES DNA/ml	MOLES/ml	MOLAR CONCENTRATION OF		
					DNA	PHOSPHATE	TERMINI
Bacteriophage $\lambda$	48,514	$3.20 \times 10^7$	$9.41 \times 10^{11}$	$1.56 \times 10^{-12}$	1.56 nM	157 $\mu\text{M}$	3.12 nM
pAd10SacBI	30,300	$2.00 \times 10^7$	$1.51 \times 10^{12}$	$2.50 \times 10^{-12}$	2.50 nM	157 $\mu\text{M}$	5.00 nM
pCYPAC1	19,600	$1.29 \times 10^7$	$2.33 \times 10^{12}$	$3.88 \times 10^{-12}$	3.88 nM	157 $\mu\text{M}$	7.76 nM
pYAC4	11,400	$7.52 \times 10^6$	$4.00 \times 10^{12}$	$6.65 \times 10^{-12}$	6.65 nM	157 $\mu\text{M}$	13.1 nM
pBeloBACII	7,400	$4.88 \times 10^6$	$6.17 \times 10^{12}$	$1.03 \times 10^{-11}$	10.3 nM	157 $\mu\text{M}$	20.6 nM
pBR322	4,363	$2.88 \times 10^6$	$1.05 \times 10^{13}$	$1.74 \times 10^{-11}$	17.4 nM	157 $\mu\text{M}$	34.8 nM
pUC18/pUC19	2,686	$1.77 \times 10^6$	$1.70 \times 10^{13}$	$2.83 \times 10^{-11}$	28.3 nM	157 $\mu\text{M}$	56.6 nM
Segment of DNA (1 kb)	1,000	$6.60 \times 10^5$	$4.56 \times 10^{13}$	$7.58 \times 10^{-11}$	75.8 nM	157 $\mu\text{M}$	152 nM
Octameric double-stranded linker	8	$5.28 \times 10^3$	$5.70 \times 10^{15}$	$9.47 \times 10^{-9}$	9.47 $\mu\text{M}$	157 $\mu\text{M}$	18.9 nM



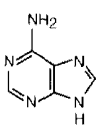
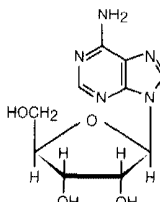
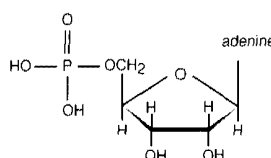
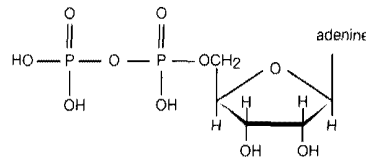
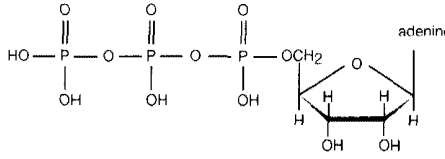
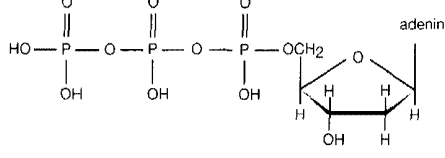
the purine ring system



the pyrimidine ring system

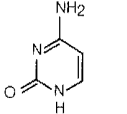
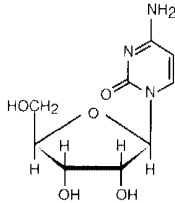
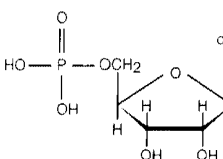
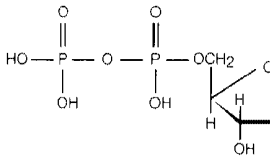
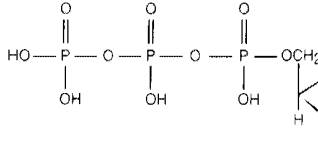
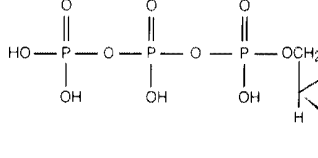
FIGURE A6-1 Numbering of Atoms on Purine and Pyrimidine Molecules

TABLE A6-5 Adenine and Related Compounds

	STRUCTURE <sup>a</sup>	M.W.	$\lambda_{\max}$ (nm)	$E_{\max}$ ( $\times 10^{-3}$ )	$OD_{280}/$ $OD_{260}$
Adenine		135.1	260.5	13.4	0.13
Adenosine		267.2	260	14.9	0.14
Adenosine 5'-phosphate (5'-AMP)		347.2	259	15.4	0.16
Adenosine 5'-diphosphate (5'-ADP)		427.2	259	15.4	0.16
Adenosine 5'-triphosphate (5'-ATP)		507.2	259	15.4	0.15
2'-Deoxyadenosine 5'-triphosphate (5'-dATP)		491.2	259	15.4	0.15

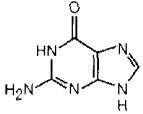
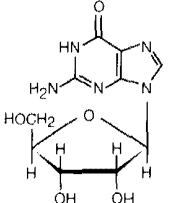
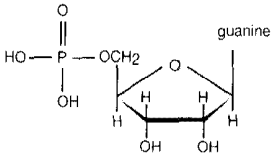
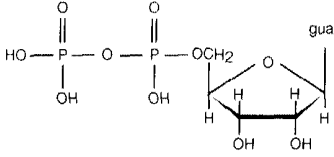
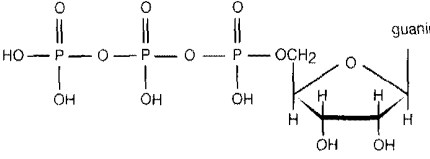
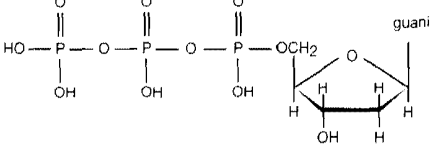
<sup>a</sup>At physiological pH, all of the hydroxyls bound to phosphate are ionized.

TABLE A6-6 Cytosine and Related Compounds

	STRUCTURE <sup>a</sup>	M.W.	$\lambda_{\max}$ (nm)	$E_{\max}$ ( $\times 10^{-3}$ )	$OD_{280}$ $OD_{260}$
Cytosine		111.1	267	6.1	0.58
Cytidine		243.2	271	8.3	0.93
Cytidine 5'-phosphate (5'-CMP)		323.2	271	9.1	0.98
Cytidine 5'-diphosphate (5'-CDP)		403.2	271	9.1	0.98
Cytidine 5'-triphosphate (5'-CTP)		483.2	271	9.0	0.97
2-Deoxycytidine 5'-triphosphate (5'-dCTP)		467.2	272	9.1	0.98

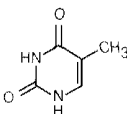
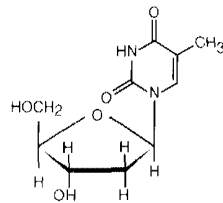
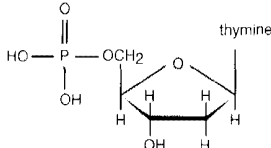
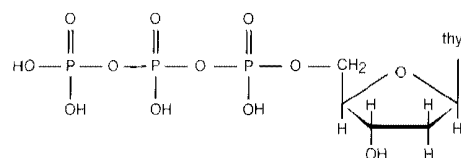
<sup>a</sup>At physiological pH, all of the hydroxyls bound to phosphate are ionized.

TABLE A6-7 Guanine and Related Compounds

	STRUCTURE <sup>a</sup>	M.W.	$\lambda_{\max}$ (nm)	$E_{\max}$ ( $\times 10^{-3}$ )	$OD_{280}/$ $OD_{260}$
Guanine		151.1	276	8.15	1.04
Guanosine		283.2	253	13.6	0.67
Guanosine 5'-phosphate (5'-GMP)		363.2	252	13.7	0.66
Guanosine 5'-diphosphate (5'-GDP)		443.2	253	13.7	0.66
Guanosine 5'-triphosphate (5'-GTP)		523.2	253	13.7	0.66
2'-Deoxyguanosine 5'-triphosphate (5'-dGTP)		507.2	253	13.7	0.66

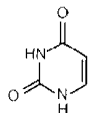
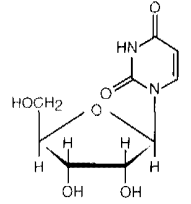
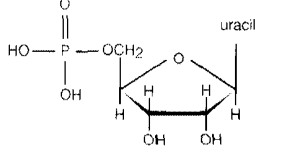
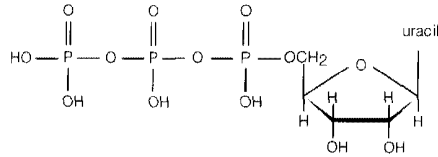
<sup>a</sup>At physiological pH, all of the hydroxyls bound to phosphate are ionized.

TABLE A6-8 Thymine and Related Compounds

	STRUCTURE <sup>a</sup>	M.W.	$\lambda_{\max}$ (nm)	$E_{\max}$ ( $\times 10^{-3}$ )	$OD_{280}$ / $OD_{260}$
Thymine		126.1	264.5	7.9	0.53
2'-deoxythymidine		242.2	267	9.7	0.70
2'-deoxythymidine 5'-phosphate (5'-TMP)		322.2	267	9.6	0.73
2'-deoxythymidine 5'-triphosphate (5'-TTP)		482.2	267	9.6	0.71

<sup>a</sup>At physiological pH, all of the hydroxyls bound to phosphate are ionized.

TABLE A6-9 Uracil and Related Compounds

	STRUCTURE <sup>a</sup>	M.W.	$\lambda_{\max}$ (nm)	$E_{\max}$ ( $\times 10^{-3}$ )	$OD_{280}$ / $OD_{260}$
Uracil		112.1	259	8.2	0.17
Uridine		244.2	262	10.1	0.35
Uridine 5'-phosphate (5'-UMP)		324.2	260	10.0	0.38
Uridine 5'-triphosphate (5'-UTP)		484.2	260	10.0	0.38

<sup>a</sup>At physiological pH, all of the hydroxyls bound to phosphate are ionized.

TABLE A6-10 Unusual Bases

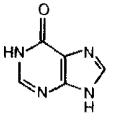
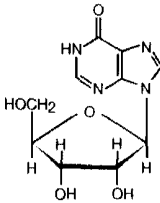
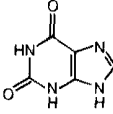
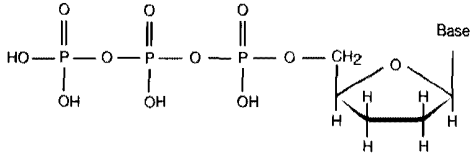
	STRUCTURE	M.W.	$\lambda_{\max}$ (nm)	$E_{\max}$ ( $\times 10^{-3}$ )	$OD_{280}/$ $OD_{260}$
Hypoxanthine		136.1	249.5	10.7	0.09
Inosine		268.2	248.5	12.3	0.25
Xanthine		152.1	267	10.3	0.61

TABLE A6-11 Nucleoside Analogs Used as Chain Terminators in DNA Sequencing

STRUCTURE <sup>a</sup>		M.W.
<b>2',3'-DIDEOXYRIBONUCLEOSIDE 5' TRIPHOSPHATES</b>		
	2',3'-Dideoxyadenosine (ddATP)	Base = adenine 475.2
	2',3'-Dideoxycytidine (ddCTP)	Base = cytosine 451.2
	2',3'-Dideoxyguanosine (ddGTP)	Base = guanine 491.2
	2',3'-Dideoxythymidine (ddTTP)	Base = thymine 466.2
		$Na_4 \cdot H_2O$ , 608.2

<sup>a</sup>At physiological pH, all of the hydroxyls bound to phosphate are ionized.

## OLIGONUCLEOTIDES

TABLE A6-12 Commonly Used Oligonucleotide Primers

PRIMER	SEQUENCE
$\lambda$ gt10 forward primer	5'-AGCAAGTTCAGCCTGGTTAAG-3'
$\lambda$ gt10 reverse primer	5'-CTTATGAGTATTTCTTCCAGGGTA-3'
$\lambda$ gt11 forward primer	5'-GGTGGCGACGACTCCTGGAGCCCG-3'
$\lambda$ gt11 reverse primer	5'-TTGACACCAGACCAACTGGTAATG-3'
pUC/M13-40 forward primer	5'-GTTTTCCAGTCACGACG-3'
pUC/M13-48 reverse primer	5'-AGCGGATAACAATTCACACAGG-3'
pUC/M13-20 forward primer	5'-GTAAAACGACGGCCAGT-3'
pUC/M13-20 reverse primer	5'-GGAAACAGCTATGACCAATG-3'
SP6 universal primer	5'-ATTTAGGTGACACTATAG-3'
T7 universal primer	5'-TAATACGACTCACTATAGGG-3'
T3 promoter primer	5'-ATTAACCCCTCACTAAAGGGA-3'

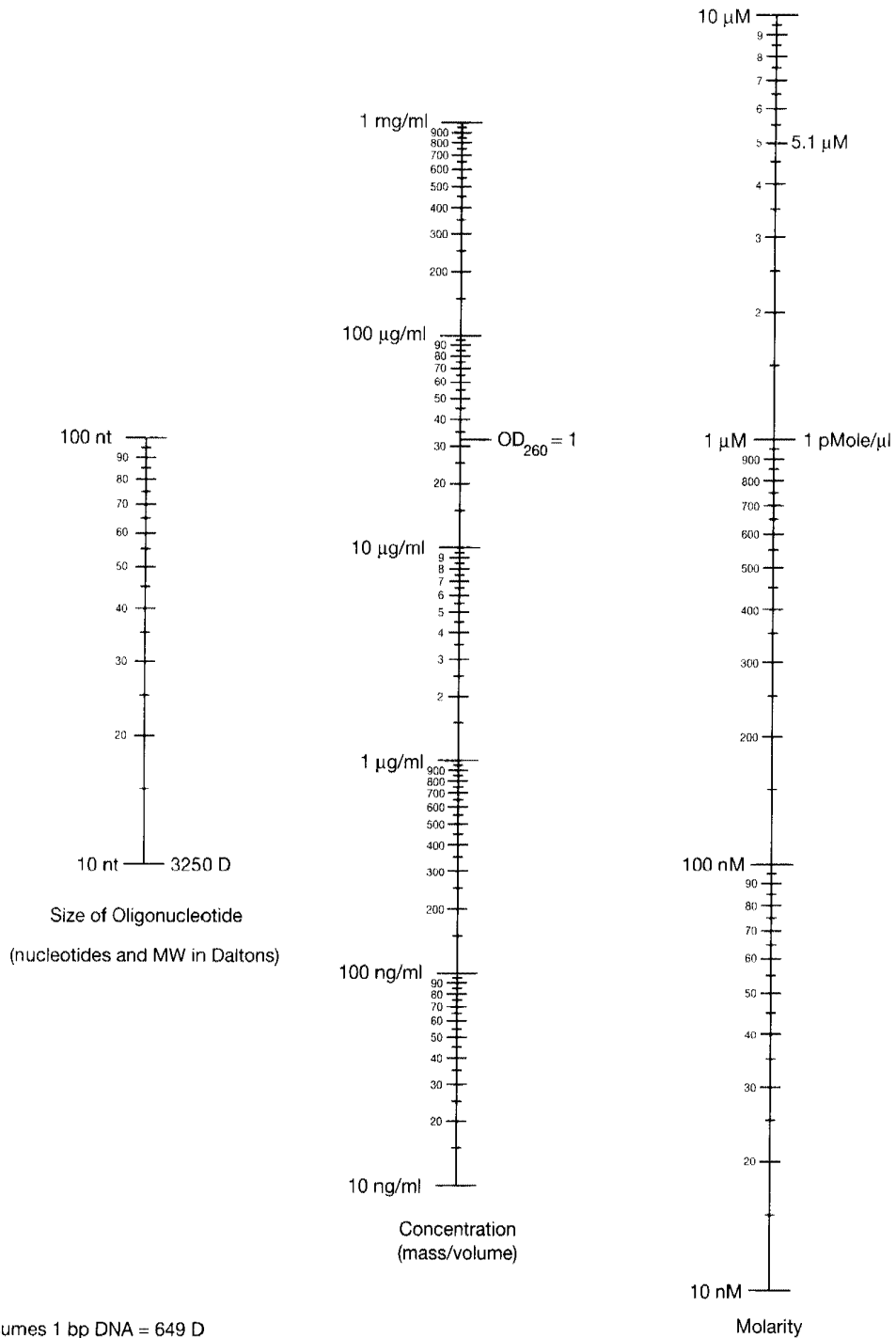
For advice on custom primer design, please see the introduction to Chapter 10.

TABLE A6-13 Molecular Conversions for Oligonucleotides

SIZE OF OLIGONUCLEOTIDE (NUCLEOTIDES)	MOLECULAR MASS (DALTONS)	MOLECULES OF DNA IN 1 $\mu$ g	MOLES OF DNA IN 1 $\mu$ g
8	$2.64 \times 10^3$	$2.28 \times 10^{14}$	379 pmoles
10	$3.30 \times 10^3$	$1.82 \times 10^{14}$	303 pmoles
12	$3.96 \times 10^3$	$1.52 \times 10^{14}$	253 pmoles
14	$4.62 \times 10^3$	$1.30 \times 10^{14}$	216 pmoles
16	$5.28 \times 10^3$	$1.14 \times 10^{14}$	190 pmoles
18	$5.94 \times 10^3$	$1.01 \times 10^{14}$	168 pmoles
20	$6.60 \times 10^3$	$9.12 \times 10^{13}$	152 pmoles



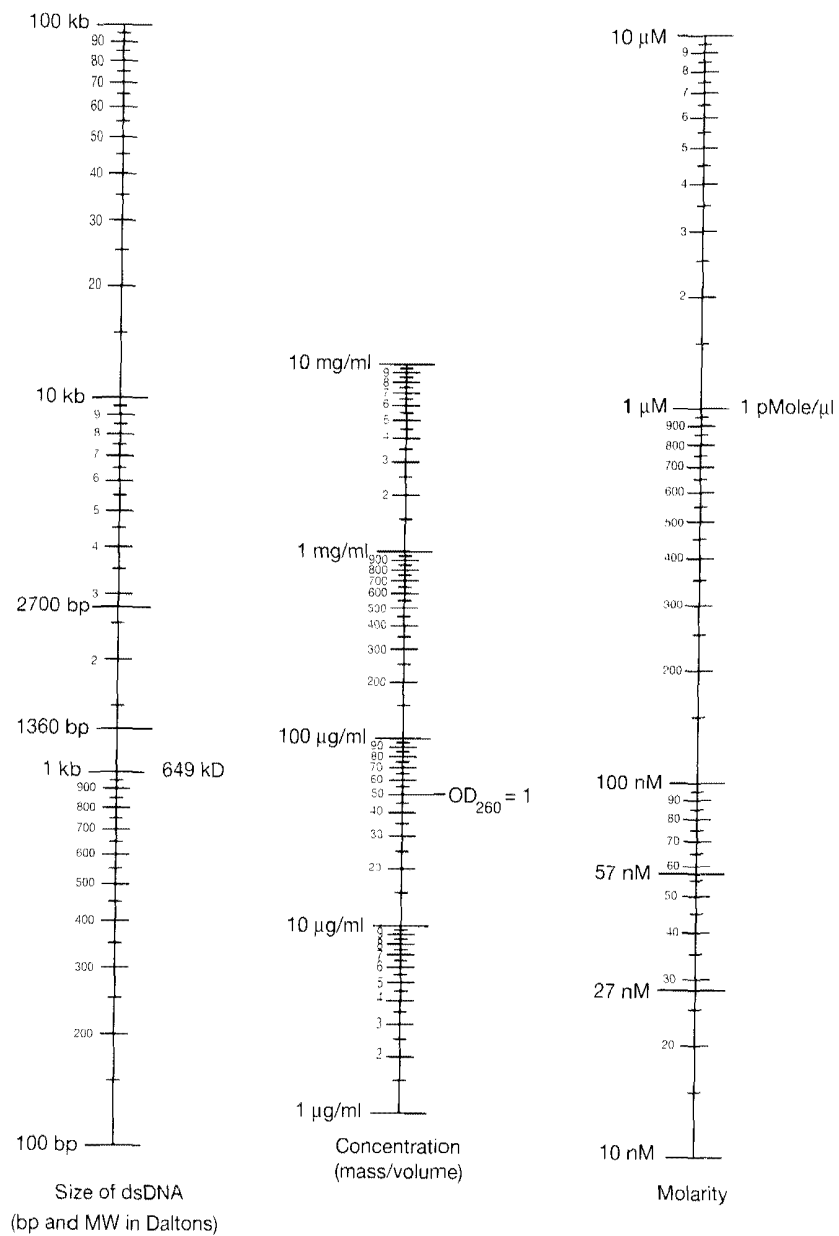
NOMOGRAMS



Assumes 1 bp DNA = 649 D

**FIGURE A6-2 Nomogram for Single-stranded DNA**

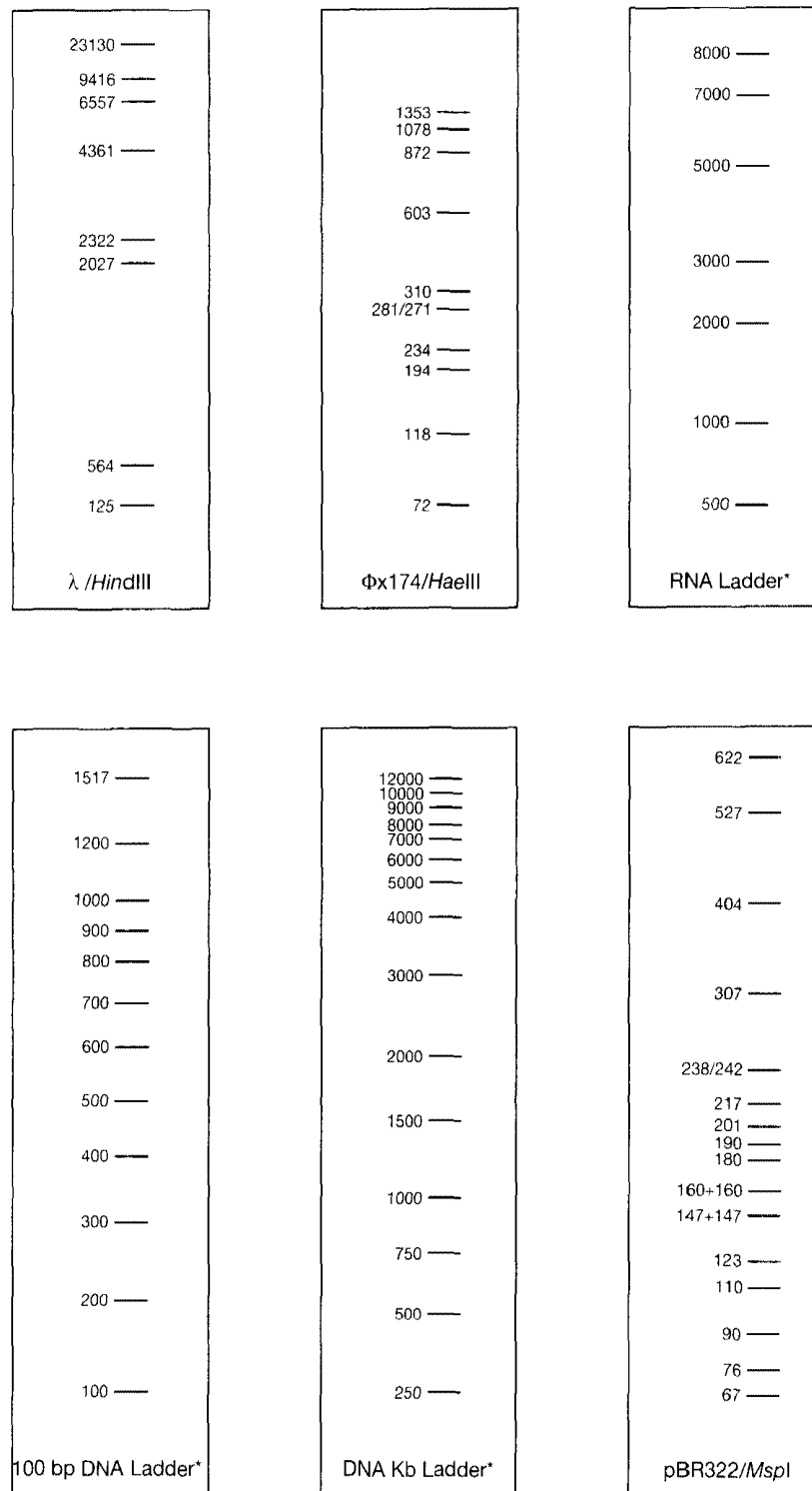
This nomogram can be used for the conversion of concentration between different conventions and to obtain approximate values of DNA concentration from  $OD_{260}$  readings. For example, a solution of an oligonucleotide 20 nucleotides in length that produces an  $OD_{260} = 1$  has a concentration of 33 µg/ml. To calculate the molarity of the solution, draw a line from the size of the molecule (in nucleotides or molecular weight) on the left-hand scale, through the point of known concentration (33 µg/ml) on the middle scale. Extrapolate the line through the third scale and read off the molarity (5.1 µM is equivalent to 5.1 pmoles/µl). (Figure kindly provided by Siân Curtis.)



**FIGURE A6-3 Nomogram for Double-stranded DNA**

This nomogram can be used for the conversion of concentration between different conventions, and also to obtain approximate values of DNA concentration from  $OD_{260}$  readings. A solution containing  $50 \mu\text{g/ml}$  of *double-stranded* DNA has an absorbance of 1 at 260 nm, i.e.,  $A_{260} = 1 = 50 \mu\text{g/ml}$  of double-stranded DNA. For example, a solution of pUC 18/19 (2686 bp) that produces an  $OD_{260} = 1$  has a concentration of  $50 \mu\text{g/ml}$ . To calculate the molarity of the solution, draw a line from the size of the molecule (base pairs or molecular weight) on the left-hand scale through the point of known concentration ( $50 \mu\text{g/ml}$ ) on the middle scale. Extrapolate the line through the third scale and read off the molarity ( $57 \text{ nM}$  is equivalent to  $57 \text{ fmoles}/\mu\text{l}$ ). (Figure kindly provided by Siân Curtis.)

SIZE MARKERS



**FIGURE A6-4 DNA Size Markers**

(100-bp DNA ladder, RNA ladder, and pBR322/MspI are reproduced, with permission, from 1998/99 New England Biolabs Catalog [©NEN]). (DNA Size Markers are reproduced with the express permission of Stratagene. Copyright 1999, Stratagene. All rights reserved.)

# Appendix 7

---

## Codons and Amino Acids

CODONS AND CODON USAGE	A7.2
AMBER MUTANTS AND AMBER SUPPRESSORS	A7.5
AMINO ACIDS	A7.6

## CODONS AND CODON USAGE

---

The genetic code is redundant, using 61 codons to specify 20 amino acids. Only two amino acids (Met and Trp) are specified by a single codon, whereas the remaining 18 amino acids are each specified by multiple codons (please see Figure A7-1).

The synonymous codons that specify a single amino acid are not used with equal frequency (Grantham et al. 1980, 1981). Instead, biased usage of synonymous codons is the rule in all species and is the norm in most genes. In addition, there is considerable variation in codon usage between genes in a single species (Bennetzen and Hall 1982; Gouy and Gautier 1982). This results from variation between genes in the G+C content of the third position of synonymous codons (Ikemura 1985; Mirouchoud and Gautier 1988). The pattern of codon usage is the result of selective forces, mutational bias, and genetic drift. For example:

- ***Selection during translation so that the codons used most frequently match the most abundant tRNAs.*** Highly expressed and weakly expressed genes display different patterns of codon usage in both prokaryotes and eukaryotes (Shields and Sharp 1987; Sharp and Devine 1989; Sharp and Cowe 1991). Direct assays of translatability of mRNAs lend further support to this view (e.g., please see Ikemura 1982; Sørensen et al. 1989).
- ***“Knock-on” or context effects, in which mutation of one base influences other bases in the neighborhood*** (Bulmer 1990; Eyre-Walker 1991).
- ***Any selection that results in a change in GC content in codons.*** Bernardi and Bernardi (1986) have argued that regions of the genome with increased (G+C) content are thermodynamically more stable and that mRNAs rich in (G+C) have more secondary structures and are therefore more stable. If correct, this relationship would have effects both on amino acid composition of proteins and on codon usage. There would be selection for “strong” codons that contain G and C at the first two positions (Gly, Ala, Pro) and a selection against weak codons that have A and T at both positions (Phe, Ile, Lys, Asn, Tyr) (Karlin and Bucher 1992). In addition, there would be a slow drift to replace A and T in the third position with G or C. Over the course of time, this gentle evolutionary wind might blow codons, like fallen leaves, into local clumps within individual genes or organisms. However, there are also stabilizing forces that protect codons rich in (A+T). Chief among these is the strong selection against the sequence CG in mammalian genomes. The cytosine of this sequence tends to be methylated and is then prone to mutation. One result is a bias against C in the third position of codons that precede codons beginning with G (e.g., please see Zhang et al. 1991).

Codon usage is a concern in molecular cloning if a sequence of amino acids is used to design an oligonucleotide for screening cDNA or genomic libraries. No rules guarantee selection of the correct codon at a position of ambiguity. However, a probe of 30 or more oligonucleotides would be expected to have at least 76% homology with its target sequence even if all codon choices were made on a random basis (Lathe 1985). If substitutions are chosen on the statistical basis of known codon utilization in the species of interest, the expected homology increases to 82%; it rises still further (to 86%) if regions lacking Leu, Arg, and Ser are chosen (each of these amino acids is specified by six codons). In yeast, still higher accuracy can be achieved by taking into account whether the gene is highly or weakly expressed. In mammalian cells, this latter refinement is not generally used because of the great variation in the level of expression of genes between tissues.

A database of codon usage in different organisms is available at <http://www.kazusa.or.jp/codon/>. The list is based on data derived from an analysis of complete coding sequences in GenBank (Nakamura et al. 1999). For a more detailed analysis of the fluctuation of codon usage in different yeast genes, please see Sharp and Cowe (1991). Codon usage in humans is shown in Table A7-1.

**TABLE A7-1 Codon Usage in Humans**

AMINO ACID	FREQUENCY IN HUMAN PROTEINS (%) <sup>a</sup>	CODONS AND THEIR USAGE IN HUMAN PROTEINS (%) <sup>b</sup>	
Alanine	6.99	GCU (28.0) GCA (20.0)	GCC (41.6) GCG (10.3)
Arginine	5.28	CGU (8.9) CGA (5.4) AGA (9.9)	CGC (21.4) CGG (10.4) AGG (11.1)
Asparagine	3.92	AAU (42.3)	AAC (57.7)
Aspartic Acid	5.07	GAU (42.8)	GAC (57.2)
Cysteine	2.44	UGU (40.6)	UGC (59.4)
Glutamic Acid	6.82	GAA (39.2)	GAG (60.7)
Glutamine	4.47	CAA (24.8)	CAG (75.2)
Glycine	7.10	GGU (15.8) GGA (24.1)	GGC (35.8) GGG (24.3)
Histidine	2.35	CAU (39.6)	CAC (60.4)
Isoleucine	4.50	AUU (33.1) AUA (12.9)	AUC (54.0)
Leucine	9.56	UUA (5.5) CUU (11.1) CUA (6.5)	UUG (11.5) CUC (20.8) CUG (44.5)
Lysine	5.71	AAA (38.9)	AAG (61.1)
Methionine	2.23	AUG (100)	
Phenylalanine	3.84	UUU (41.1)	UUC (58.2)
Proline	5.67	CCU (27.3) CCA (25.7)	CCC (35.2) CCG (11.6)
Serine	7.25	UCU (18.3) UCA (12.9) AGU (13.2)	UCC (23.7) UCG (5.9) AGC (25.9)
Threonine	5.68	ACU (22.4) ACA (25.4)	ACC (40.5) ACG (11.8)
Tryptophan	1.38	UGG (100)	
Tyrosine	3.13	UAU (40.0)	UAC (60.0)
Valine	6.35	GUU (16.4) GUA (9.3)	GUC (25.7) GUG (48.7)

<sup>a</sup>Calculated from an analysis of 1490 human genes (601,683 codons) by Wada et al. (1992). The codon usage for other mammals does not differ greatly from those presented here for human genes.

<sup>b</sup>The figures in parentheses show the frequency with which a particular codon is used to specify a certain amino acid. For example, of the alanine residues present in 1490 human proteins, 28% are specified by GCU, 41.6% by GCC, etc.

		2nd position of codon							
		U		C		A		G	
		1st position of codon (5' terminus)							
U	UUU	Phe	UCU	Ser	UAU	Tyr	UGU	Cys	U
	UUC	Phe	UCC	Ser	UAC	Tyr	UGC	Cys	C
	UUA	Leu	UCA	Ser	UAA	Stop (Ochre)	UGA	Stop	A
	UUG	Leu	UCG	Ser	UAG	Stop (Amber)	UGG	Trp	G
C	CUU	Leu	CCU	Pro	CAU	His	CGU	Arg	U
	CUC	Leu	CCC	Pro	CAC	His	CGC	Arg	C
	CUA	Leu	CCA	Pro	CAA	Gln	CGA	Arg	A
	CUG	Leu	CCG	Pro	CAG	Gln	CGG	Arg	G
A	AUU	Ile	ACU	Thr	AAU	Asn	AGU	Ser	U
	AUC	Ile	ACC	Thr	AAC	Asn	AGC	Ser	C
	AUA	Ile	ACA	Thr	AAA	Lys	AGA	Arg	A
	AUG	Met	ACG	Thr	AAG	Lys	AGG	Arg	G
G	GUU	Val	GCU	Ala	GAU	Asp	GGU	Gly	U
	GUC	Val	GCC	Ala	GAC	Asp	GGC	Gly	C
	GUA	Val	GCA	Ala	GAA	Glu	GGA	Gly	A
	GUG	Val	GCG	Ala	GAG	Glu	GGG	Gly	G

FIGURE A7-1 The Genetic Code

## AMBER MUTANTS AND AMBER SUPPRESSORS

In amber mutants, a codon that specifies an amino acid in a protein is replaced by the chain-terminating codon, UAG. Because there is no tRNA that recognizes UAG, translation of mRNA ceases at the position of the chain-terminating codon, thereby generating an incomplete fragment of the protein.

Some strains of *E. coli* can suppress the chain-terminating phenotype of amber codons, irrespective of the gene in which the amber mutation is located. Such strains carry a mutation that changes the sequence of the anticodon loop in a particular species of tRNA. The suppressor tRNA recognizes the amber codon and inserts its cognate amino acid at the chain-terminating codon, allowing protein synthesis to continue. The efficiency of this process is not absolute. In a strain carrying a strong amber suppressor, suppression of polypeptide chain termination might occur 50% of the time. In weakly suppressing strains, the efficiency may be 10% or less. All of the suppressor strains used in molecular cloning are strong suppressors. Different suppressor tRNAs insert different amino acids at the chain-terminating UAG codon. A few amber suppressors can also suppress ochre (UAA) mutations because of wobble in the third position of the codon.

At one time, it was mandatory for bacteriophage  $\lambda$  vectors to carry amber mutations in genes encoding coat proteins. It was believed that such mutations might reduce the risk of recombinant bacteriophages spreading from the laboratory into field strains of *E. coli*. Hosts for these vectors carry one or two strong amber suppressors — *supE* and *supF* — that insert glutamine and tyrosine, respectively, at UAG codons. These suppressors are not interchangeable. Some amber mutations in bacteriophage  $\lambda$  vectors are suppressed only by *supE* (e.g., Pam3) and others are suppressed only by *supF* (e.g., Sam7 and Sam100). The presence of suppressors does not generally affect the growth of the bacteriophage  $\lambda$  vectors that do not carry amber mutations. Most bacteriophage  $\lambda$  vectors can therefore be assayed and propagated on a strain of *E. coli* such as LE392 that carries *supE* and *supF*.

### HISTORICAL FOOTNOTE

Conditional mutations are a special class of mutations that can occur in a great variety of genes in a single organism. Although temperature-sensitive mutants of *Drosophila*, *Neurospora*, and *E. coli* had been isolated and characterized years before, the full power of temperature-sensitive and amber mutants only became apparent in the early 1960s when Edgar, Epstein, and their colleagues isolated and analyzed a large collection of conditional lethal mutations of bacteriophage T4 (Edgar and Lielausis 1964; Epstein et al. 1964). The first conditional lethal mutants of bacteriophage T4 were isolated quite serendipitously by a CalTech graduate student, Harris Bernstein, during a fruitless search for an entirely different class of phage mutants (Edgar 1966). Bernstein, then a student of *Neurospora* genetics, had wandered into the Epstein-Steinberg laboratory one evening hoping to persuade someone to go with him to the movies. Instead he found himself picking bacteriophage T4 plaques as part of a hunt for “anti-rII” mutants that could grow on *E. coli* K( $\lambda$ ) but not on *E. coli* B. During the course of the evening, there was much debate about whether mutants of this class could exist, with Bernstein arguing strongly that they should. Epstein and Steinberg were more skeptical but, as encouragement to Bernstein, promised that any mutants he isolated would be named after his mother. The next day, when the results of the hunt were analyzed, ~20 mutants with the expected phenotype were found. The promise was kept by translating the German word “Bernstein” into its English equivalent “amber.”

Subsequent work showed that the “anti-rII” mutants were not what they first appeared to be, since they grew in many strains of *E. coli* K not lysogenic for  $\lambda$ . Genetic mapping showed that amber mutants were widely distributed over the bacteriophage T4 genome, and physiological tests showed that their replication was blocked at many different stages in nonpermissive hosts. The hunt for parochial “anti-rII” mutants had therefore uncovered a general class of conditionally lethal, suppressor-sensitive mutants located in bacteriophage genes that were previously completely inaccessible. Strangely enough, none of the first group of 20 mutants were picked by Bernstein. It turned out that he had been flaming his bacterial wire too enthusiastically and had killed all of the bacteriophages!

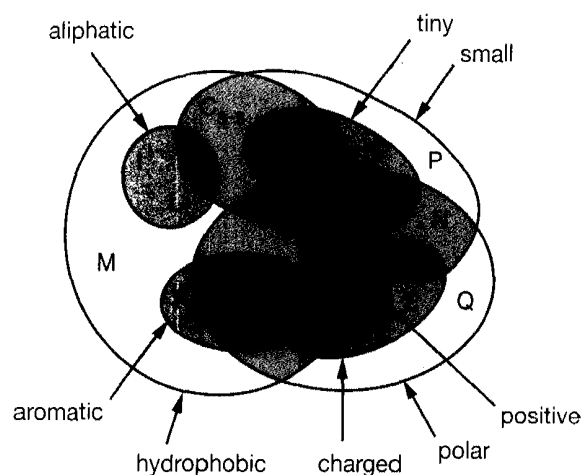
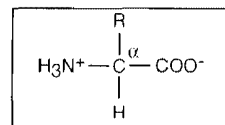


**TABLE A7-2 Amber Suppressors Used in Molecular Cloning**

SUPPRESSOR	CODON RECOGNIZED	AMINO ACID INSERTED	TRNA GENE FROM WHICH SUPPRESSOR IS DERIVED
<i>supD</i> ( <i>suI</i> )	amber (UAG)	serine	<i>serU</i>
<i>supE</i> ( <i>suII</i> )	amber (UAG)	glutamine	<i>gluU</i>
<i>supF</i> ( <i>suIII</i> )	amber (UAG)	tyrosine	<i>tyrT</i>
<i>supB</i> ( <i>suB</i> )	amber (UAG) and ochre (UAA)	glutamine	<i>gluU</i>
<i>supC</i> ( <i>suC</i> )	amber (UAG) and ochre (UAA)	tyrosine	<i>tyrT</i>

## AMINO ACIDS

Of the 20 standard  $\alpha$ -amino acids (Table A7-3) that are incorporated into proteins, 19 have the general structure shown in the figure at the right. R represents the side chain of the amino acid. The twentieth acid, proline, is really an imino acid in which the side chain is bonded to the nitrogen atom of the peptide group. Except in glycine, where the side chain is a hydrogen atom, the  $\alpha$ -carbon is asymmetric and is always the L-isomer. The  $\alpha$ -amino acids can be arranged into several groups according to the chemical properties of their side chains (Table A7-4). The amino acids can also be grouped according to various other criteria, including size and hydrophilicity (Chothia 1976; Kyte and Doolittle 1982; Taylor 1986). The relationships among these groupings of amino acids can be represented in a Venn diagram (Figure A7-2), which is based on the mutational matrix of Dayhoff (1972). The Venn diagram shows the relationships among 20 common amino acids. Cysteine is shown in two locations: The reduced form, cystine (CH), contains a polarizable S-H bond and is therefore similar in some ways to serine (which carries an O-H bond). The oxidized form, cysteine (CS-S), contains no polarizable bond and is therefore more hydrophobic in nature.

**FIGURE A7-2 Venn Diagram**

Venn diagram showing the relationships among 20 common amino acids. (Redrawn, with permission, from Taylor 1986.)

TABLE A7-3 Nomenclature of the 20 Standard  $\alpha$ -Amino Acids

AMINO ACID	THREE-LETTER SYMBOL	ONE-LETTER SYMBOL	MNEMONIC FOR ONE-LETTER SYMBOL
Alanine	Ala	A	Alanine
Arginine	Arg	R	ARginine
Asparagine	Asn	N	AsparagiNe
Aspartic acid	Asp	D	AsparDic
Cysteine	Cys	C	Cysteine
Glutamic acid	Glu	E	GluEtamic
Glutamine	Gln	Q	Q-tamine
Glycine	Gly	G	Glycine
Histidine	His	H	Histidine
Isoleucine	Ile	I	Isoleucine
Leucine	Leu	L	Leucine
Lysine	Lys	K	before L
Methionine	Met	M	Methionine
Phenylalanine	Phe	F	Fenylalanine
Proline	Pro	P	Proline
Serine	Ser	S	Serine
Threonine	Thr	T	Threonine
Tryptophan	Trp	W	TWryptophan
Tyrosine	Tyr	Y	TYrosine
Valine	Val	V	Valine

TABLE A7-4 Properties of L  $\alpha$ -Amino Acids

MAJOR PROPERTIES OF SIDE CHAINS	AMINO ACIDS
No side chain	Gly
Aliphatic	Ala, Val, Leu, Ile, Pro
Hydroxyl group	Ser, Thr
Acidic group	Asp, Glu
Amide group	Asn, Gln
Basic group	Lys, Arg
Imidazole group	His
Aromatic group	Phe, Tyr, Trp
Sulfur-containing	Met, Cys

TABLE A7-5 Molar Conversions for Proteins

MOLECULAR WEIGHT OF UNMODIFIED PROTEIN	APPROXIMATE NUMBER OF RESIDUES	MOLECULES OF PROTEIN IN 1 ml OF A SOLUTION CONTAINING 1 mg/ml	MOLES OF PROTEIN IN 1 ml OF A SOLUTION CONTAINING 1 mg/ml	MOLAR CONCENTRATION OF PROTEIN SOLUTION CONTAINING 1 mg/ml
100,000	917	$6 \times 10^{15}$	$10^{-8}$	$10^{-5}$ M
80,000	734	$7.5 \times 10^{15}$	$1.25 \times 10^{-8}$	$1.25 \times 10^{-5}$ M
60,000	550	$10^{16}$	$1.66 \times 10^{-8}$	$1.66 \times 10^{-5}$ M
40,000	367	$1.5 \times 10^{16}$	$2.50 \times 10^{-8}$	$2.5 \times 10^{-5}$ M
20,000	183	$3 \times 10^{16}$	$50 \times 10^{-8}$	$5.0 \times 10^{-5}$ M
10,000	92	$6 \times 10^{16}$	$10^{-7}$	$10^{-4}$ M

TABLE A7-6 Properties of Amino Acids

AMINO ACID	M.W. OF RESIDUE IN PROTEIN AT PH 7.0	FW	PK <sub>a</sub>			HYDROPATHY INDEX	STRUCTURE
			-COOH	-NH <sub>2</sub>	R-GROUP		
Alanine	71	89.10	2.35	9.87		1.8	$\begin{array}{c} \text{NH}_3^+ \\   \\ \text{CH}_3 - \text{C} - \text{H} \\   \\ \text{COO}^- \end{array}$
Arginine	157	174.20	1.82	8.99	12.48	-4.5	$\text{H}_2\text{N} - \underset{\text{NH}_2}{\text{C}} = \text{NH} - \text{CH}_2 - \text{CH}_2 - \text{CH}_2 - \begin{array}{c} \text{NH}_3^+ \\   \\ \text{C} - \text{H} \\   \\ \text{COO}^- \end{array}$
Asparagine	114	132.12	2.14	8.72		-3.5	$\text{H}_2\text{N} - \underset{\text{O}}{\text{C}} = \text{C} - \begin{array}{c} \text{NH}_3^+ \\   \\ \text{CH}_2 - \text{H} \\   \\ \text{COO}^- \end{array}$
Aspartic Acid	115	133.11	1.99	9.90	3.90	-3.5	$\text{O}^- - \underset{\text{O}}{\text{C}} - \text{CH}_2 - \begin{array}{c} \text{NH}_3^+ \\   \\ \text{C} - \text{H} \\   \\ \text{COO}^- \end{array}$
Cysteine	103	121.16	1.92	10.70	8.37	2.5	$\text{HS} - \text{CH}_2 - \begin{array}{c} \text{NH}_3^+ \\   \\ \text{C} - \text{H} \\   \\ \text{COO}^- \end{array}$
Glutamic Acid	129	147.13	2.10	9.47	4.07	-3.5	$\text{O}^- - \underset{\text{O}}{\text{C}} - \text{CH}_2 - \text{CH}_2 - \begin{array}{c} \text{NH}_3^+ \\   \\ \text{C} - \text{H} \\   \\ \text{COO}^- \end{array}$
Glutamine	128	146.15	2.17	9.13		-3.5	$\text{NH}_2 - \underset{\text{O}}{\text{C}} - \text{CH}_2 - \text{CH}_2 - \begin{array}{c} \text{NH}_3^+ \\   \\ \text{C} - \text{H} \\   \\ \text{COO}^- \end{array}$
Glycine	57	75.07	2.35	9.78		-0.4	$\text{H} - \begin{array}{c} \text{NH}_3^+ \\   \\ \text{C} - \text{H} \\   \\ \text{COO}^- \end{array}$
Histidine	137	155.16	1.80	9.33	6.04	-3.2	$\begin{array}{c} \text{HC} = \text{C} - \text{CH}_2 - \begin{array}{c} \text{NH}_3^+ \\   \\ \text{C} - \text{H} \\   \\ \text{COO}^- \end{array} \\   \quad   \\ \text{HN} \quad \text{NH} \\   \\ \text{C} \\   \\ \text{H} \end{array}$

Isoleucine	113	131.18	2.32	9.76		4.5	
Leucine	113	131.18	2.33	9.74		3.8	
Lysine	128	146.19	2.16	9.06	10.54	-3.9	
Methionine	131	149.21	2.13	9.28		1.9	
Phenylalanine	147	165.19	2.20	9.31		2.8	
Proline	97	115.13	1.95	10.64		-1.6	
Serine	87	105.09	2.19	9.21		-0.8	
Threonine	101	119.12	2.09	9.10		-0.7	
Tryptophan	186	204.23	2.46	9.41		-0.9	
Tyrosine	163	181.19	2.20	9.21	10.46	-1.3	
Valine	99	117.15	2.29	9.74		4.2	

Data used from Kyte and Doolittle (1982).



# Appendix 8

---

## Commonly Used Techniques in Molecular Cloning

<b>PREPARATION OF GLASSWARE AND PLASTICWARE</b>	A8.3
Siliconizing Glassware, Plasticware, and Glass Wool	A8.3
Preparation of RNase-free Glassware	A8.3
<b>PREPARATION OF DIALYSIS TUBING</b>	A8.4
<b>STORAGE OF BACTERIAL CULTURES</b>	A8.5
Stab Cultures	A8.5
Cultures Containing Glycerol	A8.5
<b>ESTIMATION OF CELL NUMBER</b>	A8.6
Hemocytometry Counting	A8.6
Viability Staining	A8.7
<b>PURIFICATION OF NUCLEIC ACIDS</b>	A8.9
Extraction with Phenol:Chloroform	A8.9
Drop Dialysis	A8.11
<b>CONCENTRATING NUCLEIC ACIDS</b>	A8.12
Ethanol Precipitation	A8.12
Standard Ethanol Precipitation of DNA in Microfuge Tubes	A8.14
Precipitation of RNA with Ethanol	A8.16
Precipitation of Large RNAs with Lithium Chloride	A8.16
Concentrating and Desalting Nucleic Acids with Microconcentrators	A8.16
Concentrating Nucleic Acids by Extraction with Butanol	A8.18
<b>QUANTITATION OF NUCLEIC ACIDS</b>	A8.19
Spectrophotometry of DNA or RNA	A8.20
Fluorometric Quantitation of DNA Using Hoechst 33258	A8.22
Quantitation of Double-stranded DNA Using Ethidium Bromide	A8.23
Saran Wrap Method Using Ethidium Bromide or SYBR Gold	A8.24
Agarose Plate Method	A8.24
Minigel Method	A8.24

<b>MEASUREMENT OF RADIOACTIVITY IN NUCLEIC ACIDS</b>	A8.25
Precipitation of Nucleic Acids with Trichloroacetic Acid	A8.25
Adsorption to DE-81 Filters	A8.26
<b>DECONTAMINATION OF SOLUTIONS CONTAINING ETHIDIUM BROMIDE</b>	A8.27
Removing Ethidium Bromide from DNA	A8.27
Disposing of Ethidium Bromide	A8.27
Decontamination of Concentrated Solutions of Ethidium Bromide (Solutions Containing >0.5 mg/ml)	A8.27
Decontamination of Dilute Solutions of Ethidium Bromide (e.g., Electrophoresis Buffer Containing 0.5 µg/ml Ethidium Bromide)	A8.28
Commercial Decontamination Kits	A8.28
<b>GEL-FILTRATION CHROMATOGRAPHY</b>	A8.29
Preparation of Sephadex	A8.29
Column Chromatography	A8.29
Spun-column Chromatography	A8.30
<b>SEPARATION OF SINGLE-STRANDED AND DOUBLE-STRANDED DNAs BY HYDROXYAPATITE CHROMATOGRAPHY</b>	A8.32
<b>FRAGMENTATION OF DNA</b>	A8.35
Sonication	A8.36
Nebulization	A8.37
<b>CENTRIFUGATION</b>	A8.39
<b>SDS-POLYACRYLAMIDE GEL ELECTROPHORESIS OF PROTEINS</b>	A8.40
Reagents	A8.41
<b>STAINING SDS-POLYACRYLAMIDE GELS</b>	A8.46
Staining SDS-Polyacrylamide Gels with Coomassie Brilliant Blue	A8.46
Staining SDS-Polyacrylamide Gels with Silver Salts	A8.47
<b>DRYING SDS-POLYACRYLAMIDE GELS</b>	A8.50
<b>IMMUNOBLOTTING</b>	A8.52
Transfer of Proteins from Gel to Filter	A8.52
Types of Membranes	A8.53
Staining of Proteins during Immunoblotting	A8.54
Blocking Agents	A8.54
Probing and Detection	A8.54

## PREPARATION OF GLASSWARE AND PLASTICWARE

**CAUTION:** Please see Appendix 12 for appropriate handling of materials marked with <!>.

All glassware should be sterilized by autoclaving or baking. Some, but not all, plasticware can be autoclaved, depending on the type of plastic. Many items of sterilized plasticware are commercially available. All of the procedures commonly used in molecular cloning should be carried out in sterile glassware or plasticware; there is no significant loss of material by adsorption onto the surfaces of the containers. However, for certain procedures (e.g., handling very small quantities of single-stranded DNA or sequencing by the Maxam-Gilbert technique), it is best to use glassware or plasticware that has been coated with a thin film of silicone. A simple procedure for siliconizing small items such as pipettes, tubes, and beakers is given below. To siliconize large items such as glass plates, please refer to the note at the end of the protocol.

### Siliconizing Glassware, Plasticware, and Glass Wool

The following method was supplied by Brian Seed (Massachusetts General Hospital).

1. Place the items to be siliconized inside a large, glass desiccator.
2. Add 1 ml of dichlorodimethylsilane <!> to a small beaker inside the desiccator.
3. Attach the desiccator, through a trap, to a vacuum pump. Turn on the vacuum and continue to apply suction until the dichlorodimethylsilane begins to boil. Immediately clamp the connection between the vacuum pump and the desiccator. Switch off the vacuum pump. The desiccator should maintain a vacuum.

It is essential to turn off the vacuum pump as soon as the dichlorodimethylsilane begins to boil. Otherwise, the volatile agent will be sucked into the pump and cause irreparable damage to the vacuum seals.

4. When the dichlorodimethylsilane has evaporated (1–2 hours), open the desiccator in a chemical fume hood. After the fumes of dichlorodimethylsilane have dispersed, remove the glassware or plasticware. Bake glassware and glass wool for 2 hours at 180°C before use. Rinse plasticware extensively with H<sub>2</sub>O before use; do not autoclave.

### NOTES

- Large items of glassware can be siliconized by soaking or rinsing them in a 5% solution of dichlorodimethylsilane in chloroform or heptane. Commercial preparations for siliconizing are also available (e.g., Sigmacoat).
- As the organic solvent evaporates, the dichlorodimethylsilane is deposited on the glassware, which must be rinsed numerous times with H<sub>2</sub>O or baked for 2 hours at 180°C before use.

### Preparation of RNase-free Glassware

Guidelines for the treatment of glassware for use with RNA are given in the information panel on **HOW TO WIN THE BATTLE WITH RNASE** in Chapter 7.



## PREPARATION OF DIALYSIS TUBING

---

The separation of molecules across a semipermeable membrane is driven by the concentration differential between the solutions on either side of the membrane and is constrained by the size (molecular weight) of the molecules relative to the size of the pores within the membrane. The pore size determines the molecular-weight cut-off, defined as the molecular weight at which 90% of the solute will be retained by the membrane. The exact permeability of a solute is dependent not only on the size of the molecule, but also on the shape of the molecule, its degree of hydration, and its charge. Each of these parameters may be influenced by the nature of the solvent, its pH, and its ionic strength. As a consequence, the molecular-weight cut-off should be used as a guide and not an absolute predictor of performance with every type of solute and solvent. Dialysis membranes are available in an enormous range of pore sizes (from 100 daltons to 2000 kD). For dialysis of most plasmid DNAs and many proteins, a molecular-weight cut-off of 12,000 to 14,000 is suitable.

1. Cut the tubing into pieces of convenient length (10–20 cm).
2. Boil the tubing for 10 minutes in a large volume of 2% (w/v) sodium bicarbonate and 1 mM EDTA (pH 8.0).
3. Rinse the tubing thoroughly in distilled H<sub>2</sub>O.
4. Boil the tubing for 10 minutes in 1 mM EDTA (pH 8.0).
5. Allow the tubing to cool, and then store it at 4°C. Be sure that the tubing is always submerged.  
▲ **IMPORTANT** From this point onward, always handle the tubing with gloves.
6. Before use, wash the tubing inside and out with distilled H<sub>2</sub>O.

### NOTE

- Instead of boiling for 10 minutes in 1 mM EDTA (pH 8.0) (Step 4), the tubing may be autoclaved at 20 psi (1.40 kg/cm<sup>2</sup>) for 10 minutes on liquid cycle in a loosely capped jar filled with H<sub>2</sub>O.

## STORAGE OF BACTERIAL CULTURES

---

### Stab Cultures

To store a bacterial culture in solid medium, pick a single, well-isolated colony with a sterile inoculating needle and stab the needle several times through the agar to the bottom of a stab vial (for the preparation of stab vials, please see Appendix 2). Replace and tighten the cap, and label both the vial and the cap. Store the vial in the dark at room temperature.

### Cultures Containing Glycerol

#### *Storage of Bacterial Cultures Growing in Liquid Media*

1. To 1.5 ml of bacterial culture, add 0.5 ml of sterile 60% glycerol (sterilized by autoclaving for 20 minutes at 15 psi [1.05 kg/cm<sup>2</sup>] on liquid cycle).
2. Vortex the culture to ensure that the glycerol is evenly dispersed.
3. Transfer the culture to a labeled storage tube equipped with a screw cap and an air-tight gasket.
4. Freeze the culture in ethanol-dry ice or in liquid nitrogen, and then transfer the tube to  $-70^{\circ}\text{C}$  for long-term storage.
5. To recover the bacteria, scrape the frozen surface of the culture with a sterile inoculating loop, and then immediately streak the bacteria that adhere to the needle onto the surface of an LB agar plate containing the appropriate antibiotic. Return the frozen culture to storage at  $-70^{\circ}\text{C}$ . Incubate the plate overnight at  $37^{\circ}\text{C}$ .

#### *Storage of Bacterial Cultures Growing on Agar Plates*

1. Scrape the bacteria growing on the surface of an agar plate into 2 ml of LB medium in a sterile tube. Add an equal volume of LB medium containing 30% sterile glycerol.
2. Vortex the mixture to ensure that the glycerol is completely dispersed.
3. Dispense aliquots of the glycerinated culture into sterile tubes equipped with screw caps and air-tight gaskets. Freeze the cultures as described above.

This method is useful for storing copies of cDNA libraries established in plasmid vectors (for discussion, please see Hanahan 1985).

## ESTIMATION OF CELL NUMBER\*

The number of mammalian cells in a defined volume of medium can be measured using a hemocytometer. Automated methods using cell-counting devices such as those produced by Coulter are desirable when large numbers of individual samples are to be counted. A method to estimate the number of live cells in a population by staining with a vital dye also is provided here.

### Hemocytometry Counting

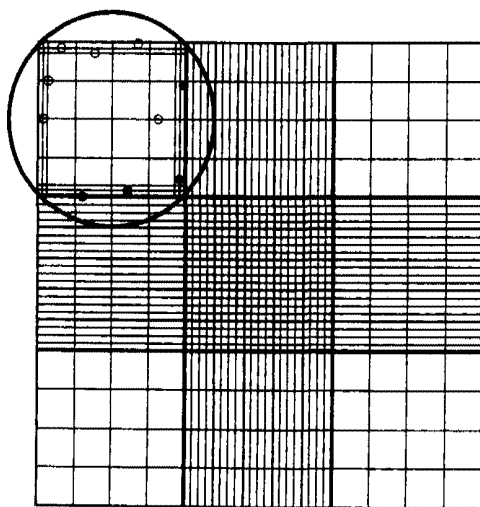
A hemocytometer contains two chambers, each of which when filled and coverslipped contains a total volume of 9  $\mu\text{l}$ . Each chamber is ruled into nine major squares, and each square is 1  $\times$  1 mm with a depth of 0.1 mm. Thus, when coverslipped, the volume of each square is 0.1  $\text{mm}^3$  or 0.1  $\mu\text{l}$ . Additional subdivisions of the major nine squares are not necessary for counting and can be ignored. A representation of the marking on a hemocytometer is shown in Figure A8-1.

1. Trypsinize the cells (please see Chapter 17, Protocol 8: Stage 1, Step 18) and resuspend them in growth medium.
2. Use Pasteur pipettes to remove two independent samples from the cell suspension to be counted. Deliver each sample of cell suspension into one side of the coverslipped hemocytometer by capillary action.

Fluid should just fill the chamber and not overflow into the troughs outside the counting face. Load the first sample into one chamber and the second sample into the second chamber.

3. Count the total number of cells in five of the nine large squares in each of two sides of the hemocytometer for a total of ten squares.

The microscope field using a 10x objective and a 10x ocular should encompass the majority of one of the nine squares of the chamber and is a convenient magnification to use for counting. Cells that overlap the border on two sides of the square should be included in the cell count and not counted on the other two sides. If the initial dilution results in more than 50–100 cells/square, make a further dilution to improve counting accuracy and speed the process of determining cell numbers.



**FIGURE A8-1 Standard Hemocytometer Chamber**

The circle indicates the approximate area covered at 100x microscope magnification (10x ocular and 10x objective). Count the cells on top and left touching the middle line (*open circles*). Do not count the cells touching the middle line at bottom and right (*closed circles*). Count the 4 corner squares and the middle square in both chambers (only one chamber is represented here).

\*Adapted from Spector et al. (1998 *Cells: A Laboratory Manual*).

4. Add the number of cells in a total of ten chambers (five from one side and five from the other) to give the number of cells in  $1 \times 10^{-3}$  ml ( $1 \times 10^{-4}$  ml/square  $\times$  10 squares = a volume of  $10^{-3}$  ml). Multiply the total number of cells by 1000 to give the number of cells/ml in the sample counted.

If dilutions from the original cell suspension have been made, this factor must also be incorporated.

**EXAMPLE:**

1 ml of a 10-ml suspension of cells is diluted with 4 ml of medium. The diluted suspension is then sampled with a Pasteur pipette twice. The first sample is delivered to one chamber of the hemocytometer. The second sample is delivered to the second side. Five squares are counted from each side of the hemocytometer.

Number of cells/square: 45, 37, 52, 40, 60, 48, 54, 70, 58, 60

Total count: 524

Dilution factor:  $(1 + 4)/1 = 5$

Cells/ml (in original):  $524 \times 10^3 \times 5 = 2.62 \times 10^6/\text{ml}$  cells

5. Immediately after use, clean the hemocytometer and coverslip by rinsing in distilled  $\text{H}_2\text{O}$  followed by 70% ethanol. Dry with lens paper.

▲ **IMPORTANT** Do not allow the cell suspension to dry on the hemocytometer.

## NOTES

Errors that may result from using hemocytometer counts are due to:

- **Variable sampling from the original cell suspension.** The cell suspension must be agitated; do not allow the cells to settle to the bottom of the container.
- **Inadequate or excessive filling of the hemocytometer chamber.** The volume in the chambers counted is based on the coverslip resting on the sides of the hemocytometer. Overflow increases the volume counted.
- **Cell clumping.** Large clumps of cells may be too large to enter the chamber through capillary action and will be excluded from the cell count. Small clumps that are able to enter the chamber are difficult to count with accuracy. It is important to have a monodisperse suspension of cells for accurate counting. The cells must be thoroughly mixed to achieve uniformity.

## Viability Staining

Various manipulations of cells, including passaging, freezing, and dissociation from primary tissue, can result in cell death. Exclusion of the dye, Trypan Blue, can be used to determine the number of surviving cells in a population (Phillips 1973). Normal healthy cells are able to exclude the dye, but Trypan Blue diffuses into cells in which membrane integrity has been lost. The dye exclusion method is an approximate estimate of cell viability and often does not distinguish within a 10–20% difference. Additionally, cells that exclude dye are not necessarily capable of attachment and prolonged survival or proliferation.

1. Trypsinize the cells (please see Chapter 17, Protocol 8: Stage 1, Step 18) and aseptically dilute 0.5 ml of cells into phosphate-buffered saline to a concentration from  $2 \times 10^5$  to  $4 \times 10^5$  cells/ml.
2. Aseptically transfer 0.5 ml of the diluted cell suspension in phosphate-buffered saline to a fresh tube and add 0.5 ml of a solution of Trypan Blue (0.4% w/v).

3. Allow the cells to remain in the dye solution for no less than 3 minutes and no longer than 10 minutes. Use a Pasteur pipette to sample the cells in dye and deliver them to a hemocytometer by capillary action.
4. Count a total of at least 500 cells, keeping a separate count of blue cells. Determine the frequency of those that are blue, i.e., have not excluded the dye.
5. Determine the percent viability from the number of cells that have not excluded the dye.

**EXAMPLE:**

A monolayer culture is trypsinized and resuspended in 5 ml of medium; 0.5 ml of cells is mixed with 4.5 ml of PBS, and 0.5 ml of the suspended cells in PBS is transferred to a small tube and mixed with 0.5 ml of Trypan Blue solution. In the sample transferred to the hemocytometer, 540 cells are counted; 62 of the cells fail to exclude the dye and are blue. The percent viability equals 88.5%.

$540 - 62 =$  the number of cells that excluded the dye

540 = the total number of cells counted

$$\frac{540 - 62}{540} \times 100 = 88.5\% \text{ viability}$$

## PURIFICATION OF NUCLEIC ACIDS

**CAUTION:** Please see Appendix 12 for appropriate handling of materials marked with <!.>.

Perhaps the most basic of all procedures in molecular cloning is the purification of nucleic acids. The key step, the removal of proteins, can often be carried out simply by extracting aqueous solutions of nucleic acids with phenol:chloroform <!.> and chloroform <!.>. Such extractions are used whenever it is necessary to inactivate and remove enzymes that are used in one step of a cloning operation before proceeding to the next. However, additional measures are required when nucleic acids are purified from complex mixtures of molecules such as cell lysates. In these cases, it is usual to remove most of the protein by digestion with proteolytic enzymes such as pronase or proteinase K (please see Appendix 4, Table A4-8), which are active against a broad spectrum of native proteins, before extracting with organic solvents.

### Extraction with Phenol:Chloroform

The standard way to remove proteins from nucleic acid solutions is to extract first with phenol:chloroform (optionally containing hydroxyquiniline at 0.1%) and then with chloroform. This procedure takes advantage of the fact that deproteinization is more efficient when two different organic solvents are used instead of one. Furthermore, although phenol denatures proteins efficiently, it does not completely inhibit RNase activity, and it is a solvent for RNA molecules that contain long tracts of poly(A) (Brawerman et al. 1972). Both of these problems can be circumvented by using a mixture of phenol:chloroform:isoamyl alcohol (25:24:1). The subsequent extraction with chloroform removes any lingering traces of phenol from the nucleic acid preparation. Extraction with ether, which was widely used for this purpose for many years, is no longer required or recommended for routine purification of DNA.

1. Transfer the sample to a polypropylene tube and add an equal volume of phenol:chloroform.

The nucleic acid will tend to partition into the organic phase if the phenol has not been adequately equilibrated to a pH of 7.8–8.0.

2. Mix the contents of the tube until an emulsion forms.
3. Centrifuge the mixture at 80% of the maximum speed that the tubes can bear for 1 minute at room temperature. If the organic and aqueous phases are not well separated, centrifuge again for a longer time.

Normally, the aqueous phase forms the upper phase. However, if the aqueous phase is dense because of salt (>0.5 M) or sucrose (>10%), it will form the lower phase. The organic phase is easily identifiable because of the yellow color contributed by the 8-hydroxyquinoline that is added to phenol during equilibration (please see Appendix 1).

4. Use a pipette to transfer the aqueous phase to a fresh tube. For small volumes (<200  $\mu$ l), use an automatic pipettor fitted with a disposable tip. Discard the interface and organic phase.

To achieve the best recovery, the organic phase and interface may be “back-extracted” as follows: After the first aqueous phase has been transferred as described above, add an equal volume of TE (pH 7.8) to the organic phase and interface. Mix well. Separate the phases by centrifugation as in Step 3. Combine this second aqueous phase with the first, and proceed to Step 5.

5. Repeat Steps 1–4 until no protein is visible at the interface of the organic and aqueous phases.
6. Add an equal volume of chloroform and repeat Steps 2–4.
7. Recover the nucleic acid by standard precipitation with ethanol.

Occasionally, ether <math>\langle ! \rangle</math> is used to remove traces of chloroform from preparations of high-molecular-weight DNA (please see the Notes below).

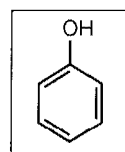
## NOTES

The organic and aqueous phases may be mixed by vortexing when isolating small DNA molecules (<math>< 10\text{ kb}</math>) or by gentle shaking when isolating DNA molecules of moderate size (10–30 kb). When isolating large DNA molecules (>30 kb), the following precautions must be taken to avoid shearing (please see also Chapter 6).

- Mix the organic and aqueous phases by rotating the tube slowly (20 rpm) on a wheel.
- Use large-bore pipettes to transfer the DNA from one tube to another.

### HISTORICAL FOOTNOTE ON PHENOL ( $C_6H_6O$ , F.W. = 94.11)

Until the mid 1950s, the standard method of purifying DNA involved stripping protein from the nucleic acid with detergent and strong salt solutions (e.g., perchlorate). Final deproteinization was achieved by several extractions with chloroform laced with isoamyl alcohol (Sevag 1934; Sevag et al. 1938). The first reported use of phenol to purify nucleic acids was published by Kirby (1956), who was aware of the power of phenol to extract proteins from aqueous solution (Grassmann and Deffner 1953). In his initial paper, Kirby showed that extraction of homogenates of mammalian tissue with a two-phase phenol- $H_2O$  mixture at room temperature led to partitioning of RNA into the aqueous layer. DNA remained associated with protein at the interface. Kirby quickly realized that replacement of  $H_2O$  by solutions of anionic salts released both RNA and DNA into the aqueous phase (Kirby 1957; for review, please see Kirby 1964). Although the use of anionic salts to release proteins from DNA was quickly abandoned in favor of strong anionic detergents such as SDS, Kirby's original description of phenol extraction forms the basis of many purification methods in common use today. The function of the phenol is probably the same as that of a protein solvent: It extracts protein that has been dissociated from nucleic acids by anionic salts or detergents. So efficient is this process that pure preparations of nucleic acid are obtained after just two or three extractions with phenol.



Purified phenol has a specific gravity of 1.07 and therefore forms the lower phase when mixed with  $H_2O$ . However, the organic and aqueous phases may be difficult to separate or may invert when phenol is used to extract protein from aqueous solutions containing high concentrations of solutes. This problem is largely alleviated when a 50:50 mixture of phenol:chloroform is used, because the higher density of chloroform (1.47) ensures separation of the two phases. Denatured proteins collect at the interface between the two phases while lipids partition efficiently into the organic layer. Isoamyl alcohol is often added to the phenol:chloroform mixture to reduce foaming.

Pure phenol is supplied as a white crystalline mass (mp  $43^\circ\text{C}$ ). However, on exposure to air and light, phenol is prone to redden, a process that is accelerated by alkalinity. Crystalline phenol is not recommended because it must be redistilled at  $182^\circ\text{C}$  to remove oxidation products such as quinones that cause the breakdown of phosphodiester bonds or promote cross-linking of nucleic acids.

The liquefied form of phenol provided by many manufacturers contains ~8%  $H_2O$  and can be stored frozen at  $-20^\circ\text{C}$ . Liquefied phenol, if colorless, can be used in molecular cloning without redistillation. Today, only occasional batches of liquefied phenol are pink or yellow, and these should be rejected and returned to the manufacturer.

Before use, phenol must be saturated with  $H_2O$  and equilibrated with Tris to a pH of >7.8 to suppress partitioning of DNA into the organic phase, which occurs at acidic pH.

### **Drop Dialysis**

Low-molecular-weight contaminants, which may inhibit restriction digestion or DNA sequencing, can be removed from DNA in solution by drop dialysis.

1. Spot a drop (~50  $\mu$ l) of DNA in the center of a Millipore Series V membrane (0.025  $\mu$ m), floating shiny side up on 10 ml of sterile H<sub>2</sub>O in a 10-cm diameter Petri dish.
2. Dialyze the DNA for 10 minutes.
3. Remove the drop to a clean microfuge tube, and use aliquots of the dialyzed DNA for restriction enzyme digestion and/or DNA sequencing.



## CONCENTRATING NUCLEIC ACIDS

**CAUTION:** Please see Appendix 12 for appropriate handling of materials marked with <!>.

### Ethanol Precipitation

Precipitation with ethanol is the standard method to recover nucleic acids from aqueous solutions. It is rapid, virtually foolproof, and efficient: Subnanogram amounts of DNA and RNA can be quantitatively precipitated with ethanol, collected by centrifugation, and redissolved within minutes.

Ethanol depletes the hydration shell from nucleic acids and exposes negatively charged phosphate groups. Counterions such as Na<sup>+</sup> bind to the charged groups and reduce the repulsive forces between the polynucleotide chains to the point where a precipitate can form. Ethanol precipitation can therefore only occur if cations are available in sufficient quantity to neutralize the charge on the exposed phosphate residues. The most commonly used cations are shown in Table A8-1 and are described below.

- **Ammonium acetate** is frequently used to reduce the coprecipitation of unwanted contaminants (e.g., dNTPs or oligosaccharides) with nucleic acids. For example, two sequential precipitations of DNA in the presence of 2 M ammonium acetate result in the removal of >99% of the dNTPs from preparations of DNA (Okayama and Berg 1982). Ammonium acetate is also the best choice when nucleic acids are precipitated after digestion of agarose gels with agarase. The use of this cation reduces the possibility of coprecipitation of oligosaccharide digestion products. However, ammonium acetate should not be used when the precipitated nucleic acid is to be phosphorylated, since bacteriophage T4 polynucleotide kinase is inhibited by ammonium ions.
- **Lithium chloride** is frequently used when high concentrations of ethanol are required for precipitation (e.g., when precipitating RNA). LiCl is very soluble in ethanolic solutions and is not coprecipitated with the nucleic acid. Small RNAs (tRNAs and 5S RNAs) are soluble in solutions of high ionic strength (without ethanol), whereas large RNAs are not. Because of this difference in solubility, precipitation in high concentrations of LiCl (0.8 M) can be used to purify large RNAs.
- **Sodium chloride** (0.2 M) should be used if the DNA sample contains SDS. The detergent remains soluble in 70% ethanol.
- **Sodium acetate** (0.3 M, pH 5.2) is used for most routine precipitations of DNA and RNA.

Until a few years ago, ethanol precipitation was routinely carried out at low temperature (e.g., in a dry-ice/methanol bath). This is now known to be unnecessary. At 0°C in the absence of carrier, DNA concentrations as low as 20 ng/ml will form a precipitate that can be quantitatively recovered by centrifugation in a microfuge. However, when lower concentrations of DNA or very small fragments (<100 nucleotides in length) are processed, more extensive centrifugation may be necessary to cause the pellet of nucleic acid to adhere tightly to the centrifuge tube. Centrifugation at 100,000g for 20–30 minutes allows the recovery of picogram quantities of nucleic acid in the absence of carrier.

**TABLE A8-1** Salt Solutions

SALT	STOCK SOLUTION (M)	FINAL CONCENTRATION (M)
Ammonium acetate	10.0	2.0–2.5
Lithium chloride	8.0	0.8
Sodium chloride	5.0	0.2
Sodium acetate	3.0 (pH 5.2)	0.3

When dealing with small amounts of DNA, it is prudent to save the ethanolic supernatant from each step until all of the DNA has been recovered. This retention is especially important after precipitates of DNA have been washed with 70% ethanol, a treatment that often loosens the precipitates from the wall of the tube.

### ***Dissolving DNA Precipitates***

Until a few years ago, DNA precipitates recovered after ethanol precipitation were dried under vacuum before being redissolved. This practice has now been abandoned (1) because desiccated pellets of DNA dissolve slowly and inefficiently and (2) because small fragments of double-stranded DNA (<400 bp) become denatured upon drying, probably as a result of loss of the stabilizing shell of bound water molecules (Svaren et al. 1987).

These days, the best practice is to remove ethanol from the nucleic acid pellet and from the sides of the tube by gentle aspiration and then to store the open tube on the bench for ~15 minutes to allow most of the residual ethanol to evaporate. The still-damp pellet of nucleic acid can then be dissolved rapidly and completely in the appropriate buffer. If necessary, the open tube containing the redissolved DNA can be incubated for 2–3 minutes at 45°C in a heating block to allow any traces of ethanol to evaporate.

The precipitated DNA is not all found at the bottom of the tube after centrifugation in an angle-head rotor. In the case of microfuge tubes, for example, at least 40% of the precipitated DNA is plastered on the wall of the tube. To maximize recovery of DNA, use a pipette tip to roll a bead of solvent several times over the appropriate segment of the wall. If the sample of DNA is radioactive, check that no detectable radioactivity remains in the tube after the dissolved DNA has been removed.

### ***Carriers***

Carriers (or coprecipitants) are inert substances that are used to improve the recovery of small quantities of nucleic acids during ethanol precipitation. Insoluble in ethanolic solutions, carriers form a precipitate that traps the target nucleic acids. During centrifugation, carriers generate a visible pellet that facilitates handling of the target nucleic acids. This may be their major virtue: As discussed above, ethanol precipitation — even of small amounts of nucleic acids in dilute solution — is remarkably efficient. Carriers do little, other than provide visual clues to the location of the target nucleic acid. Three substances are commonly used as carriers: yeast tRNA, glycogen, and linear polyacrylamide. Their advantages and disadvantages are listed in Table A8-2.

**TABLE A8-2** Carriers

CARRIER	WORKING CONCENTRATION	ADVANTAGES/DISADVANTAGES
Yeast tRNA	10–20 µg/ml	Yeast tRNA is inexpensive, but it has the disadvantage that it cannot be used for precipitating nucleic acids that will be used as substrates in reactions catalyzed by polynucleotide kinase or terminal transferase. The termini of yeast RNA are excellent substrates for these enzymes and would compete with the termini contributed by the target nucleic acid.
Glycogen	50 µg/ml	Glycogen is usually used as a carrier when nucleic acids are precipitated with 0.5 M ammonium acetate and isopropanol. Glycogen is not a nucleic acid and therefore does not compete with the target nucleic acids in subsequent enzymatic reactions. However, it can interfere with interactions between DNA and proteins (Gaillard and Strauss 1990).
Linear polyacrylamide	10–20 µg/ml	Linear polyacrylamide is an efficient neutral carrier for precipitating picogram amounts of nucleic acids with ethanol and proteins with acetone (Strauss and Varshavsky 1984; Gaillard and Strauss 1990).

**HISTORICAL FOOTNOTE**

Ethanol precipitation predates molecular cloning by ~50 years. It was first used as a method to concentrate biologically active nucleic acid by J. Lionel Alloway, who worked at the Rockefeller Institute in the early 1930s. His project was to prepare active cell-free extracts of S-type *Streptococcus pneumoniae* that would permit bacterial transformation of R-type organisms in vitro. At that time, transformation had been achieved only with intact, heat-killed donor cells. After many frustrating failures, Alloway reported in 1932 that he could get the substance responsible for transformation into solution by heating a freeze/thaw extract of the S organisms to 60°C, removing particulate matter by centrifugation, and passing the solution through a filter made of porous porcelain (Alloway 1932). This last step was included to silence skeptics who believed that transformation was an artifact caused by an occasional S-type organism that survived the extraction procedure.

Alloway's success at eliminating the need for heat-killed donor cells was a major step on the road that eventually led to the discovery of DNA as the transforming material (Avery et al. 1944). However, not all of Alloway's cell-free preparations worked, and, even when transformation was obtained, the efficiency was very low. Alloway must have realized that these problems were caused by the dilute nature of the extract, for he began to search for different ways to lyse the pneumococci and for different methods to concentrate the transforming activity (Alloway 1933). Maclyn McCarty (1985) described Alloway's discovery of ethanol precipitation as follows:

Alloway then introduced another new procedure that became an indispensable part of all work on the transforming substance from that time forward. He added pure alcohol in a volume five times that of the extract which resulted in precipitation of most of the material that had been released from the pneumococci... The precipitated material could be redissolved in salt solution and shown to contain the active substance in transformation tests. Alcohol precipitation and resolution could be repeated at will without loss of activity.

Alloway was certainly not the first person to precipitate nucleic acids with ethanol. This technique had already been used as a purification step by several generations of organic chemists who were puzzling over the structure of the bases in DNA. However, Alloway was the first to use ethanol precipitation to prepare material that could change the phenotype of recipient cells. Final proof that the transforming factor was DNA still lay a dozen or more years into the future. But Alloway could fairly claim to be the inventor of a technique that is now second nature to us all.

**Standard Ethanol Precipitation of DNA in Microfuge Tubes**

1. Estimate the volume of the DNA solution.
2. Adjust the concentration of monovalent cations either by dilution with TE (pH 8.0) if the DNA solution contains a high concentration of salts or by addition of one of the salt solutions shown in Table A8-1.

If the volume of the final solution is 400 µl or less, carry out precipitation in a single microfuge tube. Larger volumes can be divided among several microfuge tubes, or the DNA can be precipitated and centrifuged in tubes that will fit in a medium-speed centrifuge or ultracentrifuge.

3. Mix the solution well. Add exactly 2 volumes of ice-cold ethanol and again mix the solution well. Store the ethanolic solution on ice to allow the precipitate of DNA to form.

Usually 15–30 minutes is sufficient, but when the size of the DNA is small (<100 nucleotides) or when it is present in small amounts (<0.1 µg/ml), extend the period of storage to at least 1 hour and add MgCl<sub>2</sub> to a final concentration of 0.01 M.

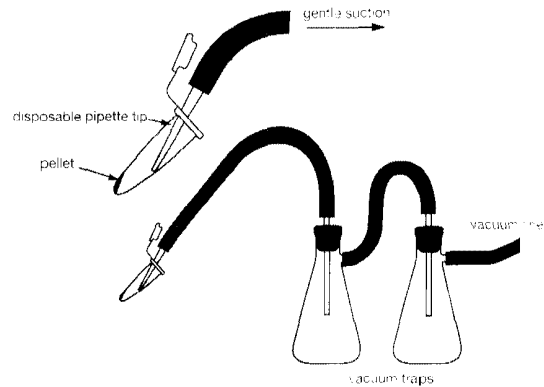
DNA can be stored indefinitely in ethanolic solutions at 0°C or at –20°C.

4. Recover the DNA by centrifugation at 0°C.

For most purposes, centrifugation at maximum speed for 10 minutes in a microfuge is sufficient. However, as discussed above, when low concentrations of DNA (<20 ng/ml) or very small fragments are being processed, more extensive centrifugation may be required.

**FIGURE A8-2 Aspiration of Supernatants**

Hold the open microfuge tube at an angle, with the pellet on the upper side. Use a disposable pipette tip attached to a vacuum line to withdraw fluid from the tube. Insert the tip just beneath the meniscus on the lower side of the tube. Move the tip toward the base of the tube as the fluid is withdrawn. Use a gentle suction to avoid drawing the pellet into the pipette tip. Keep the end of the tip away from the pellet. Finally, vacuum the walls of the tube to remove any adherent drops of fluid.



- Carefully remove the supernatant with an automatic micropipettor or with a disposable pipette tip attached to a vacuum line (please see Figure A8-2). Take care not to disturb the pellet of nucleic acid (which may be invisible). Use the pipette tip to remove any drops of fluid that adhere to the walls of the tube.

It is best to save the supernatant from valuable DNA samples until recovery of the precipitated DNA has been verified.

- Fill the tube half way with 70% ethanol and recentrifuge at maximum speed for 2 minutes at 4°C in a microfuge.
- Repeat step 5.
- Store the open tube on the bench at room temperature until the last traces of fluid have evaporated.

It was once common practice to dry pellets of nucleic acid in a lyophilizer. This step is not only unnecessary, but also undesirable, since it causes denaturation of small (<400-nucleotide) fragments of DNA (Svaren et al. 1987) and greatly reduces the recovery of larger fragments of DNA.

- Dissolve the DNA pellet (which is often invisible) in the desired volume of buffer (usually TE [pH between 7.6 and 8.0]). Rinse the walls of the tube well with the buffer.

**NOTES**

- After centrifugation in a microfuge, not all of the DNA is deposited on the bottom of the microfuge tube. Up to 50% of the DNA is smeared on the wall of the tube. To recover all of the DNA, it is necessary to work a bead of fluid backward and forward over the appropriate quadrant of wall. This step can easily be done by pushing the bead of fluid over the surface with a disposable pipette tip attached to an automatic micropipettor.
- One volume of isopropanol <math>\langle ! \rangle</math> may be used in place of 2 volumes of ethanol to precipitate DNA. Precipitation with isopropanol has the advantage that the volume of liquid to be centrifuged is smaller. However, isopropanol is less volatile than ethanol and is therefore more difficult to remove; moreover, solutes such as sucrose or sodium chloride are more easily coprecipitated with DNA when isopropanol is used. In general, precipitation with ethanol is preferable, unless it is necessary to keep the volume of fluid to a minimum.
- In general, DNA precipitated from solution by ethanol can be redissolved easily in buffers of low ionic strength, such as TE (pH 8.0). Occasionally, difficulties arise when buffers containing  $\text{MgCl}_2$  or  $>0.1 \text{ M NaCl}$  are added directly to the DNA pellet. It is therefore preferable to dissolve the DNA in a small volume of low-ionic-strength buffer and to adjust the composi-

tion of the buffer later. If the sample does not dissolve easily in a small volume, add a larger volume of buffer and repeat the precipitation with ethanol. The second precipitation may help eliminate additional salts or other components that may be preventing dissolution of the DNA.

### Precipitation of RNA with Ethanol

RNA is efficiently precipitated with 2.5–3.0 volumes of ethanol from solutions containing 0.8 M LiCl, 5 M ammonium acetate, or 0.3 M sodium acetate. The choice among these salts is determined by the way in which the RNA will be used later. Since the potassium salt of dodecyl sulfate is extremely insoluble, avoid potassium acetate if the precipitated RNA is to be dissolved in buffers that contain SDS, for example, buffers that are used for chromatography on oligo(dT)-cellulose. For the same reason, avoid potassium acetate if the RNA is already dissolved in a buffer containing SDS. Avoid LiCl when the RNA is to be used for cell-free translation or reverse transcription. LiCl ions inhibit initiation of protein synthesis in most cell-free systems and suppress the activity of RNA-dependent DNA polymerase.

#### NOTE

- Solutions used for precipitation of RNA must be free of RNase (please see Chapter 7).

### Precipitation of Large RNAs with Lithium Chloride

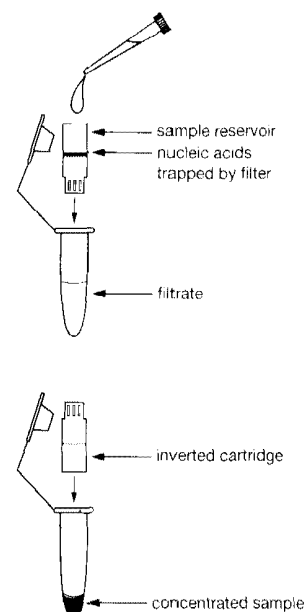
Whereas small RNAs (tRNAs and 5S RNAs) are soluble in solutions of high ionic strength, large RNAs (e.g., rRNAs and mRNAs) are insoluble and can be removed by centrifugation.

1. Measure the volume of the sample and add 0.2 volume of RNase-free 8 M LiCl. Mix the solution well and store it on ice for at least 2 hours.
2. Centrifuge the solution at 15,000g for 20 minutes at 0°C. Discard the supernatant, and dissolve the precipitated high-molecular-weight RNA in 0.2 volume of H<sub>2</sub>O.
3. Repeat Steps 1 and 2.
4. Recover the high-molecular-weight RNA from the resuspended pellet by precipitation with 2 volumes of ethanol.

### Concentrating and Desalting Nucleic Acids with Microconcentrators

Ultrafiltration is an alternative to ethanol precipitation for the concentration and desalting of nucleic acid solutions. It requires no phase change and is particularly useful for dealing with very low concentrations of nucleic acids. The Microcon cartridge, supplied by Millipore, is a centrifugal ultrafiltration device that can desalt and concentrate nucleic acid samples efficiently. The protocol presented below and the accompanying notes have been adapted from those provided on the Millipore Web Site ([www.millipore.com](http://www.millipore.com)). Complete directions may be found on this Web Site.

1. Select a Microcon unit with a nucleotide cut-off equal to or smaller than the molecular size of the nucleic acid of interest (please see Table A8-3).
2. Insert the Microcon cartridge into one of the two vials supplied, as shown in Figure A8-3.
3. To concentrate (without affecting salt concentration), pipette up to 500 µl of sample (DNA or RNA) into the reservoir. Centrifuge for the recommended time, not exceeding the g force shown in Table A8-3.



**FIGURE A8-3 Concentration/Desalting of Nucleic Acid Solutions Using Micron Ultracentrifugation**

4. To exchange salt, add the proper amount of appropriate diluent to bring the concentrated sample to 500  $\mu\text{l}$ . Centrifuge for the recommended time, not exceeding the g force shown in Table A8-3. To achieve a lower salt concentration, repeat the entire step as necessary. Please see the footnote below to Table A8-3.
  - ▲ **IMPORTANT** Do not overfill the filtrate vial.
5. Remove the reservoir from the vial and invert the reservoir into a new vial (save the filtrate until the sample has been analyzed).
6. Centrifuge at 500–1000g for 2 minutes in a microfuge to recover nucleic acid in the vial.
7. Remove reservoir. Cap the vial to store the sample.

**TABLE A8-3 Nucleotide Cut-offs for Microcon Concentrators**

MICROCON MODEL	COLOR CODE	NUCLEOTIDE CUT-OFF <sup>a</sup>		MAXIMUM RECOMMENDED g FORCE	SPIN TIME IN MINUTES	
		SS	DS		4°C	25°C
3	yellow	10	10	14,000	185	95
10	green	30	20	14,000	50	35
30	clear	60	50	14,000	15	8
50	rose	125	100	14,000	10	6
100	blue	300	125	500	25	15

Note that ultrafiltration alone does not change buffer composition. The salt concentration in a sample concentrated by spinning in a Microcon will be the same as that in the original sample. For desalting, the concentrated sample is diluted with  $\text{H}_2\text{O}$  or buffer to its original volume and spun again (called discontinuous diafiltration). This removes the salt by the concentration factor of the ultrafiltration. For example, if a 500- $\mu\text{l}$  sample containing 100 mM salt is concentrated to 25  $\mu\text{l}$  (20x concentration factor), 95% of the total salt in the sample will be removed. The salt concentration in the sample will remain at 100 mM. Rediluting the sample to 500  $\mu\text{l}$  in  $\text{H}_2\text{O}$  will bring the salt concentration to 5 mM. Concentrating to 25  $\mu\text{l}$  once more will remove 99% of the original total salt. The concentrated sample will now be in 0.25 mM salt. For more complete salt removal, an additional redilution and spinning cycle will remove 99.9% of the initial salt content.

<sup>a</sup>ss indicates single-stranded and ds indicates double-stranded.

## Concentrating Nucleic Acids by Extraction with Butanol

During extraction of aqueous solutions with solvents such as secondary butyl alcohol (isobutanol) or *n*-butyl alcohol (*n*-butanol), some of the water molecules are partitioned into the organic phase. By carrying out several cycles of extraction, the volume of a nucleic acid solution can be reduced significantly. This method of concentration is used to reduce the volume of dilute solutions to the point where the nucleic acid can be recovered easily by precipitation with ethanol.

1. Measure the volume of the nucleic acid solution and add an equal volume of isobutanol. Mix the solution well by vortexing.

Addition of too much isobutanol can result in removal of all the H<sub>2</sub>O and precipitation of the nucleic acid. If this happens, add H<sub>2</sub>O to the organic phase until an aqueous phase (which should contain the nucleic acid) reappears.

2. Centrifuge the solution at maximum speed for 20 seconds at room temperature in a microfuge or at 1600g for 1 minute in a benchtop centrifuge. Use an automatic micropipettor to remove and discard the upper (isobutanol) phase.

3. Repeat Steps 1 and 2 until the desired volume of aqueous phase is achieved.

Because isobutanol extraction does not remove salt, the salt concentration increases in proportion to the reduction in the volume of the solution. The nucleic acid can be transferred to the desired buffer by spun-column chromatography or by precipitation with ethanol.

## QUANTITATION OF NUCLEIC ACIDS

**CAUTION:** Please see Appendix 12 for appropriate handling of materials marked with <!>.

Two types of methods are widely used to measure the amount of nucleic acid in a preparation. If the sample is pure (i.e., without significant amounts of contaminants such as proteins, phenol, agarose, or other nucleic acids), spectrophotometric measurement of the amount of UV irradiation absorbed by the bases is simple and accurate. If the amount of DNA or RNA is very small or if the sample contains significant quantities of impurities, the amount of nucleic acid can be estimated from the intensity of fluorescence emitted by ethidium bromide or Hoechst 33258. A summary of the methods commonly used to measure the concentrations of DNA in solution are listed in Table A8-4. More detailed discussion of the methods follows after the table.

**TABLE A8-4 Measuring Nucleic Acid Concentrations**

METHOD	INSTRUMENT	COMMENTS
Absorbance at 260 nm	spectrophotometer	<p>Useful only for highly purified preparations of nucleic acid, since it detects any compound that absorbs significantly at 260 nm, which includes, for example, DNA, RNA, EDTA, and phenol. The ratio of absorbance at 260 nm and 280 nm is often used as a test for contamination of a preparation of DNA and RNA with protein. Despite its popularity, this test is of questionable worth. Nucleic acids absorb so strongly at 260 nm that only a significant level of protein contamination will cause a significant change in the ratio of absorbance at the two wavelengths (Warburg and Christian 1942; Glasel 1995; Manchester 1995, 1996; Wilfinger et al. 1997) (please see the panel on <b>ABSORPTION SPECTROSCOPY OF NUCLEIC ACIDS</b> on the following page).</p> <p>The specific absorption coefficients of both DNA and RNA are affected by the ionic strength and the pH of the solution (Beaven et al. 1955; Wilfinger et al. 1997). Accurate measurements of concentration can be made only when the pH is carefully controlled and the ionic strength of the solution is low.</p> <p>It is difficult to measure the absorbance of small volumes of solution and the method is reliable only over a fairly narrow range of concentrations (5 µg/ml to 90 µg/ml).</p>
Emission at 458 nm in the presence of Hoechst 33258	fluorometer	<p>Hoechst 33258 is one of a class of <i>bis</i>-benzimidazole fluorescent dyes that bind nonintercalatively and with high specificity to double-stranded DNA. After binding, the fluorescent yield increases from 0.01 to 0.6 (Latt and Wöhlleb 1975); Hoechst 33258 is therefore a useful fluorochrome for fluorometric detection and quantitation of double-stranded DNA. Hoechst 33258 interacts preferentially with A/T-rich regions of the DNA helix, with the log<sub>10</sub> of the intensity of fluorescence increasing in proportion to the A+T content of the DNA (Daxhelet et al. 1989). The fluorescent yield of Hoechst 33258 is approximately threefold lower with single-stranded DNA (Hilwig and Gropp 1975).</p> <p>Fluorometry assays with Hoechst 33258 do not work at extremes of pH and are affected by both detergents and salts (Van Lancker and Gheysens 1986). Assays are therefore usually carried out in 0.2 M NaCl, 10 mM EDTA at pH 7.4. The concentration of DNA in the unknown sample is estimated from a standard curve constructed using a set of reference DNAs (10–250 ng/ml) whose base composition is the same as the unknown sample. The intensity of emission is nearly linear over a 1000-fold range of DNA concentrations.</p> <p>The DNAs must be of high molecular weight since Hoechst 33258 does not bind efficiently to small fragments of DNA. All DNAs and solutions must be free of ethidium bromide, which quenches the fluorescence of Hoechst 33258. However, because Hoechst 33258 has little affinity for proteins or rRNA, measurements can be carried out using cell lysates or purified preparations of DNA (Cesarone et al. 1979, 1980; Labarca and Paigen 1980).</p>
Dipstick (a kit from Invitrogen)		<p>This method is good only for solutions containing low concentrations of DNA and RNA (&lt;10 µg/ml), and is both expensive and relatively slow (30–40 minutes).</p>
Ethidium bromide spot test	UV transilluminator	<p>A fast and sensitive method that utilizes the UV-induced fluorescence emitted by intercalated ethidium bromide molecules. The DNA preparations under test are spotted onto an agarose plate containing 0.5 µg/ml ethidium bromide. A series of DNAs of known concentration are used as standards. Because the amount of fluorescence is proportional to the total mass of DNA, the quantity of DNA can be estimated by comparing the light emitted at 590 nm by the test preparations and the standards. The results of the assay can be recorded on film. In a similar, older test, developed in the early 1970s, DNA samples and standards are spotted onto a sheet of Saran Wrap, mixed with a dilute solution of ethidium bromide, and photographed.</p> <p>The chief problem with the method is that it is sensitive to interference by RNA.</p>



## Spectrophotometry of DNA or RNA

For quantitating the amount of DNA or RNA, readings are taken at wavelengths of 260 nm and 280 nm. The reading at 260 nm allows calculation of the concentration of nucleic acid in the sample. An OD of 1 corresponds to ~50 µg/ml for double-stranded DNA, 40 µg/ml for single-stranded DNA and RNA, and ~33 µg/ml for single-stranded oligonucleotides. The ratio between the readings at 260 nm and 280 nm ( $OD_{260}:OD_{280}$ ) provides an estimate of the purity of the nucleic acid. Pure preparations of DNA and RNA have  $OD_{260}:OD_{280}$  values of 1.8 and 2.0, respectively. If there is significant contamination with protein or phenol, the  $OD_{260}:OD_{280}$  will be less than the values given above, and accurate quantitation of the amount of nucleic acid will not be possible.

Because it is rapid, simple, and nondestructive, absorption spectroscopy has long been the method of choice to measure the amount of DNA and RNA in concentrated pure solutions. However, absorption spectroscopy is comparatively insensitive and, with most laboratory spectrophotometers, nucleic acid concentrations of at least 1 µg/ml are required to obtain reliable estimates of  $A_{260}$ . In addition, absorption spectroscopy cannot readily distinguish between DNA and RNA, and it cannot be used with crude preparations of nucleic acids. Because of these limitations, a number of alternative methods have been devised to measure the concentration of DNA and RNA (please see Table A8-4).

### ABSORPTION SPECTROSCOPY OF NUCLEIC ACIDS

Purines and pyrimidines in nucleic acids absorb UV light. As described by the Beer-Lambert Law, the amount of energy absorbed at a particular wavelength is a function of the concentration of the absorbing material:

$$I = I_0 10^{-\epsilon dc}$$

where  $I$  = intensity of transmitted light  
 $I_0$  = intensity of incident light  
 $\epsilon$  = molar extinction coefficient (also known as the molar absorption coefficient)  
 $d$  = optical path length (in cm)  
 $c$  = concentration of absorbing material (mole/liter)

$\epsilon$  is numerically equal to the absorbance of a 1 M solution in a 1-cm light path and is therefore expressed in  $M^{-1} \text{ cm}^{-1}$ . Absorbance data are collected using a UV spectrometer and are generally reported as the absorbance  $A$  ( $\log I/I_0$ ). When  $D = 1$  cm,  $A$  is called the optical density or OD at a particular wavelength,  $\lambda$ .

$$OD_\lambda = \epsilon c$$

Because the absorption spectra of DNA and RNA are maximal at 260 nm, absorbance data for nucleic acids are almost always expressed in  $A_{260}$  or  $OD_{260}$  units. For double-stranded DNA, one  $A_{260}$  or  $OD_{260}$  unit corresponds to a concentration of 50 µg/ml. The Beer-Lambert law is valid at least to an  $OD = 2$  and the concentration of a solution of nucleic acid is therefore easily calculated by simple interpolation. For example, a solution whose  $OD_{260} = 0.66$  contains 33 µg/ml of double-stranded DNA. For nucleic acids,  $\epsilon$  decreases as the ring systems of adjacent purines and pyrimidines become stacked in a polynucleotide chain. The value of  $\epsilon$  therefore decreases in the following series:

free base  
 ↓  
 small oligonucleotides  
 ↓  
 single-stranded nucleic acids  
 ↓  
 double-stranded nucleic acids

This means that single-stranded nucleic acids have a higher absorbance at 260 nm than double-stranded nucleic acids. Thus, the molar extinction coefficient of double-stranded DNA at 260 nm is 6.6, whereas the molar extinction coefficient of single-stranded DNA and RNA is ~7.4. Note, however, that the extinction coefficients of both DNA and RNA are affected by the ionic strength and the pH of the solution (Beaven et al. 1955; Wilfinger et al. 1997). Accurate measurements of concentration can be made only when the pH is carefully controlled and the ionic strength of the solution is low.

(Continued on facing page.)

The extinction coefficients of nucleic acids are the sum of the extinction coefficients of each of their constituent nucleotides. For large molecules, where it is both impractical and unnecessary to sum the coefficients of all the nucleotides, an average extinction coefficient is used. For double-stranded DNA, the average extinction coefficient is  $50 (\mu\text{g/ml})^{-1} \text{ cm}^{-1}$ ; for single-stranded DNA or RNA, the average coefficient is  $38 (\mu\text{g/ml})^{-1} \text{ cm}^{-1}$ . These values mean that

$$\begin{aligned} &1 \text{ OD}_{260} \text{ unit equals} \\ &50 \mu\text{g/ml double-stranded DNA} \\ &\text{or} \\ &38 \mu\text{g/ml single-stranded DNA or RNA} \end{aligned}$$

For small molecules such as oligonucleotides, it is best to calculate an accurate extinction coefficient from the base composition. Because the concentrations of oligonucleotides are commonly reported as mmole/liter, a millimolar extinction coefficient ( $E$ ) is conventionally used in the Beer-Lambert equation.

$$E = A (15.3) + G (11.9) + C (7.4) + T (9.3)$$

where  $A$ ,  $G$ ,  $C$ , and  $T$  are the number of times each nucleotide is represented in the sequence of the oligonucleotide. The numbers in parentheses are the molar extinction coefficients for each deoxynucleotide at pH 7.0.

### OD<sub>260</sub>:OD<sub>280</sub> Ratios

Although it is possible to estimate the concentration of solutions of nucleic acids and oligonucleotides by measuring their absorption at a single wavelength (260 nm), this is not good practice. The absorbance of the sample should be measured at several wavelengths since the ratio of absorbance at 260 nm to the absorbance at other wavelengths is a good indicator of the purity of the preparation. Significant absorption at 230 nm indicates contamination by phenolate ion, thiocyanates, and other organic compounds (Stulnig and Amberger 1994), whereas absorption at higher wavelengths (330 nm and higher) is usually caused by light scattering and indicates the presence of particulate matter. Absorption at 280 nm indicates the presence of protein, because aromatic amino acids absorb strongly at 280 nm.

For many years, the ratio of the absorbance at 260 nm and 280 nm (OD<sub>260</sub>:OD<sub>280</sub>) has been used as a measure of purity of isolated nucleic acids. This method dates from Warburg and Christian (1942) who showed that the ratio is a good indicator of contamination of protein preparations by nucleic acids. The reverse is not true! Because the extinction coefficients of nucleic acids at 260 nm and 280 nm are so much greater than that of proteins, significant contamination with protein will not greatly change the OD<sub>260</sub>:OD<sub>280</sub> ratio of a nucleic acid solution (please see Table A8-5). Nucleic acids absorb so strongly at 260 nm that only a significant level of protein contamination will cause a significant change in the ratio of absorbance at the two wavelengths (Warburg and Christian 1942; Glasel 1995; Manchester 1995, 1996; Wilfinger et al. 1997).

**TABLE A8-5 Absorbance of Nucleic Acids and Proteins**

% PROTEIN	% NUCLEIC ACID	OD <sub>260</sub> :OD <sub>280</sub>	% PROTEIN	% NUCLEIC ACID	OD <sub>260</sub> :OD <sub>280</sub>
100	0	0.57	45	55	1.89
95	5	1.06	40	60	1.91
90	10	1.32	35	65	1.93
85	15	1.48	30	70	1.94
80	20	1.59	25	75	1.95
75	25	1.67	20	80	1.97
70	30	1.73	15	85	1.98
65	35	1.78	10	90	1.98
60	40	1.81	5	95	1.99
55	45	1.84	0	100	2.00
50	50	1.87			

Using the predicted values in this table, Glasel (1995) derived an empirical equation to describe %N for a range of OD<sub>260</sub>:OD<sub>280</sub> ratios: %N =  $F[11.16R - 6.32, [2.16 - R]]$ , where  $R = \text{OD}_{260}:\text{OD}_{280}$ . Note that estimates of purity of nucleic acids based on OD<sub>260</sub>:OD<sub>280</sub> ratios are accurate only when the preparations are free of phenol. Water saturated with phenol absorbs with a characteristic peak at 270 nm and an OD<sub>260</sub>:OD<sub>280</sub> ratio of 2 (Stulnig and Amberger 1994). Nucleic acid preparations free of phenol should have OD<sub>260</sub>:OD<sub>280</sub> ratios of ~1.2.

## Fluorometric Quantitation of DNA Using Hoechst 33258

Measuring the concentration of DNA using fluorometry is simple and more sensitive than spectrophotometry, and allows the detection of nanogram quantities of DNA. The assay can only be used to measure the concentration of DNAs whose sizes exceed ~1 kb, as Hoechst 33258 binds poorly to smaller DNA fragments. In this assay, DNA preparations of known and unknown concentrations are incubated with Hoechst 33258 fluorochrome. Absorption values for the unknown sample are compared with those observed for the known series, and the concentration of the unknown sample is estimated by interpolation.

### HOECHST 33258

Hoechst 33258 is one of a class of *bis*-benzimidazole fluorescent dyes that bind nonintercalatively and with high specificity into the minor groove of double-stranded DNA. After binding, the fluorescent yield increases from 0.01 to 0.6 (Latt and Wohlleb 1975), and Hoechst 33258 can therefore be used for fluorometric detection and quantification of double-stranded DNA in solution. Hoechst 33258 is preferred to ethidium bromide for this purpose because of its greater ability to differentiate double-stranded DNA from RNA and single-stranded DNA (Loontjens et al. 1990).

Like many other nonintercalative dyes (Müller and Gautier 1975), Hoechst 33258 binds preferentially to A/T-rich regions of the DNA helix (Weisblum and Haenssler 1974), with the  $\log_{10}$  of the intensity of fluorescence increasing in proportion to the A+T content of the DNA (Daxhelet et al. 1989). The fluorescent yield of Hoechst 33258 is approximately threefold lower with single-stranded DNA (Hilwig and Gropp 1975).

### Facts and Figures

- Hoechst 33258 in free solution has an excitation maximum at ~356 nm and an emission maximum at 492 nm. However, when bound to DNA, Hoechst 33258 absorbs maximally at 365 nm and emits maximally at 458 nm (Cesarone et al. 1979, 1980).
- Fluorometry assays with Hoechst 33258 do not work at extremes of pH and are affected by both detergents and salts (Van Lancker and Gheysens 1986). Assays are therefore usually carried out under standard conditions (0.2 M NaCl, 10 mM EDTA at pH 7.4). However, two different salt concentrations are required to distinguish double-stranded from single-stranded DNA and RNA (Labarca and Paigen 1980). The concentration of DNA in the unknown sample is estimated from a standard curve constructed using a set of reference DNAs (10–250 ng/ml) whose base composition is the same as the unknown sample. The DNAs must be of high molecular weight since Hoechst 33258 does not bind efficiently to small fragments of DNA. Measurements should be carried out rapidly to minimize photobleaching and shifts in fluorescence emission due to changes in temperature. Either a fixed wavelength fluorometer (e.g., Hoefer model TKO 100) or a scanning fluorescence spectrometer (e.g., Hitachi Perkin-Elmer model MPF-2A) can be used.
- The concentration of Hoechst 33258 ( $M_r = 533.9$ ) in the reaction should be kept low ( $5 \times 10^{-7}$  M to  $2.5 \times 10^{-6}$  M), since quenching of fluorescence occurs when the ratio of dye to DNA is high (Stokke and Steen 1985). However, two concentrations of dye are sometimes used to extend the dynamic range of the assay.
- All DNAs and solutions should be free of ethidium bromide, which quenches the fluorescence of Hoechst 33258. However, because Hoechst 33258 has little affinity for proteins or rRNA, measurements can be carried out using cell lysates or purified preparations of DNA (Cesarone et al. 1979; Labarca and Paigen 1980).
- Unlike ethidium bromide, Hoechst dyes are cell-permeant.

1. Turn the fluorometer on 1 hour before the assay is carried out to allow the machine to warm up and stabilize.

When bound to high-molecular-weight double-stranded DNA, Hoechst 33258 dye absorbs maximally at 365 nm and emits maximally at 458 nm.

2. Prepare an appropriate amount of diluted Hoechst 33258 dye solution by combining 50  $\mu$ l of concentrated Hoechst 33258 dye solution per 100 ml of fluorometry buffer (please see Appendix 1). Each tube in the DNA assay requires 3 ml of diluted Hoechst 33258 dye solution. Transfer 3 ml of diluted dye solution to an appropriate number of clean glass tubes. Include six extra tubes for a blank and the standard curve.

The concentrated Hoechst 33258 dye solution is prepared in H<sub>2</sub>O at 0.2 mg/ml and can be stored at room temperature in a foil-wrapped test tube.

3. Prepare a standard curve by adding 100, 200, 300, 400, and 500 ng of DNA from the reference stock solution to individual tubes. Mix and read the absorbance on the prewarmed fluorometer of each tube immediately after addition of the DNA.

The reference stock solution of DNA is prepared in TE to a concentration of 100 µg/ml. Because the binding of Hoechst 33258 dye to DNA is influenced by the base composition, the DNA used to construct the standard curve should be from the same species as the test sample.

4. Add 0.1 µl (i.e., 1 µl of a 1:10 dilution), 1.0 µl, and 10 µl of the preparation of DNA, whose concentration is being determined, to individual tubes containing diluted dye solution. Immediately read the fluorescence.
5. Construct a standard curve plotting fluorescence on the ordinate and weight of reference DNA (in ng) on the abscissa. Estimate the concentration of DNA in the unknown sample by interpolation.

If the reading for the unknown DNA solution falls outside that of the standard curve, read the fluorescence of a larger sample or make an appropriate dilution of the sample and repeat the assay.

#### NOTES

- Binding of Hoechst 33258 is adversely influenced by pH extremes, the presence of detergents near or above their critical micelle concentrations, and salt concentrations above 3 M. If these conditions or reagents are used to prepare the DNA and improbable results are obtained in the fluorometry assay, precipitate an aliquot of the DNA with ethanol, rinse the pellet of nucleic acid in 70% ethanol, dissolve the dried pellet in TE, and repeat the assay.
- If the preparation of test DNA is highly viscous, sampling with standard yellow tips may be so inaccurate that the dilutions of unknown DNA will not track with the standard curve. In this case, the best solution is to withdraw two samples (10–20 µl) with an automatic pipettor equipped with a cut-off yellow tip. Each sample is then diluted with ~0.5 ml of TE (pH 8.0) and vortexed vigorously for 1–2 minutes. Different amounts of the diluted samples can then be transferred to the individual tubes containing diluted dye solution. The results obtained from the two sets of samples should be consistent.
- Use scissors or a dog nail clipper (e.g., Fisher) to generate cut-off yellow tips. Alternatively, the tips can be cut with a sharp razor blade. Sterilize the cut-off tips before use, either by autoclaving or by immersion in 70% alcohol for 2 minutes followed by drying in air. Presterilized, purpose-made wide-bore tips can be purchased from a number of commercial companies (e.g., Bio-Rad).

### Quantitation of Double-stranded DNA Using Ethidium Bromide

Sometimes there is not sufficient DNA (<250 ng/ml) to assay spectrophotometrically, or the DNA may be heavily contaminated with other substances that absorb UV irradiation and therefore impede accurate analysis. A rapid way to estimate the amount of DNA in such samples is to use the UV-induced fluorescence emitted by ethidium bromide molecules intercalated into the DNA. Because the amount of fluorescence is proportional to the total mass of DNA, the quantity of DNA in the sample can be estimated by comparing the fluorescent yield of the sample with that of a series of standards. As little as 1–5 ng of DNA can be detected by this method. For more information on ethidium bromide, please see Appendix 9 and Chapter 5, Protocol 2.

## Saran Wrap Method Using Ethidium Bromide or SYBR Gold

1. Stretch a sheet of Saran Wrap over a UV transilluminator or over a sheet of black paper.
2. Spot 1–5  $\mu\text{l}$  of the DNA sample onto the Saran Wrap.
3. Spot equal volumes of a series of DNA concentration standards (0.1, 2.5, 5, 10, and 20  $\mu\text{g}/\text{ml}$ ) in an ordered array on the Saran Wrap.

The standard DNA solutions should contain a single species of DNA approximately the same size as the expected size of the unknown DNA. The DNA standards are stable for many months when stored at  $-20^{\circ}\text{C}$ .

4. Add to each spot an equal volume of TE (pH 7.6) containing 2  $\mu\text{g}/\text{ml}$  ethidium bromide or an equal volume of a 1:5000 dilution of dimethylsulfoxide (DMSO)/SYBR Gold stock. Mix by pipetting up and down with a micropipette.
5. Photograph the spots using short-wavelength UV illumination for ethidium bromide, or 300-nm transillumination for SYBR Gold (please see Chapter 5, Protocol 2). Estimate the concentration of DNA by comparing the intensity of fluorescence in the sample with that of the standard solutions.

## Agarose Plate Method

Contaminants that may be present in the DNA sample can either contribute to or quench the fluorescence. To avoid these problems, the DNA samples and standards can be spotted onto the surface of a 1% agarose slab gel containing ethidium bromide (0.5  $\mu\text{g}/\text{ml}$ ). Allow the gel to stand at room temperature for a few hours so that small contaminating molecules have a chance to diffuse away. Photograph the gel as described in Chapter 5.

## Minigel Method

Electrophoresis through minigels (please see Chapter 5) provides a rapid and convenient way to measure the quantity of DNA and to analyze its physical state at the same time. This is the method of choice if there is a possibility that the samples may contain significant quantities of RNA.

1. Mix 2  $\mu\text{l}$  of the DNA sample with 0.4  $\mu\text{l}$  of Gel-loading buffer IV (bromophenol blue only; please see Table A1-6 in Appendix 1) and load the solution into a slot in a 0.8% agarose minigel containing ethidium bromide (0.5  $\mu\text{g}/\text{ml}$ ).

SYBR Gold is too expensive to use routinely in this technique.

2. Mix 2  $\mu\text{l}$  of each of a series of standard DNA solutions (0, 2.5, 5, 10, 20, 30, 40, and 50  $\mu\text{g}/\text{ml}$ ) with 0.4  $\mu\text{l}$  of Gel-loading buffer IV. Load the samples into the wells of the gel.

The standard DNA solutions should contain a single species of DNA approximately the same size as the expected size of the unknown DNA. The DNA standards are stable for many months when stored at  $-20^{\circ}\text{C}$ .

3. Carry out electrophoresis until the bromophenol blue has migrated  $\sim 1$ –2 cm.
4. Destain the gel by immersing it for 5 minutes in electrophoresis buffer containing 0.01 M  $\text{MgCl}_2$ .
5. Photograph the gel using short-wavelength UV irradiation (please see Chapter 5). Compare the intensity of fluorescence of the unknown DNA with that of the DNA standards and estimate the quantity of DNA in the sample.

## MEASUREMENT OF RADIOACTIVITY IN NUCLEIC ACIDS

**CAUTION:** Please see Appendix 12 for appropriate handling of materials marked with  $\llcorner$ .

Radioactive isotopes  $\llcorner$  are used as tracers to monitor the progress of many reactions used to synthesize DNA and RNA. To calculate the efficiency of such reactions, it is necessary to measure accurately the proportion of the radioactive precursor incorporated into the desired product. This goal can be achieved by two methods: (1) differential precipitation of the nucleic acid products with trichloroacetic acid  $\llcorner$  (TCA) and (2) differential adsorption of the products onto positively charged surfaces (e.g., DE-81 paper).

### Precipitation of Nucleic Acids with Trichloroacetic Acid

1. Use a soft-lead pencil to label the appropriate number of Whatman GF/C glass fiber filters (2.4-cm diameter). Impale each of the filters on a pin stuck into a polystyrene support.
2. Spot an accurately known volume (up to 5  $\mu$ l) of each sample to be assayed on the center of each of two labeled filters.

One of the filters is used to measure the total amount of radioactivity in the reaction (i.e., acid-soluble and acid-precipitable radioactivity). The other filter is used to measure only the acid-precipitable radioactivity. Under the conditions described, DNA and RNA molecules  $>50$  nucleotides long will be precipitated on the surface of the filter.

3. Store the filters at room temperature until all of the fluid has evaporated. This process can be accelerated by using a heat lamp, although this is not usually necessary.
4. Use blunt-end forceps (e.g., Millipore forceps) to transfer one of each pair of filters to a beaker containing 200–300 ml of ice-cold 5% TCA and 20 mM sodium pyrophosphate. Swirl the filters in the acid solution for 2 minutes, and then transfer them to a fresh beaker containing the same volume of the ice-cold 5% TCA/20 mM sodium pyrophosphate mixture. Repeat the washing two more times.

During washing, the unincorporated nucleotide precursors are eluted from the filters and the radioactive nucleic acids are fixed to them.

Commercially available, vacuum-driven filtration manifolds that hold up to 24 filters may also be used to wash the filters.

5. Transfer the washed filters to a beaker containing 70% ethanol and allow them to remain there briefly. Then dry the filters either at room temperature or under a heat lamp.
6. Insert each of the filters (washed and unwashed) into a scintillation vial. Measure the amount of radioactivity on each filter.

$^{32}\text{P}$  can be detected on dry filters by Cerenkov counting (in the  $^3\text{H}$  channel of a liquid scintillation counter). The efficiency with which Cerenkov radiation can be measured varies from instrument to instrument and also depends on the geometry of the scintillation vials and the amount of  $\text{H}_2\text{O}$  remaining in the filters. With dry filters, the efficiency of Cerenkov counting is  $\sim 25\%$  (one radioactive decay in four can be detected). Alternatively,  $^{32}\text{P}$  can be measured with 100% efficiency by adding a few milliliters of toluene-based scintillation fluid to the dried filters and counting in the  $^{32}\text{P}$  channel of the liquid scintillation counter.

To measure other isotopes ( $^3\text{H}$ ,  $^{14}\text{C}$ ,  $^{35}\text{S}$ ,  $^{33}\text{P}$ , etc.), it is essential to use toluene-based scintillation fluid and the appropriate channel of a liquid scintillation counter. The efficiency of counting these isotopes varies from counter to counter and should be determined for each instrument.

7. Compare the amount of radioactivity on the unwashed filter with the amount on the washed filter, and then calculate the proportion of the precursor that has been incorporated as described in the panel below.

### Adsorption to DE-81 Filters

DE-81 filters are positively charged and strongly adsorb and retain nucleic acids, including oligonucleotides that are too small to be precipitated efficiently with TCA. Unincorporated nucleotides stick less tightly to the filters and can be removed by washing the filter extensively in sodium phosphate. The procedure is essentially identical to that described for precipitation of nucleic acids by TCA, except that the DE-81 filters are washed in 0.5 M  $\text{Na}_2\text{HPO}_4$  (pH 7.0) instead of TCA/sodium pyrophosphate.

#### CALCULATION OF THE SPECIFIC ACTIVITY OF A RADIOLABELED PROBE

To calculate the specific activity of a radiolabeled probe in dpm/ $\mu\text{g}$ , use the following equation:

$$\text{specific activity} = \frac{L (2.2 \times 10^9) (PI)}{m + [(1.3 \times 10^3) (PI) (L/S)]}$$

where

- $L$  = input radioactive label ( $\mu\text{Ci}$ )
- $PI$  = proportion of the precursor that has been incorporated (cpm in washed filter/cpm in unwashed filter, please see above)
- $m$  = mass of template DNA (ng)
- $S$  = specific activity of input label ( $\mu\text{Ci}/\text{nmole}$ )

The numerator of this equation is the product of three terms: the total dpm in the reaction [ $L(2.2 \times 10^6 \text{ dpm}/\mu\text{Ci})$ ]; the proportion of these dpm which were incorporated ( $PI$ ); and a factor to convert the final value for specific activity from dpm/ng to dpm/ $\mu\text{g}$  ( $10^3$ ).

The denominator represents the total mass of DNA (in ng) at the end of the reaction, equal to the starting mass ( $m$ ) plus the mass (in ng) synthesized during the reaction. The latter is calculated from the number of nanomoles of dNMP incorporated [ $(PI)(L/S)$ ] multiplied by four times the average molecular mass of the four dNMPs ( $4 \times 325 \text{ ng}/\text{nmole} = 1.3 \times 10^3 \text{ ng}/\text{nmole}$ ).

#### EXAMPLE:

In a random priming reaction in which 50% of the radioactivity has been incorporated into TCA-precipitable material, from a starting reaction containing 25 ng of template DNA and 50  $\mu\text{Ci}$  of radiolabeled dNTP with a specific activity of 3000 Ci/mmole:  $L = 50 \mu\text{Ci}$ ,  $PI = 0.5$ ,  $m = 25 \text{ ng}$ , and  $S = 3000 \text{ Ci}/\text{mmole}$ .

$$\begin{aligned} \text{specific activity of the probe} &= \frac{50 (2.2 \times 10^9)(0.5)}{25 + [(1.3 \times 10^3)(0.5)(50/3000)]} \\ &= 1.5 \times 10^9 \text{ dpm}/\mu\text{g} \end{aligned}$$

## DECONTAMINATION OF SOLUTIONS CONTAINING ETHIDIUM BROMIDE

CAUTION: Please see Appendix 12 for appropriate handling of materials marked with <!.>.

### Removing Ethidium Bromide from DNA

The reaction between ethidium bromide <!.> and DNA is reversible (Waring 1965), but the dissociation of the complex is very slow and is measured in days rather than minutes or hours. For practical purposes, dissociation is achieved by passing the complex through a small column packed with a cation-exchange resin such as Dowex AG 50W-X8 (Waring 1965; Radloff et al. 1967) or by extracting with organic solvents such as isopropanol (Cozzarelli et al. 1968) or *n*-butanol <!.> (Wang 1969). The former method has been shown to result in the removal of ethidium bromide to a binding ratio below that detectable by fluorescence, a molar ratio of dye:nucleic acid of 1:4000 (Radloff et al. 1967).

### Disposing of Ethidium Bromide

Ethidium bromide itself is not highly mutagenic, but it is metabolized by microsomal enzymes to compound(s) that are moderately mutagenic in yeast and *Salmonella typhimurium* (Mahler and Bastos 1974; McCann et al. 1975; MacGregor and Johnson 1977; Singer et al. 1999). A number of methods have been described to decontaminate solutions and surfaces that contain or have been exposed to ethidium bromide. The concentration of ethidium bromide in solution may be reduced to <0.5 µg/ml with activated charcoal, which can then be incinerated (Menozzi et al. 1990). Alternatively, ethidium bromide can be degraded by treatment with sodium nitrite <!.> and hypophosphorous acid <!.> (Lunn and Sansone 1987).

### Decontamination of Concentrated Solutions of Ethidium Bromide

(solutions containing >0.5 mg/ml)

#### Method 1

This method (Lunn and Sansone 1987) reduces the mutagenic activity of ethidium bromide in the *Salmonella*/microsome assay by ~200-fold.

1. Add sufficient H<sub>2</sub>O to reduce the concentration of ethidium bromide to <0.5 mg/ml.
2. To the resulting solution, add 0.2 volume of fresh 5% hypophosphorous acid and 0.12 volume of fresh 0.5 M sodium nitrite. Mix carefully.

▲ **IMPORTANT** Make sure that the pH of the solution is <3.0.

Hypophosphorous acid is usually supplied as a 50% solution, which is corrosive and must be handled with care. Freshly dilute the acid immediately before use.

Sodium nitrite solution (0.5 M) should be freshly prepared by dissolving 34.5 g of sodium nitrite in H<sub>2</sub>O to a final volume of 500 ml.

3. After incubation for 24 hours at room temperature, add a large excess of 1 M sodium bicarbonate. The solution may now be discarded.

#### Method 2

This method (Quillardet and Hofnung 1988) reduces the mutagenic activity of ethidium bromide in the *Salmonella*/microsome assay by ~3000-fold. However, there are reports (Lunn and Sansone 1987) of mutagenic activity in occasional batches of "blanks" treated with the decontaminating solutions.



1. Add sufficient H<sub>2</sub>O to reduce the concentration of ethidium bromide to <0.5 mg/ml.
2. Add 1 volume of 0.5 M KMnO<sub>4</sub>. Mix carefully, and then add 1 volume of 2.5 N HCl. Mix carefully, and allow the solution to stand at room temperature for several hours.
3. Add 1 volume of 2.5 N NaOH. Mix carefully, and then discard the solution.

### Decontamination of Dilute Solutions of Ethidium Bromide (e.g., electrophoresis buffer containing 0.5 µg/ml ethidium bromide)

#### Method 1

The following method is from Lunn and Sansone (1987).

1. Add 2.9 g of Amberlite XAD-16 (Sigma-Aldrich) for each 100 ml of solution. Amberlite XAD-16 is a nonionic, polymeric absorbent.
2. Store the solution for 12 hours at room temperature, shaking it intermittently.
3. Filter the solution through a Whatman No. 1 filter, and discard the filtrate.
4. Seal the filter and Amberlite resin in a plastic bag, and dispose of the bag in the hazardous waste.

#### Method 2

The following method is from Bensaude (1988).

1. Add 100 mg of powdered activated charcoal for each 100 ml of solution.
2. Store the solution for 1 hour at room temperature, shaking it intermittently.
3. Filter the solution through a Whatman No. 1 filter, and discard the filtrate.
4. Seal the filter and activated charcoal in a plastic bag, and dispose of the bag in the hazardous waste.

#### NOTES

- Treatment of dilute solutions of ethidium bromide with hypochlorite (bleach) is not recommended as a method of decontamination. Such treatment reduces the mutagenic activity of ethidium bromide in the *Salmonella*/microsome assay by ~1000-fold, but it converts the dye into a compound that is mutagenic in the absence of microsomes (Quillardet and Hofnung 1988).
- Ethidium bromide decomposes at 262°C and is unlikely to be hazardous after incineration under standard conditions.
- Slurries of Amberlite XAD-16 or activated charcoal can be used to decontaminate surfaces that become contaminated by ethidium bromide.

### Commercial Decontamination Kits

Several commercial companies sell devices to extract ethidium bromide from solutions with the minimum of fuss and bother. These devices include the EtBr Green Bag (Q•BIOgene) and the Eliminator Dye Removal System (Stratagene).

## GEL-FILTRATION CHROMATOGRAPHY

**CAUTION:** Please see Appendix 12 for appropriate handling of materials marked with <!.>.

This technique, which employs gel filtration to separate high-molecular weight DNA from smaller molecules, is used most often to separate unincorporated labeled dNTPs from DNA that has been radiolabeled. However, it is also used at several stages during the synthesis of double-stranded cDNA, during addition of linkers to blunt-ended DNA, to remove oligonucleotide primers from polymerase chain reaction (PCR), and, in general, whenever it is necessary to change the composition of the buffer in which DNA is dissolved.

Two methods are available: conventional column chromatography, which is used when it is necessary to collect fractions that contain components of different sizes, and centrifugation through gel matrices packed in disposable syringes, which is a rapid method used to free DNA from smaller molecules. The two most commonly used gel matrices are Sephadex and Bio-Gel, both of which are available in several porosities. Sephadex G-50 and Bio-Gel P-60 are ideal for purifying DNA larger than 80 nucleotides in length. Smaller molecules are retained in the pores of the gel, whereas the larger DNA is excluded and passes directly through the column. Bio-Gel P-2 can be used to separate oligonucleotides from phosphate ions or dNTPs. Bio-Gel is supplied in the form of a gel and need only be equilibrated in running buffer before use. Sephadex is supplied as a powder that must be hydrated before use.

### Preparation of Sephadex

1. Slowly add Sephadex of the desired grade to distilled sterile H<sub>2</sub>O in a 500-ml beaker or bottle (10 g of Sephadex G-50 granules yields 160 ml of slurry). Wash the swollen resin with distilled sterile H<sub>2</sub>O several times to remove soluble dextran, which can create problems by precipitating during ethanol precipitation.
2. Equilibrate the resin in TE (pH 7.6), autoclave at 10 psi (0.70 kg/cm<sup>2</sup>) for 15 minutes, and store at room temperature.

### Column Chromatography

1. Prepare Sephadex or Bio-Gel columns in disposable 5-ml borosilicate glass pipettes or Pasteur pipettes plugged with a small amount of sterile glass wool. Use a long, narrow pipette (e.g., a disposable 1-ml plastic pipette) to push the wool to the bottom of the glass or Pasteur pipette.
2. Use a Pasteur pipette to fill the column with a slurry of the Sephadex or Bio-Gel, taking care to avoid producing bubbles. There is no need to close the bottom of the column. Keep adding gel until it packs to a level 1 cm below the top of the column. Wash the gel with several volumes of 1x TEN buffer (pH 8.0) (please see Appendix 1).
3. Apply the DNA sample (in a volume of 200  $\mu$ l or less) to the top of the gel. Wash out the sample tube with  $\sim$ 100  $\mu$ l of 1x TEN buffer, and load the washing on the column as soon as the DNA sample has entered the gel. When the washing has entered the gel, immediately fill the column with 1x TEN buffer.

▲ **WARNING** Columns used to separate radiolabeled DNA from radioactive precursors should be run behind Lucite screens to protect against exposure to radioactivity.

4. Immediately start to collect fractions (~200  $\mu$ l) in microfuge tubes.

If the DNA is labeled with  $^{32}\text{P}$  <math>\langle ! \rangle</math>, measure the radioactivity in each of the tubes by using either a hand-held minimonitor or by Cerenkov counting in a liquid scintillation counter. Add more 1x TEN buffer to the top of the gel as required from time to time.

The DNA will be excluded from the gel and will be found in the void volume (usually 30% of the total column volume). The leading peak of radioactivity therefore consists of nucleotides incorporated into DNA, and the trailing peak consists of unincorporated [ $^{32}\text{P}$ ]dNTPs.

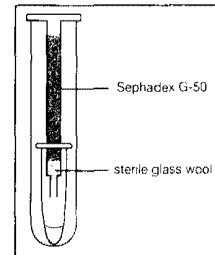
5. Pool the radioactive fractions in the leading peak and store at  $-20^{\circ}\text{C}$ .**NOTES**

Instead of collecting individual fractions, it is possible with practice to follow the progress of the incorporated and unincorporated [ $^{32}\text{P}$ ]dNTPs down the column using a hand-held minimonitor.

- Collect the leading peak into a sterile polypropylene tube as it elutes from the column.
- Clamp the bottom of the column and disconnect the buffer reservoir.
- Discard the column in the radioactive waste.

**Spun-column Chromatography**

This method is used to separate DNA, which passes through the gel-filtration matrix, from lower-molecular-weight substances that are retained on the column. Spun-column chromatography is particularly useful when separating labeled DNA from radioactive precursors. However, it is also used extensively for other purposes, for example, to remove unwanted nucleotide primers or double-stranded linkers, to change the buffer in which small amounts of DNA are dissolved, or to free crude preparations of minipreparations of plasmid or bacteriophage DNA from inhibitors that prevent cleavage by restriction enzymes. Several samples of DNA can be handled simultaneously. In this respect, spun-column chromatography is much superior to conventional column chromatography.



1. Plug the bottom of a 1-ml disposable syringe with a small amount of sterile glass wool. This is best accomplished by using the barrel of the syringe to tamp the glass wool in place.
2. Fill the syringe with Sephadex G-50 or Bio-Gel P-60, equilibrated in 1x TEN buffer (pH 8.0) (please see Appendix 1). Start the buffer flowing by tapping the side of the syringe barrel several times. Keep adding more resin until the syringe is completely full.
3. Insert the syringe into a 15-ml disposable plastic tube. Centrifuge at 1600g for 4 minutes at room temperature in a swinging-bucket rotor in a bench-top centrifuge. Do not be alarmed by the appearance of the column. The resin packs down and becomes partially dehydrated during centrifugation. Continue to add more resin and recentrifuge until the volume of the packed column is ~0.9 ml and remains unchanged after centrifugation.
4. Add 0.1 ml of 1x TEN buffer to the columns, and recentrifuge as in Step 3.
5. Repeat Step 4 twice more.

Spun columns may be stored at this stage if desired. Several spun columns can be prepared simultaneously and stored at  $4^{\circ}\text{C}$  for periods of 1 month or more before being used. Fill the syringes with 1x TEN buffer and wrap Parafilm around them to prevent evaporation. Store the columns upright at  $4^{\circ}\text{C}$ . Spun columns stored in this way should be washed once with sterile 1x TEN buffer as described in Step 4 just before they are used.

6. Apply the DNA sample to the column in a total volume of 0.1 ml (use 1× TEN buffer to make up the volume). Place the spun column in a fresh disposable tube containing a decapped microfuge tube (please see figure above).
7. Centrifuge again as in Step 3, collecting the effluent from the bottom of the syringe (~100 µl) into the decapped microfuge tube.
8. Remove the syringe, which will contain unincorporated radiolabeled dNTPs or other small components. Using forceps, carefully recover the decapped microfuge tube, which contains the eluted DNA, and transfer its contents to a capped, labeled microfuge tube.

A rough estimate of the proportion of radioactivity that has been incorporated into nucleic acid may be obtained by holding the syringe and the eluted DNA to a hand-held minimonitor.
9. If the syringe is radioactive <!-- -->, carefully discard it in the radioactive waste. Store the eluted DNA at -20°C until needed.

#### **NOTE**

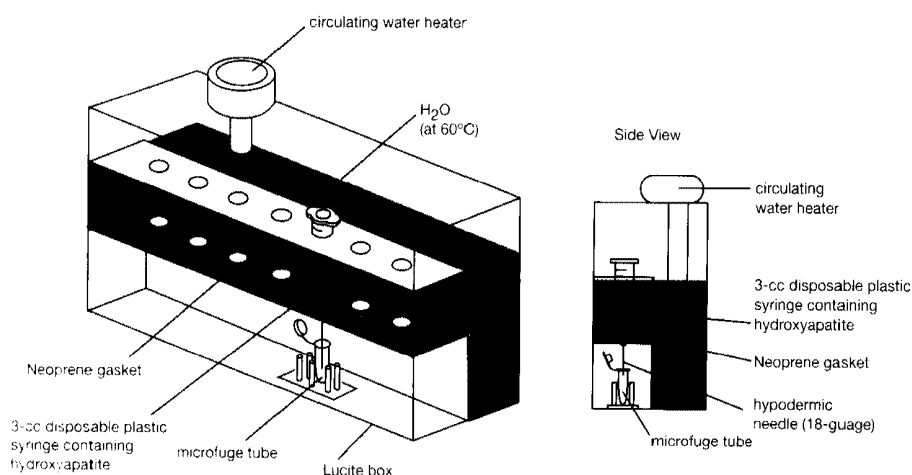
- Not all resins are suitable for spun-column centrifugation: DEAE-Sephacel forms an impermeable lump during centrifugation, and the larger grades of Sephadex (G-100 and up) cannot be used because the beads are crushed by centrifugation. If a coarser-sieving resin is required, use Sepharose CL-4B.

## SEPARATION OF SINGLE-STRANDED AND DOUBLE-STRANDED DNAs BY HYDROXYAPATITE CHROMATOGRAPHY

Nucleic acids bind to hydroxyapatite by virtue of interactions between the phosphate groups of the polynucleotide backbone and calcium residues in the matrix. Bound nucleic acids can be eluted in phosphate buffers. This step is usually carried out at 60°C, although there is no good reason to do so since the adsorption and elution profiles of nucleic acids are indistinguishable between 25°C and 60°C. The affinity of nucleic acids is determined by the number of phosphate groups that are available to bind to the matrix. Both single- and double-stranded nucleic acids bind to hydroxyapatite in 0.05 M sodium phosphate (pH 6.8). Double-stranded molecules, with their well-ordered and evenly spaced sets of phosphate residues, make many regular contacts with the matrix and therefore require high concentrations of phosphate (0.4 M) for elution. Single-stranded molecules are more disordered and a smaller proportion of their phosphate residues are available for contact with the matrix. Hence, single-stranded DNA is eluted in lower concentrations of phosphate (~0.12 M). Partial duplexes and DNA-RNA hybrid molecules elute at intermediate concentrations.

Nucleic acids are often eluted in such large volumes that they need to be concentrated before they can be used. Ethanol precipitation must be avoided until the phosphate ions have been removed from the solution. This is best achieved by concentrating the eluate by extraction with isobutanol and then removing the salt by chromatography through G-50 Sephadex columns.

Batches of hydroxyapatite vary slightly in their characteristics, and it is therefore important to carry out preliminary experiments to determine the optimal phosphate concentrations for elution of single- and double-stranded nucleic acids. This can be accomplished by setting up two hydroxyapatite columns as described below. One of the columns is loaded with a small amount (~10<sup>5</sup> cpm) of <sup>32</sup>P-labeled DNA that has been denatured by boiling for 10 minutes in TE (pH 7.6). The other column receives an equal amount (~10<sup>5</sup> cpm) of <sup>32</sup>P-labeled native DNA. Each of the columns is washed with a series of buffers containing increasing concentrations of sodium phosphate (0.01, 0.12, 0.16, 0.20, 0.24, 0.28, 0.32, 0.36, and 0.40 M). The amount of radioactivity eluting at each phosphate concentration is then measured in a liquid scintillation counter (either by Cerenkov counting or in a water-miscible fluor). Usually, single-stranded DNA elutes in 0.14–0.16 M sodium phosphate (pH 6.8), whereas double-stranded DNA is not removed from the column until the phosphate concentration exceeds 0.36 M. In the protocol that follows, SS buffer contains the phosphate concentration that is optimal for elution of single-stranded DNA; DS buffer contains the concentration that is optimal for elution of double-stranded DNA.



**FIGURE A8-4** Apparatus for Hydroxyapatite Chromatography

**HYDROXYAPATITE CHROMATOGRAPHY**

Hydroxyapatite ( $\text{Ca}_5[\text{PO}_4]_3\text{OH}$ ), the most stable of all calcium phosphates precipitated from aqueous solution, was originally developed as a matrix for protein chromatography by Tiselius et al. (1956). Semenza (1957), working in the Tiselius laboratory, and Main and Cole (1957; Main et al. 1959) seem to have been the first to use hydroxyapatite to fractionate nucleic acids. However, it was work in Bernardi's laboratory (Bernardi 1961, 1965; Bernardi and Timasheff 1961) that led to the widespread and successful use of hydroxyapatite columns to separate single-stranded from double-stranded nucleic acids and to fractionate complex nucleic acids by thermal elution according to their content of (G+C) (Martinson and Wagenaar 1974). During the 1960s and 1970s, hydroxyapatite chromatography became the standard method to investigate the reassociation kinetics of DNAs from many different sources (Britten and Kohne 1966, 1967, 1968; Britten et al. 1974), to construct transcription maps (Sambrook et al. 1972), and to measure the copy number of specific sequences in complex genomes (Gelb et al. 1971; Gallimore et al. 1974). More recently, hydroxyapatite has been used in the preparation of cDNA for subtractive cloning (Davis 1986), as well as for a variety of more menial chores, for example, the isolation of DNA from low-melting-temperature agarose (Wilkie and Cortini 1976) and the removal of contaminants from DNA preparations (Smith 1980). During the decade that led to the development of molecular cloning, hydroxyapatite chromatography was in daily use in many laboratories for a variety of manipulations involving nucleic acids both preparative and analytical. However, there are now better ways to carry out almost all of these tasks, and hydroxyapatite chromatography has all but disappeared from the standard repertoire of laboratory techniques..

1. Determine the concentrations of sodium phosphate that are optimal for elution of single-stranded DNA (SS buffer) and double-stranded DNA (DS buffer) as described above.
2. Prepare SS and DS buffers by diluting 2 M sodium phosphate (pH 6.8).
 

2 M sodium phosphate (pH 6.8) is made by mixing equal volumes of 2 M  $\text{NaH}_2\text{PO}_4$  and 2 M  $\text{Na}_2\text{HPO}_4$ .
3. Suspend the hydroxyapatite powder (Bio-Gel HTP) in 0.01 M sodium phosphate (pH 6.8). Approximately 0.5 ml of packed Bio-Gel HTP is required for each column.
 

Bio-Gel HTP has a capacity of 100–200  $\mu\text{g}$  of native DNA/ml of bed volume.
4. Prepare the hydroxyapatite columns in disposable 3-cc plastic syringes as follows:
  - a. Remove the barrel from the syringe.
  - b. Use the wide end of a Pasteur pipette to push a Whatman GF/C filter to the bottom of the syringe. The filter should completely cover the bottom of the syringe.
  - c. Attach an 18-gauge hypodermic needle to the syringe.
  - d. Insert the syringe through a Neoprene gasket in the apparatus shown in Figure A8-4.
  - e. Use a Pasteur pipette to add enough of the slurry of hydroxyapatite to the syringe to form a column whose packed volume is 0.5–1.0 ml. Wash the column with several volumes of 0.01 M sodium phosphate (pH 6.8). The column will not be harmed if it runs dry; simply rewet before use.
  - f. Seal the bottom of the column by sticking a small Neoprene stopper on the end of the hypodermic needle.
5. Load the sample containing the nucleic acid onto the column.
 

The concentration of phosphate in the sample should be less than 0.08 M.
6. Remove the Neoprene stopper, and allow the sample to flow through the column.
 

There is usually no need to collect and save the loading buffer that elutes from the column.
7. Wash the column with 3 ml of 0.01 M sodium phosphate.

8. Seal the bottom of the column with a Neoprene stopper, and add 1 column volume of SS buffer preheated to 60°C.
9. After 5 minutes, remove the Neoprene stopper and collect the eluate in microfuge tubes. No more than 0.5 ml should be collected in any one microfuge tube. Repeat Steps 8 and 9 two more times.
10. Seal the bottom of the column with a Neoprene stopper, and add 1 column volume of DS buffer preheated to 60°C.
11. After 5 minutes, remove the Neoprene stopper and collect the eluate in microfuge tubes. No more than 0.5 ml should be collected in any one microfuge tube. Repeat Steps 10 and 11 two more times.
12. Allow the eluates to cool to room temperature. DNA can then be extracted as follows:
  - a. Add an equal volume of isobutanol to each of the tubes containing the desired nucleic acids.
  - b. Mix the two phases by vortexing, and centrifuge the mixture at maximum speed for 20 seconds at room temperature in a microfuge.
  - c. Discard the upper (organic) phase.
  - d. Repeat the extraction with isobutanol until the volume of the aqueous phase is 100–125  $\mu$ l.
  - e. Remove salts from the DNA by chromatography on, or centrifugation through, a small column of Sephadex G-50 equilibrated in TE (pH 8.0).
  - f. Recover the DNA by precipitation with 2 volumes of ethanol at 0°C.

#### **NOTE**

- In molecular cloning, nucleic acids fractionated by hydroxyapatite are usually radiolabeled, and the tubes containing the desired fractions can be easily identified by Cerenkov counting in a liquid scintillation counter.

## FRAGMENTATION OF DNA

The fragmentation of DNA is often a necessary step preceding library construction or subcloning for DNA sequencing. Fragmentation is typically achieved by physical or enzymatic methods; the most commonly used of these are described in Table A8-6. Although each approach is reasonably successful for generating a range of fragments from a large contiguous segment of DNA, each has its particular limitations. Because they are independent of sequence composition, physical methods for shearing DNA typically result in more uniform and random disruption of the target DNA than enzymatic methods. In particular, methods involving hydrodynamic shearing due to physical stress induced by sonication or nebulization produce collections of appropriately random fragments. The variety in lengths of these fragments is quite large, however, and their use usually requires a subsequent size selection step to narrow the range of fragments that are acceptable for cloning or sequencing.

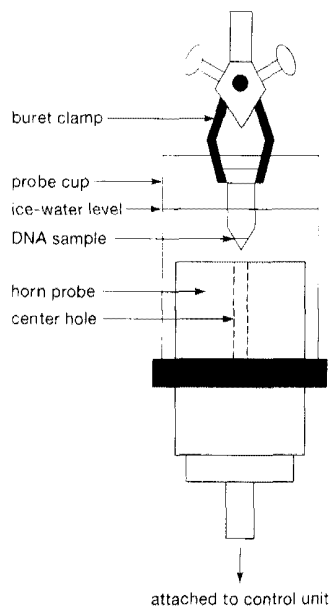
### AUTOMATED SHEARING

During the last few years, a method for hydrodynamic shearing, initially based on the use of high-performance liquid chromatography (HPLC) and called the "point-sink" flow system, has become increasingly refined and, finally, automated (Oefner et al. 1996; Thorstenson et al. 1998). In the point-sink system, an HPLC pump is used to apply pressure to the DNA sample, thereby forcing it through tubing of very small diameter. In the automated process known as HydroShear (commercially available from Gene Machines), a sample of DNA is repeatedly passed through a small hole until the sample is fragmented to products of a certain size. The final size distribution is determined by both the flow rate of the sample and the size of the opening, parameters that are controlled and monitored by the automated system. At any given setting, DNA fragments larger than a certain length are broken, whereas shorter fragments are unaffected by passage through the opening. The resulting sheared products therefore have a narrow size distribution: Typically 90% of the sheared DNA falls within a twofold size range of the target length. It is reasonable to expect that libraries constructed from these DNA fragments are likely to be of higher quality than those made using one of the "old-fashioned" ways. They will certainly contain clones of more uniform size, and possibly may be more comprehensive in their coverage of the genome. However, libraries constructed from sonicated or hydrodynamically sheared DNA, although imperfect, are certainly workable. Perfectionists will feel that the machine is necessary; pragmatists will find it merely desirable.

**TABLE A8-6 Hydrodynamic Shearing Methods Used to Fragment DNA**

METHOD	PROS AND CONS	REFERENCES
Sonication	Requires relatively large amounts of DNA (10–100 µg); fragments of DNA distributed over a broad range of sizes; only a small fraction of the fragments are of a length suitable for cloning and sequencing; requires ligation of DNA before sonication and end-repair afterward; DNA may be damaged by hydroxyl radicals generated during cavitation (McKee et al. 1977).	Deininger (1983)
Nebulization	Easy and quick; requires only small amounts of DNA (0.5–5 µg) and large volumes of DNA solution; no preference for AT-rich regions; size of fragments easily controlled by altering the pressure of the gas blowing through the nebulizer; fragments of DNA distributed over a narrow range of sizes (700–1330 bp); requires ligation of DNA before nebulization and end-repair afterward.	Bodenteich et al. (1994); Hengen (1997)
Circulation through an HPLC pump	Requires expensive apparatus, ligation of DNA before sonication, and 1–100 µg of DNA; fragments of DNA distributed over a narrow range of sizes that can be adjusted by changing the flow rate; end-repair of fragments before cloning not necessary.	Oefner et al. (1996); Thorstenson et al. (1998)
Passage through the orifice of a 28-gauge hypodermic needle	Cheap, easy, and requires only small amounts of DNA; however, the fragments are a little larger (1.5–2.0 kb) than required for shotgun sequencing; requires ligation of DNA before cleavage and end-repair afterward.	Davidson (1959, 1960); Schrieffer et al. (1990)





**FIGURE 8-5 Cup Horn Sonicator for Random Fragmentation of DNA**

The cup horn attachment for a Heat Systems sonicator is depicted with a sample tube in place. The cup horn unit, which contains a large horn probe, is attached to the sonicator control unit and filled with ice water before the sample is sonicated. Typically, the sample tube is held in place from above by using a buret clamp and a ring stand. Alternatively, a tube holder can be fabricated from 1/4-inch plastic and used to hold up to eight tubes for simultaneous processing. (Redrawn, with permission, from Birren et al. 1997.)

## Sonication

DNA samples are subjected to hydrodynamic shearing by exposure to brief pulses of sonication. DNA that has been sonicated for excessive periods of time is extremely difficult to clone, perhaps because of damage caused by free radicals generated by cavitation. Most sonicators will not shear DNA to a size smaller than 300–500 bp, and it is tempting to continue sonication until the entire population of DNA fragments has been reduced to this size. However, the yield of subclones is usually greater if sonication is stopped when the fragments of target DNA first reach a size of ~700 bp.

### Calibration of the Sonicator

1. Transfer 10  $\mu\text{g}$  of bacteriophage  $\lambda$  DNA (or some other large DNA of defined molecular weight) to a microfuge tube. Add TE (pH 7.6) to a final volume of 150  $\mu\text{l}$ . Distribute 25- $\mu\text{l}$  aliquots of the DNA solution into five microfuge tubes. Store the remaining DNA in an ice bath.
2. Fill the cup horn of the sonicator (Figure A8-5) with a mixture of ice and  $\text{H}_2\text{O}$ . Clamp the five microfuge tubes containing the bacteriophage  $\lambda$  DNA just above the probe.

If the temperature of the sample rises during sonication, the speed and vigor of fragmentation will increase. It is therefore important to mix the ice and  $\text{H}_2\text{O}$  after each burst of sonication and to add fresh ice when necessary.

3. Sonicate at maximum output and continuous power for bursts of 10 seconds. After each burst, remove one of the microfuge tubes from the sonicator and store it on ice.
4. After sonication is completed, analyze the size of the DNA fragments in each stored sample by electrophoresis through a 1.4% agarose gel. Use suitable standards for molecular-weight markers (please see Appendix 6, Figure A6-4).
5. Stain and photograph the gel, and then estimate the amount of sonication required to produce a reasonable yield of fragments of the desired size (500 bp to 2 kb).

The times of sonication given in this method are for a cup horn sonicator with a nominal peak output energy of 475 W. Because the actual output of different sonicators varies widely, it is necessary to calibrate each instrument. A probe-type sonicator can be used with a microtip if the volume of the DNA sample is increased to ~250  $\mu\text{l}$  to accommodate the probe. After sonication is completed, concentrate the DNA by precipitation with 2 volumes of ethanol and dissolve in 25  $\mu\text{l}$  of TE (pH 7.6).

### Sonication of Target DNA

6. Sonicate the chosen DNA sample for the length of time estimated to produce a reasonable yield of fragments of the desired size (500 bp to 1 kb). Confirm that the fragmentation has gone according to plan by analyzing an aliquot of the sample (~200 ng) by electrophoresis through a 1.4% agarose gel as described above.

### Nebulization

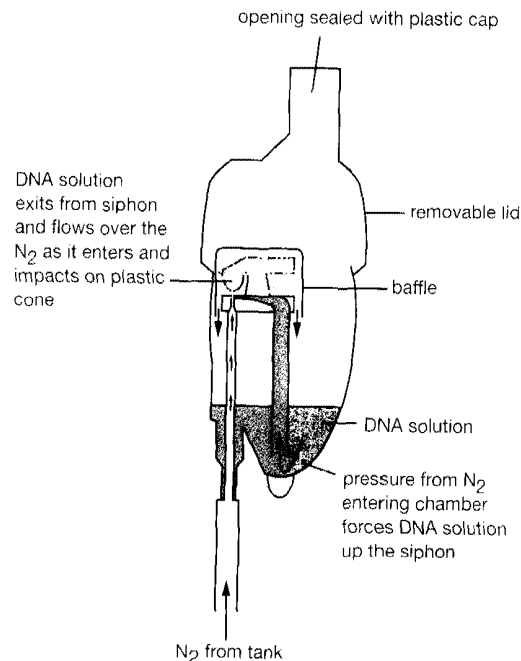
Nebulization is performed by collecting the fine mist created by forcing DNA in solution through a small hole in the nebulizer unit. The size of the fragments is determined chiefly by the speed at which the DNA solution passes through the hole, the viscosity of the solution, and the temperature.

#### Modification of the Nebulizer

1. Modify a nebulizer model number CA-209 (available from CIS-US Inc., Bedford, Massachusetts) by sealing the mouthpiece hole in the top cover with a QS-T plastic cap. Connect a length of Nalgene tubing to the smaller hole. This tubing will be connected to a source of nitrogen gas.

#### Calibration of the Nebulizer

2. Prepare a sample containing 25  $\mu\text{g}$  of bacteriophage  $\lambda$  DNA or other large DNA of defined size in 500  $\mu\text{l}$  of TE (pH 7.6) containing 25% glycerol. Store the DNA solution in an ice bath for 5 minutes.
3. Place the DNA in the cup of a nebulizer connected to a nitrogen gas source and place the nebulizer in an ice-water bath.



**FIGURE A8-6 Nebulizer for Random Fragmentation of DNA**

A DNA solution containing glycerol, for viscosity, is placed in the nebulizer. The nebulizer is attached to a nitrogen tank. Pressure from nitrogen entering the chamber siphons the DNA solution from the bottom of the chamber to the top. The solution exits the siphon and impacts on a small plastic cone suspended near the top of the chamber, thus shearing the DNA.

4. Nebulize the DNA sample at 10 psi (69 KPa) for 90 seconds.  
The nebulizer usually leaks a little.
5. After nebulization is completed, collect the DNA by placing the entire unit in a rotor bucket of a bench-top centrifuge fitted with pieces of Styrofoam to cushion. Centrifuge the nebulizer at 2500 rpm for 30 seconds. Analyze the size of the DNA fragments by electrophoresis through a 1.4% agarose gel with appropriate standards, e.g., the fragments generated by digestion of pUC18/19 DNA with *Sau3AI*. For detail of standards, please see Appendix 6, Table A6-4.
6. If the fragments are too large (>1.0 kb) repeat the procedure increasing either the pressure of the nitrogen gas (to 14 psi or 96.5 KPa) or the length of nebulization (2 minutes). Repeat the procedure until conditions are found that produce a reasonable yield of fragments of the desired size (500 bp to 1 kb).

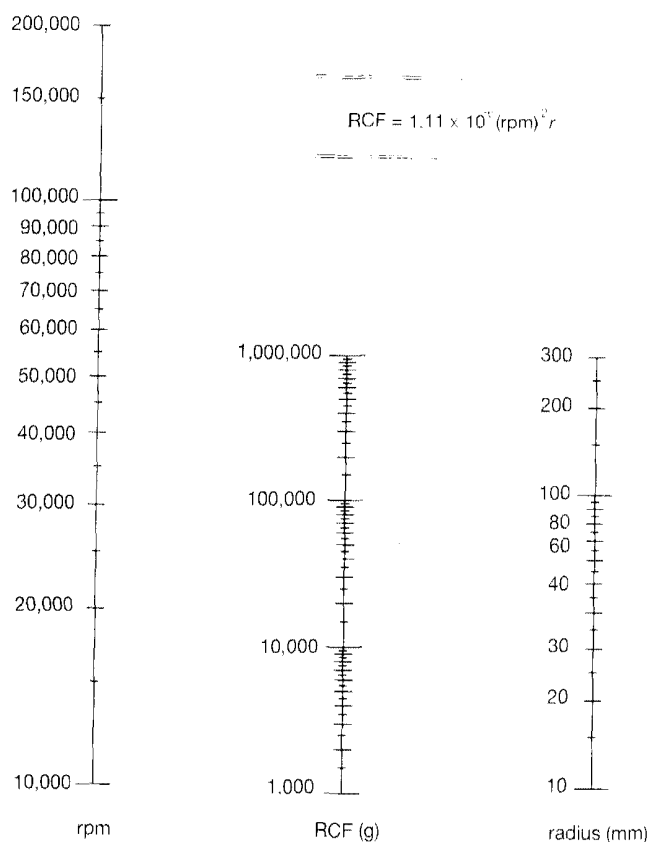
### ***Nebulization and Recovery of the Target DNA***

7. Nebulize the target DNA to produce a reasonable yield of fragments of the desired size (500 bp to 1 kb).
8. Confirm that the fragmentation has gone according to plan by analyzing an aliquot of the sample (~200 ng) by electrophoresis through a 1.4% agarose gel as described above.
9. Distribute the remainder of the sample into two microfuge tubes and recover the DNA by precipitation with 3 volumes of ethanol in the presence of 2.5 M ammonium acetate.
10. Centrifuge the DNA sample at maximum speed for 5 minutes in a microfuge, wash the pellet with 0.5 ml of 70% ethanol at room temperature, and centrifuge again. Remove the ethanol and allow the DNA to dry in the air for a few minutes. Dissolve the pellet of DNA in 25  $\mu$ l of TE (pH 7.6).

## CENTRIFUGATION

**FIGURE A8-7** Nomogram for Conversion of Rotor Speed (rpm) and Relative Centrifugal Force (RCF)

The symbol  $r$  represents the radial distance from the center of the rotor to the point for which RCF is required. This is generally equivalent to  $r_{\max}$  of the rotor. For the example marked, rotor speed = 80,000 rpm and  $r = 20$  mm. RCF can be read as  $\sim 145,000g$  from the middle scale. Using the equation given above, RCF can be calculated as 142,080g. (Figure kindly provided by Siân Curtis.)



**TABLE A8-7** Commonly Used Rotors

	$R_{\text{MAX}}$	$G_{\text{MAX}}$	MAX RPM
<b>Sorvall Rotors</b>			
GS3 Sorvall superspeed	151.3	13,700	9,000
GSA Sorvall super superspeed	145.6	27,400	13,000
HB6	146.3	27,617	13,000
AH629 Sorvall ultraspeed	161.0	151,000	29,000
SS-34 Sorvall	107.0	20,500	50,200
<b>Beckman Rotors</b>			
JA17 Beckman	123	17,000	39,800
JA20 Beckman	108	20,000	48,400
SW 28.1 Beckman	171.3	28,000	150,000
Type 50 Beckman	70.1	50,000	196,000
Vti50 Beckman	86.6	50,000	242,000
SW40 Ti Beckman	158.8	40,000	285,000
SW41 Ti Beckman	153.1	41,000	288,000
SW50.1 Beckman	107.3	50,000	300,000
Type 60Ti Beckman	89.9	60,000	362,000
Type 70Ti Beckman	39.5	70,000	504,000

## SDS-POLYACRYLAMIDE GEL ELECTROPHORESIS OF PROTEINS

---

Almost all analytical electrophoreses of proteins are carried out in polyacrylamide gels under conditions that ensure dissociation of the proteins into their individual polypeptide subunits and that minimize aggregation. Most commonly, the strongly anionic detergent SDS is used in combination with a reducing agent and heat to dissociate the proteins before they are loaded onto the gel. The denatured polypeptides bind SDS and become negatively charged. Because the amount of SDS bound is almost always proportional to the molecular weight of the polypeptide and is independent of its sequence, SDS-polypeptide complexes migrate through polyacrylamide gels in accordance with the size of the polypeptide. At saturation, ~1.4 g of detergent is bound per gram of polypeptide. By using markers of known molecular weight, it is possible to estimate the molecular weight of the polypeptide chain(s). Modifications to the polypeptide backbone, such as N- or O-linked glycosylation, however, have a significant impact on the apparent molecular weight. Thus, the apparent molecular weight of glycosylated proteins is not a true reflection of the mass of the polypeptide chain.

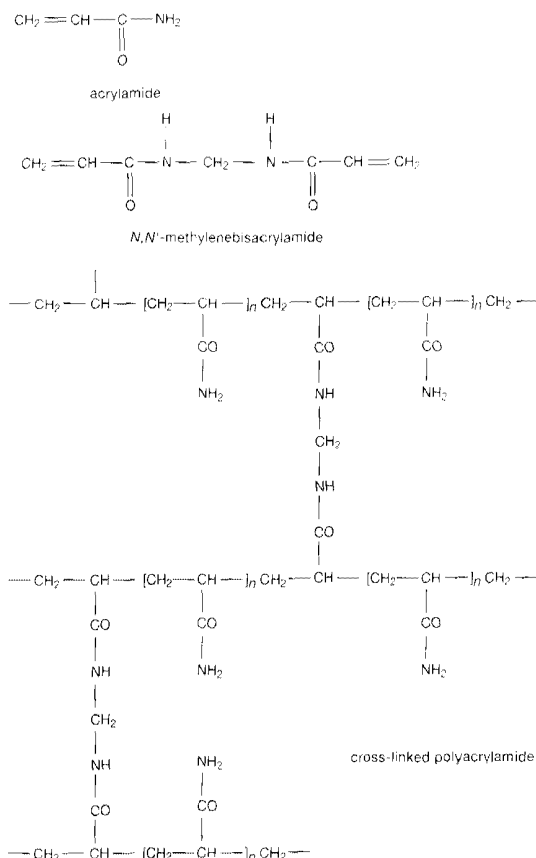
In most cases, SDS-polyacrylamide gel electrophoresis is carried out with a discontinuous buffer system in which the buffer in the reservoirs is of a pH and ionic strength different from that of the buffer used to cast the gel. The SDS-polypeptide complexes in the sample that is applied to the gel are swept along by a moving boundary created when an electric current is passed between the electrodes. After migrating through a stacking gel of high porosity, the complexes are deposited in a very thin zone (or stack) on the surface of the resolving gel. The ability of discontinuous buffer systems to concentrate all of the complexes in the sample into a very small volume greatly increases the resolution of SDS-polyacrylamide gels.

The discontinuous buffer system that is most widely used was originally devised by Ornstein (1964) and Davis (1964). The sample and the stacking gel contain Tris-Cl (pH 6.8), the upper and lower buffer reservoirs contain Tris-glycine (pH 8.3), and the resolving gel contains Tris-Cl (pH 8.8). All components of the system contain 0.1% SDS (Laemmli 1970). The chloride ions in the sample and stacking gel form the leading edge of the moving boundary, and the trailing edge is composed of glycine molecules. Between the leading and trailing edges of the moving boundary is a zone of lower conductivity and steeper voltage gradient, which sweeps the polypeptides from the sample and deposits them on the surface of the resolving gel. There the higher pH of the resolving gel favors the ionization of glycine, and the resulting glycine ions migrate through the stacked polypeptides and travel through the resolving gel immediately behind the chloride ions. Freed from the moving boundary, the SDS-polypeptide complexes move through the resolving gel in a zone of uniform voltage and pH and are separated according to size by sieving.

Polyacrylamide gels are composed of chains of polymerized acrylamide that are cross-linked by a bifunctional agent such as *N,N'*-methylene-bis-acrylamide (please see Figure A8-8).

The effective range of separation of SDS-polyacrylamide gels depends on the concentration of polyacrylamide used to cast the gel and on the amount of cross-linking. Polymerization of acrylamide in the absence of cross-linking agents generates viscous solutions that are of no practical use. Cross-links formed from bisacrylamide add rigidity and tensile strength to the gel and form pores through which the SDS-polypeptide complexes must pass. The size of these pores decreases as the bisacrylamide:acrylamide ratio increases, reaching a minimum when the ratio is ~1:20. Most SDS-polyacrylamide gels are cast with a molar ratio of bisacrylamide:acrylamide of 1:29, which has been shown empirically to be capable of resolving polypeptides that differ in size by as little as 3%.

The sieving properties of the gel are determined by the size of the pores, which is a function of the absolute concentrations of acrylamide and bisacrylamide used to cast the gel. Table A8-8 shows the linear range of separation of proteins obtained with gels cast with concentrations of acrylamide that range from 5% to 15%.



**FIGURE A8-8 Chemical Structure of Polyacrylamide**

Monomers of acrylamide are polymerized into long chains in a reaction initiated by free radicals. In the presence of *N,N'*-methylenebisacrylamide, these chains become cross-linked to form a gel. The porosity of the resulting gel is determined by the length of chains and degree of cross-linking that occurs during the polymerization reaction.

## Reagents

- Acrylamide and *N,N'*-methylene-bis-acrylamide:** Several manufacturers sell electrophoresis-grade acrylamide that is free of contaminating metal ions. A stock solution containing 29% (w/v) acrylamide and 1% (w/v) *N,N'*-methylene-bis-acrylamide should be prepared in deionized warm  $\text{H}_2\text{O}$  (to assist the dissolution of the bisacrylamide). Acrylamide and bisacrylamide are slowly converted during storage to acrylic acid and bisacrylic acid. This deamination reaction is catalyzed by light and alkali. Check that the pH of the solution is 7.0 or less, and store the solution in dark bottles at room temperature. Fresh solutions should be prepared every few months. Note that prepackaged, premixed stock solutions are commercially available (e.g., Life Technologies). These gel systems provide all the components except ammonium persulfate and are certainly convenient but perhaps a bit expensive.
- Sodium dodecyl sulfate (SDS):** Several manufacturers sell special grades of SDS that are sufficiently pure for electrophoresis. Although any one of these will give reproducible results, they are not interchangeable. The pattern of migration of polypeptides may change quite drastically when one manufacturer's SDS is substituted for another's. We recommend exclusive use of one brand of SDS. A 10% (w/v) stock solution should be prepared in deionized  $\text{H}_2\text{O}$  and stored at room temperature. If proteins are to be eluted from the gel for sequencing, electrophoresis-grade SDS should be further purified as described by Hunkapiller et al. (1983).

**TABLE A8-8 Effective Range of Separation of SDS-Polyacrylamide Gels**

ACRYLAMIDE CONCENTRATION (%)	LINEAR RANGE OF SEPARATION (KD)
15	10–43
12	12–60
10	20–80
7.5	36–94
5.0	57–212

Molar ratio of bisacrylamide:acrylamide is 1:29.

- **Tris buffers for the preparation of resolving and stacking gels:** It is essential that these buffers be prepared with Tris base. After the Tris base has been dissolved in deionized H<sub>2</sub>O, adjust the pH of the solution with HCl as described in Appendix 1. If Tris-Cl or Trizma is used to prepare buffers, the concentration of salt will be too high and polypeptides will migrate anomalously through the gel, yielding extremely diffuse bands.
- **TEMED (N,N,N',N'-tetramethylethylenediamine):** TEMED accelerates the polymerization of acrylamide and bisacrylamide by catalyzing the formation of free radicals from ammonium persulfate. Use the electrophoresis grade sold by several manufacturers. Because TEMED works only as a free base, polymerization is inhibited at low pH.
- **Ammonium persulfate:** Ammonium persulfate provides the free radicals that drive polymerization of acrylamide and bisacrylamide. A small amount of a 10% (w/v) stock solution should be prepared in deionized H<sub>2</sub>O and stored at 4°C. Ammonium persulfate decomposes slowly, and fresh solutions should be prepared weekly.
- **Tris-glycine electrophoresis buffer:** This buffer contains 25 mM Tris base, 250 mM glycine (electrophoresis grade) (pH 8.3), 0.1% SDS.

## MATERIALS

**CAUTION:** Please see Appendix 12 for appropriate handling of materials marked with <!>.

### Buffers and Solutions

Please see Appendix 1 for components of stock solutions, buffers, and reagents. Dilute stock solutions to the appropriate concentrations.

#### Acrylamide solutions <!>

Please see Table A8-9 for resolving gel recipes and Table A8-10 for stacking gel recipes.

#### Protein markers

Standard molecular-weight markers are commercially available (e.g., Life Technologies and Promega).

#### Protein samples

Samples to be resolved, for example, can be purified protein or cell lysates.

#### 1x SDS gel-loading buffer

- 50 mM Tris-Cl (pH 6.8)
- 100 mM dithiothreitol
- 2% (w/v) SDS (electrophoresis grade)
- 0.1% bromophenol blue
- 10% (v/v) glycerol

Store 1x SDS gel-loading buffer lacking dithiothreitol at room temperature. Add dithiothreitol from a 1 M stock just before the buffer is used.

TABLE A8-9 Solutions for Preparing Resolving Gels for Tris-glycine SDS-Polyacrylamide Gel Electrophoresis

↓ COMPONENTS / GEL VOLUME ⇒	VOLUME (ml) OF COMPONENTS REQUIRED TO CAST GELS OF INDICATED VOLUMES AND CONCENTRATIONS								
	5 ml	10 ml	15 ml	20 ml	25 ml	30 ml	40 ml	50 ml	
<b>6% gel</b>									
H <sub>2</sub> O	2.6	5.3	7.9	10.6	13.2	15.9	21.2	26.5	
30% acrylamide mix <!>	1.0	2.0	3.0	4.0	5.0	6.0	8.0	10.0	
1.5 M Tris (pH 8.8)	1.3	2.5	3.8	5.0	6.3	7.5	10.0	12.5	
10% SDS	0.05	0.1	0.15	0.2	0.25	0.3	0.4	0.5	
10% ammonium persulfate <!>	0.05	0.1	0.15	0.2	0.25	0.3	0.4	0.5	
TEMED <!>	0.004	0.008	0.012	0.016	0.02	0.024	0.032	0.04	
<b>8% gel</b>									
H <sub>2</sub> O	2.3	4.6	6.9	9.3	11.5	13.9	18.5	23.2	
30% acrylamide mix <!>	1.3	2.7	4.0	5.3	6.7	8.0	10.7	13.3	
1.5 M Tris (pH 8.8)	1.3	2.5	3.8	5.0	6.3	7.5	10.0	12.5	
10% SDS	0.05	0.1	0.15	0.2	0.25	0.3	0.4	0.5	
10% ammonium persulfate <!>	0.05	0.1	0.15	0.2	0.25	0.3	0.4	0.5	
TEMED <!>	0.003	0.006	0.009	0.012	0.015	0.018	0.024	0.03	
<b>10% gel</b>									
H <sub>2</sub> O	1.9	4.0	5.9	7.9	9.9	11.9	15.9	19.8	
30% acrylamide mix <!>	1.7	3.3	5.0	6.7	8.3	10.0	13.3	16.7	
1.5 M Tris (pH 8.8)	1.3	2.5	3.8	5.0	6.3	7.5	10.0	12.5	
10% SDS	0.05	0.1	0.15	0.2	0.25	0.3	0.4	0.5	
10% ammonium persulfate <!>	0.05	0.1	0.15	0.2	0.25	0.3	0.4	0.5	
TEMED <!>	0.002	0.004	0.006	0.008	0.01	0.012	0.016	0.02	
<b>12% gel</b>									
H <sub>2</sub> O	1.6	3.3	4.9	6.6	8.2	9.9	13.2	16.5	
30% acrylamide mix <!>	2.0	4.0	6.0	8.0	10.0	12.0	16.0	20.0	
1.5 M Tris (pH 8.8)	1.3	2.5	3.8	5.0	6.3	7.5	10.0	12.5	
10% SDS	0.05	0.1	0.15	0.2	0.25	0.3	0.4	0.5	
10% ammonium persulfate <!>	0.05	0.1	0.15	0.2	0.25	0.3	0.4	0.5	
TEMED <!>	0.002	0.004	0.006	0.008	0.01	0.012	0.016	0.02	
<b>15% gel</b>									
H <sub>2</sub> O	1.1	2.3	3.4	4.6	5.7	6.9	9.2	11.5	
30% acrylamide mix <!>	2.5	5.0	7.5	10.0	12.5	15.0	20.0	25.0	
1.5 M Tris (pH 8.8)	1.3	2.5	3.8	5.0	6.3	7.5	10.0	12.5	
10% SDS	0.05	0.1	0.15	0.2	0.25	0.3	0.4	0.5	
10% ammonium persulfate <!>	0.05	0.1	0.15	0.2	0.25	0.3	0.4	0.5	
TEMED <!>	0.002	0.004	0.006	0.008	0.01	0.012	0.016	0.02	

Modified from Harlow and Lane (1988).

TABLE A8-10 Solutions for Preparing 5% Stacking Gels for Tris-glycine SDS-polyacrylamide Gel Electrophoresis

↓ COMPONENTS / GEL VOLUME ⇒	VOLUME (ml) OF COMPONENTS REQUIRED TO CAST GELS OF INDICATED VOLUMES								
	1 ml	2 ml	3 ml	4 ml	5 ml	6 ml	8 ml	10 ml	
H <sub>2</sub> O	0.68	1.4	2.1	2.7	3.4	4.1	5.5	6.8	
30% acrylamide mix <!>	0.17	0.33	0.5	0.67	0.83	1.0	1.3	1.7	
1.0 M Tris (pH 6.8)	0.13	0.25	0.38	0.5	0.63	0.75	1.0	1.25	
10% SDS	0.01	0.02	0.03	0.04	0.05	0.06	0.08	0.1	
10% ammonium persulfate <!>	0.01	0.02	0.03	0.04	0.05	0.06	0.08	0.1	
TEMED <!>	0.001	0.002	0.003	0.004	0.005	0.006	0.008	0.01	

Modified from Harlow and Lane (1988).



*1x Tris-glycine electrophoresis buffer*

25 mM Tris

250 mM glycine (electrophoresis grade) (pH 8.3)

0.1% (w/v) SDS

Prepare a 5x stock of electrophoresis buffer by dissolving 15.1 g of Tris base and 94 g of glycine in 900 ml of deionized H<sub>2</sub>O. Then add 50 ml of a 10% (w/v) stock solution of electrophoresis-grade SDS and adjust the volume to 1000 ml with H<sub>2</sub>O.

## Special Equipment

*Power supply*

A device capable of supplying up to 500 V and 200 mA is needed.

*Vertical electrophoresis apparatus*

The use of discontinuous buffer systems requires SDS-polyacrylamide electrophoresis to be carried out in vertical gels. Although the basic design of the electrophoresis tanks and plates has changed little since Studier (1973) introduced the system, many small improvements have been incorporated into the apparatuses. Standard vertical as well as minigel vertical electrophoresis systems for separation and blotting of proteins are now sold by many manufacturers (e.g., Life Technologies). Which of these systems to purchase is a matter of personal choice, but it is sensible for a laboratory to use only one type of apparatus. This type of standardization makes it easier to compare the results obtained by different investigators and allows parts of broken apparatuses to be scavenged and reused.

## METHOD

---

### Pouring SDS-polyacrylamide Gels

1. Assemble the glass plates according to the manufacturer's instructions.
2. Determine the volume of the gel mold (this information is usually provided by the manufacturer). In an Erlenmeyer flask or disposable plastic tube, prepare the appropriate volume of solution containing the desired concentration of acrylamide for the resolving gel, using the values given in Table A8-9. Mix the components in the order shown. Polymerization will begin as soon as the TEMED has been added. Without delay, swirl the mixture rapidly and proceed to the next step.

The concentration of ammonium persulfate that we recommend is higher than that used by some investigators. This eliminates the need to rid the acrylamide solution of dissolved oxygen (which retards polymerization) by degassing.

3. Pour the acrylamide solution into the gap between the glass plates. Leave sufficient space for the stacking gel (the length of the teeth of the comb plus 1 cm). Use a Pasteur pipette to carefully overlay the acrylamide solution with 0.1% SDS (for gels containing ~8% acrylamide) or isobutanol (for gels containing ~10% acrylamide). Place the gel in a vertical position at room temperature.

The overlay prevents oxygen from diffusing into the gel and inhibiting polymerization. Isobutanol dissolves the plastic of some minigel apparatuses.

4. After polymerization is complete (30 minutes), pour off the overlay and wash the top of the gel several times with deionized H<sub>2</sub>O to remove any unpolymerized acrylamide. Drain as much fluid as possible from the top of the gel, and then remove any remaining H<sub>2</sub>O with the edge of a paper towel.
5. Prepare the stacking gel as follows: In a disposable plastic tube, prepare the appropriate volume of solution containing the desired concentration of acrylamide, using the values given in

Table A8-10. Mix the components in the order shown. Polymerization will begin as soon as the TEMED has been added. Without delay, swirl the mixture rapidly and proceed to the next step.

The concentration of ammonium persulfate is higher than that used by some investigators. This eliminates the need to rid the acrylamide solution of dissolved oxygen (which retards polymerization) by degassing.

6. Pour the stacking gel solution directly onto the surface of the polymerized resolving gel. Immediately insert a clean Teflon comb into the stacking gel solution, being careful to avoid trapping air bubbles. Add more stacking gel solution to fill the spaces of the comb completely. Place the gel in a vertical position at room temperature.

Teflon combs should be cleaned with H<sub>2</sub>O and dried with ethanol just before use.

## Preparation of Samples and Running the Gel

7. While the stacking gel is polymerizing, prepare the samples in the appropriate volume of 1x SDS gel-loading buffer and heat them to 100°C for 3 minutes to denature the proteins.

Be sure to denature a sample containing marker proteins of known molecular weights. Mixtures of appropriately sized polypeptides are available from commercial sources.

Extremely hydrophobic proteins, such as those containing multiple transmembrane domains, may precipitate or multimerize when boiled for 3 minutes at 100°C. To avoid these pitfalls, heat the samples for 1 hour at a lower temperature (45–55°C) to effect denaturation.

8. After polymerization is complete (30 minutes), remove the Teflon comb carefully. Use a squirt bottle to wash the wells immediately with deionized H<sub>2</sub>O to remove any unpolymerized acrylamide. If necessary, straighten the teeth of the stacking gel with a blunt hypodermic needle attached to a syringe. Mount the gel in the electrophoresis apparatus. Add Tris-glycine electrophoresis buffer to the top and bottom reservoirs. Remove any bubbles that become trapped at the bottom of the gel between the glass plates. This is best done with a bent hypodermic needle attached to a syringe.

▲ **IMPORTANT** Do not prerun the gel before loading the samples, since this procedure will destroy the discontinuity of the buffer systems.

9. Load up to 15 µl of each of the samples in a predetermined order into the bottom of the wells. This is best done with a Hamilton microliter syringe or a micropipettor equipped with gel-loading tips that is washed with buffer from the bottom reservoir after each sample is loaded. Load an equal volume of 1x SDS gel-loading buffer into any wells that are unused.
10. Attach the electrophoresis apparatus to an electric power supply (the positive electrode should be connected to the bottom buffer reservoir). Apply a voltage of 8 V/cm to the gel. After the dye front has moved into the resolving gel, increase the voltage to 15 V/cm and run the gel until the bromophenol blue reaches the bottom of the resolving gel (~4 hours). Then turn off the power supply.
11. Remove the glass plates from the electrophoresis apparatus and place them on a paper towel. Use an extra gel spacer to carefully pry the plates apart. Mark the orientation of the gel by cutting a corner from the bottom of the gel that is closest to the leftmost well (slot 1).
 

▲ **IMPORTANT** Do not cut the corner from gels that are to be used for immunoblotting.
12. At this stage, the gel can be fixed, stained with Coomassie Brilliant Blue or silver salts, fluorographed or autoradiographed, or used to establish an immunoblot, all as described on the following pages.

## STAINING SDS-POLYACRYLAMIDE GELS

Unlabeled proteins separated by polyacrylamide gel electrophoresis typically are detected by staining, either with Coomassie Brilliant Blue or with silver salts. In a relatively rapid and straightforward reaction, Coomassie Brilliant Blue binds nonspecifically to proteins but not to the gel, thereby allowing visualization of the proteins as discreet blue bands within the translucent matrix of the gel (Wilson 1983). Silver staining, although somewhat more difficult to perform, is significantly more sensitive. The use of silver staining allows detection of proteins resolved by gel electrophoresis at concentrations nearly 100-fold lower than those detected by Coomassie Brilliant Blue staining (Switzer et al. 1979; Merril et al. 1984). The identification of proteins by silver staining is based on the differential reduction of silver ions, in a reaction similar to that used in photographic processes. Reagents for staining with Coomassie Brilliant Blue as well as kits (e.g., Blue Print Fast PAGE Stain, Life Technologies) are commercially available. Kits for silver staining are commercially available from Pierce and Bio-Rad.

### HISTORICAL FOOTNOTE

Coomassie Brilliant Blue R-250 was first used as a laboratory reagent to stain proteins in 1963. Robert Webster, a graduate student in the laboratory of Stephen Fazekas de St. Groth at the Australian National University in Canberra, was searching for a way to locate influenza virus proteins that had been separated by electrophoresis on cellulose acetate strips. At that time, Australia had a thriving wool industry and government laboratories were intensely investigating the mechanism of action of various classes of dyes used for wool dyeing. Fazekas and Webster reasoned that these dyes must have a high affinity for proteins, and they obtained samples of a great many dyes from the Commonwealth Scientific and Industrial Organization. Included among them was Coomassie Brilliant Blue R-250, which had been used since the turn of the century in the textile dyeing industry. Webster soon found that Coomassie Brilliant Blue R-250 was a very sensitive stain for proteins, but he was frustrated by extreme day-to-day variation in the intensity of the staining. At home one night, he suddenly realized that the answer to the problem was to fix the protein before staining. He went back to the laboratory and fixed the separated influenza virus proteins with sulfosalicylic acid. After these results were published (Fazekas de St. Groth et al. 1963), the method was rapidly adapted to stain proteins separated by electrophoresis through polyacrylamide gels (Meyer and Lamberts 1965).

Because Coomassie Brilliant Blue R-250 is now a trademark of Imperial Chemical Industries PLC, the dye is generally listed in biochemical catalogs as Brilliant Blue. Two forms of the dye are available: Brilliant Blue G and Brilliant Blue R, which are given different numbers (42655 and 42660) in the Colour Index, a kind of dyer's Bible, in which dyes are classified and arranged according to color. Brilliant Blue G and Brilliant Blue R are, respectively, slightly soluble and insoluble in cold water, and soluble and slightly soluble in hot water and alcohols. Both dyes stain fixed proteins efficiently. They are used at a concentration of 0.05% in methanol:glacial acetic acid:water (50:10:40 v/v).

## Staining SDS-Polyacrylamide Gels with Coomassie Brilliant Blue

Coomassie Brilliant Blue is an aminotriarylmethane dye that forms strong but not covalent complexes with proteins, most probably by a combination of van der Waals forces and electrostatic interactions with  $\text{NH}_3^+$  groups. Coomassie Brilliant Blue is used to stain proteins after electrophoresis through polyacrylamide gels. The uptake of dye is approximately proportional to the amount of protein, following the Beer-Lambert law.

Polypeptides separated by SDS-polyacrylamide gels can be simultaneously fixed with methanol:glacial acetic acid and stained with Coomassie Brilliant Blue R-250, a triphenylmethane textile dye also known as Acid Blue 83. The gel is immersed for several hours in a concentrated methanol:acetic acid solution of the dye, and excess dye is then allowed to diffuse from the gel during a prolonged period of destaining.

## MATERIALS

**CAUTION:** Please see Appendix 12 for appropriate handling of materials marked with <!.>.

*Coomassie Brilliant Blue R-250*

*Methanol:acetic acid solution <!.>*

Combine 900 ml of methanol:H<sub>2</sub>O (500 ml of methanol and 400 ml of H<sub>2</sub>O) and 100 ml of glacial acetic acid.

*Step 1 of this protocol requires the reagents listed on page A8.42.*

## METHOD

1. Separate proteins by electrophoresis through an SDS-polyacrylamide gel as described on page A8.40.
2. Prepare the staining solution by dissolving 0.25 g of Coomassie Brilliant Blue R-250 per 100 ml of methanol:acetic acid solution. Filter the solution through a Whatman No. 1 filter to remove any particulate matter.
3. Immerse the gel in at least 5 volumes of staining solution and place on a slowly rotating platform for a minimum of 4 hours at room temperature.
4. Remove the stain and save it for future use. Destain the gel by soaking it in the methanol:acetic acid solution without the dye on a slowly rocking platform for 4–8 hours, changing the destaining solution three or four times.

The more thoroughly the gel is destained, the smaller the amount of protein detected by staining with Coomassie Brilliant Blue. Destaining for 24 hours usually allows as little as 0.1 µg of protein to be detected in a single band.

A more rapid rate of destaining can be achieved by the following methods:

- Destaining in 30% methanol, 10% acetic acid. If destaining is prolonged, there will be some loss in the intensity of staining of protein bands.
  - Destaining in the normal destaining buffer at higher temperatures (45°C).
  - Including a few grams of an anion exchange resin or a piece of sponge in the normal destaining buffer. These absorb the stain as it leaches from the gel.
  - Destaining electrophoretically in apparatuses that are sold commercially for this purpose.
5. After destaining, store the gels in H<sub>2</sub>O in a sealed plastic bag.  
Gels may be stored indefinitely without any diminution in the intensity of staining; however, fixed polyacrylamide gels stored in H<sub>2</sub>O will swell and may distort during storage. To avoid this problem, store fixed gels in H<sub>2</sub>O containing 20% glycerol. Stained gels should not be stored in destaining buffer, because the stained protein bands will fade.
  6. To make a permanent record, either photograph the stained gel (please see Chapter 5, Protocol 2) or dry the gel as described on p. A8.50.

### Staining SDS-Polyacrylamide Gels With Silver Salts

A number of methods have been developed to stain polypeptides with silver salts after separation by SDS-polyacrylamide gel electrophoresis. In every case, the process relies on differential reduction of silver ions that are bound to the side chains of amino acids (Switzer et al. 1979; Oakley et al. 1980; Ochs et al. 1981; Sammons et al. 1981; Merrill et al. 1984). These methods fall into two major classes: those that use ammoniacal silver solutions and those that use silver nitrate. Although both types of staining are ~100–1000-fold more sensitive than staining with Coomassie Brilliant Blue R-250 and are capable of detecting as little as 0.1–1.0 ng of polypeptide in a single band, silver nitrate solutions are easier to prepare and, by contrast to ammoniacal silver salts, do

not generate potentially explosive by-products. The method given below is a modification of the staining procedure originally devised by Sammons et al. (1981), which has since undergone several improvements (Schoenle et al. 1984). For further information, please see the discussion on silver staining in Appendix 9.

## MATERIALS

---

**CAUTION: Please see Appendix 12 for appropriate handling of materials marked with <!.>.**

*Acetic acid (1%) <!.>*

*Developing solution*

Prepare fresh for each use an aqueous solution of 2.5% sodium carbonate, 0.02% formaldehyde. <!.>

*Ethanol (30%)*

*Fixing solution*

Ethanol:glacial acetic acid:H<sub>2</sub>O (30:10:60) <!.>

*Photographic reducing solution (Switzer et al. 1979)*

Optional, please see Step 10.

*Prepare Solution A:* Dissolve 37 g of NaCl and 37 g of CuSO<sub>4</sub> in 850 ml of deionized H<sub>2</sub>O. Add concentrated NH<sub>4</sub>OH <!.> until a deep blue precipitate forms and then dissolves. Adjust the volume to 1 liter with H<sub>2</sub>O.

*Prepare Solution B:* Dissolve 436 g of sodium thiosulfate in 900 ml of deionized H<sub>2</sub>O. Adjust the volume to 1 liter with H<sub>2</sub>O.

Mix equal volumes of Solution A and Solution B, dilute the mixture with 3 volumes of H<sub>2</sub>O, and use the diluted mixture immediately.

*Silver nitrate solution*

Prepare fresh for each use, 0.1% solution of AgNO<sub>3</sub>, <!.> diluted from a 20% stock, stored in a tightly closed, brown glass bottle at room temperature.

*Step 1 of this protocol requires the reagents listed on page A8.42*

## METHOD

---

▲ **IMPORTANT** Wear gloves and handle the gel gently because pressure and fingerprints produce staining artifacts. In addition, it is essential to use clean glassware and deionized H<sub>2</sub>O because contaminants greatly reduce the sensitivity of silver staining.

1. Separate proteins by electrophoresis through an SDS-polyacrylamide gel as described on page A8.40.
2. Fix the proteins by incubating the gel for 4–12 hours at room temperature with gentle shaking in at least 5 gel volumes of fixing solution.
3. Discard the fixing solution, and add at least 5 gel volumes of 30% ethanol. Incubate the gel for 30 minutes at room temperature with gentle shaking.
4. Repeat Step 3.
5. Discard the ethanol and add 10 gel volumes of deionized H<sub>2</sub>O. Incubate the gel for 10 minutes at room temperature with gentle shaking.
6. Repeat Step 5 twice.  
The gel will swell slightly during rehydration.
7. Discard the last of the H<sub>2</sub>O washes, and, wearing gloves, add 5 gel volumes of silver nitrate solution. Incubate the gel for 30 minutes at room temperature with gentle shaking.

8. Discard the silver nitrate solution, and wash both sides of the gel (20 seconds each) under a stream of deionized H<sub>2</sub>O.  
Allowing the surface of the gel to dry out will result in staining artifacts.
9. Add 5 gel volumes of fresh developing solution. Incubate the gel at room temperature with gentle agitation. Watch the gel carefully. Stained bands of protein should appear within a few minutes. Continue incubation until the desired contrast is obtained.  
Prolonged incubation leads to a high background of silver staining within the body of the gel.
10. Quench the reaction by washing the gel in 1% acetic acid for a few minutes. Then wash the gel several times with deionized H<sub>2</sub>O (10 minutes per wash).  
A shiny gray film of silver sometimes forms on the surface of the gel. This can be removed by washing the gel for 2–3 seconds in a 1:4 dilution of photographic reducing solution. Rinse the treated gel extensively in deionized H<sub>2</sub>O.
11. Preserve the gel by drying as described on the following pages.

## DRYING SDS-POLYACRYLAMIDE GELS

---

SDS-polyacrylamide gels containing proteins radiolabeled with  $^{35}\text{S}$ -labeled amino acids must be dried before autoradiographic images can be obtained. The major problems encountered when a gel is dried are (1) shrinkage and distortion and (2) cracking of the gel. The first of these problems can be minimized if the gel is attached to a piece of Whatman 3MM paper before it is dehydrated. (For nonradioactive gels, note that the preference may be to dry the gel between acetate sheets to allow transillumination and easy visualization of the dried gel.) However, there is no guaranteed solution to the second problem, which becomes more pronounced with thicker gels containing more polyacrylamide. Cracking generally occurs when the gel is removed from the drying apparatus before it is completely dehydrated. It is therefore essential to keep the drying apparatus in good condition, to use a reliable vacuum line that has few fluctuations in pressure, and to use the thinnest gel possible to achieve the desired purpose. An excellent alternative method is soaking the gel in 3% glycerol, followed by drying in air using a simple apparatus (available from AP Biotech or Owl Scientific).

## MATERIALS

---

**CAUTION:** Please see Appendix 12 for appropriate handling of materials marked with <!.>.

### *Fixing solution*

Glacial acetic acid:methanol:H<sub>2</sub>O (10:20:70 v/v/v) <!.>

### *Gel dryer*

Gel dryers are available from a number of commercial sources (e.g., Life Technologies and Promega). It is best to purchase the dryer from the manufacturer of the SDS-polyacrylamide gel electrophoresis tanks to ensure that the size of the dryer will be tailored to that of the gels and will accommodate several SDS-polyacrylamide gels simultaneously.

### *Methanol (20%) containing 3% glycerol <!.>*

Optional, please see Step 1.

### *Whatman 3MM paper*

## METHOD

---

1. Remove the gel from the electrophoresis apparatus and incubate it at room temperature in 5–10 volumes of fixing solution. The bromophenol blue will turn yellow as the acidic fixing solution diffuses into the gel. Continue fixation for 5 minutes after all of the blue color has disappeared, and then wash the gel briefly in deionized H<sub>2</sub>O.  
If cracking of polyacrylamide gels during drying is a constant problem, soak the fixed gel in 20% methanol, 3% glycerol overnight before proceeding to Step 2.
2. On a piece of Saran Wrap slightly larger than the gel, arrange the gel with its cut corner on the lower right-hand side.
3. Place a piece of dry Whatman 3MM paper on the damp gel. The paper should be large enough to create a border (1–2 cm) around the gel and small enough to fit on the gel dryer. Do not attempt to move the 3MM paper once contact has been made with the gel.
4. Arrange another piece of dry 3MM paper on the drying surface of the gel dryer. This piece should be large enough to accommodate all of the gels that are to be dried at the same time.
5. Place the sandwich of 3MM paper/gel/Saran Wrap on the piece of 3MM paper on the gel dryer. The Saran Wrap should be uppermost.

6. Close the lid of the gel dryer, and apply suction so that the lid makes a tight seal around the gels. If the dryer is equipped with a heater, apply low heat (50–65°C) to speed up the drying process.
7. Dry the gel for the time recommended by the manufacturer (usually 2 hours for standard 0.75-mm gels). If heat was applied, turn off the heat for a few minutes before releasing the vacuum.
8. Remove the gel, which is now attached to a piece of 3MM paper, from the dryer.
9. Remove the piece of Saran Wrap and establish an autoradiograph as described in Appendix 9, or store the dehydrated gel as a record of the experiment.



## IMMUNOBLOTTING

**CAUTION:** Please see Appendix 12 for appropriate handling of materials marked with <!>.

Immunoblotting is used to identify and measure the size of macromolecular antigens (usually proteins) that react with a specific antibody (Towbin et al. 1979; Burnette 1981; for reviews, please see Towbin and Gordon 1984; Gershoni 1988; Stott 1989; Poxton 1990). The proteins are first separated by electrophoresis through SDS-polyacrylamide gels and then transferred electrophoretically from the gel to a solid support, such as a nitrocellulose, polyvinylidene difluoride (PVDF), or cationic nylon membrane. After the unreacted binding sites of the membrane are blocked to suppress nonspecific adsorption of antibodies, the immobilized proteins are reacted with a specific polyclonal or monoclonal antibody. Antigen-antibody complexes are finally located by radiographic, chromogenic, or chemiluminescent reactions.

Much mumbo-jumbo has been written about ways to avoid the problems that commonly arise in immunoblotting. These problems include inefficient transfer of proteins, loss of antigenic sites, low sensitivity, high background, and nonquantitative detection methods. Although no magic incantation can eliminate all of these undesirable difficulties for every antigen, a small amount of experimentation is usually sufficient to cure all but the most obdurate technical problems. Comprehensive reviews by Bjerrum and Schafer-Nielsen (1986), Bjerrum et al. (1988), and Stott (1989) provide catalogs of potential difficulties in immunoblotting and detailed suggestions for solving them.

### Transfer of Proteins from Gel to Filter

Electrophoretic transfer of proteins from polyacrylamide gels to membranes is far more efficient and much quicker than capillary transfer. Transfer is carried out perpendicularly from the direction of travel of proteins through the separating gel, using electrodes and membranes that cover the entire area of the gel. Most commercial electrophoretic transfer devices use large electrodes made of graphite, platinum wire mesh, or stainless steel. In older devices, vertical electrodes were submerged in a tank of transfer buffer in a plastic cradle surrounding the gel and the membrane. The more modern devices use the efficient "semi-dry" method, in which Whatman 3MM paper saturated with transfer buffer is used as a reservoir. For transfer from SDS gels, the membrane is

**TABLE A8-11 Buffers for Transfer of Proteins from Polyacrylamide Gels to Membranes**

TYPE OF TRANSFER	BUFFER	REFERENCE
Semi-dry	24 mM Tris base 192 mM glycine 20% methanol <!>	Towbin et al. (1979)
Immersion	48 mM Tris base 39 mM glycine 20% methanol <!> 0.0375% SDS	Bjerrum and Schafer-Nielsen (1986)

Methanol minimizes swelling of the gel and increases the efficiency of binding of proteins to nitrocellulose membranes. The efficiency of transfer may be affected by the presence of SDS in the electrophoresis buffer, the pH of the transfer buffer, and whether the proteins were stained in the gel before transfer. To maximize transfer of protein to membranes, the concentration of SDS should be  $\leq 0.1\%$  and the pH should be  $\geq 8.0$ . CAPS buffer should be used for transfer if the protein is to be sequenced on the membrane (Moos 1992). Glycine interferes with this procedure.

placed on the side of the gel facing the anode. The conditions used for transfer vary according to the design of the apparatus, and it is therefore best to follow the manufacturer's instructions at this stage.

## Types of Membranes

Three types of membranes are used for immunoblotting: nitrocellulose, nylon, and polyvinylidene fluoride. Different proteins may bind with different efficiencies to these membranes, and particular antigenic epitope(s) may be better preserved in one case than another. It is therefore worthwhile wherever possible to test the efficiency with which the antigen of interest can be detected on various membranes, using several antibodies.

- **Nitrocellulose** (pore size 0.45  $\mu\text{m}$ ) remains a standard membrane used for immunoblotting, although membranes with a smaller pore size (0.22  $\mu\text{m}$  or 0.1  $\mu\text{m}$ ) are recommended for immunoblotting of small proteins of  $M_r < 14,000$  (Burnette 1981; Lin and Kasamatsu 1983). The capacity of nitrocellulose to bind and retain proteins ranges from 80  $\mu\text{g}/\text{cm}^2$  to 250  $\mu\text{g}/\text{cm}^2$ , depending on the protein. Proteins bind to nitrocellulose chiefly by hydrophobic interactions (van Oss et al. 1987), although hydrogen bonding between amino acid side chains and the nitro group of the membrane may also be involved. In any event, partial dehydration of the proteins by methanol or salt in the transfer buffer ensures a more lasting bond between the protein and the membrane. Even so, proteins may be lost from the membrane during processing, particularly if buffers containing nonionic detergents are used. Many investigators therefore fix the proteins to nitrocellulose membranes to reduce loss during washing and incubation with antibody (e.g., please see Gershoni and Palade 1982). However, it is important to check that the treatments used for fixation (glutaraldehyde, cross-linking, UV irradiation) do not destroy the antigenic epitope under study. These treatments can also increase the brittleness of nitrocellulose filters that are allowed to dry after transfer.
- **Nylon and positively charged nylon membranes** are tougher than nitrocellulose and bind proteins tightly by electrostatic interactions. Their capacity varies from one type of nylon to the next and from one protein to another but is usually in the range of 150  $\mu\text{g}/\text{cm}^2$  to 200  $\mu\text{g}/\text{cm}^2$ . The advantage of nylon and charged nylon membranes over nitrocellulose is that they can be probed multiple times with different antibodies. However, nylon membranes have two potential disadvantages. First, as discussed below, no simple and sensitive procedure is available to stain proteins immobilized on nylon and charged nylon membranes. Second, because it is difficult to block all of the unoccupied sites on these membranes, antibodies tend to bind non-specifically to the filter, resulting in a high background, especially when a highly sensitive detection method such as enhanced chemiluminescence (ECL) is used. In many cases, extended blocking in solutions containing 6% heat-treated casein and 1% polyvinylpyrrolidone (Gillespie and Hudspeth 1991) is required to achieve satisfactory results.
- **Polyvinylidene fluoride** (PVDF) (Pluskal et al. 1986) is mechanically strong and manifests a strong interfacial (hydrophobic) interaction with proteins. Before transfer, it is necessary to wet the hydrophobic surface of the membrane with methanol. The capacity of PVDF membranes is approximately equal to that of nylon membranes ( $\sim 170 \mu\text{g protein}/\text{cm}^2$ ). Proteins bind approximately sixfold more tightly to PVDF membranes than to nitrocellulose (van Oss et al. 1987) and are retained more efficiently during the subsequent detection steps. Proteins immobilized on PVDF can be visualized with standard stains such as Amido Black, India Ink, Ponceau S, and Coomassie Brilliant Blue.

## Staining of Proteins during Immunoblotting

Separation of proteins in gels and transfer to membranes can be confirmed by staining. This is a simple procedure, but it requires careful choice of a stain that is sufficiently sensitive and appropriate for the type of membrane. Staining can be carried out at several stages in the immunoblotting procedure as outlined below.

- **Staining gels before transfer to membranes.** Proteins can be stained in polyacrylamide gels with conventional dyes such as Coomassie Brilliant Blue, destained, and then transferred electrophoretically to nitrocellulose or PVDF filters for immunoblotting (e.g., please see Thompson and Larson 1992). The chief advantage of this method is that proteins remain stained during immunodetection, thereby providing a set of internal markers. However, in some cases, staining of proteins in gels appears to reduce the efficiency of electroelution and/or to interfere with binding of antibody. (The use of prestained protein markers [Life Technologies] provides a set of internal markers during protein transfer without the need to stain the entire gel.)
- **Staining proteins after transfer to membranes.** The entire area of nitrocellulose and PVDF membranes can be stained with the removable but insensitive stain Ponceau S (Muilerman et al. 1982; Salinovitch and Montelaro 1986). When more permanent stains are used (e.g., India Ink [Hancock and Tsang 1983], Amido Black [Towbin et al. 1979; Wilson 1979], colloidal gold [Moeremans et al. 1985; Rohringer and Holden 1985], or silver [Yuen et al. 1982]), it is usually necessary to cut a reference lane from the membrane.

Brief exposure to alkali enhances staining with both India Ink and colloidal gold, perhaps by reducing loss of protein from the filter during washing (Sutherland and Skerritt 1986). Under these conditions, it is easily possible to detect a band containing as little as a few nanograms of protein. There is no satisfactory method to stain proteins immobilized on nylon or cationic nylon membranes. The high density of charge on these membranes causes dye molecules to bind indiscriminately to the surface, producing high backgrounds that obscure all but the strongest protein bands.

## Blocking Agents

Traditional blocking agents such as 0.5% low-fat dry milk or 5% bovine serum albumin (Johnson et al. 1984; DenHollander and Befus 1989) are suitable for use with chromogenic detection systems based on horseradish peroxidase. However, these solutions are usually rich in residual alkaline phosphatase and should not be used in detection systems that employ this enzyme. This is particularly true with chemiluminescent systems, where the sensitivity is determined not by the strength of the emitted signal but by the efficiency of suppression of background. The best blocking solution for alkaline-phosphatase-based systems contains 6% casein, 1% polyvinylpyrrolidone, 10 mM EDTA in phosphate-buffered saline (Gillespie and Hudspeth 1991). The blocking solution should be heated to 65°C for 1 hour to inactivate residual alkaline phosphatase and then stored at 4°C in the presence of 3 mM sodium azide. For recipes, please see Appendix 1.

## Probing and Detection

The antibody that reacts with the epitope of interest can be either polyclonal or monoclonal. In either case, it is not radiolabeled or conjugated to an enzyme but is merely diluted into an appropriate buffer for formation of antibody-antigen complexes. In general, backgrounds in immunoblotting are unacceptably high unless the primary antibody can be diluted at least 1:1000

when enzymatic methods of detection are used and at least 1:5000 when chemiluminescent methods are used. After washing, the bound antibody is detected by a radiolabeled or enzyme-conjugated secondary reagent, which recognizes common features of the primary antibody and carries a reporter enzyme or group. Secondary reagents include:

- **Radioiodinated antibodies or Staphylococcal Protein A**, which were used in the first immunoblots (e.g., please see Burnette 1981) and for a few years thereafter. However, radiolabeled secondary reagents have now been replaced by nonradioactive detection systems such as enhanced chemiluminescence, which are less hazardous and more sensitive. They remain the most accurate method for semi-quantitative immunoblotting.
- **Antibodies conjugated to enzymes**, such as horseradish peroxidase or alkaline phosphatase, for which a variety of chromogenic, fluorescent, and chemiluminescent substrates are available.
- **Antibodies coupled to biotin**, which can then be detected by labeled or conjugated streptavidin.

Images of radiolabeled reagents are captured on X-ray film or phosphorimagers, whereas the results of chromogenic and fluorogenic reactions are best recorded by conventional photography. Table A8-12 shows the approximate sensitivity with which the best of these methods can detect a standard antigen using antibodies of high titer and specificity. For more information about these detection methods, please see Appendix 9.

**TABLE A8-12 Chromogenic and Chemiluminescent Methods of Detection of Immobilized Antigens**

ENZYME	REAGENT	SENSITIVITY	COMMENTS	REFERENCES
<b>Chromogenic</b>				
Horseradish peroxidase	4-chloro-1 naphthol/ H <sub>2</sub> O <sub>2</sub>	1 ng	The purple color of oxidized products fades rapidly on exposure to light.	Hawkes et al. (1982); Dresel and Schettler (1984)
	diaminobenzidine <math>\langle ! \rangle</math>/ H <sub>2</sub> O <sub>2</sub>	250 pg	Potentially carcinogenic. The diaminobenzidine reaction generates a brown precipitate, which is enhanced by the addition of cobalt, silver, and nickel salts.	de Blas and Chervinski (1983); Gershoni (1988)
	3,3',5,5'-tetramethylbenzidine	100 pg	Deep purple precipitate.	McKimm-Breschkin (1990)
Alkaline phosphatase	nitro blue tetrazolium/ 5-bromo-4-chloroindolyl phosphate	100 pg	Steel-blue precipitate.	Leary et al. (1983); Blake et al. (1984)
<b>Chemiluminescent</b>				
Horseradish peroxidase	luminol/4-iodo-phenol/ H <sub>2</sub> O <sub>2</sub>	300 pg	Oxidized luminol emits blue light that is captured on X-ray film. Luminescence generated by intense bands appears within a few seconds, whereas faint bands need at least 30 minutes to develop.	Schneppenheim and Rautenberg (1987); Harper and Murphy (1991); Schneppenheim et al. (1991)
Alkaline phosphatase	AMPPD 3-(4-methoxyspiro[1,2-dioxetane-3,2'-tricyclo-[3,3,1 <sup>3,7</sup> ]decan]-4-yl)-phenylphosphate	1 pg	The enzymatically dephosphorylated product emits light. Because of its high turnover number, alkaline phosphatase rapidly generates a strong signal that provides an exquisitely sensitive method of immunodetection.	Gillespie and Hudspeth (1991)

-----

# Appendix 9

---

## Detection Systems

<b>STAINING NUCLEIC ACIDS</b>	A9.3
Ethidium Bromide	A9.3
Methylene Blue	A9.4
Silver Staining	A9.5
Silver Staining of DNA in Nondenaturing Polyacrylamide Gels	A9.6
SYBR Dyes	A9.7
<b>AUTORADIOGRAPHY AND IMAGING</b>	A9.9
<b>AUTORADIOGRAPHY AND PHOSPHORIMAGING</b>	A9.11
Intensifying Screens	A9.11
Prelashing	A9.11
Fluorography	A9.12
Sensitivity of Different Autoradiographic Methods	A9.13
Setting up Autoradiographs	A9.13
Phosphorimaging	A9.14
Isotopic Data	A9.15
<b>CHEMILUMINESCENCE</b>	A9.16
Chemiluminescent Labels	A9.17
Chemiluminescent Enzyme Assays	A9.19
Commercial Reagents, Kits, and Luminometers	A9.20
<b>BIOLUMINESCENCE</b>	A9.21
Firefly Luciferase	A9.21
Bacterial Luciferase	A9.23
Green Fluorescent Protein	A9.24
<b>ANTIBODIES</b>	A9.25
Purification of Antibodies	A9.25
Immunological Assays	A9.27
Radiolabeling of Antibodies	A9.30

Antipeptide Antibodies	A9.30
Conjugated Antibodies	A9.33

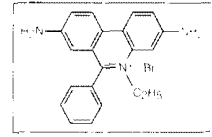
**INFORMATION PANELS**

Horseradish Peroxidase	A9.35
Digoxigenin	A9.38
BCIP	A9.41
AMPPD	A9.42
Avidin and Biotin	A9.45
Immunoglobulin-binding Proteins: Proteins A, G, and L	A9.46

## STAINING NUCLEIC ACIDS

### Ethidium Bromide

Ethidium bromide was synthesized in the 1950s in an effort to develop phenanthridine compounds as effective trypanocidal agents. Ethidium emerged from the screening program with flying colors. It was 10–50-fold more effective against trypanosomes than the parent compound, was no more toxic to mice, and, unlike earlier phenanthridines, did not induce photosensitization in cattle (Watkins and Wolfe 1952). Until recently, ethidium bromide was widely used for the treatment and prophylaxis of trypanomiasis in cattle in tropical and subtropical countries. The chemical structure of ethidium bromide is shown at the right.



### *Binding of Ethidium Bromide to Nucleic Acids*

Ethidium bromide contains a planar tricyclic phenanthridine ring system that is able to intercalate between the stacked base pairs of double-stranded DNA. After insertion into the helix, the drug lies perpendicular to the helical axis and makes van der Waals contacts with the base pairs above and below. Whereas the planar ring system of the drug is buried, its peripheral phenyl and ethyl groups project into the major groove of the DNA helix. At saturation in solutions of high ionic strength, approximately one ethidium molecule is intercalated per 2.5 base pairs, independent of the base composition of the DNA. The geometry of the base pairs and their positioning with respect to the helix are unchanged except for their displacement by 3.4 Å along the helix axis (Waring 1965). This causes a 27% increase in the length of double-stranded DNA (Freifelder 1971) saturated with ethidium bromide.

Ethidium bromide also binds with highly variable stoichiometry to helical regions formed by intrastrand base pairing in RNA and heat-denatured or single-stranded DNA (Waring 1965, 1966; LePecq and Paoletti 1967). The fixed position of the planar group of ethidium bromide and its close proximity to the bases cause the bound dye to display a 20–25-fold increase in fluorescent yield compared to the dye in free solution. UV radiation at 254 nm is absorbed by the DNA and transmitted to the dye; radiation at 302 nm and 366 nm is absorbed by the dye itself. The energy is re-emitted with a quantum yield of 0.3 at 590 nm in the red-orange region of the visible spectrum (LePecq and Paoletti 1967; Tuma et al. 1999).

Most of the commercially available UV light sources emit UV light at 302 nm. The fluorescent yield of ethidium bromide–DNA complexes excited by irradiation is considerably greater at 302 nm than at 366 nm but is slightly less than at shorter wavelength (254 nm). However, the amount of photobleaching of the dye and nicking of the DNA is much less at 302 nm than at 254 nm (Brunk and Simpson 1977).

### *Staining DNA in Gels*

Ethidium bromide is widely used to locate fragments of DNA in agarose gels (Aaij and Borst 1972; Sharp et al. 1973; please see the introduction to Chapter 5 and Protocol 2 in Chapter 5). The dye is usually incorporated into the gel and the electrophoresis buffer at a concentration of 0.5 µg/ml. Although the electrophoretic mobility of linear double-stranded DNA is reduced by ~15% in the presence of ethidium bromide, the ability to examine the gel directly under UV illumination is a great advantage. Since the fluorescent yield of ethidium bromide–DNA complexes is much greater than that of the unbound dye, small amounts of DNA (~10 ng/band) can be detected in



the presence of free ethidium bromide in gels (Sharp et al. 1973). Even smaller quantities of DNA can be detected if the DNA has previously been treated with chloroacetaldehyde, a chemical mutagen that reacts with adenine, cytosine, and guanine (Premaratne et al. 1993). A more practical way to enhance fluorescence is to destain the gel in a solution containing 10 mM Mg<sup>2+</sup> before examining it under UV illumination (Sambrook et al. 1989).

### **Quantitating Double-stranded DNA**

The formation of complexes between DNA and ethidium bromide can be observed with the naked eye because of the large metachromatic shift in the absorption spectrum of the drug that accompanies binding. The original maximum at 480 nm (yellow-orange) is shifted progressively to 520 nm (pink) with a characteristic isosbestic point at 510 nm. This provides a simple way to estimate the concentration of a sample of DNA by quantitative spectrophotometry (Waring 1965).

A faster and more sensitive method utilizes the UV-induced fluorescence emitted by intercalated ethidium bromide molecules. Because the amount of fluorescence is proportional to the total mass of DNA, the quantity of DNA can be estimated by comparing the light emitted by the sample at 590 nm with that of a series of standards (for more information on quantifying DNA with ethidium bromide, please see Appendix 8).

### **Improved Versions of Ethidium Bromide**

Dimers of intercalating dyes bind to DNA with much greater affinity than the parent monomeric compound (Gaugain et al. 1978). Homodimers of ethidium bromide and heterodimers of acridine and ethidium are therefore much more sensitive reagents for detecting DNA than is monomeric ethidium bromide. For example, as little as 30 pg of DNA can be detected on a confocal fluorescence gel scanner (e.g., please see Glazer et al. 1990; Glazer and Rye 1992). However, the price for this increase in sensitivity is very steep; 1 mg of ethidium homodimer costs about ten times more than 1 g of ethidium bromide. Unsymmetric cyanine dyes unrelated to ethidium bromide are more sensitive detectors of DNA, but these dyes are also expensive (please see section on SYBR Dyes below). For information on disposal of ethidium bromide, please see Appendix 8.

## **Methylene Blue**

Also known as Swiss Blue, in recognition of the nationality of Caro who first synthesized the dye in 1876, methylene blue (Fierz-David and Blangey 1949) is sometimes used as a stain for RNA that has been transferred to nitrocellulose filters or to certain types of nylon filters (Herrin and Schmidt 1988) (please see Chapter 7, Protocol 7).

Methylene blue may also be used to stain bands of DNA in agarose gels (please see the panel on **BRIEF PROTOCOL**). The aim is to avoid the use of ethidium bromide and to minimize the exposure of the DNA to UV irradiation, which can generate pyrimidine dimers and lower the biological activity of the DNA. This problem does not seem to be serious, but it is nevertheless a source of concern to some investigators.

Methylene blue has two absorption maxima (668 and 609 nm) in the visible spectrum, and is soluble in H<sub>2</sub>O. For staining RNA immobilized on nylon or nitrocellulose, the dye is used at a concentration of 0.04% in 0.5 M sodium acetate (pH 5.2). Staining is reversible and can be carried out before hybridization.

**BRIEF PROTOCOL****Staining DNA in Gels with Methylene Blue**

1. Load and run a gel cast with GTG agarose in 1× TAE buffer.

The smallest amount of DNA that can be reliably detected as a band by staining with methylene blue is ~40 ng. It is therefore necessary in most cases to load 2–3 times the normal quantity of DNA into the gel.

2. At the end of the electrophoretic run, place the gel in a glass dish containing 5 gel volumes of a solution containing 0.001–0.0025% methylene blue (available from Sigma) in 1 mM Tris-acetate (pH 7.4), 0.1 mM EDTA (pH 8.0).
3. Incubate the gel for 4 hours at room temperature, with gentle agitation on a rotary shaker.
4. Rinse the gel briefly in distilled H<sub>2</sub>O and examine it on a light box of the kind used to illuminate X-ray films.

**Silver Staining**

Count Albert von Bollstadt (1193 or 1206–1280) is thrice famous. He was the teacher of St. Thomas Aquinas, he was an alchemist who described arsenic so clearly that he sometimes receives credit for the discovery of the element, and, of relevance to molecular cloning, he recorded that silver nitrate would stain human skin. Eight centuries later, silver staining has been refined into a highly sensitive technique for postelectrophoretic detection of DNA bands in polyacrylamide and agarose gels. At its best, silver staining can detect bands containing <1.0 ng of DNA. Described below are three general types of silver staining (Merril 1987, 1990; Mitchell et al. 1994).

- **Photo development**, like conventional photography and fluorography, uses photonic energy to reduce silver ions to the metallic element. Unfortunately, the simplicity and speed of the method cannot compensate for its lack of sensitivity, which is no better than can be achieved by conventional staining with ethidium bromide.
- **Diammine staining** methods use ammonium hydroxide to generate silver diammine complexes, which bind to the nucleic acid (Yuksel and Gracy 1985). Silver ions are then liberated from the complexes by decreasing the concentration of ammonium ions with citric acid. The liberated silver ions are finally reduced to metallic silver by formaldehyde. The basic method established by Johansson and Skoog (1987) is both rapid and reasonably sensitive (0.5–2 ng of DNA/band); greater sensitivity (0.1–1 ng DNA/band) can be achieved using the modifications described by Vari and Bell (1996). However, in our hands, it is difficult to achieve such high sensitivity on a regular basis. In addition, ammoniacal silver salts are potentially explosive and must be handled with great care.
- **Nondiammine staining** involves, for example, fixation of the DNA, sensitization of the DNA with glutaraldehyde, impregnation of the gel or membrane with silver nitrate at weakly acidic pH, and reduction of bound silver ions to metallic silver by alkaline formaldehyde. Many different variants of this technique have been published, but most of them suffer to a greater or lesser extent from the same problem: Bands of DNA stain gray or dog-yellow against a variable background of brownish surface staining (Vari and Bell 1996). This problem can be minimized, as in the protocol below, by carefully monitoring the gel during development so as to obtain the greatest discrimination between specific staining of the DNA and background staining of the gel. Differential reduction of silver ions can be improved by adding sodium thiosulfate to the alkaline formaldehyde solution (Bassam et al. 1991); thiosulfate removes silver ions from the gel surface by forming soluble complexes with silver salts. When working well, the nondiammine staining can detect bands of DNA containing 2–5 ng of DNA. A nondiammine silver staining is marketed by Promega as part of the Silver Sequence DNA sequencing kit. The

nondiammine staining method outlined below is simple and is sensitive enough to detect a band containing 2–5 ng of DNA in a polyacrylamide gel. The protocol was kindly provided by Dr. Sue Forrest (Victorian Clinical Genetics Service, Melbourne, Australia).

## Silver Staining of DNA in Nondenaturing Polyacrylamide Gels

The volumes in the protocol are appropriate for staining a 150 × 150-mm polyacrylamide gel. Gels of this size are often used to analyze single-stranded DNA by SSCP (please see Chapter 13).

### MATERIALS

---

**CAUTION: Please see Appendix 12 for appropriate handling of materials marked with <!>.**

*Acetic acid (3% v/v) <!>*

*Developer*

Dissolve 22.9 g of sodium carbonate in a final volume of 1 liter of distilled H<sub>2</sub>O. Store the solution at room temperature away from direct light (e.g., in a closet).

*Ethanol (10% v/v)*

*Ethanol/Glycerol (10% and 7% v/v, respectively)*

*Formaldehyde (37% v/v) <!>*

*Nitric acid (0.7% v/v) <!>*

*Silver nitrate (0.2% w/v), freshly prepared <!>*

### METHOD

---

1. After electrophoresis is complete, place the gel, still attached to one glass plate, in a plastic tray reserved for silver staining. Do not touch the surface of the gel at any time.  
Because pressure on the gel causes background staining, the various solutions used for silver staining are removed from the plastic tray with a pipette attached via a trap to a vacuum line.
2. Rinse the gel twice with distilled H<sub>2</sub>O to remove electrophoresis buffer. During rinsing, the gel will float free and the glass plate can then be removed.
3. Fix the gel in 10% ethanol by gentle shaking for 10 minutes on a rocking platform. Remove the 10% ethanol by suction and repeat the process.  
If necessary, the gel can be left for several hours in the second batch of 10% ethanol.
4. Remove the ethanol by suction and add just enough 0.7% nitric acid to cover the gel. Shake the gel gently on a rocking platform for 6 minutes. Remove the nitric acid by suction and rinse the gel with two changes of distilled H<sub>2</sub>O.
5. Add just enough 0.2% silver nitrate to cover the gel. Shake the gel gently on a rocking platform for 30 minutes. Rinse the gel and the staining tray three times with distilled H<sub>2</sub>O.  
The silver nitrate solution may be reused but staining then may become unreliable.
6. To 100 ml of developer, add 125 µl of formaldehyde solution. Transfer the developer/formaldehyde solution to the staining tray and shake the tray gently in an indirect light (e.g., cover the container with aluminum foil). When the solution turns yellow or when a dark precipitate becomes noticeable, replace the developer/formaldehyde with a second batch of 100 ml of the same solution. Continue to shake the gel in indirect light. Monitor the appearance of bands and background. When the ratio of signal to noise is at its maximum, remove the second batch of developer/formaldehyde.

7. Add 250 ml of 3% acetic acid to the staining tray. Shake the gel gently for 5 minutes.
8. Remove the 3% acetic acid and wash the gel with 10% ethanol. Remove the ethanol and then store the gel for 2 minutes in a fresh batch of 10% ethanol.
9. Photograph the gel by transillumination on a white light box using Polaroid 667 film. The best photographs are obtained when the area around the gel is covered with black paper.
10. For long-term storage, either keep the gel in 10% ethanol/7% glycerol or dry it as follows:
  - a. Lay a glass plate 2 cm longer and wider than the gel across the top of a beaker.
  - b. Wet a piece of Saran Wrap approximately the same size as the glass plate. Lay the wet wrap on the glass plate, taking care to remove any air bubbles.
  - c. Place the gel in the center of the piece of Saran Wrap and then cover it with another piece of pre-wet wrap, the same size as the first. Remove all wrinkles and air bubbles.
  - d. Place gel spacers, ~1 cm thick on the Saran Wrap around the four edges of the gel. Use a series of bulldog clips to clamp the gel spacers to the glass plate.
  - e. Allow the gel to dry for 24–48 hours, until the Saran Wrap feels crisp.

## SYBR Dyes

The SYBR dyes are unsymmetric cyanine compounds, developed by Molecular Probes, that have some advantages as stains for DNA and RNA over phenanthridine dyes such as ethidium bromide. The information about SYBR dyes in the scientific literature is sparse. However, the Web Site of the manufacturer (<http://www.probes.com>) has much useful information, which is summarized below. For further details on the advantages and use of SYBR dyes, please see Chapter 5, Protocol 2.

Three SYBR dyes are used in molecular cloning: SYBR Green I and II and SYBR Gold. All three dyes are essentially nonfluorescent in free solution but, upon binding to nucleic acids, display greatly enhanced fluorescence and a high quantum yield. SYBR Green I, for example, has a quantum yield of 0.8 upon binding to double-stranded DNA, whereas SYBR Gold has a quantum yield of 0.7 and 1000-fold enhancement of fluorescence (Tuma et al. 1999). Because the SYBR dyes generate strong signals with very little background and have a high affinity for nucleic acids, they can be used in low concentrations and are more sensitive than conventional stains such as ethidium bromide. SYBR Green I and II, however, have some less desirable characteristics:

- These dyes are not optimally stimulated by standard transilluminators that emit UV radiation at 300 nm. The signal strength improves when illumination at 254 nm is used, but at this wavelength, damage to DNA is maximal.
- Both dyes penetrate agarose gels slowly. Postelectrophoretic staining can take 2 hours or more when the gels are thick or contain a high concentration of agarose.
- The dyes are not particularly photostable.
- SYBR Green I is only slightly more sensitive than ethidium bromide in detecting single-stranded DNA in agarose gels.

For these reasons, SYBR Green I and II are not commonly used to stain DNA in agarose gels. However, SYBR Green II detects RNA in denaturing agarose gels with fivefold greater sensitivity than ethidium bromide and does not interfere with northern transfer. The dye is therefore useful when analyzing quantities of RNA that are too small to be detected by ethidium bromide. SYBR

Green I, on the other hand, is used chiefly to quantify DNA in solution, for example, in real time polymerase chain reactions (please see the panel on **REAL TIME PCR** in Chapter 8, Protocol 15).

SYBR Gold, which has come onto the market more recently, is the best of the SYBR dyes. It is tenfold more sensitive than ethidium bromide, and its dynamic range is greater. Unlike SYBR Green I and II, SYBR Gold penetrates gels quickly and can therefore be used to stain DNA and RNA both in conventional neutral polyacrylamide and agarose gels and in gels containing denaturants such as urea, glyoxal, and formaldehyde. Because SYBR Gold most probably binds to the backbone of charged phosphate residues, the electrophoretic mobility of DNA stained with the dye is markedly retarded, and the bands of DNA are sometimes curved. For this reason, gels are stained with SYBR Gold after electrophoresis is complete. The level of background fluorescence is so low that no destaining is required. When excited by standard transillumination at 300 nm, nucleic acids stained with SYBR Gold generate bright gold fluorescent signals that can be captured on conventional black and white Polaroid film (type 667) or on charged couple device (CCD)-based image detection systems. The stained nucleic acids can be transferred directly to membranes for northern or Southern hybridization (Tuma et al. 1999).

Although many enzymatic reactions are not inhibited by SYBR Gold, polymerase chain reactions are sensitive to high concentrations of the dye. Inhibition can, however, be relieved by adjusting the concentration of  $Mg^{2+}$  (Tuma et al. 1999) or be avoided by removing SYBR Gold from the template DNA by standard ethanol precipitation.

SYBR Gold is supplied as a 10,000x concentrate in anhydrous dimethylsulfoxide (DMSO). The high cost of the dye precludes its use for routine staining of gels. However, the dye may be cost-effective as an alternative to radiolabeling or silver staining of DNA in techniques such as single-strand conformation polymorphism (SSCP) and denaturing gradient gel electrophoresis (DGGE).

## AUTORADIOGRAPHY AND IMAGING

The first autoradiograph was obtained in 1867, when Niepce de St. Victor described the blackening of emulsions of silver chloride and iodide by uranium nitrate and tartrate. The blackening occurred even when the uranium salt was separated from the emulsion by sheets of colored glass. At that time, radioactivity had not been discovered and Niepce struggled unsuccessfully to explain his results in terms of luminescence.

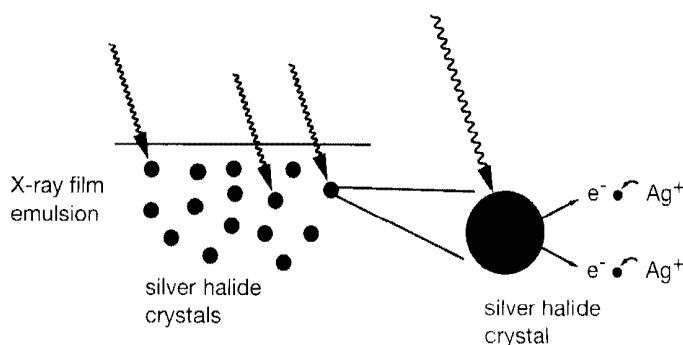
Molecular cloning depends on techniques to map accurately the distribution of radioactive atoms on two-dimensional surfaces. For the last 20 years, autoradiographic images of Southern blots, northern hybridizations, DNA sequencing gels, and library screens have been the icons of the field. In autoradiography, a radioactive specimen emits radiation, generally in the form of  $\beta$ -particles whose image is recorded on photographic emulsion. A diagram of the events that occur during exposure of photographic emulsion to radioactivity is shown in Figure A9-1.

The emulsions used in autoradiography are suspensions of crystals (grains) of silver halide in gelatin. Exposure to radiation activates the halide crystals, producing a latent image that can be converted to a true image by development. Each  $\beta$ -particle emitted by the sample converts a number of silver ions to silver atoms, which are then withdrawn from the crystal lattice. The resulting latent image is unstable since the atoms of silver tend to lose their captured electrons and to resume their places in the lattice. At room temperature, this return reaction has a half-time of  $\sim 1$  second. At  $-70^\circ\text{C}$ , the rate of the return reaction is much slower, and there is little fading of the latent image.

During development, the activated nuclei of silver atoms catalyze the conversion of the entire silver halide grain into metallic silver. In most emulsions, it is necessary to activate between 5 and 10 silver atoms per crystal in order to obtain complete conversion of the crystal during development. Crystals with fewer activated silver atoms have a lower chance of development. This means that the intensity of the final image is not proportional to the intensity of the incident radiation. Low levels of radiation will generate developed images that are disproportionately faint. In photography, this phenomenon is known as low-intensity reciprocity failure.

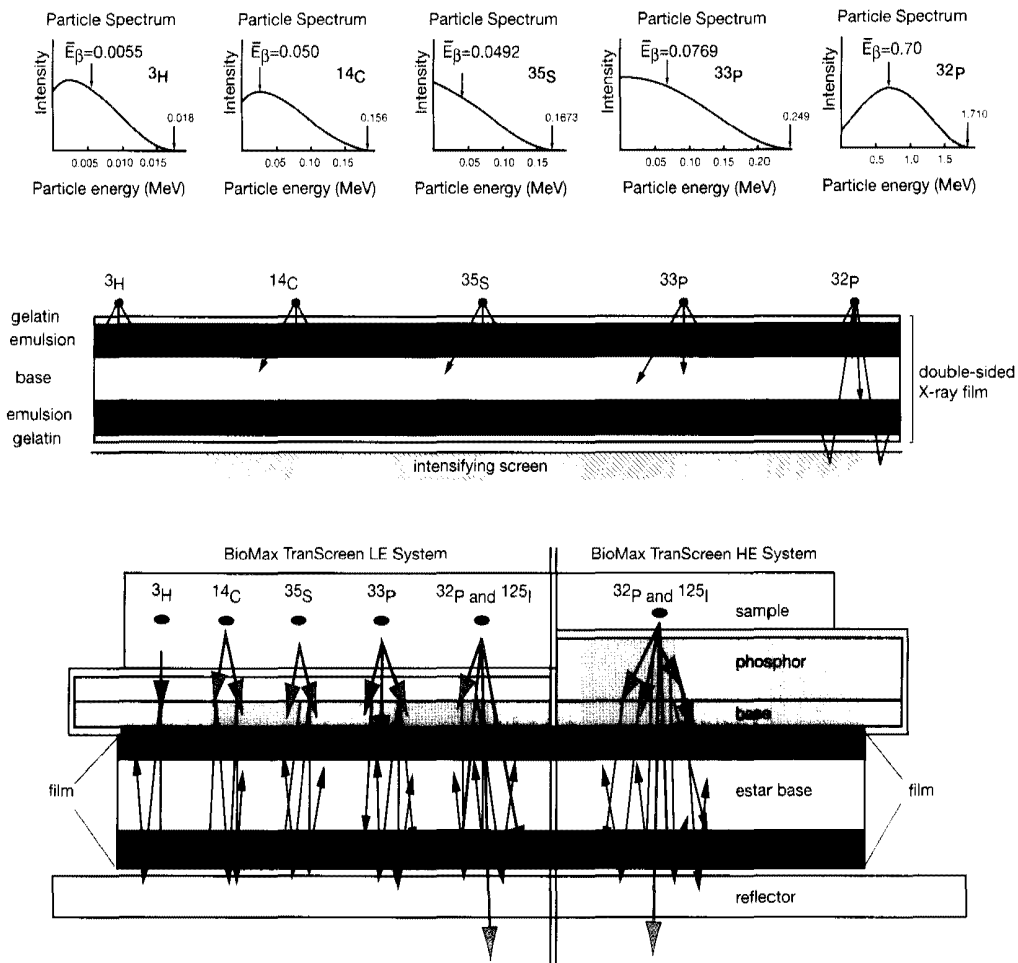
Conversely, exposure to an intense source of light or  $\beta$ -particles can saturate all of the silver bromide crystals so that the emulsion becomes refractory to further radiation. The density of such burnt images is no longer proportional to the intensity of the incident radiation. Developed images whose absorbance at 545 nm exceeds 1.3 on a microdensitometer have saturated the film and cannot be used to quantitate the intensity of the original source of radiation.

The three isotopes most commonly used for autoradiography are  $^{35}\text{S}$ ,  $^{33}\text{P}$ , and  $^{32}\text{P}$ , all of which emit  $\beta$ -particles. The energies of these particles are different:  $^{35}\text{S}$  emits a particle with a maximum energy of 0.167 MeV that can penetrate film emulsion only to a depth of 0.25 mm (see Figure A9-2).  $^{33}\text{P}$  emissions are slightly stronger (0.249 MeV) with a maximum penetration depth of 0.6 mm. Although this depth is sufficient to allow the emitted  $\beta$ -particles to interact productively with silver



**FIGURE A9-1** Events Leading to the Formation of an Autoradiographic Image

The diagram shows that particles entering the autoradiographic image cause ejection of electrons from silver halide crystals. These electrons attract positively charged silver ions, generating precipitates of silver atoms.



**FIGURE A9-2** Energy of Radiation Emitted by Commonly Used Isotopes

(Top) Graphs show the spectra of energies carried by particles emitted by decaying radioactive isotopes. In each case, the arrow marks the average energy per particle. (Middle) Diagram showing the depth to which commonly used isotopes penetrate autoradiographic film. (Bottom) Principle of Kodak BioMax TranScreen Systems (Modified, with permission, from Eastman Kodak Company; Kodak, BioMax, and TranScreen are trademarks of Eastman Kodak Company.)

halide crystals in the emulsion, it is not enough to allow the particles to pass through barriers (e.g., Saran Wrap) that might be placed between the film and the source of the radiation. Thus, when establishing autoradiographs of  $^{35}\text{S}$ - or  $^{33}\text{P}$ -labeled material, it is essential that the film and the source of the radiation be directly apposed to one another. To reduce internal absorption of radiation, gels should be as thin as possible and should be fixed and dried before autoradiographs are taken. Nitrocellulose and nylon filters should be thoroughly dried, and care should be taken to ensure that the surface carrying the radioactivity is placed in contact with the film. (Warning: Damp gels and membranes stick tightly to the film and usually cannot be removed.)

$^{32}\text{P}$ , by contrast to  $^{35}\text{S}$  and  $^{33}\text{P}$ , emits a  $\beta$ -particle with sufficient energy (1.709 MeV) to penetrate water or plastic to a depth of 6 mm and to pass completely through an X-ray film. Gels and filters therefore need not be completely dried (although the sharpness of the autoradiographic image is much improved if they are) and can be covered with Saran Wrap before they are exposed to the film. Radiation from  $^{32}\text{P}$  is strong enough to require shielding by 1-cm Plexiglas, which blocks  $\beta$ -particles while minimizing production of Bremstrahlung.

## AUTORADIOGRAPHY AND PHOSPHORIMAGING

---

### Intensifying Screens

Strong  $\beta$ -particles, such as those emitted by decay of  $^{32}\text{P}$ , can pass undetected through X-ray film. To increase the efficiency with which high-energy particles are detected, an intensifying screen may be placed behind the X-ray film. Radioactive particles that pass through the film hit the intensifying screen and cause it to emit photons that are captured by silver halide crystals in the emulsion. The efficiency of the intensifying screen is determined largely by the thickness of the phosphor layer. A thicker phosphor layer results in a "faster" screen because the thick layer absorbs more radiation than a thin layer. Thick screens are faster, but generate fuzzier images on film, due primarily to diffusion of light in the phosphor layer.

Most conventional intensifying screens are made of calcium tungstate, which emits blue light after capture of  $\beta$ -particles. Other screens contain rare earths such as lanthanum oxybromide (blue light) or gadolinium oxysulfide, which emits green light. Modern calcium tungstate screens such as Lightning Plus (Dupont, Cronex) enhance the intensity of an autoradiographic image by a factor of  $\sim 5$  when the film is exposed at low temperature ( $-70^\circ\text{C}$ ) to retard the decay of the latent image (Koren et al. 1970; Swanstrom and Shank 1978). Intensifying screens are usually used in pairs, with double-sided X-ray film and the  $^{32}\text{P}$ -labeled sample sandwiched between the two screens in a light-tight cassette.

Conventional intensifying screens do not improve the efficiency with which low-energy  $\beta$ -particles can be captured by X-ray film. It is therefore a waste of time to use these screens with samples that are labeled with  $^{35}\text{S}$ ,  $^{33}\text{P}$ ,  $^{14}\text{C}$ , or  $^3\text{H}$  (Laskey and Mills 1977; Sanger et al. 1977). However, specialized screens for use with these isotopes are available from Kodak. These screens are placed between the sample and the film.  $\beta$ -particles from the sample are captured by the screen and converted into photons, which are then detected by the film, as illustrated in Figure A9-2. The signal enhancement provided by TranScreen is generally equivalent to the sensitivity obtained using fluorography.

### Preflashing

The spectral emission of some phosphors requires that an appropriately sensitized film be used or much of the light will be wasted. Accordingly, the efficiencies with which low levels of radioactivity can be detected are increased by a further twofold by preexposing the film to a short ( $\sim 1$  msec) flash of light emitted by a stroboscope or a photographic flash unit. This exposure generates stable pairs of silver atoms within each silver halide crystal and therefore increases the probability that an incoming particle of radiation will generate an activated crystal, which will be reduced to silver metal during the developing process. The distance of the light source from the film during preexposure should be determined empirically as follows (Laskey and Mills 1975, 1977). Note that preflashing is not recommended for high-sensitivity films such as BioMax (Kodak). Preflashing these films induces high levels of background.

1. Cover the stroboscope or flash unit with an orange filter (Kodak, Wratten 21 or 22A). This filter reduces the amount of incident blue light, to which X-ray film is very sensitive.
2. Working in total darkness, place the film perpendicular to the light source and at least 50 cm away from it. This prevents uneven illumination. Cover the film with a diffusing screen. If a suitable screen is not available, use a piece of Whatman No. 1 filter paper.



3. Expose a series of test films to the light source for different lengths of time and then develop the films. Cut the films into pieces that will fit neatly into the cuvette holder of a spectrophotometer. Measure the absorbance at 545 nm of the exposed films against a blank consisting of film that was not preexposed. Choose an exposure time that causes the absorbance to increase by 0.15.

Pre flashed film has another advantage: The intensity of the image on the film becomes proportional to the amount of radioactivity in the sample (Laskey 1980). The intensity of autoradiographic images on preexposed film can therefore be quantitated by microdensitometry and be used to measure the amount of radioactivity in the original sample. By contrast, the silver halide crystals in film that is not preexposed to light are not fully activated and therefore respond in a sigmoidal fashion to increasing amounts of radioactivity (Laskey and Mills 1975, 1977). This relationship can complicate quantitation of autoradiographic images. The best types of films, for all types of autoradiography except fluorography, are Kodak X-Omat-R and Fuji RX. When preexposed, these films yield images whose absorbances are proportional to the intensity of the source of radioactivity over a range of 0.15–1.0. However, true linear responses are only obtained when (1) the background absorbance of the film at 545 nm is raised to an OD of 0.10–0.20 and (2) the presensitizing flash is brief (~1 msec).

## Fluorography

The intensity of autoradiographic images of weak  $\beta$ -emitters such as  $^3\text{H}$ ,  $^{14}\text{C}$ , and  $^{35}\text{S}$  can be enhanced by impregnating the samples with chemicals that are fluorescent and emit many photons when they encounter a single quantum of radiation (Wilson 1958, 1960). Fluorography increases the sensitivity of detection of  $^{14}\text{C}$  and  $^{35}\text{S}$  approximately tenfold and permits detection of  $^3\text{H}$ , which is otherwise virtually invisible to conventional autoradiography. Fluorography is therefore particularly useful for the detection of radiolabeled proteins and nucleic acids in polyacrylamide gels.

In the original methods (Bonner and Laskey 1974; Laskey and Mills 1975), aqueous gels containing the radioactive samples were equilibrated with DMSO, impregnated with the scintillant PPO (2,5-diphenyloxazole), soaked in  $\text{H}_2\text{O}$  to remove the DMSO, dried, and exposed to X-ray film at  $-70^\circ\text{C}$ . These procedures were costly, tedious (requiring at least 5 hours of work), and irreproducible in inexperienced hands. The most frequent cause of difficulty was the failure to remove DMSO: Complete removal is essential to avoid sticky gels after drying. Because of these problems, a number of alternative solvents have been developed to deliver PPO to the sample. These include ethanol (Laskey 1980), glacial acetic acid (Skinner and Griswold 1983), and several other organic solvents (e.g., please see Shine et al. 1974; Southern 1975).

Despite these improvements, PPO has now largely been replaced as a scintillant by sodium salicylate (Chamberlain 1979) or by commercial scintillants (see below). With sodium salicylate, the level of enhancement is approximately equal to that obtained with organic scintillants, although the bands are slightly more diffuse. Commercially available aqueous scintillants such as En<sup>3</sup>Hance, Enlightning, or Entensify (NEN Life Science Products) and Amplify (Amersham) are supplied in liquid and spray-on form and, if used in accordance with the manufacturer's instructions, give results every bit as good as those obtained with PPO, with far less work. However, they are exceedingly expensive.

The types of X-ray film used for fluorography should match the fluorescence spectrum of the scintillant. Sodium salicylate emits at 409 nm, whereas PPO emits at 375 nm. Commercial enhancers emit either blue or UV light. Films that are sensitive in this region of the spectrum are called "screen-type" X-ray films and include Kodak BioMax MS, Amersham Hyperfilm-MP, and Fuji RX.

TABLE A9-1 Sensitivity of Autoradiographic Methods for Detection of Radioisotopes

ISOTOPE	METHOD	SENSITIVITY (dpm/mm <sup>2</sup> )
<sup>35</sup> S	no enhancement	30–60
	fluorography	2–3
	TranScreen LE (Kodak)	0.8–1.2
<sup>32</sup> P	direct	2–5
	intensifying screen	0.5
	TranScreen HE (Kodak)	0.05–0.1
<sup>33</sup> P	direct	15–30
	intensifying screen	1–1.5
	TranScreen LE (Kodak)	0.4–0.6
<sup>14</sup> C	fluorography	2
	TranScreen LE (Kodak)	0.8–1.2
<sup>125</sup> I	intensifying screen	1–2
<sup>3</sup> H	fluorography	10–20
	TranScreen LE (Kodak)	74–110

### Sensitivity of Different Autoradiographic Methods

Table A9-1 shows the sensitivities of different autoradiographic methods for the detection of radioisotopes, with and without various enhancements. The amounts of radioactivity shown in the table are those required to obtain a detectable image ( $A_{545} = 0.02$ ) on preflashed film that is exposed to the sample for 24 hours. Much longer exposure times may be necessary to obtain publishable images.

### Setting up Autoradiographs

1. Prepare gels for autoradiography in one of the following ways:
  - a. Fix the SDS-polyacrylamide gels containing <sup>33</sup>P or <sup>35</sup>S, <sup>14</sup>C, or <sup>3</sup>H as described in Chapter 5, Protocol 11. Use a commercial gel dryer to dry the gels onto Whatman 3MM paper.
  - b. Fix the sequencing gels containing <sup>33</sup>P or <sup>35</sup>S as described in Chapter 12, Protocol 12. Use a commercial gel dryer to dry the gels onto Whatman 3MM paper.
  - c. For maximal sensitivity and resolution, fix, dry, and mount the polyacrylamide gels containing <sup>32</sup>P on backing paper.

Satisfactory images of wet, unfixd gels can also be obtained as long as the gels are sealed in a plastic bag or wrapped in Saran Wrap before they are exposed to the film (please see Chapter 5, Protocol 11). <sup>32</sup>P-labeled nucleic acids in agarose gels can be detected by exposing the wet gel (wrapped in Saran Wrap) to X-ray film. However, for maximal sensitivity and resolution, transfer the radiolabeled nucleic acids to a solid support (nitrocellulose or nylon membrane) as described in Chapter 6, Protocol 8. Dry the solid supports and cover with Saran Wrap to prevent contamination of intensifying screens and film holders.

2. Place pieces of tape marked with radioactive ink around the edge of the sample on the backing paper or Saran Wrap. Cover the pieces of tape with Scotch Tape. This arrangement prevents contamination of the film holder or intensifying screen with the radioactive ink.

Alternatively, attach luminescent labels to the paper or Saran Wrap. These may be purchased from several manufacturers (e.g., Stratagene).

3. In a darkroom, place the sample in a light-tight X-ray film holder and cover it with a sheet of X-ray film. If preflashed film is used, the preexposed side should face the sample; if an intensifying screen is used, the preexposed side should face the intensifying screen.
4. Expose the film for an appropriate length of time (see Table A9-1). When conventional intensifying screens or fluorography is used, the film must be exposed at  $-70^{\circ}\text{C}$ . The low temperature stabilizes the silver atoms and ions that form the latent image of the radioactive source.
5. Remove the film holder from storage (use gloves to handle holders stored at  $-70^{\circ}\text{C}$ ). In a darkroom, remove the film as quickly as possible and allow it to warm up to room temperature before developing.

If it is necessary to obtain another autoradiograph, apply another film immediately and return the film holder and screens to the freezer as rapidly as possible. If condensation forms before the new film can be applied, allow the sample and screens to reach room temperature and wipe away all condensation before applying the new film.

6. Develop the X-ray film either in an automatic X-ray film processor or by hand as follows:

X-ray developer

5 minutes

3% acetic acid stop bath or water bath

1 minute

rapid fixer

5 minutes

running water

15 minutes

The temperatures of all solutions should be  $18\text{--}20^{\circ}\text{C}$ .

7. Use the images of the radioactive or luminescent markers to align the autoradiograph with the sample.

## Phosphorimaging

Autoradiography has been the mainstay of molecular cloning for many years. Recently, however, two types of phosphorimaging devices have become available that create images of radiation sources on computer screens rather than on conventional photographic film. One type of device (area detector) scans the gel or filter in small windows with a Geiger counter, compiling a contour map of the number of radioactive disintegrations per unit area. The other device uses plates coated with a light-responsive phosphor. The film or filter is directly exposed to the plates, and the energy emitted is stored in a europium-based coating. The plates are then scanned by a laser, releasing photons that are collected to form an image. Both devices present the image on a computer screen. These instruments are more expensive than those required for conventional autoradiography and the images have a lower resolution. However, the images can be detected in  $\sim 10\text{--}20\%$  of the time required by conventional autoradiography and a darkroom is not required. In addition, the linear range of imaging instruments extends over about five orders of magnitude, an improvement of at least 100-fold over conventional X-ray film. Densitometric analysis of images is therefore more accurate and far simpler. Details of phosphorimaging methodology will vary with the device used and manufacturers' instructions should be followed. The images are captured electronically and can be stored and prepared for publication using programs such as Adobe Photoshop (Adobe Systems Incorporated).

Isotopic Data

TABLE A9-2 Isotopic Data

<sup>3</sup> H		<sup>35</sup> S		<sup>32</sup> P	
TIME (YEARS)	% ACTIVITY REMAINING	TIME (DAYS)	% ACTIVITY REMAINING	TIME (DAYS)	% ACTIVITY REMAINING
1	94.5	2	98.4	1	95.3
2	89.3	5	96.1	2	90.8
3	84.4	10	92.3	3	86.5
4	79.8	15	88.7	4	82.4
5	75.4	20	85.3	5	78.5
6	71.3	25	82.0	6	74.8
7	67.4	31	78.1	7	71.2
8	63.7	37	74.5	8	67.8
9	60.2	43	71.0	9	64.7
10	56.9	50	67.0	10	61.5
11	53.8	57	63.6	11	58.7
12	50.9	65	59.6	12	55.9
12.3	50.0	73	56.0	13	53.2
		81	52.5	14	50.7
		87.1	50.0	14.3	50.0

<sup>125</sup> I		<sup>131</sup> I		<sup>33</sup> P	
TIME (YEARS)	% ACTIVITY REMAINING	TIME (DAYS)	% ACTIVITY REMAINING	TIME (DAYS)	% ACTIVITY REMAINING
4	95.5	0.2	98.3	2	94.7
8	91.2	0.4	96.6	4	89.7
12	87.1	0.6	95.0	6	84.9
16	83.1	1.0	91.8	8	80.4
20	79.4	1.6	87.2	10	76.1
24	75.8	2.3	81.2	12	72.1
28	72.4	3.1	76.7	14	68.3
32	69.1	4.0	71.0	16	64.6
36	66.0	5.0	65.2	18	61.2
40	63.0	6.1	59.3	20	57.9
44	60.2	7.3	53.4	22	54.9
48	57.4	8.1	50.0	24	52.0
52	54.8			25.4	50.0
56	52.4				
60	50.0				

One Curie (Ci) is equivalent to the amount of an isotope undergoing  $3.7 \times 10^{10}$  nuclear disintegrations/second ( $2.22 \times 10^{12}$  disintegrations/minute). 1 Ci =  $3.7 \times 10^{10}$  becquerels (Bq).

- 1 Bq =  $2.7 \times 10^{-11}$  Ci
- 1  $\mu$ Ci =  $37 \times 10^3$  Bq = 37 kBq =  $2.22 \times 10^6$  dpm
- 1 mCi =  $37 \times 10^6$  Bq = 37 MBq =  $2.22 \times 10^9$  dpm
- 1 Ci =  $37 \times 10^9$  Bq = 37 GBq =  $2.22 \times 10^{12}$  dpm

## CHEMILUMINESCENCE

Larry J. Kricka

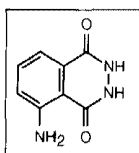
Department of Pathology and Laboratory Medicine, University of Pennsylvania, Philadelphia

Radioactive reagents have been gradually replaced by nonisotopic reagents for some tasks in molecular biology. Concern over laboratory safety and the economic and environmental aspects of radioactive waste disposal have been key factors in this change. Generally, the new nonisotopic systems have improved in terms of analytical sensitivity and the time required to obtain a result. The most prominent nonisotopic analytical methods exploit chemiluminescence. This technique has been particularly effective when used in combination with an enzyme label, so that the amplifying properties of an enzyme label and the high sensitivity of a chemiluminescent detection reaction are combined to produce an ultrasensitive assay (e.g., chemiluminescent detection of peroxidase- and alkaline-phosphatase-labeled proteins and nucleic acid probes). In all of the commonly used applications in molecular biology, the analytical performance of the chemiluminescent systems approaches that of  $^{125}\text{I}$ - or  $^{32}\text{P}$ -based systems. Chemiluminescent systems also avoid the lengthy signal detection times required with  $^{32}\text{P}$ -based methods, yielding results in minutes rather than days. In addition, chemiluminescent probes can be easily stripped from membranes, allowing the membranes to be reprobbed many times without significant loss of resolution. Experimental protocols for directly attaching nonisotopic labels to nucleic acids and indirect labeling methods based on biotin, fluorescein, and digoxigenin labels are now well established. The ancillary reagents (e.g., avidin, streptavidin, antidigoxigenin, and antifluorescein enzyme conjugates) required for the indirect methods are widely available. In addition, several companies have developed complete kits of labeling and detection reagents to simplify and facilitate the application of the chemiluminescent assays.

Chemiluminescence is the light emission produced in certain chemical reactions as a result of the decay of chemi-excited intermediates to the electronic ground state. Most chemiluminescent reactions are oxidation reactions because the production of visible light requires highly energetic reactions (63.5 kcal/mole for visible light at 450 nm) (please see the panel on **CHEMILUMINESCENT REACTIONS**).

### CHEMILUMINESCENT REACTIONS

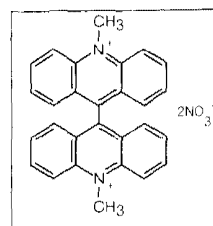
Acridinium ester + peroxide + base  
 Adamantyl 1,2-dioxetane aryl phosphate + alkaline phosphatase  
 Lucigenin + peroxide + base  
 Luminol + peroxide + base  
 Nitric oxide + ozone  
 bis(2,4,6-trichlorophenyl)oxalate + peroxide + fluorescer



Generally, chemiluminescent reactions are inefficient, especially in aqueous environments, and the chemiluminescent quantum yields are typically <10%. Despite such inefficiency, this type of reaction is analytically useful and there are many highly sensitive assays based on compounds with quantum yields of only 1% (e.g., luminol [5-amino-2,3-dihydro-1,4-phthalazinedione]; the chemical structure of luminol is shown at the left).

Chemiluminescence has a long history (for a review, please see Campbell 1988) and some of the compounds in routine use today have been known for a long time. Luminol was first synthesized in 1853 (its chemiluminescent properties were not recognized until 1928), and lucigenin

(bis-*N*-methylacridinium nitrate; the chemical structure of lucigenin is shown at the right) was synthesized in 1935. Chemiluminescent reactions are known in the gas phase (reaction of nitric oxide and ozone), liquid phase (e.g., luminol oxidation reaction), and solid phase (e.g., phosphorous oxidation reaction) (Gundermann and McCapra 1987; Campbell 1988; Van Dyke and Van Dyke 1990).



There are numerous applications for chemiluminescent reactions ranging from the familiar emergency lighting that exploits the fluorescence-sensitized peroxyoxalate oxidation reaction (Cyalume Lightsticks) to the study of phagocytosis using lucigenin or luminol to enhance weak cellular chemiluminescence (Allen and Loose 1976). In molecular biology, chemiluminescent compounds are used as labels in nucleic acid probe and protein blotting applications (e.g., Southern and western blotting), and as reagents to detect enzyme-labeled nucleic acids and proteins (Tables A9-3 and A9-4) (Kricka 1992; Nozaki et al. 1992). Specific advantages of chemiluminescent assays and protocols are improved sensitivity over conventional radiometric, colorimetric, and fluorometric detection systems, hazard-free reagents, rapid results, and versatile assay formats (e.g., solution- and membrane-based assays).

## Chemiluminescent Labels

### Acridinium Esters and Related Compounds

Light emission from an acridinium-ester-labeled antigen or antibody, prepared using an activated label (2',6'-dimethyl-4'-[*N*-succinimidylloxycarbonyl]phenyl 10-methylacridinium-9-carboxylate), is triggered by simply adding a mixture of sodium hydroxide and hydrogen peroxide. The light is emitted as a rapid flash lasting <5 seconds, and this time scale imposes certain constraints on the initiation of light production and its measurement (Weeks et al. 1983; Law et al. 1989). Usually, the light emission is measured by injecting the reagents into the assay tube positioned directly in front of a photodetector in the light-tight measuring chamber of the luminometer. Acridinium esters and the acridinium carboxamide analogs (acridinium-9-[*N*-sulfonyl]carboxamide) (Kinkel et al. 1989; Mattingly 1991) are the principal chemiluminescent labels used in immunoassay (available from Assay Designs Inc, Athens, GA; Behringwerke AG, Marburg, Germany; Ciba Corning Diagnostics, Medfield, MA, and Molecular Light Technology Research Ltd, Cardiff, UK). The detection limit for this type of label is ~0.5 attomole ( $0.5 \times 10^{-18}$  moles).

Nonseparation DNA probe assays based on hybridization protection have been devised (Arnold et al. 1989). This type of assay does not require the separation of bound from unbound labeled species and so can be conveniently performed in a single step. The hybridization protection assay format exploits the millionfold difference in the hydrolysis rate of an acridinium-ester-

**TABLE A9-3 Chemiluminescent Assays for Immunoassay and Nucleic Acid Hybridization Labels**

ENZYME	SUBSTRATE	DETECTION LIMIT (ZEPTOMOLES)
Acridinium ester	NaOH + peroxide	500
Alkaline phosphatase	AMPPD	1
$\beta$ -D-galactosidase	AMPGD	30
Horseradish peroxidase	luminol + perborate + 4-iodophenol	5,000
Isoluminol	microperoxidase + peroxide	50,000
Xanthine oxidase	luminol + Fe EDTA	3,000

Bronstein and Kricka (1989); Kricka (1991).

**TABLE A9-4 Applications of Chemiluminescence in Molecular Biology**

TECHNIQUE	EXAMPLE	REFERENCES
Cell surface molecule analysis	CD2	Meier et al. (1992)
Colony screening	<i>E. coli</i> transformed with pSP65 containing <i>N-ras</i> proto-oncogene	Stone and Durrant (1991)
DNA fingerprinting	Plant and fungal genomes; forensics	Decorte and Cassiman (1991); Bierwerth et al. (1992)
DNA sequencing	Single vector and multiplex	Beck et al. (1989); Creasey et al. (1991); Martin et al. (1991); Karger et al. (1993)
Dot/slot blots	M13 single-stranded DNA	Stone and Durrant (1991)
Gel mobility shift assay	DNA-binding protein complex AP-1 (Jun/Fos)	Ikeda and Oda (1993)
In situ hybridization	Herpes simplex virus I	Bronstein and Voyta (1989)
Northern blotting	LDL receptor IL-6, PGDF	Höltké et al. (1991) Engler-Blum et al. (1993)
PCR product detection	<i>bcl-2</i> t(14:18) chromosomal translocation; <i>Listeria monocytogenes</i>	Nguyen et al. (1992); Holmstrom et al. (1993)
Plaque screening	M13mp8 containing <i>N-ras</i> proto-oncogene	Stone and Durrant (1991)
Reporter gene	$\beta$ -D-galactosidase <i>lacZ</i> gene	Jain and Magrath (1991)
Reverse transcriptase assay	HIV and lentivirus reverse transcriptase	Cook et al. (1992); Suzuki et al. (1993)
RFLP typing	<i>Clostridium difficile</i>	Bowman et al. (1991)
Southern blotting	pBR328 t-PA HLA class I antigens	Höltké et al. (1991) Cate et al. (1991) Engler-Blum et al. (1993)
Southwestern analysis	Protein: <i>c-myc</i> intron DNA interaction	Dooley et al. (1992)
Western blotting	HIV-1 antibodies; transferrin	Bronstein et al. (1992)

labeled probe that is hybridized to complementary target DNA and labeled probe free in solution. Hydrolysis using a pH 7.6 borate buffer destroys the chemiluminescent property of the label, and the light emission produced after the hydrolysis step is due solely to the hybridized labeled probe (available from Gen-Probe, San Diego, CA).

### **Luminol and Its Analogs**

Luminol was the first chemiluminescent compound to be used as an immunoassay label (Schroeder et al. 1978). Light emission is triggered by adding an oxidant (e.g., hydrogen peroxide) in the presence of a suitable catalyst (horseradish peroxidase, microperoxidase, ferricyanide). However, labeling via the 5-amino group of luminol reduced light emission by a factor of 10. Isoluminol, the 6-amino isomer of luminol, is less efficient than luminol (quantum yield 0.1%), but labeling at the 6-position increases the light emission by a factor of 10, and thus this compound, and its amino-substituted analogs, such as *N*-(4-aminobutyl)-*N*-ethylisoluminol (ABEI), have become the favored labels for immunoassay applications (Kohen et al. 1979; Pazzagli et al. 1982).

Pyridopyridazines represent a separate class of chemiluminescent compounds. Early data indicate that these compounds, particularly the 8-amino-5-chloro-7-phenyl and 8-hydroxy-7-phenyl derivatives, will be useful as labels and co-substrates for detection of peroxidase labels. Compared to luminol, these compounds have a much more intense chemiluminescence (~50-fold) (Masuya et al. 1992).

## Chemiluminescent Enzyme Assays

### *Alkaline Phosphatase*

Adamantyl 1,2-dioxetane aryl phosphates (e.g., AMPPD; disodium 3-(4-methoxy Spiro[1,2-dioxetane-3,2'-tricyclo[3.3.1<sup>3,7</sup>]decan]-4-yl)-phenylphosphate) and the 5-substituted analogs (e.g., 5-chloro; CSPD; available from Tropix Inc.) have become extremely popular as chemiluminescent substrates for alkaline phosphatase labels (Bronstein et al. 1989, 1990, 1991; Schaap et al. 1989). The detection limit for the enzyme is 1 zeptomole ( $10^{-21}$  moles) and the light emission is long-lived (>1 hour), thus making this an ideal system for use with membrane-based assays. The light emission from this reaction can be enhanced by a nylon membrane surface and by certain polymers, for example, polyvinylbenzyl(benzyl dimethylammonium) chloride. In the case of nylon, the enhancement is due to sequestering of the dephosphorylated intermediate in hydrophobic domains; these stabilize and minimize nonluminescent decomposition of the intermediate. Chemiluminescent assays for alkaline phosphatase labels are now used widely for blotting and DNA sequencing (Beck and Köster 1990; Tizard et al. 1990).

### *$\beta$ -galactosidase*

Adamantyl 1,2-dioxetane aryl galactoside substrates (AMPGD) for this enzyme are increasing in popularity. The enzyme cleaves the galactoside group from the 3-position of the aromatic ring to produce a phenoxide intermediate, and this compound decomposes to produce light. The detection limit for the enzyme using this assay is 30 zeptomoles.

### *Horseradish Peroxidase*

Luminol and other cyclic diacylhydrazides serve as chemiluminescent cosubstrates for horseradish peroxidase. The basic isoenzyme of horseradish peroxidase can be assayed in amounts <5 attomoles ( $5 \times 10^{-18}$  moles) using an assay reagent comprising luminol, hydrogen peroxide, and an enhancer (e.g., 4-iodophenol or 4-hydroxycinnamic acid) (Whitehead et al. 1983; Thorpe et al. 1985; Thorpe and Kricka 1986). Enhancement of the acidic isoenzymes of peroxidase is much less effective. The role of the enhancer is to increase the intensity of the light emission and reduce background light emission due to oxidation of luminol by peroxide or other oxidants. This dual effect has dramatic impact on the detection of peroxidase activity and increases the ratio of signal to background by several thousandfold (the enhanced chemiluminescent assay reagents are available from Amersham). This sensitive assay for peroxidase (>10-fold more sensitive than a colorimetric assay) has been combined effectively with the catalyzed reporter deposition (CARD) protocol (Wigle et al. 1993). In this amplification scheme, a peroxidase label reacts with a biotin tyramine substrate to produce highly reactive radical products that react with the label and any protein in the immediate vicinity of the label. Next, deposited biotin groups are reacted with streptavidin-peroxidase (in this way, the original peroxidase label is amplified manyfold), and bound peroxidase is detected using the enhanced chemiluminescent assay. Significant improvements in sensitivity were achieved using the combination of CARD and chemiluminescent detection as opposed to colorimetric detection of the deposited peroxidase.

### *Xanthine Oxidase*

This enzyme can be assayed using a mixture of luminol and an iron EDTA complex (Baret et al. 1990; Baret and Fert 1990). The assay is sensitive (detection limit 3 attomoles), and one notable advantage is that the light emission from the xanthine-oxidase-catalyzed chemiluminescent reaction is very long-lived (>96 hours).



### ***Glucose Oxidase***

Several chemiluminescent assays for glucose oxidase have been developed. Isoluminol or luminol in the presence of a microperoxidase catalyst can be used to assay peroxide produced by the action of glucose oxidase on glucose (Sekiya et al. 1991); alternatively, the peroxide can be measured using the chemiluminescent fluorophore-sensitized bis(2,4,6-trichlorophenyl) oxalate reaction (Arakawa et al. 1982).

### **Commercial Reagents, Kits, and Luminometers**

Comprehensive surveys of available chemiluminescent reagents and kits and luminometers for the measurement of light emission have been published (please see Stanley 1992, 1993). Also available are a series of compilations of references to current developments in both the fundamental and applied aspects of chemiluminescence (please see Kricka and Stanley 1992; Kricka et al. 1993; Wilkinson 1998). Chemiluminescence can be detected using a range of measuring devices, including a photomultiplier tube (in photon counting or less sensitive photon current mode) or silicon photodiode, or it can be imaged using a CCD camera (Wick 1989) or photographic film (Kricka and Thorpe 1986). CCD cameras are gaining in popularity because they are a convenient and sensitive means of detecting light emission from a two-dimensional source such as a membrane or a 96-well microplate. In addition, the kinetics of light emission are easily monitored, and image enhancement and background subtraction improve the quality of the results.

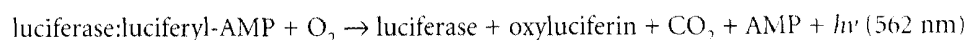
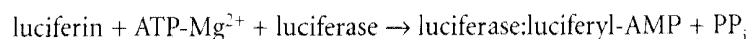
## BIOLUMINESCENCE

Bioluminescent organisms generate light from chemical reactions that are catalyzed by enzymes called luciferases. Many of these reactions are extremely efficient and produce about one photon per luciferase cycle. In the laboratory, light generated by the action of luciferases can be captured, amplified, and measured in a luminometer. A sensitive instrument can detect the light produced by the activity of  $2 \times 10^4$  luciferase molecules ( $10^{-20}$  moles), a level that is several orders of magnitude more sensitive than any non-light-producing enzymatic reaction. Because assays for luciferases are simple to perform, luciferase genes have become widely used as reporters which, when linked to appropriate regulatory elements, provide accurate measurements of the level of gene expression. In the short space of 3 or 4 years, luciferases have replaced chloramphenicol acetyltransferase (CAT) as the reporter system of choice. Assays for luciferase are more sensitive, faster, and less expensive than CAT assays; they do not require the use of radiolabeled compounds and may not involve the destruction of the host cells.

Luciferases are widely distributed in nature and are diverse in structure. The best studied are those of the common North American firefly *Photinus pyralis* (*Photinus* luciferin 4-mono-oxygenase) and the marine microorganism *Vibrio harveyi* (alkanal, reduced-FMN:oxido oxidoreductase). The properties and substrate specificities of these two luciferases are very different.

### Firefly Luciferase

Firefly luciferase catalyzes the oxidative decarboxylation of D(-) luciferin in the presence of ATP-Mg<sup>2+</sup> to generate oxyluciferin and light:



Luciferin is a generic term for substrates that generate light during oxidation catalyzed by luciferases. Firefly luciferin, 6-hydroxybenzothiazole [D-(-)-(6'-hydroxy-2'-benzothiazolyl)D<sup>2</sup>-thiazoline-4-carboxylic acid] was first isolated in pure form from fireflies in 1957 by Bitler and McElroy; 9 mg of pure luciferin was obtained from 15,000 fireflies. Nowadays, luciferin is synthesized chemically.

### Properties of Firefly Luciferase

Firefly luciferase is a 521-amino-acid protein with a predicted molecular weight of 57,000 (de Wet et al. 1987) that is targeted to peroxisomes in all organisms in which the protein is expressed (Keller et al. 1987; for review, please see Gould and Subramani 1988). The membrane-bound nature of peroxisomes undoubtedly limits access of substrates (luciferin and ATP) to the enzyme and may account for the low level of light produced when firefly luciferase is assayed in intact mammalian cells (de Wet et al. 1987; Gould and Subramani 1988). Deletion or mutation of the three carboxy-terminal amino acid residues generates cytosolic forms of the enzyme. Several of these cytoplasmic mutants appear to retain full enzymatic activity (Gould and Subramani 1988), but it is not yet known whether they are more accessible to substrates that are added to the extracellular medium.

In addition to tolerating changes at its carboxyl terminus, firefly luciferase will accept alterations to its amino terminus. The enzyme has been expressed in *E. coli* (1) as a fusion protein that lacks the first six amino acids of luciferase and contains eight amino-terminal residues encoded by the expression vector and the synthetic oligonucleotide used for cloning (de Wet et al. 1985) and (2) as a 92-kD fusion with a modified *Staphylococcus aureus* A protein (Subramani and

DeLuca 1988). A series of eukaryotic expression vectors for measuring promoter strength has been developed by Promega. A particularly useful version, the Dual Luciferase Reporter Assay System (DRL), encodes two luciferases, one from the firefly and the other from the sea pansy (*Renilla reniformis*). This dual reporter assay provides a convenient internal standard for normalization of gene expression measurements.

Firefly luciferase, isolated either from fireflies or from *E. coli* expressing a cloned copy of the luciferase gene, is available commercially (Boehringer Mannheim, Sigma, and Promega). A solution of purified firefly luciferase (1 mg/ml) has an absorbance at 280 nm of 0.75 (DeLuca and McElroy 1978).

### **Assays for Firefly Luciferase**

**Luminometry.** Addition of ATP and luciferin to preparations of firefly luciferase generates a flash of light that peaks 0.3 second later and lasts for a few seconds. Within 1 minute after mixing substrate and enzyme, the intensity of the emitted light falls to ~10% of peak values and then declines more slowly over a period of several minutes. The decay in light emission is caused by slow turnover of the enzyme and product inhibition by pyrophosphate (DeLuca and McElroy 1978). Dissociation of the enzyme-product complex occurs more efficiently in the presence of acetyl-coenzyme A (CoA) (Wood 1991) and nonionic detergents such as Triton X-100 (Kricka and DeLuca 1982). The concentration of ATP in the assay affects the intensity of light produced in the two phases of the reaction. Firefly luciferase has two distinct, catalytically active ATP-binding sites. One site is responsible for the initial flash, whereas the second, which has a higher affinity for ATP, is involved in the continuous production of light of lower intensity (DeLuca and McElroy 1984). Assays for luciferase generally contain concentrations of ATP that are sufficient to saturate both sites of the enzyme. Under these conditions, the amount of light emitted during the initial flash is proportional to the amount of enzyme in the reaction mixture over five orders of magnitude. Because of the short duration of the initial flash, most assays for luciferase require special luminometers that are designed to allow injection and rapid mixing of reagents and immediate analysis of the emitted light. A moderately priced luminometer can detect as little as 0.03–0.10 pg of luciferase.

An improved luciferase assay system is available from Promega. The system generates a burst of light whose intensity remains nearly constant for ~20 seconds and then decays slowly with a half-time of 5–10 minutes. These more favorable kinetics are achieved by including Triton X-100 and acetyl-CoA in the assay system. Luciferin is oxidized more efficiently by luciferyl-CoA than by luciferyl-AMP (Wood 1991). The emitted light can be measured either in a luminometer or in a liquid scintillation counter.

**Liquid scintillation spectroscopy.** If a luminometer is not available, firefly luciferase can be assayed in a conventional liquid scintillation counter. Reaction conditions have been reported that minimize the intensity of the initial flash and optimize the long-lasting emission of low-intensity light by firefly luciferase (Nguyen et al. 1988). The reactions are carried out in microfuge tubes or 96-well plates (Schwartz et al. 1990), and the emitted light is measured in a channel of a scintillation counter that detects chemiluminescence. Collection of data begins a few seconds after the reagents have been mixed and continues for 3–5 minutes. Under optimal conditions, measurement of long-lasting emission of light in a scintillation counter is as sensitive an assay for firefly luciferase as luminometry.

Some scintillation counters are not equipped with a preset channel for detection of chemiluminescence. However, the standard channels used for counting of atomic disintegration can be used for assay of luciferase provided the coincidence circuit is turned off. The counts per minute are then proportional to the intensity of luminescence. If the coincidence circuit cannot be turned

off, the intensity of luminescence will be proportional to the square root of the counts per minute after background has been subtracted.

**Photographic and X-ray film.** Firefly luciferase can be detected by exposing the light-emitting reaction to X-ray or photographic films (de Wet et al. 1986; Wood and DeLuca 1987). This method is useful for preliminary screening of samples for the presence or absence of firefly luciferase (e.g., screening tissue extracts of transgenic animals or estimating the relative efficiencies of a series of mutant promoters).

### ***Firefly Luciferase as a Reporter Molecule***

The use of luciferase as a reporter gene follows the same basic strategy developed for other reporter gene systems. In brief, a segment of DNA containing putative regulatory *cis*-acting elements is inserted into a plasmid upstream of a cloned copy of luciferase cDNA. The chimeric construct is used to transfect cultured cells of the appropriate type, and luciferase activity is assayed some time later in extracts of the transfected cells. When the assay is carried out in the presence of excess substrates, the amount of luminescence is proportional to the concentration of newly synthesized enzyme. Because extracts are likely to contain ATP, whose concentration is unknown, luciferase is generally measured by adding luciferin as the last substrate. Promoterless expression vectors for luciferase have been described by Nordeen (1988). Another suitable plasmid, pGEM-luc, sold by Promega, contains the firefly luciferase gene positioned in the center of the multiple cloning region of pGEM-11Zf(-).

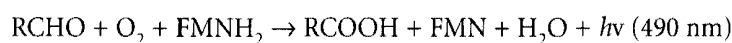
Cultures of mammalian cells ( $2 \times 10^5$  cells) transfected by the calcium phosphate method with a reporter construct in which expression of firefly luciferase is driven by a moderately strong promoter produce ~15–50 ng of luciferase. Luciferase activity is stable for several weeks in extracts of cells stored at 4°C.

Luciferase was first used in 1988 as a reporter for promoter activity in transgenic mice (DiLella et al. 1988). Since then, it has been used successfully as a reporter to measure the tissue specificity, developmental expression, and strength of more than a dozen different promoters in transgenic animals. Luciferase is commonly used as a reporter to locate and analyze regulatory elements in mammalian genes (e.g., please see van Zonneveld et al. 1988; Economou et al. 1989; Hudson et al. 1989). In addition, luciferase has been used (1) to identify proteins that influence gene transcription (Waterman et al. 1988; Mellon et al. 1989), (2) to investigate the effects of mRNA structure on protein synthesis (Baughman and Howell 1988; Malone et al. 1989), and (3) to measure rates of intracellular protein recycling (Nguyen et al. 1989). Luminometric measurements can detect  $\sim 5 \times 10^5$  molecules of luciferase in 10 mg of protein in a crude tissue extract, which is a fivefold increase in sensitivity over assays for CAT activity in tissue extracts (Robinson et al. 1989).

## **Bacterial Luciferase**

Luciferase of *Vibrio harveyi* is a heterodimer whose  $\alpha$  and  $\beta$  subunits (355 and 324 amino acids, respectively) are encoded by the bacterial *luxA* and *luxB* genes. These genes, which are part of an operon (Belas et al. 1982; for review, please see Ziegler and Baldwin 1981), have been cloned, sequenced, and expressed, first in *E. coli* (Baldwin et al. 1984; Cohn et al. 1985; Johnston et al. 1986) and then in plants, where the *luxA* and *luxB* cistrons were placed downstream from two separate promoter elements (Koncz et al. 1987). The termination codon of *luxA* and the short intercistronic distance separating *luxA* and *luxB* have been replaced by sequences encoding polypeptide linkers (Boylan et al. 1989; Kirchner et al. 1989). The resulting fused *luxA* and *luxB* genes express highly active luciferase that can be assayed in yeast, *E. coli*, and plant cells. This abil-

ity to express bacterial luciferase as a single polypeptide removes a major obstacle to its use as a reporter molecule in mammalian cells. Bacterial luciferase catalyzes the oxidation of long-chain aldehydes into carboxylic acids using FMNH<sub>2</sub> as a cofactor, producing photons as one of the reaction products:



where R is an aliphatic moiety containing at least seven carbon atoms; FMN is a flavin mononucleotide; and FMNH<sub>2</sub> is a reduced flavin mononucleotide. Bacteria contain enough FMNH<sub>2</sub> to drive this reaction, and light emission can therefore be measured directly from intact cells, allowing gene expression to be assayed in real time (e.g., please see Legocki et al. 1986). In yeasts, the intracellular concentration of FMNH<sub>2</sub> is much lower, and the intensity of in vivo luminescence is therefore far lower than in intact bacteria. However, the level of light produced in intact yeast cells expressing the bacterial *lux* genes is still 1000-fold over background and significantly above that reported for firefly luciferase (Tatsumi et al. 1988). Intact cells of higher eukaryotes do not contain enough FMNH<sub>2</sub> to drive the reaction catalyzed by the fused *luxAB* genes. However, addition to cell extracts of FMNH<sub>2</sub> and an FMNH<sub>2</sub>-generating system (e.g., NAD[P]H:FMN reductase; available from Boehringer Mannheim) generates high levels of luminescence.

Although side-by-side comparisons of efficiency have not been reported, a *luxAB* fusion has two theoretical advantages over firefly luciferase as a reporter molecule: *luxAB* is a cytosolic molecule, and its substrate, the aldehyde decanal, penetrates membranes easily. Although the quantum yield of the photochemical reaction catalyzed by *luxAB* is less than that of firefly luciferase, *luxAB* may turn out to be the more sensitive reporter in intact cells. For a summary of chromogenic and luminescent methods of detection of immobilized antigens, please see Appendix 8, Table A8-12.

## Green Fluorescent Protein

The bioluminescent jellyfish, *Aequorea victoria* emits a characteristic green fluorescence, which is due to the interaction of two proteins, the calcium-binding photoprotein aequorin, and the green fluorescent protein (GFP). The emission spectrum of GFP peaks at 508 nm (Johnson et al. 1962), a wavelength close to that of living *Aequorea* tissue, but distinct from the chemiluminescence of pure aequorin, which is blue and peaks near 470 nm. With the initial purification and crystallization of GFP, it was discovered that calcium-activated aequorin could efficiently transfer its luminescent energy to GFP when the two were co-adsorbed onto a cationic support (Morise et al. 1974). Green light is produced when energy is transferred by a Förster-type mechanism from Ca<sup>2+</sup>-activated aequorin to GFP. Blue light emitted by activated aequorin is captured by a hexapeptide chromophore (beginning at residue 64 of GFP) that contains a cyclic structure (4-[*p*-hydroxybenzylidene]imidazolidin-5-one) attached to the peptide backbone through the 1-position and 2-position of the ring (Shimomura 1979). Interestingly, this structure appears to be conserved among fluorescent proteins, even those from nonbioluminescent organisms (Matz et al. 1999).

The GFP gene was cloned in 1992 (Prasher et al. 1992) and is now used as a reporter in a wide range of organisms (e.g., please see Chalfie et al. 1994; Wang and Hazelrigg 1994; Marshall et al. 1995; Yeh et al. 1995; Chiu et al. 1996; Niedenthal et al. 1996; Misteli et al. 1997). Expression levels of GFP can be measured accurately using a fluorometer. Fluorescence is measured directly in intact living cells in 96-well plates and expression is assessed on an individual cell basis using fluorescence microscopy. Engineered variants of GFPs that fluoresce at different wavelengths and with different intensities have been developed and are available from various commercial sources (e.g., Research Genetics and CLONTECH). For more information on GFP and its applications in molecular biology, please see the information panel in Chapter 17.

## ANTIBODIES

---

Antibodies are used for several major purposes in molecular cloning:

- to screen cDNA libraries for clones that express a specific protein
- to purify fusion proteins that are tagged with a specific epitope
- to detect and quantify foreign protein expressed by recombinant DNA techniques
- to confirm that a cloned gene encodes a protein of interest
- to detect probes labeled with biotin or digoxigenin
- to detect mRNAs by immunohistochemical analysis

Antibodies come in a variety of classes, affinities, and idiotypes. They can be polyclonal or monoclonal, engineered or natural, and raised in animals or generated in vitro. However, as far as molecular cloning is concerned, the specificity of the antibody is far more important than its provenance. Antibodies can be divided into three groups according to how they react with their target proteins.

- **Antibodies that react with the foreign protein independently of its conformation.** Antibodies of this type are particularly useful for measuring the total amount of the target protein in crude preparations or in cell extracts. They are usually polyclonal in nature and are prepared by immunizing animals with partially denatured protein or with a peptide whose sequence corresponds to part of the intact protein. However, monoclonal antibodies that are pan-specific are not uncommon.
- **Antibodies that react only with epitopes specific to the native form of the target protein.** Antibodies of this type are typically monoclonal, have been raised against native protein, and recognize a given sequence of amino acids only when it occurs in its native three-dimensional configuration. These antibodies are useful for testing whether mutated forms of proteins that have been generated by in vitro mutagenesis are folded correctly or whether a wild-type protein expressed in heterologous cells is assembled into a correct three-dimensional configuration.
- **Antibodies that react only with denatured forms of the target protein.** These antibodies are raised against fully denatured antigens and can be either monoclonal or polyclonal. Antibodies of this type are useful for western blotting and for immunological screening of cDNA libraries.

Although there is no way to guarantee the production of particular types of antibodies, it is nevertheless possible to choose an immunization regimen that will favor the production of antibodies with the desired characteristics. However, it is always necessary to screen several independent antisera or a series of monoclonal antibodies to identify those suited to the tasks at hand.

### Purification of Antibodies

For many purposes, antisera need not be fractionated before use. However, if the antisera are to be radiolabeled or conjugated to enzymes such as horseradish peroxidase (HRP) or alkaline phosphatase, it is necessary to purify the IgG fraction or, in some cases, to purify the antibody of interest by binding it to its cognate antigen.

Although many techniques have been developed to purify IgG molecules, the method of choice is adsorption to, and elution from, beads coated with protein A, a component of the cell wall of *S. aureus* (Hjelm et al. 1972). For reasons that are not known, this protein ( $M_r = 42,000$ )

binds strongly to sites in the second and third constant regions of the Fc portion of the immunoglobulin heavy chain (Deisenhofer 1981). Each IgG molecule therefore contains two binding sites for protein A. Because protein A itself has five potential sites for binding to IgG (Sjödahl 1977), it is possible to form multimeric complexes of the two types of proteins.

Not all immunoglobulins bind to protein A with the same affinity. Antibodies from humans, rabbits, and guinea pigs bind most tightly, followed in decreasing order of affinity by those from pigs, mice, horses, and cows (Kronvall et al. 1970a,b; Goudswaard et al. 1978). Immunoglobulins from goats, rats, chickens, and hamsters bind in a much weaker fashion, and a “bridging” antibody is usually required to purify them by adsorption to protein A.

Within any one species, different classes of immunoglobulins vary in the sequences of their Fc regions and consequently bind to protein A with different affinities. Of the major classes of human IgG, for example, three (IgG1, 2, and 4) bind with high affinity and one (IgG3) binds very weakly, if at all. Similarly, mouse IgG2a binds with high affinity, IgG2b and IgG3 bind tolerably well, and IgG1 binds poorly (Ey et al. 1978). These differences are generally unimportant when dealing with polyclonal sera, where antibodies against the target antigen are distributed throughout all of the major subclasses of IgG. Consequently, purification of polyclonal immunoglobulins raised in rabbits, humans, and mice by binding to protein A may alter the distribution of subclasses of IgG, but it rarely changes the specificity or avidity of the final preparation. However, monoclonal antibodies secreted from hybridomas carry only one subclass of heavy chain. Before attempting to purify a given monoclonal antibody, it is essential to determine the subclass of its heavy chain using commercially available immunological reagents directed against isotypes of the Fc region. If the monoclonal antibody falls into a class that binds poorly to protein A (e.g., by binding to protein G or to human IgG3 or mouse IgG1), it should be purified by another method (e.g., ammonium sulfate precipitation, followed by chromatography on DEAE-cellulose). Alternatively, a bridging antibody can be used to attach the monoclonal antibody to protein A.

Protein A coupled to a solid support by cyanogen bromide is supplied by several manufacturers (e.g., protein A–Sepharose CL-4B; Pharmacia). Each milliliter of swollen gel can bind ~10–20 mg of IgG (equivalent to 1–2 ml of antiserum). Antibodies bind to protein A chiefly by hydrophobic interactions (Deisenhofer 1981) that can be disrupted at low pH. Protein A is remarkably resilient and withstands repeated cycles of exposure to low pH extremely well; it can also be treated with high concentrations of denaturing agents such as urea, guanidine hydrochloride, or potassium isothiocyanate without permanent damage. Most antibodies can withstand transient exposure to low pH, and this treatment is now the standard method to release them in an active form from protein A–Sepharose beads. For additional information on protein A, protein G, and protein L, please see the information panel on **IMMUNOGLOBULIN-BINDING PROTEINS: PROTEINS A, G, AND L** at the end of this appendix.

Although hyperimmune antisera raised in experimental animals contain very high concentrations of immunoglobulin directed against the target antigen, such antisera also always contain antibodies directed against other antigens. In addition, the immunoglobulins in antisera may bind with low avidity to molecules that are not true target antigens. For these and other reasons, antisera can manifest a level of background reactivity that is unacceptably high. There are three ways to deal with this problem:

- **Use an innocuous blocking agent (e.g., bovine serum albumin, normal serum, or BLOTTO)** to compete with the immunoglobulin for nonspecific binding sites. Blocking agents are routinely included in solutions used, for example, in immunological screening of expression libraries constructed in plasmid or bacteriophage  $\lambda$  vectors.
- **Remove antibodies that are directed against specific contaminating antigens by adsorption.** Methods to remove antibodies directed against bacterial antigens are discussed in Chapter 14,

Protocol 4. Antibodies that cross-react with components in eukaryotic cells can be adsorbed with acetone extracts of a cell line or tissue that are known not to express the true target antigen. If such a line cannot be identified with certainty, use an acetone extract of commercially available dried yeast (Sambrook et al. 1989). Alternatively, unwanted antibodies can be adsorbed to antigens immobilized on nitrocellulose or PVDF membranes.

- **Separate antibodies directed against the target antigen from contaminating antibodies by affinity purification.** In some cases (e.g., when the antigen is a protein), the antigen may be coupled to a matrix such as cyanogen-bromide-activated Sepharose. Antibodies directed against epitopes displayed by the protein will be retained by the column; all other immunoglobulins will pass through. The bound antibody is then released from the column by agents that disrupt the antigen-antibody complex (e.g., potassium isothiocyanate and low-pH buffers). Details of the methods used to prepare antibodies by immunochromatography vary from antigen to antigen and from antibody to antibody. However, the general principles are well-described in a number of reviews (e.g., please see Hurn and Chantler 1980; Harlow and Lane 1988, 1999). When using these methods, it is essential to use highly purified antigen and to avoid the batch of antigen that was used to raise the antibody in the experimental animals. Furthermore, it is important to remember that antibodies with different affinities for the antigen will show different patterns of elution from the column; those that bind loosely to the antigen will elute first, and those that bind most tightly will elute last. In fact, antibodies with the highest avidity may be denatured by the elution buffer before they dissociate from the antigen. Thus, there is a tendency during immunopurification to select for antibodies that are specific for the antigen but that bind with low affinity.

Antibodies may be purified on a small scale by adsorption to, and elution from, protein antigens that are immobilized on diazotized paper (Olmsted 1981), or nitrocellulose filters (Burke et al. 1982; Smith and Fisher 1984; Earnshaw and Rothfield 1985), after electrophoresis through SDS-polyacrylamide gels. Antibodies prepared by this method are especially useful for confirming the identity of cDNA clones isolated from expression libraries constructed in bacteriophage  $\lambda$  or plasmid expression vectors. For example, many false-positive clones can be eliminated by purifying antibodies from crude sera by virtue of their ability to bind to a fusion protein partly encoded by the cloned cDNA and testing the ability of these purified antibodies to precipitate the target protein or to react with it on a western blot. However, this method works well only when the antibodies react with epitopes that are displayed on denatured proteins. Typically, ~50 ng of immunopurified antibody is recovered per microgram of target protein loaded on the original SDS-polyacrylamide gel. Because of the idiosyncratic nature of the interactions between antibodies and their target proteins, it is not possible to give conditions for binding and elution that are universally applicable. For example, most antibodies can be eluted from their immobilized antigens with glycine buffer (pH 2.8). However, Earnshaw and Rothfield (1985) found that antibodies to human centromeric proteins could be eluted only with a solution containing 3 M potassium thiocyanate and 0.5 M  $\text{NH}_4\text{OH}$ . Investigators who wish to use this potentially powerful technique should be prepared to invest some effort in defining the optimal conditions for binding and release of their particular antibodies from their target proteins.

## Immunological Assays

Antibodies are used in a wide variety of assays, both qualitative and quantitative, to detect and measure the amount of target antigens. These assays include western blotting, immunoprecipitation, and solid-phase radioimmunoassay (RIA).



### Western Blotting

Western blotting (Towbin et al. 1979; Burnette 1981; Towbin and Gordon 1984) is to proteins what Southern blotting is to DNA. In both techniques, electrophoretically separated components are transferred from a gel to a solid support and probed with reagents that are specific for particular sequences of amino acids (western blotting) or nucleotides (Southern hybridization). In the case of proteins, the probes usually are antibodies that react specifically with antigenic epitopes displayed by the target protein attached to the solid support. Western blotting is therefore extremely useful for the identification and quantitation of specific proteins in complex mixtures of proteins that are not radiolabeled. The technique is almost as sensitive as standard solid-phase radioimmunoassays and, unlike immunoprecipitation, does not require that the target protein be radiolabeled. Furthermore, because electrophoretic separation of proteins is almost always carried out under denaturing conditions, any problems of solubilization, aggregation, and coprecipitation of the target protein with adventitious proteins are eliminated.

The critical difference between Southern and western blotting lies in the nature of the probes. Whereas nucleic acid probes hybridize with a specificity and rate that can be predicted by simple equations, antibodies behave in a much more idiosyncratic manner. As discussed earlier, an individual immunoglobulin may preferentially recognize a particular conformation of its target epitope (e.g., denatured or native). Consequently, not all monoclonal antibodies are suitable for use as probes in western blots, where the target proteins are denatured. Polyclonal antisera, on the other hand, are undefined mixtures of individual immunoglobulins, whose specificity, affinity, and concentration are often unknown. It is therefore not possible to predict the efficiency with which a given polyclonal antiserum will detect different antigenic epitopes of an immobilized, denatured target protein.

Although there is an obvious danger in using undefined reagents to assay a target protein that may also be poorly characterized, most problems that arise with western blotting in practice can be solved by designing adequate controls. These include the use of (1) antibodies (i.e., preimmune sera, normal sera, or irrelevant monoclonal antibodies) that should not react with the target protein and (2) control preparations that either contain known amounts of target antigen or lack it altogether.

Often, there is little choice of immunological reagents for western blotting — it is simply necessary to work with whatever antibodies are at hand. However, if a choice is available, either a high-titer polyclonal antiserum or a mixture of monoclonal antibodies raised against the denatured protein should be used. Reliance on a single monoclonal antibody is hazardous because of the high frequency of spurious cross-reactions with irrelevant proteins. If, as is usually the case, monoclonal and polyclonal antibodies have been raised against native target protein, it will be necessary to verify that they react with epitopes that either (1) resist denaturation with SDS and reducing agents or (2) are created by such treatment. This test can be done by using denatured target antigen in a solid-phase radioimmunoassay or in western dot blots.

In western blotting, the samples to be assayed are solubilized with detergents and reducing agents, separated by SDS-polyacrylamide gel electrophoresis, and transferred to a solid support (usually a nitrocellulose or PVDF filter), which may then be stained (e.g., with Ponceau S). The filter is subsequently exposed to unlabeled antibodies specific for the target protein. Finally, the bound antibody is detected by one of several secondary immunological reagents (e.g.,  $^{125}\text{I}$ -labeled or anti-immunoglobulin, or anti-immunoglobulin or protein A coupled to horseradish peroxidase or alkaline phosphatase), followed by autoradiography, enhanced chemiluminescence, or enzymatic production of a colored precipitate. As little as 1–5 ng of an average-sized protein can be detected by western blotting. For more information on western blotting, please see Appendix 8.

### **Immunoprecipitation**

Immunoprecipitation is used to detect and quantitate target antigens in mixtures of proteins. The power of the technique lies in its selectivity: The specificity of the immunoglobulin for its ligand is so high that the resulting antigen-antibody complexes can be purified from contaminating proteins. Furthermore, immunoprecipitation is extremely sensitive and is capable of detecting as little as 100 pg of radiolabeled protein. When coupled with SDS-polyacrylamide gel electrophoresis, the technique is ideal for analysis of the synthesis and processing of foreign antigens expressed in prokaryotic and eukaryotic hosts or in *in vitro* systems.

The target protein is usually immunoprecipitated from extracts of cells that have been radiolabeled. However, immunoprecipitation can also be used to analyze unlabeled proteins as long as sufficiently sensitive methods are available to detect the target protein after it has been dissociated from the antibody. Such methods include enzymatic activity, binding of radioactive ligands, and western blotting.

### **Solid-phase Radioimmunoassay**

The solid-phase radioimmunoassay (RIA) is a quantitative method that is capable of detecting as little as 1 pg of target antigen. This means that RIAs are sufficiently sensitive to measure, for example, the amount of foreign protein produced by transfected mammalian cell cultures. There are many different kinds of RIAs, which fall into four basic designs:

- **Competition RIAs:** In this method, the unlabeled target protein in the test sample competes with a constant amount of radiolabeled protein for binding sites on the antibody. The amount of radioactivity present in the unbound or bound target protein is then measured. This type of assay can be extremely sensitive but requires that target protein be available (preferably in a pure form) to serve both as a competitor and as a standard.
- **Immobilized antigen RIAs:** In this method, unlabeled antigen is attached to a solid support and exposed to radiolabeled antibody. Comparison of the amount of radioactivity that binds specifically to the samples under test with the amount that binds to a known amount of immobilized antigen allows the antigen in the test samples to be quantitated. Although used occasionally, this type of assay is not particularly useful for quantitation of small amounts of foreign protein in complex mixtures (e.g., in cell lysates); most of the binding sites on the solid support become occupied by proteins other than the target protein, so that the sensitivity of the assay is comparatively low.
- **Immobilized antibody RIAs:** In this method, a single antibody bound to a solid support is exposed to radiolabeled antigen. The amount of antigen in the test sample can be determined by the amount of radioactivity that binds to the antibody. This assay is not useful for quantitating the amount of foreign protein in many different samples, chiefly because of the practical difficulty of radiolabeling the protein either *in vivo* or *in vitro*.
- **Double-antibody RIAs:** In this method, one antibody bound to a solid support is exposed to the unlabeled target protein. After washing, the target protein bound to the immobilized antibody is quantitated with an excess of a second radiolabeled antibody. This assay is extremely sensitive and specific because the target protein is essentially purified and concentrated by immunoadsorption. Furthermore, many test samples can be processed simultaneously. However, the method requires that the first and second antibodies recognize nonoverlapping epitopes on the target protein. Ideally, the first antibody is monoclonal, whereas the second can be either a polyclonal antibody or a monoclonal antibody of different specificity. However, in

some cases, it may be possible to use the same polyclonal antibody for both parts of the assay. If suitable antibodies are available, this is the method of choice for quantitation of target proteins in complex mixtures.

## Radiolabeling of Antibodies

Of the several methods that are available to radioiodinate antibodies, the most commonly used is a reaction in which an electrophilic iodine species is generated by oxidation of  $\text{Na}^{125}\text{I}$  with chloramine-T (*N*-chlorobenzenesulfonamide). The positively charged iodine then reacts with the side chains of tyrosyl, and to a lesser extent, histidyl residues (for review, please see Seevers and Counsell 1982). Iodination by chloramine-T was devised as a method to label small amounts of polypeptide hormones to very high specific activity (Hunter and Greenwood 1962; Greenwood et al. 1963). However, the reaction conditions are so severe as to cause extensive denaturation of proteins that are sensitive to oxidation. The modified procedure devised by McConahey and Dixon (1966, 1980), which uses lower concentrations of chloramine-T and longer reaction times, yields native proteins without a significant loss in the efficiency of radiolabeling. Nowadays, most investigators prefer to use chloramine-T covalently coupled to nonporous polystyrene beads (Iodobeads, Pierce) (Markwell 1982). This has several benefits: It reduces the amount of radiolabeled molecular iodine generated in the reaction and simplifies measurements of the time course and overall efficiency of radioiodination (Cheng and Rudick 1991). In addition, because there is very little contact between the protein and the oxidizing agent, oxidative damage to the protein is minimized. Finally, when iodination is carried out according to standard protocols, no more than one atom of  $^{125}\text{I}$  is incorporated per protein molecule. Conformational distortions caused by the introduction of a bulky iodine atom are therefore kept to a minimum.

An alternative to chloramine-T is Iodogen (1,3,4,6-tetrachloro-3 $\alpha$ ,6 $\alpha$ -diphenylglycouril), an oxidizing reagent resembling a fourfold chloramine-T (Fraker and Speck 1978). Iodogen is sparingly soluble in water and forms a thin coating on the wall of the tube used for radioiodination. Solid-phase reagents such as Iodogen and Iodobeads (available from Pierce) give radiochemical yields that are equal to those obtained with free chloramine-T (Woltanski et al. 1990) while significantly reducing the potential for exposure of laboratory workers to volatile forms of radioiodine.

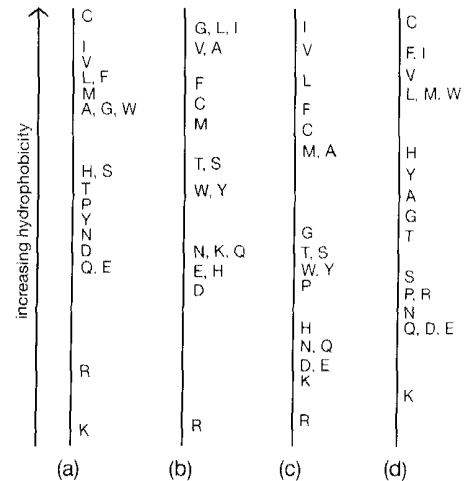
Radioiodination with chloramine-T and similar compounds will not work with proteins and peptides that lack accessible tyrosines or are extremely susceptible to damage by oxidation. These proteins should be labeled by the Bolton-Hunter reagent (Bolton and Hunter 1973). The *N*-succinamidyl group of this reagent (*N*-succinamidyl 3-[4-hydroxy 5- $^{125}\text{I}$ ]iodophenyl]propionate) condenses with free amino groups and with imino groups in lysyl side chains to give a derivative in which the radioiodinated phenyl group is linked via an amide bond to the target protein (for more details, please see Langone 1980; Harlow and Lane 1988).

## Antipeptide Antibodies

If the sequence of a protein is known or can be deduced from the nucleic acid sequence, specific antisera can be raised by immunizing animals with a synthetic peptide corresponding in sequence to a segment of the native protein (for review, please see Lerner 1984). If information about the primary sequence of the target protein is limited, there may be little or no choice in the peptide sequence used as an immunogen. However, there is a good chance that peptides chosen at random will be at least partially buried in the native protein and they may be too hydrophobic to be

**FIGURE A9-3 Hydrophobicity Scales**

Several hydrophobicity scales, approximately normalized to each other and increasing from bottom to top. Data from (a) Janin (1979); (b) Wolfenden et al. (1981); (c) Kyte and Doolittle (1982); and (d) Rose et al. (1985). Please also see Figure A7-2 in Appendix 7. (Reprinted, with permission, from Richardson and Richardson 1989 [©Kluwer Academic/Plenum Publishers].)



efficient immunogens. Antibodies directed against these peptides may be of low titer and/or may react only with denatured protein.

Hydrophilic peptides that contain charged residues are much better immunogens and also have a high probability of occupying a surface location on the native protein. Antipeptide antibodies raised against conformationally flexible surface features of proteins such as turns and  $\beta$ -loops are likely to be of high titer and may react efficiently with the native protein. Most of the computing packages that are commonly used to analyze DNA sequences contain programs to search protein sequences for surface peptides that are likely to be good antigens. The goal of these programs is to choose a sequence of 11–15 amino acids that contains a preponderance of polar residues and no more than four adjacent hydrophobic residues. Such peptides are likely to be soluble in aqueous solvents and therefore easy to couple to carrier proteins.

Several scales of hydrophobicity and hydrophilicity have been proposed for amino acids (please see Figure A9-3) (Janin 1979; Wolfenden et al. 1981; Kyte and Doolittle 1982; Rose et al. 1985). Although these scales are in good general agreement, they differ slightly in the order of amino acids and in the relative hydrophobicity values assigned to them. This variability arises because the hydrophobicity of an amino acid residue is the product of several different factors, including electrostatic charge, hydrogen-bonding capability, and surface area. In addition, the hydrophobicity of an amino acid can be assessed experimentally by partitioning into solvents of various types. The variation in hydrophobicity scales of amino acids reflects the particular weightings that different investigators have attached to these and other factors.

Computer programs to predict strongly antigenic sites in proteins rely on hydrophobicity scales alone or in combination with programs that predict secondary structure. The strongest antigenic sites are predicted in regions of the protein surface that are high in charge and low in hydrophobicity. Rarely found in ordered structures such as helices or sheets, such regions usually map to turns and loops that are rich in residues with H-bonding potential.

Highly charged regions also often occur at the amino and carboxyl termini of proteins, which tend to be regions of high flexibility. However, if the protein of interest is a secretory or transmembrane protein, or is located in organelles such as mitochondria or chloroplasts, it is better not to use peptides derived from the terminal regions. The amino-terminal peptide is likely to be part of a signal or leader sequence that will be cleaved during posttranslational processing. The carboxy-terminal region of transmembrane proteins may be located on the cytoplasmic side of the membrane and may only be accessible to antibodies after cells are permeabilized, fixed, or lysed.

**GUIDELINES FOR CHOOSING AN IMMUNOGENIC PEPTIDE**

An immunogenic peptide should have:

- a sequence 11–15 amino acids long
- no more than six hydrophobic residues
- no more than four adjacent hydrophobic residues
- no consensus sites for *N*-glycosylation\* (N-X-S/T)
- no basic residues if glutaraldehyde is to be used as a cross-linker
- no internal or cysteine residues if *m*-maleimidobenzoic acid *N*-hydroxysuccinimide ester (MBS) is to be used as a cross-linker
- a tyrosine residue because the peptide can then easily be radiolabeled with <sup>125</sup>I

\*Oligosaccharide groups added to secretory and plasma membrane proteins can shield the underlying amino acid residues from interacting with antibodies and other ligands. Antibodies generated against a synthetic peptide may therefore not recognize the glycosylated target protein even though the immunogen and the target share amino acid sequences. When raising antibodies against secretory and plasma membrane proteins, it is best to avoid regions that contain consensus sites for glycosylation.

Usually, the synthetic peptide is coupled to a carrier protein such as keyhole limpet hemocyanin through an amino- or carboxy-terminal cysteine residue. Ideally, therefore, the sequence of the peptide should end with a “natural” cysteine that is present in the cognate sequence of the target protein. If this is not possible, choose a peptide that has no cysteine at all. Chemical synthesis of the peptide, which proceeds from the carboxyl terminus to the amino terminus, is then initiated from an “artificial” cysteine that has no counterpart in the natural cognate sequence. This terminal cysteine is used as a linker to couple the synthetic peptide to the carrier protein. Alternatively, multiple copies of a peptide can be linked to each other. Other methods of coupling peptides to carriers are available but are rarely used. These include:

- ***Glutaraldehyde-mediated cross-linking of basic residues in the peptide and a carrier protein.*** Because glutaraldehyde reacts with -NH<sub>2</sub> groups to form Schiff's bases, peptides containing lysine residues can be efficiently cross-linked to a protein such as keyhole limpet hemocyanin, whose surface is rich in basic residues. However, lysines, if present in the peptide, are likely to be important contributors to its antigenicity. Modifying them may reduce the antigenicity of the peptide and/or generate antibodies that efficiently recognize the modified residues but do not interact with the unmodified cognate sequence in the target protein.
- ***Use of peptide-resin as the immunogen.*** Novabiochem sells a polymethylacrylamide/Keiselguhr composite derived using ethylene diamine. Antigenic peptides can be synthesized directly on the free amino group of the base resin and remain attached to the support by a covalent bond. After deprotection of the peptide with trifluoroacetic acid and homogenization of the inorganic Keiselguhr, the peptide-polyamide complex can be emulsified with adjuvant and injected into animals.

Immunization with the carrier-peptide complexes will generate a mixture of antibodies of various affinities and specificities. Some antibodies will be directed toward the carrier (protein or resin) or the cross-linking groups; others will react with both peptide and carrier. However, as long as the synthetic protein is at least 11 residues in length, a proportion of the antibodies will be specific for amino acid sequences that are shared by the peptide and its cognate protein. Usually, there is no need to remove antibodies directed against the linking groups and the carrier protein, since these do not interfere with antibodies directed against the target protein.

However, antibodies that cross-react with the carrier protein can, if necessary, be removed by immunoabsorption with resin or by immunoaffinity chromatography on Sepharose columns containing immobilized carrier protein.

## Conjugated Antibodies

Antibodies can be conjugated to a wide variety of substances without significant erosion of avidity and specificity. These substances include biotin, fluorochromes of various colors, and enzymes such as alkaline phosphatase, horseradish peroxidase, and urease. Antibodies conjugated to different substances allow simultaneous detection of more than one antigen and generate strong signals that can be further amplified through the use of secondary antibodies and avidin-conjugated enzymes.

- **Biotinylated antibodies** are used chiefly to detect antigens by enzyme-linked immunosorbent assay (ELISA), for antibody screening of expression libraries, and for western blotting.

The labeled avidin-biotin (LAB) technique uses an avidin-enzyme conjugate to detect a biotinylated primary or secondary antibody.

The bridged avidin-biotin (BRAB) assay, as its name implies, uses avidin as a bridge between a biotinylated primary or secondary antibody and a biotin-enzyme conjugate.

The avidin-biotin complex (ABC) assay is the most sensitive of these three assays. The biotinylated enzyme is preincubated with avidin, forming large complexes that are then used to detect biotinylated primary or secondary antibodies.

Biotinylated secondary antibodies are available from several manufacturers (e.g., Pierce and Vector).

- **Fluorochrome-labeled antibodies** are used chiefly for immunohistochemistry. Wherever possible, it is best to use fluorochrome-labeled, affinity-purified, anti-immunoglobulins or fluorochromes conjugated to avidin or streptavidin. These reagents, which are commercially available, have lower background and less nonspecific fluorescence than fluorescent antiserum or immunoglobulin fractions. The choice among fluorochromes is usually dictated by the types of filters that are available for the fluorescence microscope. Fluorescein has a lower background than rhodamine, but bleaches more rapidly. Texas Red emits strongly and is resistant to photobleaching. Phycoerythrin, a phycobiliprotein whose fluorescent yield is 30–50 times greater than that of fluorescein and rhodamine, is used when extreme sensitivity is required (Oi et al. 1982). Table A9-5 summarizes the excitation and emission wavelengths of various fluorochromes.

**TABLE A9-5** Excitation and Emission Wavelengths of Fluorochromes

FLUOROCHROME	EXCITATION WAVELENGTH (nm)	EMISSION WAVELENGTH (nm)
Fluorescein	495 blue	524 greenish-yellow
Rhodamine	540 green, visible	575 orange-red
Texas Red	595 orange-red, visible	620 red
Oregon Green	496 blue	524 greenish-yellow
R-phycoerythrin	480, 545, 565 green, visible	574 orange-red

- **Enzyme-conjugated antibodies.** Antibodies coupled to horseradish peroxidase, alkaline phosphatase,  $\beta$ -galactosidase, and urease are available commercially. These can be used as secondary reagents for the enzymatic detection of primary antibody-antigen complexes. For both immunoscreening and western blotting, enzymatic methods are more sensitive and give lower backgrounds than radiolabeled antibodies or protein A. Enzyme-conjugated antibodies are particularly useful for screening expression libraries because signals develop directly on the nitrocellulose filter (rather than on a sheet of X-ray film or a phosphorimager), so that positive plaques can be located more accurately.

Conjugated enzymes catalyze the formation of insoluble colored precipitates on the surface of a nitrocellulose filter at the site of an antibody-antigen complex (Towbin et al. 1979; Hawkes et al. 1982; Blake et al. 1984; Knecht and Dimond 1984; Towbin and Gordon 1984; Hawkes 1986). Alkaline phosphatase and horseradish peroxidase are the most commonly used conjugated enzymes. Alkaline phosphatase remains active for several hours, during which the end-product of the reaction — a dark blue precipitate of diformazan (McGadey 1970) — continues to accumulate and intensify in color. By contrast, horseradish peroxidase is inactivated within a short period of time by its substrate, peroxide, which may account for the lower sensitivity of horseradish-peroxidase-conjugated antibodies in detecting antibody-antigen complexes on nitrocellulose filters (Mierendorf et al. 1987). Furthermore, some protocols using horseradish peroxidase antibodies employ a carcinogenic chromogen, *o*-dianisidine, which requires special handling and disposal. For a summary of chromogenic and luminescent methods of detection of immobilized antigens, please see Table A8-12 in Appendix 8.

## HORSERADISH PEROXIDASE

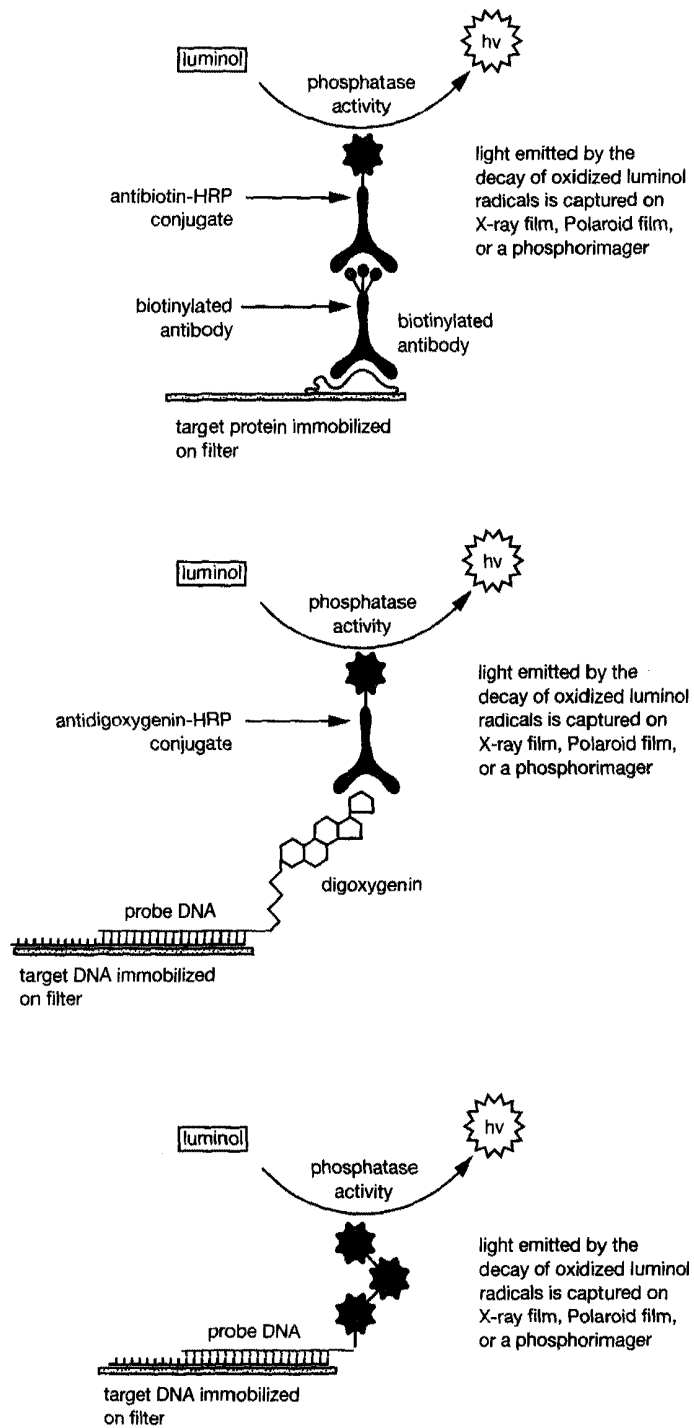
Horseradish peroxidase (HRP), a heme-containing protein, is generally isolated from wild horseradish roots as a mixture of several isozymes. The classical preparation (Shannon et al. 1966) is predominantly a mixture of two forms (isozymes B and C), each with a  $M_r \sim 40,000$ . HRP catalyzes the transfer of two electrons from a substrate to hydrogen peroxide, to generate  $H_2O$  and an oxidized donor. When 3,3'-diaminobenzidine (DAB) is used as the substrate (Graham and Karnovsky 1966), the oxidized product polymerizes to form an intense brown residue that is insoluble in both  $H_2O$  and ethanol. In the presence of transition elements, such as cobalt and nickel, the residue is a slatey blue-black. These reactions form the basis of sensitive chromogenic assays for peroxidase that have been used for many years in electron microscopy (Robbins et al. 1971), immunocytochemistry (Nakane and Pierce 1967), various enzyme-linked immunosorbent assays and western blotting (see Figure A9-4). However, diaminobenzidine has some disadvantages as a substrate: It is possibly carcinogenic (Garner 1975; Weisburger et al. 1978), and it is not as sensitive a detector of HRP activity as more recently developed compounds such as 3,3',5,5'-tetramethylbenzidine (TMB) (e.g., please see Roberts et al. 1991). The oxidation products of TMB are normally soluble but can be "captured" by pretreating blots with dextran sulfate (McKimm-Breschkin 1990) or by using a particulate form of TMB that is available commercially. With these modifications, TMB is suitable for detection of HRP-antibody conjugates that are directed against proteins (including antibodies of another species) or ligands that can be attached to nucleic acid probes.

In addition to DAB and TMB, other HRP substrates that can be oxidized to insoluble chromogenic products include 4-chloro-1-naphthol (purple precipitate) and 3-amino-4-ethylcarbazole (red precipitate). Neither of these substrates is as sensitive a detector of HRP activity as diaminobenzidine. In addition, a number of chromogenic substrates for HRP are available that yield attractively colored, soluble oxidation products. In addition to TMB, these include *O*-phenylenediamine dihydrochloride (OPD) (tangerine orange) (Wolters et al. 1976), and 2,2'-azino-di(3-ethylbenzthiazoline-6-sulphonic acid) (ABTS) (green) (Engvall 1980). The best fluorogenic substrate is 3-(*p*-hydroxyphenyl) propionic acid (HPPA) (violet) (Roberts et al. 1991).

In the presence of hydrogen peroxide, HRP can also be used to trigger a cyclical chemiluminescent reaction that results in the oxidation of luminol to an excited form of 3-aminophthalate (Isaacson and Wettermark 1974; Roswell and White 1978; Durrant 1990; Stone and Durrant 1991) (please see Figure A9-5). As this compound returns to ground state, blue light is emitted at 428 nm. However, because the efficiency of this reaction is low, various *para*-substituted phenol-based compounds are used to increase the quantity and duration of the light emitted by the reaction (Whitehead et al. 1983; Hodgson and Jones 1989). In the presence of *p*-iodophenol, for example, the light emitted by the reaction may be increased by >1000-fold and the emission may be sustained for several hours. In addition, enhancers reduce the background by inhibiting chemical oxidation of luminol. Enhancers are thought to achieve these effects by eliminating the rate-limiting step in the reaction cycle by (1) reacting with HRP and (2) forming enhancer radicals that in turn react with luminol to form luminol radicals (please see Figure A9-5). The net result is an increase in the efficiency and speed, but not the characteristics, of the light-producing reaction. Light emitted from the reaction can be captured on X-ray film, phosphorimagers, or CCD cameras.

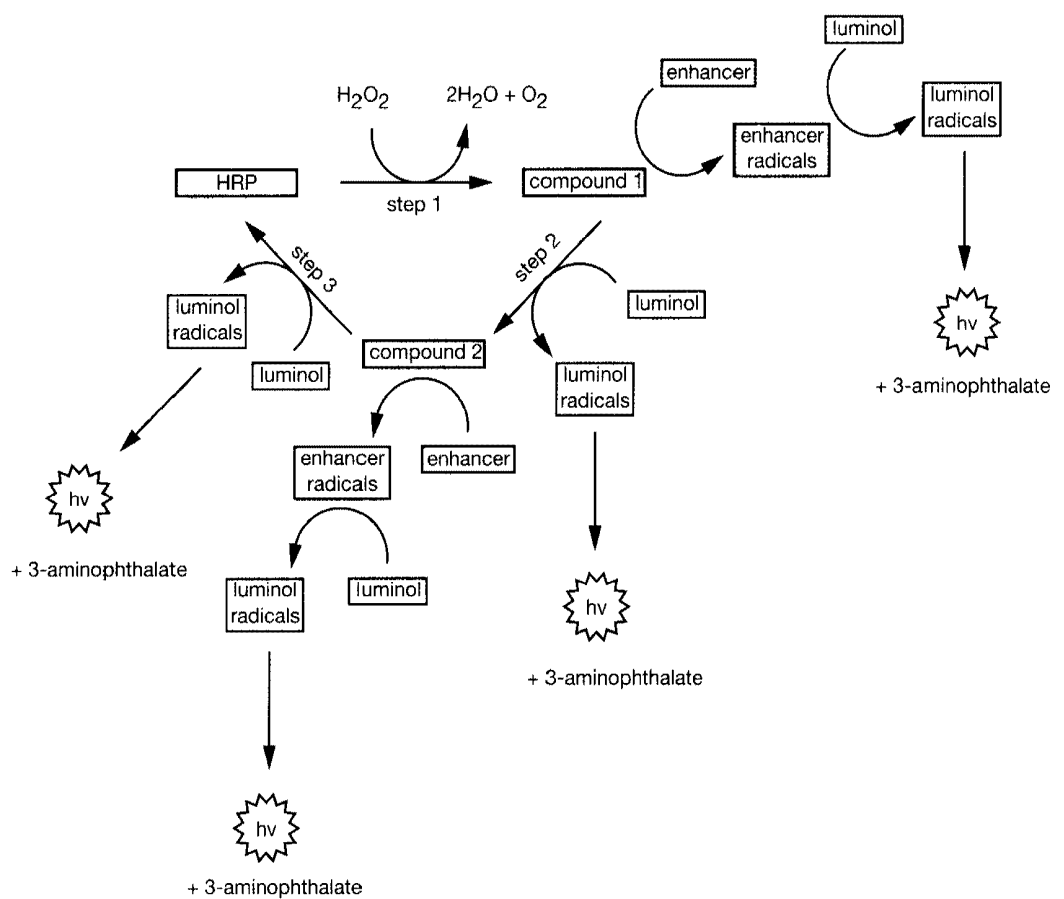
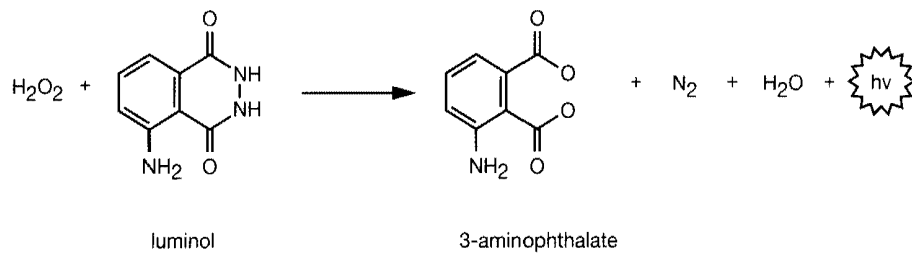
HRP can be directly coupled to single-stranded nucleic acid probes (Renz and Kurz 1984; Stone and Durrant 1991) or it can be conjugated to an antibody specific for ligands such as biotin or digoxigenin that can be incorporated into nucleic acid probes by standard enzymological techniques. In either case, the HRP/luminol reaction is sufficiently sensitive for nonradioactive detection of nucleic acids in Southern and northern hybridizations (Thorpe and Kricka 1986). Under ideal conditions, the limit of detection of nucleic acid probes is  $\sim 5 \times 10^{-17}$  moles (Urdea et al. 1988). However, the HRP/luminol reaction is considerably less sensitive than chemiluminescent reactions involving cleavage of 1,2-dioxetanes by alkaline phosphatase (please see the information panel on **AMPPD**). In addition, to achieve maximal sensitivity, the HRP/luminol reaction may require extensive optimization of its various components. For these reasons, HRP is now used less than alkaline phosphatase for the chemiluminescent detection of nucleic acids and proteins.





**FIGURE A9-4 Experimental Formats for Detection of Immobilized Nucleic Acids and Proteins with Horseradish Peroxidase (HRP)**

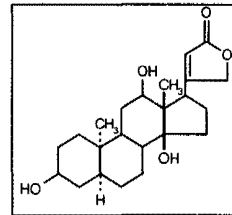
Light emitted by the decay of oxidized luminol radicals is captured on X-ray film or by a CCD camera.



**FIGURE A9-5 Proposed Cyclic Reaction for the Generation of Light by Oxidation of Luminol by HRP**

## DIGOXYGENIN

The cardenolide digoxigenin ( $M_r = 390.53$ ) can be derived by chemical or enzymatic removal of four sugar residues from desacetylanatoside C isolated from *Digitalis purpurea* (Reichstein 1962) or it can be extracted directly from *D. orientalis* and *D. lanata* L. *Scrophulariaceae* (Maanich and Schneider 1941; Hegenauer 1971). The chemical structure of digoxigenin (Cardwell and Smith 1953, 1954; Pataki et al. 1953) is shown in the box at the right.

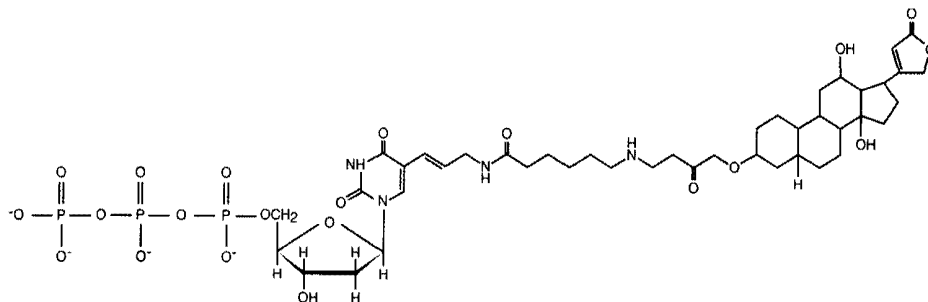


In molecular cloning, digoxigenin is used as a ligand that can be incorporated into DNA and RNA probes and detected after hybridization with an anti-digoxigenin-antibody enzyme conjugate (Kessler et al. 1989; Kessler 1991) (please see Figure A9-6). Digoxigenin-labeled probes can therefore be used in Southern, northern, and dot-blot hybridizations. They also have considerable advantages for in situ hybridization, in part because the hapten digoxigenin is not present in animal cells (e.g., please see Tautz and Pfeifle 1989; Hemmati-Brivanlou et al. 1990). This absence eliminates background contributed by endogenous molecules. Such is not always the case with biotin-labeled probes. Digoxigenin-labeled nucleic acid probes can be stripped from nylon filters by heating the filters to 37°C for 20–30 minutes in a large volume of 0.1% SDS, 2 mM EDTA (pH 8.0) (Church and Kieffer-Higgins 1988). After washing, the filters can be reprobbed without significant loss of efficiency or sensitivity.

Note that after several cycles of probing, stripping, and reprobbed, the background of chemiluminescence may increase significantly due to the accumulation of alkaline phosphatase residue on the filter. This problem can be avoided by treating the filter with proteinase K and formamide between every second and third probing (Dubitsky et al. 1992).

### Labeling Nucleic Acids with Digoxigenin

For labeling of nucleic acids, digoxigenin is supplied by the manufacturer (Boehringer Mannheim) in two forms: digoxigenin-11-dUTP (DIG-11-dUTP) and digoxigenin-11-UTP (DIG-11-UTP). In each form, digoxigenin is coupled by an alkali-stable linkage and a spacer arm to deoxyuridine triphosphate and uridine triphosphate, respectively.



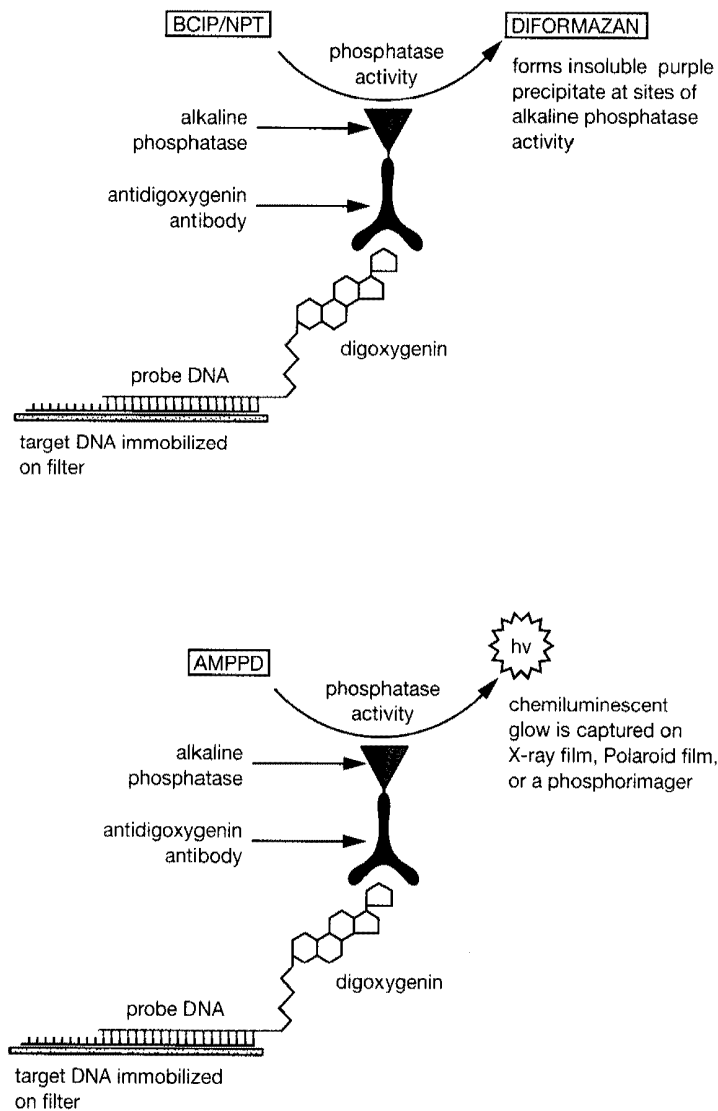
- DIG-11-dUTP is a substrate for *E. coli* DNA polymerase, the Klenow fragment of DNA polymerase I, thermostable polymerases such as *Taq*, reverse transcriptase, and terminal transferase. Digoxigenin can therefore be introduced into DNA by a variety of standard reactions including random priming, nick translation, amplification, end-filling, and 3'-tailing.
- DIG-11-UTP is incorporated into RNA during in vitro transcription of DNA templates by bacteriophage-encoded DNA-dependent RNA polymerases (T3, T7 and SP6 RNA polymerases) (please see Table A9-6).

Oligonucleotides that have been 5'-aminated during synthesis can be labeled with digoxigenin by reaction with NHS-digoxigenin (digoxigenin-3-O-methylcarbonyl-ε-aminocaproic acid-N-hydroxysuccinamide ester; Boehringer Mannheim) (Richterich and Church 1993).

**TABLE A9-6 Methods of Labeling Nucleic Acids with Digoxigenin**

METHOD OF LABELING	ENZYME	NUMBER OF DIGOXIGENIN MOLECULES INCORPORATED	REFERENCE
Random priming	Klenow fragment	1 per 25–36 nucleotides	Kessler et al. (1990)
Nick translation	<i>E. coli</i> DNA polymerase I	1 per 25–36 nucleotides	Höltke et al. (1990)
Tailing	Terminal transferase	1 per 12 nucleotides	Schmitz et al. (1991)
Amplification by PCR	<i>Taq</i> and other thermostable polymerases	1 per 25 nucleotides	Seibl et al. (1990)
Transcription	T3, T7, and SP6 RNA polymerases	1 per 25–36 nucleotides	Höltke and Kessler (1990)
cDNA synthesis	Reverse transcriptase	1 per 25–36 nucleotides	McCracken (1989)

For review, please see Kessler (1991).



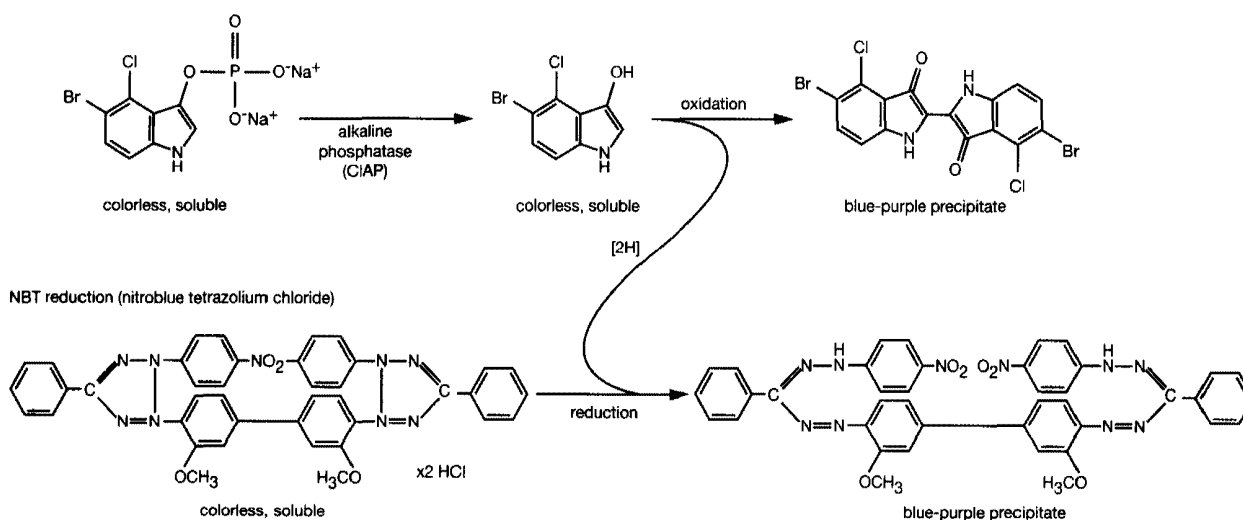
**FIGURE A9-6 Detection of Digoxigenin-labeled Nucleic Acid Probes with BCIP/NBT or AMPPD**

### Digoxigenin-specific Antibodies Coupled to Reporter Enzymes

High-affinity digoxigenin-specific antibody is raised in sheep immunized with the digoxigenin-coated proteins edestin or bovine serum albumin. The most versatile of the immunological reagents available for detection of digoxigenin-labeled probes are FAB fragments of antidigoxigenin immunoglobulin that have been coupled to alkaline phosphatase (Boehringer Mannheim). The best chromogenic substrates for immunolocalized alkaline phosphatase are the binary reagents 5-bromo-4-chloro-3-indolyl phosphate (BCIP) and 4-nitroblue tetrazolium chloride (NBT). For more information on these reagents, please see the information panel on **BCIP**.

Under optimal conditions, where high concentrations (50–100 ng/ml) of digoxigenin-labeled probe are used in the hybridization step and the color reactions are incubated for extended times (16–24 hours), it is possible to detect <1 pg of target DNA in a dot-blot assay (e.g., please see Kerkhof 1992). However, far greater sensitivity and a more linear response are obtained with the soluble chemiluminescent substrate adamantyl 1,2-dioxetane phosphate (AMPPD; Tropix, Inc.; Roche) (Kerkhof 1992; Bronstein et al. 1993). In AMPPD luminescent systems, which have gained rapidly in popularity in recent years, removal of the phosphate residue by alkaline phosphatase stimulates the substrate to emit chemiluminescence at 477 nm, which can be measured using a luminometer. The light occurs as a glow that persists for several hours in solution and for considerably longer on nylon surfaces (Tizard et al. 1990). Images of blots can be captured on X-ray film, on Polaroid instant black and white film (Kricka and Thorpe 1986), on a phosphorimager, or on a CCD camera (Karger et al. 1993). At its best, chemiluminescent detection of digoxigenin-labeled probes is highly sensitive (0.03 pg of target DNA or RNA) and rapid (<30 minutes exposure). The method is therefore ~10-fold more sensitive and 50-fold faster than autoradiographic detection of  $^{32}\text{P}$ -labeled nucleic acid probes. In addition, reprobing is simplified since stripping of the filter may not be required (Allefs et al. 1990). As a consequence of these advantages, chemiluminescent assays for alkaline phosphatase labels are used for detection of immobilized nucleic acid sequences in a wide variety of techniques involving blotting and DNA sequencing. For more information on AMPPD systems, please see the information panel on **AMPPD**.

BCIP oxidation (5-bromo-4-chloro-3-indolyl phosphate)

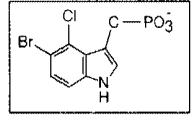


**FIGURE A9-7 Oxidation of BCIP and Reduction of NBT in the BCIP/NPT Indicator Reaction**

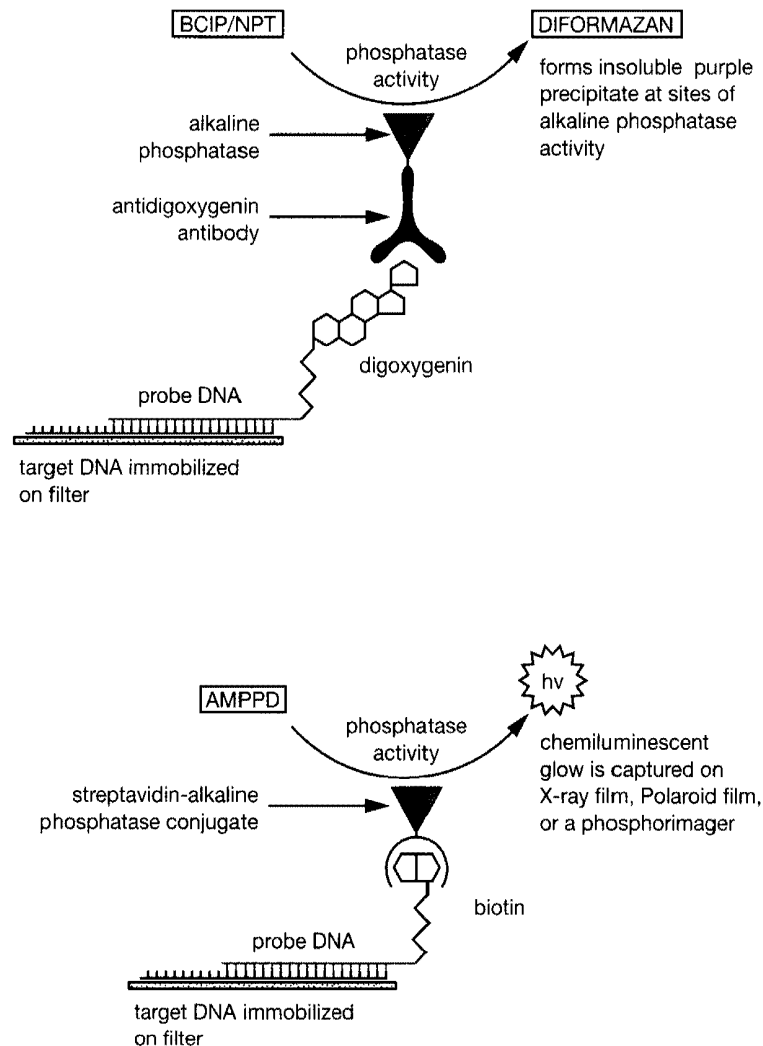
(Reprinted, with permission, from Kessler 1991 [Copyright 1991 ©Academic Press London].)

## BCIP

BCIP (5-bromo-4-chloro-3-indolyl phosphate, F.W. 370.4, [disodium salt]; F.W. 433.6 [toluidine salt]) is used in combination with nitroblue-tetrazolium salt (NPT) to detect alkaline phosphatase in situ. The binary reagent forms insoluble precipitates at sites of alkaline phosphatase activity and is the most sensitive indicator system available for chromogenic detection of alkaline phosphatase conjugates. In this reaction (Figure A9-7), alkaline phosphatase catalyzes the removal of the phosphate group from BCIP, generating 5-bromo-4-chloro-3-indolyl hydroxide, which dimerizes to the insoluble blue compound, 5,5'-dibromo-4,4'-dichloroindigo. The two reducing equivalents produced during the dimerization reaction reduce one molecule of nitroblue tetrazolium to the insoluble, intensely purple dye, diformazan (McGadey 1970; Franci and Vidal 1988). Color development occurs over several hours, but the time required to produce maximum signal varies considerably, depending on the amount of antibody bound to the target molecule.



BCIP/NBT is a sensitive detector of alkaline phosphatase activity but is not quantitative. Quantitative assays of the enzyme are carried out using the chromogenic substrate *p*-nitrophenyl phosphate (McComb and Bowers 1972; Brickman and Beckwith 1975; Michaelis et al. 1983). This substrate is sold by Sigma under



**FIGURE A9-8** Detection of Digoxigenin- and Biotin-labeled Nucleic Acid Probes with BCIP/NPT

the name "Sigma No. 104 phosphatase substrate." Hydrolysis of Sigma 104 generates *p*-nitrophenol, which in aqueous solution absorbs strongly at 420 nm. A more sensitive bioluminescence-based assay has also been described (Miska and Geiger 1987) in which D-luciferin-*O*-phosphate is used as a substrate. The amount of luciferin released by hydrolysis of the substrate is titrated using luciferase, and light impulses are then measured in a luminometer.

In molecular cloning, BCIP/NPT is widely used as an indicator in nonradioactive systems to detect nucleic acids or proteins. Almost always, these systems consist of several components that are used in sequence. When working at its best, the BCIP/NPT indicator system is sensitive enough to detect single copies of genes in Southern hybridization of total mammalian DNA. Typical arrangements are shown in Figure A9-8.

Southern, northern, and dot blots can be rehybridized by stripping the precipitate of formazan from charged nylon filters with *N,N*-dimethylformamide. Note that *N,N*-dimethylformamide's vapor is irritating to skin and mucous membranes and should therefore be used only in a well-ventilated chemical fume hood. Digoxigenin-labeled oligonucleotide probes can be removed from membranes by *N,N*-dimethylformamide at room temperature or by heating to 70–75°C in a buffer containing high concentrations of SDS (Richterich and Church 1993). The membranes then can be reprobbed.

Chromogenic detection of alkaline phosphatase is far less sensitive than the luminescent method using the soluble 1,2-dioxetane substrate AMPPD (Schaap et al. 1987). In this system, the sensitivity in dot blots is increased from 0.2 pg in 16 hours to 1 fg in 1 hour. In Southern hybridizations, using AMPPD as an indicator, the sensitivity is ~70 fg in 1 hour (e.g., please see Allefs et al. 1990).

In addition to its use as an indicator for alkaline phosphatase conjugates, BCIP/NBT has also been used to detect alkaline phosphatase expressed in sections of vertebrate tissues (Fields-Berry et al. 1992) and to identify bacterial colonies that express BAP (Brickman and Beckwith 1975; for review, please see Manoil et al. 1990).

BCIP is sold as a disodium salt or a toluidine salt. The toluidine salt of BCIP is suitable for use with the commercially available nonradioactive detection systems for nucleic acids and proteins.

---

## AMPPD

---

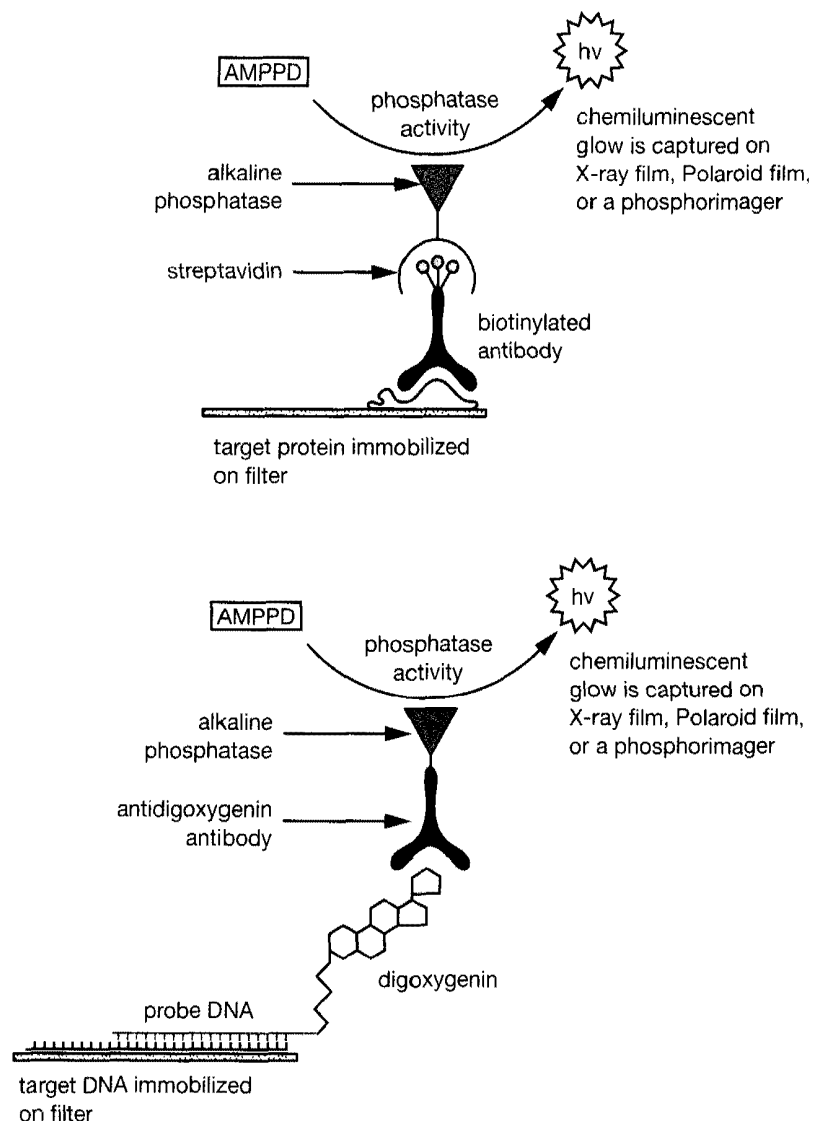
AMPPD (adamantyl-1,2-dioxetane phosphate also known as -[2'spiroadamantane]-4-methoxy-3-[3''-(phosphoryl)phenyl]1,2-dioxetane or disodium 3-(4-methoxyspiro[1,2-dioxetane-3,2'-tricyclo-[3.3.1.3<sup>7</sup>]decan]-4-yl)-phenylphosphate) is a substrate used in alkaline-phosphatase-triggered chemiluminescence for the detection of biopolymers immobilized on nylon or PVDF membranes (Bronstein and McGrath 1989; Bronstein et al. 1990; Tizard et al. 1990; Gillespie and Hudspeth 1991). Figure A9-9 shows a typical format used for the detection of proteins in western blotting and for hybridization of immobilized nucleic acids.

The sensitivity of chemiluminescent detection of DNA, RNA, and proteins using AMPPD is superior to available colorimetric, bioluminescent, or fluorimetric methods and is at least equal to the traditional autoradiographic techniques that have dominated molecular cloning for the last 20 years (e.g., please see Beck and Köster 1990; Bronstein et al. 1990; Carlson et al. 1990; Pollard-Knight et al. 1990). In solution, the light output from the activity of fewer than 1000 molecules (1 zmole or 10<sup>-21</sup> moles) of alkaline phosphatase may be measured (Schaap et al. 1989). Less than 0.1 pg of RNA or DNA may be detected in standard Southern and northern hybridizations (e.g., please see Beck et al. 1989), whereas <1 pg of a target protein may be detected in western blots of total cell proteins (Gillespie and Hudspeth 1991).

Figure A9-10 shows the events triggered by dephosphorylation of AMPPD that leads to the production of light. Alkaline phosphatase catalyzes the removal of the single phosphate residue of AMPPD, generating a moderately stable dioxetane anion that fragments into adamantanone and the excited state of a methylmetaoxybenzoate anion. On return to ground state, the anion emits visible, yellow-green light (Bronstein et al. 1989). The dephosphorylation of dioxetanes by alkaline phosphatase is quite efficient with a turnover rate of ~4.0 × 10<sup>3</sup> molecules s<sup>-1</sup> (Schaap, cited in Beck and Köster 1990). However, the half-life of the excited 1,2 dioxetane anion is comparatively long, varying from 2 minutes to several hours, depending on the

local environment (Bronstein 1990). Thus, when the dephosphorylation reaction is carried out in the presence of excess AMPPD, the dioxetane anion is initially produced more rapidly than it decays. This behavior explains why chemiluminescence is emitted in the form of a "glow" that increases in intensity for several minutes and then persists for several hours (Figure A9-11). On nylon membranes, the kinetics are even slower because the excited dioxetane anion is stabilized by hydrophobic pockets in the membrane (Tizard et al. 1990). The hydrophobic interactions between the nylon and the anion also cause a "blue shift" of ~10 nm in the emitted light, i.e., from 477 nm to 466 nm (Beck and Köster 1990; Bronstein 1990).

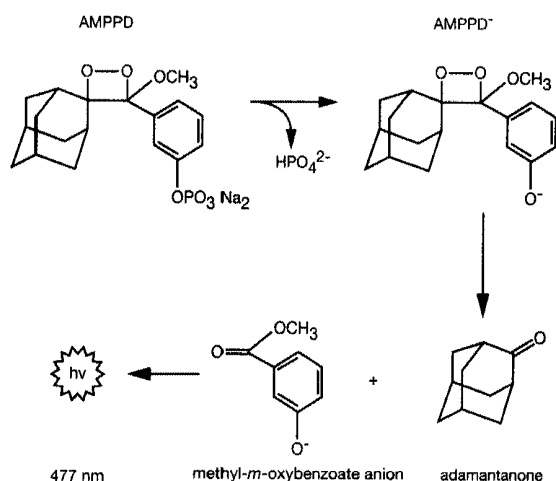
In most experimental situations, the extended kinetics of chemiluminescence on nylon filters are advantageous because they allow time to make capture images at several exposures. However, the slow kinetics may be of practical importance when alkaline-phosphatase-triggered chemiluminescence is used to detect extremely low concentrations of DNA, RNA, or protein, for example, when the target band of DNA on a filter is expected to contain  $<10^{-18}$  moles. In such cases, CSPD, a halogen-substituted derivative of AMPPD, may be a better choice. The addition of a chlorine atom to the 5-position of the adamantyl group



**FIGURE A9-9 Detection of Immobilized Nucleic Acids and Proteins with AMPPD**

(Top) Detection of target protein by western blotting; (bottom) detection of nucleic acid sequence in Southern or Northern blotting.





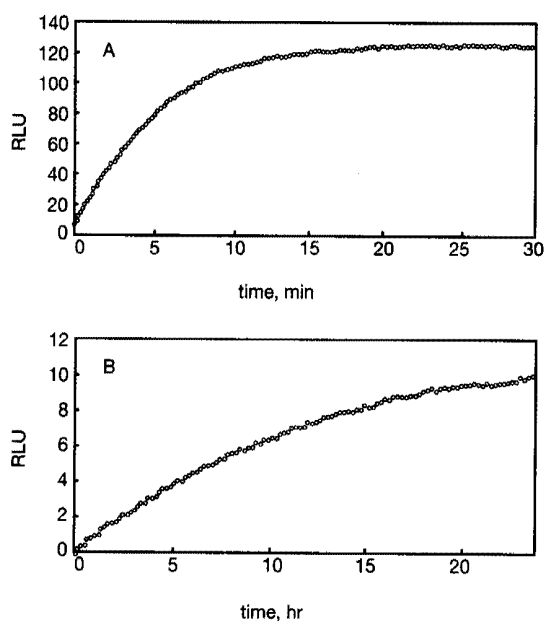
**FIGURE A9-10 Chemiluminescent Generation of Light by Dephosphorylation of AMPPD**

diminishes the tendency of the 1,2 dioxetane to self-aggregate and restricts its interactions with nylon filters. With this compound, the time to reach maximum light emission is markedly reduced so that very small quantities of target molecules can be detected rapidly (e.g., please see Martin et al. 1991).

CDP-*Star*, a third 1,2-dioxetane substrate, follows a decomposition pathway similar to that of AMPPD and CSPD, but it produces a signal several times brighter. The CDP-*Star* signal also peaks earlier in the reaction and persists for longer (up to several days) than that of its rivals (source: Tropix Web Site [www.tropix.com](http://www.tropix.com)).

Nitrocellulose filters lack the appropriate hydrophobic surfaces and are therefore not recommended for use with either AMPPD, CSPD, or CDP-*Star*; however, PVDF can be used with all three.

AMPPD is an extremely stable compound: The activation energy for its thermal decomposition in  $\text{H}_2\text{O}$  is 21.5 kcal/mole and its half-life at 25°C is ~20 years. Since nonenzymatic hydrolysis is very slow, the background of chemiluminescence on blots is minimal. In fact, the sensitivity of chemiluminescent detection of proteins and nucleic acids is generally limited, not by spontaneous decay of AMPPD, but by the presence of trace amounts in buffers of alkaline phosphatase of bacterial origin (Bronstein et al. 1990).



**FIGURE A9-11 Kinetics of Chemiluminescence of AMPPD**

Shown are the kinetics of chemiluminescence of alkaline-phosphatase-catalyzed decomposition of AMPPD in (A) 0.05 M bicarbonate/carbonate/1 mM  $\text{MgCl}_2$  (pH 9.5) or (B) on a Biodye A membrane. Luminescent rates are expressed as relative light units (RLU). (Reprinted, with permission, from Tizard et al. 1990.)

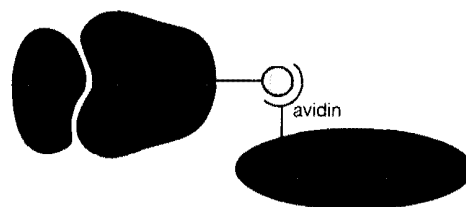
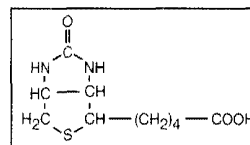
## AVIDIN AND BIOTIN

Biotin (vitamin H, coenzyme R; F.W. 244.3) is a water-soluble vitamin that binds with high affinity to avidin ( $M_r = 66,000$ ), a tetrameric, basic glycoprotein, abundant in raw egg white (for review, please see Green 1975). Because each subunit of avidin can bind one biotin molecule, 1 mg of avidin can bind  $\sim 14.8 \mu\text{g}$  of biotin. The dissociation constant of the complex is  $\sim 1.0 \times 10^{-15} \text{ M}$ , which corresponds to a free energy of association of 21 kcal/mole. With such a tight association, the off-rate is extremely slow and the half-life of the complex is 200 days at pH 7.0 (Green and Toms 1973). For all practical purposes, therefore, the interaction between avidin and biotin is essentially irreversible. In addition, the avidin-biotin complex is resistant to chaotropic agents (3 M guanidine hydrochloride) and to extremes of pH and ionic strength (Green and Toms 1972). The strength of the interaction between biotin and avidin provides a bridging system to bring molecules with no natural affinity for one another into close contact.

Biotin can be attached to a variety of proteins and nucleic acids, often without altering their properties. Similarly, avidin (or streptavidin, its nonglycosylated prokaryotic equivalent) can be joined to reporter enzymes whose activity can be used to locate and/or quantitate avidin-biotin-target complexes. For example, in enzyme immunoassays, a biotinylated antibody bound to an immobilized antigen or primary antibody is often assayed by an enzyme, such as horseradish peroxidase or alkaline phosphatase, that has been coupled to avidin (Young et al. 1985; French et al. 1986). In addition, in nucleic acid hybridization, biotinylated probes can be detected by avidin-conjugated enzymes or fluorochromes. Derivatives of biotin are used to biotinylate proteins, peptides, and other molecules (for review and references, please see Wilchek and Bayer 1990).

The disadvantage of egg white avidin is the relatively high background of nonspecific binding caused by the presence of oligosaccharide groups. This problem can be reduced by using streptavidin, a tetrameric nonglycosylated 58,000-dalton protein secreted by *Streptomyces avidini* that binds biotin with approximately the same affinity as egg-white avidin.

For more information on biotin, please see the information panel on **BIOTIN** in Chapter 11. Much useful information about avidin-biotin chemistry and avidin-biotin techniques is available in a handbook entitled *Avidin-Biotin Chemistry: A Handbook*, published and sold by Pierce.



**FIGURE A9-12** The Avidin-Biotin Complex

---

**IMMUNOGLOBULIN-BINDING PROTEINS: PROTEINS A, G, AND L**


---

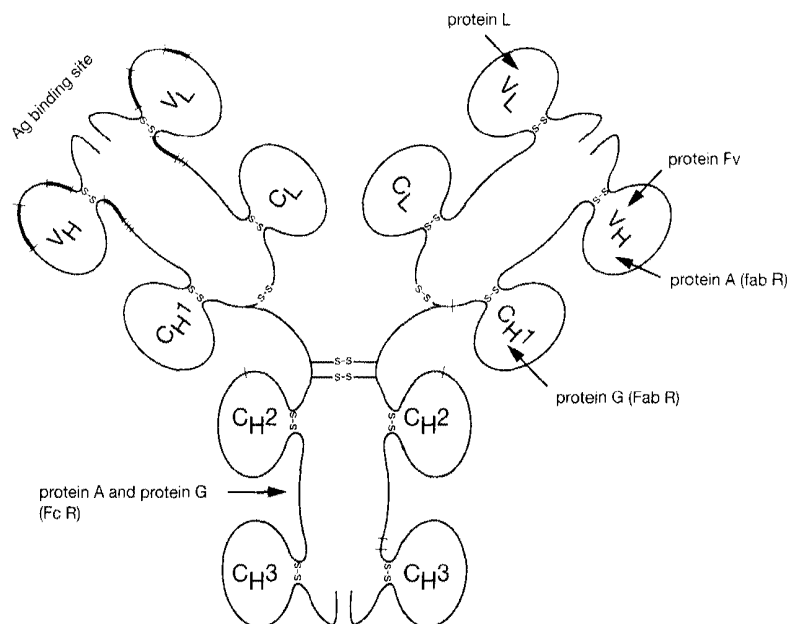
**Protein A**

Protein A, a cell wall component of *Staphylococcus aureus*, binds to the Fc region of immunoglobulins (IgG) of many mammalian species and thereby helps the bacterium escape the immune response of the host (Forsgren and Sjöquist 1966; for review, please see Langone 1982; Boyle and Reis 1987; Boyle 1990; Bouvet 1994) (please see Table A9-7). The interaction of protein A with the Fc portion of IgG molecules does not block the ability of the antibody to combine with its antigen (Figure A9-13). Protein A has been used extensively for both qualitative and quantitative analysis of immunochemical reactions (Goding 1978; Harlow and Lane 1988, 1999).

**TABLE A9-7 Binding of Protein A and Protein G to the Fc Region of Mammalian Immunoglobulins**

IMMUNOGLOBULIN	PROTEIN A ( <i>STAPHYLOCOCCUS AUREUS</i> )	PROTEIN G (STREPTOCOCCI OF GROUPS C AND G)
Human IgG1	++	++
Human IgG2	++	++
Human IgG3	-	++
Human IgG4	++	++
Mouse IgG1	+	+
Mouse IgG2a	++	++
Mouse IgG2b	++	++
Mouse IgG3	++	++
Rat IgG1	+	+
Rat IgG2A	-	++
Rat IgG2b	-	+
Rat IgG2c	++	++
Rabbit IgG	++	++
Bovine IgG1	-	++
Bovine IgG2	++	++
Sheep IgG	-	++
Sheep IgG2	++	++
Goat IgG1	+	++
Goat IgG2	++	++
Horse IgG(ab)	+	++
Horse IgG(c)	+	(+)
Chicken	-	(+)
Hamster	(+)	+
Guinea Pig	++	+

Data on human IgG from Forsgren and Sjöquist (1966), Kronvall (1973), and Myhre and Kronvall (1977, 1980a); on mouse from Kronvall et al. (1970a), Chalon et al. (1979), and Myhre and Kronvall (1980b); on rat from Medgyesi et al. (1978) and Nilsson et al. (1982); on rabbit from Kronvall (1973), Myhre and Kronvall (1977), and Forsgren and Sjöquist (1967); on bovine from Lind et al. (1970), Myhre and Kronvall (1981), and Kronvall et al. (1970b); on ovine, equine, and caprine from Kronvall et al. (1970b) and Sjöquist et al. (1972). Data on other animals are from Richman et al. (1982), Björck and Kronvall (1984), Åkerström et al. (1985), and Åkerström and Björck (1986).



**FIGURE A9-13 Immunoglobulin Regions Recognized by the Fab-binding Molecules**

(Redrawn, with permission, from Bouvet 1994 [©Elsevier Science].)

**TABLE A9-8 Binding of Immunoglobulins to Protein L, Protein A, and Protein G**

IMMUNOGLOBULIN	PROTEIN L	PROTEIN LA <sup>a</sup>	PROTEIN A	PROTEIN G
<b>Human</b>				
IgG	++	++	+	+++
IgM	++	++	+	-
IgA	++	++	+	-
IgE	++	++	+	-
IgD	++	++	+	-
Fab	++	++	+	+
F(ab') <sub>2</sub>	++	++	-	+
κ light chains	++	++	+	-
scFv	++	++	+	-
<b>Mouse</b>				
IgG1	++	++	+	++
IgG2a	++	++	++	++
IgG2b	++	++	++	++
IgG3	++	++	+	++
IgM	++	++	+	-
IgA	++	++	++	+
<b>Polyclonal</b>				
Mouse	++	++	++	++
Rat	++	++	+	++
Rabbit	+	++	++	+++
Sheep	-	++	++	++
Goat	-	++	+	++
Bovine	-	++	+	++
Porcine	++	++	++	++
Chicken IgY/IgG	++	++	-	-

Modified, with permission, from CLONTECH ([www.clontech.com/archive/JUL98UPD/proteinL.html](http://www.clontech.com/archive/JUL98UPD/proteinL.html)).

<sup>a</sup>Protein LA combines the immunoglobulin-binding domains of protein A and protein L.

- **When coupled to a radioactive, enzymatic, or fluorescent tag**, protein A is an excellent reagent to detect and quantitate antibodies with high affinity for the protein. Protein A chemically coupled to particles of colloidal gold can be used to locate IgGs by electron microscopy.
- **Protein A immobilized on a solid support** can be used to purify antibodies and to collect immune complexes, antigens, and whole cells (please see Figure A9-14).
- **Using ELISA-like sandwich techniques, DNA fragments can be purified** and detected using purified protein A or engineered fusion proteins containing the IgG-binding domains of protein A domains (e.g., please see Lindbladh et al. 1987; Peterhans et al. 1987; Werstuck and Capone 1989; for review, please see Stahl et al. 1993).

Chimeric proteins containing two independent ligand-binding domains have also been explored as adhesive immunological reagents. For example:

- **Molecules labeled with digoxigenin** may be labeled with a fusion protein containing an IgG-binding domain of protein A and an antigen-binding site of an antidigoxigenin antibody. The label may then be detected with any antibody that binds to protein A (Tai et al. 1990).
- **Streptavidin-protein A chimeras** may be used for indirect labeling of antibodies with enzymes (Sano and Cantor 1991).
- **Protein A-maltose binding protein chimeras** may be used as bifunctional reagents for binding antibodies to a solid matrix (Xue et al. 1995).
- **Protein A** can be used as an affinity tag to purify fusion proteins synthesized in pro- and eukaryotic cells (e.g., please see Kobatake et al. 1995; Nilsson et al. 1985; for reviews, please see Nilsson and Abrahamson 1990; Uhlén and Moks 1990; Uhlén et al. 1992; Stahl et al. 1993). The simplest protocol involves purifying fusion proteins containing the Fc-binding domains of protein A by affinity chromatography with an IgG resin (Uhlén et al. 1983; Nilsson et al. 1985).

The gene for protein A (Uhlén et al. 1984) encodes a preprotein of 509 amino acids that consists of a signal sequence, which is removed during secretion: five homologous, independent IgG-binding domains, each of 58 amino acids; and a repetitive carboxy-terminal anchor (region X), of 180 amino acids. Crystallographic analysis of cocrystals of a single IgG-binding domain of protein A bound to human Fc shows that the IgG-binding domain contains two  $\alpha$ -helices that form extensive hydrophobic interactions with the second and third constant regions of the Fc domain (Deisenhofer 1981).

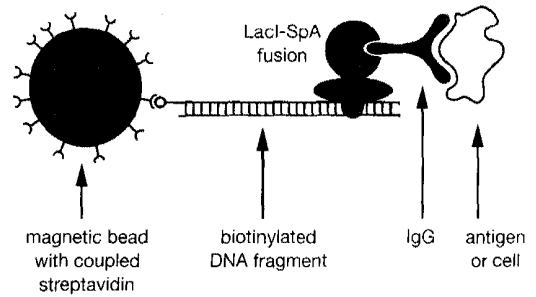
## Protein G

Protein G was first isolated from streptococcal strains belonging to groups C and G (Björck and Kronvall 1984). Protein G, like staphylococcal protein A, has a high affinity for the Fc region of mammalian antibodies. However, the two proteins are quite different in structure and have different affinities for antibodies (please see Table A9-8) (Åkerström et al. 1985). Whereas protein A is rich in  $\alpha$ -helices and forms hydrophobic interactions with immunoglobulins, protein G has a large content of  $\beta$ -sheet structures (Olsson et al. 1987; Gronenborn et al. 1991). Protein G binds to the first constant domain of IgG (Erntell et al. 1985) and the interaction between the two molecules involves alignment of  $\beta$  strands to form a continuous  $\beta$ -sheet across the interacting surfaces (Derrick and Wigley 1992). The structures recognized by protein G and protein A are closely related (Stone et al. 1989). However, many species and subclasses of IgGs that do not bind well to protein A bind with high efficiency to protein G. For example, protein G is able to bind efficiently to human immunoglobulins of the IgG3 subclass, whereas protein A cannot (Sjöbring et al. 1991). Chimeric proteins, containing ligand-binding domains of proteins A and G exhibit the combined specificities of the parental proteins (Eliasson et al. 1988, 1989).

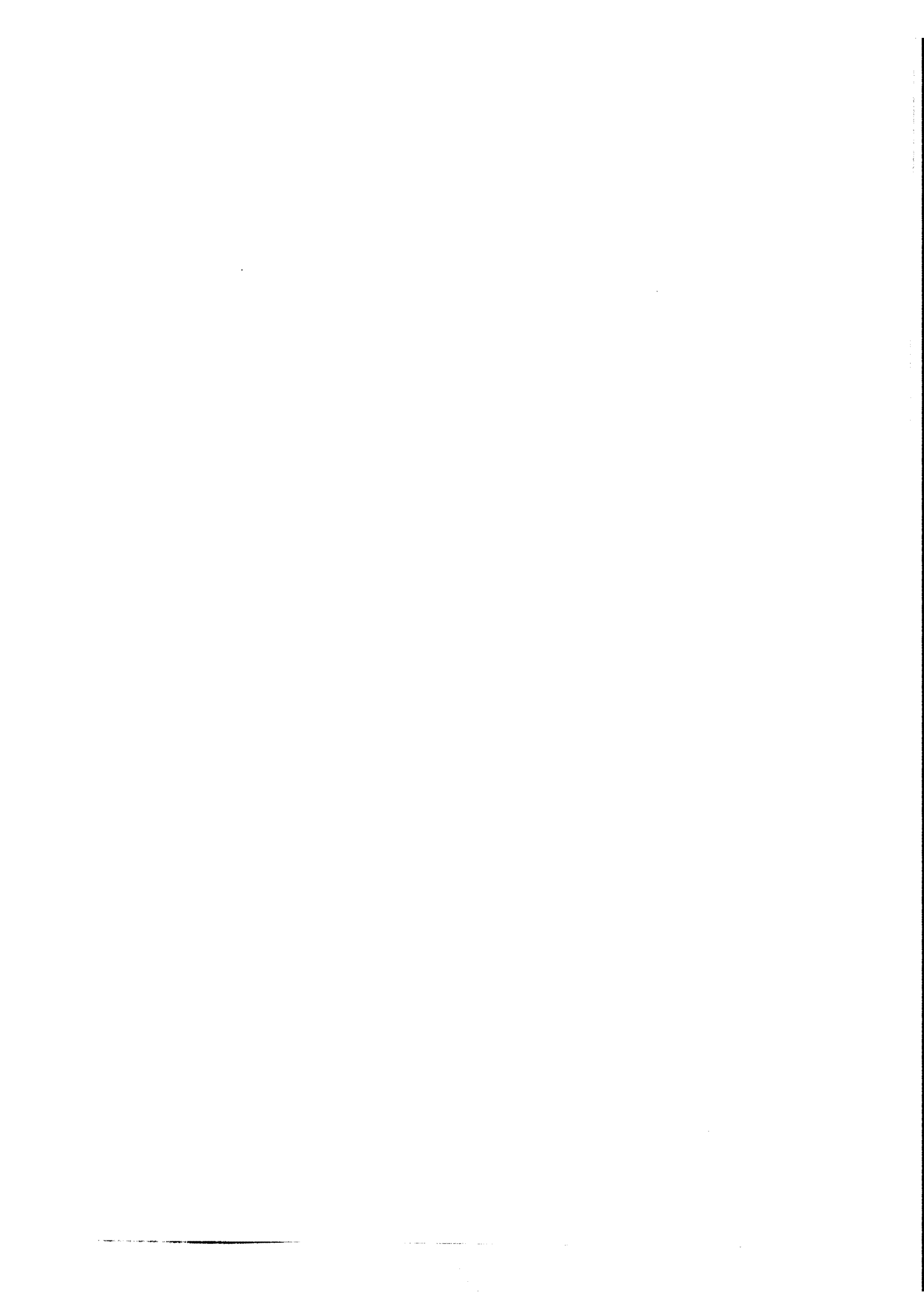
One potential disadvantage of protein G as a reagent to collect immune complexes and to purify IgGs is that it binds strongly to bovine serum albumin (Björck et al. 1987). However, the IgG-binding site and the serum albumin-binding site are structurally distinct (Nygren et al. 1988; Sjöbring et al. 1989) and engineered versions of protein G lacking the albumin-binding site are commercially available. The serum albumin domains of protein G have been used as purification tags in fusion proteins (Nygren et al. 1988, 1991; Sjölander et al. 1993).

**FIGURE A9-14 Isolation of Antigens or Whole Cells Using a LacI-SpA Fusion Protein**

The figure illustrates the use of a *lac* repressor (LacI-SpA) fusion protein for reversible recovery of protein antigens or whole cells using magnetic beads with a coupled DNA fragment containing the *lac* operator (*lacO*) sequence.

**Protein L**

Protein L ( $M_r \sim 76,000$ ) (Åkerström and Björck 1989) is a cell-wall component of the anaerobic bacterium *Peptostreptococcus magnus* (Björck 1988), which binds with high affinity to the  $\kappa$  light chains of immunoglobulins. This interaction does not interfere with the antigen-binding sites of the antibody (Åkerström and Björck 1989). Protein L binds to a wide range of Ig subclasses including human, mouse, rat, rabbit, and chicken (please see Table A9-8), but it does not bind to bovine, goat, or sheep Ig. These species-specific binding characteristics make protein L a useful tool for antibody purification, in particular for the purification of monoclonal antibodies from media supplemented with fetal bovine serum or bovine serum albumin and the purification of humanized antibodies from transgenic animals. Protein L is available commercially (e.g., CLONTECH and Pierce).



# Appendix 10

---

## DNA Array Technology

Vivek Mittal  
*Cold Spring Harbor Laboratory*

<b>INTRODUCTION</b>	A10.2
The Process	A10.2
Applications	A10.2
<b>OVERVIEW AND SCHEMA OF DNA MICROARRAYS</b>	A10.3
Clone Sources and Their Description	A10.3
Robotics for High-throughput Processing	A10.5
Solid Support and Surface Chemistry	A10.5
Microarray Production	A10.7
Commercial Arrays and Integrated Array Services	A10.8
Choice of an Array System	A10.8
<b>IMAGING AND ANALYSIS OF THE ARRAY</b>	A10.10
Sample Processing and Hybridization	A10.10
Detection of the Hybridization Signal	A10.11
Image Analysis	A10.12
Some Considerations in Performing a Microarray Experiment	A10.13
<b>MICROARRAY DATA MINING, ANALYSIS, AND MANAGEMENT</b>	A10.14
<b>EMERGING TECHNOLOGIES</b>	A10.16
Novel Microarray Fabrication Methods	A10.16
Resequencing	A10.17
Specific, High-throughput Genotyping by Primer Extension on Microarrays	A10.17
Direct Identical-by-descent Mapping Using DNA Arrays	A10.17
Protein Microarrays	A10.18
Tissue Microarrays	A10.18
Use of Arrays to Detect DNA-Protein Interactions	A10.18
Barcode Chip	A10.19
Bioelectronic Chips	A10.19
<b>SUMMARY</b>	A10.19



## INTRODUCTION

---

With the growing abundance of sequencing data from such diverse organisms as yeast, bacteria, fruit fly, several plants, and humans comes a pressing need for developing and applying technologies to perform comprehensive functional analyses. DNA microarrays have been developed in response to the need for simultaneous analysis of the patterns of expression of thousands of genes. Microarrays therefore offer tremendous advantages over traditional "single-gene" methods such as northern hybridization, reverse transcriptase-polymerase chain reaction (RT-PCR), and nuclease protection.

### The Process

In a typical application, high-density nucleic acid samples, usually cDNAs or oligonucleotides, are delivered (or printed) by a robotic system onto very small, discrete areas of coated substrates (or chips) usually microscopic glass slides or membrane filters, and then immobilized to the substrate. The resulting microarray is then hybridized with a complex mixture of fluorescently labeled nucleic acids (probe) derived from a desired source. Following hybridization, the fluorescent markers are detected using a high-resolution laser scanner. A pattern of gene expression is obtained by analyzing the signal emitted from each spot with digital imaging software. The pattern of gene expression of the experimental sample can then be compared with that of a control for differential analyses. The use of terms varies in the literature; however, in this discussion, probe refers to the mixture of labeled nucleic acids and target denotes the immobilized array of nucleic acid samples.

### Applications

Two chief applications of DNA microarray technology are described briefly below. Other applications include gene discovery, genotyping, and pathway analysis.

#### *Analysis of Gene Expression*

Gene expression patterns are biologically informative and provide direct clues to function. Correlating changes in gene expression with specific changes in physiology can provide mechanistic insights into the dynamics of various biological processes in an organism. Microarray technology may be used, for example, for simultaneously detecting expression of many genes in different tissues or at different developmental stages; for comparing genes expressed in normal and diseased states; and for analyzing the response of cells exposed to drugs or different physiological conditions. The value of microarrays for identifying patterns of gene expression has been demonstrated clearly in organisms such as yeast, fruit flies, mice, and humans. In yeast, for example, gene expression patterns obtained using cDNA arrays correlate very well with changes in the yeast cell cycle (yeast data sets and analysis tools are available at [cmgm.stanford.edu/pbrown/](http://cmgm.stanford.edu/pbrown/)). In explorations of human cancer, expression arrays have aided in the molecular classification of B-cell lymphomas and leukemias. These studies are likely to help us to understand the pathophysiology of cancer and to define targets for therapeutic intervention.

#### *Monitoring Changes in Genomic DNA*

Cancer cells typically exhibit genomic instability, including gain-of-function mutations of oncogenes often marked by gene amplifications or translocations and loss-of-function mutations in

tumor suppressor genes often marked by point mutations and subsequent loss of heterozygosity or by homozygous deletions. Three laboratories are now using microarrays for high-resolution analysis of genomic DNA:

- The Brown laboratory ([cmgm.stanford.edu/pbrown](http://cmgm.stanford.edu/pbrown)) uses cDNA microarrays.
- The Gray laboratory ([cc.ucsf.edu/gray/](http://cc.ucsf.edu/gray/)) uses microarrays of genomic DNA cloned in BAC vectors.
- The Wigler laboratory ([nucleus.cshl.org/wigler/](http://nucleus.cshl.org/wigler/)) uses microarrays derived from low-complexity representations of genomic DNA.

Which method or combination of methods will be successful in measuring changes in copy number of nonabundant sequences with high statistical confidence in clinical samples remains to be determined.

Mutations and polymorphisms, in particular single nucleotide polymorphisms (SNPs), can be studied within and among species using high-density oligonucleotide arrays. These so-called mutation detection arrays consist of oligonucleotides representing all known sequence variants of a gene or a collection of genes. Because hybridization to oligonucleotides is sensitive enough to detect single-nucleotide mismatches, an homologous gene carrying an unknown sequence variation can be screened rapidly for a large number of changes. Examples of mutation detection arrays include a p53 gene chip, an HIV gene chip, and a breast cancer BRCA-1 gene chip.

The remainder of this discussion focuses on the technological aspects of DNA microarrays, with little further emphasis on applications. It is imperative to remember that DNA microarrays represent a developing technology and that there remain substantial obstacles in the design and analysis of these microarrays.

## OVERVIEW AND SCHEMA OF DNA MICROARRAYS

---

There are six basic steps in performing a DNA microarray experiment (please see Figure A10-1):

1. Processing cDNA clones to generate print-ready material.
2. Printing cDNA clones (or oligonucleotides) onto a substrate.
3. Sample RNA isolation (either total RNA or mRNA).
4. Preparation of the probe (e.g., cDNA synthesis and labeling).
5. Hybridization of the labeled probe DNA to the DNA arrayed on the substrate.
6. Image acquisition of hybridization results and image analysis.

### Clone Sources and Their Description

The initial resources required to design and fabricate gene expression microarrays include genomic or cDNA sequence data, cDNA clones, or both. Traditional approaches to gene discovery, such as cloning, have identified only a small subset of genes in an organism. More recent approaches, for example, large-scale sequencing of expressed sequence tags (ESTs), have greatly enhanced the rate of gene discovery. GenBank now has a collection of >1 million human ESTs. EST sequences are deposited into the databank dbEST ([www.ncbi.nlm.nih.gov/dbEST/index.html](http://www.ncbi.nlm.nih.gov/dbEST/index.html)), a division of GenBank. Sequences stored in dbEST are subjected to an automated

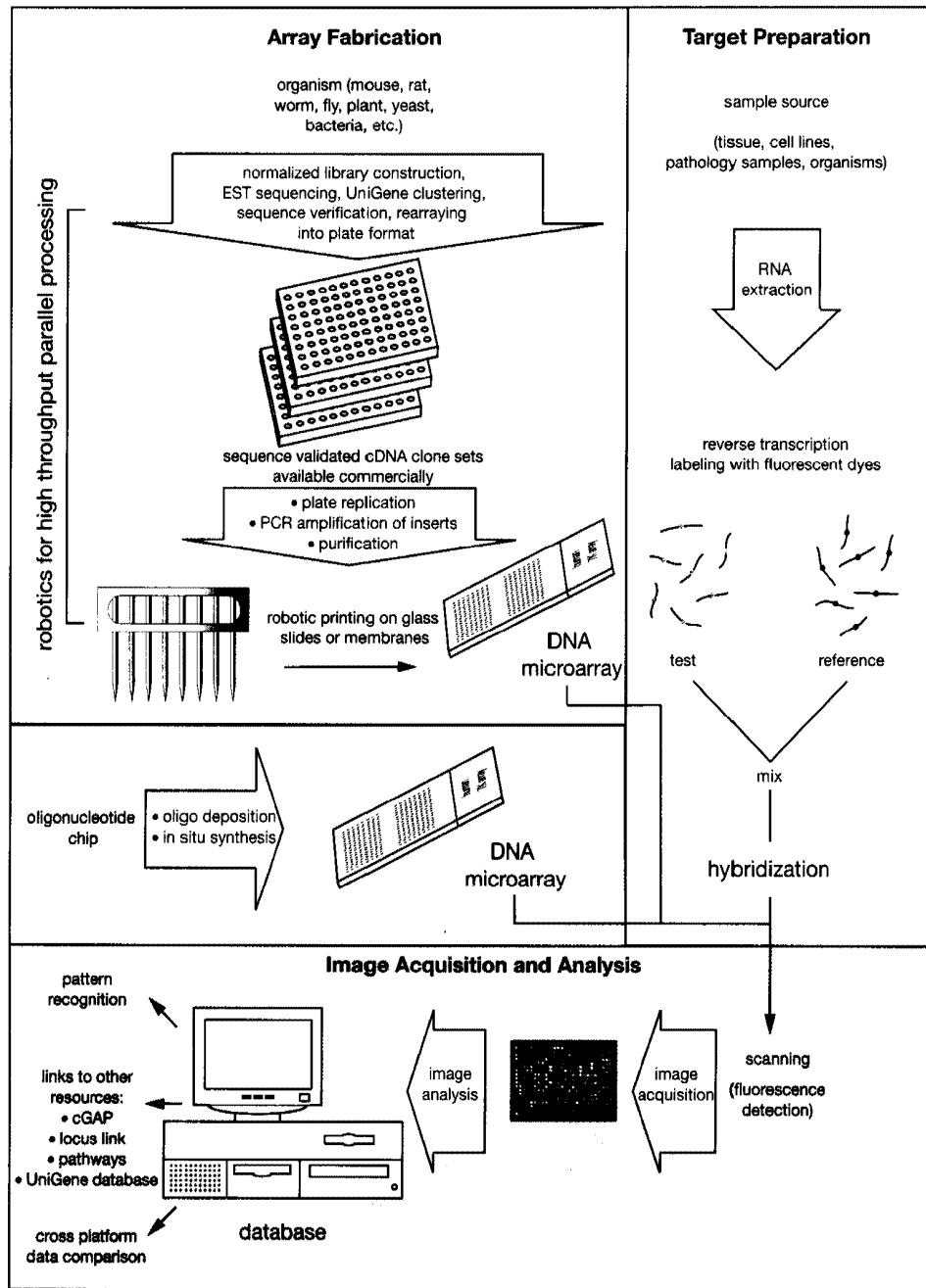


FIGURE A10-1 Flowchart: Performing a Microarray Experiment

process called UniGene that compares ESTs and assembles overlapping sequences into clusters ([www.ncbi.nlm.nih.gov/UniGene/index.html](http://www.ncbi.nlm.nih.gov/UniGene/index.html)). Clone sets, comprising the largest single representative of each cluster, are sequence-verified and then made available to the public through licensed vendors (<http://image.llnl.gov/image/html/idistributors.shtml>).

The current UniGene collection of human and mouse cDNA sequences (~40,000 and 10,000 sequence-validated clones, respectively) is available for purchase through official vendors such as Research Genetics ([www.resgen.com](http://www.resgen.com)) and Incyte Genomics ([gem.incyte.com/gem/products/unigemv2.shtml](http://gem.incyte.com/gem/products/unigemv2.shtml)). The UniGene collection is likely to expand proportionally with progress in

the various genome sequencing projects. Another resource for the human cDNA collection is the German Human Genome Project (<http://www.rzpd.de/general/html/glossary/unigene.shtml>). A comprehensive, sequence-validated full-length mouse cDNA collection is also available from Riken Genomic Sciences Center, Japan (<http://hgp.gsc.riken.go.jp/>) and from the National Institute of Aging (<http://lgsun.grc.nia.nih.gov/>). Table A10-1 presents genomic resources for organisms other than human and mouse that are available for microarray fabrication.

## Robotics for High-throughput Processing

Considering the enormous size of clone sets derived from eukaryotic genomes, some degree of automation is typically required to obtain print-ready material with a high degree of accuracy and reproducibility. Two robotic systems, designed for high-throughput parallel processing, encompassing fully automated or semi-automated liquid-dispensing and plate-handling systems are the Robbins Hydra Work Station ([www.robsci.com](http://www.robsci.com)), which uses high-precision Teflon-coated capillaries, and the Beckman Coulter Multimek ([www.beckmancoulter.com](http://www.beckmancoulter.com)), which uses disposable tips. In addition to accurate volumetric handling of liquids to and from standard 96-well or 384-well plates, these robotic systems also have reformatting capabilities, allowing the transfer of material between 96- and 384-well plates on the same work surface. Each robotic unit can be integrated with other automated systems. Robots with analogous capabilities are the Qiagen BioRobot ([www.qiagen.com/automation/](http://www.qiagen.com/automation/)), Tecan AG GENESIS sample processor ([www.tecan.com](http://www.tecan.com)), Packard MultiPROBE ([www.packardinst.com](http://www.packardinst.com)), and Tomtec Quadra ([www.tomtec.com](http://www.tomtec.com)).

## Solid Support and Surface Chemistry

The development of novel solid supports and efficient chemistries for the manufacture of spatially resolved microscopic DNA arrays is essential if the potential of DNA chip technology is to be fully realized. A good substrate must bind DNA efficiently and uniformly, and leave the surface-bound DNA both functional and accessible. The density of DNA attached to the substrate must be high, the bound array must be stable, and the substrate must be chemically inert and have ultra-low intrinsic fluorescence while providing strong signal intensity and a broad dynamic range. Two basic substrates commonly used are glass and membrane filters.

Chemically treated microscope glass slides are the most widely used support. Glass is optically superior, durable under high temperatures of hybridization, and nonporous, thus keeping hybridization volumes to a minimum; it has low autofluorescence and good geometry and is amenable to high-density array fabrication. The major disadvantages of glass are that its planar surface has low loading capacity, the array on a glass support is not reusable, and an efficient chemistry for linking DNA to glass is lacking.

Glass slides coated with amine or aldehyde surface chemistry are available from Corning Microarray Technology (CMT) (<http://www.cmt.corning.com/>), Cel ([www.cel-1.com/bio-molecular\\_products.htm](http://www.cel-1.com/bio-molecular_products.htm)), and TeleChem International ([www.Arrayit.com](http://www.Arrayit.com)). It is also possible to attach DNA covalently to glass slides. SurModics' 3D-Link Activated Slides are coated with a three-dimensional matrix that covalently binds amine-terminated DNA (PCR products or oligonucleotides) through endpoint attachment ([www.surmodics.com](http://www.surmodics.com)). A common method for making amine-coated glass slides in-house is to treat them with polylysine. Details on the chemistry and instructions for preparing polylysine slides are available on the Brown laboratory Web Site (<http://cmgm.stanford.edu/pbrown/index.html>).

A major effort is now under way to explore the use of porous materials (such as nitrocellulose, nylon, and acrylamide) as substrates for attachment of nucleic acids. Porous substrates per-

TABLE A10-1 Genomic Resources for Microarrays

ORGANISM	MATERIAL	COMMENTS	RESOURCE
Rat	6000 cDNA clones	1500 sequence-validated clones are available.	Research Genetics (www.resgen.com)
Yeast ( <i>S. cerevisiae</i> )	ORF-specific primer pairs	These primers are designed to amplify complete coding regions including start and stop codons from genomic DNA (possible because very few yeast genes contain introns). Recently, The Sanger Centre and the Imperial Cancer Research Fund have initiated work on amplification of coding regions from the fission yeast <i>S. pombe</i> .	Research Genetics (www.resgen.com)
	intergenic region primer pairs	These primer pairs are designed to amplify regions that lie between the open reading frames (ORFs), from genomic DNA, for use in cloning yeast promoters upstream of reporter genes, assaying deletions or insertions in yeast genes, and mapping transcription-factor-binding sites.	Research Genetics (www.resgen.com)
<i>Arabidopsis thaliana</i>	7900-member clone set	The clones represent genes from all major tissue categories (e.g., roots, rosettes, and inflorescence).	Incyte Genomics (www.incyte.com/products/organisms.html)
	11,500 EST clones	Collection was generated at Michigan State University.	Affymetrix
<i>Caenorhabditis elegans</i>	cDNA arrays representing the complete set of <i>C. elegans</i> genes	These microarrays along with support for hybridization and data analysis are available to other <i>C. elegans</i> laboratories on a collaborative basis.	Stuart Kim's laboratory at Stanford University (cmgm.stanford.edu/~kimlab/)
	primer pairs	These primer pairs can amplify all or a portion of each of the 19,000 genes.	Research Genetics (www.resgen.com)
<i>Drosophila melanogaster</i>	cDNAs representing 12,000 genes	The cDNA collection is currently undergoing annotation at the Berkeley <i>Drosophila</i> Genome Project.	Berkeley <i>Drosophila</i> Genome Project (www.fruitfly.org) will be available for purchase through Research Genetics (www.resgen.com)
<i>Escherichia coli</i>	4290 ORF sequences	Membrane arrays containing a complete set of PCR-amplified genes.	Genosys Biotechnologies (http://www.genosys.com/expression/frameset.html)
<i>Bacillus subtilis</i>	4107 ORF sequences	PCR-amplified ORFs.	Genosys Biotechnologies
<i>Helicobacter pylori</i>	putative 1590 ORFs of strain 26,695; 91 ORFs unique to strain J99		Genosys Biotechnologies
<i>C. jejuni</i>	1654 genes		Genosys Biotechnologies
<b>In Development:</b>			
<i>Staphylococcus aureus</i>	1900 ORF sequences		Incyte Genomics (www.incyte.com/products/organisms.html)
<i>Candida albicans</i>	ORF sequences		Incyte Genomics (www.incyte.com/products/organisms.html)

mit the immobilization of large amounts of target molecules due to greatly enhanced surface area, providing enhanced sensitivity compared to planar substrates. Porous substrates based on polymer matrices provide a three-dimensional hydrophilic environment similar to free solution for biomolecular interactions. The utility of nitrocellulose-coated glass surfaces for microarrays has been demonstrated. The high binding capacity of nitrocellulose combined with low background

fluorescence makes these membrane-coated slides a superior substrate for microarrays. They are available from Schleicher & Schuell ([www.s-und-s.de/](http://www.s-und-s.de/)).

## Microarray Production

Microarrays may be produced using one of the methods described below. Alternatively, prefabricated microarrays from many sources are available commercially. Microarray fabrication technologies are of two kinds: in situ synthesis of nucleic acids and exogenous deposition of prepared materials on solid substrates. Three types of advanced technologies have emerged as early favorites in automated microarray production.

### Contact Printing

In this approach, DNA fragments are directly deposited onto a glass support using a precision robot. The DNA sample is loaded into a spotting pin by capillary action and small volumes are transferred to a solid surface, such as a microscope slide, by direct physical contact between the pin and the solid substrate. After the first spotting cycle, the pin is washed and a second sample is then transferred to an adjacent address. A robotic control system and multiplexed print heads allow automated microarray fabrication. One of the crucial factors affecting array fabrication using the contact printing method is the reproducibility and durability of the spotting pins (also called quills or tips). Custom, machine-made high-precision pins can be obtained from Telechem International ([www.arrayit.com](http://www.arrayit.com)), Majer Precision Engineering (<http://www.majerprecision.com/>), and Die-Tech (San Francisco).

The first contact printing arrayer was designed and built in the laboratory of Patrick Brown at Stanford University. An arrayer based largely on the Stanford prototype was subsequently fabricated in the National Human Genome Research Institute (NHGRI, [www.nhgri.nih.gov/DIR/LCG/15K/HTML](http://www.nhgri.nih.gov/DIR/LCG/15K/HTML)) and at the Albert Einstein College of Medicine (<http://sequence.aecom.yu.edu/bioinf/microarray/printer.html>). For the “do-it-yourself” approach, detailed instructions for assembling a contact printing arrayer, including a description of the necessary parts, can be found at <http://cmgm.stanford.edu/pbrown/mguide/>. Commercial robotic systems for making arrays by contact printing are offered by

- Cartesian Technology ([www.cartesiantech.com/pixsyspa.htm](http://www.cartesiantech.com/pixsyspa.htm))
- GeneMachines' OmniGrid ([www.genemachines.com](http://www.genemachines.com))
- Genomic Solutions ([www.genomicsolutions.com](http://www.genomicsolutions.com))
- BioRobotics ([www.biorobotics.co.uk](http://www.biorobotics.co.uk))
- Genetix ([www.genetix.co.uk/Microarraying.htm](http://www.genetix.co.uk/Microarraying.htm))
- Intelligent Bio-Instruments ([www.intelligentbio.com](http://www.intelligentbio.com))
- Genepak ([www.genepakdna.com](http://www.genepakdna.com))
- Amersham Pharmacia Biotech ([www.apbiotech.com/application/microarray/](http://www.apbiotech.com/application/microarray/))

A less expensive alternative to robotic spotting of samples onto substrates is to use a hand-held 384-pin arraying device, available from V & P Scientific, Inc. ([www.vp-scientific.com/](http://www.vp-scientific.com/)). This vendor offers pin tools for 96-, 384-, and 1536-well plates, as well as registration accessories that allow the creation of high-density arrays of up to 3456 samples per array.

### ***Photolithography***

Developed by Affymetrix ([www.affymetrix.com](http://www.affymetrix.com)), this method combines photolithography technology from the semiconductor industry with DNA synthetic chemistry to permit the manufacture of high-density oligonucleotide microarrays. A solid support is derivatized with a covalent linker terminated with a photolabile protecting group. A photomask is used to determine which positions react with light. Exposure to light causes dissociation of the protecting group at the exposed site. A chemical coupling reaction is then used to add a specific nucleotide to the new deprotected site, and the process is repeated using a different mask. The end result is a precision-made array, containing many oligonucleotides of known sequence. The Affymetrix method for making arrays demands a technical sophistication that generally cannot be imported to academic laboratory settings.

### ***Pin and Ring***

A "pin and ring" device is used for sample spotting by a noncontact mechanism. The ring holds a droplet of solution picked up from the well of a microtiter plate, and the pin punches a smaller droplet from this reservoir onto the substrate. The main advantage of this technology is the ability to generate consistent delivery from a variety of solvents with DNA, proteins, and small molecules on virtually any substrates. The technology as it currently stands has a high degree of precision but lacks the desired robustness. This technology was developed at Genetic Microsystems, now wholly owned by Affymetrix ([www.affymetrix.com](http://www.affymetrix.com)).

## **Commercial Arrays and Integrated Array Services**

The formidable task of generating microarrays is time-consuming and frequently cost-prohibitive for many laboratories. Some commercial ventures have fabricated microarrays on membranes (nylon and nitrocellulose) and/or glass, and these are available commercially (please see Table A10-2). Commercial arrays are also available from Hyseq ([www.hyseq.com](http://www.hyseq.com)) and Stratagene ([www.stratagene.com/gc/gene.htm](http://www.stratagene.com/gc/gene.htm)).

## **Choice of an Array System**

The choice of a DNA array for a particular experiment requires consideration of the expense, desired density of DNA on the array, reproducibility among chips, and type of DNA to be immobilized on the surface. The first decision is whether the chips should contain immobilized cDNAs or shorter oligonucleotide sequences. cDNA samples must be spotted onto the chips as complete molecules, whereas oligonucleotides can be either spotted or synthesized on the surface of a chip with high fidelity. Another important decision is whether the user will make the arrays or purchase the chips. The advantages and disadvantages for each of these issues for each approach are presented in Table A10-3.

**TABLE A10-2 Commercial Arrays**

PRODUCTS	SOURCE	DESCRIPTION	COMMENTS
GeneChip product line (includes high-density DNA arrays for human, murine, yeast, and plant genomes)	Affymetrix www.affymetrix.com	GeneChip expression arrays use ~20 pairs of matched and mismatched oligonucleotides to interrogate each transcript. GeneChips designed for clinical settings include: <i>p53 GeneChip</i> to detect single-nucleotide polymorphisms of the p53 tumor-suppressor gene. <i>HIV GeneChip</i> to detect mutations in the HIV-1 protease and viral reverse transcriptase genes. <i>P450 GeneChip</i> , which focuses on mutations of key liver enzymes that metabolize drugs.	This oligonucleotide-pairing strategy helps identify and minimize the effects of nonspecific hybridization and background signal (a major concern in array experiments) to permit sensitive and accurate recognition of low-intensity hybridization patterns from mRNAs. In addition to expression monitoring, Affymetrix chips are also used for sequence analysis, genotyping, and SNP mapping. An integrated platform comprising an automated hybridization station, array scanner, and software for image analysis is mandatory for Affymetrix DNA chip users.
GeneFilters microarrays (for human, murine, and yeast)	Research Genetics www.resgen.com	The human cDNA arrays consist of 30,000 nonredundant sequence-validated I.M.A.G.E. clones (on six different membranes) chosen from the UniGene set. The tissue-specific GeneFilters are gene expression arrays that contain sequences enriched for expression in prostate, ovary, breast, and colon tissues. Membranes carrying 6144 yeast ORFs and 10,000 sequence-validated rat cDNAs are also available.	A Pathways analysis software package from the same source is available for image analysis of the GeneFilters.
Atlas cDNA arrays	CLONTECH www.clontech.com	Arrays on nylon membranes or glass are available for a range of mammalian genes involved in cellular pathways such as oncogenesis, apoptosis, and cell cycle regulation. The arrays contain human, mouse, or rat cDNA and are usually spotted in duplicate. The Atlas human 1.0 cDNA array (on glass) represents 1081 known genes, covering a broad range of biologically significant genes and pathways.	All of the immobilized cDNAs have been tested for optimal performance and minimal cross hybridization. An integrated Expression Array platform, including a total RNA purification/labeling system, image analysis software, and bioinformatics database, is available.
Membrane Expression arrays	Incyte Genomics www.incyte.com/ expression/argem1.html	The human array represents 20,000 I.M.A.G.E. cDNA clones of human ESTs. The plant array contains clones representing 7900 <i>Arabidopsis thaliana</i> genes from all major tissue categories (roots, rosettes, and inflorescence).	Arrays carrying proprietary Incyte sequences are available only to Incyte subscribers. The data analysis is done in-house.
Membrane arrays for human and mouse	Super Array Inc. www.superarray.com	Super Array Incorporated provides pathway-specific gene expression membrane arrays.	Custom arrays are also available.
Expression microarrays	Genometrix Inc. www.genometrix.com	Microarrays are available in membrane format or on microscope slides for analyzing cancer-related human gene expression and mouse gene expression. Arrays for risk and toxicity assessments are also available.	A BioScanner for high-density imaging accompanied by GeneView software for image analysis is available.
Genomic microarray	Vysis Inc. www.vysis.com	The array contains >58 different gene targets, reported to be amplified in various human cancers or cancer cell lines, including HER-2/neu, cyclin D1, and Myc. The array contains large fragments (80–150 kb) of genomic DNA spotted onto chromium-coated glass slides.	The Vysis array is currently the only commercial source of a genomic array for assessing gene copy number. The array can be used to detect amplifications of threefold or greater.
discoveryARRAY Gene Display	Display Systems Biotech www.displaysystems.com	The unique human and mouse discoveryARRAY Gene Display slides are made using the company's proprietary restriction fragment differential display (RFDD-PCR) technology, which identifies and isolates nonredundant expressed cDNA sequences. Tissue-specific sequence arrays for eight different human tissues (liver, brain, kidney, heart, prostate, lung, mammary, and spleen) are also available.	Display Systems Biotech allows users to discover and characterize completely novel genes by analyzing differential expression patterns of various biological samples. The clones identified by RFDD-PCR are completely independent of expression level or preexisting cDNA libraries or sequence databases.
Arrays carrying covalently bound oligonucleotides	Operon Technologies www.operon.com	Oligonucleotides, 70 nucleotides in length, are each optimized for sequence specificity and melting temperature. The human collagen array represents 320 genes from eight functional categories: apoptosis, cancer, cell cycle, transcription factors, neuron/axon guidance, heat shock/stress, blood/inflammation, and aging. The apoptosis array contains 374 genes.	Operon also offers "array-ready" DNA products, normalized for concentration and ready to print. Customized 70 mers are also available.
Micromax	NEN Life Sciences www.nen.com/products/ micromax/prod_serv	Two unique arrays are available, one containing a collection of 294 human transcription factors and the other containing a mixture of 196 human kinase and 96 phosphatase genes.	



TABLE A10-3 Choice of an Array System

ARRAY TYPE	ADVANTAGES	DISADVANTAGES
cDNA arrays	<ul style="list-style-type: none"> <li>• Availability of large nonredundant, sequence-validated clone sets from different organisms.</li> <li>• Because prior sequence information is not required, cDNA arrays are an excellent choice for gene discovery.</li> <li>• cDNA size is optimal for specific hybridization.</li> <li>• Technology for spotting DNA on glass and membranes is readily available.</li> </ul>	<ul style="list-style-type: none"> <li>• Processing clones to generate print-ready material is cumbersome.</li> <li>• Density of printed cDNA is lower than for in-situ-synthesized oligonucleotides.</li> <li>• cDNA sequences may contain repetitive sequences such as <i>Alu</i> in human 3' UTRs or B elements in rodent 3' UTRs, resulting in cross-hybridization.</li> <li>• Clone authentication can be a problem.</li> </ul>
Oligonucleotide chips	<ul style="list-style-type: none"> <li>• High-density chips can be fabricated.</li> <li>• In situ synthesis on the chip generates consistent and uniform geometry of spots.</li> <li>• Oligonucleotide arrays may be used for genotyping as well as for gene expression analysis.</li> <li>• Maintaining large collections of cloned DNA molecules is not essential.</li> <li>• Because oligonucleotides are relatively short and can be designed for any gene region, oligonucleotide chips can be used for sequencing, identification of polymorphisms, and potentially for identification of different transcript splice variants.</li> </ul>	<ul style="list-style-type: none"> <li>• There is an absolute sequence data requirement for designing oligonucleotides.</li> <li>• Oligonucleotide selection rules are not well defined.</li> <li>• Short sequences are not the best targets for hybridization and, therefore, appropriate controls must be included.</li> <li>• Oligonucleotide chips are extremely expensive and the current manufacturing process is inherently inflexible.</li> </ul>
Homemade systems	<ul style="list-style-type: none"> <li>• Technology for array fabrication is readily available and well suited to laboratory setting.</li> <li>• Once the infrastructure is established, it is a less expensive way of making arrays.</li> <li>• Unlimited number of arrays can be generated as required (quite useful considering microarray experiments are performed with a large number of arrays).</li> <li>• Most flexible and versatile way to study any available genes. New genes can be added easily.</li> <li>• User has complete control over the research and is less dependent on commercial companies.</li> </ul>	<ul style="list-style-type: none"> <li>• User must learn to design and build chips.</li> <li>• Not the system of choice if only a small number of arrays are needed or a limited number of experiments are performed because capital costs run high. (This cost can be circumvented by establishing core facilities and shared resources.)</li> <li>• Tracking of clones and print material can be cumbersome and error-prone.</li> </ul>
Commercial systems	<ul style="list-style-type: none"> <li>• Uniformity in chip quality.</li> <li>• Burden of production and quality control is on the manufacturers.</li> <li>• User has access to proprietary technologies and private clone resources.</li> <li>• Integrated packages are available for array hybridization and downstream informatics.</li> </ul>	<ul style="list-style-type: none"> <li>• Limited flexibility.</li> <li>• Chip costs are extremely high.</li> <li>• User is totally dependent on outsourced production of chips.</li> </ul>

## IMAGING AND ANALYSIS OF THE ARRAY

### Sample Processing and Hybridization

Once the array has been printed or purchased, the next step is to hybridize a labeled probe to the immobilized DNAs on the array. Typically, the probes for arrays are labeled representations of cellular mRNA pools isolated from various biological resources, such as cell cultures, tissues of model organisms, clinical biopsies, and histological samples. Detailed protocols for preparing the probe samples (including isolation of RNA, synthesis of cDNA, and incorporation of fluorescent dyes) and hybridizing the probe molecules to the immobilized DNA arrays are available on the following Web Sites:

Stanford University	<a href="http://www.cmgm.stanford.edu/pbrown/">www.cmgm.stanford.edu/pbrown/</a>
Albert Einstein College of Medicine	<a href="http://www.sequence.aecom.yu.edu/bioinf/microarray/protocol.html">www.sequence.aecom.yu.edu/bioinf/microarray/protocol.html</a>
NHGRI	<a href="http://www.nhgri.nih.gov/DIR/LCG/15K/HTML/protocol.html">www.nhgri.nih.gov/DIR/LCG/15K/HTML/protocol.html</a>
Cold Spring Harbor Laboratory	<a href="http://www.nucleus.cshl.org/wigler/">www.nucleus.cshl.org/wigler/</a>
Collection of protocols	<a href="http://www.protocol-online.net/molbio/DNA/dna_microarray.htm">www.protocol-online.net/molbio/DNA/dna_microarray.htm</a>
TIGR protocols	<a href="http://www.tigr.org/tdb/microarray">www.tigr.org/tdb/microarray</a>

## Detection of the Hybridization Signal

After hybridization, the DNA microarray is scanned to monitor the fluorescence of each probe that was successfully hybridized to the target. Most microarrays utilize two fluorophores, typically, the most commonly used fluorophores are Cy3 (green channel excitation) and Cy5 (red channel excitation). To generate a complete microarray image, it is necessary to acquire an image for each of these fluorophores. In general, two different scanning approaches are used: (1) sequential scanning acquires one image at a time and then builds the ratio image after acquisition is completed, and (2) simultaneous scanning acquires both images at the same time. Although a range of scanners is available, it is difficult to judge their relative performances at this time. A listing of scanners and their notable features is presented in Table A10-4.

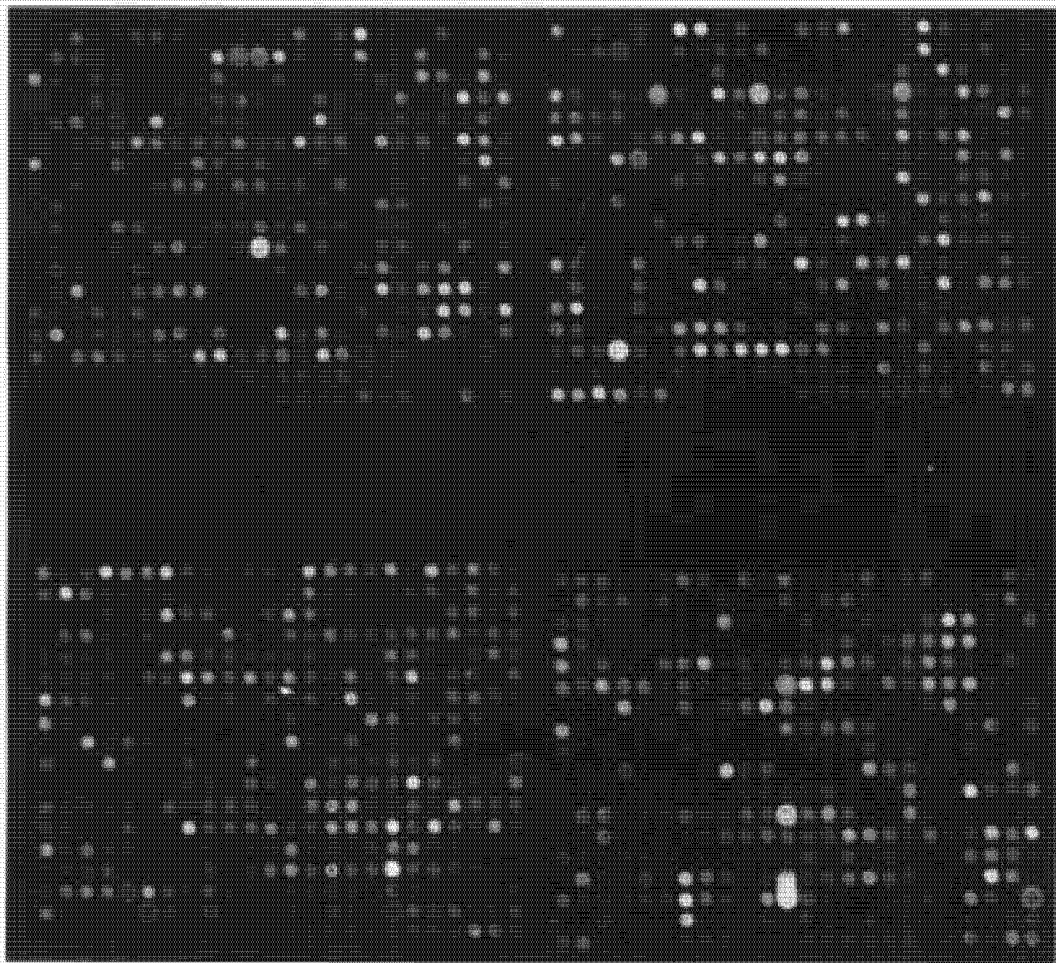
**TABLE A10-4 Scanning Systems**

SCANNING SYSTEM	SOURCE	DESCRIPTION
GenePix 4000	Axon Instruments, Inc. <a href="http://www.axon.com">www.axon.com</a>	This highly compact scanner has 10- $\mu$ m resolution and simultaneous dual wave length scanning. Its main strengths are a very short scan time and perfect pixel-to-pixel registration of the images in both channels. (Keeping the pixels in register between channels is a problem often associated with dual-wavelength scanners.) It also includes elaborate image analysis software. The Axon scanner is currently limited to using only two fluorophores.
ScanArray 5000	General Scanning, Inc. <a href="http://www.gsilmomics.com/products_frame/datashts/scanarray/sa5000.htm">www.gsilmomics.com/products_frame/datashts/scanarray/sa5000.htm</a>	This microarray scanner utilizes a confocal laser with a resolution of 10 $\mu$ m and includes advanced software for image acquisition, image analysis, and data mining. The distinguishing feature is the use of 4 different excitation lasers and 10 emission filters, providing users with the flexibility of many different fluorescent dyes (emission spectra between 500 and 700 nm) for sample labeling. This setup permits more than two differently labeled samples to be used for probing each microarray.
GeneTAC 1000	Genomic Solutions <a href="http://www.genomicsolutions.com/products/bio/img.htm">www.genomicsolutions.com/products/bio/img.htm</a>	GeneTAC 1000 uses a CCD camera and a highly sensitive detector capable of detecting up to four fluorophores per experiment. It also has an automated sample holder, with provisions for loading and scanning 24 slides at one time.
HP GeneArray Scanner	Hewlett-Packard <a href="http://www.affymetrix.com/products/ins_array.html">www.affymetrix.com/products/ins_array.html</a>	The HP GeneArray Scanner is a high-resolution (3- $\mu$ m) scanner designed to read Affymetrix GeneChip probe arrays.
The Storm system	Molecular Dynamics <a href="http://www.mdyn.com/arrays/gen.htm">www.mdyn.com/arrays/gen.htm</a>	This system combines phosphorimager autoradiography technology with two nonradioactive fluorescent-labeling techniques: direct fluorescence and chemifluorescence. The Storm system scans storage phosphor screens plus fluorescent gels and chemifluorescent blots in a 35 $\times$ 43-cm scanning area and is thus well-suited for scanning membrane arrays.
GMS 418 Array Scanner	Genetic Microsystems <a href="http://www.affymetrix.com">www.affymetrix.com</a>	This system is a scanning laser confocal imaging epifluorescence microscope with a 10- $\mu$ m resolution.

## Image Analysis

The objective of microarray image analysis is to extract hybridization signals from each probe. Signals are measured as absolute intensities for a given target (essentially for arrays hybridized to a single sample) or as ratios of two probes with different fluorescent labels, representing two separate treatments to be compared with one probe as an internal control. The ratio of two signals provides relative response ratios rather than an estimate of an absolute signal. A typical color image is shown in Figure A10-2.

Once images are obtained in digitized form, they are subjected to further analyses using a variety of software programs. These programs provide a more accurate quantification of the intensity ratio. Undesired features of the data such as uneven spots, dust on the slides, and non-specific hybridizations are flagged as inadequate and are not considered for further analysis. Background fluorescence, such as autofluorescence of the solid support or nonspecific binding of sample to the array, can also be subtracted from the intensity of a feature. Subsequently, the mean,



**FIGURE A10-2 Expression Patterns in a Human cDNA Array (from cells induced with the human tumor suppressor PTEN, protein tyrosine phosphatase, and tensin homolog)**

A portion of a human cDNA array hybridized with a red fluor-tagged experimental probe and a green fluor-tagged reference (uninduced) probe. The measured intensities from the two fluorescent reporters have been false-colored red and green and overlaid. Yellow signals (red plus green) indicate roughly equal amounts of bound cDNA from each sample and therefore have equal intensities in the red and green channels. Spots containing mRNA present at a higher level in one or the other sample show up as predominantly red or green. (Image provided by Vivek Mittal and Michael Wigler, Cold Spring Harbor Laboratory.)

median, and standard deviation of pixel intensities in each feature is determined and subjected to further detailed analysis. The following image analysis programs are commonly used:

- **GenePix Pro** is a program for scanning and analyzing microarray slides using the GenePix 4000 Scanner. It can also be used to analyze images acquired with other scanners. GenePix Pro automatically aligns the blocks of feature indicators on an image and aligns feature indicators within the blocks with features on the image. It is fully integrated with the Web in such a way that the gene names or their accession numbers can be linked to any database. It can be purchased directly from Axon ([www.axon.com](http://www.axon.com)).
- **ScanAlyze**, a program similar to GenePix Pro, was developed by Michael Eisen at Stanford University and is freely available from <http://rana.stanford.edu/software/>.

Other image analysis programs include ArrayVision (from Imaging Research Inc.: <http://imaging.brocku.ca/products/>); deArray (from NHGRI: [www.nhgri.nih.gov/DIR/LCG/15K/HTML/](http://www.nhgri.nih.gov/DIR/LCG/15K/HTML/)); ImaGene (from BioDiscovery: <http://www.biodiscovery.com/products/ImaGene/imagene.html>); TIGR Spotfinder (from TIGR: [www.tigr.org/softlab/](http://www.tigr.org/softlab/)); MicroArray Suite (from Scanalytics: [www.scanalytics.com/sos/product/hts/microarray.html](http://www.scanalytics.com/sos/product/hts/microarray.html)); GenExplore (from Applied Maths: [www.applied-maths.com/ge/ge.htm](http://www.applied-maths.com/ge/ge.htm)); GeneData AG (from Basel: [www.genedata.com/prod-exp.html](http://www.genedata.com/prod-exp.html)); Partek Pro 2000 (from Partek Inc.: [www.partek.com/](http://www.partek.com/)); and Spotfire.net (from Spotfire: [www.spotfire.com](http://www.spotfire.com)).

### Some Considerations in Performing a Microarray Experiment

Because microarray experiments are miniaturized and of a high-throughput nature, they are sensitive to both external and internal fluctuations, for example, during delivery of the target DNAs onto the substrate and during hybridization. Approximately 7–8% of the variation in the data is estimated to be due to background noise. It is therefore imperative to follow proper averaging and normalization procedures, both to minimize these variables and to ensure that the extracted data are reliable and meaningful. It is also important to note that, as of this writing, there are no globally accepted rules or standards for performing controlled microarray experiments. Furthermore, the platforms as well as the methods for data extraction and analysis are subject to great variability. The following are general recommendations for performing experiments on homemade arrays and should be used as guidelines only.

- **Replicate each experiment on multiple arrays.** Averaging the normalized ratios for the same controls to compensate for array-to-array variation.
- **Perform experiments using color reversal to account for variations in dye incorporation.** The purpose of reversing the label for the two replicates is to reduce variability in signals that can occur due to differential incorporation of fluorescent labels by reverse transcriptase or other associated technical variability. False positive results can be substantially reduced using this strategy.
- **Randomize the address of arrayed DNAs on the surface of the substrate** to control for variation in hybridization that may occur at different locations on the array.
- **Include a large number of controls on every array** to verify the success of the probe synthesis, labeling, and hybridization. Some recommended controls include:

**Doping/spiking RNA controls**, where mRNAs synthesized from cDNA clones by in vitro transcription are added to each labeling reaction. Ideally, these mRNAs are derived from genes that are not homologous to the organism under study (e.g., nonhomologous plant mRNAs are used on the human expression array). The cognate genes for these mRNAs

are represented on the array. These controls are useful for determining variations in differential labeling of samples, for assaying the stringency of the hybridization, and for calibrating the ratios for comparisons among experiments.

**Intensity series clones**, where clones from the organism under study that represent high, medium, and low expression are represented on the array. These are useful for estimating sensitivity of detection and measuring relative saturation and scanning effects.

**Blocking controls**. Most array hybridization experiments require the addition of cold DNA (e.g., human  $C_{\alpha}t1$  DNA and polyadenylic acid for human cDNA expression arrays) to block nonspecific annealing including hybridization due to repetitive elements. Inclusion of human  $C_{\alpha}t1$  DNA or oligo(dA) spots on human expression arrays should have little or no hybridization signal if repetitive elements have been successfully blocked.

**Background hybridization controls**. It is often useful to include blank salt spots and spots of DNA from another organism whose mRNA is not represented in the sample. These controls give an estimate of the nonspecific component of the hybridization and are useful for subtracting background from feature values.

**Contamination controls**. DNA samples that are used multiple times for printing arrays may become contaminated with bacteria or yeast. Total genomic DNA or cDNA clones of common contaminants such as *E. coli* and yeast are represented in the array to monitor for spurious hybridizations.

**cDNA synthesis and RNA label quality control**. Hybridization intensity is often dictated by the size of the labeled sample. This variable can be monitored with appropriate quality control elements. For example, DNA fragments, encompassing 100–200 bp tiled across an entire gene, can be spotted on arrays. Labeled cDNA probes of high integrity will hybridize efficiently to all spots, whereas cDNAs of lesser quality will generate proportionately weaker signals with fragments that map to the 5' end of the gene.

- **Control of geometric artifacts**. The use of standard floating coverslips for DNA array hybridization sometimes results in uneven distribution of the probe DNA on the array, which compromises the hybridization. This situation occurs because the hybridization volume under a coverslip is small, which results in inefficient mixing of the hybridization fluid and generation of localized temperature gradients. The compromise is manifest by geometrical distortions in the image due to variations in hybridization at different locations within the array. One way to circumvent this variable is to use custom-made raised-edge coverslips (also referred to as “lifters”; available from [www.eriesci.com/](http://www.eriesci.com/)). These coverslips provide separation and ensure even dispersal of hybridization solution between the array and the coverslip. Another solution is to use larger hybridization volumes within specially designed hybridization chambers. These ensure efficient mixing of the hybridization fluid, which brings more probe molecules into contact with the cognate target in the array, thus increasing the number of productive events. Hybridization chambers are available from Schleicher & Schuell ([www.s-and-s.de/](http://www.s-and-s.de/)) and CLONTECH ([www.clontech.com](http://www.clontech.com)).

## MICROARRAY DATA MINING, ANALYSIS, AND MANAGEMENT

---

Because microarray analysis is a high-throughput technology, the amount of data being generated is expanding at a tremendous rate. The handling and analyses of these data therefore require elaborate databases, query tools, and data-visualization software. A brief description of some of these databases and analysis software follows:

- **Another MicroArray Database.** AMAD is a flat file, Web-driven database system written entirely in PERL and javascript, and intended for use with microarray data. AMAD supports both ScanAlyze and GenePix image analysis software. Further multivariate statistical analyses are performed on the values obtained from the data analysis program by using Mike Eisen's Cluster analysis and TreeView; both are freely available from [www.rana.Stanford.edu/software/](http://www.rana.Stanford.edu/software/). AMAD, developed by a group of experienced scientists originally from Stanford University, is the only free database (available from [www.microarrays.org](http://www.microarrays.org)) and provides a reliable analysis and data storage tool for investigators with little or no experience in handling enormous amounts of microarray data.
- **Resolver (Rosetta Inpharmatics).** Resolver is a comprehensive storage, visualization, and analysis tool for high-volume gene expression data obtained using cDNA microarrays, oligonucleotide arrays, and other technologies. It is interlaced with a powerful discovery tool for pathway interrogation, functional gene assignment, and compound analysis. Multi-experiment analyses are possible through correlation plots, cluster trees, and BLAST-like searches that can be conducted within the database. This feature enables the user to perform ranked similarity searches across entire data sets containing tens of thousands of gene expression profiles. More information about Resolver is available at [www.rii.com/prodserv/resolver/index.htm](http://www.rii.com/prodserv/resolver/index.htm).
- **GeneSpring (Silicon Genetics)** is a powerful analysis and visualization software suite available for genomic expression experiments. It is capable of handling and analyzing enormous data sets from any organism. Clustering, pathway determination, regulatory sequence detection, Eigenmode analysis, and a variety of data visualization tools are principal features of GeneSpring. A copy of a free demonstration version and software for purchase are available at [www.sigenetics.com](http://www.sigenetics.com).
- **IPLab MicroArray Suite for Macintosh (Scanalytics)** is image analysis software capable of performing basic routines for extracting and visualizing microarray data generated from virtually any scanning device. Originally developed by researchers at the National Institute for Human Genome Research (NHGRI), this software is now a completely supported product available from Scanalytics Inc. ([www.scanalytics.com/sos/product/hts/microarray.html](http://www.scanalytics.com/sos/product/hts/microarray.html)).

A DNA microarray database can be linked to a reference database, for example, the UniGene database, to allow access to information about particular genes. Each UniGene entry corresponds to a single human or rodent gene and provides a direct link to GenBank gene and EST entries, to SWISS-PROT entries, and to literature entries through PubMed. Several groups have begun to assemble comprehensively curated gene databases for mammals. Such databases will facilitate rapid retrieval of information concerning functional and biochemical pathways. Some of the databases under development are:

Kyoto Encyclopedia of Genes and Genomes (KEGG)	<a href="http://www.genome.ad.jp/kegg/">http://www.genome.ad.jp/kegg/</a>
Locus Link	<a href="http://www.ncbi.nlm.nih.gov/LocusLink/">www.ncbi.nlm.nih.gov/LocusLink/</a>
WIT	<a href="http://wit.mcs.anl.gov/WIT2/">wit.mcs.anl.gov/WIT2/</a>
SPAD Signaling pathway Database	<a href="http://www.grt.kyushu-u.ac.jp/spad/">www.grt.kyushu-u.ac.jp/spad/</a>
Genecards	<a href="http://bioinformatics.weizmann.ac.il/cards/">http://bioinformatics.weizmann.ac.il/cards/</a>
BRITE	<a href="http://www.genome.ad.jp/brite_old/">www.genome.ad.jp/brite_old/</a>
EGAD	<a href="http://www.tigr.org/docs/tigr-scripts/egad_scripts/role_report.spl">www.tigr.org/docs/tigr-scripts/egad_scripts/role_report.spl</a>
Stanford genome resources	<a href="http://genome-www4.stanford.edu/cgi-bin/SMD/source/sourceSearch">http://genome-www4.stanford.edu/cgi-bin/SMD/source/sourceSearch</a>
Database of transcribed sequences	<a href="http://www.cbil.upenn.edu/DOTS">www.cbil.upenn.edu/DOTS</a>
South African National Bioinformatics STACK database	<a href="http://www.sanbi.ac.za/Dbases.html">www.sanbi.ac.za/Dbases.html</a>
TIGR Gene Indices	<a href="http://www.tigr.org/tdb/tgi.shtml">www.tigr.org/tdb/tgi.shtml</a>

The large-scale data sets normally obtained from related microarray experiments are subjected to pattern recognition analysis to identify groups of genes that are regulated in a similar manner across many experiments. Pattern recognition is performed using a variety of multivariate analytical algorithms, such as hierarchical clustering, k-means clustering, and self-organizing maps. Typically, the interpreted array analysis highlights a relatively smaller number of spots representing differentially expressed mRNAs whose cognate genes are further validated by resequencing and whose patterns of expression are confirmed by other more reliable but low-throughput methods such as northern blotting, nuclease protection, or RT-PCR (for details of these protocols, please see Chapter 7, Protocols 8 and 10, and Chapter 8, Protocol 8).

As large-scale gene expression data accumulate over time, public access to these data becomes an important issue. In its current format, the data are widely dispersed and lack uniform structure and retrieval modalities. Efforts to establish some type of standardized data format for storing and communicating microarray-based gene expression data are in progress, largely due to efforts of the European Bioinformatics Institute ([www.ebi.ac.uk/microarray/MGED/](http://www.ebi.ac.uk/microarray/MGED/)). The main objectives of this effort are (1) to ensure reproducibility and verifiability of results, (2) to identify controlled vocabularies for annotating the samples and experiments, and (3) to define the data communication standards. The development of standards for cross-platform data comparison and normalization is also under way.

## EMERGING TECHNOLOGIES

---

The field of microarray technology presents a tremendous technical challenge for both academic institutions and industry. Commercial companies are vying with one another to establish market dominance. Novel platforms are being developed that promise higher throughput and better reproducibility; but which technology will emerge as the system of choice remains to be determined. This discussion surveys some of the emerging technologies that are likely to have a significant impact on the future of microarray research.

### Novel Microarray Fabrication Methods

- **Piezoelectric Printing** uses technology analogous to that employed in ink-jet printers. The sample is loaded into a miniature nozzle equipped with a piezoelectric element around the nozzle. An electric current is applied to the piezoelectric element, which causes the nozzle to expel a precise amount of liquid from the jet onto the substrate. After the first step, the jet is washed and the second sample is loaded and deposited to an adjacent address. This method allows high-density gridding of virtually any molecule of interest, including DNA, antibodies, and small molecules, onto the substrate of choice. Arrays can be produced on nonporous (glass), porous (filters), and three-dimensional (Hydro-gel) substrates. The piezoelectric technology is not currently as robust as photolithography or microspotting. The BioChip Arrayer from Packard Instrument Co. uses piezoelectric "drop-on-demand" tips to provide noncontact dispensing ([www.packardinst.com](http://www.packardinst.com)).
- **Bubble Jet Technology** uses the ink-ejecting mechanism used in printing devices. A Bubble Jet ink-jet device is used to eject 5'-terminal-thiolated oligonucleotides onto glass surfaces. The printing head (which is similar to conventional piezoelectric devices) consists of a heater that generates a bubble of fluid in a nozzle. The bubble pressure then ejects a microdroplet of material from the aperture.

Alternate approaches for fabrication of high-density in-situ-synthesized oligonucleotide arrays are under way. The Digital Optical Chemistry (DOC) system developed by Skip Garner and colleagues at the University of Texas Southwestern Medical Center ([www.pompous.swmed.edu/](http://www.pompous.swmed.edu/)) consists of three parts: a Digital Micromirror Device that selectively focuses ultraviolet light onto a glass substrate where chemistry is done, a fluidics system that delivers the chemical reagents in the proper sequence, and a computer program that controls both the Digital Micromirror Device and fluidics system according to the desired sequence pattern. This system alleviates the need for expensive photolithographic masks (using instead a "virtual" digital mask) and generates unique chips very rapidly. Another benefit of using DOC is that the machine is a benchtop unit that can be manufactured for use in any laboratory. In a similar technological direction, Xiaolian Gao at the University of Houston ([www.zeiram.chem.uh.edu/gao/](http://www.zeiram.chem.uh.edu/gao/)) uses a digital photolithographic system and new oligonucleotide deprotection chemistry using photogenerated acids and newly developed synthesis microreactors. These technological improvements should in the future permit chips of any design to be made in regular research laboratories at an affordable cost and with improved quality.

## Resequencing

Also known as sequencing by hybridization (SBH), resequencing uses a set of oligonucleotides comprising all possible combinations of sequences in a given length that are synthesized and immobilized on a chip. The DNA fragment to be sequenced is broken down into smaller pieces, fluorescently labeled, and hybridized to the chip. The sequence of the DNA emerges from the pattern of fluorescence bound to the nested sequence. Since the chip contains all possible sequences, this system has the distinct advantage of being able to sequence DNA from any source. Fragments containing nonrandom sequences such as direct and inverted repeats presently limit this technique. The technology is being developed by Hyseq Inc., in collaboration with PE Corporation ([www.hyseq.com](http://www.hyseq.com)).

## Specific, High-throughput Genotyping by Primer Extension on Microarrays

A system to genotype SNPs and point mutations by a DNA-polymerase-assisted primer extension reaction using a microarray format is being developed by Ann-Christine Syvanen at Uppsala University in Sweden. Miniaturized reaction chambers formed on microscope slides allow analysis of 80 individual samples for hundreds of SNPs, potentially allowing the generation of >20,000 genotypes per slide. Minisequencing single-base extensions from one primer per SNP with dideoxynucleotides labeled with four fluorophores, or alternatively, extension of two allele-specific primers per SNP with one fluorescent deoxynucleotide, may be used. The genotypes of the samples at each SNP are determined by measuring the slides in a fluorescence array scanner.

## Direct Identical-by-descent Mapping Using DNA Arrays

This mapping method is being developed in both the Brown ([www.cmgm.stanford.edu/pbrown/](http://www.cmgm.stanford.edu/pbrown/)) and the Cheung ([www.w95vcl.neuro.chop.edu/vcheung/](http://www.w95vcl.neuro.chop.edu/vcheung/)) laboratories and facilitates the isolation and physical mapping of DNA fragments shared identical-by-descent (IBD) between individuals. IBD mapping is a combination of two techniques: genomic mismatch scanning (GMS), a method for genetic linkage mapping, and DNA microarray technology. In this method, specialized enzymes are used to isolate DNA fragments shared IBD between two individuals. The isolated DNA fragments are mapped at high resolution by hybridization to a DNA array representing physically ordered genomic segments. Compared to traditional genotyping methods, direct IBD



mapping allows the entire genome to be analyzed in one step without laborious locus-by-locus genotyping. Microarray-based genetic linkage mapping will be useful in mapping genes that underlie complex genetic traits in yeast and in the distribution of meiotic recombination events across the entire genome. Parallel work is directed at adapting the GMS methodology to the human genome. In a demonstration of the feasibility of this technique, a gene for congenital hyperinsulinemia has been mapped by the Cheung lab.

### **Protein Microarrays**

As a complementary approach to gene expression profiling on cDNA microarrays, microarrays of specific antibodies are being developed to measure the abundance of thousands of different proteins in samples from cells, or in biological fluids, such as serum or urine. Preactivated surfaces are used for the covalent immobilization of antibodies. Proteins from experimental and reference samples are differentially labeled with fluorescent dyes and hybridized to the array. Evaluation of the various applications of protein microarrays in detecting and diagnosing disease is under way. Because this application would not be restricted to antigen-antibody systems, protein microarrays should provide a general resource for high-throughput screens of gene expression, receptor-ligand interactions, and protein-protein interactions. Information on the development of protein arrays is available at [www.molgen.mpg.de/~proteingroup/LuekingetalPub.html](http://www.molgen.mpg.de/~proteingroup/LuekingetalPub.html).

### **Tissue Microarrays**

This array-based high-throughput technique facilitates gene expression and copy-number surveys of very large numbers of tissue specimens. For example, as many as 1000 cylindrical tissue biopsies from individual tumors can be distributed in a single tumor tissue microarray. Sections of the microarray provide targets for parallel in situ detection of DNA, RNA, and protein targets in each specimen on the array, and consecutive sections allow the rapid analysis of hundreds of molecular markers in the same set of specimens. Tissue microarrays were developed in the Olli-P. Kallioniemi laboratory at the National Human Genome Research Institute ([www.nhgri.nih.gov/DIR/CGB/TMA/about.html](http://www.nhgri.nih.gov/DIR/CGB/TMA/about.html)). A machine to make tissue microarrays is available from Beecher Instruments ([www.beecherinstruments.com](http://www.beecherinstruments.com)).

### **Use of Arrays to Detect DNA-Protein Interactions**

The potential of DNA microarrays for high-throughput screening of DNA-protein interactions is being exploited in several laboratories. One of the major interests is the detection of transcription-factor-binding sites in the genome under different physiological conditions. The general approach uses construction of an array containing both the intergenic and the coding region of the genome. Next, the total DNA and protein content of a cell is cross-linked in vivo, and a chromatin immunoprecipitation (ChIP) experiment using antibody specific to a transcription factor is performed. The DNA component of the immunoprecipitate (DNA-protein-antibody complex) is labeled with fluorescent dyes by PCR and hybridized to the array. A positive spot on the array is likely to be the target of the protein. This approach is feasible for organisms whose complete genomic sequence is known. Methods to analyze genome-wide protein-DNA interactions in yeast are being developed by Iyer and Brown at Stanford University.

Using a more general approach, the Church laboratory (<http://arep.med.harvard.edu/gmc/>) has generated arrays of single-stranded DNA oligonucleotides (all possible sequence combinations) carrying a constant sequence region at one end. The single-stranded arrays are converted to a double-stranded array by annealing and enzymatically extending a complementary primer.

Arrays containing all possible permutations of a site at each position will facilitate exploration of the spectrum of sequence-specific protein-binding sites in genomes.

### Barcode Chip

In an effort to assign a function to every gene in the yeast genome, a novel high-throughput method is under development at Stanford University. The project is described on the Web Site [http://sequence-www.stanford.edu/group/yeast\\_deletion\\_project/deletions3.html](http://sequence-www.stanford.edu/group/yeast_deletion_project/deletions3.html).

A library of yeast strains, harboring a deletion in each gene, is generated. Each of the deletions is tagged with a unique 20-mer DNA sequence that acts as a molecular barcode for individual deletions. The mixture of all such tag strains then allows for the analysis of the entire genome with the manipulation of a single sample. During growth under a variety of conditions, the loss of a tag indicates the loss of a corresponding deletion from the population. The concentration of each tag is determined by PCR amplification of the mixture and hybridization to a chip that contains tag complements at defined positions. Thus, phenotypes of individual strains can be analyzed in parallel. This approach has prospects for use in other organisms as well.

### Bioelectronic Chips

A number of companies are focusing on creating microchips using microelectronics. Nanogen-chips ([www.nanogen.com/](http://www.nanogen.com/)) contain probes that can be electrically activated individually. A sample is applied to the chip, and the spot is electrically activated, which allows the sample to be concentrated and bound efficiently. The chip is then washed and another sample applied. Thus, multiplex hybridizations can be performed to the same chip. This technology has potential applications in a number of other analyses, including antigen-antibody, enzyme-substrate, cell-receptor, and cell separation techniques.

Orchid Biocomputer (Princeton, NJ; [www.orchid.com](http://www.orchid.com)) is designing a microfluidics chip that has precise control over the flow of process chemicals and temperature integration. This chip is used for screening SNPs. Both of these technologies have implications in drug screening and clinical diagnostics.

### SUMMARY

---

From providing detailed profiles of the differential expression of literally thousands of genes to exploiting protein microarrays to build a resource of protein interactions, the applications of array technology are likely to produce an explosion of information on many biological fronts. The final challenge, beyond the emerging technological developments, may well lie in developing effective means for storing, sharing, and analyzing the information.



# Appendix 11

---

## Bioinformatics

David Mount, *University of Arizona, Tucson*

Judy Cuddihy, *Cold Spring Harbor Laboratory*

TABLE A11-1: BIOINFORMATICS SOFTWARE	A11.3
TABLE A11-2: DATABASE SIMILARITY SEARCH SOFTWARE	A11.18
TABLE 11-3: BIOINFORMATICS DATABASES	A11.22

The following tables present widely used software for analyzing DNA, RNA, and protein sequences, as well as databases and types of searches that can be performed for DNA, RNA, and protein structure and function. The organization for Table A11-1 is outlined below:

- DNA
  - Sequence Submission
  - Sequence Alignments (Pairwise and Multiple)
  - Scoring Matrices
  - Motifs and Patterns
  - Genes, Exons, and Introns
  - Promoters, Transcription-factor-binding Sites
  - Other Regulatory Sites
- RNA
  - Secondary Structure
  - RNA-specifying Genes, Motifs
- Protein
  - Sequence Alignment
  - Motifs, Patterns, and Profiles

Because of the ever-changing nature of software and World Wide Web sites, it is worth the effort to consult the relevant Web or FTP sites for more information and the latest versions of software and databases. In most instances, a license is needed if the programs or databases are used for commercial purposes; see each site for further information. Commercial programs have not been included in this survey. For more information on these options, refer to the Web Sites of the relevant companies.

In addition to the specific sites for software and databases, there are several "gateway" Web pages that offer access to many of the sites listed in the tables, as well as to additional sites. The following Web pages offer a good starting place for many searches:

**National Center for Biotechnology Information (NCBI)**

Web Site: <http://www.ncbi.nlm.nih.gov>

This site offers a wide range of databases and searches via Web-based interactive forms, including GenBank, PubMed, BLAST, genome biology resources and databases, cancer resources and databases, and many other resources. These resources are integrated by Entrez, a search and retrieval system that also includes cross-referenced information. Submission to the GenBank database can be made here.

**Baylor College of Medicine Search Launcher**

Web Site: <http://www.hgsc.bcm.tmc.edu/SearchLauncher>

Web-based interactive forms and links are provided for many types of searches, including nucleic acid, protein sequence and pattern, species-specific protein, sequence alignments, gene features, and protein secondary structure, as well as for many sequence utilities.

**The Sanger Centre**

Web Site: <http://www.sanger.ac.uk>

Web-based interactive forms and links are provided to a wide range of databases and software utilities, including the many genome sequencing projects.

**EBI-European Bioinformatics Institute, EMBL Outstation**

Web Site: <http://www.ebi.ac.uk>

Web-based interactive forms and links to databases and software utilities are given. Submissions to EMBL Data Libraries can be made here.

**ExPASy Molecular Biology Server-Expert Protein Analysis System, Swiss Institute of Bioinformatics**

Web Site: <http://www.expasy.ch>

This protein-specific site provides a wide range of links to database and software utility resources for analysis of protein structure and function.

For more extensive information on the mathematical and statistical underpinnings of bioinformatics software, as well as methods for database searching and analysis of DNA, RNA, and protein sequence, please see Mount (2001).

**TABLE A11-1 Bioinformatics Software**

PROGRAM NAME	WEB SITE/FTP SITE	DESCRIPTION/PLATFORMS	INPUT FORMAT	INTERPRETATION/RESULTS
<i>Sequence Submission</i>				
BankIt	<a href="http://www.ncbi.nlm.nih.gov/BankIt">http://www.ncbi.nlm.nih.gov/BankIt</a>	Web-based sequence submission tool for direct submission to GenBank; submitted sequence must be DNA/RNA sequence that has been sequenced by the submitter. This tool is for one or a few submissions with uncomplicated sequence annotation.	FASTA	Returned by e-mail are: preliminary GenBank flat file; GenBank accession number; completed GenBank flatfile.
Sequin (formerly called Authorin)	<a href="http://www.ncbi.nlm.nih.gov/Sequin/index.html">http://www.ncbi.nlm.nih.gov/Sequin/index.html</a> <i>FTP: www.ncbi.nlm.nih.gov/sequin</i>	Submission and update of sequence submission to GenBank, EMBL, and DDJB. Handles simple and complex submissions; automatically performs functions that need to be done manually in other submission programs. Has powerful sequence annotation tools, built-in validation functions; graphical and sequence views. Runs on UNIX and PC; has NetworkAware mode to exchange information with NCBI.	FASTA for sequence files; also PHYLIP, NEXUS, MACAW, FASTAGAP for population, phylogenetic, and mutation studies.	GenBank flat file; GenBank accession number.
Webin	<a href="http://www.ebi.ac.uk/Tools/index.html">http://www.ebi.ac.uk/Tools/index.html</a>	Web-based interface preferred for EMBL sequence submission. Data can be modified and viewed before submission; has bulk submission procedure for 25 or more related sequences; also EBI vector screening software.	EMBL Data Libraries accession number.	Local alignment.

*Sequence Alignments (methods for aligning two sequences at a time; for database searches that give pairwise alignments, see Table A11-2)*

BLAST (Basic Alignment Search Tool) (Altschul et al. 1990; Karlin and Altschul 1990, 1993; Tatusova and Madden 1999)	<a href="http://www.ncbi.nlm.nih.gov/gorf/bl2.html">http://www.ncbi.nlm.nih.gov/gorf/bl2.html</a>	The BLAST algorithm is primarily used for similarity searches in sequence databases, but it may also be used for aligning a pair of sequences. The BLAST Web Site also provides a page for aligning two sequences by first searching for conserved words and using these to seed an alignment.	FASTA or Accession/Genbank index number (web site)	Local alignment of sequences based on word "seeds" and graphical representation of alignment.
FASTA programs				
FASTA (Pearson and Lipman 1988)	<a href="http://fasta.bioch.virginia.edu">http://fasta.bioch.virginia.edu</a> <i>FTP: ftp.virginia.edu, dir /pub/fasta</i>	FASTA is used primarily for similarity searches in sequence databases, but it may also be used for aligning a pair of DNA sequences or a pair of protein sequences. Web-based interactive form or downloadable software. Permission needed for commercial use. FASTA may be established on a variety of computer platforms, including Macintosh and PC. Windows, but without a graphical interface.	FASTA or Accession/Genbank index number (web site)	Single, local (Smith-Waterman) alignment between two sequences.

(Continued on following pages.)

TABLE A11-1 (Continued)

PROGRAM NAME	WEB SITE/FTP SITE	DESCRIPTION/PLATFORMS	INPUT FORMAT	INTERPRETATION/RESULTS
LFASTA	<a href="http://fasta.bioch.virginia.edu">http://fasta.bioch.virginia.edu</a>	Compares two protein or DNA sequences for local similarity; uses the FASTA word search method to locate regions of similarity and then performs and scores a local (Smith Waterman) alignment. BLOSUM50 scoring matrix used by default but other matrices can also be specified; gap penalties can also be designated. Use LALIGN or SIM instead.	FASTA	Local sequence alignment.
FASTX/FASTY	<a href="http://fasta.bioch.virginia.edu">http://fasta.bioch.virginia.edu</a>	Compares translated DNA sequence to protein sequence database.	FASTA	Translates DNA sequence in 3 forward and 3 reverse frames; allows frameshifts.
LALIGN, LALIGN0, PLALIGN (see Huang et al. 1990; Huang and Miller 1991)	<a href="http://fasta.bioch.virginia.edu">http://fasta.bioch.virginia.edu</a>	Compares 2 DNA or 2 protein sequences to identify regions of sequence similarity; default scoring matrix is BLOSUM50 but others can be specified; optional gap penalties; uses sim algorithm to provide a local (Smith-Waterman) alignment; provides <i>n</i> different alignments with the same two residues never aligned more than once using the SIM method; can identify internal repeats. LALIGN scores penalties for gaps at the ends of the alignment; LALIGN0 does not penalize end gaps. PLALIGN produces a graphical plot of the alignment much like a dot matrix.	FASTA	Reports several sequence alignments if there are similar regions as well as similarity scores. Web site reports significance of alignment score based on PRSS analysis (see next entry).
PRSS (see Huang et al. 1990; Huang and Miller 1991)	<a href="http://fasta.bioch.virginia.edu">http://fasta.bioch.virginia.edu</a>	Evaluates the significance of pairwise similarity scores of 2 DNA or 2 protein sequences; uses BLOSUM50 matrix and standard gap penalties as default for proteins, but others may be used; second sequence is scrambled (at level of individual characters or of words) many times and each scrambled sequence is aligned with first sequence to give a range of unrelated sequence scores. From these scores, an Expect value for the original alignment score is calculated, i.e., the number of alignments between unrelated sequences that can achieve such a score.	FASTA	Reports similarity scores for 2 sequences; the second sequence is then shuffled a specified number of times compared with the first sequence.
Bayes Block Aligner (primarily used for sequence alignments but also has been used for similarity searching in sequence databases) (Zhu et al. 1997, 1998)	<a href="http://www.wadsworth.org/resnres/bioinfo">www.wadsworth.org/resnres/bioinfo</a>	Finds all possible blocks (short ungapped alignments between a pair of sequences up to a specified number of blocks), then generates all possible alignments of the sequences that includes compatible sets of these blocks. There is no gap penalty; unmatched sequence regions between blocks are neither aligned nor scored. Scores alignments with a series of log odds scoring matrices to provide an odds score for	FASTA	Most probable sequence alignments according to different sampling criteria; probability that a given pair of residues is aligned; probability of each scoring matrix and each choice for number of blocks, and Bayesian probability that sequences are related.

SIM (Huang et al. 1990; Huang and Miller 1991)	<a href="http://www.expasy.ch/tools/sim-prot.html">http://www.expasy.ch/tools/sim-prot.html</a>	each alignment and matrix combination. The sum of all of these scores is calculated and the contribution of each alignment, block number, and scoring matrix to this sum is used to calculate posterior probabilities for the alignment, scoring matrix, etc., using conditional probability calculations (Bayesian statistics). Sequence characters aligned most often regardless of other variables may be determined. Download and compile software for Sun Solaris or SGI Irix or as C source code. PC Windows version also available with no graphic interface. Licensing agreement needed.	FASTA	Reports <i>or</i> local alignments in order of similarity score.
--	---	--	-------	--

**Scoring Matrices**

BLOSUM scoring matrices (see also BLOCKS database) (Henikoff and Henikoff 1992, 1993, 1994; Henikoff et al. 1995)	<a href="http://www.blocks.fhrc.org">http://www.blocks.fhrc.org</a>	Examines multiple alignments of related protein regions, in order to produce a matrix of amino acid substitutions scores, rather than extrapolating from scores of divergent but closely related sequences (as do the PAM scoring matrices). Most alike proteins in the alignment may be clustered to reduce the frequency of changes among the more commonly represented amino acids (e.g., for BLOSUM62, sequences that are 62% or more identical are clustered). There is no specific evolutionary model for these matrices as there is for PAM matrices; all sequences are considered just as likely to be the ancestor of the others (a star phylogeny).		Detection of similarity between protein sequences as evidence of evolutionary homology.
DNA PAM matrices	<a href="http://blast.wustl.edu/">http://blast.wustl.edu/</a> , see "Improved sensitivity of nucleic acid database searches using application-specific scoring matrices."	Assumes Markov model of change in DNA sequences (see PAM matrices below).		Prediction of evolutionary distance between DNA sequences.
PAM (Percent Accepted Mutation or mutations that survive natural selection) (Dayhoff et al. 1978; Schwartz and Dayhoff 1978; for more recent versions, please see Gon- nett et al. 1992; Jones et al. 1992)	FTP: <a href="ftp://ncbi.nlm.nih.gov/directory/blast/matrices">ftp://ncbi.nlm.nih.gov/directory/blast/matrices</a>	Predicts the expected amount of substitution in protein sequences that have had a given amount of evolutionary time to diverge from a common ancestor sequence. Assumes a Markov model of change (no site-to-site variation and no change in composition) and forward and reverse changes equally as likely. Matrix values give log odds scores for matches or mismatches. Best odds score for alignment is found when scoring matrix that matches number of mismatches in the alignment is used.		When used with alignment program, provides measure of similarity between 2 sequences being characterized by evolutionary distance. 1 PAM corresponds to the average change in 1% of all amino acid positions.

(Continued on following pages.)



TABLE A11-1 (Continued)

PROGRAM NAME	WEB SITE/FTP SITE	DESCRIPTION/PLATFORMS	INPUT FORMAT	INTERPRETATION/RESULTS
<b>DNA Sequence Alignment: Multiple Sequence Alignment</b>				
MSA (Lipman et al. 1989)	<a href="http://www.psc.edu/general/software/packages/msa/msa.html">http://www.psc.edu/general/software/packages/msa/msa.html</a> <i>Interactive Web forms at:</i> <a href="http://www.ibr.wustl.edu/service/msa/index.html">http://www.ibr.wustl.edu/service/msa/index.html</a> (other programs also available on this site)	Aligns several nucleic acid or protein sequences globally; uses dynamic programming to produce optimal alignment of all sequences at the same time; sequences are weighted in accord with their similarity to other sequences in the group. Uses sum of pairs score for evaluating columns in the alignment; normally limited to 3 sequences because it requires large amounts of computer time and memory. Three versions allow alignment of >3 sequences; up to 50 sequences where each sequence has <150 residues; up to 25 sequences where each sequence has <500 residues; up to 10 sequences where each sequence has <1000 residues. Interactive Web-based form; UNIX.	FASTA, GCG, PIR and other formats recognized by the READSEQ program.	Initially shows heuristic alignment based on a progressive pairwise alignment; this alignment is used to limit the search space for an optimal alignment; an optimal alignment is then shown; calculation of alignment costs; divergence values for each pairwise alignment; maximum score of optimal alignment.
CLUSTALW (Higgins and Sharp 1988; Higgins et al. 1992; Thompson et al. 1994)	<i>Interactive Web-based form at:</i> <a href="http://www.ibr.wustl.edu/ibr/msa.html">http://www.ibr.wustl.edu/ibr/msa.html</a> <a href="http://dot.imgen.bcm.tmc.edu:9331/multi-align/multi-align.html">http://dot.imgen.bcm.tmc.edu:9331/multi-align/multi-align.html</a> <a href="http://www.infobiogen.fr/docs/ClustalW/clustalw.html">http://www.infobiogen.fr/docs/ClustalW/clustalw.html</a> <i>FTP:</i> <a href="ftp://ftp.ebi.ac.uk/pub/software/unix/clustalw.tar.Z">ftp://ftp.ebi.ac.uk/pub/software/unix/clustalw.tar.Z</a>	Performs multiple alignments on a set of DNA or protein sequences or adds new sequences to an existing alignment; uses a progressive alignment of sequence pairs and groups using as a guide of similarity a neighbor-joining phylogenetic tree initially made by pairwise alignments of the sequences. The contribution of individual sequences to the alignment is weighted in accord with the amount of divergence from the other sequences (different from MSA). Uses position-dependent gap penalties depending on the estimated divergence in each region of the aligned sequences. Excellent method for sequences that are not very divergent; can make errors in the initial alignments of most-alike sequences that becomes more possible with increasing divergence. Matrices that may be used are BLOSUM80,62,45,30; Gonnett80,120,160,250,350; PAM20,60,120,350. CLUSTALW (weighted alignments) is a major update and rewrite of CLUSTALV. Interactive Web-based form; ANSI-C version for UNIX and VMS or any machine with ANSI-C compiler; executables for major platforms MAC, PC. Clustal X provides a graphic interface for an X windows environment.	FASTA; also GCG/MSF, NBRE/PIR, EMBL/Swiss Prot, GDE flat file, CLUSTAL, and GCG9-RSF formats. All sequences to be aligned must be in one file. Formats recognized by REASEQ program may be used.	Output formatted in CLUSTAL (shows sequence aligned in blocks), NBRE/PIR, GCG/MSF for input into GCG software; PHYLIP for input into Phylip, GDE flatfiles. For graphical views of the phylogenetic trees calculated after sequence alignment, other software, such as Phylip, must be used.
PIMA (Pattern-induced Multiple Alignment) (Smith and Smith 1990, 1992)	<i>Interactive Web-based form at:</i> <a href="http://dot.imgen.bcm.tmc.edu:9331/multi-align/multi-align.html">http://dot.imgen.bcm.tmc.edu:9331/multi-align/multi-align.html</a> <i>FTP:</i> <a href="ftp://ftp.ebi.ac.uk/pub/software/unix">ftp://ftp.ebi.ac.uk/pub/software/unix</a>	Constructs multiple sequence alignments by first performing pairwise alignments between the sequences and clustering the sequences into one or more families based on the scores.	See previous entry.	Multiple sequence alignment.

MACAW (Multiple Alignment Construction and Analysis Workbench) (Schuler et al. 1991)	<i>FTP:</i> ncbi.nlm.nih.gov/dir/pub/macaw	Common patterns are located in each family and the set of sequences is then aligned using these patterns as starting points; uses constraints to determine gap locations. Interactive Web-based form; UNIX.	FASTA	Multiple sequence alignment based on blocks; statistical evaluation of block similarity
SAM (Sequence Alignment and Modeling System) (Haussler et al. 1992; Hughey and Krogh 1995, 1996)	<a href="http://www.cse.ucsd.edu/research/compbio/sam.html">http://www.cse.ucsd.edu/research/compbio/sam.html</a> <i>FTP:</i> ftp.cse.ucsc.edu/dir/pub/protein/sam1.01.tar.Z.crypt	Locates, analyzes, and edits blocks of localized sequence similarity among multiple sequences; constructs multiple alignments by analyzing, editing, and combining blocks of aligned sequence segments. Sequence blocks are located using a sum of pairs scoring system to produce a local multiple sequence alignment or the Gibbs sampler (see Gibbs sampler, below), a statistical method, is used. The user interface allows the editing and linking of blocks. PC, NT, Mac.	DNA, RNA, and protein alphabets; user-defined alphabets, most common formats such as FASTA, GenBank, NBRF, EMBL, GCG, DNA Strider, Phylip, GCG/MSE, PAUP NEXUS, PIR CODATA; can be given a predetermined multiple sequence alignment. Uses READSEQ program to recognize sequence formats.	Hidden Markov model-based multiple sequence alignment; database search for new family members.
HMMER (Haussler et al. 1992; Hughey and Krogh 1995, 1996)	<a href="http://genome.wustl.edu/eddy/hmmer.html">http://genome.wustl.edu/eddy/hmmer.html</a> <i>FTP:</i> genome.wustl.edu/dir/pub/eddy	Uses a hidden Markov model to represent a multiple sequence alignment of a set of full sequences or partial sequences. The HMM allows matches, insertions, and deletions in the alignment. A model is produced for each sequence set by training the model with a family of related sequences. A large number of sequences (>50) are required to produce a representative model, and the larger the set, the better the model produced. A multiple sequence alignment may be used as input. The trained HMM will produce a multiple sequence alignment of the training sequences, and may also be used to search for new family members in sequence databases. HMMs have the advantage of offering a well-defined probabilistic model of sequence alignments. Conversion programs for HMMER formats are included. Encrypted source code; UNIX, Mas-Par.	FASTA, GenBank, EMBL, Swiss-Prot, GCG/MSE, SELEX	Hidden Markov model-based multiple sequence alignment. Smith-Waterman local alignments found by database searching. Global Needleman: Wunsch alignments found by database searching.
SAGA (Sequence Alignment by Genetic Algorithm) (Notredame and Higgins 1996)	<a href="http://www.ebi.ac.uk/~cedric">http://www.ebi.ac.uk/~cedric</a>	Creates multiple sequence alignments using genetic algorithms (developed as computer science tool) and user-defined objective functions (descriptors of multiple alignment quality). Software evolves population of alignments in	See program notes.	Globally optimal multiple sequence alignment.

(Continued on following pages.)

TABLE A11-1 (Continued)

PROGRAM NAME	WEB SITE/FTP SITE	DESCRIPTION/PLATFORMS	INPUT FORMAT	INTERPRETATION/RESULTS
DIALIGN segment alignment (Morgenstern et al. 1996)	<a href="http://www.gsf.de/biodv/dialign.html">http://www.gsf.de/biodv/dialign.html</a>	quasi-evolutionary manner; improves the fitness of the population using the objective functions. The software can align <20 sequences that are <400 residues long. A related program, COFFEE (Notredame et al. 1998; available at same site), can be used to optimize the multiple sequence alignment obtained. ANSI-C and UNIX versions. Compares whole segments of sequences instead of single residues. Constructs pairwise and multiple sequence alignments from gap-free pairs of equal-length segments, called diagonals. Especially useful for detecting local similarities in otherwise unrelated sequence. Download executables for DEC, SUN, HP, SG, CONVEX, and LINUS. (For commercial use, contact <a href="mailto:genomatix@gsf.de">genomatix@gsf.de</a> . DIALIGN2 offers a Web-based interactive form.	EMBL, FASTA, GCG/RSE, GenBank.DNA/protein sequences <1 Mb.	Alignment of input sequence; graphical representation of degree of local similarity between aligned sequences; sequence tree showing degrees of similarity.
MultiAlin (Corpet 1988)	<a href="http://protein.toulouse.inra.fr/multalin.html">http://protein.toulouse.inra.fr/multalin.html</a>	Web-based interactive form for multiple sequence alignment. Alignment parameters can be set; consensus level options can be chosen for output.	Multi-Alin FASTA; EMBL-SwissProt; GenBank	Multiple sequence alignment output as colored image, plain text, or HTML.
PRRP progressive global alignment (randomly or doubly-nested) (Gotoh 1995)	<a href="ftp://genome.ad.jp/pub/genome/saitama-cc">ftp://genome.ad.jp/pub/genome/saitama-cc</a>	Iterative method of multiple sequence alignment based on a profile method in which groups of sequences are repeatedly aligned, guided by a tree until best score is obtained. Avoids errors made by progressive alignment methods when sequences are divergent.	Special format (see program notes).	Best alignment after repeated trials.

**DNA: Motifs and Patterns**

MEME (Multiple Expectation Maximization for Motif Elicitation) (Bailey and Elkan 1994, 1995; Bailey 1995)	<a href="http://www.sdsc.edu/MEME/meme/website/intro.html">http://www.sdsc.edu/MEME/meme/website/intro.html</a> <i>Interactive Web-based form at:</i> <a href="http://www.sdsc.edu/MEME/website/meme.html">www.sdsc.edu/MEME/website/meme.html</a>	Detects motifs (conserved sequence patterns of the same length; no gaps; no covariations between positions) in groups of related DNA or protein sequences. The software uses a statistical technique (the expectation maximization or EM algorithm) to locate motifs of a given length range, of which there may be 0, 1, or more in an individual sequence, as specified by the user. The output is a PSSM (a position-specific-scoring-matrix) of each motif found with columns that represent motif positions and rows that represent the distribution of residues in each column in a log-odds format. The matrix may be used to search sequence		Results are e-mailed to user, including: PSSMs, which represent the distribution of residues in each column of the motifs found; diagram showing the information content of each column (represents degree of conservation at each motif position), multilevel consensus sequence, examples of motifs found, and location in input sequences; motif also output in BLOCKS format. PSSM may be subsequently
---	--	---	--	---

		databases using MAST. License needed for commercial use. Interactive Web-based form; ANSI source code.		used for database searches using MAST.
Meta-MEME (Grundy et al. 1997)	<i>FTP:</i> <a href="http://metameme.sdsc.edu">metameme.sdsc.edu</a> <i>Interactive Web-based form at:</i> <a href="http://www.sdsc.edu/MEME/meme/website/intro.html">http://www.sdsc.edu/MEME/meme/website/intro.html</a>	Combines DNA or protein motif patterns from MEME into a hidden Markov model (HMM) that represents an alignment of the sequences through alignments of the conserved motifs. The HMM may then be used to search sequence databases for other family members. Interactive Web-based form; ANSI-C source code and program binaries for selected platform.	Set of similar DNA or protein sequences in variety of formats (e.g., FASTA) or a set of motif models previously determined using MEME.	Motif-based multiple sequence alignment of query set of sequences for use in searching sequence databases for additional family members. Computes Viterbi score or total probability score for homology detection reported as log-odds scores
ASSET (Aligned Segment Statistical Evaluation Tool) (Neuwald and Green 1994)	<i>FTP:</i> <a href="http://ncbi.nlm.nih.gov/Dir/pub/asset">ncbi.nlm.nih.gov</a> <i>Dir:</i> <a href="http://pub/asset">pub/asset</a>	Performs a depth-first search for conserved sequence patterns to create a multiple sequence alignment by maximizing the log likelihood ratio statistic. Available as C code for UNIX system.	FASTA	Patterns found are reported as motifs with score and locations in sequences.
BLOCKS server (see also Table A11-2) (Smith et al. 1990; Henikoff and Henikoff 1991; Henikoff et al. 1999a,b)	<a href="http://www.blocks.fhcrc.org">http://www.blocks.fhcrc.org</a>	Blocks are conserved patterns of amino acid sequences of the same length (no gaps) found in members of a protein family. The BLOCKS resource will create blocks from a multiple sequence alignment or locate them in unaligned sequences by either a pattern-searching method or statistical method (Gibbs sampling). BLOCKS server is used to produce position-specific scoring matrices (PSSMs) and a consensus (cobble) sequence that may in turn be used to scan additional proteins in sequence databases for presence of block. An input sequence may also be scanned against blocks databases. Blocks have been calibrated for specificity against the Prosite and Swiss-Prot databases.	Input sequences in FASTA format on alignment (see description).	Blocks found are reported in their own (blocks) format. PSSMs and a cobble (consensus) are also given for further database searching. Output can be used to predict PCR primers using CODEHOPS.
BLIMPS-BLOCKS Improved Searcher (Henikoff and Henikoff 1991; Wallace and Henikoff 1992)	<a href="http://blocks.fhcrc.org">http://blocks.fhcrc.org</a> <i>FTP:</i> <a href="http://ncbi.nlm.nih.gov/Dir/repository/blocks/unix/blimps">ncbi.nlm.nih.gov</a> <i>Dir:</i> <a href="http://repository/blocks/unix/blimps">repository/blocks/unix/blimps</a> <i>FTP:</i> <a href="http://howard.fhcrc.org/Dir/blimps/">howard.fhcrc.org</a> <i>Dir:</i> <a href="http://blimps/">blimps/</a>	Alignment search software that scores sequence against BLOCKS database or blocks against sequence. (See also BLOCKS database in DNA: Motifs and Patterns.)	See BLOCKS server.	See BLOCKS server.
emotif (Exploring the Motif Universe) (Nevill-Manning et al. 1998)	<a href="http://dna.stanford.edu/emotif/simple.html">http://dna.stanford.edu/emotif/simple.html</a>	Forms motifs or subsets of aligned sequences. Interactive Web-based form.	Aligned sequence.	List of retrieved motifs.
MAST (Motif Alignment and Search Tool) (Bailey and Gribskov 1998)	<a href="http://www.sdsc.edu/MEME/meme/website/mast.html">http://www.sdsc.edu/MEME/meme/website/mast.html</a>	Searches databases for sequences that contain one or more motifs. (Motifs are defined on this site as conserved sequence patterns of the same length that occur one or more times in a related set of sequences.) Motifs are identified by searching through a set of related sequences with the MEME or	One or more motifs in MEME output or any file in an appropriate format (GCG profile file, concatenated GCG profile files, motif file format). The individual motifs cannot contain gaps.	Retrieved motifs; maximum of 50 matches returned. Output consists of names of high-scoring sequences, motif diagrams showing order and spacing of motifs (PSSM that describes score of each possi-

(Continued on following pages.)

TABLE A11-1 (Continued)

PROGRAM NAME	WEB SITE/FTP SITE	DESCRIPTION/PLATFORMS	INPUT FORMAT	INTERPRETATION/RESULTS
		BLOCKS servers; each are represented by a PSSM (position-specific scoring matrix) showing the variation in each column of the aligned motifs as a log odds score. Each PSSM is moved across each database sequence to identify high-scoring matches. Sequences with highest-scoring matches are identified. Web-based interactive form.		ble letter at each position in the pattern), detailed annotation of sequence; sequences shown with the location and scores for each motif found, and a combined probability score that these matches would have occurred by chance is also shown. HTML or ASCII format.
Gibbs sampler (Gibbs Sampling Strategy for Multiple Alignment) (Lawrence et al. 1993)	FTP: ncbi.nlm.nih.gov Dir:/pub/gibbs	Finds conserved patterns of sequence of the same length in a set of related sequences (no gaps, no correlations between positions) by a Gibbs sampling strategy. This method repeatedly rescans individual sequences in the set with a trial PSSM (position-specific scoring matrix) to find conserved patterns, using a probabilistic approach for choosing a matching location in the sequence, and then updates the matrix. Eventually, common patterns will be recruited to the matrix. May require initial estimate of pattern length (see also BLOCKS Web Site and MACAW).	FASTA	Location of conserved pattern in the sequences.
<b>DNA: Genes, Exons, Introns</b>				
Genie (Kulp et al. 1996; Reese et al. 1997)	http://www.fruitfly.org/seq_tools/genie.html	Finds potential genes in <i>Drosophila</i> genomic sequences using a hidden Markov model trained on known <i>Drosophila</i> genes, including a neural network trained on <i>Drosophila</i> splice sites. Tries to find one gene match on each strand of each sequence submitted; multiple sequences can be submitted. Software has been trained on human genes, but claims to give good results for other vertebrate sequences, <i>Drosophila</i> , other invertebrates.	DNA sequence in FASTA or multiple-FASTA; maximum DNA sequence length is 90,000 bases.	Highest-scoring gene location on each input DNA strand.
GeneMark (Borodovsky and McInich 1993)	http://genemark.biology.gatech.edu/ GeneMark/gm_info.html e-mail service: genemark@amberbiology.gatech.edu OR genemark@embl-ebi.ac.uk	Identifies protein-coding regions in prokaryotic or eukaryotic genomic DNA sequences. Uses inhomogeneous Markov chain models, each trained on known genes of each organism. Analyzes EST sequences; predicts long exons; can be used for designed RT-PCR primers. Web-based interactive form; e-mail server. License required for use of local version. GeneMark.hmm algorithm (Lukashin and Borodovsky 1998) is an extension of GeneMark used for more accurate finding of 5' ends in bacterial, human, and <i>C. elegans</i> genes.	DNA sequence in GCG, FASTA, EMBL, GenBank, PIR, NBRE, Phylip, text formats.	Coding signals for putative genes shown in graphical format (PSGRAPH). Text output for ORF predictions; possible frameshifts; right and left end of ORFs; orientation and frame of region; mean probability function; internal exon predictions.

Grail II - Gene Recognition and Analysis Internet Link: (Uberbacher and Mural 1991)	<a href="http://compbio.ornl.gov/Grail_1_3/">http://compbio.ornl.gov/Grail_1_3/</a>	Predicts exons in human genomic sequences. Uses neural networks trained on intron length, GC-composition, codon usage, 6-mer preference scores, splice junction scores, and other features. These scores are weighted in the neural network so as to give the best overall prediction of the training sequences. For new sequences, a sliding sequence window is moved across the sequence and a prediction (exon score) is made for each window.	Several formats.	List of best candidate exons and most probable gene structure.
GeneParser (Snyder and Stormo 1993, 1995)	<i>FTP:</i> <a href="http://beagle.colorado.edu/pub/GeneParser">beagle.colorado.edu/pub/GeneParser</a>	Predicts gene structure in genomic DNA sequences. Uses sequence indicators found in known exons, introns, and splice junctions (see Grail) to evaluate likelihood that a sequence interval represents an exon or intron. Applies dynamic programming algorithm to find the exon/intron combination that maximizes the likelihood function for predicting a gene structure. Neural network used to adjust weights to sequence indicators for best fit to known genes.	See documentation.	List of best candidate exons and most probable gene structures.
GENSCAN (Burge and Karlin 1997)	<a href="http://CCR-081.mit.edu/GENSCAN.html">http://CCR-081.mit.edu/GENSCAN.html</a> Web servers also at Stanford University, DKFZ/EMBLnet, Heidelberg, Pasteur Institute e-mail server at Pasteur Institute	Predicts genes in genomic DNA based on probabilistic models in gene structure in various organisms. Executables available for UNIX; license needed for commercial use.	DNA sequence, one-letter code.	Most probable gene structures.
NetGene (Brunak et al. 1991)	<a href="http://130.225.67.199/services/NetGene/index.html">http://130.225.67.199/services/NetGene/index.html</a> <i>e-mail service:</i> <a href="mailto:netgene@cbs.dtu.dk">netgene@cbs.dtu.dk</a>	Predicts splice sites in vertebrate genes. Uses neural networks trained to recognize differences in sequence features between exon and nonexon sequences (see Grail).	FASTA	Produces list of most strongly predicted exons.
FGENES (V.V. Solovyev, unpubl.)	<a href="http://genomic.sanger.ac.uk/gf/gf.html">http://genomic.sanger.ac.uk/gf/gf.html</a>	Predicts genes and exons by using pattern-based structure prediction. Algorithm based on pattern recognition of different types of exons, promoters, and poly(A) signals; dynamic programming finds optimal combinations and then constructs set of gene models. Interactive Web-based form. FGENESI+ (A.A. Salamov and V.V. Solovyev, unpubl.) predicts multiple genes in genomic DNA sequence using a hidden Markov model of genes and similarity with known protein. FGENES-M produces pattern-based human multiple variants of gene structure prediction.	FASTA, plain sequence.	Text output: number of predicted genes, number of predicted exons, positions of predicted genes and exons.
MZEF (Michael Zhang's Exon Finder) (Zhang 1997)	<a href="http://sciclio.cshl.org/genefinder">http://sciclio.cshl.org/genefinder</a> <i>FTP:</i> <a href="http://phage.cshl.org">phage.cshl.org</a> <i>Dir:</i> <a href="http://pub/science/mzef">pub/science/mzef</a>	Predicts internal coding exons. Based on prediction algorithm using quadratic discriminant function for multivariate statistical pattern recognition (best discriminates between exon and nonexon sequences using sequence features similar to those described for Grail). Software for SUN, DEC Alpha. Need site license for commercial use.	FASTA; maximum of 200 kb.	Exon boundaries in base pairs, posterior probability, frame preference score, ORF ordinator, acceptor score, coding preference score, donor score.

(Continued on following pages.)

TABLE A11-1 (Continued)

PROGRAM NAME	WEB SITE/FTP SITE	DESCRIPTION/PLATFORMS	INPUT FORMAT	INTERPRETATION/RESULTS
<i>DNA: Promoters, Transcription-factor Binding Sites</i>				
Transfac (Heinemeyer et al. 1999)	<a href="http://transfac.gbf.de/TRANSEFAC/">http://transfac.gbf.de/TRANSEFAC/</a> <i>FTP: transfac.gbf.de</i>	Transfac is a relational database of transcription factor <i>cis</i> -acting binding sites and transcription factors from many organisms, and also includes PSSMs (position-specific scoring matrices) representing the observed variation in each column of the aligned binding sites for one factor. (Some matrices may not be specific so that false positive matches are common.) Download is flat ASCII files. Software is for noncommercial use only. Programs include Coinspector, MatInspector, MatInd.	See web site.	Predicted location of TF binding sites.
CorePromoter (Zhang 1998)	<a href="http://sciclio.cshl.org/genefinder/CPROMOTER">http://sciclio.cshl.org/genefinder/CPROMOTER</a>	Predicts transcriptional start sites and localizes them into 50–100-bp core-promoter regions. Uses quadratic discrimination analysis to distinguish sequence features (e.g., conserved sequence words) characteristic of promoter sequences. Web-based interactive form. License needed for commercial use.	FASTA; DNA sequence must be <2 kb.	N-profile position scores; strand; prior probability; QDA data; maximum number of predictions.
NNPP ( <i>Promoter Prediction by Neural Network</i> ) (Reese 1994; Reese and Eeckman 1995; Reese et al. 1996)	<a href="http://www.fruitfly.org/seq_tools/promoter-instrucs.html">http://www.fruitfly.org/seq_tools/promoter-instrucs.html</a>	Finds eukaryotic and prokaryotic promoters in DNA sequence. Uses time-delay neural networks (TDNN) that recognize features such as the TATA box, the GC box, the CAAT box, and the initiator region that spans the transcription start site (TSS). TDNN is repeatedly trained and re-trained until it recognizes the most important features of each element as a scoring matrix. Predictions for each element are then combined so that elements can be found even when their spacing varies.	FASTA	Transcription start sites most likely to be promoters. For eukaryotes, list of the 51 bases spanning –40 to +11 where +1 is the predicted transcription start site. For prokaryotes, 46 bases spanning from –41 to +5 where +1 is the predicted transcription start site.
TESS ( <i>Transcription Element Search System</i> ) (Schug and Overton 1997)	<a href="http://www.cbil.upenn.edu/tess">http://www.cbil.upenn.edu/tess</a>	Finds potential transcription-factor-binding sites in DNA sequence (see Transfac). Has Web-based interactive forms for combined search query, browsing Transfac, string-based searching, filtered string-based searching. Options for filtering, setting thresholds, attributes, and scoring schemes.	DNA sequence	Predicted sites.
TFBIND (Tsunoda and Takagi 1999)	<a href="http://tfbind.ims.u-tokyo.ac.jp">http://tfbind.ims.u-tokyo.ac.jp</a>	Searches for transcription-factor-binding sites, including TATA boxes, GC boxes, CCAAT boxes, and transcription start sites.	FASTA	Predicted sites.

			Uses weight matrix in Transfac database and cut-off values (see Transfac). Web-based interactive form.		
TSSG (V.V. Solovyev et al., unpubl. [see <a href="http://dot.imgen.bcm.tmc.edu:9331/gene-finder/gf.html">http://dot.imgen.bcm.tmc.edu:9331/gene-finder/gf.html</a> ])	<a href="http://genomic.sanger.ac.uk/gf/Help/tssg.html">http://genomic.sanger.ac.uk/gf/Help/tssg.html</a> for information <i>e-mail service:</i> service@heory.bchs.tuh.edu Put tssg in subject line of message.	Recognizes human PolII promoter region and transcription start site. Uses a linear discriminant function that combines characteristics of functional motifs and oligonucleotide composition of transcription start sites.	DNA sequence	Promoter region, including sequence name, I/DI threshold and length of sequence, number of predicted promoter regions, positions of predicted sites, TATA box positions, transcription start site positions, functional motifs for each predicted region.	
TSSW (V.V. Solovyev et al., unpubl. [see <a href="http://dot.imgen.bcm.tmc.edu:9331/gene-finder/gf.html">http://dot.imgen.bcm.tmc.edu:9331/gene-finder/gf.html</a> ])	<a href="http://genomic.sanger.ac.uk/gf/Help/tssw.html">http://genomic.sanger.ac.uk/gf/Help/tssw.html</a> for information <i>e-mail service:</i> service@bchs.uh.edu OR services@bioinformatics.weizmann.ac.il Put tssw in subject line of message.	Recognizes human PolII promoter region and transcription start site. Uses linear discriminant function for prediction; combines characteristics describing functional motifs and oligonucleotide composition of the sites.	Name of sequence; sequence letters. Maximum line length is 79 characters.	Name of sequence; linear discriminant function threshold and length of sequence; number of predicted promoter regions; positions of predicted sites, TATA box, and transcription start site positions; functional motifs for each predicted region.	
MAR-Finder (Kramer et al. 1996; Singh et al. 1997)	<a href="http://www.ncgr.org/MarFinder/about.html">http://www.ncgr.org/MarFinder/about.html</a>	Deduces presence of matrix-associated regions (MARs) in DNA sequence. (Matrix-associated regions are the regions at which the chromatin fiber attaches to the nuclear matrix and are necessary for transcriptional regulation.) Method used is statistical inference and a Boolean logic network; 18 motifs known to occur in the neighborhood of MARs are used in the analysis. Web-based interactive form; registration necessary.	FASTA	High-scoring regions in base pairs, including average and integrated strengths; graphical output showing output of relative positions of potential MARs.	
GenomeInspector (Quandt et al. 1996a,b)	<a href="http://www.gsf.de/biodv/genomeinspector.html">http://www.gsf.de/biodv/genomeinspector.html</a>	Detects distance correlation between open reading frames and transcription binding sites on megabases of nucleotide sequence; uses large-scale correlation analysis. Download executables for DEC Alpha, SUN, HP, Silicon Graphics, CONVEX; UNIX and X-windows. License needed for commercial use.	Many formats including database annotation, GCG, ConsInspector, MatInspector.	Graphical display showing correlation of ORFs and ARS-binding factor 1 binding sites.	
<b>DNA: Other Regulatory Sites</b>					
consensus and wconsensus (Hertz and Stormo 1999)	<a href="ftp://beagle.colorado.edu/pub/consensus">FTP:beagle.colorado.edu/pub/consensus</a>	A sliding window from each sequence is scanned against windows of the remaining sequences to find the most alike regions. The combined alignments of two or more windows are then used to recruit additional matching regions from other sequences. The algorithm is greedy in the sense that the first sequences to be matched determine the ultimate alignment of all sites found. Thus,	Set of input sequences.	Aligned sites in input sequences and position-specific scoring matrices for these sites.	

(Continued on following pages.)



TABLE A11-1 (Continued)

PROGRAM NAME	WEB SITE/FTP SITE	DESCRIPTION/PLATFORMS	INPUT FORMAT	INTERPRETATION/RESULTS
		multiple cycles of matching are necessary. In consensus, window width is user-specified, and in wconsensus, it is not specified since the method can recruit flanking sequence if informative. The object is to maximize the information content (highest conservation of bases in each column) of a PSSM (position-specific scoring matrix). Includes important statistical evaluation of the PSSM. Note that there is no accounting for covariation within the sites as in palindromic regulatory sites, but methods to locate such regions have been described (Hertz and Stormo 1995). Available for implementation on UNIX platforms.		
polyadq (Zhang 1997)	<a href="http://sciclio.cshl.org/mzhanglab/tabaska/polyadq/polyadq_form.html">http://sciclio.cshl.org/mzhanglab/tabaska/polyadq/polyadq_form.html</a>	Decides if a given AATAA or ATTAAA hexamer is a true poly(A) signal. Algorithm uses quadratic discriminant analysis (see MZEF) Web-based interactive form.	FASTA. Can set cut-off score by four methods.	Prediction for each AATAA or ATTAAA found in the query sequence. Output is head, plus or minus prediction, site, sequence, and score.
Pol3scan (Pavesi et al. 1994)	<a href="http://irisbioc.bio.unipr.it/pol3scan.html">http://irisbioc.bio.unipr.it/pol3scan.html</a>	Searches eukaryotic DNA sequence for PolIII intergenic control regions; can discriminate between tRNA genes and related class III elements. Algorithmic method based on analysis of 231 eukaryotic tRNA promoter regions; weight (position-specific scoring) matrices and weight vectors used for scoring. Web-based interactive form.	ReadSeq; also all common formats including FASTA, GenBank, EMBL, GCG, etc.	Predictions of class III intergenic region and presence of transcription termination sites.
<b>RNA: Secondary Structure</b>				
MFOLD (Jaeger et al. 1989; Zuker 1989; Walter et al. 1994)	<a href="http://bioweb.pasteur.fr/seqanal/interfaces/mfold.html">http://bioweb.pasteur.fr/seqanal/interfaces/mfold.html</a>	Predicts RNA secondary structure; computes number of folds, 5' base number (start), and 3' base number (stop). Uses energy minimization method of Zuker. A maximum of 1400 bases can be folded. Web-based interactive form. Can be implemented on a local UNIX host with graphic interface for exploring alternative structural models in given energy range.	RNA and DNA 1-nucleotide sequence in most common formats, including FASTA, IG, GenBank, NBRF, EMBL, etc.	Energy matrices that determine the optimal and suboptimal secondary structure; computed folding has energy within given range of computed minimum free energy. Matrices are written to an output file. Plotfold software is used to read the file and display a representative set of optimal and suboptimal secondary structures.
Vienna RNA package (Shapiro 1988; McCaskill 1990; Shapiro and Zhang	<a href="http://www.tbi.univie.ac.at/~ivo/RNA">http://www.tbi.univie.ac.at/~ivo/RNA</a>	Calculates predictions of RNA structures with minimum free energies as well as equilibrium partition functions and base-pairing probab-	RNA sequence; HIT representation for structure representation	RNAfold produces plots and dot plot of minimum free energy structure and base pair

1999; Bonhoeffer et al. 1993; Fontana et al. 1993; Hofacker et al. 1994; Wuchty et al. 1999.

ities. Web-based interactive form for moderate sized RNAs.  
 RNAfold calculates secondary RNA structure.  
 RNAeval calculates energy of RNA sequence on given structure.  
 RNAheat calculates specific heat of RNA.  
 RNAinverse finds an RNA sequence with a given secondary structure.  
 RNAdistance calculates the distance of RNA secondary structure.  
 RNApbdist calculates the distance of thermodynamic RNA secondary structure groups.  
 RNAsubopt calculates suboptimal secondary structure.  
 Download source codes (C code library) or stand-alone programs for UNIX, LINUX.

probabilities.  
 RNAeval gives energy in Kcal/mole; RNA heat, temperature in degrees C, specific heat in Kcal/mole\*K.  
 RNAinverse, found sequence, Hamming distance to start sequence.  
 RNAdistance, base pair distribution.  
 RNApbdist, partition function and matrix of base-pairing probabilities, dot plots.  
 RNAsubopt, structure in bracket notation and energy in Kcal/mole.

**RNA: RNA-specifying Genes, Motifs**

tRNAscan-SE  
 (Fichant and Burks 1991; Eddy and Durbin 1994; Pavesi et al. 1994; Lowe and Eddy 1997)

<http://www.genetics.wustl.edu/eddy/tRNAscan-SE>

Searches for tRNA genes in genomic DNA or RNA sequence. Candidate tRNAs are identified and analyzed by a highly selective tRNA covariance model (sequence variation that occurs at two separated sites to conserve base pairing in regions of RNA secondary structure); searches are done at 30,000 bp/sec.  
 The method also searches for eukaryotic PolIII sites and RNA promoters. Web-based interactive form, UNIX source code can also be accessed from the Web page.

Raw sequence, FASTA, GenBank, EMBL, GCG, IG. Searches are best as one sequence at a time, each sequence under 100,000 nucleotides.

Candidate tRNA genes.

snoRNA  
 (Lowe and Eddy 1999)

<http://rna.wustl.edu/snoRNAdb>

Searches prescreened sections of genomic sequence with characteristic sequence patterns for 2'-O-ribose methylation guide snoRNA genes (sno, small nucleolar).  
 The algorithm uses probabilistic methods similar to those used in speech recognition and computational linguistics.  
 SCFG models (stochastic, context-free grammars) are used to recognize regions with a particular pattern of sequence covariation in separated regions of sequence that corresponds to sequences that base pair to form dsRNA secondary structure.

**Protein: Sequence Alignment**

FASTA, SSEARCH, Baves block aligner

Please see DNA sequence alignment section.

(Continued on following pages.)

TABLE A11-1 (Continued)

PROGRAM NAME	WEB SITE/FTP SITE	DESCRIPTION/PLATFORMS	INPUT FORMAT	INTERPRETATION/RESULTS
<i>Proteins: Motifs, Patterns, Profiles</i>				
emotif, ProfileMaker, Psi-BLAST, Phi-BLAST, PowerBLAST, Blast 2, Bayes block aligner, LAMA, BLOCKS	Please see DNA motifs, patterns, profiles section.			
PowerBLAST	<a href="http://www.ncbi.nlm.nih.gov/Kuehl/prefinished/powblast.html">http://www.ncbi.nlm.nih.gov/Kuehl/prefinished/powblast.html</a>	Provides added functionality over the traditional BLAST programs. Allows masking of a sequence against human repetitive elements, comparison of masked sequence against multiple databases simultaneously. Allows rapid examination of ESTs, STSS, and gene hits in the context of their spatial relationships to one another. User can set additional parameters, filter BLAST hits by organism, and choose multiple output options. Web-based interactive form.	FASTA	Text, HTML, or ASN.1 output. A file is output for each sequence in the query. The output can be viewed with a mask. Sequin can be used to annotate the BLAST hits.
PfScan (ProfileScan) (Swiss Institute of Bioinformatics [see www site])	<a href="http://www.isrec.isb-sib.ch/software/PFSCAN_form.html">http://www.isrec.isb-sib.ch/software/PFSCAN_form.html</a>	Scans protein or DNA sequence against profiles from the PROSITE catalog. PROSITE contains amino acid patterns found in families of functionally related proteins, e.g., representing active site of protein kinases. The patterns are given as regular expressions that provide a list of the sequential amino acids found in the sites showing conserved, variable, amino acids not found and skipped amino acid positions. Also scans profiles against Swiss-Prot protein sequence database. Can search against the Pfam database. Web-based interactive form.	FASTA	Optimal alignment scores for profiles—PROSITE profiles N score; Pfam-A Nscore; Gribskov Z score; PROSITE patterns.
Pfam (Sonnhammer et al. 1997, 1998; Bateman et al. 1999, 2000)	<a href="http://www.sanger.ac.uk/Software/Pfam">http://www.sanger.ac.uk/Software/Pfam</a> Sweden: <a href="http://www.cgr.ki.se/Pfam">www.cgr.ki.se/Pfam</a> USA: <a href="http://pfam.wustl.edu">pfam.wustl.edu</a>	Enables rapid and automatic classification of predicted proteins into protein domain families; considers domain organization of proteins. Annotates protein using hidden Markov model software (see HMMER) that represents highly suitable probabilistic models of protein families, predicts genes, and annotates DNA sequence using the Wise2 package. The database contains 2128 families matching 65% of the proteins in Swiss-Prot. Genomic DNA can be directly searched against the Pfam library. This software was used to annotate the <i>C. elegans</i> genome.	FASTA	Graphical representation of domain structure. Name of domain in Pfam; start and end points of domain; statistical score of match in bits and <i>E</i> values; alignment of matching section of query sequence to relevant hidden Markov model. Provides functional annotation, literature references, and database links for each family. The output can be linked to the SCOP database to determine if the domain's structure has been solved.

ScanProsite (Swiss Institute of Bioinformatics, see WWW site):	<a href="http://www.expasy.ch/tools/scanspstr.html">http://www.expasy.ch/tools/scanspstr.html</a>	Scans sequence against patterns in PROSITE or a pattern against Swiss-Prot. Web-based interactive form.		Graphical output.
PPSEARCH (European Bioinformatics Institute, Hinxton, UK)	<a href="http://www2.ebi.ac.uk/ppsearch">http://www2.ebi.ac.uk/ppsearch</a>	Scans sequence against patterns in PROSITE.		
PROSITE (Klaus Hornuth, University of Vienna, Manfred D. Zorn, Lawrence Berkeley Laboratory)	<a href="http://pbl.jhu.edu/cgi-bin/mpsa-automat.pl?page=mpsa-prosite.html">http://pbl.jhu.edu/cgi-bin/mpsa-automat.pl?page=mpsa-prosite.html</a> FTP: genome.lbl.gov Dir: /pub/prosite File: Prosite.shar.Z	Scans sequence against patterns from PROSITE; can define level of mismatches. Web-based interactive form. Download UNIX, C code. Also available commercially. Many other programs that use PROSITE are listed at <a href="http://www.expasy.ch/cgi-bin/lists/prosite.org">www.expasy.ch/cgi-bin/lists/prosite.org</a>	Swiss-Prot, EASFA, ASCII	ASCII. Positions of patterns shown under sequence; complete PROSITE pattern position pattern of pattern occurrences for each pattern.
BEAUTY (BLAST Enhanced Alignment Utility) (Worley et al, 1995, 1998)	<a href="http://gc.bcm.tmc.edu:8088/search/launcher/launcher.html">http://gc.bcm.tmc.edu:8088/search/launcher/launcher.html</a>	An enhanced version of NCBI BLAST that facilitates identification of functions of matched sequences. Integrates protein families, conserved regions, annotated regions, alignment displays, and WWW resources. Includes new databases of conserved regions and functional domains for protein sequences in NCBI Entrez. An updated version of BEAUTY-X provides enhanced output for DNA queries, ability to search any protein database, and more domain information. Web-based interactive form.	FASTA and other formats.	Schematic display compares relative locations of conserved regions, annotated domains and sites, locally aligned regions matched in a BLAST search, and WWW links to external databases for additional functional information.

TABLE A11-2 Database Similarity Search Software

PROGRAM NAME	WEB SITE/FTP SITE	DESCRIPTION/PLATFORMS	INPUT FORMAT	INTERPRETATION/RESULTS
BLAST ( <i>Basic Alignment Search Tool</i> ) (Altschul et al. 1990; Karlin and Altschul 1990, 1993; Tatusova and Madden 1999)	<a href="http://www.ncbi.nlm.nih.gov/BLAST">http://www.ncbi.nlm.nih.gov/BLAST</a>	Sequence similarity search tool for analysis of nucleotide (DNA) and protein databases; uses heuristic algorithm that seeks high-scoring words and then uses these to produce gapped local alignments; filters out low-complexity regions from the search (optional); assigns scores with well-defined statistical interpretation so that real matches can be distinguished from random background hits. Default scoring matrix is BLOSUM62. The significances of the matches are given an Expect ( <i>E</i> ) score, the expected number of alignments between a random query sequence and a database of random sequences of the same "effective" length and number that will score as well. Available as interactive Web-based interface, stable URL, e-mail server, network BLAST with downloadable client for AIX, UNIX (see Web Site for details). Subprograms include: <i>blastn</i> —compares nucleotide query sequence against nucleotide sequence database <i>blastp</i> —compares amino acid query sequence against protein sequence database <i>blastx</i> —compares 6-frame conceptual translation products of nucleotide query sequence (both strands) against protein sequence database <i>tblastn</i> —compares protein query sequence against nucleotide sequence database dynamically translating all 6 reading frames <i>tblastx</i> —compares 6-frame translations of nucleotide query sequence against 6-frame translations of nucleotide sequence database A stand-alone BLAST system can be established locally on many computer platforms, including PC Windows 32, by FTP from <a href="http://ncbi.nlm.nih.gov/blast/executables">ncbi.nlm.nih.gov/blast/executables</a> .	FASTA or Accession/GenBank index no.	Mouse-clickable histogram of matches; list of high-scoring database sequences; gapped, local alignment of query sequence with matching database sequences with statistical evaluation; list of parameters used and statistical calculations made during search.
PHI-BLAST ( <i>Position Hit Initiated BLAST</i> ) (Zhang et al. 1998)	<a href="http://www.ncbi.nlm.nih.gov/BLAST">http://www.ncbi.nlm.nih.gov/BLAST</a>	Finds protein sequences that share an amino acid pattern, entered using PROSITE syntax (a regular expression). Program is integrated with PSI-BLAST so that query results can be used to start one or more rounds of PSI-BLAST searching using Web-based interactive form.	FASTA or Accession/GenBank index no.	Statistical significance of sequences that contain patterns are reported using <i>E</i> values. Multiple sequence alignment (a position-specific scoring matrix of the matching sequences) can then be used for additional rounds (iterations) of database searching using PSI-BLAST.
PSI-BLAST ( <i>Position-specific BLAST</i> ) (Altschul et al. 1997)	<a href="http://www.ncbi.nlm.nih.gov/BLAST">http://www.ncbi.nlm.nih.gov/BLAST</a>	Search for similar protein sequences using a multiple sequence alignment as the query, thus allowing searches for new combinations of residues found in the alignment. Starts with a regular BLAST search, but as new matching sequences are found, these are added to the alignment and an iteration of the search can then be performed; multiple iterations are possible until no more matching sequences are found. Web-based interactive form.	FASTA or Accession/GenBank index no.	A multiple sequence alignment (a position-specific scoring matrix of the matching sequences) replaces the initial pattern and may be used for additional rounds (iterations) of database searching until no more matching sequences are found.

BLAST2 (Gapped BLAST) (Altschul et al. 1997)	<a href="http://www.ncbi.nlm.nih.gov/BLAST/">http://www.ncbi.nlm.nih.gov/BLAST/</a>	The newer version 2 of BLAST returns a local (Smith-Waterman) alignment from BLAST searches and uses the statistical significance of the alignment scores to identify the most alike sequences; this is the default condition for the BLAST2 program. Earlier versions of BLAST identified high-scoring regions, and used the sum of these scores to evaluate the significance of the sequence similarity.	FASTA or Accession/GenBank index no.	
BLAST-Genome Sequences	<a href="http://www.ncbi.nlm.nih.gov/genome/seq">http://www.ncbi.nlm.nih.gov/genome/seq</a>	Searches a query sequence against the human genome data base (or any other genomic sequence database). Interactive Web-based form.	FASTA or Accession/GenBank index no.	Match of sequence by chromosomal number.
WU-BLAST (Washington University BLAST) (Altschul et al. 1990; Gish and States 1993; Karlin and Altschul 1993; Altschul and Gish 1996; W. Gish unpubl.)	<a href="http://blast.wustl.edu">http://blast.wustl.edu</a>	Performs similarity searches of proteins and nucleotide sequence databases; similar to NCBI BLAST but developed independently and can produce different results. WU-BLAST2 uses gapped alignments to identify matching sequences; produces a gapped local (Smith-Waterman) alignment; calculates statistical significance based on the combined scores of high-scoring regions (the sum statistics method as in earlier pre-version 2 versions of NCBI BLAST). BLASTN, BLASTP, TBLASTN, BLASTX and TBLASTX programs are available (see NCBI BLAST); includes improvements for identifying coding regions and uses DNA scoring matrices for more significant alignment of nucleic acids. Contains enhancements for optimized execution, reduced virtual memory requirements, support for parallel processing, and eXtended Database Format (XDF). Software is downloadable from Web Site: License is free for academic and nonprofit use; fee for commercial use.	FASTA or Accession/GenBank index no.	Mouse-clickable map of matching sequences, lists of matching sequences with sum-statistics scores, gapped alignments with potentially multiple regions of similarity; can be used to show all exons in multi-exon sequence; all complete on partial copies of repetitive element in genomic sequence.
FASTA Programs				
FASTA (Pearson and Lipman 1988)	<a href="http://fasta.bioch.virginia.edu">http://fasta.bioch.virginia.edu</a> <i>FTP:</i> <a href="ftp://ftp.virginia.edu/dir/pub/fasta">ftp://ftp.virginia.edu/dir/pub/fasta</a>	The FASTA package includes a suite of programs for data base similarity searching and for pair-wise sequence alignment. Compares DNA sequence to another DNA sequence or to a DNA sequence database (designated library by the programs), or a protein sequence to another protein sequence or to a protein sequence database; also compares protein sequence to translated DNA sequence or DNA sequence database (library). FASTA3 (version 3) returns matches based on a normalized Z score, the number of standard deviations above a mean of 50 and standard deviation of 10 for matching all unrelated sequences of the same length in the database. The E (expect) value of the Z score, the number of unrelated sequences in the database that are expected to score as well, is given. Can search individual genomes; databases listed on Web form. Web-based interactive form, or down-loadable software. Permission needed for commercial use. FASTA may be established on a variety computer platforms, including Macintosh and PC Windows, but without a graphical interface.	FASTA or Accession/GenBank index no.	Provides a graphical display of the range of alignment scores found between the query sequence and each database sequence, with a fit of the scores with unrelated proteins to the extreme value distribution. A list of high-scoring sequences is then given followed by gapped alignments of the query and matched data base sequences. Normalized Z scores are used to describe the relationship of the alignment score between related sequences to that found for unrelated sequences in the same length range (mean 50, standard deviation 10). The E value of these high Z scores is the expected number of unrelated sequence alignments with Z scores as high as that found with the matched sequence.

(Continued on following pages.)

TABLE A11-2 (Continued)

PROGRAM NAME	WEB SITE/FTP SITE	DESCRIPTION/PLATFORMS	INPUT FORMAT	INTERPRETATION/RESULTS
TEASTX/TEASTY EASTX, EASTY (Chao et al. 1992)	<a href="http://fasta.bioch.virginia.edu">http://fasta.bioch.virginia.edu</a>	Compares protein sequence to translated DNA sequence or DNA sequence database (TEASTX/TEASTY) or translated DNA sequence against protein sequence database (EASTX/EASTY); designed to accommodate high error rate in EST sequences by allowing frameshifts and substitutions.	FASTA or Accession/Genbank index no.	Single alignment between 2 sequences; DNA sequence is translated in 3 forward and 3 reverse frames; protein query is compared to each of the 6 derived protein sequences. DNA sequence is translated from one end to the other and intervening sequences are not edited out; termination codons are translated into unknown amino acids.
FASTS/TEASTS EASTF/TEASTF	<a href="http://fasta.bioch.virginia.edu">http://fasta.bioch.virginia.edu</a>	Compares sequence of peptide fragments (mass-spectrophotometric analysis) (FASTS) or an ordered peptide mixture (EASTF) against a protein (EASTS) or DNA (TEASTS) data base.	See Web site	Similar to FASTA, includes list of matching sequences in the database.

**TABLE A11-3 Bioinformatics Databases**

DATABASE	WWW ADDRESS	DESCRIPTION
<b>DNA</b>		
GenBank	<a href="http://www.ncbi.nlm.nih.gov/Genbank/GenbankSearch.html">www.ncbi.nlm.nih.gov/Genbank/GenbankSearch.html</a>	DNA sequence database maintained by National Center for Biotechnology Information (NCBI); member of International DNA Databases.
EMBL (Baker et al. 2000)	<a href="http://www.ebi.ac.uk/embl/">www.ebi.ac.uk/embl/</a>	DNA sequence database maintained by European Bioinformatics Institute (EBI); member of International DNA databases.
DDBJ	<a href="http://www.ddbj.nig.ac.uk">www.ddbj.nig.ac.uk</a>	DNA sequence database maintained by DNA Data Bank of Japan; member of International DNA Databases.
<b>DNA: Motifs, Patterns</b>		
Codon use database <i>Arabidopsis</i>	<a href="http://www.kazusa.or.jp/codon/">http://www.kazusa.or.jp/codon/</a>	Consensus splice sites.
Yeast splice sites by M. Ares, Jr. laboratory (Spingola et al. 1999)	<a href="http://genome-www.stanford.edu/Arabidopsis/splice_site.html">http://genome-www.stanford.edu/Arabidopsis/splice_site.html</a>	
	<a href="http://www.cse.ucsc.edu/research/compbio/yeast_introns.html">http://www.cse.ucsc.edu/research/compbio/yeast_introns.html</a>	
<b>DNA: Promoters and Regulatory Sequences</b>		
EPD (Eucaryotic promoter Database) (Bucher 1990; Perier et al. 1999)	<a href="http://www.epd.isb-sib.ch/">http://www.epd.isb-sib.ch/</a> ; <a href="http://www.epd.isb-sib.ch/promoter_elements/">http://www.epd.isb-sib.ch/promoter_elements/</a>	
TRRD (Transcriptional Regulatory Region Database); (Kolchanov et al. 1999)	<a href="http://wwwmgs.bionet.nsc.ru/mgs/systems/geneexpress/">http://wwwmgs.bionet.nsc.ru/mgs/systems/geneexpress/</a>	
TSSW (Recognition of human PolII promoter region and start of transcription by linear discriminant function analysis)	<a href="http://genomic.sanger.ac.uk/gf/gf.shtml">http://genomic.sanger.ac.uk/gf/gf.shtml</a> ; <a href="http://dot.imgen.bcm.tmc.edu:9331/gene-finder/gf.html">http://dot.imgen.bcm.tmc.edu:9331/gene-finder/gf.html</a>	
OOTFD (Object-Oriented Transcription Factor Database) (Ghosh 1998)	<a href="http://www.isbi.net/">http://www.isbi.net/</a>	
PLACE (plant <i>cis</i> -acting regulatory elements) (Higo et al. 1999)	<a href="http://www.dna.affrc.go.jp/htdocs/PLACE/">http://www.dna.affrc.go.jp/htdocs/PLACE/</a>	
PlantCARE (plant <i>cis</i> -acting regulatory elements) (Rombauts et al. 1999)	<a href="http://sphinx.rug.ac.be:8080/PlantCARE/index.htm">http://sphinx.rug.ac.be:8080/PlantCARE/index.htm</a>	
Thyroid receptor resource	<a href="http://xanadu.mgh.harvard.edu/receptor/trrfront.html">http://xanadu.mgh.harvard.edu/receptor/trrfront.html</a>	

(Continued on following pages.)



TABLE A11-3 (Continued)

DATABASE	WWW ADDRESS	DESCRIPTION
<b>RNA</b>		
5S ribosomal RNA data bank (Szymanski et al. 1999)	<a href="http://rose.man.poznan.pl/5SData/5SRNA.html">http://rose.man.poznan.pl/5SData/5SRNA.html</a> and mirrored at <a href="http://userpage.chemie.fu-berlin.de/fb_chemie/ibc/agerdmann/5S_rRNA.html">http://userpage.chemie.fu-berlin.de/fb_chemie/ibc/agerdmann/5S_rRNA.html</a>	
Gobase for Mitochondrial Sequences (Korab-Laskowska et al. 1998)	<a href="http://alice.bch.umontreal.ca/genera/gobase/gobase.html">http://alice.bch.umontreal.ca/genera/gobase/gobase.html</a>	
Guide RNA (gRNA) database (Souza and Göringer 1998)	<a href="http://www.biochem.mpg.de/~goeringe/">http://www.biochem.mpg.de/~goeringe/</a>	
tRNA Genes, higher-plant mitochondria (Ceci et al. 1999)	<a href="ftp://ftp.ebi.ac.uk/pub/databases/plmitrna/">ftp://ftp.ebi.ac.uk/pub/databases/plmitrna/</a>	
Nucleic acid database and structure resource (Berman et al. 1998)	<a href="http://ndbserver.rutgers.edu/">http://ndbserver.rutgers.edu/</a>	
Pseudobase (Pseudoknot database main- tained by E van Batenburg, Leiden University)	<a href="http://wwwbio.leidenuniv.nl/~batenburg/pkb.html">http://wwwbio.leidenuniv.nl/~batenburg/pkb.html</a>	
Ribosomal RNA mutation databases (Triman and Adams 1997)	<a href="http://www.fandm.edu/Departments/Biology/Databases/RNA.html">http://www.fandm.edu/Departments/Biology/Databases/RNA.html</a>	
RNA modification database (Limbach et al. 1994; Rozenski et al. 1999)	<a href="http://medlib.med.utah.edu/RNAmods/">http://medlib.med.utah.edu/RNAmods/</a>	
RNA secondary structures (Group I introns–16S rRNA–23S rRNA) (Gutell 1994; Schnare et al. 1996 and references therein)	<a href="http://pundit.icmb.utexas.edu">http://pundit.icmb.utexas.edu</a>	
RNA structure database	<a href="http://grserv.med.jhmi.edu/~venk/rna/">http://grserv.med.jhmi.edu/~venk/rna/</a>	
RNA World at IMB Jena (Sühnel 1997)	<a href="http://www.imb-jena.de/RNA.html">http://www.imb-jena.de/RNA.html</a>	
rRNA (database of ribosomal subunit sequences) (De Rijk et al. 1992, 1999)	<a href="http://trna.uia.ac.be/">http://trna.uia.ac.be/</a>	
Small RNA database	<a href="http://mber.bcm.tmc.edu/smallRNA/smallrna.html">http://mber.bcm.tmc.edu/smallRNA/smallrna.html</a>	
snoRNA database for <i>S. cerevisiae</i> (Lowe and Eddy 1999)	<a href="http://rna.wustl.edu/snoRNAdb/">http://rna.wustl.edu/snoRNAdb/</a>	
tmRNA database (Wower and Zwiab 1999)	<a href="http://psyche.uthct.edu/dbs/tmRDB/tmRDB.html">http://psyche.uthct.edu/dbs/tmRDB/tmRDB.html</a>	

uRNA database (Zwieb 1997)	<a href="http://psyche.uthct.edu/dbs/uRNADB/uRNADB.html">http://psyche.uthct.edu/dbs/uRNADB/uRNADB.html</a>
Viroid and viroid like RNA sequences (Lafontaine et al. 1999)	<a href="http://www.callisto.si.usherb.ca/~jpperra">http://www.callisto.si.usherb.ca/~jpperra</a>

**Protein: Motifs Based on Sequence Alignments**

HSSP ( <i>H</i> omology-derived Secondary Structure of Proteins) (Sander and Schneider 1991)	<a href="http://www.sander.embl-ebi.ac.uk/hssp">http://www.sander.embl-ebi.ac.uk/hssp</a>	Derived database that merges two- and three-dimensional structure and sequence information.
BLOCKS motif, pfam, prints, prodom SYSTEMS (Krause et al. 1999)	See Table A11-1. <a href="http://www.dkfz-heidelberg.de/tbi/services/cluster/systerform">http://www.dkfz-heidelberg.de/tbi/services/cluster/systerform</a>	Based on clustering of all similar sequences in Swiss-Prot.
Protomap (Yona et al. 1998)	<a href="http://www.protomap.cs.huji.ac.il">http://www.protomap.cs.huji.ac.il</a>	Automatic hierarchical classification of all Swiss-Prot proteins.
Prodom (Corpet et al. 1998)	<a href="http://protein.toulouse.inra.fr/prodom.html">http://protein.toulouse.inra.fr/prodom.html</a>	Groups of sequence segments or domains from similar sequences found in Swiss-Prot database by Blastp algorithm; aligned by multiple sequence alignment.

**Protein: Structural Alignment**

SCOP (Structural Classification of Proteins) (Murzin et al. 1995)	<a href="http://scop.mrc-imb.cam.ac.uk/scop/">http://scop.mrc-imb.cam.ac.uk/scop/</a>	Classification of 11 proteins whose structure is known based on expert analysis; includes all PDB entries.
FSSP ( <i>F</i> old classification based on Structure-Structure alignment of Proteins) (Holm and Sander 1996)	<a href="http://www2.ebi.ac.uk/dali/fssp/fssp.html">http://www2.ebi.ac.uk/dali/fssp/fssp.html</a>	Three-dimensional structure comparison of protein structures in PDB; structural alignments are performed by Dali program.
3D-Ali (Pascarella and Argos 1992)	<a href="http://embl-heidelberg.de/argos/ali/ali_info.html">http://embl-heidelberg.de/argos/ali/ali_info.html</a>	Aligned protein structures and related sequences using only secondary structures assigned by the author of the structures.
National Center for Biotechnology Information Structure Group	<a href="http://www.ncbi.nlm.nih.gov/Structure/">http://www.ncbi.nlm.nih.gov/Structure/</a>	Molecular modeling database (MMDB), vector alignment search tool (VAST) for structural comparisons, viewers, threader software.
Biomolecular Structure and Modelling group at the University College, London	<a href="http://www.biochem.ucl.ac.uk/bsm/">http://www.biochem.ucl.ac.uk/bsm/</a>	CATH database, a hierarchical domain classification of protein structures by class, architecture, fold family, and superfamily, other databases and structural analyses, threader software.
European Bioinformatics Institute, Hinxton, Cambridge	<a href="http://www2.ebi.ac.uk/">http://www2.ebi.ac.uk/</a>	Databases, TOPS protein structural topology cartoons, Dali domain server, and FSSP database.

(Continued on following pages.)

TABLE A11-3 (Continued)

DATABASE	WWW ADDRESS	DESCRIPTION
<i>Protein: Structural Coordinates</i>		
PDB (Protein Data Bank) (Berman et al. 2000)	<a href="http://www.rcsb.org/pdb">http://www.rcsb.org/pdb</a>	Three-dimensional macromolecular structure data determined mainly by X-ray crystallography and nuclear magnetic resonance; also contains atomic coordinates, reference citations, and primary and secondary structure information. Operated by the Research Collaboration for Structural Bioinformatics, Rutgers.

This survey of databases lists the principal databases as well as some of the more specialized databases for DNA, protein, and RNA. There are several Web pages that list and provide links to the large array of databases. Among these are:

Gabriel's Hot List

<http://www.bmm.icnet.uk/useful/usefulz.html>

Extensive lists of links to sequence and structure databases and to specialized databases.

A List of Databases, Rockefeller University

<http://linkage.rockefeller.edu/wli/gene/databases.html>

Links to DNA, protein, and genome databases.

Bioinformatics Resources, Bioinformatics Group, University of Waterloo, Canada

[http://wh.math.uwaterloo.ca/bioinfo\\_res.html](http://wh.math.uwaterloo.ca/bioinfo_res.html)

Links to DNA, protein, and genome databases.

The RNA World

<http://www.imb-jena.de/RNA.html>

Links to RNA-specific databases.

Amos' WWW Links

<http://www.expasy.ch/alinks.html>

Extensive lists of links to protein databases and resources.

and also see

<http://www.bioinformaticsonline.com>, a Web Site for Mount D. *Bioinformatics: Sequence and genome analysis* (Cold Spring Harbor Laboratory Press 2001)

# Appendix 12

---

## Cautions

### GENERAL CAUTIONS

---

The following general cautions should always be observed.

- Become **completely familiar** with the properties of all substances used before beginning the procedure.
- **The absence of a warning** does not necessarily mean that the material is safe, since information may not always be complete or available.
- If **exposed** to toxic substances, contact the local safety office immediately for instructions.
- **Use proper disposal procedures** for all chemical, biological, and radioactive waste.
- For specific guidelines on **appropriate gloves**, consult the local safety office.
- Handle **concentrated acids and bases** with great care. Wear goggles and appropriate gloves, as well as a face shield if handling large quantities.

Do not mix strong acids with organic solvents as they may react. Sulfuric acid and nitric acid especially may react highly exothermically and cause fires and explosions.

Do not mix strong bases with halogenated solvent as they may form reactive carbenes which can lead to explosions.

When preparing diluted solutions of acids from concentrated stocks, add acid to water (“If you do what you oughta, add acid to wata”).

- Never **pipette** solutions using mouth suction. This method is not sterile and can be dangerous. Always use a pipette aid or bulb.
- Keep **halogenated and nonhalogenated** solvents separately (e.g., mixing chloroform and acetone can cause unexpected reactions in the presence of bases). Halogenated solvents are organic solvents such as chloroform, dichloromethane, trichlorotrifluoroethane, and dichloroethane. Some nonhalogenated solvents are pentane, heptane, ethanol, methanol, benzene, toluene, *N,N*-dimethylformamide (DMF), dimethylsulfoxide (DMSO), and acetonitrile.
- **Laser radiation**, visible or invisible, can cause severe damage to the eyes and skin. Take proper precautions to prevent exposure to direct and reflected beams. Always follow manufacturers safety guidelines and consult the local safety office. For more detailed information, see caution below.
- **Flash lamps**, due to their light intensity, can be harmful to the eyes and may explode on occasion. Wear appropriate eye protection and follow the manufacturer’s guidelines.
- **Photographic fixatives and developers** contain harmful chemicals. Handle them with care and follow manufacturer’s directions.

- **Power supplies and electrophoresis equipment** pose serious fire hazard and electrical shock hazards if not used properly.
- **Microwave ovens and autoclaves** in the lab require certain precautions. If the screw top on the bottle is not loose enough, and there is not enough space for the steam to vent, the bottle can explode when the containers are removed from the microwave or autoclave. Always loosen bottle caps before microwaving or autoclaving.
- Use extreme caution when handling **cutting devices** such as microtome blades, scalpels, razor blades, or needles. Microtome blades are extremely sharp! If unfamiliar with their use, have an experienced person demonstrate proper procedures. For proper disposal, use a “sharps” disposal container in the lab. Discard used needles unshielded, with the syringe still attached. This method prevents injuries (and possible infections) while manipulating used needles since many accidents occur while trying to replace the needle shield. Injuries may also be caused by broken Pasteur pipettes, coverslips, or slides.

## GENERAL PROPERTIES OF COMMON CHEMICALS

---

The hazardous materials list can be summarized in the following categories:

- Inorganic acids, such as hydrochloric, sulfuric, nitric, or phosphoric, are colorless liquids with stinging vapors. Avoid spills on skin or clothing. Dilute spills with large amounts of water. The concentrated forms of these acids can destroy paper, textiles, and skin as well as cause serious injury to the eyes.
- Salts of heavy metals are usually colored powdered solids that dissolve in water. Many of them are potent enzyme inhibitors and therefore toxic to humans and to the environment (e.g., fish and algae).
- Most organic solvents are flammable volatile liquids. Breathing their vapors can cause nausea or dizziness. Also avoid skin contact.
- Other organic compounds, including organosulphur compounds such as mercaptoethanol or organic amines, have very unpleasant odors. Others are highly reactive and must be handled with appropriate care.
- If improperly handled, dyes and their solutions can stain not only the sample, but also skin and clothing. Some of them are also mutagenic (e.g., ethidium bromide), carcinogenic, and toxic.
- Nearly all names ending with “ase” (e.g., catalase,  $\beta$ -glucuronidase, or zymolase) refer to enzymes. There are also other enzymes with nonsystematic names like pepsin. Many of them are provided by manufacturers in preparations containing buffering substances, etc. Be aware of the individual properties of materials contained in these substances.
- Toxic compounds often used to manipulate cells (e.g., cycloheximide, actinomycin D, and rifampicin) can be dangerous and should be handled appropriately.

## HAZARDOUS MATERIALS

---

**Acetic acid (concentrated)** must be handled with great care. It may be harmful by inhalation, ingestion, or skin absorption. Wear appropriate gloves and goggles. Use in a chemical fume hood.

**Acetonitrile** is very volatile and extremely flammable. It is an irritant and a chemical asphyxiant that can exert its effects by inhalation, ingestion, or skin absorption. Treat cases of severe exposure as cyanide poisoning. Wear appropriate gloves and safety glasses. Use only in a chemical fume hood. Keep away from heat, sparks, and open flame.

**Acrylamide** (unpolymerized) is a potent neurotoxin and is absorbed through the skin (effects are cumulative). Avoid breathing the dust. Wear appropriate gloves and a face mask when weighing powdered acrylamide and methylene-bisacrylamide. Use in a chemical fume hood. Polyacrylamide is considered to be nontoxic, but it should be handled with care because it might contain small quantities of unpolymerized acrylamide.

**Actinomycin D** is a teratogen and a carcinogen. It is highly toxic and may be fatal if inhaled, ingested, or absorbed through the skin. It may also cause irritation. Avoid breathing the dust. Wear appropriate gloves and safety glasses. Always use in a chemical fume hood. Solutions of actinomycin D are light-sensitive.

**AgNO<sub>3</sub>**, *see Silver nitrate*

**$\alpha$ -Amanitin** is highly toxic and may be fatal by inhalation, ingestion, or skin absorption. Symptoms may be delayed for as long as 6–24 hours. Wear appropriate gloves and safety glasses. Always use in a chemical fume hood.

**Aminobenzoic acid** may be harmful by inhalation, ingestion, or skin absorption. Wear appropriate gloves and safety glasses.

**Ammonium acetate**, H<sub>3</sub>CCOONH<sub>4</sub>, may be harmful by inhalation, ingestion, or skin absorption. Wear appropriate gloves and safety glasses. Use in a chemical fume hood.

**Ammonium chloride**, NH<sub>4</sub>Cl, may be harmful by inhalation, ingestion, or skin absorption. Wear appropriate gloves and safety glasses. Use in a chemical fume hood.

**Ammonium formate**, *see Formic acid*

**Ammonium hydroxide**, NH<sub>4</sub>OH, is a solution of ammonia in water. It is caustic and should be handled with great care. As ammonia vapors escape from the solution, they are corrosive, toxic, and can be explosive. Use only with mechanical exhaust. Wear appropriate gloves. Use only in a chemical fume hood.

**Ammonium molybdate**, (NH<sub>4</sub>)<sub>6</sub>Mo<sub>7</sub>O<sub>24</sub>•4H<sub>2</sub>O (or its **tetrahydrate**) may be harmful by inhalation, ingestion, or skin absorption. Wear appropriate gloves and safety glasses. Use in a chemical fume hood.

**Ammonium persulfate**, (NH<sub>4</sub>)<sub>2</sub>S<sub>2</sub>O<sub>8</sub>, is extremely destructive to tissue of the mucous membranes and upper respiratory tract, eyes, and skin. Inhalation may be fatal. Wear appropriate gloves, safety glasses, and protective clothing. Always use in a chemical fume hood. Wash thoroughly after handling.

**Ammonium sulfate**, (NH<sub>4</sub>)<sub>2</sub>SO<sub>4</sub>, may be harmful by inhalation, ingestion, or skin absorption. Wear appropriate gloves and safety glasses.

**Ampicillin** may be harmful by inhalation, ingestion, or skin absorption. Wear appropriate gloves and safety glasses. Use in a chemical fume hood.

**Aprotinin** may be harmful by inhalation, ingestion, or skin absorption. It may also cause allergic reactions. Exposure may cause gastrointestinal effects, muscle pain, blood pressure changes, or bronchospasm. Wear appropriate gloves and safety glasses. Do not breathe the dust. Use only in a chemical fume hood.

**Arc lamps** are potentially explosive. Follow manufacturer's guidelines. When turning on arc lamps, make sure nearby computers are turned off to avoid damage from electromagnetic wave components. Computers may be restarted once the arc lamps are in operation.

**Aspartic acid** is a possible mutagen and poses a risk of irreversible effects. It may be harmful by inhalation, ingestion, or skin absorption. Wear appropriate gloves and safety glasses. Use in a chemical fume hood. Do not breathe the dust.

**Bacterial strains** (shipping of): The Department of Health, Education, and Welfare (HEW) has classified various bacteria into different categories with regard to shipping requirements (please see Sanderson and Zeigler, *Methods Enzymol.* 204: 248–264 [1991] or the instruction brochure by Alexander and Brandon (*Packaging and Shipping of Biological Materials at ATCC* [1986] available from the American Type Culture Collection [ATCC], Rockville, Maryland). Nonpathogenic strains of *Escherichia coli* (such as K-12) and *Bacillus subtilis* are in Class 1 and are considered to present no or minimal hazard under normal shipping conditions. However, *Salmonella*, *Haemophilus*, and certain strains of *Streptomyces* and *Pseudomonas* are in Class 2. Class 2 bacteria are "Agents of ordinary potential hazard: agents which produce disease of varying degrees of severity...but which are contained by ordinary laboratory techniques."

**BCIG**, see **5-Bromo-4-chloro-3-indolyl- $\beta$ -D-galactopyranoside**

**Biotin** may be harmful by inhalation, ingestion, or skin absorption. Wear appropriate gloves and safety glasses. Use in a chemical fume hood.

**Bisacrylamide** is a potent neurotoxin and is absorbed through the skin (the effects are cumulative). Avoid breathing the dust. Wear appropriate gloves and a face mask when weighing powdered acrylamide and methylene-bisacrylamide.

**Blood (human) and blood products and Epstein-Barr virus.** Human blood, blood products, and tissues may contain occult infectious materials such as hepatitis B virus and HIV that may result in laboratory-acquired infections. Investigators working with EBV-transformed lymphoblast cell lines are also at risk of EBV infection. Any human blood, blood products, or tissues should be considered a biohazard and be handled accordingly. Wear disposable appropriate gloves, use mechanical pipetting devices, work in a biological safety cabinet, protect against aerosol generation, and disinfect all waste materials before disposal. Autoclave contaminated plasticware before disposal; autoclave contaminated liquids or treat with bleach (10% [v/v] final concentration) for at least 30 minutes before disposal. Consult the local institutional safety officer for specific handling and disposal procedures.

**Boric acid**,  $H_3BO_3$ , may be harmful by inhalation, ingestion, or skin absorption. Wear appropriate gloves and goggles.

**5-Bromo-4-chloro-3-indolyl- $\beta$ -D-galactopyranoside (BCIG; X-gal)** is toxic to the eyes and skin and may be harmful by inhalation, ingestion, or skin absorption. Wear appropriate gloves and safety goggles.

**Bromophenol blue** may be harmful by inhalation, ingestion, or skin absorption. Wear appropriate gloves and safety glasses. Use in a chemical fume hood.

**n-Butanol** is irritating to the mucous membranes, upper respiratory tract, skin, and especially the eyes. Avoid breathing the vapors. Wear appropriate gloves and safety glasses. Use in a chemical fume hood. n-Butanol is also highly flammable. Keep away from heat, sparks, and open flame.

**Cacodylate** contains arsenic, is highly toxic, and may be fatal if inhaled, ingested, or absorbed through the skin. It is a possible carcinogen and may be mutagenic. Wear appropriate gloves and safety glasses. Use in a chemical fume hood.

**Cacodylic acid** is toxic and a possible carcinogen. It may be mutagenic and is harmful by inhalation, ingestion, or skin absorption. Wear appropriate gloves and safety glasses. Use only in a chemical fume hood. Do not breathe the dust.

**Carbenicillin** may cause sensitization by inhalation, ingestion, or skin absorption. Wear appropriate gloves and safety glasses.

**Carbon dioxide, CO<sub>2</sub>**, in all forms may be fatal by inhalation, ingestion, or skin absorption. In high concentrations, it can paralyze the respiratory center and cause suffocation. Use only in well-ventilated areas. In the form of dry ice, contact with carbon dioxide can also cause frostbite. Do not place large quantities of dry ice in enclosed areas such as cold rooms. Wear appropriate gloves and safety goggles.

**Cesium chloride, CsCl**, may be harmful by inhalation, ingestion, or skin absorption. Wear appropriate gloves and safety glasses.

**Cetylpyridinium bromide (CPB)** causes severe irritation to the eyes, skin, and respiratory tract. Wear appropriate gloves and safety glasses. Use in a chemical fume hood.

**Cetyltrimethylammonium bromide (CTAB)** is toxic and an irritant and may be harmful by inhalation, ingestion, or skin absorption. Wear appropriate gloves and safety glasses. Avoid breathing the dust.

**CH<sub>3</sub>CH<sub>2</sub>OH**, *see* Ethanol

**C<sub>6</sub>H<sub>5</sub>CH<sub>2</sub>SO<sub>2</sub>F**, *see* Phenylmethylsulfonyl fluoride

**CHCl<sub>3</sub>**, *see* Chloroform

**C<sub>7</sub>H<sub>7</sub>FO<sub>2</sub>S**, *see* Phenylmethylsulfonyl fluoride

**Chloramphenicol** may be harmful by inhalation, ingestion, or skin absorption and is a carcinogen. Wear appropriate gloves and safety glasses. Use in a chemical fume hood.

**Chloroform, CHCl<sub>3</sub>**, is irritating to the skin, eyes, mucous membranes, and respiratory tract. It is a carcinogen and may damage the liver and kidneys. It is also volatile. Avoid breathing the vapors. Wear appropriate gloves and safety glasses. Always use in a chemical fume hood.

**Citric acid** is an irritant and may be harmful by inhalation, ingestion, or skin absorption. It poses a risk of serious damage to the eyes. Wear appropriate gloves and safety goggles. Do not breathe the dust.

**CO<sub>2</sub>**, *see* Carbon dioxide

**Cobalt chloride, CoCl<sub>2</sub>**, may be harmful by inhalation, ingestion, or skin absorption. Wear appropriate gloves and safety glasses.

**CoCl<sub>2</sub>**, *see* Cobalt chloride

**Coomassie Brilliant Blue** may be harmful by inhalation, ingestion, or skin absorption. Wear appropriate gloves and safety glasses.

**Copper sulfate, CuSO<sub>4</sub>**, may be harmful by inhalation or ingestion. Wear appropriate gloves and safety glasses.

**CPB**, *see* Cetylpyridinium bromide

***m*-Cresol** may be fatal if inhaled, ingested, or absorbed through the skin. It may also cause burns and is extremely destructive to the eyes, skin, mucus membranes, and upper respiratory tract. Wear appropriate gloves and safety glasses. Use in a chemical fume hood.

**CsCl**, *see* Cesium chloride

**CTAB**, *see* Cetyltrimethylammonium bromide

**CuSO<sub>4</sub>**, *see* Copper sulfate

**Cysteine** is an irritant to the eyes, skin, and respiratory tract. It may be harmful by inhalation, ingestion, or skin absorption. Wear appropriate gloves and safety glasses. Do not breathe the dust.

**DEAE**, *see* Diethylaminoethanol

**DEPC**, *see* Diethyl pyrocarbonate

**Dichloromethylsilane**, *see* Dichlorosilane



**Dichlorosilane** is highly flammable and toxic and may be fatal if inhaled. It is harmful by inhalation, ingestion, or skin absorption. Wear appropriate gloves and safety goggles. Use only in a chemical fume hood. It reacts violently with water. Keep away from heat, sparks, and open flame. Take precautionary measures against static discharges.

**Diethylamine,  $\text{NH}(\text{C}_2\text{H}_5)_2$** , is corrosive, toxic, and extremely flammable. It may be harmful by inhalation, ingestion, or skin absorption. Wear appropriate gloves and safety glasses. Use only in a chemical fume hood. Keep away from heat, sparks, and open flame.

**Diethylaminoethanol (DEAE)** may be harmful by inhalation, ingestion, or skin absorption. Wear appropriate gloves and safety glasses. Use in a chemical fume hood.

**Diethyl ether,  $\text{Et}_2\text{O}$  or  $(\text{C}_2\text{H}_5)_2\text{O}$** , is extremely volatile and flammable. It is irritating to the eyes, mucous membranes, and skin. It is also a CNS depressant with anesthetic effects. It may be harmful by inhalation, ingestion, or skin absorption. Avoid breathing the vapors. Wear appropriate gloves and safety glasses. Always use in a chemical fume hood. Explosive peroxides can form during storage or on exposure to air or direct sunlight. Keep away from heat, sparks, and open flame.

**Diethyl pyrocarbonate (DEPC)** is a potent protein denaturant and is a suspected carcinogen. Aim bottle away from you when opening it; internal pressure can lead to splattering. Wear appropriate gloves and lab coat. Use in a chemical fume hood.

**Diethyl sulfate (DES),  $(\text{C}_2\text{H}_5)_2\text{SO}_4$** , is a mutagen and suspected carcinogen. It is also volatile. Avoid breathing the vapors. Wear appropriate gloves. Use in a chemical fume hood. Use screw-cap tubes for all DES-treated cultures and mechanical pipettors to manipulate DES solutions. Dispose of all DES-treated cultures in bleach.

***N,N*-Dimethylformamide (DMF),  $\text{HCON}(\text{CH}_3)_2$** , is irritating to the eyes, skin, and mucous membranes. It can exert its toxic effects through inhalation, ingestion, or skin absorption. Chronic inhalation can cause liver and kidney damage. Wear appropriate gloves and safety glasses. Use in a chemical fume hood.

**Dimethylsulfate (DMS),  $(\text{CH}_3)_2\text{SO}_4$** , is extremely toxic and is a carcinogen. Avoid breathing the vapors. Wear appropriate gloves and safety glasses. Use only in a chemical fume hood. Dispose of solutions containing dimethylsulfate by pouring them slowly into a solution of sodium hydroxide or ammonium hydroxide and allowing them to sit overnight in the chemical fume hood. Contact the local safety office before re-entering the lab to clean up a spill.

**Dimethylsulfoxide (DMSO)** may be harmful by inhalation or skin absorption. Wear appropriate gloves and safety glasses. Use in a chemical fume hood. DMSO is also combustible. Store in a tightly closed container. Keep away from heat, sparks, and open flame.

**Dinitrophenol (DNP)** may be fatal by inhalation, ingestion, or skin absorption. Wear appropriate gloves and safety glasses. Use only in a chemical fume hood.

**Diphenyloxazole (PPO)** may be carcinogenic. It may be harmful by inhalation, ingestion, or skin absorption. Wear appropriate gloves and safety glasses. Consult the local institutional safety officer for specific handling and disposal procedures.

**Disodium citrate**, *see* Citric acid

**Dithiothreitol (DTT)** is a strong reducing agent that emits a foul odor. It may be harmful by inhalation, ingestion, or skin absorption. When working with the solid form or highly concentrated stocks, wear appropriate gloves and safety glasses. Use in a chemical fume hood.

**DMF**, *see* *N,N*-Dimethylformamide

**DMS**, *see* Dimethylsulfate

**DMSO**, *see* Dimethylsulfoxide

**DNP**, *see* Dinitrophenol

**Dry ice**, *see* Carbon dioxide

**DTT**, *see* **Dithiothreitol**

**EDC**, *see* **N-Ethyl-N'-(dimethylaminopropyl)-carbodiimide**

**EMS**, *see* **Ethyl methane sulfonate**

**Ethanol (EtOH)**,  $\text{CH}_3\text{CH}_2\text{OH}$ , may be harmful by inhalation, ingestion, or skin absorption. Wear appropriate gloves and safety glasses.

**Ethanolamine**,  $\text{HOCH}_2\text{CH}_2\text{NH}_2$ , is toxic and harmful by inhalation, ingestion, or skin absorption. Handle with care and avoid any contact with the skin. Wear appropriate gloves and goggles. Use in a chemical fume hood. Ethanolamine is highly corrosive and reacts violently with acids.

**Ether**, *see* **Diethyl ether**

**Ethidium bromide** is a powerful mutagen and is toxic. Consult the local institutional safety officer for specific handling and disposal procedures. Avoid breathing the dust. Wear appropriate gloves when working with solutions that contain this dye.

**Ethyl acetate** may be fatal by ingestion and harmful by inhalation or skin absorption. Wear appropriate gloves and safety goggles. Do not breathe the dust. Use in a well-ventilated area.

**N-Ethyl-N'-(dimethylaminopropyl)-carbodiimide (EDC)** is irritating to the mucus membranes and upper respiratory tract. It may be harmful by inhalation, ingestion, or skin absorption. Wear appropriate gloves and safety glasses. Handle with care.

**Ethyl methane sulfonate (EMS)** is a volatile organic solvent that is a mutagen and carcinogen. It is harmful if inhaled, ingested, or absorbed through the skin. Discard supernatants and washes containing EMS in a beaker containing 50% sodium thiosulfate. Decontaminate all material that has come in contact with EMS by treatment in a large volume of 10% (w/v) sodium thiosulfate. Use extreme caution when handling. When using undiluted EMS, wear protective appropriate gloves and use in a chemical fume hood. Store EMS in the cold. DO NOT mouth pipette EMS. Pipettes used with undiluted EMS should not be too warm; chill them in the refrigerator before use to minimize the volatility of EMS. All glassware coming in contact with EMS should be immersed in a large beaker of 1 N NaOH or laboratory bleach before recycling or disposal.

**EtOH**, *see* **Ethanol**

**FeCl<sub>3</sub>**, *see* **Ferric chloride**

**Ferric chloride**,  $\text{FeCl}_3$ , may be harmful by inhalation, ingestion, or skin absorption. Wear appropriate gloves and safety glasses. Use only in a chemical fume hood.

**Formaldehyde**,  $\text{HCOH}$ , is highly toxic and volatile. It is also a carcinogen. It is readily absorbed through the skin and is irritating or destructive to the skin, eyes, mucous membranes, and upper respiratory tract. Avoid breathing the vapors. Wear appropriate gloves and safety glasses. Always use in a chemical fume hood. Keep away from heat, sparks, and open flame.

**Formamide** is teratogenic. The vapor is irritating to the eyes, skin, mucous membranes, and upper respiratory tract. It may be harmful by inhalation, ingestion, or skin absorption. Wear appropriate gloves and safety glasses. Always use in a chemical fume hood when working with concentrated solutions of formamide. Keep working solutions covered as much as possible.

**Formic acid**,  $\text{HCOOH}$ , is highly toxic and extremely destructive to tissue of the mucous membranes, upper respiratory tract, eyes, and skin. It may be harmful by inhalation, ingestion, or skin absorption. Wear appropriate gloves and safety glasses (or face shield) and use in a chemical fume hood.

**$\beta$ -Galactosidase** is an irritant and may cause allergic reactions. It may be harmful by inhalation, ingestion, or skin absorption. Wear appropriate gloves and safety glasses.

**Giemsa** may be fatal or cause blindness by ingestion and is toxic by inhalation and skin absorption. There is a possible risk of irreversible effects. Wear appropriate gloves and safety goggles. Use only in a chemical fume hood. Do not breathe the dust.

**Glassware, pressurized** must be used with extreme caution. Handle glassware under vacuum, such as desiccators, vacuum traps, drying equipment, or a reactor for working under argon atmosphere, with appropriate caution. Always wear safety glasses.

**Glass wool** may be harmful by inhalation and may cause skin irritation. Wear appropriate gloves and mask.

**Glutaraldehyde** is toxic. It is readily absorbed through the skin and is irritating or destructive to the skin, eyes, mucous membranes, and upper respiratory tract. Wear appropriate gloves and safety glasses. Always use in a chemical fume hood.

**Glycine** may be harmful by inhalation, ingestion, or skin absorption. Wear gloves and safety glasses. Avoid breathing the dust.

**Guanidine hydrochloride** is irritating to the mucous membranes, upper respiratory tract, skin, and eyes. It may be harmful by inhalation, ingestion, or skin absorption. Wear appropriate gloves and safety glasses. Avoid breathing the dust.

**Guanidine thiocyanate** may be harmful by inhalation, ingestion, or skin absorption. Wear appropriate gloves and safety glasses.

**Guanidinium hydrochloride**, *see* **Guanidine hydrochloride**

**Guanidinium isothiocyanate**, *see* **Guanidine thiocyanate**

**Guanidinium thiocyanate**, *see* **Guanidine thiocyanate**

$\text{H}_3\text{BO}_3$ , *see* **Boric acid**

$\text{H}_3\text{CCOONH}_4$ , *see* **Ammonium acetate**

$\text{HCl}$ , *see* **Hydrochloric acid**

$\text{HCOH}$ , *see* **Formaldehyde**

$\text{H}_3\text{COH}$ , *see* **Methanol**

$\text{HCON}(\text{CH}_3)_2$ , *see* **Dimethylformamide**

$\text{HCOOH}$ , *see* **Formic acid**

**Heptane** may be harmful by inhalation, ingestion, or skin absorption. Wear appropriate gloves and safety glasses. It is extremely flammable. Keep away from heat, sparks, and open flame.

$\text{HNO}_3$ , *see* **Nitric acid**

$\text{H}_2\text{O}_2$ , *see* **Hydrogen peroxide**

$\text{HOCH}_2\text{CH}_2\text{NH}_2$ , *see* **Ethanolamine**

$\text{HOCH}_2\text{CH}_2\text{SH}$ , *see*  $\beta$ -**Mercaptoethanol**

$\text{H}_3\text{PO}_2$ , *see* **Hypophosphorous acid**

$\text{H}_3\text{PO}_4$ , *see* **Phosphoric acid (concentrated)**

$\text{H}_2\text{S}$ , *see* **Hydrogen sulfide**

$\text{H}_2\text{SO}_4$ , *see* **Sulfuric acid**

**Hydrazine**,  $\text{N}_2\text{H}_4$ , is highly toxic and explosive in the anhydrous state. It may be harmful by inhalation, ingestion, or skin absorption. Avoid breathing the vapors. Wear appropriate gloves, goggles, and protective clothing. Use only in a chemical fume hood. Dispose of solutions containing hydrazine in accordance with MSDS recommendations. Keep away from heat, sparks, and open flame.

**Hydrochloric acid**,  $\text{HCl}$ , is volatile and may be fatal if inhaled, ingested, or absorbed through the skin. It is extremely destructive to mucous membranes, upper respiratory tract, eyes, and skin. Wear appropriate gloves and safety glasses. Use with great care in a chemical fume hood. Wear goggles when handling large quantities.

**Hydrogen peroxide,  $H_2O_2$** , is corrosive, toxic, and extremely damaging to the skin. It may be harmful by inhalation, ingestion, and skin absorption. Wear appropriate gloves and safety glasses. Use only in a chemical fume hood.

**Hydrogen sulfide,  $H_2S$** , is an extremely toxic gas that causes paralysis of the respiratory center. It is irritating and corrosive to tissues and may cause olfactory fatigue. Do not rely on odor to detect its presence. Take great care when handling it. Keep  $H_2S$  tanks in a chemical fume hood or in a room equipped with appropriate ventilation. Wear appropriate gloves and safety glasses. It is also very flammable. Keep away from heat, sparks, and open flame.

**N-Hydroxysuccinimide** is an irritant and may be harmful by inhalation, ingestion, or skin absorption. Wear appropriate gloves and safety glasses.

**Hygromycin B** is highly toxic and may be fatal if inhaled, ingested, or absorbed through the skin. Wear appropriate gloves and safety goggles. Use only in a chemical fume hood. Do not breathe the dust.

**Hypophosphorous acid,  $H_3PO_2$** , is usually supplied as a 50% solution, which is corrosive and should be handled with care. It should be freshly diluted immediately before use. Wear appropriate gloves and safety glasses. Use in a chemical fume hood.

**Inositol** may be harmful by inhalation, ingestion, or skin absorption. Wear appropriate gloves and safety glasses.

**IPTG**, *see* **Isopropyl- $\beta$ -D-thiogalactopyranoside**

**Isoamyl alcohol** may be harmful by inhalation, ingestion, or skin absorption and presents a risk of serious damage to the eyes. Wear appropriate gloves and safety goggles. Keep away from heat, sparks, and open flame.

**Isobutanol**, *see* **Isobutyl alcohol**

**Isobutyl alcohol (Isobutanol)** is extremely flammable and may be harmful by inhalation or ingestion. Wear appropriate gloves and safety glasses. Keep away from heat, sparks, and open flame.

**Isopropanol** is irritating and may be harmful by inhalation, ingestion, or skin absorption. Wear appropriate gloves and safety glasses. Do not breathe the vapor. Keep away from heat, sparks, and open flame.

**Isopropyl- $\beta$ -D-thiogalactopyranoside (IPTG)** may be harmful by inhalation, ingestion, or skin absorption. Wear appropriate gloves and safety glasses.

**Isotope  $^{125}I$**  accumulates in the thyroid and is a potential health hazard. Consult the local radiation safety office for further guidance in the appropriate use and disposal of radioactive materials. Wear appropriate gloves when handling radioactive substances. The  $^{125}I_2$  formed during oxidation of  $Na^{125}I$  is volatile. Work in an approved chemical fume hood with a charcoal filter when exposing the  $Na^{125}I$  to oxidizing reagents such as chloramine-T, IODO-GEN, or acids. Because the oxidation proceeds very rapidly and releases large amounts of volatile  $^{125}I_2$  when chloramine-T is used, it is important to be well prepared for each step of the reaction, so that the danger of contamination from volatile radiation can be minimized. Shield all forms of the isotope with lead. When handling the isotope, wear one or two pairs of appropriate gloves, depending on the amount of isotope being used and the difficulty of the manipulation required.

**KCl**, *see* **Potassium chloride**

**$K_3Fe(CN)_6$** , *see* **Potassium ferricyanide**

**$K_4Fe(CN)_6 \cdot 3H_2O$** , *see* **Potassium ferrocyanide**

**$KH_2PO_4/K_2HPO_4/K_3PO_4$** , *see* **Potassium phosphate**

**$KMnO_4$** , *see* **Potassium permanganate**

**KOH**, *see* **Potassium hydroxide**

**Laser radiation**, both visible and invisible, can be seriously harmful to the eyes and skin and may generate airborne contaminants, depending on the class of laser used. High-power lasers produce perma-

ment eye damage, can burn exposed skin, ignite flammable materials, and activate toxic chemicals that release hazardous by-products. Avoid eye or skin exposure to direct or scattered radiation. Do not stare at the laser and do not point the laser at someone else. Wear appropriate eye protection and use suitable shields that are designed to offer protection for the specific type of wavelength, mode of operation (continuous wave or pulsed), and power output (watts) of the laser being used. Avoid wearing jewelry or other objects that may reflect or scatter the beam. Some non-beam hazards include electrocution, fire, and asphyxiation. Entry to the area in which the laser is being used must be controlled and posted with warning signs that indicate when the laser is in use. Always follow suggested safety guidelines that accompany the equipment and contact your local safety office for further information.

**LiCl**, *see* **Lithium chloride**

**Liquid nitrogen** can cause severe damage due to extreme temperature. Handle frozen samples with extreme caution. Do not breathe the vapors. Seepage of liquid nitrogen into frozen vials can result in an exploding tube upon removal from liquid nitrogen. Use vials with O-rings when possible. Wear cryo-mitts and a face mask.

**Lithium chloride, LiCl**, is an irritant to the eyes, skin, mucous membranes, and upper respiratory tract. It may be harmful by inhalation, ingestion, or skin absorption. Wear appropriate gloves and safety goggles. Use in a chemical fume hood. Do not breathe the dust.

**Lysozyme** is caustic to mucus membranes. Wear appropriate gloves and safety glasses.

**Magnesium chloride, MgCl<sub>2</sub>**, may be harmful by inhalation, ingestion, or skin absorption. Wear appropriate gloves and safety glasses. Use in a chemical fume hood.

**Magnesium sulfate, MgSO<sub>4</sub>**, may be harmful by inhalation, ingestion, or skin absorption. Wear appropriate gloves and safety glasses. Use in a chemical fume hood.

**Manganese chloride, MnCl<sub>2</sub>**, may be harmful by inhalation, ingestion, or skin absorption. Wear appropriate gloves and safety glasses. Use in a chemical fume hood.

**MeOH or H<sub>3</sub>COH**, *see* **Methanol**

**β-Mercaptoethanol (2-Mercaptoethanol), HOCH<sub>2</sub>CH<sub>2</sub>SH**, may be fatal if inhaled or absorbed through the skin and is harmful if ingested. High concentrations are extremely destructive to the mucous membranes, upper respiratory tract, skin, and eyes. β-Mercaptoethanol has a very foul odor. Wear appropriate gloves and safety glasses. Always use in a chemical fume hood.

**MES**, *see* **2-[N-morpholino]ethanesulfonic acid**

**Methanol, MeOH or H<sub>3</sub>COH**, is poisonous and can cause blindness. It may be harmful by inhalation, ingestion, or skin absorption. Adequate ventilation is necessary to limit exposure to vapors. Avoid inhaling these vapors. Wear appropriate gloves and goggles. Use only in a chemical fume hood.

**Methotrexate (MTX)** is a carcinogen and a teratogen. It may be harmful by inhalation, ingestion, or skin absorption. Exposure may cause gastrointestinal effects, bone marrow suppression, liver or kidney damage. It may also cause irritation. Avoid breathing the vapors. Wear appropriate gloves and safety glasses. Always use in a chemical fume hood.

**N,N'-Methylenebisacrylamide** is a poison and may effect the central nervous system. It may be harmful by inhalation, ingestion, or skin absorption. Wear appropriate gloves and safety glasses. Do not breathe the dust.

**Methylene blue** is irritating to the eyes and skin. It may be harmful by inhalation, ingestion, or skin absorption. Wear appropriate gloves and safety glasses.

**Methylmercuric hydroxide** is extremely toxic and may be harmful by inhalation, ingestion, or skin absorption. It is also volatile. Therefore, carry out all manipulations of solutions containing concentrations of methylmercuric hydroxide in excess of 10<sup>-2</sup> M in a chemical fume hood and wear appropriate gloves when handling such solutions. Treat all solid and liquid wastes as toxic materials and dispose of in accordance with MSDS recommendations.

**MgCl<sub>2</sub>**, *see* Magnesium chloride

**MgSO<sub>4</sub>**, *see* Magnesium sulfate

**2-[N-morpholino]ethanesulfonic acid (MES)** may be harmful by inhalation, ingestion, or skin absorption. Wear appropriate gloves and safety glasses.

**3-(N-Morpholino)-propanesulfonic acid (MOPS)** may be harmful by inhalation, ingestion, or skin absorption. It is irritating to mucous membranes and upper respiratory tract. Wear appropriate gloves and safety glasses. Use in a chemical fume hood.

**MnCl<sub>2</sub>**, *see* Manganese chloride

**MOPS**, *see* 3-(N-Morpholino)-propanesulfonic acid

**MTX**, *see* Methotrexate

**NaF**, *see* Sodium fluoride

**Na<sub>2</sub>HPO<sub>4</sub>**, *see* Sodium hydrogen phosphate

**NaN<sub>3</sub>**, *see* Sodium azide

**NaNO<sub>3</sub>**, *see* Sodium nitrate

**NaOH**, *see* Sodium hydroxide

**N<sub>2</sub>H<sub>4</sub>**, *see* Hydrazine

**NH<sub>4</sub>Cl**, *see* Ammonium chloride

**(NH<sub>4</sub>)<sub>6</sub>Mo<sub>7</sub>O<sub>24</sub>·4H<sub>2</sub>O**, *see* Ammonium molybdate

**NH<sub>4</sub>OH**, *see* Ammonium hydroxide

**(NH<sub>4</sub>)<sub>2</sub>SO<sub>4</sub>**, *see* Ammonium sulfate

**(NH<sub>4</sub>)<sub>2</sub>S<sub>2</sub>O<sub>8</sub>**, *see* Ammonium persulfate

**Nickel sulfate, NiSO<sub>4</sub>** is a carcinogen and may cause heritable genetic damage. It is a skin irritant and may be harmful by inhalation, ingestion, or skin absorption. Wear appropriate gloves and safety glasses. Use in a chemical fume hood. Do not breathe the dust.

**NiSO<sub>4</sub>**, *see* Nickel sulfate

**Nitric acid, HNO<sub>3</sub>** is volatile and must be handled with great care. It is toxic by inhalation, ingestion, and skin absorption. Wear appropriate gloves and safety goggles. Use in a chemical fume hood. Do not breathe the vapors. Keep away from heat, sparks, and open flame.

**PEG**, *see* Polyethyleneglycol

**Perchloric acid** may be fatal by inhalation, ingestion, or skin absorption. Wear appropriate gloves and safety glasses. Use only in a chemical fume hood.

**Phenol** is extremely toxic, highly corrosive, and can cause severe burns. It may be harmful by inhalation, ingestion, or skin absorption. Wear appropriate gloves, goggles, and protective clothing. Always use in a chemical fume hood. Rinse any areas of skin that come in contact with phenol with a large volume of water and wash with soap and water; do not use ethanol!

**Phenylmethylsulfonyl fluoride (PMSF), C<sub>7</sub>H<sub>7</sub>FO<sub>2</sub>S or C<sub>6</sub>H<sub>5</sub>CH<sub>2</sub>SO<sub>2</sub>F** is a highly toxic cholinesterase inhibitor. It is extremely destructive to the mucous membranes of the respiratory tract, eyes, and skin. It may be fatal by inhalation, ingestion, or skin absorption. Wear appropriate gloves and safety glasses. Always use in a chemical fume hood. In case of contact, immediately flush eyes or skin with copious amounts of water and discard contaminated clothing.

**Phosphoric acid, H<sub>3</sub>PO<sub>4</sub>** is highly corrosive and may be harmful by inhalation, ingestion, or skin absorption. Wear appropriate gloves and safety glasses.

**Piperidine** is highly toxic and is corrosive to the eyes, skin, respiratory tract, and gastrointestinal tract. It reacts violently with acids and oxidizing agents and may be harmful by inhalation, ingestion, or skin absorption. Do not breathe the vapors. Keep away from heat, sparks, and open flame. Wear appropriate gloves and safety glasses. Use in a chemical fume hood.

**PMSE**, *see* **Phenylmethylsulfonyl fluoride**

**Polyacrylamide** is considered to be nontoxic, but it should be treated with care because it may contain small quantities of unpolymerized material (*see* **Acrylamide**).

**Polyethyleneglycol (PEG)** may be harmful by inhalation, ingestion, or skin absorption. Avoid inhalation of powder. Wear appropriate gloves and safety glasses.

**Polyvinylpyrrolidone** may be harmful by inhalation, ingestion, or skin absorption. Wear appropriate gloves and safety glasses. Use in a chemical fume hood.

**Potassium cacodylate**, *see* **Cacodylate**

**Potassium chloride, KCl**, may be harmful by inhalation, ingestion, or skin absorption. Wear appropriate gloves and safety glasses.

**Potassium ferricyanide,  $K_3Fe(CN)_6$** , may be fatal by inhalation, ingestion, or skin absorption. Wear appropriate gloves and safety glasses. Always use with extreme care in a chemical fume hood. Keep away from strong acids.

**Potassium ferrocyanide,  $K_4Fe(CN)_6 \cdot 3H_2O$** , may be fatal by inhalation, ingestion, or skin absorption. Wear appropriate gloves and safety glasses. Always use with extreme care in a chemical fume hood. Keep away from strong acids.

**Potassium hydroxide, KOH and KOH/methanol**, can be highly toxic. It may be harmful by inhalation, ingestion, or skin absorption. Solutions are caustic and should be handled with great care. Wear appropriate gloves.

**Potassium permanganate,  $KMnO_4$** , is an irritant and a strong oxidant. It may form explosive mixtures when mixed with organics. Use all solutions in a chemical fume hood. Do not mix with hydrochloric acid.

**Potassium phosphate,  $KH_2PO_4/K_2HPO_4/K_3PO_4$** , may be harmful by inhalation, ingestion, or skin absorption. Wear appropriate gloves and safety glasses. Do not breathe the dust.  $K_2HPO_4 \cdot 3H_2O$  is *dibasic* and  $KH_2PO_4$  is *monobasic*.

**PPO**, *see* **Diphenyloxazole**

**Probe DNA or RNA**, *see* **Radioactive substances**

**Proteinase K** is an irritant and may be harmful by inhalation, ingestion, or skin absorption. Wear appropriate gloves and safety glasses.

**Putrescine** is flammable and corrosive and may be harmful by inhalation, ingestion, or skin absorption. Wear appropriate gloves and safety glasses. Keep away from heat, sparks, and open flame.

**Radioactive substances:** When planning an experiment that involves the use of radioactivity, consider the physico-chemical properties of the isotope (half-life, emission type, and energy), the chemical form of the radioactivity, its radioactive concentration (specific activity), total amount, and its chemical concentration. Order and use only as much as needed. Always wear appropriate gloves, lab coat, and safety goggles when handling radioactive material. **X-rays** and **gamma rays** are electromagnetic waves of very short wavelengths either generated by technical devices or emitted by radioactive materials. They might be emitted isotropically from the source or may be focused into a beam. Their potential dangers depend on the time period of exposure, the intensity experienced, and the wavelengths used. Be aware that appropriate shielding is usually made of lead or other similar material. The thickness of the shielding is determined by the energy(s) of the X-rays or gamma rays. Consult the local safety office for further guidance in the appropriate use and disposal of radioactive materials. Always

monitor thoroughly after using radioisotopes. A convenient calculator to perform routine radioactivity calculations can be found at:

<http://www.graphpad.com/calculators/radcalc.cfm>

**S-Adenosylmethionine** is toxic and may be harmful by inhalation, ingestion, or skin absorption. Wear appropriate gloves and safety glasses. Use in a chemical fume hood. Do not breathe the dust.

**SDS**, *see* **Sodium dodecyl sulfate**

**Silane** may be harmful by inhalation, ingestion, or skin absorption. It is extremely flammable. Keep away from heat, sparks, and open flame. The vapor is irritating to the eyes, skin, mucous membranes, and upper respiratory tract. Wear appropriate gloves and safety glasses. Always use in a chemical fume hood.

**Silica** is an irritant and may be harmful by inhalation, ingestion, or skin absorption. Wear appropriate gloves and safety glasses. Do not breathe the dust.

**Silver nitrate, AgNO<sub>3</sub>**, is a strong oxidizing agent and should be handled with care. It may be harmful by inhalation, ingestion, or skin absorption. Avoid contact with skin. Wear appropriate gloves and safety glasses. It can cause explosions upon contact with other materials.

**Sodium acetate**, *see* **Acetic acid**

**Sodium azide, NaN<sub>3</sub>**, is highly poisonous. It blocks the cytochrome electron transport system. Solutions containing sodium azide should be clearly marked. It may be harmful by inhalation, ingestion, or skin absorption. Wear appropriate gloves and safety goggles and handle it with great care.

**Sodium cacodylate** may be carcinogenic and contains arsenic. It is highly toxic and may be fatal by inhalation, ingestion, or skin absorption. It also may cause harm to the unborn child. Effects of contact or inhalation may be delayed. Do not breathe the dust. Wear appropriate gloves and safety goggles. Use only in a chemical fume hood. *See also* **Cacodylate**.

**Sodium citrate**, *see* **Citric acid**

**Sodium dodecyl sulfate (SDS)** is toxic, an irritant, and poses a risk of severe damage to the eyes. It may be harmful by inhalation, ingestion, or skin absorption. Wear appropriate gloves and safety goggles. Do not breathe the dust.

**Sodium fluoride, NaF**, is highly toxic and causes severe irritation. It may be fatal by inhalation, ingestion, or skin absorption. Wear appropriate gloves and safety glasses. Use only in a chemical fume hood.

**Sodium hydrogen phosphate, Na<sub>2</sub>HPO<sub>4</sub>**, (**sodium phosphate, dibasic**) may be harmful by inhalation, ingestion, or skin absorption. Wear appropriate gloves and safety glasses. Use in a chemical fume hood.

**Sodium hydroxide, NaOH, and solutions containing NaOH** are highly toxic and caustic and should be handled with great care. Wear appropriate gloves and a face mask. All concentrated bases should be handled in a similar manner.

**Sodium nitrate, NaNO<sub>2</sub>**, is irritating to the eyes, mucous membranes, upper respiratory tract, and skin. It may be harmful by inhalation, ingestion, or skin absorption. Wear appropriate gloves and safety glasses and always use in a chemical fume hood. Keep away from acids.

**Sodium nitrate, NaNO<sub>3</sub>**, may be harmful by inhalation, ingestion, or skin absorption. Wear appropriate gloves and safety glasses. Use in a chemical fume hood.

**Sodium pyrophosphate** is an irritant and may be harmful by inhalation, ingestion, or skin absorption. Wear appropriate gloves and safety glasses. Do not breathe the dust.

**Sodium salicylate** is an irritant and may be harmful by inhalation, ingestion, or skin absorption. Wear appropriate gloves and safety glasses. Do not breathe the dust.



**Spermidine** may be corrosive and harmful by inhalation, ingestion, or skin absorption. Wear appropriate gloves and safety glasses. Use in a chemical fume hood.

**Streptomycin** is toxic and a suspected carcinogen and mutagen. It may cause allergic reactions. It may be harmful by inhalation, ingestion, or skin absorption. Wear appropriate gloves and safety glasses.

**Sulfuric acid, H<sub>2</sub>SO<sub>4</sub>**, is highly toxic and extremely destructive to tissue of the mucous membranes and upper respiratory tract, eyes, and skin. It causes burns and contact with other materials (e.g., paper) may cause fire. Wear appropriate gloves, safety glasses, and lab coat. Use in a chemical fume hood.

**SYBR Green I/Gold** is supplied by the manufacturer as a 10,000-fold concentrate in DMSO which transports chemicals across the skin and other tissues. Wear appropriate gloves and safety glasses and decontaminate according to Safety Office guidelines. *See DMSO.*

**TCA**, *see Trichloroacetic acid*

**TEMED**, *see N,N,N',N'-Tetramethylethylenediamine*

**Tetracycline** may be harmful by inhalation, ingestion, or skin absorption. Wear appropriate gloves and safety glasses and use in a chemical fume hood. Solutions of tetracycline are sensitive to light.

**N,N,N',N'-Tetramethylethylenediamine (TEMED)** is extremely destructive to tissues of the mucous membranes and upper respiratory tract, eyes, and skin. Inhalation may be fatal. Prolonged contact can cause severe irritation or burns. Wear appropriate gloves, safety glasses, and other protective clothing. Use only in a chemical fume hood. Wash thoroughly after handling. Flammable: Vapor may travel a considerable distance to source of ignition and flash back. Keep away from heat, sparks, and open flame.

**TFA**, *see Trifluoroacetic acid*

**Thiourea** may be carcinogenic and may be harmful by inhalation, ingestion, or skin absorption. Wear appropriate gloves and safety glasses. Use in a chemical fume hood.

**Tissues (human)**, *see Blood (human) and blood products*

**Trichloroacetic acid (TCA)** is highly caustic. Wear appropriate gloves and safety goggles.

**Trichlorotrifluoroethane** may be harmful by inhalation, ingestion, or skin absorption. Wear appropriate gloves and safety goggles. Use in a chemical fume hood. Keep away from heat, sparks, and open flame.

**Trifluoroacetic acid (TFA) (concentrated)** may be harmful by inhalation, ingestion, or skin absorption. Concentrated acids must be handled with great care. Decomposition causes toxic fumes. Wear appropriate gloves and a face mask. Use in a chemical fume hood.

**Tris** may be harmful by inhalation, ingestion, or skin absorption. Wear appropriate gloves and safety glasses.

**Triton X-100** causes severe eye irritation and burns. It may be harmful by inhalation, ingestion, or skin absorption. Wear appropriate gloves and safety goggles.

**Trypan blue** may be a carcinogen and may be harmful by inhalation, ingestion, or skin absorption. Do not breathe the dust. Wear appropriate gloves and safety glasses.

**Tryptophan** may be harmful by inhalation, ingestion, or skin absorption. Wear appropriate gloves and safety glasses.

**Urea** may be harmful by inhalation, ingestion, or skin absorption. Wear appropriate gloves and safety glasses.

**UV light** and/or **UV radiation** is dangerous and can damage the retina of the eyes. Never look at an unshielded UV light source with naked eyes. Examples of UV light sources that are common in the laboratory include hand-held lamps and transilluminators. View only through a filter or safety glasses that absorb harmful wavelengths. UV radiation is also mutagenic and carcinogenic. To minimize exposure, make sure that the UV light source is adequately shielded. Wear protective appropriate gloves when holding materials under the UV light source.

**Valine** may be harmful by inhalation, ingestion, or skin absorption. Wear appropriate gloves and safety glasses.

**X-gal** may be toxic to the eyes and skin. Observe general cautions when handling the powder. Note that stock solutions of X-gal are prepared in DMF, an organic solvent. For details, see *N,N*-dimethylformamide. See also **5-Bromo-4-chloro-3-indolyl- $\beta$ -D-galactopyranoside (BCIG)**.

**X-rays**, *see* **Radioactive substances**

**Xylene** is flammable and may be narcotic at high concentrations. It may be harmful by inhalation, ingestion, or skin absorption. Wear appropriate gloves and safety glasses. Use only in a chemical fume hood. Keep away from heat, sparks, and open flame.

**Xylene cyanol**, *see* **Xylene**

**Zinc chloride,  $ZnCl_2$** , is corrosive and poses possible risk to the unborn child. It may be harmful by inhalation, ingestion, or skin absorption. Wear appropriate gloves and safety glasses. Do not breathe the dust.

**$ZnCl_2$** , *see* **Zinc chloride**

**Zymolase** may be harmful by inhalation, ingestion, or skin absorption. Wear appropriate gloves and safety glasses.



# Appendix 13

---

## Suppliers

Commercial sources and products have been included in the text for the user's convenience and should not necessarily be construed as an endorsement by the authors. With the exception of those suppliers listed in the text with their addresses, all suppliers mentioned in this manual can be found in the *BioSupplyNet Source Book* and on the Web Site at:

<http://www.biosupplynet.com>

If a copy of *BioSupplyNet Source Book* was not included with this manual, a free copy can be ordered by using any of the following methods:

- Complete the Free *Source Book* Request Form found at the "Get the *Source Book*" link on the Web Site:

<http://www.biosupplynet.com>

- E-mail a request to [info@biosupplynet.com](mailto:info@biosupplynet.com)
- Fax a request to 631-370-8808

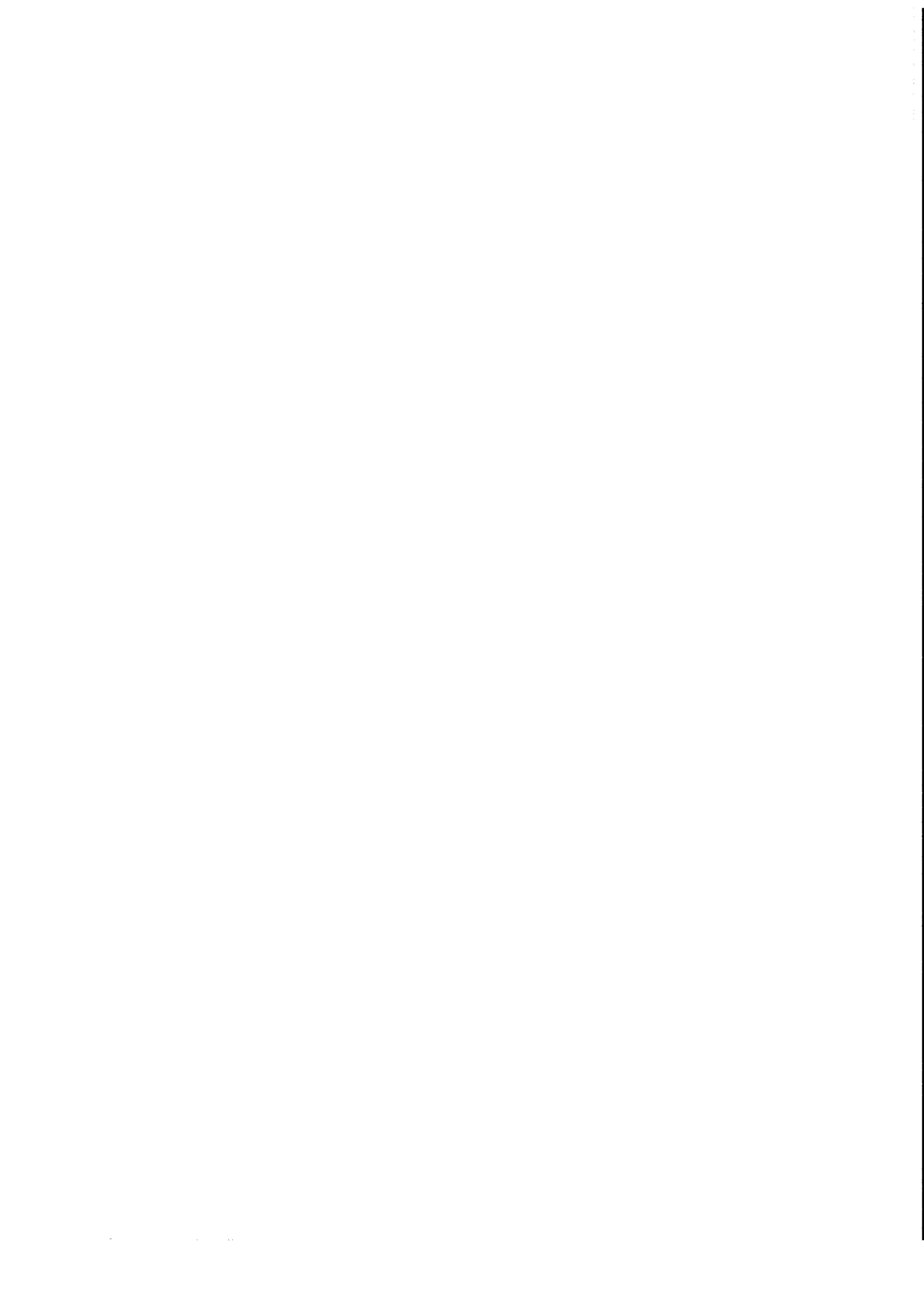


# Appendix 14

---

## Trademarks

Products mentioned in this book that may be trademarked or registered-trademarked are listed on the [www.MolecularCloning.com](http://www.MolecularCloning.com) Web Site for informational purposes only. Any trademarks or names being used are for editorial purposes only, with no intention of infringing upon that trademark. CSHL Press has provided and will continue to provide, to the best of our ability, accurate and up-to-date information on its Web Site. However, all registered trademarks and service-marks are the property of their respective owners, and are listed on the Web Site solely for identification or description of the applicable goods and services. Therefore, please consult individual manufacturers and other resources for current and specific product information.



## APPENDIX REFERENCES

- Aaij C. and Borst P. 1972. The gel electrophoresis of DNA. *Biochim. Biophys. Acta* **269**: 192–200.
- Adams A., Gottschling D., Kaiser C., and Stearns T. 1998. *Methods in yeast genetics: A laboratory course manual*. Cold Spring Harbor Laboratory Press, Cold Spring Harbor, New York.
- Adams M.D., Celniker S.E., Holt R.A., Evans C.A., Gocayne J.D., Amanatides P.G., Scherer S.E., Li P.W., Hoskins R.A., Galle R.E., et al. 2000. The genome sequence of *Drosophila melanogaster*. *Science* **287**: 2185–2195.
- Akerström B. and Björck L. 1986. A physicochemical study of protein G, a molecule with unique immunoglobulin G-binding properties. *J. Biol. Chem.* **261**: 10240–10247.
- . 1989. Protein L: An immunoglobulin light chain-binding bacterial protein. Characterization of binding and physicochemical properties. *J. Biol. Chem.* **264**: 19740–19746.
- Akerström B., Brodin T., Reis K., and Björck L. 1985. Protein G: A powerful tool for binding and detection of monoclonal and polyclonal antibodies. *J. Immunol.* **135**: 2589–2592.
- Allefs J.J., Salentijn E.M., Krens F.A., and Rouwendal G.J. 1990. Optimization of non-radioactive Southern blot hybridization: Single copy detection and reuse of blots. *Nucleic Acids Res.* **18**: 3099–3100.
- Allen R.C. and Loose L.D. 1976. Phagocytic activation of a luminol-dependent chemiluminescence in rabbit alveolar and peritoneal macrophages. *Biochem. Biophys. Res. Commun.* **69**: 245–252.
- Alloway J.L. 1932. The transformation *in vitro* of R pneumococci into S forms of different specific types by the use of filtered pneumococcus extracts. *J. Exp. Med.* **55**: 91–99.
- . 1933. Further observations on the use of pneumococcus extracts in effecting transformation of type *in vitro*. *J. Exp. Med.* **57**: 265–278.
- Alm R.A., Ling I.-S., Moir D.T., King B.L., Brown E.D., Doig P.C., Smith D.R., Noonan B., Guild B.C., deJonge B.L., et al. 1999. Genomic-sequence comparison of two unrelated isolates of the human gastric pathogen *Helicobacter pylori* (erratum *Nature* [1999] **397**: 719). *Nature* **397**: 176–180.
- Altschul S.F. and Gish W. 1996. Local alignment statistics. *Methods Enzymol.* **266**: 460–480.
- Altschul S.F., Gish W., Miller W., Myers E.W., and Lipman D.J. 1990. Basic local alignment search tool. *J. Mol. Biol.* **215**: 403–410.
- Altschul S.F., Madden T.L., Schaffer A.A., Zhang J., Zhang Z., Miller W., and Lipman D.J. 1997. Gapped BLAST and PSI-BLAST: A new generation of protein database search programs. *Nucleic Acids Res.* **25**: 3389–3402.
- Anderson S. 1981. Shotgun DNA sequencing using cloned DNase I-generated fragments. *Nucleic Acids Res.* **9**: 3015–3027.
- Andersson S.G., Zomorodipour A., Andersson J.O., Sicheritz-Ponten T., Alsmark U.C., Podowski R.M., Näslund A.K., Eriksson A.-S., Winkler H.H., and Kurland C.G. 1998. The genome sequence of *Rickettsia prowazekii* and the origin of mitochondria. *Nature* **396**: 133–140.
- Appleyard R.K. 1954. Segregation of new lysogenic types during growth of a doubly lysogenic strain derived from *Escherichia coli* K12. *Genetics* **39**: 440–452.
- Arakawa H., Maeda M., and Tsuji A. 1982. Chemiluminescence enzyme immunoassay of 17  $\alpha$ -hydroxyprogesterone using glucose oxidase and bis(2,4,6-trichlorophenyl)oxalate: fluorescent dye system. *Chem. Pharm. Bull.* **30**: 3036–3039.
- Arber W., Enquist L., Hohn B., Murray N.E., and Murray K. 1983. Experimental methods for use with lambda. In *Lambda II* (ed. R.W. Hendrix et al.), pp. 433–466. Cold Spring Harbor Laboratory, Cold Spring Harbor, New York.
- Arnold Jr., L.J., Hammond P.W., Wiese W.A., and Nelson N.C. 1989. Assay formats involving acridinium-ester-labeled DNA probes. *Clin. Chem.* **35**: 1588–1594.
- Avery O.T., McLeod C.M., and McCarty M. 1944. Studies on the chemical nature of the substance inducing transformation of pneumococcal types. Induction of transformation by a desoxyribonucleic acid fraction isolated from pneumococcus type III. *J. Exp. Med.* **79**: 137–158.
- Backman K. 1980. A cautionary note on the use of certain restriction endonucleases with methylated substrates. *Gene* **11**: 169–171.
- Bailey T.L. 1995. “Discovering motifs in DNA and protein sequences: The approximate common substrings problem.” Ph.D. thesis, University of California, San Diego.
- Bailey T.L. and Elkan C. 1994. Fitting a mixture model by expectation maximization to discover motifs in biopolymers. *Ismb* **21**: 28–36.
- . 1995. Unsupervised learning of multiple motifs in biopolymers using EM. *Mach. Learn.* **21**: 51–80.
- Bailey T.L. and Gribskov M. 1998. Methods and statistics for combining motif match searches. *J. Comput. Biol.* **5**: 211–221.
- Bajorath J., Hinrichs W., and Saenger W. 1988. The enzymatic activity of proteinase K is controlled by calcium. *Eur. J. Biochem.* **176**: 441–447.
- Bajorath J., Raghunathan S., Hinrichs W., and Saenger W. 1989. Long-range structural changes in proteinase K triggered by calcium ion removal. *Nature* **337**: 481–484.
- Baker W., van den Broek A., Camon E., Hingamp P., Sterk P., Stoesser G., and Tuli M.A. 2000. The EMBL Nucleotide Sequence Database. *Nucleic Acids Res.* **28**: 19–23.
- Baldwin T.O., Berends T., Bunch T.A., Holzman T.F., Rausch S.K., Shamansky L., Treat M.L., and Ziegler M.M. 1984. Cloning of the luciferase structural genes from *Vibrio harveyi* and expression of bioluminescence in *Escherichia coli*. *Biochemistry* **23**: 3663–3667.
- Barany F. and Gelfand D.H. 1991. Cloning, overexpression and nucleotide sequence of a thermostable DNA ligase-encoding gene. *Gene* **109**: 1–11.
- Baret A. and Fert V. 1990. T<sub>4</sub> and ultrasensitive TSH immunoassays using luminescent enhanced xanthine oxidase assay. *J. Biolumin. Chemilumin.* **4**: 149–153.
- Baret A., Fert V., and Aumaille J. 1990. Application of a long-term enhanced xanthine oxidase-induced luminescence in solid-phase immunoassays. *Anal. Biochem.* **187**: 20–26.
- Bassam B.J., Caetano-Anollés G., and Gresshoff P.M. 1991. Fast and sensitive silver staining of DNA in polyacrylamide gels. *Anal. Biochem.* **196**: 80–83.
- Bateman A., Birney E., Eddy S.R., Finn R.D., and E.L. Sonnhammer. 1999. Pfam 3.1: 1313 multiple alignments match the majority of proteins. *Nucleic Acids Res.* **27**: 260–262.
- Bateman A., Birney E., Durbin R., Eddy S.R., Howe K.L., and Sonnhammer E.L. 2000. The Pfam protein families database. *Nucleic Acids Res.* **28**: 263–266.
- Baughman G. and Howell S.H. 1988. Cauliflower mosaic virus 35S RNA leader region inhibits translation of downstream genes. *Virology* **167**: 125–135.



## R.2 Appendix References

- Beaven G.H., Holiday E.R., and Johnson E.A. 1955. Optical properties of nucleic acids and their components. In *The nucleic acids* (ed. E. Chargaff and J.N. Davidson), vol. 1, pp. 493–553. Academic Press, New York.
- Beck S. and Köster H. 1990. Applications of dioxetane chemiluminescent probes to molecular biology (erratum *Anal. Chem.* [1991] **63**: 848). *Anal. Chem.* **62**: 2258–2270.
- Beck S., O'Keeffe T., Coull J.M., and Köster H. 1989. Chemiluminescent detection of DNA: Application for DNA sequencing and hybridization. *Nucleic Acids Res.* **17**: 5115–5123.
- Bei A.K. and Mahbubani M.H. 1994. Thermostable DNA polymerases for *in vitro* DNA amplifications. In *PCR technology: Current innovations* (ed. H.G. Griffin and A.M. Griffin), pp. 219–238. CRC Press, Boca Raton, Florida.
- Belas R., Mileham A., Cohn D., Hilmen M., Simon M., and Silverman M. 1982. Bacterial luminescence: Isolation and expression of the luciferase genes from *Vibrio harveyi*. *Science* **218**: 791–793.
- Bennetzen J.L. and Hall B.D. 1982. Codon selection in yeast. *J. Biol. Chem.* **257**: 3026–3031.
- Bensaude O. 1988. Ethidium bromide and safety — Readers suggest alternative solutions (letter). *Trends Genet.* **4**: 89–90.
- Berger S.L., Wallace D.M., Puskas R.S., and Eschenfeldt W.H. 1983. Reverse transcriptase and its associated ribonuclease H: Interplay of two enzyme activities controls the yield of single-stranded complementary deoxyribonucleic acid. *Biochemistry* **22**: 2365–2372.
- Berk A.J. and Sharp P.A. 1977. Sizing and mapping of early adenovirus mRNAs by gel electrophoresis of S1 endonuclease-digested hybrids. *Cell* **12**: 721–732.
- Berkner K.L. and Folk W.R. 1977. Polynucleotide kinase exchange reaction. Quantitative assay for restriction endonuclease-generated 5'-phosphoryl termini in DNAs. *J. Biol. Chem.* **252**: 3176–3184.
- Berman H.M., Zardecki C., and Westbrook J. 1998. The nucleic acid database: A resource for nucleic acid science. *Acta Crystallogr. Sect. D Biol. Crystallogr.* **54**: 1095–1104.
- Berman H.M., Westbrook J., Feng Z., Gilliland G., Bhat T.N., Weissig H., Shindyalov I.N., and Bourne P.E. 2000. The Protein Data Bank. *Nucleic Acids Res.* **28**: 235–242.
- Bernardi G. 1961. Chromatography of native deoxyribonucleic acid on calcium phosphate. *Biochem. Biophys. Res. Commun.* **6**: 54–57.
- . 1965. Chromatography of nucleic acids on hydroxyapatite. *Nature* **206**: 779–783.
- Bernardi G. and Bernardi G. 1986. Compositional constraints and genome evolution. *J. Mol. Evol.* **24**: 1–11.
- Bernardi G. and Timasheff S.N. 1961. Chromatography of Ehrlich ascites tumor cell high molecular weight ribonucleic acid on calcium phosphate. *Biochem. Biophys. Res. Commun.* **6**: 58–61.
- Bernardi A., Gaillard C., and Bernardi G. 1975. The specificity of five DNAses as studied by the analysis of 5' terminal doublets. *Eur. J. Biochem.* **52**: 451–457.
- Bertani G. and Weigle J.J. 1953. Host controlled variation in bacterial viruses. *J. Bacteriol.* **65**: 113–121.
- Betzl C., Pal G.P., and Saenger W. 1988. Three-dimensional structure of proteinase K at 0.15nm resolution. *Eur. J. Biochem.* **178**: 155–171.
- Bickle T.A. 1987. DNA restriction and modification systems. In *Escherichia coli and Salmonella typhimurium: Cellular and molecular biology* (ed. F.C. Neidhardt et al.), vol. 1, pp. 692–697. American Society for Microbiology, Washington, D.C.
- Bierwerth S., Kahl G., Weigand F., and Weising K. 1992. Oligonucleotide fingerprinting of plant and fungal genomes: A comparison of radioactive, colorigenic and chemiluminescent detection methods. *Electrophoresis* **13**: 115–122.
- Bird A.P. and Southern E.M. 1978. Use of restriction enzymes to study eukaryotic DNA methylation. I. The methylation pattern in ribosomal DNA from *Xenopus laevis*. *J. Mol. Biol.* **118**: 27–47.
- Bird A.P., Taggart M., Frommer M., Miller O.J., and Macleod D. 1985. A fraction of the mouse genome that is derived from islands of nonmethylated, CpG-rich DNA. *Cell* **40**: 91–99.
- Birren B., Green E.D., Klapholz S., Myers R.M., and Roskams J. 1997. *Genome analysis: A laboratory manual*, vol. 1. *Analyzing DNA* (ed E.D. Green et al.). Cold Spring Harbor Laboratory Press, Cold Spring Harbor, New York.
- Bitler B. and McElroy W.D. 1957. The preparation and purification of crystalline firefly luciferase. *Arch. Biochem. Biophys.* **72**: 358–368.
- Bjerrum O.J. and Schafer-Nielsen C. 1986. Buffer systems and transfer parameters for semidry electroblotting with a horizontal apparatus. In *Electrophoresis '86: Proceedings of the 5th Meeting of the International Electrophoresis Society* (ed. M.J. Dunn), pp. 315–327. VCH Publishers, Deerfield Beach, Florida.
- Bjerrum O.J., Larsen K.P., and Heegaard N.H. 1988. Non-specific binding and artifacts-specificity problems and troubleshooting with an atlas of immunoblotting artifacts. In *CRC handbook of immunoblotting of proteins: Technical descriptions* (ed. O.J. Bjerrum and N.H. Heegaard), vol. 1, pp. 227–254. CRC Press, Boca Raton, Florida.
- Björck L. 1988. Protein L: A novel bacterial cell wall protein with affinity for IgL chains. *J. Immunol.* **140**: 1194–1197.
- Björck L. and Kronvall G. 1984. Purification and some properties of streptococcal protein G, a novel IgG-binding reagent. *J. Immunol.* **133**: 969–974.
- Björck L., Kastern W., Lindahl G., and Wideback K. 1987. Streptococcal protein G, expressed by streptococci or by *Escherichia coli*, has separate binding sites for human albumin and IgG. *Mol. Immunol.* **24**: 1113–1122.
- Blackburn P., Wilson G., and Moore S. 1977. Ribonuclease inhibitor from human placenta. Purification and properties. *J. Biol. Chem.* **252**: 5904–5910.
- Blake C.C.F., Johnson L.N., Mair G.A., North A.C.T., Phillips D.C., and Sarma V.R. 1967. Crystallographic studies of the activity of hen egg-white lysozyme. *Proc. R. Soc. Lond. B Biol. Sci.* **167**: 378–388.
- Blake M.S., Johnston K.H., Russell-Jones G.J., and Gotschlich E.C. 1984. A rapid, sensitive method for detection of alkaline phosphatase-conjugated anti-antibody on Western blots. *Anal. Biochem.* **136**: 175–179.
- Blattner F.R., Plunkett III, G., Bloch C.A., Perna N.T., Burland V., Riley M., Collado-Vides J., Glasner J.D., Rode C.K., Mayhew G.F., et al. 1997. The complete genome sequence of *Escherichia coli* K-12. *Science* **277**: 1453–1474.
- Bodenteich A., Chissoe S., Wang Y.-F., and Roe B.A. 1994. Shotgun cloning as the strategy of choice to generate templates for high-throughput dideoxynucleotide sequencing. In *Automated DNA sequencing and analysis* (ed. M.D. Adams et al.), pp. 42–50. Academic Press, San Diego, California.
- Bolivar F. and Backman K. 1979. Plasmids of *Escherichia coli* as cloning vectors. *Methods Enzymol.* **68**: 245–267.
- Bolivar F., Rodriguez R.L., Green P.J., Betlach M.C., Heyneker H.L., Boyer H.W., Crosa J.H., and Falkow S. 1977. Construction and characterization of new cloning vehicles.

- II. A multipurpose cloning system. *Gene* **2**: 95–113.
- Bollum F.J. 1974. Terminal deoxynucleotidyl transferase. In *The enzymes*, 3rd edition (ed. P.D. Boyer), vol. 10, p. 145. Academic Press, New York.
- Bolton A.E. and W.M. Hunter. 1973. The labelling of proteins to high specific radioactivities by conjugation to a <sup>125</sup>I-containing acylating agent. *Biochem. J.* **133**: 529–539.
- Bonhoeffer S., McCaskill J.S., Stadter P.F., and Schuster P. 1993. RNA multistructure landscapes. *Biophys. J.* **22**: 13–24.
- Bonner W.M. and Laskey R.A. 1974. A film detection method for tritium-labelled proteins and nucleic acids in polyacrylamide gels. *Eur. J. Biochem.* **46**: 83–88.
- Borck K., Beggs J.D., Brammar W.J., Hopkins A.S., and Murray N.E. 1976. The construction in vitro of transducing derivatives of phage lambda. *Mol. Gen. Genet.* **146**: 199–207.
- Borodovsky M. and McInich J. 1993. GeneMark: Parallel gene recognition for both DNA strands. *Comput. Chem.* **17**: 123–133.
- Bouvet J.P. 1994. Immunoglobulin Fab fragment-binding proteins. *Int. J. Immunopharmacol.* **16**: 419–424.
- Bowman R.A., O'Neil G.L., and Riley T.V. 1991. Non-radioactive restriction fragment length polymorphism (RFLP) typing of *Clostridium difficile*. *FEMS Microbiol. Lett.* **63**: 269–272.
- Boyer H.W. and Roulland-Dussoix D. 1969. A complementation analysis of the restriction and modification of DNA in *Escherichia coli*. *J. Mol. Biol.* **41**: 459–472.
- Boylan M., Pelletier J., and Meighen E.A. 1989. Fused bacterial luciferase subunits catalyze light emission in eukaryotes and prokaryotes. *J. Biol. Chem.* **264**: 1915–1918.
- Boyle M.D.P. 1990. *Bacterial immunoglobulin-binding proteins*. Academic Press, San Diego, California.
- Boyle M.D.P. and Reis K.J. 1987. Bacterial Fc-receptors. *Bio/Technology* **5**: 697–703.
- Brawerman G., Mendecki J., and Lee S.Y. 1972. A procedure for the isolation of mammalian messenger ribonucleic acid. *Biochemistry* **11**: 637–641.
- Brent R. and Ptashne M. 1981. Mechanism of action of the *lexA* gene product. *Proc. Natl. Acad. Sci.* **78**: 4204–4208.
- Brickman E. and Beckwith J. 1975. Analysis of the regulation of *Escherichia coli* alkaline phosphatase synthesis using deletions and phi80 transducing phages. *J. Mol. Biol.* **96**: 307–316.
- Britten R.J. and Kohne D.E. 1966. Nucleotide sequence repetition. *Carnegie Inst. Wash. Year Book* **65**: 78–106.
- . 1967. Repeated nucleotide sequences. *Carnegie Inst. Wash. Year Book* **66**: 73–88.
- . 1968. Repeated sequences in DNA. Hundreds of thousands of copies of DNA sequences have been incorporated into the genomes of higher organisms. *Science* **161**: 529–540.
- Britten R.J., Graham D.E., and Neufeld B.R. 1974. Analysis of repeating DNA sequences by reassociation. *Methods Enzymol.* **29**: 363–418.
- Bronstein I. 1990. Chemiluminescent 1,2-dioxetane-based enzyme substrates and their applications. In *Luminescence immunoassays and molecular applications* (ed. K. Van Dyke and R. Van Dyke), pp. 255–274. CRC Press, Boca Raton, Florida.
- Bronstein I. and Kricka L.J. 1989. Clinical applications of luminescent assays for enzymes and enzyme labels. *J. Clin. Lab. Anal.* **3**: 316–322.
- Bronstein I. and McGrath P. 1989. Chemiluminescence lights up. *Nature* **338**: 599–600.
- Bronstein I. and Voyta J.C. 1989. Chemiluminescent detection of herpes simplex virus I DNA in blot and in situ hybridization assays. *Clin. Chem.* **35**: 1856–1860.
- Bronstein I., Edwards B., and Voyta J.C. 1989. 1,2-dioxetanes: Novel chemiluminescent enzyme substrates. Applications to immunoassays. *J. Biolumin. Chemilumin.* **4**: 99–111.
- Bronstein I., Juo R.R., Voyta J.C., and Edwards B. 1991. Novel chemiluminescent adamantyl 1,2-dioxetane enzyme substrates. In *Bioluminescence and chemiluminescence: Current status* (ed. P.E. Stanley and L.J. Kricka), pp. 73–82. Wiley, Chichester, United Kingdom.
- Bronstein I., Voyta J.C., Murphy O.J., Bresnick L., and Kricka L.J. 1992. Improved chemiluminescent Western blotting procedure. *BioTechniques* **12**: 748–753.
- Bronstein I., Voyta J.C., Lazzari K.G., Murphy O., Edwards B., and Kricka L.J. 1990. Rapid and sensitive detection of DNA in Southern blots with chemiluminescence. *BioTechniques* **8**: 310–314.
- Bronstein I., Voyta J.C., Murphy O.J., Tizard R., Ehrenfels C.W., and Cate R.L. 1993. Detection of DNA in Southern blots with chemiluminescence. *Methods Enzymol.* **217**: 398–414.
- Brunak S., Engelbrecht J., and Knudsen J. 1991. Prediction of human mRNA donor and acceptor sites from DNA sequence. *J. Mol. Biol.* **220**: 49–65.
- Brunk C.F. and Simpson L. 1977. Comparison of various ultraviolet sources for fluorescent detection of ethidium bromide-DNA complexes in polyacrylamide gels. *Anal. Biochem.* **82**: 455–462.
- Bucher P. 1990. Weight matrix descriptions of four eukaryotic RNA polymerase II promoter elements derived from 502 unrelated promoter sequences. *J. Mol. Biol.* **212**: 563–578.
- Bullock W.O., Fernandez J.M., and Short J.M. 1987. X11-blue: A high efficiency plasmid transforming *recA Escherichia coli* strain with  $\beta$ -galactosidase selection. *BioTechniques* **5**: 376–379.
- Bulmer M. 1990. The effects of context on synonymous codon usage in genes with low codon bias. *Nucleic Acids Res.* **18**: 2869–2873.
- Bult C.J., White O., Olsen G.J., Zhou L., Fleischmann R.D., Sutton G.G., Blake J.A., FitzGerald L.M., Clayton R.A., Gocayne J.D., et al. 1996. Complete genome sequence of the methanogenic archaeon, *Methanococcus jannaschii*. *Science* **273**: 1058–1073.
- Burge C.B. and Karlin S. 1997. Prediction of complete gene structures in human genomic DNA. *J. Mol. Biol.* **268**: 78–94.
- Burke B., Griffiths G., Reggio H., Louvard D., and Warren G. 1982. A monoclonal antibody against a 135-K Golgi membrane protein. *EMBO J.* **1**: 1621–1628.
- Burnette W.N. 1981. Western blotting: Electrophoretic transfer of proteins from sodium dodecyl sulphate-polyacrylamide gels to unmodified nitrocellulose and radiographic detection with antibody and radioiodinated protein A. *Anal. Biochem.* **112**: 195–203.
- Butler E.T. and Chamberlin M.J. 1982. Bacteriophage SP6-specific RNA polymerase. I. Isolation and characterization of the enzyme. *J. Biol. Chem.* **257**: 5772–5778.
- C. elegans* Sequencing Consortium. 1998. Genome sequence of the nematode *C. elegans*: A platform for investigating biology (errata *Science* [1999] **283**: 35; **283**: 2103; **285**: 1493). *Science* **282**: 2012–2018.
- Campbell A. 1965. The steric effect in lysogenization by bacteriophage lambda. I. Lysogenization of a partially diploid strain of *Escherichia coli* K12. *Virology* **27**: 329–339.
- Campbell A.K. 1988. *Chemiluminescence*. Ellis Horwood, Chichester, United Kingdom.
- Campbell J.L., Richardson C.C., and Studier F.W. 1978. Genetic recombination and complementation between bacterio-

## R.4 Appendix References

- phage T7 and cloned fragments of T7 DNA. *Proc. Natl. Acad. Sci.* **75**: 2276–2280.
- Campbell V.W. and Jackson D.A. 1980. The effect of divalent cations on the mode of action of DNase I. The initial reaction products produced from covalently closed circular DNA. *J. Biol. Chem.* **255**: 3726–3735.
- Cardwell H.M.E. and Smith S. 1953. The structure of digoxigenin. *Experientia* **9**: 267–368.
- . 1954. Digitalis glucosides. VII. The structure of the digitalis anhydrogenins and the orientation of the hydroxy-groups in digoxigenin and gitoxigenin. *J. Chem. Soc.* **1954**: 2012–2023.
- Carlson D.P., Superko C., Mackey J., Gaskill M.E., and Hansen P. 1990. Chemiluminescent detection of nucleic acid hybridization. *Focus (Life Technologies)* **12**: 9–12.
- Cate R.L., Ehrenfels C.W., Wysk M., Tizard R., Voyta J.C., Murphy O.J., and Bronstein I. 1991. Genomic Southern analysis with alkaline phosphatase-conjugated oligonucleotide probes and the chemiluminescent substrate AMPPD. *Genet. Anal. Tech. Appl.* **8**: 102–106.
- Ceci L.R., Volpicella M., Liuni S., Volpetti V., Licciulli E., and Gallerani R. 1999. PLMitRNA, a database for higher plant mitochondrial tRNAs and tRNA genes. *Nucleic Acids Res.* **27**: 156–157.
- Cesarone C.E., Bolognesi C., and Santi L. 1979. Improved micro-fluorimetric DNA determination in biological material using 33258 Hoechst. *Anal. Biochem.* **100**: 188–197.
- . 1980. Fluorometric DNA assay at nanogram levels in biological material. *Boll. Soc. Ital. Biol. Sper.* **56**: 1666–1672.
- Chalfie M., Tu Y., Euskirchen G., Ward W.W., and Prasher D.C. 1994. Green fluorescent protein as a marker for gene expression. *Science* **263**: 802–805.
- Chalon M.P., R.W. Milne, and J.P. Vaerman. 1979. Interactions between mouse immunoglobulins and staphylococcal protein A. *Scand. J. Immunol.* **9**: 359–364.
- Chamberlain J.P. 1979. Fluorographic detection of radioactivity in polyacrylamide gels with the water-soluble fluor, sodium salicylate. *Anal. Biochem.* **98**: 132–135.
- Chang L.M.S. and Bollum F.J. 1986. Molecular biology of terminal transferase. *Crit. Rev. Biochem.* **21**: 27–52.
- Chao K.-M., Pearson W.R., and Miller W. 1992. Aligning two sequences within a specified diagonal band. *Comput. Appl. Biosci.* **8**: 481–487.
- Chao S., Chao L., and Chao J. 1989. Enhanced specificity in immunoscreening of expression cDNA clones using radiolabelled antigen technology. *BioTechniques* **7**: 68–72.
- Chen W., Tabor S., and Struhl K. 1987. Distinguishing between mechanisms of eukaryotic transcriptional activation with bacteriophage T7 RNA polymerase. *Cell* **50**: 1047–1055.
- Cheng H. and Rudick M.J. 1991. A membrane blotting method for following the time course of protein radioiodination using Iodobeads. *Anal. Biochem.* **198**: 191–193.
- Chien A., Edgar D.B., and Trela J.M. 1976. Deoxyribonucleic acid polymerase from the extreme thermophile *Thermus aquaticus*. *J. Bacteriol.* **127**: 1550–1557.
- Chiu W.L., Niwa Y., Zeng W., Hirano T., Kobayashi H., and Sheen J. 1996. Engineered GFP as a vital marker in plants. *Curr. Biol.* **6**: 325–330.
- Chothia C. 1976. The nature of the accessible and buried surfaces in proteins. *J. Mol. Biol.* **105**: 1–12.
- Chrambach A. and Rodbard D. 1972. Polymerization of polyacrylamide gels: Efficiency and reproducibility as a function of catalyst concentrations. *Sep. Sci.* **7**: 663–703.
- Church G.M. and Gilbert W. 1984. Genomic sequencing. *Proc. Natl. Acad. Sci.* **81**: 1991–1995.
- Church G.M. and Kieffer-Higgins S. 1988. Multiplex DNA sequencing. *Science* **240**: 185–188.
- Cohn D.H., Mileham A.J., Simon M.I., Nealon K.H., Rausch S.K., Bonam D., and Baldwin T.O. 1985. Nucleotide sequence of the *luxA* gene of *Vibrio harveyi* and the complete amino acid sequence of the  $\alpha$  subunit of bacterial luciferase. *J. Biol. Chem.* **260**: 6139–6146.
- Cole S.T., Brosch R., Parkhill J., Garnier T., Churcher C., Harris D., Gordon S.V., Eiglmeier K., Gas S., Barry C.E., et al. 1998. Deciphering the biology of *Mycobacterium tuberculosis* from the complete genome sequence (erratum *Nature* [1998] **396**: 190). *Nature* **393**: 537–544.
- Cook R.F., Cook S.J., and Issel C.J. 1992. A nonradioactive micro-assay for released reverse transcriptase activity of a lentivirus. *BioTechniques* **13**: 380–386.
- Corpet F. 1988. Multiple sequence alignment with hierarchical clustering. *Nucleic Acids Res.* **16**: 10881–10890.
- Corpet F., Gouzy J., and Kahn D. 1998. The ProDom database of protein domain families. *Nucleic Acids Res.* **26**: 323–326.
- Cozzarelli N.R., Kelly R.B., and Kornberg A. 1968. A minute circular DNA from *Escherichia coli* 15. *Proc. Natl. Acad. Sci.* **60**: 992–999.
- . 1969. Enzymic synthesis of DNA. XXXIII. Hydrolysis of a 5'-triphosphate-terminated polynucleotide in the active center of DNA polymerase. *J. Mol. Biol.* **45**: 513–531.
- Creasey A., D'Angio L.J., Dunne T.S., Kissinger C., O'Keefe T., Perry-O'Keefe H., Moran L., Roskey M., Schildkraut I., Sears L.E., and Slatko B. 1991. Application of a novel chemiluminescent-based DNA detection method to a single vector and multiplex DNA sequencing. *BioTechniques* **11**: 102–109.
- Crooke S.T. 1998. Molecular mechanisms of antisense drugs: RNase H. *Antisense Nucleic Acid Drug Dev.* **8**: 133–134.
- Crouch R. 1990. Ribonuclease H: From discovery to 3D structure. *New Biol.* **2**: 771–777.
- Daniels D.L., Schroeder J.L., Szybalski W., Sanger F., and Blattner F.R. 1983. Appendix I: A molecular map of coliphage lambda. In *Lambda II* (ed. R.W. Hendrix et al.), pp. 469–517. Cold Spring Harbor Laboratory, Cold Spring Harbor, New York.
- Davanloo P., Rosenberg A.H., Dunn J.J., and Studier F.W. 1984. Cloning and expression of the gene for bacteriophage T7 RNA polymerase. *Proc. Natl. Acad. Sci.* **81**: 2035–2039.
- Davidson J.N. 1972. *The biochemistry of the nucleic acids*, 7th edition. Academic Press, New York.
- Davidson P.F. 1959. The effect of hydrodynamic shear on the deoxyribonucleic acid from T2 and T4 bacteriophages. *Proc. Natl. Acad. Sci.* **45**: 1560–1568.
- . 1960. Biophysics: Sedimentation of deoxyribonucleic acid isolated under low hydrodynamic shear. *Nature* **185**: 918–920.
- Davis B.J. 1964. Disc electrophoresis. II. Method and application to human serum proteins. *Ann. N.Y. Acad. Sci.* **121**: 404–427.
- Davis M.M. 1986. Subtractive cDNA hybridization and the T-cell receptor genes. In *Handbook of experimental immunology* (ed. D.M. Weir et al.), pp. 76.1–76.13. Blackwell Scientific, Oxford, United Kingdom.
- Daxhelet G.A., Coene M.M., Hoet P.P., and Cocito C.G. 1989. Spectrofluorometry of dyes with DNAs of different base composition and conformation. *Anal. Biochem.* **179**: 401–403.
- Dayhoff M.O., ed. 1972. *Atlas of protein sequence and structure*, vol. 5. National Biomedical Research Foundation,

- Georgetown University Medical Center, Washington, D.C.
- Dayhoff M.O., Schwartz R.M., and Orcutt B.C. 1978. A model of evolutionary change in proteins. In *Atlas of protein sequence and structure* (ed. M.O. Dayhoff et al.), vol. 5, suppl. 3, pp. 345–352. National Biomedical Research Foundation, Georgetown University Medical Center, Washington, D.C.
- de Blas A.L. and Cherwinski H.M. 1983. Detection of antigens on nitrocellulose: In situ staining of alkaline phosphatase conjugated antibody. *Anal. Biochem.* **133**: 214–219.
- Deckert G., Warren P.V., Gaasterland T., Young W.G., Lenox A.L., Graham D.E., Overbeek R., Snead M.A., Keller M., Aujay M., Huber R., Feldman R.A., Short J.M., Olsen G.J., and Swanson R.V. 1998. The complete genome of the hyperthermophilic bacterium *Aquifex aeolicus*. *Nature* **392**: 353–358.
- Decorte R. and Cassiman J.J. 1991. Detection of amplified VNTR alleles by direct chemiluminescence: Application to the genetic identification of biological samples in forensic cases. *Exper. Suppl.* **58**: 371–390.
- Deininger P.L. 1983. Approaches to rapid DNA sequence analysis. *Anal. Biochem.* **135**: 247–263.
- Deisenhofer J. 1981. Crystallographic refinement and atomic models of a human Fc fragment and its complex with fragment B of protein A from *Staphylococcus aureus* at 2.9- and 2.8-Å resolution. *Biochemistry* **20**: 2361–2370.
- DeLuca M. and McElroy W.D. 1978. Purification and properties of firefly luciferase. *Methods Enzymol.* **57**: 3–14.
- . 1984. Two kinetically distinguishable ATP sites in firefly luciferase. *Biochem. Biophys. Res. Commun.* **123**: 764–770.
- Deng G. and Wu R. 1983. Terminal transferase: Use in the tailing of DNA and for in vitro mutagenesis. *Methods Enzymol.* **100**: 96–116.
- Denhardt D.T. 1966. A membrane-filter technique for the detection of complementary DNA. *Biochem. Biophys. Res. Commun.* **23**: 641–646.
- DenHollander N. and Befus D. 1989. Loss of antigens from immunoblotting membranes. *J. Immunol. Methods* **122**: 129–135.
- Dente L., Cesareni G., and Cortese R. 1983. pEMBL: A new family of single-stranded plasmids. *Nucleic Acids Res.* **11**: 1645–1655.
- De Rijk P., Neefs J.M., Van de Peer Y., and De Wachter R. 1992. Compilation of small ribosomal subunit RNA sequences. *Nucleic Acids Res.* **20**: 2075–2089.
- De Rijk P., Robbrecht E., de Hoog S., Caers A., Van de Peer Y., and De Wachter R. 1999. Database on the structure of large subunit ribosomal RNA. *Nucleic Acids Res.* **27**: 174–178.
- Derrick J.P. and Wigley D.B. 1992. Crystal structure of a streptococcal protein G domain bound to a Fab fragment. *Nature* **359**: 752–754.
- de Wet J.R., Wood K.V., Helinski D.R., and DeLuca M. 1985. Cloning of firefly luciferase cDNA and the expression of active luciferase in *Escherichia coli*. *Proc. Natl. Acad. Sci.* **82**: 7870–7873.
- . 1986. Cloning firefly luciferase. *Methods Enzymol.* **133**: 3–14.
- de Wet J.R., Wood K.V., DeLuca M., Helinski D.R., and Subramani S. 1987. Firefly luciferase gene: Structure and expression in mammalian cells. *Mol. Cell. Biol.* **7**: 725–737.
- DiLella A.G., Hope D.A., Chen H., Trumbauer M., Schwartz R.J., and Smith R.G. 1988. Utility of firefly luciferase as a reporter gene for promoter activity in transgenic mice. *Nucleic Acids Res.* **16**: 4159.
- Dooley S., Welter C., and Blin N. 1992. Nonradioactive southern analysis using chemiluminescent detection. *BioTechniques* **13**: 540–542.
- Dresel H.A. and Schettler G. 1984. Characterization and visualization of the low density lipoprotein receptor by ligand blotting using anti-low density lipoprotein enzyme-linked immunosorbent assay (ELISA). *Electrophoresis* **5**: 372–373.
- Dubitsky A., Brown J., and Brandwein H. 1992. Chemiluminescent detection of DNA on nylon membranes. *BioTechniques* **13**: 392–400.
- Durrant I. 1990. Light-based detection of biomolecules. *Nature* **346**: 297–298.
- Earnshaw W.C. and Rothfield N. 1985. Identification of a family of human centromere proteins using autoimmune sera from patients with scleroderma. *Chromosoma* **91**: 313–321.
- Ebeling W., Hennrich N., Klockow M., Metz H., Orth H.D., and Lang H. 1974. Proteinase K from *Tritirachium album* Limber. *Eur. J. Biochem.* **47**: 91–97.
- Economou J.S., Rhoades K., Essner R., McBride W.H., Gasson J.C., and Morton D.L. 1989. Genetic analysis of human tumor necrosis factor  $\alpha$ /cachectin promoter region in a macrophage cell line. *J. Exp. Med.* **170**: 321–326.
- Eddy S.R. and Durbin R. 1994. RNA sequence analysis using covariance models. *Nucleic Acids Res.* **22**: 2079–2088.
- Edgar R.S. 1966. Conditional lethals. In *Phage and the origins of molecular biology* (ed. J. Cairns et al.), pp. 166–170. Cold Spring Harbor Laboratory, Cold Spring Harbor, New York.
- Edgar R.S. and Lielausis I. 1964. Temperature-sensitive mutants of bacteriophage T4D: Their isolation and genetic characterization. *Genetics* **49**: 649–662.
- Efstratiadis A., Kafatos F.C., Maxam A.M., and Maniatis T. 1976. Enzymatic in vitro synthesis of globin genes. *Cell* **7**: 279–288.
- Ehrlich S.D., Devillers-Thiery A., and Bernardi G. 1973. Further investigations on the specificity of an acid deoxyribonuclease from *Helix aspersa* (Mull.). *Eur. J. Biochem.* **40**: 139–141.
- Eliasson M., Andersson R., Olsson A., Wigzell H., and Uhlén M. 1989. Differential IgG-binding characteristics of staphylococcal protein A, streptococcal protein G, and a chimeric protein AG. *J. Immunol.* **142**: 575–581.
- Eliasson M., Olsson A., Palmcrantz E., Wiberg K., Inganas M., Guss B., Lindberg M., and Uhlén M. 1988. Chimeric IgG-binding receptors engineered from staphylococcal protein A and streptococcal protein G. *J. Biol. Chem.* **263**: 4323–4327.
- Engler M.J. and Richardson C.C. 1982. DNA ligases. In *The enzymes*, 3rd edition (ed. P.D. Boyer), vol. 15, pp. 3–29. Academic Press, New York.
- Engler-Blum G., Meier M., Frank J., and Muller G.A. 1993. Reduction of background problems in nonradioactive northern and southern blot analyses enables higher sensitivity than  $^{32}\text{P}$ -based hybridizations. *Anal. Biochem.* **210**: 235–244.
- Engvall E. 1980. Enzyme immunoassay ELISA and EMIT. *Methods Enzymol.* **70**: 419–439.
- Epstein R.H., Bolle A., Steinberg C.M., Kellenberger E., Boy de la Tour E., Chevalley R., Edgar R.S., Susman M., Denhardt G.H., and Lielausis A. 1964. Physiological studies of conditional lethal mutants of bacteriophage T4D. *Cold Spring Harbor Symp. Quant. Biol.* **28**: 375–394.
- Erntell M., Myhre E.B., and Kronvall G. 1985. Non-immune IgG F(ab')<sub>2</sub> binding to group C and G streptococci is mediated by structures on gamma chains. *Scand. J. Immunol.* **21**: 151–157.
- Eschenfeldt W.H., Puskas R.S., and Berger S.L. 1987. Homopolymeric tailing. *Methods Enzymol.* **152**: 337–342.

- Ey P.L., Prowse S.J., and Jenkin C.R. 1978. Isolation of pure IgG<sub>1</sub>, IgG<sub>2a</sub>, and IgG<sub>2b</sub> immunoglobulins from mouse serum using protein A-Sepharose. *Immunochemistry* **15**: 429–436.
- Eyre-Walker A.C. 1991. An analysis of codon usage in mammals: Selection or mutation-bias? *J. Mol. Evol.* **33**: 442–449.
- Favaloro J., Treisman R., and Kamen R. 1980. Transcription maps of polyoma virus-specific RNA: Analysis by two-dimensional nuclease S1 gel mapping. *Methods Enzymol.* **65**: 718–749.
- Fazekas de St. Groth S., Webster R.G. and Datyner A. 1963. Two new staining procedures for quantitative estimation of proteins on electrophoretic strips. *Biochim. Biophys. Acta* **71**: 377–391.
- Felton J. 1983. M13 host strain JM103 contains two restriction systems. *BioTechniques* **1**: 42–43.
- Ferguson W.J., Braunschweiger K.I., Braunschweiger W.R., Smith J.R., McCormick J.J., Wasmann C.C., Jarvis N.P., Bell D.H., and Good N.E. 1980. Hydrogen ion buffers for biological research. *Anal. Biochem.* **104**: 300–310.
- Fichant G.A. and C. Burks. 1991. Identifying potential tRNA genes in genomic DNA sequences. *J. Mol. Biol.* **220**: 659–671.
- Fields-Berry S.C., Halliday A.L., and Cepko C.L. 1992. A recombinant retrovirus encoding alkaline phosphatase confirms clonal boundary assignment in lineage analysis of murine retina. *Proc. Natl. Acad. Sci.* **89**: 693–697.
- Fierz-David H.E. and Blangey L. 1949. *Fundamental processes of dye chemistry*. Interscience, New York.
- Fleischmann R.D., Adams M.D., White O., Clayton R.A., Kirkness E.F., Kerlavage A.R., Bult C.J., Tomb J.F., Dougherty B.A., Merrick J.M., et al. 1995. Whole-genome random sequencing and assembly of *Haemophilus influenzae* Rd. *Science* **269**: 496–512.
- Fleming A. 1922. On a remarkable bacteriolytic element found in tissues and secretions. *Proc. R. Soc. Lond. B Biol. Sci.* **93**: 306–317.
- Fontana W., Konings D.A.M., Stadler P.F., and Schuster P. 1993. Statistics of RNA secondary structures. *Biopolymers* **13**: 1389–1404.
- Forsgren A. and Sjöquist J. 1966. "Protein A" from *S. aureus*. I. Pseudo-immune reaction with human gamma-globulin. *J. Immunol.* **97**: 822–827.
- . 1967. "Protein A" from *Staphylococcus aureus*. III. Reaction with rabbit gamma-globulin. *J. Immunol.* **99**: 19–24.
- Fraker P.J. and Speck Jr., J.C. 1978. Protein and cell membrane iodinations with a sparingly soluble chloroamide, 1,3,4,6-tetrachloro-3a,6a-diphenylglycoluril. *Biochem. Biophys. Res. Commun.* **80**: 849–857.
- Franci C. and Vidal J. 1988. Coupling redox and enzymic reactions improves the sensitivity of the ELISA-spot assay. *J. Immunol. Methods* **107**: 239–244.
- Fraser C.M., Gocayne J.D., White O., Adams M.D., Clayton R.A., Fleischmann R.D., Bult C.J., Kerlavage A.R., Sutton G., Kelley J.M., et al. 1995. The minimal gene complement of *Mycoplasma genitalium*. *Science* **270**: 397–403.
- Fraser C.M., Casjens S., Huang W.M., Sutton G.G., Clayton R., Lathigra R., White O., Ketchum K.A., Dodson R., Hickey E.K., et al. 1997. Genomic sequence of a Lyme disease spirochaete, *Borrelia burgdorferi*. *Nature* **390**: 580–586.
- Fraser C.M., Norris S.J., Weinstock G.M., White O., Sutton G.G., Dodson R., Gwinn M., Hickey E.K., Clayton R., Ketchum K.A., et al. 1998. Complete genome sequence of *Treponema pallidum*, the syphilis spirochete. *Science* **281**: 375–388.
- Freifelder D. 1971. Electron microscopic study of the ethidium bromide-DNA complex. *J. Mol. Biol.* **60**: 401–403.
- French B.T., Maul H.M., and Maul G.G. 1986. Screening cDNA expression libraries with monoclonal and polyclonal antibodies using an amplified biotin-avidin-peroxidase technique. *Anal. Biochem.* **156**: 417–423.
- Frischauf A.M., Garoff H., and Lehrach H. 1980. A subcloning strategy for DNA sequence analysis. *Nucleic Acids Res.* **8**: 5541–5549.
- Frischauf A.M., Lehrach H., Poustka A., and Murray N. 1983. Lambda replacement vectors carrying polylinker sequences. *J. Mol. Biol.* **170**: 827–842.
- Fursht A. 1985. *Enzyme structure and mechanism*, 2nd edition. W.H. Freeman, New York.
- Gaillard C. and Strauss F. 1990. Ethanol precipitation of DNA with linear acrylamide as a carrier. *Nucleic Acids Res.* **18**: 378.
- Galas D.J. and Schmitz A. 1978. DNAase footprinting: A simple method for the detection of protein-DNA binding specificity. *Nucleic Acids Res.* **5**: 3157–3170.
- Gallimore P.H., Sharp P.A., and Sambrook J. 1974. Viral DNA in transformed cells. II. A study of the sequences of adenovirus 2 DNA in nine lines of transformed rat cells using specific fragments of the genome. *J. Mol. Biol.* **89**: 49–72.
- Garner R.C. 1975. Testing of some benzidine analogues for microsomal activation to bacterial mutagens. *Cancer Lett.* **1**: 39–42.
- Gaugain B., Barbet J., Oberlin R., Roques B.P., and LePecq J.B. 1978. DNA bifunctional intercalators. I. Synthesis and conformational properties of an ethidium homodimer and of an acridine ethidium heterodimer. *Biochemistry* **17**: 5071–5078.
- Gelb L.D., Kohne D.E., and Martin M.A. 1971. Quantitation of simian virus 40 sequences in African green monkey, mouse and virus-transformed cell genomes. *J. Mol. Biol.* **57**: 129–145.
- Gerard G.F. 1983. Reverse transcriptase. In *Enzymes of nucleic acid synthesis and modification: DNA enzymes* (ed. S.T. Jacob), vol. 1, p. 1. CRC Press, Boca Raton, Florida.
- Gershoni J.M. 1988. Protein blotting: A manual. *Methods Biochem. Anal.* **33**: 1–58.
- Gershoni J.M. and Palade G.E. 1982. Electrophoretic transfer of proteins from sodium dodecyl sulfate-polyacrylamide gels to a positively charged membrane filter. *Anal. Biochem.* **124**: 396–405.
- Ghosh D. 1998. OOTFD (Object-Oriented Transcription Factors Database): An object-oriented successor to TFD. *Nucleic Acids Res.* **26**: 360–362.
- Gibson T.J. 1984. "Studies on the Epstein-Barr virus genome." Ph.D. thesis, Cambridge University, United Kingdom.
- Gillespie P.G. and Hudspeth A.J. 1991. Chemiluminescence detection of proteins from single cells. *Proc. Natl. Acad. Sci.* **88**: 2563–2567.
- Gish W. and States D.J. 1993. Identification of protein coding regions by database similarity search. *Nat. Genet.* **3**: 266–272.
- Glaser J. 1995. Validity of nucleic acid purities monitored by 260nm/280nm absorbance ratios. *BioTechniques* **18**: 62–63.
- Glazer A.N. and Rye H.S. 1992. Stable dye-DNA intercalation complexes as reagents for high sensitivity fluorescence detection. *Nature* **359**: 859–861.
- Glazer A.N., Peck K., and Mathies R.A. 1990. A stable double-stranded DNA-ethidium homodimer complex: Application to picogram fluorescence detection of DNA in agarose gels. *Proc. Natl. Acad. Sci.* **87**: 3851–3855.
- Goding J.W. 1978. Use of staphylococcal protein A as an immunological reagent. *J. Immunol. Methods* **20**: 241–253.
- Godson G.N. and Vapnek D. 1973. A simple method of preparing large amounts of  $\phi$ X174 RFI supercoiled DNA. *Biochim.*

- Biophys. Acta* **299**: 516–520.
- Goffeau A., Barrell B.G., Bussey H., Davis R.W., Dujon B., Feldmann H., Galibert F., Hoheisel J.D., Jacq C., Johnston M., Louis E.J., Mewes H.W., Murakami Y., Philippsen P., Tettelin H., and Oliver S.G. 1996. Life with 6000 genes. *Science* **274**: 546, 563–567.
- Goldberg D.A. 1980. Isolation and partial characterization of the *Drosophila* alcohol dehydrogenase gene. *Proc. Natl. Acad. Sci.* **77**: 5794–5798.
- Gomori G. 1946. Buffers in the range of pH 6.5 to 9.6. *Proc. Soc. Exp. Biol. Med.* **6**: 233–234.
- . 1955. Preparation of buffers for use in enzyme studies. *Methods Enzymol.* **1**: 138–146.
- Gonnott G.H., Cohen M.A., and Benner S.A. 1992. Exhaustive matching of the entire sequence database. *Science* **256**: 1443–1445.
- Good N.E. and Izawa S. 1972. Hydrogen ion buffers. *Methods Enzymol.* **24**: 53–68.
- Good N.E., Winget G.D., Winter W., Connolly T.N., Izawa S., and Singh R.M.M. 1966. Hydrogen ion buffers for biological research. *Biochemistry* **5**: 467–477.
- Gotoh O. 1995. A weight system and algorithm for aligning many phylogenetically related sequences. *Comput. Appl. Biosci.* **11**: 543–551.
- Goudswaard J., Van der Donk J.A., Noordzij A., van Dam R.H., and Vaerman J.-P. 1978. Protein A reactivity of various mammalian immunoglobulins. *Scand. J. Immunol.* **8**: 21–28.
- Gough J.A. and Murray N.E. 1983. Sequence diversity among related genes for recognition of specific targets in DNA molecules. *J. Mol. Biol.* **166**: 1–19.
- Gould S.J. and Subramani S. 1988. Firefly luciferase as a tool in molecular and cell biology. *Anal. Biochem.* **175**: 5–13.
- Gouy M. and Gautier C. 1982. Codon usage in bacteria: Correlation with gene expressivity. *Nucleic Acids Res.* **10**: 7055–7074.
- Graham Jr., R.C. and Karnovsky M.J. 1966. The early stages of absorption of injected horseradish peroxidase in the proximal tubules of mouse kidney: Ultrastructural cytochemistry by a new technique. *J. Histochem. Cytochem.* **14**: 291–302.
- Grantham R., Gautier C., Gouy M., Jacobzone M., and Mercier R. 1981. Codon catalog usage is a genome strategy modulated for gene expressivity. *Nucleic Acids Res.* **9**: r43–r74.
- Grantham R., Gautier C., Gouy M., Mercier R., and Pavé A. 1980. Codon catalog usage and the genome hypothesis. *Nucleic Acids Res.* **8**: r49–r62.
- Grassmann W. and Deffner G. 1953. Verteilungschromatographisches Verhalten von Proteinen und Peptiden in phenolhaltigen Lösungsmitteln. *Hoppe-Seyler's Z. Physiol. Chem.* **293**: 89–98.
- Gray Jr., H.B., Winston T.P., Hodnett J.L., Legerski R.J., Nees D.W., Wei C.-F., and Roberson D.L. 1981. The extracellular nuclease from *Alteromonas espejiana*: An enzyme highly specific for nonduplex structure in nominally duplex DNAs. In *Gene amplification and analysis: Structural analysis of nucleic acids* (ed. J.G. Chirikjian and T.S. Papas), vol. 2, pp. 169–203. Elsevier, New York.
- Green A.A. 1933. The preparation of acetate and phosphate buffer solutions of known pH and ionic strength. *J. Am. Chem. Soc.* **55**: 2331–2336.
- Green N.M. 1975. Avidin. *Adv. Protein Chem.* **29**: 85–133.
- Green N.M. and Toms E.J. 1972. The dissociation of avidin-biotin complexes by guanidinium chloride. *Biochem. J.* **130**: 707–711.
- . 1973. The properties of subunits of avidin coupled to sepharose. *Biochem. J.* **133**: 687–700.
- Greene P.H., Poonian M.S., Nussbaum A.L., Tobias L., Garfin D.E., Boyer H.W., and Goodman H.M. 1975. Restriction and modification of a self-complementary octanucleotide containing the EcoRI substrate. *J. Mol. Biol.* **99**: 237–261.
- Greenfield L., Simpson L., and Kaplan D. 1975. Conversion of closed circular DNA molecules to single-nicked molecules by digestion with DNAase I in the presence of ethidium bromide. *Biochim. Biophys. Acta* **407**: 365–375.
- Greenwood F.C., Hunter W.M., and Glover J.S. 1963. The preparation of <sup>131</sup>I-labelled human growth hormone of high specific radioactivity. *Biochem. J.* **89**: 114–123.
- Gronenborn A.M., Filpula D.R., Essig N.Z., Achari A., Whitlow M., Wingfield P.T., and Clore G.M. 1991. A novel, highly stable fold of the immunoglobulin binding domain of streptococcal protein G. *Science* **253**: 657–661.
- Grundy W.N., Bailey T.L., Elkan C.P., and Baker M.E. 1997. Meta-MEME: Motif-based hidden Markov models of proteins families. *Comput. Appl. Biosci.* **13**: 397–406.
- Guarente L. and Ptashne M. 1981. Fusion of *Escherichia coli lacZ* to the cytochrome *c* gene of *Saccharomyces cerevisiae*. *Proc. Natl. Acad. Sci.* **78**: 2199–2203.
- Gundermann K.-D. and McCapra F. 1987. *Chemiluminescence in organic chemistry*. Springer-Verlag, Berlin.
- Gunkel F.A. and Gassen H.G. 1989. Proteinase K from *Tritirachium album* Limber. Characterization of the chromosomal gene and expression of the cDNA in *Escherichia coli*. *Eur. J. Biochem.* **179**: 185–194.
- Gutell R.R. 1994. Collection of small subunit (16S- and 16S-like) ribosomal RNA structures. *Nucleic Acids Res.* **22**: 3502–3507.
- Hanahan D. 1983. Studies on transformation of *Escherichia coli* with plasmids. *J. Mol. Biol.* **166**: 557–580.
- . 1985. Techniques for transformation of *E. coli*. In *DNA cloning: A practical approach* (ed. D.M. Glover), vol. 1, p. 109–135. IRL Press, Oxford, United Kingdom.
- Hancock K. and Tsang V.C. 1983. India ink staining of proteins on nitrocellulose paper. *Anal. Biochem.* **133**: 157–162.
- Harlow E. and Lane D. 1988. *Antibodies: A laboratory manual*. Cold Spring Harbor Laboratory, Cold Spring Harbor, New York.
- . 1999. *Using antibodies: A laboratory manual*. Cold Spring Harbor Laboratory Press, Cold Spring Harbor, New York.
- Harper D.R. and Murphy G. 1991. Nonuniform variation in band pattern with luminol/horse radish peroxidase Western blotting. *Anal. Biochem.* **192**: 59–63.
- Hattman S., Brooks J.E. and Masurekar M. 1978. Sequence-specificity of the P1 modification methylase (*M.Eco* P1) and the DNA methylase (*M.Eco* dam) controlled by the *Escherichia coli dam* gene. *J. Mol. Biol.* **126**: 367–380.
- Hausen P. and Stein H. 1970. Ribonuclease H. An enzyme degrading the RNA moiety of DNA-RNA hybrids. *Eur. J. Biochem.* **14**: 278–283.
- Haussler D., Krogh A., Mian S., and Sjölander K. 1992. Protein modeling using hidden markov models. In *C.I.S. Technical Report UCSC-CRL-92-93*. University of California, Santa Cruz.
- Hawkes R. 1986. The dot immunobinding assay. *Methods Enzymol.* **121**: 484–491.
- Hawkes R., Niday E., and Gordon J. 1982. A dot-immunobinding assay for monoclonal and other antibodies. *Anal. Biochem.* **119**: 142–147.
- Hayashi K., Nakazawa M., Ishizaki Y., Hiraoka N., and Obayashi

- A. 1986. Regulation of inter- and intramolecular ligation with T4 DNA ligase in the presence of polyethylene glycol. *Nucleic Acids Res.* **14**: 7617-7631.
- Hegenauer R. 1971. Pflanzstoffe und Pflanzensystematik. *Naturwissenschaften* **58**: 585-598.
- Heinemeyer T., Chen X., Karas H., Krel A.E., Kel O.V., Liebach I., Meinhardt T., Reuter I., Schacherer E., and Wingender E. 1999. Expanding the TRANSFAC database towards an expert system of regulatory molecular mechanisms. *Nucleic Acids Res.* **27**: 318-322.
- Heitman J. and Model P. 1987. Site-specific methylases induce the SOS DNA repair response in *Escherichia coli*. *J. Bacteriol.* **169**: 3243-3250.
- Hemmati-Brivanlou A., Frank D., Bolce M.E., Brown B.D., Sive H.L., and Harland R.M. 1990. Localization of specific mRNAs in *Xenopus* embryos by whole-mount *in situ* hybridization. *Development* **110**: 325-330.
- Hengen P.N. 1997. Shearing DNA for genomic library construction. *Trends Biochem. Sci.* **22**: 273-274.
- Henikoff J.G., Henikoff S., and Pietrokovski S. 1999a. New features of the Blocks Database servers. *Nucleic Acids Res.* **27**: 226-228.
- . 1999b. Blocks+: A non-redundant database of protein alignment blocks derived from multiple compilations. *Bioinformatics* **15**: 471-479.
- Henikoff S. 1984. Unidirectional digestion with exonuclease III creates targeted breakpoints for DNA sequencing. *Gene* **28**: 351-359.
- Henikoff S. and Henikoff J.G. 1991. Automated assembly of protein blocks for database searching. *Nucleic Acids Res.* **19**: 6565-6572.
- . 1992. Amino acid substitution matrices from protein blocks. *Proc. Natl. Acad. Sci.* **89**: 10915-10919.
- . 1993. Performance evaluation of amino acid substitution matrices. *Protein* **17**: 49-61.
- . 1994. Protein family classification based on searching a database of blocks. *Genomics* **19**: 97-107.
- Henikoff S., Henikoff J.G., Alford W.J., and Pietrokovski S. 1995. Automated construction and graphical presentation of protein blocks from unaligned sequences. *Gene* **163**: GC17-26.
- Herrin D.L. and Schmidt G.W. 1988. Rapid, reversible staining of northern blots prior to hybridization. *BioTechniques* **6**: 196-200.
- Hertz G.Z. and Stormo G.D. 1995. Identification of consensus patterns in unaligned DNA and protein sequences: A large deviation statistical basis for penalizing gaps. In *Proceedings of the 3rd International Conference on Bioinformatics and Genome Research* (ed. H.A. Lim and C.R. Cantor), pp. 201-216. World Scientific, Singapore.
- . 1999. Identifying DNA and protein patterns with statistically significant alignments of multiple sequences. *Bioinformatics* **15**: 563-577.
- Higgins D.G. and Sharp P.M. 1988. CLUSTAL: A package for performing multiple sequence alignment on a microcomputer. *Gene* **73**: 237-244.
- Higgins D.G., Bleasby A.J., and Fuchs R. 1992. CLUSTAL V: Improved software for multiple sequence alignment. *Comput. Appl. Biosci.* **8**: 189-191.
- Higo K., Ugawa Y., Iwamoto M., and Korenaga T. 1999. Plant cis-acting regulatory DNA elements (PLACE) database: 1999. *Nucleic Acids Res.* **27**: 297-300.
- Hilwig I. and Gropp A. 1975. pH-dependent fluorescence of DNA and RNA in cytologic staining with "33258 Hoechst". *Exp. Cell Res.* **91**: 457-460.
- Hilz H., Wieggers U., and Adamietz P. 1975. Stimulation of proteinase K action by denaturing agents: Application to the isolation of nucleic acids and the degradation of 'masked' proteins. *Eur. J. Biochem.* **56**: 103-108.
- Himmelreich R., Hilbert H., Plagens H., Pirkl E., Li B.C., and Herrmann R. 1996. Complete sequence analysis of the genome of the bacterium *Mycoplasma pneumoniae*. *Nucleic Acids Res.* **24**: 4420-4449.
- Hjelm H., Hjelm K., and Sjöquist J. 1972. Protein A from *Staphylococcus aureus*. Its isolation by affinity chromatography and its use as an immunosorbent for isolation of immunoglobulins. *FEBS Lett.* **28**: 73-76.
- Hodgson M. and Jones P. 1989. Enhanced chemiluminescence in the peroxidase-luminol-H<sub>2</sub>O<sub>2</sub> system: Anomalous reactivity of enhancer phenols with enzyme intermediates. *J. Biolumin. Chemilumin.* **3**: 21-25.
- Hofacker I.L., Fontana W., Stadler P.F., Bonhoeffer S., Tacker M., and Schuster P. 1994. Fast folding and comparison of RNA secondary structures. *Monatsh. Chem.* **125**: 167-188.
- Hohn B. 1979. *In vitro* packaging of  $\lambda$  and cosmid DNA. *Methods Enzymol.* **68**: 299-309.
- Hohn B. and Murray K. 1977. Packaging recombinant DNA molecules into bacteriophage particles *in vitro*. *Proc. Natl. Acad. Sci.* **74**: 3259-3263.
- Holm L. and Sander C. 1996. Mapping the protein universe. *Science* **273**: 595-603.
- Holmstrom K., Rossen L., and Rasmussen O.F. 1993. A highly sensitive and fast nonradioactive method for detection of polymerase chain reaction products. *Anal. Biochem.* **209**: 278-283.
- Höltke H.-J. and Kessler C. 1990. Non-radioactive labeling of RNA transcripts *in vitro* with the hapten digoxigenin (DIG): Hybridization and ELISA-based detection. *Nucleic Acids Res.* **18**: 5843-5851.
- Höltke H.-J., Ettl J., Obermaier J., and Schmitz G. 1991. Sensitive chemiluminescent detection of digoxigenin (DIG) labeled nucleic acids. A fast and simple protocol and its applications. In *Bioluminescence and chemiluminescence: Current status* (ed. P.E. Stanley and L.J. Kricka), pp. 179-182. Wiley, Chichester, United Kingdom.
- Höltke H.-J., Seibl R., Burg J., Mühlegger K., and Kessler C. 1990. Non-radioactive labeling and detection of nucleic acids. II. Optimization of the digoxigenin system. *Biol. Chem. Hoppe-Seyler* **371**: 929-938.
- Hong G.F. 1982. A systemic DNA sequencing strategy. *J. Mol. Biol.* **158**: 539-549.
- Hostomsky Z., Hostomska Z., and Matthews D.A. 1993. Ribonucleases H. In *Nucleases*, 2nd edition (ed. S.M. Linn et al.), pp. 341-376. Cold Spring Harbor Laboratory Press, Cold Spring Harbor, New York.
- Huang X. and Miller W. 1991. A time-efficient linear-space local similarity algorithm. *Adv. Appl. Math.* **12**: 337-357.
- Huang X., Hardison R.C., and Miller W. 1990. A space-efficient algorithm for local similarities. *Comput. Appl. Biosci.* **6**: 373-381.
- Hudson L.G., Santon J.B., and Gill G.N. 1989. Regulation of epidermal growth factor receptor gene expression. *Mol. Endocrinol.* **3**: 400-408.
- Hughey R. and Krogh A. 1995. SAM: Sequence alignment and modeling software system. In *C.I.S. Technical Report UCSC-CRL-95-7*. University of California, Santa Cruz.
- . 1996. Hidden Markov models for sequence analysis:

- Extension and analysis of the basic method. *Comput. Appl. Biosci.* **12**: 95–107.
- Hunkapiller M.W., Lujan E., Ostrander F., and Hood L.E. 1983. Isolation of microgram quantities of proteins from polyacrylamide gels for amino acid sequence analysis. *Methods Enzymol.* **91**: 227–236.
- Hunter W.M. and Greenwood F.C. 1962. Preparation of iodine-131 labelled human growth hormone of high specific activity. *Nature* **194**: 495–496.
- Hurn B.A. and Chantler S.M. 1980. Production of reagent antibodies. *Methods Enzymol.* **70**: 104–142.
- Ikeda S. and Oda T. 1993. Nonisotopic gel-mobility shift assay using chemiluminescent detection. *BioTechniques* **14**: 878–880.
- Ikemura T. 1982. Correlation between the abundance of yeast transfer RNAs and the occurrence of the respective codons in protein genes. *J. Mol. Biol.* **158**: 573–597.
- . 1985. Codon usage and tRNA content in unicellular and multicellular organisms. *Mol. Biol. Evol.* **2**: 13–34.
- Isaacson U. and Wettermark G. 1974. Chemiluminescence in analytical chemistry. *Anal. Chim. Acta* **68**: 339–362.
- ISCO. 1982. *ISCOTABLES: A handbook of data for biological and physical scientists*, 8th edition. ISCO, Inc., Lincoln, Nebraska.
- Jacobsen H., Klenow H., and Overgaard-Hansen K. 1974. The N-terminal amino-acid sequences of DNA polymerase I from *Escherichia coli* and of the large and the small fragments obtained by a limited proteolysis. *Eur. J. Biochem.* **45**: 623–627.
- Jaeger J.A., Turner D.H., and Zuker M. 1989. Improved predictions of secondary structures for RNA. *Proc. Natl. Acad. Sci.* **86**: 7706–7710.
- Jain V.K. and Magrath I.T. 1991. A chemiluminescent assay for quantitation of  $\beta$ -galactosidase in the femtogram range: Application to quantitation of  $\beta$ -galactosidase in *lac Z*-transfected cells. *Anal. Biochem.* **199**: 639–650.
- Jamin J. 1979. Surface and inside volumes in globular proteins. *Nature* **277**: 491–492.
- Jany K.-D., Lederer G., and Mayer B. 1986. Amino acid sequence of proteinase K from the mold *Tritirachium album* Limber. *FEBS Lett.* **199**: 139–144.
- Jendrisak J., Young R.A., and Engel J.D. 1987. Cloning cDNA into  $\lambda$ gt10 and  $\lambda$ gt11. *Methods Enzymol.* **152**: 359–371.
- Jerpseth B., Greener A., Short J.M., Viola J., and Kretz P.L. 1992. XL1-Blue MRF *E. coli* cells. In *Strategies Newsletter*, vol. 5, pp. 81–83. Stratagene, La Jolla, California.
- Johansson S. and Skoog B. 1987. Rapid silver staining of polyacrylamide gels. *J. Biochem. Biophys. Methods* (suppl.) **14**: 33.
- Johnson D.A., Gautsch J.W., Sportsman J.R., and Elder J.H. 1984. Improved technique utilizing nonfat dry milk for analysis of proteins and nucleic acids transferred to nitrocellulose. *Gene Anal. Tech.* **1**: 3–8.
- Johnson E.H., Shimomura O., Saiga Y., Gershman L.C., Reynolds G.T., and Waters J.R. 1962. Quantum efficiency of *Cypridina* luminescence, with a note on that of *Aequorea*. *J. Cell. Comp. Physiol.* **60**: 85–103.
- Johnston T.C., Thompson R.B., and Baldwin T.O. 1986. Nucleotide sequence of the *luxB* gene of *Vibrio harveyi* and the complete amino acid sequence of the  $\beta$  subunit of bacterial luciferase. *J. Biol. Chem.* **261**: 4805–4811.
- Jollés P. 1960. Lysozyme. In *The Enzymes*, 2nd edition (ed. P.D. Boyer et al.), pp. 431–445. Academic Press, New York.
- Jones D.T., Taylor W.R., and Thornton J.M. 1992. The rapid generation of mutation data matrices from protein sequences. *Comput. Appl. Biosci.* **8**: 275–282.
- Jónsson Z.O., Thorbjarnardóttir S.H., Eggertsson G., and Palsdóttir A. 1994. Sequence of the DNA ligase-encoding gene from *Thermus scotoductus* and conserved motifs in DNA ligases. *Gene* **151**: 177–180.
- Joyce C.M. and Grindley N.D.F. 1983. Construction of a plasmid that overproduces the large proteolytic fragment (Klenow fragment) of DNA polymerase I of *Escherichia coli*. *Proc. Natl. Acad. Sci.* **80**: 1830–1834.
- Jung Y.H. and Lee Y. 1995. RNases in ColE1 DNA metabolism. *Mol. Biol. Rep.* **22**: 195–200.
- Kalman S., Mitchell W., Marathe R., Lammel C., Fan J., Hyman R.W., Olinger L., Grimwood J., Davis R.W., and Stephens R.S. 1999. Comparative genomes of *Chlamydia pneumoniae* and *C. trachomatis*. *Nat. Genet.* **21**: 385–389.
- Kan N.C., Lautenberger J.A., Edgell M.H., and Hutchison C.A. 1979. The nucleotide sequence recognized by the *Escherichia coli* K12 restriction and modification enzymes. *J. Mol. Biol.* **130**: 191–209.
- Kanaya S. and Ikehara M. 1995. Functions and structures of ribonuclease H enzymes. *Subcell. Biochem.* **24**: 377–422.
- Kaneko T., Sato S., Kotani H., Tanaka A., Asamizu E., Nakamura Y., Miyajima N., Hirosawa M., Sugiura M., Sasamoto S., et al. 1996. Sequence analysis of the genome of the unicellular cyanobacterium *Synechocystis* sp. strain PCC6803. II. Sequence determination of the entire genome and assignment of potential protein-coding regions. *DNA Res.* **3**: 109–136.
- Karger A.E., Weiss R., and Gesteland R.F. 1993. Line scanning system for direct digital chemiluminescence imaging of DNA sequencing blots. *Anal. Chem.* **65**: 1785–1793.
- Karlin S. and Altschul S.F. 1990. Methods for assessing the statistical significance of molecular sequence features by using general scoring schemes. *Proc. Natl. Acad. Sci.* **87**: 2264–2268.
- . 1993. Applications and statistics for multiple high-scoring segments in molecular sequences. *Proc. Natl. Acad. Sci.* **90**: 5873–5877.
- Karlin S. and Bucher P. 1992. Correlation analysis of amino acid usage in protein classes. *Proc. Natl. Acad. Sci.* **89**: 12165–12169.
- Karn J., Brenner S., Barnett L., and Cesareni G. 1980. Novel bacteriophage  $\lambda$  cloning vector. *Proc. Natl. Acad. Sci.* **77**: 5172–5176.
- Kawarabayasi Y., Sawada M., Horikawa H., Haikawa Y., Hino Y., Yamamoto S., Sekine M., Baba S., Kosugi H., Hosoyama A., et al. 1998. Complete sequence and gene organization of the genome of a hyper-thermophilic archaeobacterium, *Pyrococcus horikoshii* OT3. *DNA Res.* **5**: 55–76.
- Keller G.-A., Gould S., DeLuca M., and Subramani S. 1987. Firefly luciferase is targeted to peroxisomes in mammalian cells. *Proc. Natl. Acad. Sci.* **84**: 3264–3268.
- Kelley W.S. and Stump K.H. 1979. A rapid procedure for isolation of large quantities of *Escherichia coli* DNA polymerase I utilizing a  $\lambda$ polA transducing phage. *J. Biol. Chem.* **254**: 3206–3210.
- Kerkhof L. 1992. A comparison of substrates for quantifying the signal from a nonradiolabeled DNA probe. *Anal. Biochem.* **205**: 359–364.
- Kessler C. 1991. The digoxigenin:anti-digoxigenin (DIG) technology — A survey on the concept and realization of a novel bioanalytical indicator system. *Mol. Cell. Probes* **5**: 161–205.
- Kessler C. and Manta V. 1990. Specificity of restriction endonuclease and DNA modification methyltransferases — A review.



- Gene* **92**: 1–248.
- Kessler C., Höltke H.-J., Seibl R., Burg J., and Mühlegger K. 1989. A novel DNA labeling and detection system based on digoxigenin: Anti-digoxigenin ELISA principle. *J. Clin. Chem. Clin. Biochem.* **27**: 130–131.
- . 1990. Non-radioactive labeling and detection of nucleic acids. I. A novel DNA labeling and detection system based on digoxigenin: Anti-digoxigenin ELISA principle (digoxigenin system). *Biol. Chem. Hoppe-Seyler* **371**: 917–927.
- Kim Y., Grable J.C., Love R.J., Greene P.J., and Rosenberg J.M. 1990. Refinement of EcoRI endonuclease crystal structure: A revised chain tracing. *Science* **249**: 1307–1309.
- Kinkel T., Lubbers H., Schmidt E., Molz P., and Skrzypczyk H.J. 1989. Synthesis and properties of new luminescent acridinium-9-carboxylic acid derivatives and their application in luminescence immunoassays (LIA). *J. Biolumin. Chemilumin.* **4**: 136–139.
- Kirby K.S. 1956. A new method for the isolation of ribonucleic acids from mammalian tissues. *Biochem. J.* **64**: 405.
- . 1957. A new method for the isolation of deoxyribonucleic acids: Evidence on the nature of bonds between deoxyribonucleic acid and protein. *Biochem. J.* **66**: 495–504.
- . 1964. Isolation and fractionation of nucleic acids. *Prog. Nucleic Acid Res. Mol. Biol.* **3**: 1–31.
- Kirchner G., Roberts J.L., Gustafson G.D., and Ingolia T.D. 1989. Active bacterial luciferase from a fused gene: Expression of a *Vibrio harveyi luxAB* translational fusion in bacteria, yeast and plant cells. *Gene* **81**: 349–354.
- Klenk H.P., Clayton R.A., Tomb J.F., White O., Nelson K.E., Ketchum K.A., Dodson R.J., Gwinn M., Hickey E.K., Peterson J.D., et al. 1997. The complete genome sequence of the hyperthermophilic, sulphate-reducing archaeon *Archaeoglobus fulgidus* (erratum *Nature* [1998] **394**: 101). *Nature* **390**: 364–370.
- Klenow H. and Henningsen I. 1970. Selective elimination of the exonuclease activity of the deoxyribonucleic acid polymerase from *Escherichia coli* B by limited proteolytic digestion. *Proc. Natl. Acad. Sci.* **65**: 168–175.
- Klimasauskas S., Kumar S., Roberts R.J., and Cheng X. 1994. HhaI methyltransferase flips its target base out of the DNA helix. *Cell* **76**: 357–369.
- Klug A., Jack A., Viswamitra M.A., Kennard O., Shakked Z., and Steitz T.A. 1979. A hypothesis on a specific sequence-dependent conformation of DNA and its relation to the binding of the *lac*-repressor protein. *J. Mol. Biol.* **131**: 669–680.
- Knecht D.A. and Dimond R.L. 1984. Visualization of antigenic proteins on Western blots. *Anal. Biochem.* **136**: 180–184.
- Kobatake E., Ikariyama Y., and Aizawa M. 1995. Production of the chimeric-binding protein, maltose-binding protein-protein A, by gene fusion. *J. Biotechnol.* **38**: 263–268.
- Kohen F., Pazzagli M., Kim J.B., and Lindner H.R. 1979. An assay procedure for plasma progesterone based on antibody enhanced chemiluminescence. *FEBS Lett.* **104**: 140–143.
- Kolchanov N.A., Ananko E.A., Podkolodnaya O.A., Ignatieva E.V., Stepanenko I.L., Kel-Margoulis O.V., Kel A.E., Merkulova T.I., Goryachkovskaya T.N., Busygina T.V., Kolpakov F.A., Podkolodny N.L., Naumochkin A.N., and Romashchenko A.G. 1999. Transcription Regulatory Regions Database (TRRD): Its status in 1999. *Nucleic Acids Res.* **27**: 303–306.
- Koncz C., Olsson O., Langridge W.H.R., Shell J., and Szalay A.A. 1987. Expression and assembly of functional bacterial luciferase in plants. *Proc. Natl. Acad. Sci.* **84**: 131–135.
- Korab-Laskowska M., Rioux P., Brossard N., Littlejohn T.G., Gray M.W., Lang B.F., and Burger G. 1998. The Organelle Genome Database Project (GOBASE). *Nucleic Acids Res.* **26**: 138–144.
- Koren J.F., Melo T.B., and Prydz S. 1970. Enhanced photoemulsion sensitivity at low temperatures used in radiochromatography. *J. Chromatogr.* **46**: 129–131.
- Kornberg A. and Baker T.A. 1992. Topoisomerases. In *DNA replication*, 2nd edition, pp. 379–401. W.H. Freeman, New York.
- Kornberg T. and Kornberg A. 1974. Bacterial DNA polymerases. In *The enzymes*, 3rd edition (ed. P.D. Boyer), vol. 10, p. 119. Academic Press, New York.
- Kotewicz M.L., Sampson C.M., D'Alessio J.M., and Gerard G.F. 1988. Isolation of cloned Moloney murine leukemia virus reverse transcriptase lacking ribonuclease H activity. *Nucleic Acids Res.* **16**: 265–277.
- Kramer J.A., Singh G.B., and Krawetz S.A. 1996. Computer-assisted search for sites of nuclear matrix attachment. *Genomics* **33**: 305–308.
- Krause A., Nicodeme P., Bornberg-Bauer E., Rehmsmeier M., and Vingron M. 1999. WWW access to the SYSTERS protein sequence cluster set. *Bioinformatics* **15**: 262–263.
- Kricka L.J. 1991. Chemiluminescent and bioluminescent techniques. *Clin. Chem.* **37**: 1472–1481.
- . 1992. *Nonisotopic DNA probe techniques*. Academic Press, San Diego, California.
- Kricka L.J. and DeLuca M. 1982. Effects of solvents on the catalytic activity of firefly luciferase. *Arch. Biochem. Biophys.* **217**: 674–681.
- Kricka L.J. and Stanley P.E. 1992. Bioluminescence and chemiluminescence literature—1991: Part I. *J. Biolumin. Chemilumin.* **7**: 47–73.
- Kricka L.J. and Thorpe G.H. 1986. Photographic detection of chemiluminescent and bioluminescent reactions. *Methods Enzymol.* **133**: 404–420.
- Kricka L.J., Nozaki O., and Stanley P.E. 1993. Bioluminescence and chemiluminescence literature—1992: Part I. *J. Biolumin. Chemilumin.* **8**: 169–182.
- Kroeker W.D. and Kowalski D. 1978. Gene-sized pieces produced by digestion of linear duplex DNA with mung bean nuclease. *Biochemistry* **17**: 3236–3243.
- Kronvall G. 1973. A surface component in group A, C, and G streptococci with non-immune reactivity for immunoglobulin G. *J. Immunol.* **111**: 1401–1406.
- Kronvall G., Grey H.M., and Williams Jr., R.C. 1970a. Protein A reactivity with mouse immunoglobulins. Structural relationship between some mouse and human immunoglobulins. *J. Immunol.* **105**: 1116–1123.
- Kronvall G., Seal U.S., Finstad J., and Williams Jr., R.C. 1970b. Phylogenetic insight into evolution of mammalian Fc fragment of  $\lambda$ G globulin using staphylococcal protein A. *J. Immunol.* **104**: 140–147.
- Kulp D., Haussler D., Reese M.G., and Eeckman F.H. 1996. A generalized hidden Markov model for the recognition of human genes in DNA. *Ismb* **4**: 134–142.
- Kumar S., Cheng X., Klimasauskas S., Mi S., Posfai J., Roberts R.J., and Wilson G.G. 1994. The DNA (cytosine-5) methyltransferases. *Nucleic Acids Res.* **22**: 1–10.
- Kunitz M. 1950. Crystalline deoxyribonuclease. II. Digestion of thymus nucleic acid (deoxyribonucleic acid). The kinetics of the reaction. *J. Gen. Physiol.* **33**: 363–377.
- Kunkel T.A., Roberts J.D., and Zakour R.A. 1987. Rapid and efficient site-specific mutagenesis without phenotypic selection. *Methods Enzymol.* **154**: 367–382.

- Kunst E., Ogasawara N., Moszer I., Albertini A.M., Alloni G., Azevedo V., Bertero M.G., Bessières P., Bolotin A., Borchert S., et al. 1997. The complete genome sequence of the gram-positive bacterium *Bacillus subtilis*. *Nature* **390**: 249–256.
- Kyte J. and Doolittle R.F. 1982. A simple method for displaying the hydropathic character of a protein. *J. Mol. Biol.* **157**: 105–132.
- Labarca C. and Paigen K. 1980. A simple, rapid and sensitive DNA assay procedure. *Anal. Biochem.* **102**: 344–352.
- Laemmli U.K. 1970. Cleavage of structural proteins during the assembly of the head of bacteriophage T4. *Nature* **227**: 680–685.
- Lafontaine D.A., Deschenes P., Bussiere F., Poisson V., and Perreault J.P. 1999. The viroid and viroid-like RNA database. *Nucleic Acids Res.* **27**: 186–187.
- Langone J.J. 1980. Radioiodination by use of the Bolton-Hunter and related reagents. *Methods Enzymol.* **70**: 221–247.
- . 1982. Protein A of *Staphylococcus aureus* and related immunoglobulin receptors produced by streptococci and pneumococci. *Adv. Immunol.* **32**: 157–252.
- Laskey R.A. 1980. The use of intensifying screens or organic scintillators for visualizing radioactive molecules resolved by gel electrophoresis. *Methods Enzymol.* **65**: 363–371.
- Laskey R.A. and Mills A.D. 1975. Quantitative film detection of <sup>3</sup>H and <sup>14</sup>C in polyacrylamide gels by fluorography. *Eur. J. Biochem.* **56**: 335–341.
- . 1977. Enhanced autoradiographic detection of <sup>32</sup>P and <sup>125</sup>I using intensifying screens and hypersensitized film. *FEBS Lett.* **82**: 314–316.
- Laskowski Sr., M. 1980. Purification and properties of the mung bean nuclease. *Methods Enzymol.* **65**: 263–276.
- Lathe R. 1985. Synthetic oligonucleotide probes deduced from amino acid sequence data: Theoretical and practical considerations. *J. Mol. Biol.* **183**: 1–12.
- Latt S.A. and Wohlleb J.C. 1975. Optical studies of the interaction of 33258 Hoechst with DNA, chromatin and metaphase chromosomes. *Chromosoma* **52**: 297–316.
- Lau P.P. and Gray Jr., H.B. 1979. Extracellular nucleases of *Alteromonas espejiana* BAL 31. IV. The single strand-specific deoxyriboendonuclease activity as a probe for regions of altered secondary structure in negatively and positively supercoiled closed circular DNA. *Nucleic Acids Res.* **6**: 331–357.
- Lauer G., Rudd E.A., McKay D.L., Ally A., Ally D., and Backman K.C. 1991. Cloning, nucleotide sequence, and engineered expression of *Thermus thermophilus* DNA ligase, a homolog of *Escherichia coli* DNA ligase. *J. Bacteriol.* **173**: 5047–5053.
- Law S.-J., Miller T., Piran U., Klukas C., Chang S., and Unger J. 1989. Novel poly-substituted aryl acridinium esters and their use in immunoassay. *J. Biolumin. Chemilumin.* **4**: 88–98.
- Lawrence C.E., Altschul S.F., Boguski M.S., Liu J.S., Neuwald A.F., and Wootton J.C. 1993. Detecting subtle sequence signals: A Gibbs sampling strategy for multiple alignment. *Science* **262**: 208–214.
- Leary J.J., Brigati D.J., and Ward D.C. 1983. Rapid and sensitive colorimetric method for visualizing biotin-labeled DNA probes hybridized to DNA or RNA immobilized on nitrocellulose: Bio-blots. *Proc. Natl. Acad. Sci.* **80**: 4045–4049.
- Leder P., Tiemeier D., and Enquist L. 1977. EK2 derivatives of bacteriophage lambda useful in the cloning of DNA from higher organisms: The λgtWES system. *Science* **196**: 175–177.
- Legerski R.J., Hodnett J.L., and Gray Jr., H.B. 1978. Extracellular nucleases of *Pseudomonas* BAL 31. III. Use of the double-strand deoxyriboendonuclease activity as the basis of a convenient method for the mapping of fragments of DNA produced by cleavage with restriction enzymes. *Nucleic Acids Res.* **5**: 1445–1464.
- Legocki R.P., Legocki M., Baldwin T.O., and Szalay A.A. 1986. Bioluminescence in soybean root nodules: Demonstration of a general approach to assay gene expression *in vivo* by using bacterial luciferase. *Proc. Natl. Acad. Sci.* **83**: 9080–9084.
- Lehman I.R. 1981. DNA polymerase I of *Escherichia coli*. In *The enzymes*, 3rd edition (ed. P.D. Boyer), vol. 14, pp. 15–37. Academic Press, New York.
- Lehrach H., Diamond D., Wozney J.M., and Boedtker H. 1977. RNA molecular weight determinations by gel electrophoresis under denaturing conditions, a critical reexamination. *Biochemistry* **16**: 4743–4751.
- LePecq J.B. and Paoletti C. 1967. A fluorescent complex between ethidium bromide and nucleic acids. Physical-chemical characterization. *J. Mol. Biol.* **27**: 87–106.
- Lerner R.A. 1984. Antibodies of predetermined specificity in biology and medicine. *Adv. Immunol.* **36**: 1–44.
- Levinson A., Silver D., and Seed B. 1984. Minimal size plasmids containing an M13 origin for production of single-stranded transducing particles. *J. Mol. Appl. Genet.* **2**: 507–517.
- Limbach P.A., Crain P.F., and McCloskey J.A. 1994. Summary: The modified nucleosides of RNA. *Nucleic Acids Res.* **22**: 2183–2196.
- Lin J.J., Smith M., Jessee J., and Bloom F. 1992. DH11S: An *Escherichia coli* strain for preparation of single-stranded DNA from phagemid vectors. *BioTechniques* **12**: 718–721.
- Lin W. and Kasamatsu H. 1983. On the electrotransfer of polypeptides from gels to nitrocellulose membranes. *Anal. Biochem.* **128**: 302–311.
- Lind I., Live I., and Mansa B. 1970. Variation in staphylococcal protein A reactivity with gamma G-globulins of different species. *Acta Pathol. Microbiol. Scand. B Microbiol. Immunol.* **78**: 673–682.
- Lindbladh C., Persson M., Bulow L., Stahl S., and Mosbach K. 1987. The design of a simple competitive ELISA using human proinsulin-alkaline phosphatase conjugates prepared by gene fusion. *Biochem. Biophys. Res. Commun.* **149**: 607–614.
- Lindsay S. and Bird A.P. 1987. Use of restriction enzymes to detect potential gene sequences in mammalian DNA. *Nature* **327**: 336–338.
- Lipman D.J., Altschul S.F., and Kececioglu J. 1989. A tool for multiple sequence alignment. *Proc. Natl. Acad. Sci.* **86**: 4412–4415.
- Lis J.T. 1980. Fractionation of DNA fragments by polyethylene glycol induced precipitation. *Methods Enzymol.* **65**: 347–353.
- Lis J.T. and Schleif R. 1975a. Size fractionation of double-stranded DNA by precipitation with polyethylene glycol. *Nucleic Acids Res.* **2**: 383–389.
- . 1975b. The regulatory region of the L-arabinose operon: Its isolation on a 1000 base-pair fragment from DNA heteroduplexes. *J. Mol. Biol.* **95**: 409–416.
- Little J.W. 1981. Lambda exonuclease. *Gene Amplif. Anal.* **2**: 135–145.
- Little J.W., Lehman I.R., and Kaiser A.D. 1967. An exonuclease induced by bacteriophage lambda. I. Preparation of the crystalline enzyme. *J. Biol. Chem.* **242**: 672–678.
- Lomonosoff G.P., Butler P.J., and Klug A. 1981. Sequence-dependent variation in the conformation of DNA. *J. Mol. Biol.* **149**: 745–760.
- Loontjens F.G., Regenfuss P., Zechel A., Dumortier L., and Clegg

- R.M. 1990. Binding characteristics of Hoechst 33258 with calf thymus DNA, poly[d(A-T)], and d(CCGGAATTCGG): Multiple stoichiometries and determination of tight binding with a wide spectrum of site affinities. *Biochemistry* **29**: 9029-9039.
- Low B. 1968. Formation of merodiploids in matings with a class of Rec<sup>-</sup> recipient strains of *Escherichia coli* K12. *Proc. Natl. Acad. Sci.* **60**: 160-167.
- Lowe T.M. and Eddy S.R. 1997. tRNAscan-SE: A program for improved detection of transfer RNA genes in genomic sequence. *Nucleic Acids Res.* **22**: 955-964.
- . 1999. A computational screen for methylation guide snoRNAs in yeast. *Science* **283**: 1168-1171.
- Luckow B., Renkawitz R., and Schütz G. 1987. A new method for constructing linker scanning mutants. *Nucleic Acids Res.* **15**: 417-429.
- Lukashin A.V. and Borodovsky M. 1998. GeneMark.hmm: New solutions for gene finding. *Nucleic Acids Res.* **26**: 1107-1115.
- Lunn G. and Sansone E.B. 1987. Ethidium bromide: Destruction and decontamination of solutions. *Anal. Biochem.* **162**: 453-458.
- Maanich C. and Schneider W. 1941. Über die Glykoside von *Digitalis orientalis* L. *Arch. Pharm.* **279**: 223-248.
- MacGregor J.T. and Johnson I.J. 1977. In vitro metabolic activation of ethidium bromide and other phenanthridinium compounds: Mutagenic activity in *Salmonella typhimurium*. *Mutat. Res.* **48**: 103-107.
- Mahler H.R. and Bastos R.N. 1974. Coupling between mitochondrial mutation and energy transduction. *Proc. Natl. Acad. Sci.* **71**: 2241-2245.
- Main R.K. and Cole L.J. 1957. Chromatography of deoxyribonucleic acids on calcium phosphate columns. *Arch. Biochem. Biophys.* **68**: 186-195.
- Main R.K., Wilkins M.J., and Cole L.J. 1959. A modified calcium phosphate for column chromatography of polynucleotides and proteins. *J. Am. Chem. Soc.* **81**: 6490-6495.
- Malone R.W., Felgner P.L., and Verma I. M. 1989. Cationic liposome-mediated RNA transfection. *Proc. Natl. Acad. Sci.* **86**: 6077-6081.
- Manchester K.L. 1995. Value of  $A_{260/280}$  ratios for measurement of purity of nucleic acids. *BioTechniques* **19**: 208-219.
- . 1996. Use of UV methods for the measurement of protein and nucleic acid concentrations. *BioTechniques* **20**: 968-970.
- Maniatis T., Jeffrey A., and Kleid D.G. 1975. Nucleotide sequence of the rightward operator of phage lambda. *Proc. Natl. Acad. Sci.* **72**: 1184-1188.
- Maniatis T., Hardison R.C., Lacy E., Lauer J., O'Connell C., Quon D., Sim G.K., and Efstratiadis A. 1978. The isolation of structural genes from libraries of eucaryotic DNA. *Cell* **15**: 687-701.
- Manoil C., Mekalanos J.J., and Beckwith J. 1990. Alkaline phosphatase fusions: Sensors of subcellular location. *J. Bacteriol.* **172**: 515-518.
- Marinus M.G. 1973. Location of DNA methylation genes on the *Escherichia coli* K-12 genetic map. *Mol. Gen. Genet.* **127**: 47-55.
- . 1987. Methylation of DNA. In *Escherichia coli and Salmonella typhimurium: Cellular and molecular biology* (ed. F.C. Neidhardt et al.), vol. 1, pp. 697-702. American Society for Microbiology, Washington, D.C.
- Marinus M.G. and Morris N.R. 1973. Isolation of deoxyribonucleic acid methylase mutants of *Escherichia coli* K-12. *J. Bacteriol.* **114**: 1143-1150.
- Markwell M.A. 1982. A new solid-state reagent to iodinate proteins. I. Conditions for the efficient labeling of antiserum. *Anal. Biochem.* **125**: 427-432.
- Marshall J., Molloy R., Moss G.W., Howe J.R., and Hughes T.E. 1995. The jellyfish green fluorescent protein: A tool for studying ion channel expression and function. *Neuron* **14**: 211-215.
- Martin C., Bresnick L., Juo R.R., Voyta J.C., and Bronstein J. 1991. Improved chemiluminescent DNA sequencing. *BioTechniques* **11**: 110-113.
- Martinson H.G. and Wagenaar E.B. 1974. Thermal elution chromatography and the resolution of nucleic acids on hydroxylapatite. *Anal. Biochem.* **61**: 144-154.
- Masuya H., Kondo K., Aramaki Y., and Ishimori Y. 1992. Pyridopyridazine compounds and their use. European Patent No. EP0491477.
- Mattingly P.G. 1991. Chemiluminescent 10-methyl-acridinium-9-(N-sulphonylcarboxamide) salts. Synthesis and kinetics of light emission. *J. Biolumin. Chemilumin.* **6**: 107-114.
- Matz M.V., Fradkov A.F., Labas Y.A., Savitsky A.P., Zaraisky A.G., Markelov M.K., and Lukyanov S.A. 1999. Fluorescent proteins from nonbioluminescent *Anthozoa* species. *Nat. Biotechnol.* **17**: 969-973.
- Maxam A.M. and Gilbert W. 1977. A new method for sequencing DNA. *Proc. Natl. Acad. Sci.* **74**: 560-564.
- May M.S. and Hattman S. 1975. Analysis of bacteriophage deoxyribonucleic acid sequences methylated by host- and R-factor-controlled enzymes. *J. Bacteriol.* **123**: 768-770.
- McCann J., Choi E., Yamasaki E., and Ames B.N. 1975. Detection of carcinogens as mutagens in the *Salmonella*/microsome test: Assay of 300 chemicals. *Proc. Natl. Acad. Sci.* **72**: 2241-2245.
- McCarty M. 1985. *The transforming principle: Discovering that genes are made of DNA*, 1st edition, pp. 83-85. W.W. Norton, New York.
- McCaskill J.J. 1990. The equilibrium partition function and base pair binding probabilities for RNA secondary structures. *Biopolymers* **29**: 1105-1119.
- McClelland M. 1981. Purification and characterization of two new modification methylases: MclIaI from *Caryophanon latum* L and MtaqI from *Thermus aquaticus* YTI. *Nucleic Acids Res.* **9**: 6795-6804.
- . 1983. The frequency and distribution of methylatable DNA sequences in leguminous plant protein coding genes. *J. Mol. Evol.* **19**: 346-354.
- McClelland M. and Nelson M. 1987. Enhancement of the apparent cleavage specificities of restriction endonucleases: Applications to megabase mapping of chromosomes. In *Gene amplification and analysis: Restriction endonucleases and methylases* (ed. J.G. Chirikjian), vol. 5, pp. 257-282. Elsevier, New York.
- . 1988. The effect of site-specific DNA methylation on restriction endonucleases and DNA modification methyltransferases — A review. *Gene* **74**: 291-304.
- . 1992. Effect of site-specific methylation on DNA modification methyltransferases and restriction endonucleases. *Nucleic Acids Res.* (suppl.) **20**: 2145-2157.
- McClelland M., Kessler L.G., and Bittner M. 1984. Site-specific cleavage of DNA at 8- and 10-base-pair sequences. *Proc. Natl. Acad. Sci.* **81**: 983-987.
- McComb R.B. and Bowers Jr., G.N. 1972. Study of optimum buffer conditions for measuring alkaline phosphatase activity in human serum. *Clin. Chem.* **18**: 97-104.

- McConahey P.I. and Dixon F.J. 1966. A method of trace iodination of proteins for immunologic studies. *Int. Arch. Allergy Appl. Immunol.* **29**: 185–189.
- . 1980. Radioiodination of proteins by the use of the chloramine-T method. *Methods Enzymol.* **70**: 210–213.
- McCracken S. 1989. Preparation of RNA transcripts using SP6 RNA polymerase. In *DNA probes* (ed. G.H. Keller and M.M. Manak), pp. 119–120. Stockton Press, New York.
- McFarland W.N. and Norris K.S. 1958. Control of pH and CO<sub>2</sub> by buffers in fish transport. *Calif. Fish Game* **44**: 291–310.
- McGadey J. 1970. A tetrazolium method for non-specific alkaline phosphatase. *Histochemie* **23**: 180–184.
- McKee J.R., Christman C.L., O'Brien Jr., W.D., and Wang S.Y. 1988. Effects of ultrasound on nucleic acid bases. *Biochemistry* **16**: 4651–4654.
- McKimm-Breschkin J.L. 1990. The use of tetramethylbenzidine for solid phase immunoassays. *J. Immunol. Methods* **67**: 1–11.
- Medgyesi G.A., Fust G., Gergely J., and Bazin H. 1978. Classes and subclasses of rat immunoglobulins: Interaction with the complement system and with staphylococcal protein A. *Immunochimistry* **15**: 125–129.
- Meier T., Arni S., Malarkannan S., Poincelet M., and Hoessli D. 1992. Immunodetection of biotinylated lymphocyte-surface proteins by enhanced chemiluminescence: A nonradioactive method for cell-surface protein analysis. *Anal. Biochem.* **204**: 220–226.
- Meissner P.S., Sisk W.P., and Berman M.L. 1987. Bacteriophage  $\lambda$  cloning system for the construction of directional cDNA libraries. *Proc. Natl. Acad. Sci.* **84**: 4171–4175.
- Melgar E. and Goldthwait D.A. 1968. Deoxyribonucleic acid nucleases. II. The effects of metals on the mechanism of action of deoxyribonuclease I. *J. Biol. Chem.* **243**: 4409–4416.
- Mellon P.L., Clegg C.H., Correll L.A., and McKnight G.S. 1989. Regulation of transcription by cyclic AMP-dependent protein kinase. *Proc. Natl. Acad. Sci.* **86**: 4487–4891.
- Melton D.A., Krieg P.A., Rebagliati M.R., Maniatis T., Zinn K., and Green M.R. 1984. Efficient in vitro synthesis of biologically active RNA and RNA hybridization probes from plasmids containing a bacteriophage SP6 promoter. *Nucleic Acids Res.* **12**: 7035–7056.
- Menozzi F.D., Michel A., Pora H., and Miller A.O.A. 1990. Absorption method for rapid decontamination of solutions of ethidium bromide and propidium iodide. *Chromatographia* **29**: 167–169.
- Merrill C.R. 1987. Detection of proteins separated by electrophoresis. *Adv. Electrophor.* **1**: 111–139.
- . 1990. Silver staining of proteins and DNA. *Nature* **343**: 779–780.
- Merrill C.R., Goldman D., and Van Keuren M.L. 1984. Gel protein stains: Silver stain. *Methods Enzymol.* **104**: 441–447.
- Meselson M. and Yuan R. 1968. DNA restriction enzyme from *E. coli*. *Nature* **217**: 1110–1114.
- Messing J. 1979. A multipurpose cloning system based on the single-stranded DNA bacteriophage M13. *Recomb. DNA Tech. Bull.* **2**: 43–48.
- Messing J., Crea R., and Seeburg P.H. 1981. A system for shotgun sequencing. *Nucleic Acids Res.* **9**: 309–321.
- Messing J.B., Gronenborn B., Müller-Hill B., and Hofschneider P.H. 1977. Filamentous coliphage M13 as a cloning vehicle: Insertion of a *Hind*II fragment of the *lac* regulatory region in M13 replicative form *in vitro*. *Proc. Natl. Acad. Sci.* **74**: 3642–3246.
- Meyer T.S. and Lamberts B.L. 1965. Use of Coomassie brilliant blue R250 for the electrophoresis of microgram quantities of parotid saliva proteins on acrylamide gel strips. *Biochim. Biophys. Acta* **107**: 144–145.
- Michaelis S., Guarente L., and Beckwith J. 1983. *In vitro* construction and characterization of *phoA-lacZ* gene fusions in *Escherichia coli*. *J. Bacteriol.* **154**: 356–365.
- Michelson A.M. and Orkin S.H. 1982. Characterization of the homopolymer tailing reaction catalyzed by terminal deoxynucleotidyl transferase. Implications for the cloning of cDNA. *J. Biol. Chem.* **257**: 14773–14782.
- Miele E.A., Mills D.R., and Kramer F.R. 1983. Autocatalytic replication of a recombinant RNA. *J. Mol. Biol.* **171**: 281–295.
- Mierendorf R.C., Percy C., and Young R.A. 1987. Gene isolation by screening  $\lambda$ gt11 libraries with antibodies. *Methods Enzymol.* **152**: 458–469.
- Miller J.H. 1972. *Experiments in molecular genetics*. Cold Spring Harbor Laboratory, Cold Spring Harbor, New York.
- Mirouchoud D. and Gautier C. 1988. High codon-usage changes in mammalian genes. *Mol. Biol. Evol.* **5**: 192–194.
- Miska W. and Geiger R. 1987. Synthesis and characterization of luciferin derivatives for use in bioluminescence enhanced enzyme immunoassays. New ultrasensitive detection systems for enzyme immunoassays, I. *J. Clin. Chem. Clin. Biochem.* **25**: 23–30.
- Misteli T., Caceres J.F., and Spector D.L. 1997. The dynamics of a pre-mRNA splicing factor in living cells. *Nature* **387**: 523–527.
- Mitchell L.G., Bodenteich A., and Merrill C.R. 1994. Use of silver-staining to detect nucleic acids. *Methods Mol. Biol.* **31**: 197–203.
- Modrich P. and Lehman I.R. 1970. Enzymatic joining of polynucleotides. IX. A simple and rapid assay of polynucleotide joining (ligase) activity by measurement of circle formation from linear deoxyadenylate-deoxythymidylate copolymer. *J. Biol. Chem.* **245**: 3626–3631.
- Moeremans M., Daneels G., and De Mey J. 1985. Sensitive colloidal metal (gold or silver) staining of protein blots on nitrocellulose membranes. *Anal. Biochem.* **145**: 315–321.
- Monstein H.-J., Geijer T., and Bakalkin G.Y. 1992. BLOTTO-ME, an inexpensive and reliable hybridization solution in northern blot analysis using complementary RNA probes. *BioTechniques* **13**: 842–843.
- Moos M. 1992. Isolation of proteins for microsequence analysis. In *Current protocols in immunology* (ed. J.E. Coligan et al.), pp. 8.7.1–8.7.12. Wiley, New York.
- Morgenstern B., Dress A., and Werner T. 1996. Multiple DNA and protein sequence alignment based on segment-to-segment comparison. *Proc. Natl. Acad. Sci.* **93**: 12098–12103.
- Morise H., Shimomura O., Johnson F.H., and Winant J. 1974. Intermolecular energy transfer in the bioluminescent system of *Aequorea*. *Biochemistry* **13**: 2656–2662.
- Morris C.E., Klement J.F., and McAllister W.T. 1986. Cloning and expression of the bacteriophage T3 RNA polymerase gene. *Gene* **41**: 193–200.
- Mount D. 2001. *Bioinformatics: Sequence and genome analysis*. Cold Spring Harbor Laboratory Press, Cold Spring Harbor, New York. (In press.)
- Muylerman H.G., ter Hart H.G., and Van Dijk W. 1982. Specific detection of inactive enzyme protein after polyacrylamide gel electrophoresis by a new enzyme-immunoassay method using unspecific antiserum and partially purified active enzyme: Application to rat liver phosphodiesterase I. *Anal. Biochem.* **120**: 46–51.

- Müller A., Hinrichs W., Wolf W.M., and Saenger W. 1994. Crystal structure of calcium-free proteinase K at 1.5Å resolution. *J. Biol. Chem.* **269**: 23108–23111.
- Müller W. and Gautier F. 1975. Interactions of heteroaromatic compounds with nucleic acids. A–T-specific non-intercalating DNA ligands. *Eur. J. Biochem.* **54**: 385–394.
- Murray N.E., Brammar W.J., and Murray K. 1977. Lambdoid phages that simplify the recovery of *in vitro* recombinants. *Mol. Gen. Genet.* **150**: 53–61.
- Murzin A.G., Brenner S.E., Hubbard T., and Chothia C. 1995. SCOP: A structural classification of proteins database for the investigation of sequences and structures. *J. Mol. Biol.* **247**: 536–540.
- Myers R.M., Larin Z., and Maniatis T. 1985. Detection of single base substitutions by ribonuclease cleavage at mismatches in RNA:DNA duplexes. *Science* **230**: 1242–1246.
- Myhre E.B. and Kronvall G. 1977. Heterogeneity of nonimmune immunoglobulin Fc reactivity among gram-positive cocci: Description of three major types of receptors for human immunoglobulin G. *Infect. Immun.* **17**: 475–482.
- . 1980a. Immunochemical aspects of Fc-mediated binding of human IgG subclasses to group A, C and G streptococci. *Mol. Immunol.* **17**: 1563–1573.
- . 1980b. Binding of murine myeloma proteins of different Ig classes and subclasses to Fc-reactive surface structures in gram-positive cocci. *Scand. J. Immunol.* **11**: 37–46.
- . 1981. Specific binding of bovine, ovine, caprine and equine IgG subclasses to defined types of immunoglobulin receptors in gram-positive cocci. *Comp. Immunol. Microbiol. Infect. Dis.* **4**: 317–328.
- Nader W.F., Edlind T.D., Huettermann A., and Sauer H.W. 1985. Cloning of *Physarum* actin sequences in an exonuclease-deficient bacterial host. *Proc. Natl. Acad. Sci.* **82**: 2698–2702.
- Nagai K. and Thøgersen H.C. 1984. Generation of β-globin by sequence-specific proteolysis of a hybrid protein produced in *Escherichia coli*. *Nature* **309**: 810–812.
- Nakamura Y., Gojobori T., and Ikemura T. 1999. Codon usage tabulated from the international DNA sequence databases: Its status 1999. *Nucleic Acids Res.* **27**: 292.
- Nakane P.K. and Pierce Jr., G.B. 1967. Enzyme-labeled antibodies for the light and electron microscopic localization of tissue antigens. *J. Cell Biol.* **33**: 307–318.
- Nelson K.E., Clayton R.A., Gill S.R., Gwinn M.L., Dodson R.J., Haft D.H., Hickey E.K., Peterson J.D., Nelson W.C., Ketchum K.A., et al. 1999. Evidence for lateral gene transfer between Archaea and bacteria from genome sequence of *Thermotoga maritima*. *Nature* **399**: 323–329.
- Nelson M. and McClelland M. 1987. The effect of site-specific methylation on restriction-modification enzymes. *Nucleic Acids Res.* (suppl.) **15**: 219–230.
- Nelson M. and Schildkraut I. 1987. The use of DNA methylases to alter the apparent recognition specificities of restriction endonucleases. *Methods Enzymol.* **155**: 41–48.
- Nelson M., Christ C., and Schildkraut I. 1984. Alteration of apparent restriction endonuclease recognition specificities by DNA methylases. *Nucleic Acids Res.* **12**: 5165–5173.
- Nelson T. and Brutlag D. 1979. Addition of homopolymers to the 3'-ends of duplex DNA with terminal transferase. *Methods Enzymol.* **68**: 41–50.
- Neuwald A.F. and Green P. 1994. Detecting patterns in protein sequences. *J. Mol. Biol.* **239**: 698–712.
- Nevill-Manning C.G., Wu T.D., and Brutlag D.L. 1998. Highly specific protein sequence motifs for genome analysis. *Proc. Natl. Acad. Sci.* **95**: 5865–5871.
- Nguyen N., Hansen C., and Braman J. 1992. Detection of *bcl-2* t(14;18) chromosomal translocation using PCR and chemiluminescent probes. *Clin. Chem.* **38**: 469.
- Nguyen V.T., Morange M., and Bensaude O. 1988. Firefly luciferase luminescence assays using scintillation counters for quantitation in transfected mammalian cells. *Anal. Biochem.* **171**: 404–408.
- . 1989. Protein denaturation during heat shock and related stress. *Escherichia coli* β-galactosidase and *Photinus pyralis* luciferase inactivation in mouse cells. *J. Biol. Chem.* **264**: 10487–10492.
- Niedenthal R.K., Riles L., Johnston M., and Hegemann J.H. 1996. Green fluorescent protein as a marker for gene expression and subcellular localization in budding yeast. *Yeast* **12**: 773–786.
- Nilsson B. and Abrahmsén L. 1990. Fusions to staphylococcal protein A. *Methods Enzymol.* **185**: 144–161.
- Nilsson B., Abrahmsén L., and Uhlén M. 1985. Immobilization and purification of enzymes with staphylococcal protein A gene fusion vectors. *EMBO J.* **4**: 1075–1080.
- Nilsson R., Myhre E., Kronvall G., and Sjogren H.O. 1982. Fractionation of rat IgG subclasses and screening for IgG Fc-binding to bacteria. *Mol. Immunol.* **19**: 119–126.
- Nordeen S.K. 1988. Luciferase reporter gene vectors for analysis of promoters and enhancers. *BioTechniques* **6**: 454–458.
- Normore W.M. 1976. Guanine-plus-cytosine (GC) composition of the DNA of bacteria, fungi, algae and protozoa. In *Handbook of biochemistry and molecular biology: Nucleic acids*, 3rd edition (ed. G.D. Fasman), vol. 2, p. 65. CRC Press, Cleveland, Ohio.
- Nossal N.G. 1974. DNA synthesis on a double-stranded DNA template by the T4 bacteriophage DNA polymerase and the T4 gene 32 DNA unwinding protein. *J. Biol. Chem.* **249**: 5668–5676.
- Notredame C. and Higgins D. 1996. SAGA: Sequence alignment by genetic algorithm. *Nucleic Acids Res.* **24**: 1515–1524.
- Notredame C., Holm L., and Higgins D.F. 1998. COFFEE: An objective function for multiple sequence alignments. *Bioinformatics* **14**: 407–422.
- Nozaki O., Kricka L.J., and Stanley P.E. 1992. Nucleic acid hybridization assays. *J. Biolumin. Chemilumin.* **7**: 223–228.
- Nygren P.A., Eliasson M., Abrahmsén L., Uhlén M., and Palmcrantz E. 1988. Analysis and use of the serum albumin binding domains of streptococcal protein G. *J. Mol. Recognit.* **1**: 69–74.
- Nygren P.A., Flodby P., Andersson R., Wigzell H., and Uhlén M. 1991. *In vivo* stabilization of a human recombinant CD4 derivative by fusion to a serum-albumin-binding receptor. In *Vaccines 91: Modern approaches to new vaccines including prevention of aids* (ed. R.M. Channock et al.), pp. 363–368. Cold Spring Harbor Laboratory Press, Cold Spring Harbor, New York.
- Oakley B.R., Kirsch D.R., and Morris N.R. 1980. A simplified ultrasensitive silver stain for detecting proteins in polyacrylamide gels. *Anal. Biochem.* **105**: 361–363.
- Ochs D.C., McConkey E.H., and Sammons D.W. 1981. Silver stains for proteins in polyacrylamide gels: A comparison of six methods. *Electrophoresis* **2**: 304–307.
- Oefner P.J., Hunicke-Smith S.P., Chiang L., Dietrich F., Mulligan J., and Davis R.W. 1996. Efficient random subcloning of DNA sheared in a recirculating point-sink flow system. *Nucleic Acids Res.* **24**: 3879–3886.

- O'Farrell P.H., Kutter E., and Nakanishi M. 1980. A restriction map of the bacteriophage T4 genome. *Mol. Gen. Genet.* **179**: 421-435.
- Ogata R. and Gilbert W. 1977. Contacts between the *lac* repressor and the thymines in the *lac* operator. *Proc. Natl. Acad. Sci.* **74**: 4973-4976.
- Oi V.T., Glazer A.N., and Stryer L. 1982. Fluorescent phyco-biliprotein conjugates for analyses of cells and molecules. *J. Cell Biol.* **93**: 981-986.
- Oka T., Sakamoto S., Miyoshi K., Fuwa T., Yoda K., Yamasaki M., Tamura G., and Miyake T. 1985. Synthesis and secretion of human epidermal growth factor by *Escherichia coli*. *Proc. Natl. Acad. Sci.* **82**: 7212-7216.
- Okayama H. and Berg P. 1982. High efficiency cloning of full-length cDNA. *Mol. Cell. Biol.* **2**: 161-170.
- Olmsted J.B. 1981. Affinity purification of antibodies from diazotized paper blots of heterogeneous protein samples. *J. Biol. Chem.* **256**: 11955-11957.
- Olsson A., Eliasson M., Guss B., Nilsson B., Hellman U., Lindberg M., and Uhlen M. 1987. Structure and evolution of the repetitive gene encoding streptococcal protein G. *Eur. J. Biochem.* **168**: 319-324.
- Ornstein L. 1964. Disc electrophoresis. I. Background and theory. *Ann. N.Y. Acad. Sci.* **121**: 321-349.
- Palmer B.R. and Marinus M.G. 1994. The *dam* and *dcm* strains of *Escherichia coli* — A review. *Gene* **143**: 1-12.
- Panasenko S.M., Alazard R.J., and Lehman I.R. 1978. A simple, three-step procedure for the large scale purification of DNA ligase from a hybrid  $\lambda$  lysogen constructed in vitro. *J. Biol. Chem.* **253**: 4590-4592.
- Panasenko S.M., Cameron J.R., Davis R.W., and Lehman I.R. 1977. Five hundredfold overproduction of DNA ligase after induction of a hybrid  $\lambda$  lysogen constructed in vitro. *Science* **196**: 188-189.
- Pascarella S. and Argos P. 1992. A data bank merging related protein structures and sequences. *Protein Eng.* **5**: 121-137.
- Pataki S., Meyer K., and Reichstein T. 1953. Die Konfiguration des Digoxygenins. *Experientia* **9**: 253-254.
- Patterson T.A. and Dean M. 1987. Preparation of high titer lambda phage lysates. *Nucleic Acids Res.* **15**: 6298.
- Pavesi A., Contero F., Bolchi A., Dieci G., and Ottonello S. 1994. Identification of new eucaryotic tRNA genes in genomic databases by a multistep weight matrix analysis of transcriptional control regions. *Nucleic Acids Res.* **22**: 1247-1256.
- Pazzagli M., Bolelli G.F., Messeri G., Martinazzo G., Tomassi A., Salerno R., and Serio M. 1982. Homogeneous luminescent immunoassay for progesterone: A study on the antibody-enhanced chemiluminescence. In *Luminescent assays: Perspectives in endocrinology and clinical chemistry* (ed. M. Serio and M. Pazzagli), pp. 191-200. Raven Press, New York.
- Peacock S.L., McIver C.M., and Monahan J.J. 1981. Transformation of *E. coli* using homopolymer-linked plasmid chimeras. *Biochim. Biophys. Acta* **655**: 243-250.
- Pearson W.R. and Lipman D.J. 1988. Improved tools for biological sequence analysis. *Proc. Natl. Acad. Sci.* **85**: 2444-2448.
- Perier R.C., Junier T., Bonnard C., and Bucher P. 1999. The Eukaryotic Promoter Database (EPD): Recent developments. *Nucleic Acids Res.* **27**: 307-309.
- Perler F.B., Kumar S., and Kong H. 1996. Thermostable DNA polymerases. *Adv. Protein Chem.* **48**: 377-435.
- Peterhans A., Mecklenburg M., Meussdoerffer E., and Mosbach K. 1987. A simple competitive enzyme-linked immunosorbent assay using antigen-beta-galactosidase fusions. *Anal. Biochem.* **163**: 470-475.
- Pheiffer B.H. and Zimmerman S.B. 1983. Polymer-stimulated ligation: Enhanced blunt- or cohesive-end ligation of DNA or deoxyribooligonucleotides by T4 DNA ligase in polymer solutions. *Nucleic Acids Res.* **11**: 7853-7871.
- Phillips H.J. 1973. Dye exclusion tests for cell viability. In *Tissue culture: Methods and applications* (ed. P.F. Kruse, Jr. and M.K. Paterson, Jr.), pp. 406-408. Academic Press, New York.
- Piloty O. and Ruff O. 1997. Über die Reduktion des tertiären Nitroisobutylglycerins und das Oxim des Dioxyacetons. *Ber. Dtsch. Chem. Ges.* **30**: 1656-1665.
- Pluskal M.G., Przekop M.B., Kavonian M.R., Vecoli C., and Hicks D.A. 1986. Immobilon PVDF transfer membrane — A new membrane substrate for western blotting of proteins. *BioTechniques* **4**: 272-283.
- Pollard-Knight D., Simmonds A.C., Schaap A.P., Akhavan H., and Brady M.A. 1990. Nonradioactive DNA detection on Southern blots by enzymatically triggered chemiluminescence. *Anal. Biochem.* **185**: 353-358.
- Pouliot J.J., Yao K.C., Robertson C.A., and Nash H.A. 1999. Yeast gene for a Tyr-DNA phosphodiesterase that repairs topoisomerase I complexes. *Science* **286**: 552-555.
- Poxton I.R. 1990. Immunoblotting techniques. *Curr. Opin. Immunol.* **2**: 905-909.
- Prasher D.C., Eckenrode V.K., Ward W.W., Prendergast E.G., and Cormier M.J. 1992. Primary structure of the *Aequorea victoria* fluorescent green protein. *Gene* **111**: 229-233.
- Prell B. and Vosberg H.P. 1980. Analysis of covalent complexes formed between calf thymus DNA topoisomerase and single-stranded DNA. *Eur. J. Biochem.* **108**: 389-398.
- Premaratne S., Helms M., and Mower H.F. 1993. Enhancement of ethidium bromide fluorescence in double-stranded DNA reacted with chloroacetaldehyde. *BioTechniques* **15**: 394-395.
- Price P.A. 1972. Characterization of Ca<sup>++</sup> and Mg<sup>++</sup> binding to bovine pancreatic deoxyribonuclease A. *J. Biol. Chem.* **247**: 2895-2899.
- Puskas R.S., Manley N.R., Wallace D.M., and Berger S.L. 1982. Effect of ribonucleoside-vanadyl complexes on enzyme-catalyzed reactions central to recombinant deoxyribonucleic acid technology. *Biochemistry* **21**: 4602-4608.
- Quandt K., Grote K., and Werner T. 1996a. GenomeInspector: Basic software tools for analysis of spatial correlations between genomic structures within megabase sequences. *Genomics* **15**: 301-304.
- . 1996b. GenomeInspector: A new approach to detect correlation patterns of elements on genomic sequences. *Comput. Appl. Biosci.* **12**: 405-413.
- Quillardet P. and Hofnung M. 1988. Ethidium bromide and safety — Readers suggest alternative solutions (letter). *Trends Genet.* **4**: 89-90.
- Radloff R., Bauer W., and Vinograd J. 1967. A dye-buoyant density method for the detection and isolation of closed circular duplex DNA: The closed circular DNA in HeLa cells. *Proc. Natl. Acad. Sci.* **57**: 1514-1521.
- Raleigh E.A. and Wilson G. 1986. *Escherichia coli* K-12 restricts DNA containing 5-methylcytosine. *Proc. Natl. Acad. Sci.* **83**: 9070-9074.
- Raleigh E.A., Murray N.E., Revel H., Blumenthal R.M., Westaway D., Reith A.D., Rigby P.W., Elhai J., and Hanahan D. 1988. McrA and McrB restriction phenotypes of some *E. coli* strains and implications for gene cloning (erratum *Nucleic Acids Res.* [1995] **23**: 3612). *Nucleic Acids Res.* **16**: 1563-1575.
- Rassoulzadegan M., Binetruy B., and Cuzin F. 1982. High fre-

- quency of gene transfer after fusion between bacteria and eukaryotic cells. *Nature* **295**: 257–259.
- Reese M.G. 1994. "Erkennung von Promotoren in pro- und eukaryontischen DNA-Sequenzen durch künstliche Neuronale Netze." Ph.D. thesis, German Cancer Research Center, Heidelberg, Germany.
- Reese M.G. and E.H. Eeckman. 1995. New neural network algorithms for improved eukaryotic promoter site recognition. *Genome Sci. Technol.* **1**: 45.
- Reese M.G., N.L. Harris, and E.H. Eeckman. 1996. Large scale sequencing specific neural networks for promoter-splice site recognition. In *Biocomputing: Proceedings of the 1996 Pacific Symposium* (ed. L. Hunter and T.E. Klein). World Scientific, Singapore.
- Reese M.G., E.H. Eeckman, D. Kulp, and D. Haussler. 1997. Improved splice site detection in Genie. *J. Comput. Biol.* **4**: 311–323.
- Reichstein T. 1962. Besonderheiten der Zucker von herzaktiven Glikosiden. *Angew. Chem.* **74**: 887–918.
- Remaut E., Stanssens P., and Fiers W. 1981. Plasmid vectors for high-efficiency expression controlled by the  $p_L$  promoter of coliphage lambda. *Gene* **15**: 81–93.
- Renz M. and Kurz C. 1984. A colorimetric method for DNA hybridization. *Nucleic Acids Res.* **12**: 3435–3444.
- Rice P., Craigie R., and Davies D.R. 1996. Retroviral integrases and their cousins. *Curr. Opin. Struct. Biol.* **6**: 76–83.
- Richardson C.C. 1971. Polynucleotide kinase from *Escherichia coli* infected with bacteriophage T4. In *Procedures in nucleic acid research* (ed. G.L. Cantoni and D.R. Davies), vol. 2, p. 815–828. Harper and Row, New York.
- Richardson C.C. 1981. Bacteriophage T4 polynucleotide kinase. In *The enzymes*, 3rd edition (ed. P.D. Boyer), vol. 14, pp. 299–314. Academic Press, New York.
- Richardson J.S. and Richardson D.C. 1989. Principles and patterns of protein conformation. In *Prediction of protein structure and the principles of protein conformation* (ed. G.D. Fasman), pp. 1–97. Plenum Press, New York.
- Richman D.D., Cleveland P.H., Oxman M.N., and Johnson K.M. 1982. The binding of staphylococcal protein A by the sera of different animal species. *J. Immunol.* **128**: 2300–2305.
- Richterich P. and Church G.M. 1993. DNA sequencing with direct transfer electrophoresis and nonradioactive detection. *Methods Enzymol.* **218**: 187–222.
- Rigby P.W., Dieckmann M., Rhodes C., and Berg P. 1977. Labeling deoxyribonucleic acid to high specific activity in vitro by nick translation with DNA polymerase I. *J. Mol. Biol.* **113**: 237–251.
- Robbins D., Fahimi H.D., and Cotran R.S. 1971. Fine structural cytochemical localization of peroxidase activity in rat peritoneal cells: Mononuclear cells, eosinophils and mast cells. *J. Histochem. Cytochem.* **19**: 571–575.
- Roberts I.M., Jones S.L., Premier R.R., and Cox J.C. 1991. A comparison of the sensitivity and specificity of enzyme immunoassays and time-resolved fluoroimmunoassay. *J. Immunol. Methods* **143**: 49–56.
- Roberts T.M., Swanberg S.L., Potete A., Riedel G., and Backman K. 1980. A plasmid cloning vehicle allowing a positive selection for inserted fragments. *Gene* **12**: 123–127.
- Robinson M.O., McCarrey J.R., and Simon M.I. 1989. Transcriptional regulatory regions of testis-specific *PGK2* defined in transgenic mice. *Proc. Natl. Acad. Sci.* **86**: 8437–8441.
- Rogers S.G. and Weiss B. 1980. Exonuclease III of *Escherichia coli* K-12, an AP endonuclease. *Methods Enzymol.* **65**: 201–211.
- Rohringer R. and Holden D.W. 1985. Protein blotting: Detection of proteins with colloidal gold, and of glycoproteins and lectins with biotin-conjugated and enzyme probes. *Anal. Biochem.* **144**: 118–127.
- Rombauts S., Dehais P., Van Montagu M., and Rouze P. 1999. PlantCARE, a plant *cis*-acting regulatory element database. *Nucleic Acids Res.* **27**: 295–296.
- Rose G.D., Geselowitz A.R., Lesser G.J., Lee R.H., and Zehfus M.N. 1985. Hydrophobicity of amino acid residues in globular proteins. *Science* **229**: 834–838.
- Rosenberg S.M. 1985. *EcoK* restriction during in vitro packaging of coliphage lambda DNA. *Gene* **39**: 313–315.
- Roswell D.F. and White E.H. 1978. The chemiluminescence of luminol and related hydrazides. *Methods Enzymol.* **57**: 409–423.
- Roychoudhury R. and Wu R. 1980. Terminal transferase-catalyzed addition of nucleotides to the 3'-termini of DNA. *Methods Enzymol.* **65**: 43–62.
- Roychoudhury R., Jay E., and Wu R. 1976. Terminal labeling and addition of homopolymer tracts to duplex DNA fragments by terminal deoxynucleotidyl transferase. *Nucleic Acids Res.* **3**: 101–116.
- Rozenski J., Crain P.E., and McCloskey J.A. 1999. The RNA Modification Database: 1999 update. *Nucleic Acids Res.* **27**: 196–197.
- Rüther U. and Müller-Hill B. 1983. Easy identification of cDNA clones. *EMBO J.* **2**: 1791–1794.
- Salinovich O. and Montelaro R.C. 1986. Reversible staining and peptide mapping of proteins transferred to nitrocellulose after separation by sodium dodecyl sulfate-polyacrylamide gel electrophoresis. *Anal. Biochem.* **156**: 341–347.
- Sambrook J., Fritsch E., and Maniatis T. 1989. *Molecular cloning: A laboratory manual*, 2nd edition, p. 18.15. Cold Spring Harbor Laboratory Press, Cold Spring Harbor, New York.
- Sambrook, J., Sharp P.A., and Keller W. 1972. Transcription of simian virus 40. I. Separation of the strands of SV40 DNA and hybridization of the separated strands to RNA extracted from lytically infected and transformed cells. *J. Mol. Biol.* **70**: 57–71.
- Sammons D.W., Adams L.D., and Nishizawa E.E. 1981. Ultrasensitive silver-based color staining of polypeptides in polyacrylamide gels. *Electrophoresis* **2**: 135–141.
- Sander C. and Schneider R. 1991. Database of homology-derived protein structures and the structural meaning of sequence alignment. *Proteins* **9**: 56–68.
- Sanger E., Nicklen S., and Coulson A.R. 1977. DNA sequencing with chain-terminating inhibitors. *Proc. Natl. Acad. Sci.* **74**: 5463–5467.
- Sano T. and Cantor C.R. 1991. A streptavidin-protein A chimera that allows one-step production of a variety of specific antibody conjugates. *Bio/Technology* **9**: 1378–1381.
- Schaap A.P., Akhavan H., and Romano L.J. 1989. Chemiluminescent substrates for alkaline phosphatase: Application to ultrasensitive enzyme-linked immunoassays and DNA probes. *Clin. Chem.* **35**: 1863–1864.
- Schaap A.P., Sandison M.D., and Handley R.S. 1987. Chemical and enzymatic triggering of 1,2-dioxetanes. 3. Alkaline phosphatase-catalyzed chemiluminescence from an aryl phosphate substituted dioxetane. *Tetrahedron Lett.* **28**: 1159–1162.
- Schaffner W. 1980. Direct transfer of cloned genes from bacteria to mammalian cells. *Proc. Natl. Acad. Sci.* **77**: 2163–2167.

- Scheffler L.E., Elson E.L., and Baldwin R.L. 1968. Helix formation by dAT oligomers. I. Hairpin and straight-chain helices. *J. Mol. Biol.* **36**: 291–304.
- Schmitz A. and Galas D.J. 1979. The interaction of RNA polymerase and *lac* repressor with the *lac* control region. *Nucleic Acids Res.* **6**: 111–137.
- Schmitz G.G., Walter T., Seibl R., and Kessler C. 1991. Nonradioactive labeling of oligonucleotides in vitro with the hapten digoxigenin by tailing with terminal transferase. *Anal. Biochem.* **192**: 222–231.
- Schnare M.N., Damberger S.H., Gray M.W., and Gutell R.R. 1996. Comprehensive comparison of structural characteristics in eukaryotic cytoplasmic large subunit (23 S-like) ribosomal RNA. *J. Mol. Biol.* **256**: 701–719.
- Schneppenheim R. and Rautenberg P. 1987. A luminescence Western blot with enhanced sensitivity for antibodies to human immunodeficiency virus. *Eur. J. Clin. Microbiol.* **6**: 49–51.
- Schneppenheim R., Budde U., Dahlmann N., and Rautenberg P. 1991. Luminography — A new highly sensitive visualization method for electrophoresis. *Electrophoresis* **12**: 367–372.
- Schoenle E.J., Adams L.D., and Sammons D.W. 1984. Insulin-induced rapid decrease of a major protein in fat cell plasma membranes. *J. Biol. Chem.* **259**: 12112–12116.
- Schriefer L.A., Gebauer B.K., Qui L.Q., Waterston R.H., and Wilson R.K. 1990. Low pressure DNA shearing: A method for random DNA sequence analysis. *Nucleic Acids Res.* **18**: 7455–7456.
- Schroeder H.R., Boguslaski R.C., Carrico R.J., and Buckler R.T. 1978. Monitoring specific binding reactions with chemiluminescence. *Methods Enzymol.* **57**: 424–445.
- Schug J. and Overton G.C. 1997. TESS: Transcription element search software on the www. Computational Biology and Informatics Laboratory, University of Pennsylvania School of Medicine (Technical Report CBIL-TR-1997-1001-v0.0).
- Schuler G.D., Altschul S.E., and Lipman D.J. 1991. A workbench for multiple alignment construction and analysis. *Proteins* **9**: 180–191.
- Schwartz O., Virelizier J.-L., Montagnier L., and Hazan U. 1990. A microtransfection method using the luciferase-encoding reporter gene for the assay of human immunodeficiency virus LTR promoter activity. *Gene* **88**: 197–205.
- Schwartz R.M. and Dayhoff M.O. 1978. Matrices for detecting distant relationships. In *Atlas of protein sequence and structure* (ed. M.O. Dayhoff et al.), vol. 5, suppl. 3, pp. 353–358. National Biomedical Research Foundation, Georgetown University Medical Center, Washington, D.C.
- SeEVERS R.R.H. and Counsell R.E. 1982. Radioiodination techniques for small organic molecules. *Chem. Rev.* **82**: 575–590.
- Seibl R., Hölte H.-J., Ruger R., Meindl A., Zachau H.G., Rasshofer R., Roggendorf M., Wolf H., Arnold N., Wienberg J., et al. 1990. Non-radioactive labeling and detection of nucleic acids. III. Applications of the digoxigenin system. *Biol. Chem. Hoppe-Seyler* **371**: 939–951.
- Sekiya K., Saito Y., Ikegami T., Yamamoto M., Sato Y., Maeda M., and Tsuji A. 1991. Fully-automated analyzer for chemiluminescent enzyme immunoassay. In *Bioluminescence and chemiluminescence: Current status* (eds. P.E. Stanley and L.J. Kricka), pp. 123–126. Wiley, Chichester, United Kingdom.
- Semenza G. 1957. Chromatography of deoxyribonucleic acid in calcium phosphate. *Ark. Kemi* **11**: 89–96.
- Setlow P. 1976. Nearest neighbor frequencies in deoxyribonucleic acids. In *Handbook of biochemistry and molecular biology: Nucleic acids*, 3rd edition (ed. G.D. Fasman), vol. 2, p. 312. CRC Press, Cleveland, Ohio.
- Sevag M.G. 1934. Eine neue physikalische Enteiweißungs-methode zur Darstellung biologisch wirksamer Substanzen. *Biochem. Z.* **213**: 419–429.
- Sevag M.G., Lackman D.B., and Smolens J. 1938. Isolation of components of streptococcal nucleoproteins in serologically active form. *J. Biol. Chem.* **124**: 425.
- Shannon L.M., Kay E., and Lew J.Y. 1966. Peroxidase isozymes from horseradish roots. I. Isolation and physical properties. *J. Biol. Chem.* **241**: 2166–2172.
- Shapiro B.A. 1988. An algorithm for comparing multiple RNA secondary structures. *Comput. Appl. Biosci.* **4**: 381–393.
- Shapiro B.A. and Zhang K. 1990. Comparing multiple RNA secondary structures using tree comparison. *Comput. Appl. Biosci.* **6**: 309–318.
- Shapiro H.S. 1976. Distribution of purines and pyrimidines in deoxyribonucleic acids. In *Handbook of biochemistry and molecular biology: Nucleic acids*, 3rd edition (ed. G.D. Fasman), vol. 2, p. 241. CRC Press, Cleveland, Ohio.
- Sharp P.A., Sugden B., and Sambrook J. 1973. Detection of two restriction endonuclease activities in *Haemophilus parainfluenzae* using analytical agarose–ethidium bromide electrophoresis. *Biochemistry* **12**: 3055–3063.
- Sharp P.M. and Cowe E. 1991. Synonymous codon usage in *Saccharomyces cerevisiae*. *Yeast* **7**: 657–678.
- Sharp P.M. and Devine K.M. 1989. Codon usage and gene expression level in *Dictyostelium discoideum*: Highly expressed genes do “prefer” optimal codons. *Nucleic Acids Res.* **17**: 5029–5039.
- Shields D.C. and Sharp P.M. 1987. Synonymous codon usage in *B. subtilis* reflects both translational selection and mutational bias. *Nucleic Acids Res.* **15**: 3023–3040.
- Shimomura O. 1979. Structure of the chromophore of *Aequorea* green fluorescent protein. *FEBS Lett.* **104**: 220–222.
- Shine J., Dalgarno L., and Hunt J.A. 1974. Fingerprinting of eukaryotic ribosomal RNA labelled with tritiated nucleosides. *Anal. Biochem.* **59**: 360–365.
- Siegel L.I. and Bresnick E. 1986. Northern hybridization analysis of RNA using diethylpyrocarbonate-treated nonfat milk. *Anal. Biochem.* **159**: 82–87.
- Siezen R.J. and Leunissen J.A. 1997. Subtilases: The superfamily of subtilisin-like serine proteases. *Protein Sci.* **6**: 501–523.
- Siezen R.J., de Vos W.M., Leunissen J.A., and Dijkstra B.W. 1991. Homology modelling and protein engineering strategy of subtilases, the family of subtilisin-like serine proteinases. *Protein Eng.* **4**: 719–731.
- Simatake H. and Rosenberg M. 1981. Purified  $\lambda$  regulatory protein  $\phi$ II positively activates promoters for lysogenic development. *Nature* **292**: 128–132.
- Singer V.L., Lawler T.E., and Yue S. 1999. Comparison of SYBR<sup>®</sup> Green I nucleic acid gel stain mutagenicity and ethidium bromide mutagenicity in the *Salmonella* mammalian microsome reverse mutation assay (Ames test). *Mutat. Res.* **439**: 37–47.
- Singh G.B., Kramer J.A., and Krawetz S.A. 1997. Mathematical model to predict regions of chromatin attachment to the nuclear matrix. *Nucleic Acids Res.* **25**: 1419–1425.
- Singh L. and Jones K.W. 1984. The use of heparin as a simple cost-effective means of controlling background in nucleic acid hybridization procedures. *Nucleic Acids Res.* **12**: 5627–5638.
- Sjöbring U., Björck L., and Kastern W. 1989. Protein G genes:



- Structure and distribution of IgG-binding and albumin-binding domains. *Mol. Microbiol.* **3**: 319–327.
- . 1991. Streptococcal protein G. Gene structure and protein binding properties. *J. Biol. Chem.* **266**: 399–405.
- Sjödahl J. 1977. Structural studies on the four repetitive Fc-binding regions in protein A from *Staphylococcus aureus*. *Eur. J. Biochem.* **78**: 471–479.
- Sjölander A., Stahl S., Lovgren K., Hansson M., Cavalier L., Walles A., Helmy H., Wahlin B., Morein B., Uhlén M., et al. 1993. *Plasmodium falciparum*: The immune response in rabbits to the clustered asparagine-rich protein (CARP) after immunization in Freund's adjuvant or immunostimulating complexes (ISCOMs). *Exp. Parasitol.* **76**: 134–145.
- Sjöquist J., Meloun B., and Hjelm H. 1972. Protein A isolated from *Staphylococcus aureus* after digestion with lysostaphin. *Eur. J. Biochem.* **29**: 572–578.
- Skinner M.K. and Griswold M.D. 1983. Fluorographic detection of radioactivity in polyacrylamide gels with 2,5-diphenyloxazole in acetic acid and its comparison with existing procedures. *Biochem. J.* **209**: 281–284.
- Smith D.F. and Fisher P.A. 1984. Identification, developmental regulation, and response to heat shock of two antigenically related forms of a major nuclear envelope protein in *Drosophila* embryos: Application of an improved method for affinity purification of antibodies using polypeptides immobilized on nitrocellulose blots. *J. Cell Biol.* **99**: 20–28.
- Smith D.R., Doucette-Stamm L.A., Deloughery C., Lee H., Dubois J., Aldredge T., Bashirzadeh R., Blakely D., Cook R., Gilbert K., et al. 1997. Complete genome sequence of *Methanobacterium thermoautotrophicum*  $\Delta$ H: Functional analysis and comparative genomics. *J. Bacteriol.* **179**: 7135–7155.
- Smith R.F. and Smith T.F. 1990. Automatic generation of primary sequence patterns from sets of related protein sequences. *Proc. Natl. Acad. Sci.* **87**: 118–122.
- . 1992. Pattern-induced multi-sequence alignment (PIMA) algorithm employing secondary structure-dependent gap penalties for comparative protein modelling. *Protein Eng.* **5**: 35–41.
- Smith H.O. 1980. Recovery of DNA from gels. *Methods Enzymol.* **65**: 371–380.
- Smith H.O., Annau T.M., and Chandrasegaran S. 1990. Finding sequence motifs in groups of functionally related proteins. *Proc. Natl. Acad. Sci.* **87**: 826–830.
- Snyder E.E. and Stormo G. 1993. Identification of coding regions in genomic DNA sequences: An application of dynamic programming and neural networks. *Nucleic Acids Res.* **21**: 607–613.
- . 1995. Identification of coding regions in genomic DNA. *J. Mol. Biol.* **248**: 1–18.
- Sonnhammer E.L., Eddy S.R., and Durbin R. 1997. Pfam: A comprehensive database of protein families based on seed alignments. *Proteins* **28**: 405–420.
- Sonnhammer E.L., Eddy S.R., Birney E., Bateman A., and Durbin R. 1998. Pfam: Multiple sequence alignments and HMM-profiles of protein domains. *Nucleic Acids Res.* **26**: 320–322.
- Sorensen M.A., Kurland C.G., and Pedersen S. 1989. Codon usage determines translation rate in *Escherichia coli*. *J. Mol. Biol.* **207**: 365–377.
- Southern E.M. 1975. Detection of specific sequences among DNA fragments separated by gel electrophoresis. *J. Mol. Biol.* **98**: 503–517.
- Souza A.E. and Göringer H.U. 1998. The guide RNA database. *Nucleic Acids Res.* **26**: 168–169.
- Spector D.L., Goldman R.D., and Leinwand L.A. 1998. *Cells: A laboratory manual*, vol. 1. *Culture and biochemical analysis of cells*, pp. 2.8–2.10. Cold Spring Harbor Laboratory Press, Cold Spring Harbor, New York.
- Spingola M., Grate L., Haussler D., and Ares Jr., M. 1999. Genome-wide bioinformatic and molecular analysis of introns in *Saccharomyces cerevisiae*. *RNA* **5**: 221–234.
- Stahl S., Nygren P.A., Sjölander A., and Uhlén M. 1993. Engineered bacterial receptors in immunology. *Curr. Opin. Immunol.* **5**: 272–277.
- Stanley P.E. 1992. A survey of more than 90 commercially available luminometers and imaging devices for low-light measurements of chemiluminescence and bioluminescence including instruments for manual, automatic and specialized operation, for HPLC, LC, GLC, and microtiter plates. I. Descriptions. *J. Biolumin. Chemilumin.* **7**: 77–108.
- . 1993. A survey of some commercially available kits and reagents which include bioluminescence or chemiluminescence for their operation: Including immunoassays, hybridization, labels, probes, blots and ATP-based rapid microbiology. *J. Biolumin. Chemilumin.* **8**: 51–63.
- Stein H. and Hausen P. 1969. Enzyme from calf thymus degrading the RNA moiety of DNA-RNA hybrids: Effect on DNA-dependent RNA polymerase. *Science* **166**: 393–395.
- Stephens R.S., Kalman S., Lammel C., Fan J., Marathe R., Aravind L., Mitchell W., Olinger L., Tatusov R.L., Zhao Q., Koonin E.V., and Davis R.W. 1998. Genome sequence of an obligate intracellular pathogen of humans: *Chlamydia trachomatis*. *Science* **282**: 754–759.
- Sternberg N. 1985. Evidence that adenine methylation influences DNA-protein interactions in *Escherichia coli*. *J. Bacteriol.* **164**: 490–493.
- Sternberg N., Smoller D., and Braden T. 1994. Three new developments in P1 cloning. Increased cloning efficiency, improved clone recovery, and a new P1 mouse library. *Genet. Anal. Tech. Appl.* **11**: 171–180.
- Stokke T. and Steen H.B. 1985. Multiple binding modes for Hoechst 33258 to DNA. *J. Histochem. Cytochem.* **33**: 333–338.
- Stone G.C., Sjöbring U., Björck L., Sjöquist J., Barber C.V., and Nardella F.A. 1989. The Fc binding site for streptococcal protein G is in the C $\gamma$ 2-C $\gamma$ 3 interface region of IgG and is related to the sites that bind staphylococcal protein A and human rheumatoid factors. *J. Immunol.* **143**: 565–570.
- Stone T. and Durrant I. 1991. Enhanced chemiluminescence for the detection of membrane-bound nucleic acid sequences: Advantages of the Amersham system. *Genet. Anal. Tech. Appl.* **8**: 230–237.
- Stott D.I. 1989. Immunoblotting and dot blotting. *J. Immunol. Methods* **119**: 153–187.
- Strauss F. and Varshavsky A. 1984. A protein binds to a satellite DNA repeat at three specific sites that would be brought into mutual proximity by DNA folding in the nucleosome. *Cell* **37**: 889–901.
- Studier F.W. 1973. Analysis of bacteriophage T7 early RNAs and proteins on slab gels. *J. Mol. Biol.* **79**: 237–248.
- Studier F.W. and Moffatt B.A. 1986. Use of bacteriophage T7 RNA polymerase to direct selective high-level expression of cloned genes. *J. Mol. Biol.* **189**: 113–130.
- Stulnig T.M. and Amberger A. 1994. Exposing contaminating phenol in nucleic acid preparations. *BioTechniques* **16**: 403–404.
- Subramani S. and DeLuca M. 1988. Applications of the firefly luciferase as a reporter gene. *Genet. Eng.* **10**: 75–89.

- Suck D. and Oefner C. 1986. Structure of DNase I at 2.0 Å resolution suggests a mechanism for binding to and cutting DNA. *Nature* **321**: 620–625.
- Suck D., Lahm A., and Oefner C. 1988. Structure refined to 2Å of a nicked DNA octanucleotide complex with DNase I. *Nature* **332**: 464–468.
- Suck D., Oefner C., and Kabsch W. 1984. Three-dimensional structure of bovine pancreatic DNase I at 2.5 Å resolution. *EMBO J.* **3**: 2423–2430.
- Sugino A., Goodman H.M., Heyneker H.L., Shine J., Boyer H.W., and Cozzarelli N.R. 1977. Interaction of bacteriophage T4 RNA and DNA ligases in joining of duplex DNA at base-paired ends. *J. Biol. Chem.* **252**: 3987–3994.
- Süthnel J. 1997. Views of RNA on the World Wide Web. *Trends Genet.* **13**: 206–207.
- Sutcliffe J.G. 1978. Nucleotide sequence of the ampicillin resistance gene of *Escherichia coli* plasmid pBR322. *Proc. Natl. Acad. Sci.* **75**: 3737–3741.
- . 1979. Complete nucleotide sequence of the *Escherichia coli* plasmid pBR322. *Cold Spring Harbor Symp. Quant. Biol.* **43**: 77–90.
- Sutherland M.W. and Skerritt J.H. 1986. Alkali enhancement of protein staining on nitrocellulose membranes. *Electrophoresis* **7**: 401–406.
- Suzuki S., Craddock B.P., Kana T., and Steigbigel R.T. 1993. Chemiluminescent enzyme-linked immunoassay for reverse transcriptase illustrated by detection of HIV reverse transcriptase. *Anal. Biochem.* **210**: 277–281.
- Svaren J., Inagami S., Lovgren E., and Chalkley. 1987. DNA denatures upon drying after ethanol precipitation. *Nucleic Acids Res.* **15**: 8739–8754.
- Swanstrom R. and Shank P.R. 1978. X-ray intensifying screens greatly enhance the detection by autoradiography of the radioactive isotopes <sup>32</sup>P and <sup>125</sup>I. *Anal. Biochem.* **86**: 184–192.
- Switzer III, R.C., Merrill C.R., and Shifrin S. 1979. A highly sensitive silver stain for detecting proteins and peptides in polyacrylamide gels. *Anal. Biochem.* **98**: 231–237.
- Szymanski M., Barciszewska M.Z., Barciszewski J., and Erdmann V.A. 1999. 5S Ribosomal RNA Data Bank. *Nucleic Acids Res.* **27**: 158–160.
- Tabor S. and Richardson C.C. 1985. A bacteriophage T7 RNA polymerase/promoter system for controlled exclusive expression of specific genes. *Proc. Natl. Acad. Sci.* **82**: 1074–1078.
- Tabor S., Huber H.E., and Richardson C.C. 1987. *Escherichia coli* thioredoxin confers processivity on the DNA polymerase activity of the gene 5 protein of bacteriophage T7. *J. Biol. Chem.* **262**: 16212–16223.
- Tai M.S., Mudgett-Hunter M., Levinson D., Wu G.M., Haber E., Oppermann H., and Huston J.S. 1990. A bifunctional fusion protein containing Fc-binding fragment B of staphylococcal protein A amino terminal to antidigoxigenin single-chain Fv. *Biochemistry* **30**: 8024–8030.
- Takahashi M. and Uchida T. 1986. Thermophilic HB8 DNA ligase: Effects of polyethylene glycols and polyamines on blunt-end ligation of DNA. *J. Biochem.* **100**: 123–131.
- Takahashi M., Yamaguchi E., and Uchida T. 1984. Thermophilic DNA ligase. Purification and properties of the enzyme from *Thermus thermophilus* HB8. *J. Biol. Chem.* **259**: 10041–10047.
- Tartof K.D. and Hobbs C.A. 1987. Improved media for growing plasmid and cosmid clones. *Focus (Life Technologies)* **9**: 12.
- Tatsumi H., Masuda T., and Nakao E. 1988. Synthesis of enzymatically active firefly luciferase in yeast. *Agric. Biol. Chem.* **52**: 1123–1127.
- Tatusova T.A. and Madden T.L. 1999. BLAST 2 sequences, a new tool for comparing protein and nucleotide sequences (erratum *FEMS Microbiol. Lett.* [1999] **177**: 187–188). *FEMS Microbiol. Lett.* **174**: 247–250.
- Tautz D. and Pfeifle C. 1989. A non-radioactive *in situ* hybridization method for the localization of specific RNAs in *Drosophila* embryos reveals translational control of the segmentation gene *hunchback*. *Chromosoma* **98**: 81–85.
- Taylor J.M., Illmensee R., and Summers J. 1976. Efficient transcription of RNA into DNA by avian sarcoma virus polymerase. *Biochim. Biophys. Acta* **442**: 324–330.
- Taylor W.R. 1986. The classification of amino acid conservation. *J. Theor. Biol.* **119**: 205–218.
- Thompson D. and Larson G. 1992. Western blots using stained protein gels. *BioTechniques* **12**: 656–658.
- Thompson J.D., Higgins D.G., and Gibson T.J. 1994. CLUSTAL W: Improving the sensitivity of multiple sequence alignment through sequence weighting, position-specific gap penalties, and weight matrix choice. *Nucleic Acids Res.* **22**: 4673–4680.
- Thorpe G.H. and Kricka L.J. 1986. Enhanced chemiluminescent reactions catalyzed by horseradish peroxidase. *Methods Enzymol.* **133**: 331–353.
- Thorpe G.H.G., Kricka L.J., Moseley S.B., and Whitehead T.P. 1985. Phenols as enhancers of the chemiluminescent horseradish peroxidase-luminol-hydrogen peroxide reaction: Application in luminescence monitored enzyme immunoassays. *Clin. Chem.* **31**: 1335–1341.
- Thorstenson Y.R., Hunnicke-Smith S.P., Oefner P.J., and David R. 1998. An automated, hydrodynamic process for controlled, unbiased DNA shearing. *Genome Res.* **8**: 848–855.
- Tiselius A., Hjertén S., and Levin Ö. 1956. Protein chromatography on calcium phosphate columns. *Arch. Biochem. Biophys.* **65**: 132–155.
- Tizard R., Cate R.L., Ramachandran K.L., Wysk M., Voyta J.C., Murphy O.J., and Bronstein I. 1990. Imaging of DNA sequences with chemiluminescence. *Proc. Natl. Acad. Sci.* **87**: 4514–4518.
- Tomb J.F., White O., Kerlavage A.R., Clayton R.A., Sutton G.G., Fleischmann R.D., Ketchum K.A., Klenk H.P., Gill S., Dougherty B.A., et al. 1997. The complete genome sequence of the gastric pathogen *Helicobacter pylori* (erratum *Nature* [1997] **389**: 412). *Nature* **388**: 539–547.
- Towbin H. and Gordon J. 1984. Immunoblotting and dot immunobinding — Current status and outlook. *J. Immunol. Methods* **72**: 313–340.
- Towbin H., Staehelin T., and Gordon J. 1979. Electrophoretic transfer of proteins from polyacrylamide gels to nitrocellulose sheets: Procedure and some applications. *Proc. Natl. Acad. Sci.* **76**: 4350–4354.
- Triman K.L. and Adams B.J. 1997. Expansion of the 16S and 23S ribosomal RNA mutation databases (16SMDB and 23SMDB). *Nucleic Acids Res.* **25**: 188–191.
- Tsunoda T. and Takagi T. 1999. Estimating transcription factor bindability on DNA. *Bioinformatics* **15**: 622–630.
- Tu C.-P. and Cohen S.N. 1980. 3'-End labeling of DNA with [ $\alpha$ -<sup>32</sup>P]cordycepin-5'-triphosphate. *Gene* **10**: 177–183.
- Tuma R.S., Beaudet M.P., Jin X., Jones L.J., Cheung C.Y., Yue S., and Singer V.L. 1999. Characterization of SYBR Gold nucleic acid gel stain: A dye optimized for use with 300-nm ultraviolet transilluminators. *Anal. Biochem.* **268**: 278–288.
- Tung W.L. and Chow K.C. 1995. A modified medium for efficient electrotransformation of *E. coli*. *Trends Genet.* **1**: 128–129.

- Urbacher E.C. and Mural R.J. 1991. Locating protein-coding regions in human DNA sequences by a multiple sensor-neural network approach. *Proc. Natl. Acad. Sci.* **88**: 11261–11265.
- Uhlén M. 1989. Magnetic separation of DNA. *Nature* **340**: 733–734.
- Uhlén M. and Moks T. 1990. Gene fusions for purpose of expression: An introduction. *Methods Enzymol.* **185**: 129–143.
- Uhlén, M., Forsberg G., Moks T., Hartmanis M., and Nilsson B. 1992. Fusion proteins in biotechnology. *Curr. Opin. Biotechnol.* **3**: 363–369.
- Uhlén M., Guss B., Nilsson B., Gatenbeck S., Philipson L., and Lindberg M. 1984. Complete sequence of the staphylococcal gene encoding protein A. A gene evolved through multiple duplications. *J. Biol. Chem.* **259**: 1695–1702.
- Uhlén M., Nilsson B., Guss B., Lindberg M., Gatenbeck S., and Philipson L. 1983. Gene fusion vectors based on the gene for staphylococcal protein A. *Gene* **23**: 369–378.
- Uhlenbeck O. and Gumpert R.I. 1982. T4 RNA ligase. In *The enzymes*, 3rd edition (ed. P.D. Boyer), vol. 15, p. 31–58. Academic Press, New York.
- Urdea M.S., Warner B.D., Running J.A., Stempien M., Clyne J., and Horn T. 1988. A comparison of non-radioisotopic hybridization assay methods using fluorescent, chemiluminescent and enzyme labeled synthetic oligodeoxynucleotide probes. *Nucleic Acids Res* **16**: 4937–4956.
- Van Dyke K. and Van Dyke R., eds. 1990. *Luminescence immunoassay and molecular applications*. CRC Press, Boca Raton, Florida.
- Van Lancker M. and Gheysens L.C. 1986. A comparison of four frequently-used assays for quantitative determination of DNA. *Anal. Lett.* **19**: 615–623.
- van Oss C.J., Good R.J., and Chaudhury M.K. 1987. Mechanisms of DNA (Southern) and protein (Western) blotting on cellulose nitrate and other membranes. *J. Chromatogr.* **391**: 53–65.
- van Zonneveld A.J., Curriden S.A., and Loskutoff D.J. 1988. Type I plasminogen activator inhibitor gene: Functional analysis and glucocorticoid regulation of its promoter. *Proc. Natl. Acad. Sci.* **85**: 5525–5529.
- Vari F. and Bell K. 1996. A simplified silver diamine method for the staining of nucleic acids in polyacrylamide gels. *Electrophoresis* **17**: 20–25.
- Verdine G.L. 1994. The flip side of DNA methylation. *Cell* **76**: 197–200.
- Verma I.M. 1981. Reverse transcriptase. In *The enzymes*, 3rd edition (ed. P.D. Boyer), vol. 14, pp. 87–103. Academic Press, New York.
- Vieira J. and Messing J. 1987. Production of single-stranded plasmid DNA. *Methods Enzymol.* **153**: 3–11.
- Vogt V.M. 1973. Purification and further properties of single-strand-specific nuclease from *Aspergillus oryzae*. *Eur. J. Biochem.* **33**: 192–200.
- Waalwijk C. and Flavell R.A. 1978. MspI, an isoschizomer of HpaII which cleaves both unmethylated and methylated HpaII sites. *Nucleic Acids Res.* **5**: 3231–3236.
- Wada K., Wada Y., Ishibashi F., Gojobori T., and Ikemura T. 1992. Codon usage tabulated from the GenBank genetic sequence data. *Nucleic Acids Res.* **20**: 2111–2118.
- Wallace J.C. and Henikoff S. 1992. PATMAT: A searching and extraction program, sequence, and block queries and databases. *Comput. Appl. Biosci.* **8**: 249–254.
- Walter A.E., Turner D.H., Kim J., Lyttle M.H., Muller P., Mathews D.H., and Zuker M. 1994. Coaxial stacking of helices enhances binding of oligoribonucleotides and improves predictions of RNA folding. *Proc. Natl. Acad. Sci.* **91**: 9218–9222.
- Wang J.C. 1969. Variation of the average rotation angle of the DNA helix and the superhelical turns of covalently closed cyclic  $\lambda$  DNA. *J. Mol. Biol.* **43**: 25–39.
- . 1979. Helical repeat of DNA in solution. *Proc. Natl. Acad. Sci.* **76**: 200–203.
- . 1996. DNA topoisomerases. *Annu. Rev. Biochem.* **65**: 635–692.
- Wang R.Y.-H., Zhang X.-Y., Khan R., Zhou Y., Huang L.-H., and Ehrlich M. 1986. Methylated DNA-binding protein from human placenta recognizes specific methylated sites on several prokaryotic DNAs. *Nucleic Acids Res.* **14**: 9843–9860.
- Wang S. and Hazelrigg T. 1994. Implications for *bcd* mRNA localization from spatial distribution of *exu* protein in *Drosophila* oogenesis. *Nature* **369**: 400–403.
- Warburg O. and Christian W. 1942. Isolierung und kristallisation des gärungsferments enolase. *Biochem. Z.* **310**: 384–421.
- Waring M.J. 1965. Complex formation between ethidium bromide and nucleic acids. *J. Mol. Biol.* **13**: 269–282.
- . 1966. Structural requirements for the binding of ethidium bromide to nucleic acids. *Biochim. Biophys. Acta* **114**: 234–244.
- Waterman M.L., Adler S., Nelson C., Greene G.L., Evans R.M., and Rosenfeld M.G. 1988. A single domain of the estrogen receptor confers deoxyribonucleic acid binding and transcriptional activation of the rat prolactin gene. *Mol. Endocrinol.* **2**: 14–21.
- Watkins T.I. and Wolfe G. 1952. Effect of changing the quaternizing group on the trypanocidal activity of dimidium bromide. *Nature* **169**: 506.
- Weeks L., Beheshti I., McCapra F., Campbell A.K., and Woodhead J.S. 1983. Acridinium esters as high-specific activity labels in immunoassay. *Clin. Chem.* **29**: 1474–1479.
- Wei C.-F., Alianell G.A., Bencen G.H., and Gray Jr., H.B. 1983. Isolation and comparison of two molecular species of the BAL 31 nuclease from *Alteromonas espejiana* with distinct kinetic properties. *J. Biol. Chem.* **258**: 13506–13512.
- Weil M.D. and McClelland M. 1989. Enzymatic cleavage of a bacterial genome at a 10-base-pair recognition site. *Proc. Natl. Acad. Sci.* **86**: 51–55.
- Weisblum B. and Haensler E. 1974. Fluorometric properties of the benzimidazole derivative Hoechst 33258, a fluorescent probe specific for AT concentration in chromosomal DNA. *Chromosoma* **46**: 255–260.
- Weisburger E.K., Russfield A.B., Homburger F., Weisburger J.H., Boger E., Van Dongen C.G., and Chu K.C. 1978. Testing of twenty-one environmental aromatic amines or derivatives for long-term toxicity or carcinogenicity. *J. Environ. Pathol. Toxicol.* **2**: 325–356.
- Weiss B. 1976. Endonuclease II of *Escherichia coli* is exonuclease III. *J. Biol. Chem.* **251**: 1896–1901.
- Weiss B., Jacquemin-Sablon A., Live T.R., Fareed G.C., and Richardson C.C. 1968. Enzymatic breakage and joining of deoxyribonucleic acid. IV. Further purification and properties of polynucleotide ligase from *Escherichia coli* infected with bacteriophage T4. *J. Biol. Chem.* **243**: 4543–4555.
- Werstuck G. and Capone J.P. 1989. Identification of a domain of the herpes simplex virus *trans*-activator Vmw65 required for protein-DNA complex formation through the use of protein A fusion proteins. *J. Virol.* **63**: 5509–5513.
- White O., Eisen J.A., Heidelberg J.F., Hickey E.K., Peterson J.D., Dodson R.J., Haft D.H., Gwinn M.I., Nelson W.C., Richardson D.L., et al. 1999. Genome sequence of the

- radioresistant bacterium *Deinococcus radiodurans* R1. *Science* **286**: 1571–1577.
- Whitehead T.P., Thorpe G.H.G., Carter T.J.N., Groucutt C., and Kricka L.J. 1983. Enhanced luminescence procedure for sensitive determination of peroxidase-labelled conjugates in immunoassay. *Nature* **305**: 158–159.
- Whittaker P.A., Campbell A.J.B., Southern E.M., and Murray N.E. 1988. Enhanced recovery and restriction mapping of DNA fragments cloned in a new  $\lambda$  vector. *Nucleic Acids Res.* **16**: 6725–6736.
- Wick R.A. 1989. Photon counting imaging: Applications in biomedical research. *BioTechniques* **7**: 262–268.
- Wieggers U. and Hilz H. 1971. A new method using "proteinase K" to prevent mRNA degradation during isolation from HeLa cells. *Biochem. Biophys. Res. Commun.* **44**: 513–519.
- . 1972. Rapid isolation of undegraded polysomal RNA without phenol. *FEBS Lett.* **23**: 77–84.
- Wigle D.A., Radakovic N.N., Venance S.L., and Pang S.C. 1993. Enhanced chemiluminescence with catalyzed reporter deposition for increasing the sensitivity of Western blotting. *BioTechniques* **14**: 562–563.
- Wilchek M. and Bayer E.A. 1990. Biotin-containing reagents. *Methods Enzymol.* **184**: 123–138.
- Willfinger W.W., Mackey K., and Chomczynski P. 1997. Effect of pH and ionic strength on the spectrophotometric assessment of nucleic acid purity. *BioTechniques* **22**: 474–481.
- Wilkie N.M. and Cortini R. 1976. Sequence arrangement in herpes simplex virus type 1 DNA: Identification of terminal fragments in restriction endonuclease digests and evidence for inversions in redundant and unique sequences. *J. Virol.* **20**: 211–221.
- Wilkinson D. 1998. Products for the chemiluminescent detection of DNA. *Scientist* **12**: 20–22.
- Williams B.G. and Blattner F.R. 1979. Construction and characterization of the hybrid bacteriophage lambda Charon vectors for DNA cloning. *J. Virol.* **29**: 555–575.
- Wilson A.T. 1958. Tritium and paper chromatography. *Nature* **182**: 524.
- . 1960. Detection of tritium on paper chromatograms. *Biochim. Biophys. Acta* **40**: 522–526.
- Wilson C.M. 1979. Studies and critique of Amido Black 10B, Coomassie Blue R, and Fast Green FCF as stains for proteins after polyacrylamide gel electrophoresis. *Anal. Biochem.* **96**: 263–278.
- . 1983. Staining of proteins on gels: Comparison of dyes and procedures. *Methods Enzymol.* **91**: 236–247.
- Winkler E.K. 1994. DNA totally flipped out by methylase. *Structure* **2**: 79–83.
- Winkler E.K., Banner D.W., Oefner C., Tsernoglou D., Brown R.S., Heathman S.P., Bryan R.K., Martin P.D., Petratos K., and Wilson K.S. 1993. The crystal structure of EcoRV endonuclease and of its complexes with cognate and non-cognate DNA fragments. *EMBO J.* **12**: 1781–1795.
- Winter E., Yamamoto E., Almoguera C., and Perucho M. 1985. A method to detect and characterize point mutations in transcribed genes: Amplification and overexpression of the mutant c-Ki-ras allele in human tumor cells. *Proc. Natl. Acad. Sci.* **82**: 7575–7579.
- Wintersberger U. 1990. Ribonucleases H of retroviral and cellular origin. *Pharmacol. Ther.* **48**: 259–280.
- Woffenden R., Andersson L., Cullis P.M., and Southgate C.C. 1981. Affinities of amino acid side chains for solvent water. *Biochemistry* **20**: 849–855.
- Woltanski K.P., Besch W., Keilacker H., Ziegler M., and Kohnert K.D. 1990. Radioiodination of peptide hormones and immunoglobulin preparations: Comparison of the chloramine T and iodogen method. *Exp. Clin. Endocrinol.* **95**: 39–46.
- Wolters G., Kuijpers L., Kacaki J., and Schuurs A. 1976. Solid-phase enzyme-immunoassay for detection of hepatitis B surface antigen. *J. Clin. Pathol.* **29**: 873–879.
- Wood K.V. 1991. The origin of beetle luciferases. In *Bioluminescence and chemiluminescence: Current status* (ed. P. Stanley and L. Kricka), pp. 11–14. Wiley, Chichester, United Kingdom.
- Wood K.V. and DeLuca M. 1987. Photographic detection of luminescence in *Escherichia coli* containing the gene for firefly luciferase. *Anal. Biochem.* **161**: 501–507.
- Wood W.B. 1966. Host specificity of DNA produced by *Escherichia coli*: Bacterial mutations affecting the restriction and modification of DNA. *J. Mol. Biol.* **16**: 118–133.
- Worley K.C., Wiese B.A., and Smith R.F. 1995. BEAUTY: An enhanced BLAST-based search tool that integrates multiple biological information resources into sequence similarity search results. *Genome Res.* **5**: 173–184.
- Worley K.C., Culpepper P., Wiese B.A., and Smith R.F. 1998. BEAUTY-X: Enhanced BLAST searches for DNA queries. *Bioinformatics* **14**: 890–891.
- Wower J. and Zwieb C. 1999. The tmRNA database (tmRDB). *Nucleic Acids Res.* **27**: 167.
- Wu J.C. and Santi D.V. 1987. Kinetic and catalytic mechanism of Hhal methyltransferase. *J. Biol. Chem.* **262**: 4778–4786.
- Wu R., Jay E., and Roychoudhury R. 1976. Nucleotide sequence analysis of DNA. *Methods Cancer Res.* **12**: 87–176.
- Wuchty S., Fontana W., Hofacker I.L., and Schuster P. 1999. Complete suboptimal folding of RNA and the stability of secondary structures. *Biopolymers* **49**: 145–165.
- Wyman A.R. and Wertman K.F. 1987. Host strains that alleviate underrepresentation of specific sequences: Overview. *Methods Enzymol.* **152**: 173–180.
- Xue G.P., Denman S.E., Glassop D., Johnson J.S., Dierens L.M., Gobijs K.S., and Aylward J.H. 1995. Modification of a xylanase cDNA isolated from an anaerobic fungus *Neocallimastix patriciarum* for high-level expression in *Escherichia coli*. *J. Biotechnol.* **38**: 269–277.
- Yamamoto K.R., Alberts B.M., Benzinger R., Lawhorne L., and Treiber G. 1970. Rapid bacteriophage sedimentation in the presence of polyethylene glycol and its application to large-scale virus purification. *Virology* **40**: 734–744.
- Yanisch-Perron C., Vieira J., and Messing J. 1985. Improved M13 phage cloning vectors and host strains: Nucleotide sequences of the M13mp18 and pUC19 vectors. *Gene* **33**: 103–119.
- Yeh E., Skibbens R.V., Cheng J.W., Salmon E.D., and Bloom K. 1995. Spindle dynamics and cell cycle regulation of dynein in the budding yeast *Saccharomyces cerevisiae*. *J. Cell Biol.* **130**: 687–700.
- Yona G., Linial N., Tishby N., and Linial M. 1998. A map of the protein space — An automatic hierarchical classification of all protein sequences. *Ismb* **6**: 212–221.
- Young R.A. and Davis R. 1983a. Efficient isolation of genes by using antibody probes. *Proc. Natl. Acad. Sci.* **80**: 1194–1198.
- . 1983b. Yeast RNA polymerase II genes: Isolation with antibody probes. *Science* **222**: 778–782.
- Young R.A., Bloom B.R., Grosskinsky C.M., Ivanyi J., Thomas D., and Davis R.W. 1985. Dissection of *Mycobacterium tuberculosis* antigens using recombinant DNA. *Proc. Natl. Acad. Sci.* **82**: 2583–2587.

- Yuen K.C.L., Johnson T.K., Denell R.E. and Consigli R.A. 1982. A silver-staining technique for detecting minute quantities of proteins on nitrocellulose paper: Retention of antigenicity of stained proteins. *Anal. Biochem.* **126**: 398–402.
- Yuksel K.U. and Gracy R.W. 1985. The quantitation of proteins in silver stained polyacrylamide gels. *Electrophoresis* **6**: 361–366.
- Zagursky R.J. and Berman R.L. 1984. Cloning vectors that yield high levels of single-stranded DNA for rapid DNA sequencing. *Gene* **27**: 183–191.
- Zhang M.Q. 1997. Identification of protein coding regions in the human genome based on quadratic discriminant analysis. *Proc. Natl. Acad. Sci.* **94**: 565–568.
- . 1998. Identification of human gene core-promoters in silico. *Genome Res.* **8**: 319–326.
- Zhang S., Zubay G., and Goldman E. 1991. Low-usage codons in *Escherichia coli*, yeast, fruitfly and primates. *Gene* **105**: 61–72.
- Zhang Z., Schaffer A.A., Miller W., Madden T.L, Lipman D.J., Koonin E.V., and Altschul S. 1998. Protein sequence similarity searches using patterns as seeds. *Nucleic Acids Res.* **26**: 3986–3990.
- Zhu J., Liu J.S., and Lawrence C. 1997. Bayesian and adaptive alignment and inference. *Ismb* **5**: 358–368.
- . 1998. Bayesian adaptive sequence alignment algorithms. *Bioinformatics* **14**: 25–39.
- Ziegler M.M. and Baldwin T.O. 1981. Biochemistry of bacterial bioluminescence. *Curr. Top. Bioenerg.* **12**: 65–113.
- Zimmer R. and Verrinder Gibbins A.M. 1997. Construction and characterization of a large-fragment chicken bacterial artificial chromosome library. *Genomics* **42**: 217–226.
- Zimmerman S.B. and Minton A.P. 1993. Macromolecular crowding: Biochemical, biophysical, and physiological consequences. *Annu. Rev. Biophys. Biomol. Struct.* **22**: 27–65.
- Zimmerman S.B. and Pfeiffer B.H. 1983. Macromolecular crowding allows blunt-end ligation by DNA ligases from rat liver or *Escherichia coli*. *Proc. Natl. Acad. Sci.* **80**: 5852–5856.
- Zoller M.J. and Smith M. 1984. Oligonucleotide-directed mutagenesis: A simple method using two oligonucleotide primers and a single-stranded DNA template. *DNA* **3**: 479–488.
- . 1987. Oligonucleotide-directed mutagenesis: A simple method using two oligonucleotide primers and a single-stranded DNA template. *Methods Enzymol.* **154**: 329–350.
- Zuker M. 1989. On finding all suboptimal foldings of an RNA molecule. *Science* **244**: 48–52.
- Zwieb C. 1997. The uRNA database. *Nucleic Acids Res.* **25**: 102–103.

# Index

*We shall not cease from exploration  
And the end of all our exploring  
Will be to arrive where we started  
And know the place for the first time.*

I.S. EICHT

- Aat*II cleavage at end of DNA fragments, A6.4  
ABLE C, 1.15  
ABLE K, 1.15  
ABTS. *See* 2,2'-azino-bis(3-ethylbenzthiazoline-6-sulphonic acid)  
Acc65 cleavage at end of DNA fragments, A6.4  
AccI cleavage of 7-deaza-dCTP modified DNA, 8.60  
AccIII, A4.7  
Acetic acid  
  for polyacrylamide gel fixation, 5.49–5.50, 12.90–12.92  
  recipes, A1.6  
Acetonitrile, 10.28–10.29, 10.42, 10.49, 18.68  
Acetyl-CoA, 17.95  
  CAT, 17.36–17.41  
  luciferase and, A9.22  
Acid citrate dextrose solution B (ACD), 6.8–6.9  
Acid-hydrolyzed casein (AHC) medium, 4.65  
Acid-phenol guanidinium thiocyanate-chloroform extraction, 7.4–7.8  
Acids and bases, general, A1.6  
Acridine orange and glyoxylated RNA staining, 7.27  
Acridinium esters, chemiluminescence from, A9.17–A9.18  
Acrylamide, 12.74–12.75, A8.40–A8.43. *See also* Polyacrylamide; Polyacrylamide gel electrophoresis  
  recipe, A1.25  
  solutions for denaturing gels, table of, 12.78  
  solutions for denaturing polyacrylamide gels containing formamide, table of, 12.82  
  storage, 12.75  
Acrylamide gel elution buffer, 5.51–5.52  
Acrylease, 5.44, 12.75  
Actinomycin C<sub>1</sub>, A2.7  
Actinomycin D, 11.38, A1.15  
  mechanism of action, 7.88, A2.7  
  overview, 7.88  
  in primer extension mix, 7.77  
  self-priming, inhibition of, 11.46  
  structure of, 7.88  
Activation domain fusion plasmids, 18.20  
ADA. *See* Adenosine deaminase  
Adamantyl 1,2-dioxetane phosphate (AMPPD), 9.79, A9.39–A9.40, A9.42–A9.44  
  kinetics of chemiluminescence, A9.44  
Adaptors  
  attaching to protruding termini, 1.88–1.89  
  cDNA cloning, 11.20–11.21, 11.51–11.55  
  in direct selection of cDNAs protocol, 11.102  
  directional cloning, 1.84  
  overview, 1.160  
  table of sequences, 1.161  
*adc* gene, 4.2, 4.59–4.60, 18.22  
Adenine, A6.6  
  methylation of, 11.48, 13.87–13.88, A4.3–A4.4  
  nitrous oxide modification of, 13.78  
  related compounds (Table A6-5), A6.6  
  structure, A6.6  
  in YAC vector growth, 4.65  
Adenosine deaminase (ADA), 16.47  
Adenosine diphosphate (ADP), A1.25  
Adenosine triphosphate (ATP), A1.25  
  dATP inhibition of T4 DNA ligase, 1.85  
  luciferase and, 17.44–17.45, 17.47, A9.22  
ADP. *See* Adenosine diphosphate  
Adsorption, viral, 2.4  
*Aequorea victoria*, 18.69, A9.24. *See also* Green fluorescent protein  
Aequorin, 17.84, 17.89, A9.24  
Affinity chromatography. *See also* Chromatography  
  antisera purification, 14.51  
  biotin:avidin, 11.11  
  of *E. coli* lysate for cross-reactive antibody removal, 14.28–14.30  
  epitope tagging and, 17.91  
  fusion protein purification, 14.40, 14.43, 15.4–15.5  
  on amylose resin, 15.40–15.43  
  on glutathione agarose, 15.36–15.39  
  of maltose-binding proteins, 15.40–15.43  
  histidine-tagged protein purification, 15.44–15.48  
  metal chelate, 15.44–15.48  
  removal of cross-reactive antibodies, 14.28–14.30  
Affinity purification using magnetic beads, 11.118–11.120  
*Afl*II cleavage at end of DNA fragments, A6.4  
Agar, media containing, A2.5  
Agarase, 5.33–5.35, 5.83–5.88, A4.51  
Agarose. *See also* Agarose gel electrophoresis  
  blocks/plugs  
    λ concatemer ligation in, 5.72–5.73  
    lysis of cells in, 5.61, 5.64–5.65, 5.67  
    for pulsed-field gel electrophoresis, 5.59, 5.61–5.70  
  restriction endonuclease digestion of DNA in, 5.68–5.70  
  storage of, 5.64, 5.67  
  composition of, 5.4  
  electroendo-osmosis (EEO), 5.7  
  low-melting-temperature, 5.6, 5.7  
  DNA recovery from, 5.29–5.35  
    pulsed-field gel electrophoresis gels, 5.83–5.88  
  DNA size selection in shotgun sequencing protocol, 12.18  
  λ concatamer ligation in, 5.72–5.73  
  ligation in, 1.103–1.104, 5.29  
  migration rate through, 5.31  
  properties of, 5.6  
  pulsed-field gel electrophoresis, 5.61–5.67, 5.83–5.88  
  radiolabeling DNA in gel slices, 9.9  
  resolution of, 5.6  
  restriction endonuclease digestion in agarose plugs, 5.68–5.70  
  media containing, A2.5  
  types of, 5.6  
Agarose gel electrophoresis. *See also* Pulsed-field gel electrophoresis  
  alkaline, 5.36–5.39  
  autoradiography, 5.39  
  method, 5.38  
  Southern hybridization, 5.38  
  uses for, 5.36  
  analysis of linker/adaptor attachment to cDNA, 11.55  
  analysis of methylation of cDNA, 11.50  
  band-stab PCR of samples from gel, 8.71  
  cDNA fractionation, 11.9  
  denaturing, 7.21–7.23, 7.27–7.34  
  DNA content of λ stock and lysates, assaying, 2.45–2.46  
  DNA detection, 5.14–5.17  
  ethidium bromide staining, 5.14–5.15  
  photography, 5.16–5.17  
  SYBR Gold staining, 5.15–5.16  
  DNA recovery, 1.91, 5.18  
  anion-exchange chromatography, 5.26–5.28  
  DEAE cellulose membranes, electrophoresis onto, 5.18–5.22  
  dialysis bags, electroelution into, 5.23–5.25  
  low-melting temperature agarose  
    agarase, 5.33–5.35  
    glass bead use, 5.32  
    organic extraction, 5.29–5.31  
  problems associated with, 5.18  
  DNA size selection in shotgun sequencing protocol, 12.18  
  DNA transfer from  
    capillary transfer  
      downward, 6.35  
      upward, 6.34–6.35  
    electrophoretic transfer, 6.36  
    simultaneous transfer to two filters, 6.35–6.36  
    vacuum transfer, 6.37  
  electrophoresis buffers. *See also* Electrophoresis buffers  
    effect on DNA migration, 5.7–5.8  
    gel preparation, 5.10  
    recipes, 5.8  
  ethidium bromide staining, A9.3–A9.4  
  gel-loading buffers, 5.9  
  history of, 5.3  
  λ arm purification, 2.71  
  large DNA molecules, difficulty entering the gel, 6.15  
  markers, radiolabeled size, 9.54  
  method, 5.10–5.13  
    comb placement, 5.11  
    gel preparation, 5.10  
    loading gel, 5.12–5.13  
    pouring gel, 5.11–5.13  
    well capacity, 5.12–5.13  
  methylene blue staining, A9.5  
  migration rate  
    DNA from alkaline lysis preparations, 1.40  
    DNA from boiled lysis preparations, 1.45, 1.49  
    DNA from toothpick minipreparations, 1.53  
  ethidium bromide and, 1.53  
  factors determining, 5.4–5.8  
    agarose concentration, 5.5  
    agarose type, 5.6–5.7  
    conformation of DNA, 5.5  
    electrophoresis buffer, 5.7–5.8  
    ethidium bromide presence, 5.5

- Agarose gel electrophoresis (*continued*)  
 size of DNA, 5.4  
 voltage applied, 5.5–5.6  
 minigels, 5.13  
 mRNA fractionation for cDNA preparation, 11.9  
 partial digestion products, separating, 2.78  
 polyacrylamide gels compared, 5.2, 5.40  
 pulsed-field gel electrophoresis  
 overview of, 5.2–5.3  
 resolution, 5.3  
 for quantitating DNA, A8.24  
 reptation, 5.2  
 resolution, 5.2, 5.6, 5.12  
 RNA separation  
 equalizing RNA amounts, 7.22–7.23  
 formaldehyde-containing gels, 7.31–7.34  
 glyoxylated RNA, 7.27–7.30  
 markers used for, 7.23, 7.29  
 overview, 7.21–7.22  
 pseudomessages as standards, 7.23  
 tracking dyes, 7.23  
 RNA transfer to membranes, 7.35–7.41  
 Southern hybridization, 1.28  
 standards, DNA size, 5.10  
 storage of gels, 6.43
- AgeI cleavage at end of DNA fragments, A6.4  
 A gene/protein,  $\lambda$ , 2.14–2.15  
 Air bubbles in polyacrylamide gels, 12.79  
 Ala-64 subtilisin, 15.8  
 Alanine  
 codon usage, A7.3  
 nomenclature, A7.7  
 properties, table of, A7.8  
 Alanine-scanning mutagenesis, 13.3, 13.81  
 Alkaline agarose gel electrophoresis, 5.36–5.39. *See also* Agarose gel electrophoresis  
 autoradiography, 5.39  
 buffer, A1.17  
 method, 5.38  
 Southern hybridization, 5.38  
 uses of, 5.36  
 Alkaline gel-loading buffer, A1.18  
 Alkaline lysis  
 BAC DNA purification protocols, 4.53–4.57  
 in P1 PAC DNA purification protocols, 4.41–4.43  
 plasmid DNA protocols, 1.19  
 maxipreparation protocol, 1.38–1.41  
 midipreparation protocol, 1.35–1.37  
 minipreparation protocol, 1.32–1.34  
 overview, 1.31  
 troubleshooting, 1.41–1.42  
 yield, 1.41  
 Alkaline lysis solutions I, II, and III, 1.32–1.33, 1.35–1.36, 1.38, 1.40, 3.24–3.25  
 in plasmid DNA purification by precipitation with PEG, 12.51  
 recipes, A1.16  
 Alkaline phosphatase, A8.55  
 antibody conjugates, A9.34  
 calculating amount of 5' ends in a DNA sample, 9.63  
 chemiluminescent enzyme assay, A9.19  
 dephosphorylation  
 of M13 vector DNA, 12.24  
 of plasmid DNA, 1.93–1.97  
 digoxigenin-specific antibodies coupled to, A9.39–A9.40  
 in end-labeling, 9.55  
 inactivation, 1.96, 9.62, 9.64, 9.93  
 $\lambda$  vector DNA, treatment of, 2.68–2.70  
 in M13 vectors, 3.34, 3.36  
 overview, 9.92–9.93, A4.37  
 properties of, 9.92–9.93  
 protocol, 9.62–9.65  
 purification of dephosphorylated DNA, 9.64
- as reporter enzyme, 9.92, 17.31  
 for biotin, 9.76  
 chemiluminescence, 9.79  
 colorimetric assays, 9.78  
 for digoxigenin, 9.77  
 direct detection, 9.80  
 for fluorescein, 9.77  
 fluorescent assays, 9.79  
 in screening expression libraries, 14.3  
 chemiluminescent, 14.11, 14.21  
 chromogenic, 14.9–14.10, 14.20  
 self-ligation, prevention of, 9.92  
 substrates  
 AMPPD, A9.39, A9.42–A9.44  
 BCIP/NPT, A9.39–A9.40  
 D-luciferin-O-phosphate, A9.42  
 p-nitrophenyl phosphate, A9.41–A9.42  
 use in cosmid vector cloning, 4.15, 4.19, 4.20–4.21
- Alkaline phosphatase promoter (PhoA) for expression of cloned genes in *E. coli*, 15.30–15.35  
 large-scale expression, 15.34  
 materials for, 15.31–15.32  
 optimization, 15.33  
 overview, 15.30  
 protocol, 15.32–15.34  
 subcellular localization of fusion proteins, 15.35
- Alkaline transfer buffer, 6.40, 6.44, 6.46, A1.12  
 Allele-specific oligonucleotides (ASO), 13.91, 13.95  
 Allyl alcohol, 12.70–12.71  
 $\alpha$ -amanitin, 17.29  
 $\alpha$ -complementation, 1.149, 1.150  
 in BAC vectors, 4.3  
 in  $\lambda$  vectors, 11.22, 11.25  
 in M13, 3.8, 3.10, 3.33  
 in pMAL vectors, 15.40  
 problems with, 1.27, 1.150  
 in protein-protein interaction assays, 18.127  
 protocol, 1.123–1.125  
 in pUC vectors, 1.10, 3.9  
 $\alpha$ -galactosidase (MEL1), 18.14  
 $\alpha$ -thrombin, 15.8  
 Altered sites II in vitro mutagenesis system, 13.89  
*Alteromonas espejiana*, 13.62, 13.71–13.72, A4.43  
 AluI cleavage of 7-deaza-dGTP-modified DNA, 8.60  
 AluI methylase, A4.7  
 AMAD. *See* Another MicroArray database  
 Amber mutation, A7.5  
 in  $\lambda$  S gene, 2.15  
 in M13 vectors, 3.11–3.13  
*supE* mutation, 3.11–3.13  
 Amber suppressors, A7.5–A7.6  
 Amberlite XAD-16, A8.28  
 Ambion, 1.64  
 Amidine, 16.11  
 Amine-coupling kit, 18.104  
 Amino acids  
 codon usage, A7.2–A7.4  
 hydrophobicity/hydrophilicity scales, A9.31  
 nomenclature, table of, A7.7  
 overview, A7.6  
 properties, table of, A7.8–A7.9  
 side chain properties, A7.7  
 Venn diagram of, A7.6  
 N-(4-aminobutyl)-N-ethylisoluminol (ABEI), A9.18  
 Aminoformamide hydrochloride. *See* Guanidinium chloride  
 Aminoglycoside phosphotransferase, 16.47–16.48  
 Aminophosphotransferases (APHs), 1.145  
 Aminopterin, 16.47, 16.48  
 Ammonium acetate  
 in ethanol precipitation of nucleic acids, A8.12  
 in ethanol precipitation of oligonucleotides, 10.20–10.21  
 recipe, A1.25
- Ammonium hydroxide, A1.6  
 Ammonium ion inhibition of T4 polynucleotide kinase, A4.35  
 Ammonium persulfate, 5.41–5.43, 7.58, 12.75, 12.78, 12.82, 13.53–13.54, A1.25, A8.42  
 Ammonium sulfate, 8.9, 11.43, 11.45  
 in long PCR buffer, 8.78  
 in PCR lysis solution, 6.22  
 ampC, 15.26  
 Amphotericin, A2.7  
 Ampicillin, 1.9  
 mechanism of resistance to, 1.148  
 modes of action, 148, A2.7  
 properties, 1.148  
 satellite colonies, 1.148  
 selecting transformants, 1.110, 1.115, 1.118  
 stock/working solutions, A2.6  
 Ampicillin resistance gene (*amp<sup>r</sup>*) gene, 1.9  
 in activation domain fusion plasmids, 18.20  
 in LexA fusion plasmids, 18.19  
 in pMC9, 14.6  
 in two-hybrid system of reporter plasmids, 18.12
- Amplification  
 of bacteriophage, in situ, 2.95  
 of cDNA libraries, 11.64–11.66  
 of cosmid libraries  
 on filters, 4.31–4.32  
 in liquid culture, 4.28–4.30  
 on plates, 4.34  
 of genomic libraries, 2.87–2.89  
 for hybridization procedures, 1.128, 1.131  
 of plasmids  
 chloramphenicol and, 1.4, 1.39, 1.48, 1.56, 1.128, 1.131, 1.143  
 runaway plasmid vectors, 1.13  
 Amplification buffer, A1.9  
 Amplification refractory mutation system (ARMS), 13.91, 13.96  
 Amplify scintillant, A9.12  
 AmpliTaq DNA polymerase. *See also* Taq DNA polymerase  
 AmpliTaq Gold, 8.110  
 CS DNA polymerase, 12.54  
 in cycle sequencing reactions, 12.46–12.47  
 structure of, 12.47  
 FS DNA polymerase  
 in cycle sequencing reactions, 12.46–12.47  
 in DNA sequencing  
 automated, 12.98  
 dye-primer sequencing, 12.96  
 dye-terminator systems, 12.96–12.97  
 structure of, 12.47  
 properties, table of compared, A4.11  
 AmpliMax PCR Gems, 8.110  
 AMPPD. *See* Adamantyl 1,2-dioxetane phosphate  
 amp<sup>r</sup>. *See* Ampicillin resistance gene (*amp<sup>r</sup>*) gene  
 Amylose agarose, affinity chromatography use of, 15.40–15.43  
 Analytical ultracentrifugation, 18.96  
 Anion-exchange chromatography, DNA purification by, 5.26–5.28  
 Annealing buffer in nuclease S1 mapping of RNA, 7.55, 7.58  
 Annealing reactions  
 CTAB and, 6.62  
 in PCR, 8.8–8.9  
 in primer extension assays, 7.76, 7.79  
 in ribonuclease protection assay protocol, 7.73  
 in S1 protection assays, 7.51  
 Annealing temperature  
 in inverse PCR, 8.85  
 in long PCR, 8.80  
 in touchdown PCR, 8.112  
 Another MicroArray database (AMAD), A10.15  
 Antibiotics. *See also* specific antibiotics  
 modes of action, table of, A2.7

- for protein expression optimization, 15.19
- as selectable markers, 1.8–1.9
- stock working solutions, A2.6
- Antibodies, A9.25–A9.34
  - antipeptide, A9.30–A9.33
  - applications, A9.25
  - coimmunoprecipitation, 18.60–18.68
  - conjugated, A9.33–A9.34
    - biotinylated, A9.33
    - enzyme, A9.34
    - fluorochrome, A9.33
  - Cy3 labeling, 18.82–18.83
  - digoxigenin-specific, A9.40
  - epitope tagging, 1.14, 17.32, 17.90–17.93
  - Fab fragment generation and purification, 18.81–18.82
  - GFP, 17.89
  - immunological assays, A9.27–A9.30
    - immunoblotting, A8.54–A8.55
    - immunoprecipitation, A9.29
      - RIA, A9.29–A9.30
      - western blotting, A9.28
  - immunological screening
    - antibody choice for, 14.50–14.51
    - polyclonal vs. monoclonal, 14.50
    - purification, 14.51
  - phage display of, 18.122
  - probes for screening expression libraries, 14.1–14.2
  - protein microarrays, A10.18
  - purification of, A9.25–A9.27
  - radiolabeling, A9.30
  - removal of cross-reactive
    - affinity chromatography, 14.28–14.30
      - incubation with *E. coli* lysate, 14.26–14.27
      - pseudoscreening, 14.23–14.25
  - in SPR spectroscopy of protein interactions, 18.103–18.114
  - use in supershift assays, 17.17
- Antipain dihydrochloride, A5.1
- Antipeptide antibodies, A9.30–A9.33
- Antiporter proteins, 1.26, 1.146
- Antisense primer, 8.46–8.48, 8.50, 8.52, 8.56–8.57, 8.61, 8.63, 8.69, 8.90–8.92
- Antitermination factors in  $\lambda$ , 2.6–2.8, 2.11
- Antithrombin III, A5.1
- ApoI*
  - cleavage at end of DNA fragments, A6.4
  - fragment size created by, table of, A4.8
  - site frequency in human genome, 4.16, A6.3
- APHs. See Aminophosphotransferases
- APMSE, A5.1
- Aprotinin, 18.67, A5.1
  - in cell resuspension buffer, 17.6
  - as protease inhibitor, 15.19
- Aptamers, peptide, 18.8
- Apurinic DNA, screening expression libraries, 14.2
- Arabidopsis*
  - database, A11.20
  - genomic resources for microarrays, A10.6
- Arginine
  - for affinity purification of fusion proteins, 15.6
  - codon usage, A7.3
  - nomenclature, A7.7
  - properties, table of, A7.8
- ARMS. See Amplification refractory mutation system
- Arrayed libraries, 4.8
  - BAC, 4.50
  - differential screening, 9.90
  - PI, 4.39
  - YAC, 4.61
- Arrays. See DNA array technology
- ArrayVision image analysis program, A10.13
- AscI*
  - cleavage at end of DNA fragments, A6.4
  - fragment size created by, table of, A4.8
  - genomic DNA mapping, 5.68–5.69
  - site frequency in human genome, 4.16, A6.3
- AscI*, A4.9
- Asialofetuin*, for protein stability, 17.16
- Asparagine
  - codon usage, A7.3
  - nomenclature, A7.7
  - properties, table of, A7.8
- Aspartic acid
  - cleavage by formic acid, 15.6, 15.8
  - codon usage, A7.3
  - nomenclature, A7.7
  - properties, table of, A7.8
- Aspergillus oryzae*, A4.46
- Aspiration of supernatants, 1.33, 1.36, 1.45
- Assembly of bacteriophage particles,  $\lambda$ , 2.14–2.15
- ASSET (Aligned Segment Statistical Evaluation Tool) program, A11.9
- AstII*, A4.7
- Atlas cDNA arrays, A10.9
- ATP. See Adenosine triphosphate
- att* sites,  $\lambda$ , 2.16, 2.18
- AU epitopes, 17.93
- Authorin program, A11.3
- Autographa californica* nuclear polyhedrosis (AcNPV or AcMNPV), 17.81–17.83
- Autonomously replicating sequence (ARS), 4.2–4.3, 4.60
- Autoradiography, A9.9–A9.15
  - of alkaline agarose gels, 5.39
    - chemical DNA sequencing gels and, 12.61–12.62, 12.74, 12.90–12.91
    - chemiluminescent, 14.11–14.12, 14.21–14.22
    - in coimmunoprecipitation protocol, 18.62–18.63
  - DNase I footprinting, 17.76
  - fluorography, A9.12
  - imaging, A9.9–A9.10
  - intensifying screen, A9.11
  - isotopes used
    - decay data, A9.15
    - particle spectra, A9.9–A9.10
    - sensitivity of detection, A9.13
  - mutation detection with SSCP, 13.52, 13.55
  - phosphorimaging, A9.11–A9.14
  - phosphorimaging devices, A9.14
  - polyacrylamide gels, DNA detection in, 5.49
  - preflashing, A9.11–A9.12
  - reading an autoradiograph, 12.113
  - setting up autoradiographs, A9.13–A9.14
- AvaI* in phosphorothioate incorporation mutagenesis, 13.86
- Avian myeloblastosis virus (AMV), 11.109. See also Reverse transcriptase
  - reverse transcriptase, A4.24–A4.25
  - RNA-dependent DNA polymerase, 8.48
  - RNase H activity, 11.109
- Avidin, 11.115–11.117, A9.45
- Avidin-biotin (ABC) assay, A9.33
- AvrII*
  - cleavage at end of DNA fragments, A6.4
  - fragment size created by, table of, A4.8
  - site frequency in human genome, 4.16, A6.3
- 2,2'-azino-di(3-ethylbenzthiazoline-6-sulphonic acid) (ABTS), A9.35
- BAC. See Bacterial artificial chromosomes
- Bacillus subtilis*
  - expression in, 15.55
  - genomic resources for microarrays, A10.6
- Bacterial alkaline phosphatase (BAP), 9.92–9.93, A4.37
- Bacterial artificial chromosomes (BACs), 4.48–4.57
  - advantages of, 4.48
  - $\alpha$ -complementation in, 4.3
  - CIT Human BAC Library, 4.9
  - clone size, 4.3–4.4
  - copy number, 4.48
  - DNA purification
    - from large-scale cultures, 4.55–4.57
    - from small-scale cultures, 4.53–4.54
  - electroporation, 4.49, 4.52
  - genomic libraries
    - arrayed libraries, 4.8
    - choosing for construction of, 4.7–4.10
    - construction, 4.49–4.50
    - RPCI-11 Human BAC Library, 4.9
    - screening, 4.50–4.51
  - low-copy-number replicons, 1.3
  - overview, 4.2–4.4
  - size of inserts, 4.49
  - storage, 4.51
  - vectors, A3.5
- Bacterial colonies, screening by PCR, 8.74–8.75
- Bacterial cultures
  - receiving in the laboratory, 1.29
  - storage of, A8.5
- Bacterial strains. See *Escherichia coli* strains
- Bacteriophage
  - $\phi$ 1. See  $\phi$ 1 bacteriophage
  - $\phi$ X174. See  $\phi$ X174 bacteriophage
  - $\lambda$ . See  $\lambda$  bacteriophage
  - M13. See M13 bacteriophage
  - P1. See P1 bacteriophage
  - SP6. See SP6 bacteriophage
  - T3. See T3 bacteriophage
  - T4 DNA ligase buffer, A1.9
  - T4 DNA polymerase buffer, A1.10
  - T4 DNA polymerase repair buffer, 11.53
  - T4 polynucleotide kinase buffer, A1.10
  - T7. See T7 bacteriophage
- Bacteriophages. See also specific bacteriophages
  - CsCl density gradients purification of, 1.155
  - filamentous, 3.1–3.7
  - historical perspective, 2.109
  - male-specific, 3.2
  - origin of replication, 1.11
  - phagemids, 1.11
  - promoters, 1.11–1.12, 9.31. See also Promoters: specific promoters
- Baculovirus, 17.81–17.84
  - expression systems
    - commercial, 17.84
    - drawbacks of, 17.83
    - vectors, 17.83
  - gene expression in, 17.82
  - history, 17.81
  - host interactions, 17.81–17.82
  - as pesticides, 17.81
  - vectors, 17.83
- Baking hybridization membranes, 6.46
- BAL 31 buffer, A1.10
- BAL 31 nuclease, 13.2
  - activities of, 13.68
    - endonuclease activity, A4.44–A4.45
    - exonuclease activity, A4.44–A4.45
  - assaying activity of, 13.64–13.65
  - checking progress of digestion, 13.71
  - deletion mutant sets, generation of bidirectional, 13.62–13.67
    - materials for, 13.62–13.63
    - protocol, 13.63–13.67
  - fast and slow forms, A4.14
  - heat inactivation of, 13.65
  - history of, 13.71–13.72
  - inhibition by EGTA, 13.64
  - overview, 13.68–13.72, A4.43–A4.45
  - properties of, 13.68–13.71
  - storage, A4.44
  - unidirectional mutations, generation of, 13.68, 13.70
  - uses, list of, A4.43



- Bam*HI  
7-deaza-dGTP modified DNA, cleavage of, 8.60  
cleavage at end of DNA fragments, A6.4  
*dam* methylation and, 13.87, A4.3  
directional cloning use of, 1.84  
fragment size created by, table of, A4.8  
linker sequences, 1.99  
methylase, A4.7  
site frequency in human genome, 4.16, A6.3  
in USE, 13.85
- Band-stab PCR of samples from gel, 8.71  
BankIt program, A11.3  
BAP. See Bacterial alkaline phosphatase  
Barcode chip, A10.19  
Barnase in positive selection vectors, 1.12  
Base-excision repair, exonuclease III and, 13.73  
Batch chromatography, selection of poly(A)<sup>+</sup> RNA by, 7.18–7.19  
BAX gene, 17.72  
Baxes Block Aligner program, A11.4–A11.5  
Baylor College of Medicine Search Launcher, A11.2  
BB4 *E. coli* strain, 2.29, 11.23–11.25, 11.60–11.62, 11.66, 14.6, A3.6  
BCIP (5-bromo-4-chloro-3-indolyl phosphate), 9.78, 14.9–14.10, 14.20, A9.39–A9.42  
*Bcl*I, 13.87, A4.3, A4.9  
BEAUTY (BLAST Enhanced Alignment Utility) program, A11.17  
Beckman Coulter Multimek, A10.5  
Benzamide as protease inhibitor, 15.19  
BES (N,N-bis[2-hydroxyethyl]-2-aminoethanesulfonic acid), 16.19  
BES buffered saline (BBS), 16.19–16.20  
Bestatin, A5.1  
β-actin, normalizing RNA samples against, 7.22  
β-galactosidase, 17.97–17.99. See also Fusion proteins; *lacZ*  
α complementation, 1.26–1.27, 1.123, 1.125, 1.149–1.150  
antibody conjugates, A9.34  
assay of activity by chloroform overlay assay, 18.28  
chemiluminescent enzyme assay, A9.19  
fusion proteins, 15.26  
affinity purification of fusion proteins, 15.6  
disadvantages, 15.58  
inclusion bodies, 15.58  
vectors for, 15.59  
histochemical stains, 17.98–17.99  
immunohistochemical staining of cell monolayers for, 16.13  
ONPG substrate, 17.50–17.51  
in protein-protein interaction assays, 18.127  
quantitative assays  
MUG hydrolysis, 17.98  
ONPG hydrolysis, 17.97–17.98  
reaction catalyzed by, 17.98–17.99  
reporter assays, 17.48–17.51  
as digoxigenin reporter enzyme, 9.77  
endogenous mammalian β-galactosidase activity, 17.48  
materials for, 17.50  
method, 17.51  
normalizing reporter enzyme activity to β-galactosidase activity, 17.48, 17.51  
overview, 17.48–17.49  
pβ-gal reporter vectors, 17.49  
substrates for β-galactosidase, 17.51  
substrates, 17.50  
as transfection control (reporter gene), 16.4, 16.12–16.13  
vectors containing. See also specific vectors  
Bluescript plasmid, 1.27  
expression vectors, 14.47–14.48  
λ vectors, 2.30, 11.22, 11.25  
pGEM, 1.27  
pMAL vectors, 15.40  
pUC vectors, 1.10  
X-gal, 1.149  
β-glucuronidase, 16.42, 18.14  
β-glucuronidase lysis solution, 18.46  
β-lactamase  
mechanism of action, 1.148  
satellite colonies and, 1.110, 1.115, 1.118  
β-mercaptoacetic acid, 15.44  
β-mercaptoethanol, 15.44  
β-nicotinamide adenine dinucleotide (β-NAD), 11.43, 11.45  
*Bgl*II  
fragment size created by, table of, A4.8  
linker sequences, 1.99  
site frequency in human genome, 4.16, A6.3  
*Bgl*III  
cleavage at end of DNA fragments, A6.4  
*dam* methylation and, 13.87, A4.3  
directional cloning use of, 1.84  
fragment size created by, table of, A4.8  
site frequency in human genome, 4.16, A6.3  
in USE, 13.85  
BHB2688 *E. coli* strain  
genotype, A3.6  
λ vector propagation, 2.29  
BHB2690 *E. coli* strain  
genotype, A3.6  
λ vector propagation, 2.29  
BIAcore, 18.96–18.114  
BIAevaluation software, 18.97, 18.101–18.102, 18.112  
BIAsimulation software, 18.98  
chips, 18.98–18.100  
components of, 18.97  
Interaction Wizard, 18.108  
protocol design, 18.102–18.114  
sensorgrams, 18.100–18.101, 18.112–18.114  
writing methods with BIAcore Method Definition Language, 18.108  
BIAevaluation software, 18.97, 18.101–18.102, 18.112  
BIAsimulation software, 18.98  
Bidirectional dideoxy fingerprinting (Bi-ddF), 13.91, 13.94  
BigDye terminators, 12.96–12.99  
Binary expression system, 9.88  
Binding buffer, 14.33, 15.45  
BioChip Arrayer, A10.16  
BioChip Imager, A10.11  
Bioelectric chips, A10.19  
Bio-Gel HTP, A8.33  
Bio-Gel P-60, 10.26, A8.29–A8.30  
*bio* gene, λ transduction of, 2.18  
Bioinformatics, A10.15, A11.1–A11.23  
databases, A11.20–A11.21  
DNA, A11.20–A11.21  
microarray, A10.15  
protein, A11.22–A11.23  
RNA, A11.21–A11.22  
database similarity search software (Table A11-2), A11.18–A11.19  
software (Table A11-1), A11.3–A11.7  
DNA, A11.3–A11.14  
genes, exons and introns, A11.10–A11.12  
motifs and patterns, A11.8–A11.10  
promoters, transcription-factor-binding sites, A11.12–A11.13  
regulatory sites, miscellaneous, A11.14  
scoring matrices, A11.5  
sequence alignment, A11.3–A11.8  
sequence submission, A11.3  
protein, A11.16–A11.17  
motifs, patterns, and profiles, A11.16–A11.17  
sequence alignment, A11.16  
RNA, A11.14–A11.15  
RNA-specifying genes, motifs, A11.15  
secondary structure, A11.14–A11.15  
Web site resources, A11.2  
Biostistic PDS-1000/He Particle Delivery System, 16.39  
Biostistics, 16.3, 16.37–16.41  
materials for, 16.38–16.39  
method, 16.39–16.41  
particle types, 16.37  
variables, 16.37  
Bioluminescence, A9.21–A9.24  
bacterial luciferase, A9.23–A9.24  
firefly luciferase, A9.21–A9.23  
assays for, A9.22–A9.23  
properties of, A9.21–A9.22  
as reporter molecule, A9.23  
GFP, A9.24  
Bioluminescent resonance energy transfer (BRET), 17.87–17.89  
Biomolecular Structure and Modeling group at the University College, London, A11.22  
BioRobot (Qiagen), A10.5  
Biotin, 9.76–9.79, A9.45  
bridged avidin-biotin (BRAB) assay, A9.33  
CARD protocol and, A9.19  
derivatives, 11.116  
labeling  
antibodies, A9.33  
in cycle DNA sequencing, 12.52  
direct selection of cDNAs protocol, 11.98–1.99, 11.102, 11.106  
enzymatic labeling, 9.77–9.78  
GST, 18.50  
of nucleic acids, 11.116–11.117  
photolabeling, 9.78  
probes, for in situ hybridization, 9.35  
of proteins, 11.115–11.117  
in subtractive hybridization, 9.91  
overview, 11.115  
structure of, 11.116, A9.45  
in SPR spectroscopy, 18.99  
Biotin:avidin affinity chromatography, 11.11  
Bisacrylamide, 12.74–12.75, A8.40–A8.41. See also Polyacrylamide gel electrophoresis  
storage, 12.75  
Bis-Tris, 7.28  
Bis-Tris-Cl, 5.33  
Bisulfite, mutagenesis from, 13.78  
BL21 *E. coli* strain, 15.21–15.23, A3.6  
*bla* gene, 1.148  
BLAST (Basic Alignment Search Tool) program, A11.3, A11.18  
BLAST2 (Gapped-BLAST) program, A11.18–A11.19  
BLAST-Genome Sequences program, A11.19  
Bleomycin modes of action, A2.7  
BLIMPS-BLOCKS Improved Searcher program, A11.9  
Blocking agents, A1.14–A1.16, A8.54  
for nucleic acid hybridization, A1.14–A1.15  
for western blotting, A1.16  
Blocking buffer, 14.4, 14.9, 14.15, 14.23, 14.26, A1.12  
BLOCKS server program, A11.9  
Blood cells  
buffy coat removal by aspiration, 6.9  
collection of cells  
from freshly drawn blood, 6.8–6.9  
from frozen blood, 6.9  
lysis of, 6.8–6.9  
BLOSUM scoring matrices program, A11.5  
BLOTTO (Bovine Lacto Transfer Technique Optimizer)  
in northern hybridization, 7.45  
for protein stability, 17.16  
recipe, A1.15

- in Southern hybridization, 1.139, 6.56, A1.14–A1.15
- Bluescript vectors. *See* pBluescript vectors
- Blunt-ended DNA
- addition of synthetic linkers to, 1.98–1.102
  - cloning, 1.22–1.24
  - of PCR products, 8.32–8.34
  - into plasmid vectors, 1.90–1.92
  - creation with T4 DNA polymerase, A4.19
  - end-labeling with Klenow, 9.52–9.53, 9.55–9.56
  - generation by mung bean nuclease, 7.87
  - ligation with T4 DNA ligase, A4.31–A4.32
  - linker/adaptor ligation, 11.51–11.52
  - phosphorylation of, 9.70–9.72
  - radiolabeling using Klenow, 12.101
- BMH71-18 *E. coli* strain, 13.29
- BNN93 *E. coli* strain
- genotype, A3.6
  - $\lambda$  vector propagation, 2.28
- BNN102 *E. coli* strain, 4.83–4.84, 11.59–11.60, 11.62, 11.64–11.65
- genotype, A3.6
  - $\lambda$  vector propagation, 2.28
- Boiling lysis plasmid DNA protocols
- large-scale, 1.47–1.50
  - overview, 1.43
  - small-scale, 1.44–1.46
  - yield, 1.50
- Bolton-Hunter reagent, A9.30
- Bombus mori* nuclear polyhedrosis virus (BmNPV), 17.81
- bom* region, 1.146
- Bovine growth hormone (BGH) poly(A) signal, 17.72
- Bovine Lacto Transfer Technique Optimizer. *See* BIOTTO
- Bovine milk casein for protein stability, 17.16
- Bovine serum albumin (BSA)
- as blocking agent, A8.54
  - in long PCR buffer, 8.78
  - in PCR, 8.23
  - for protein stability, 17.16
  - SDS absorption by, 6.25
- Bovine submaxillary mucin (type1) for protein stability, 17.16
- BPT1, electrophoresis buffer, 7.28–7.29, A1.17
- BRAB. *See* Bridged avidin-biotin assay
- BRET. *See* Bioluminescent resonance energy transfer
- Bridged avidin-biotin (BRAB) assay, A9.33
- Brilliant Blue. *See* Coomassie Brilliant Blue
- BRIT database, A10.15
- 5-Bromo-4-chloro-3-indolyl phosphate. *See* BCIP
- 5-Bromo-4-chloro-3-indolyl- $\beta$ -D-galactoside. *See* X-gal
- Bromocresol green in alkaline agarose gel electrophoresis, 5.36
- 5-Bromodeoxyuridine (BrdU), 9.76, 16.47
- Bromophenol blue, 5.36
- in agarose gel electrophoresis gel-loading buffers, 1.53, 5.9
  - in denaturing agarose gels, 7.23
  - in formaldehyde gel-loading buffer, 7.32
  - in formamide buffers, 7.77, 17.6
  - inhibition of PCR by, 8.13
  - migration rate through polyacrylamide gels, 12.89
  - oligonucleotide size and comigration in polyacrylamide, 10.15
  - polyacrylamide gel electrophoresis, 5.42, 7.57
  - recipe, A1.18
  - in RNA gel-loading buffer, 7.68
  - in SDS gel-loading buffer, A8.42
  - sucrose solution, 17.14, A1.19
  - Taq* polymerase inhibition by, 1.53
- BSA. *See* Bovine serum albumin
- BSC-1 cell lines, 16.27
- Bst*WI cleavage at end of DNA fragments, A6.4
- Bsp*E1 cleavage at end of DNA fragments, A6.4
- Bsp*M1I1 methylation, A4.7
- Bsr*GI cleavage at end of DNA fragments, A6.4
- Bss*H1I
- cleavage at end of DNA fragments, A6.4
  - fragment size created by, table of, A4.8
  - genomic DNA mapping, 5.60, 5.69
  - site frequency in human genome, 4.16, A6.3
- Bst* DNA polymerase, 8.10, A4.23
- Bst*BI, 5.69
- Bst*EII, A4.9
- Bst*NI, A4.9
- Bst*XI in exon amplification protocol, 11.79, 11.82, 11.89, 11.92
- Bsu*36I in end-labeling, selective, 9.52
- Btag, epitope tagging, 17.93
- Buffers, A1.2–A1.22. *See also specific buffer types and uses; specific buffers*
- electrophoresis, 5.7–5.8, A1.17–A1.18
  - enzyme dilution, A1.9
  - enzyme reaction, A1.9–A1.12
  - extraction/lysis buffers, A1.16
  - gel-loading, 5.9, A1.18–A1.20
  - hybridization buffers, A1.12–A1.13
  - pH, A1.7–A1.8
  - phosphate, A1.5
  - properties of good buffers, A1.3–A1.4
  - restriction
    - DNA migration in agarose, effect on, 5.10
    - sequential use of, 1.86
  - Tris, A1.2–A1.3
- Buffy coat, removal by aspiration, 6.9
- Butanol, 12.70–12.71
- concentrating nucleic acids by extraction with, A8.18
  - for removal of ethidium bromide from DNA, 1.73, 1.151, A8.27
- <sup>14</sup>C
- particle spectra, A9.10
  - sensitivity of autoradiographic methods for detection, A9.13
- C600 *E. coli* strain, 11.59–11.60, 11.62, 11.65, 15.32
- genotype, A3.6
  - $\lambda$  vector propagation, 2.28
- Caenorhabditis elegans*
- genomic resources for microarrays, A10.6
  - protein interaction mapping, 18.124
- Caging, 17.13
- Cairns, 1.6, 2.11, 3.2
- Calcium (Ca<sup>2+</sup> ions and exonuclease III), 13.73
- Calcium chloride (CaCl<sub>2</sub>), A1.25
- in  $\lambda$  stock preparation, 2.35, 2.37, 2.39
  - preparation and transformation of competent *E. coli* using, 1.116–1.118
  - in transfection of eukaryotic cells, 16.16, 16.19–16.20, 16.23
- Calcium-phosphate-mediated transfection, 16.3, 16.14–16.26, 16.52–16.53
- of adherent cells, 16.25
  - of cells growing in suspension, 16.26
  - chloroquine treatment, 16.14, 16.17, 16.52
  - cotransformation, 16.24
  - efficiency, factors affecting, 16.52
  - with genomic DNA, 16.21–16.24
  - glycerol shock, 16.14, 16.17, 16.52
  - high efficiency, 16.19
  - mutation prevalence, 16.53
  - with plasmid DNA, 16.14–16.20
  - sodium butyrate, 16.14, 16.17–16.18
- Calcium phosphate transfection
- Escort, 16.5
  - Kit, 16.5
  - System, 16.5
- Calcium tungstate intensifying screens, A9.11
- Calf intestinal alkaline phosphatase (CIP), 1.95–1.96, 2.69, 9.62–9.64, 9.92–9.93, A4.37. *See also* Alkaline phosphatase
- in cosmid library construction protocol, 4.17–4.21
  - dephosphorylation of M13 vector DNA, 12.24
  - inactivation of, 1.96, 9.64, 9.93
  - properties of, 9.93
  - RNA dephosphorylation, 9.65
- Call* *dam* methylation and, 13.87
- Calpain inhibitor I and II, A5.1
- CalPhos Mammalian Kit, 16.5
- cAMP, 3'-5', 2.7
- cAMP-dependent protein kinase, 18.49, 18.51
- cAMP response element-binding protein (CREB), 18.11
- Candida albicans*, genomic resources for microarrays, A10.6
- CAP, 15.57, 17.80, 18.127
- Capillary transfer of DNA from agarose gels to solid supports
- depurination/hydrolysis, 6.34–6.35
  - downward transfer, 6.35–6.36, 7.26, 7.40–7.41
  - northern hybridization, 7.25–7.26, 7.36, 7.38–7.41
  - protocols for, 6.39–6.49
  - transfer to two membranes, 6.35–6.36, 6.47–6.49
  - upward transfer, 6.34–6.35, 7.25–7.26, 7.36, 7.38–7.39
- Capped RNAs, 9.88
- Carbenicillin, 1.148
- modes of action, A2.7
  - stock/working solutions, A2.6
- Carbodiimide, 13.95
- Carbonic anhydrase II and affinity purification of fusion proteins, 15.6
- CARD. *See* Catalyzed reporter deposition protocol
- Carrier RNA, 5.20, 7.69
- Cassette mutagenesis, 13.79
- CAI. *See* Chloramphenicol acetyltransferase
- cat* gene, 1.144
- CAI reaction mixtures, 17.36, 17.40–17.41
- Catalyzed reporter deposition protocol, A9.19
- CATH database, A11.22
- Cathepsin B, 16.52–16.53
- ccdB* gene in positive selection vectors, 1.12
- CCD cameras, 5.15–5.16, 18.76, 18.91–18.92, 18.94
- CCM. *See* Chemical cleavage of mismatched bases
- CDI modification, 13.95
- cDNA. *See also* cDNA cloning; cDNA libraries; cDNA synthesis
- adaptor use, 1.160
  - blunt-end ligation of, 11.51–11.52
  - clone analysis by PCR, 2.105
  - differentially expressed, isolating, 9.89–9.91
  - differential screening, 9.89–9.90
  - plus/minus screening, 9.89–9.90
  - random sampling, 9.89
  - subtractive screening, 9.90–9.91
- E. coli* DNA ligase use, 1.159
- end modification of cloned, 8.42
  - expression library construction, 14.48–14.49
  - full-length clones, low-yield of, 8.60
  - length, measurement by alkaline agarose gel electrophoresis, 5.36
  - linker use with, 1.99–1.100
  - methylation of, 11.48–11.50
  - microarray analysis, A10.3–A10.6, A10.9–A10.10, A10.14
- PCR techniques
- amplification of 3' ends, 8.61–8.65
  - amplification of 5' ends, 8.54–8.60
  - characterization of cloned segments in prokaryotic vectors, 8.72–8.76
  - differential display-PCR, 8.96–8.106

- cDNA *continued*
- end modification, 8.42
  - long PCR, 8.77
  - mixed oligonucleotide-primed amplification, 8.66–8.71
  - RT-PCR, 8.46–8.53
  - in primer extension assays, 7.75–7.76
  - probe construction
    - subtracted
      - by random extension, 9.46–9.50
      - using oligo(dT) primers, 9.41–9.45
      - using oligo(dT) primers, 9.41–9.45
      - using random primers, 9.38–9.40
    - tailing reaction, 8.58–8.59
  - cDNA cloning. *See also* cDNA libraries, construction
    - fidelity of, 11.5
    - history of methods to synthesize and clone, 11.3–11.5
    - linkers and adaptors, 11.20–11.21
    - methylation, 11.21
    - mRNA preparation for
      - enrichment methods, 11.8–11.11
      - fractionation of cDNA, 11.9–11.10
      - fractionation of mRNA, 11.9
      - number of clones needed for library, 11.8
      - overview, 11.8–11.9
      - polysome purification, 11.10
      - subtractive cloning, 11.10–11.11
      - integrity of mRNA, 11.7–11.8, 11.39, 11.42
      - source of mRNA, 11.6–11.7
    - PCR error rate, 11.5
    - screening. *See* cDNA libraries, screening
    - strategies for, 11.5, 11.6
    - vectors, 11.21–11.26
      - $\lambda$ gt10/ $\lambda$ gt11, 11.25, 11.27
      - $\lambda$ ZAP, 11.22
      - $\lambda$ ZAP Express, 11.22–11.25
      - $\lambda$ ZAPII, 11.22–11.23
      - $\lambda$ ZipLox, 11.25–11.26
      - plasmids, 11.25
  - cDNA libraries, 11.1–11.124. *See also* Expression libraries, screening
    - amplification, 11.64–11.66
      - in  $\lambda$ gt10, 11.64–11.65
      - in  $\lambda$ gt11,  $\lambda$ ZAP,  $\lambda$ ZipLox, 11.65–11.66
    - arrayed libraries, 4.8
    - construction
      - cDNA synthesis, 11.11–11.20
        - first-strand, 11.11–11.14, 11.38–11.42
        - second-strand, 11.14–11.20, 11.43–11.47
      - enrichment methods, 11.8–11.11
      - eukaryotic expression, 11.68–11.73
        - controls, 11.70
        - factors influencing success, 11.69–11.70
        - host/vector systems, 11.69
        - options, 11.68
        - vector systems for, 11.72
      - fractionation of cDNA, 11.56–11.58
      - kits for, 11.107–11.108
      - ligation of cDNA into plasmid vector, 11.63
      - ligation of cDNA to  $\lambda$  arms, 11.59–11.61
      - linkers and adaptors, 11.20–11.21, 11.51–11.55
      - methylation of cDNA, 11.48–11.50
      - polishing cDNA termini, 11.43, 11.45, 11.54
      - from small numbers of cells, 11.112
      - subtractive cloning, 11.10–11.11
      - troubleshooting, 11.64
      - vectors for, 11.21–11.26
    - custom-made, 11.107
    - differential screening, 9.89–9.90
    - direct selection, 11.98–11.106
      - amplification, 11.104–11.105
      - biotin labeling, 11.102
      - blocking repetitive sequences, 11.103, 11.105–11.106
      - linked pool preparations, 11.102
      - materials for, 11.100–11.101
      - overview, 11.98–11.100
      - primary selection, 11.105
      - secondary selection, 11.105
      - streptavidin bead preparation, 11.103
      - troubleshooting, 11.106
    - eukaryotic expression, 11.68–11.78
      - exon trapping/amplification, 11.79–11.97
      - flow chart for construction and screening, 11.2
      - in  $\lambda$  vectors, 2.23
      - number of clones needed, calculating, 11.8
      - oligonucleotide probes for
        - degenerate pools, 10.5–10.6
        - length of, 10.4
      - screening, 11.26–11.34
        - by binding to specific ligands, 11.32–11.33
        - double-stranded DNA probes, 11.33
        - immunoglobulin probes, 11.32–11.33
      - direct selection of cDNAs, 11.35, 11.98–11.106
      - eukaryotic expression, 11.74–11.78
        - controls, 11.74–11.75
        - protocols, 11.76–11.78
        - screening pools, 11.74
      - exon trapping, 11.35
        - by expression, 11.33–11.34
        - by hybridization, 11.27–11.32
          - homologous probes, 11.27
          - similar sequence probes, 11.28–11.29
          - subtracted cDNA probes, 11.29–11.31
          - synthetic oligonucleotide probes, 11.31–11.32
        - total cDNA probes, 11.29
        - zoo blots, 11.28
      - by PCR, 11.32
        - for protein-protein interactions, 18.30–18.48
        - by subtracted cDNA probes, 9.46, 9.90–9.91
        - validation of clones selected, 11.34
      - validation of clones, 11.34
    - cDNA synthesis
      - in exon trapping/amplification protocol, 11.91–11.92
      - first-strand, 11.11–11.14, 11.38–11.42
        - methods, table of, 11.15
        - optimizing, 11.38, 11.42
        - primers for, 11.12, 11.15, 11.39
          - oligo(dT), 11.12–11.13, 11.15, 11.39
          - random primers, 11.12–11.15, 11.39
        - protocol, 11.38–11.41
        - reverse transcriptase choice, 11.11–11.12, 11.38
        - troubleshooting, 11.42
        - yield, calculating, 11.41–11.42
      - kits for, 11.71, 11.107–11.108
      - Klenow fragment use, A4.15
      - reverse transcriptase, A4.25–A4.26
      - second-strand, 11.14–11.20, 11.43–11.47
        - oligonucleotide-primed, 11.17–11.20
        - optimizing, 11.46
        - protocol, 11.43–11.47
        - replacement synthesis, 11.16–11.17
        - self-primed, 11.14, 11.46
        - troubleshooting, 11.46
        - yield, calculating, 11.45
    - CDP-Star, 9.79, A9.44
    - CE6, bacteriophage, 15.20
    - Cell fixative, 16.13
    - Cell homogenization buffer, 17.4
    - Cell lysis buffer, 15.35, 15.41, 15.50
      - for reporter assays, 17.44–17.45
    - Cell numbers, estimation of
      - hemocytometer counting, A8.6–A8.7
      - viability staining, A8.7–A8.8
    - Cell resuspension buffer, 17.6
    - Cell walls
      - digestion of yeast, 4.60, 5.66–5.67
      - inhibition of restriction enzymes by components of, 1.33, 1.36, 1.42, 3.24
    - Cell wash buffer, 5.65
    - CellFECTIN, 16.5, 16.11
    - CellPhect Transfection Kit, 16.5
    - Cellulose. *See also* DEAE-cellulose
      - affinity purification of fusion proteins, 15.6
      - oligo(dT), 7.14
    - CEN4 (centromeric sequence), 4.60
    - Centricon concentrator, 8.27–8.29, 8.58, 8.68, 12.106, 18.81–18.82
    - Centrifugation
      - nomogram for conversion of rotor speed to relative centrifugal force, A8.39
      - rotors, table of commonly used, A8.39
    - CEPH Mega YAC Library, 4.9
    - cer region, 1.146
    - Cerenkov counting, 9.69, 9.71, 9.75, 10.27, 11.58, 12.66, A8.25
    - CES200 *E. coli* strain genotype, A3.6
    - CES201 *E. coli* strain genotype, A3.6
    - Cesium chloride (CsCl)
      - removal from bacteriophage suspensions, 2.57–2.58
      - removal from DNA, 1.73–1.75
    - Cesium chloride (CsCl) density gradients
      - bacteriophage purification, 1.155
      - DNA form and density, 1.18
      - double-stranded DNAs, 1.154
      - ethidium bromide, 1.151
      - $\lambda$  particle purification, 2.47–2.51
        - collection of particles, 2.50
        - equilibrium gradient, 2.49, 2.51
        - step gradient, 2.48–2.49
      - properties of CsCl solutions, 1.155–1.156
      - purification of closed circular DNA
        - contamination by DNA/RNA fragments, 1.65
        - continuous gradients, 1.67–1.68
        - discontinuous gradients, 1.69–1.71
        - DNA collection from, 1.67–1.68, 1.71
        - rebanding, 1.68
        - RNA, 1.155, 7.4
        - single-stranded DNAs, 1.155
    - Cetyltrimethylammonium bromide (CTAB), 6.61–6.62
      - DNA precipitation by, 6.62
      - in hybridization solutions, 6.61–6.62
      - polysaccharide removal, 2.105
      - for solubilization of inclusion bodies, 15.54
      - structure of, 6.62
    - Cetylpyridinium bromide (CPB), 10.22–10.24
    - CFLP PowerScan mutation detection system, 13.89
    - Cfr61 methylase, A4.7
    - Cfr91, A4.7
    - Chameleon Double-stranded Site-directed Mutagenesis Kit, 13.27, 13.89
    - Chaotropic agents, 15.60. *See also specific agents*
      - DNA binding to silica, 1.63
      - for solubilization of proteins from pellets, 15.11
    - Chaperones, 1.4
    - Charged couple device (CCD)-based image detection systems, 5.15–5.16, 18.76, 18.91–18.92, 18.94
    - Charon vectors, 2.12, 2.22, A3.3
    - CHEF. *See* Contour-clamped homogeneous electric field
    - Chemical cleavage of mismatched bases (CCM), 13.91, 13.95
    - Chemical mutagenesis, 13.78–13.79
    - Chemiluminescence, A8.55, A9.16–A9.20
      - alkaline phosphatase and, A9.40
      - AMPPD and, A9.42–A9.44
      - applications, table of, A9.18
      - assays for immunoassay and nucleic acid hybridization labels, table of, A9.17

- digoxigenin-labeled probes, A9.39–A9.40
- enzyme assays, A9.19–A9.20
- alkaline phosphatase, A9.19
- $\beta$ -galactosidase, A9.19
- glucose oxidase, A9.20
- horseradish peroxidase, A9.19
- xanthine oxidase, A9.19
- horseradish peroxidase and, A9.35–A9.37
- labels, A9.17–A9.19
- luminometers, A9.20
- markers, 1.140, 2.98–2.99
- overview, A9.16–A9.17
- reactions, A9.16
- screening of expression libraries
- in  $\lambda$  vectors, 14.11–14.12
- in plasmid vectors, 14.21–14.22
- Chi ( $\chi$ ) site
- E. coli*, 2.13
- $\lambda$ , 2.13, 2.22
- ChIP (Chromatin immunoprecipitation), A10.18
- Chloramine T (N-chlorobenzenesulfonamide), 14.5, 14.16, A9.30
- Chloramphenicol. *See also* Chloramphenicol acetyltransferase
- dam* strains and, 13.88
- mechanism of resistance to, 1.144
- modes of action, A2.7
- plasmid copy number amplification, 1.4, 1.39, 1.48, 1.56, 1.128, 1.131, 1.143
- properties and mode of action, 1.143–1.144
- for protein expression optimization, 15.19
- relaxed plasmid replication, 1.4
- resistance, 17.94
- stock/working solutions, A2.6
- structure of, 1.143
- Chloramphenicol acetyltransferase (CAT), 17.94–17.95
- affinity purification of fusion proteins, 15.6
- expression in mammalian cells, 17.95
- reaction catalyzed by, 17.94
- as reporter gene, 17.30–17.41, 17.95
- aberrant transcription, 17.34
- controls, 17.34
- measurement
- by diffusion of reaction products into scintillation fluid, 17.41
- by extraction with organic solvents, 17.40
- by thin-layer chromatography, 17.36–17.39
- normalizing CAT activity to  $\beta$ -galactosidase activity, 17.48–17.49, 17.51
- overview, 17.33–17.34
- pCAT3 vectors, 17.35
- quantitative assays, 17.95
- as transfection-positive control, 16.4
- Chloramphenicol resistance gene ( $\text{Cm}^R$ )
- in activation domain fusion plasmids, 18.20
- in LexA fusion plasmids, 18.19
- in two-hybrid system of reporter plasmids, 18.12
- Chloroform, 1.34. *See also* Phenol:chloroform extraction
- extraction
- in hydroxyl radical footprinting protocol, 17.12
- mineral oil removal from PCRs, 8.22
- in oligonucleotide purification, 10.27
- in transcriptional run-on assay protocol, 17.28
- for  $\lambda$  cDNA storage, 11.64
- for  $\lambda$  plaques storage, 2.32–2.33, 2.36
- overlay assay of  $\beta$ -galactosidase activity, 18.28
- 4-Chloro-1-naphthol, 14.10, 14.20–14.21
- Chlorophenol red  $\beta$ -D-galactopyranoside, 17.50
- Chloroquine, 16.14–16.15, 16.17, 16.52–16.53, 17.60, 17.62
- DEAE transfection, facilitation of, 16.28, 16.31
- Chlortetracycline, 1.147, 17.52
- Chromatin immunoprecipitation (ChIP), A10.18
- Chromatography. *See also* Affinity chromatography; *specific resins*
- anion-exchange chromatography, DNA purification protocol, 5.26–5.28
- cDNA size fractionation through Sepharose CL-4B, 11.55–11.58
- ethidium bromide removal from DNA, 1.75–1.77, 1.151
- FPLC, 13.20
- gel-filtration, A8.29–A8.31
- column chromatography, A8.29–A8.30
- spun-column, A8.30–A8.31
- HPLC, 10.49, A8.35
- hydroxyapatite, 7.65, 9.90–9.91, 11.1, A8.32–A8.34
- in IgG radioiodination protocol, 14.5, 14.16
- immunoaffinity, 11.10
- liquid chromatography-tandem MS (LC-MS/MS), 18.66
- mRNA separation by
- batch, 7.18–7.19
- oligo(dT)-cellulose, 7.13–7.17
- poly(U)-Sepharose, 7.15, 7.20
- oligonucleotide purification, 10.49
- Sep-Pak  $\text{C}_{18}$  columns, 10.11, 10.13, 10.15–10.16, 10.28–10.29
- plasmid DNA purification, 1.19
- overview of, 1.62–1.64
- through Sephacryl S-1000, 1.80–1.81
- resins, table of commercially available, 1.64
- thin-layer chromatography for CAT measurement, 17.36–17.39
- Chromogenic screening of expression libraries
- in  $\lambda$  vectors, 14.9–14.11
- in plasmid vectors, 14.20–14.21
- Chromosomal DNA. *See also* Genomic DNA
- denaturation in boiling lysis plasmid DNA protocols, 1.43
- migration in agarose gel electrophoresis, 5.5
- pulsed-field gel electrophoresis separation of, 5.3, 5.56, 5.59–5.60
- Chromosome walking
- inverse PCR use, 8.81
- overview, 4.8–4.10
- Church buffer, 4.26, A1.12
- in northern hybridization, 7.45
- in Southern hybridization, 6.56
- Chymostatin, A5.1
- Chymotrypsin, 18.64
- cl gene
- $\lambda$ , 2.3, 2.6, 2.8, 2.11, 2.17–2.18, 2.21, 2.23, 11.111.
- See also*  $\lambda$ , repressor
- PI, 4.37
- in pEX vectors, 14.14
- thermosensitive mutants, 14.37
- Cl protein,  $\lambda$ , 2.8, 2.10, 2.14, 2.17–2.18
- clI gene,  $\lambda$ , 2.6, 2.11, 2.17
- clII protein,  $\lambda$ , 2.7–2.8, 2.11
- clIII gene,  $\lambda$ , 2.6, 2.11, 2.17
- clIII protein,  $\lambda$ , 2.7, 2.11
- CIP. *See* Calf intestinal alkaline phosphatase
- Circular mutagenesis, 13.19–13.25
- materials, 13.21–13.22
- polymerase choice, 13.20–13.21
- primer design, 13.19–13.20
- protocol, 13.22–13.25
- CIT Human BAC Library, 4.9
- Citric acid, A1.6
- cIs857* mutation, 2.23
- CJ236 *E. coli* strain, 13.12–13.13, A3.6
- C-la *E. coli* strain genotype, A3.6
- Clal, methylation, A4.3, A4.7
- ClearCut Miniprep Kit, 1.64
- CLONEAMP pAMP, 11.105
- CLONfectin reagent, 16.5, 16.11
- Cloning. *See also* cDNA cloning
- by addition of linkers to blunt-ended target DNA, 1.98
- in Cosmids
- diagram of steps, 4.12
- double *cos* site vectors, 4.11–4.14
- ligation reactions, 4.15, 4.21–4.22
- partial filling of 3' termini, 4.15
- single *cos* site vectors, 4.11, 4.13
- expression cloning
- cDNA library construction, 11.68–11.73
- controls for, 11.70
- factors influencing success, 11.69–11.70
- mammalian host-vector systems, 11.69
- screening cDNA library, 11.74–11.78
- vector systems for, 11.72
- in M13 vectors
- locations
- gene X, 3.9–3.10
- large intergenic region, 3.9
- multiple cloning sites, table of, 3.14
- small intergenic region, 3.9
- materials, 3.35–3.36
- methods
- dephosphorylation of vector DNA, 3.34
- forced (directional cloning), 3.34
- ligation of insert into linearized vector, 3.34
- protocol, 3.36–3.38
- transformation reactions, 3.37–3.38
- PCR products
- blunt end, 8.30–8.34
- difficulty of, 8.30
- end modification, 8.42–8.45
- genetic engineering with PCR, 8.42–8.45
- overview, 8.30–8.31
- polishing termini, 8.30, 8.32–8.34
- restriction site addition and, 8.31, 8.37–8.41
- clamp sequences and, 8.38–8.39
- diagram of procedure, 8.38
- primer design tips, 8.37–8.38
- problems, 8.37
- protocol, 8.39–8.41
- troubleshooting, 8.41
- into T vectors, 8.31, 8.35–8.36
- in plasmid vectors
- blunt-ended cloning, 1.22–1.24, 1.90–1.92
- directional cloning, 1.21–1.22, 1.84–1.87
- fragments with protruding ends, 1.20–1.21
- overview, 1.19–1.20
- Closed circular DNA purification in CsCl gradients, 1.18
- continuous, 1.65–1.68
- discontinuous, 1.69–1.71
- Clostripain, 15.8
- clp*, 15.58
- CLUSTALW program, A11.6
- Cluster analysis program, A10.15
- CM selective medium, 18.18, 18.31, 18.40
- CMV promoter. *See* Cytomegalovirus promoter
- c-Myc protein, human, epitope tagging of, 17.92
- Code20 kit, 13.89
- Codon usage
- changing codons by PCR, 8.44
- database, A11.20
- degenerate primer pools and, 8.67
- evolution and, A7.2
- genetic code table, A7.4
- guesstimer design and, 10.7
- in humans, table of, A7.3
- optimization of expression and, 15.12
- Coenzyme R. *See* Biotin
- Cohesive termini. *See* Protruding termini
- Coimmunoprecipitation, 18.4, 18.60–18.68
- cell lysis, 18.62, 18.65
- controls, 18.63–18.66

- Coimmunoprecipitation (*continued*)  
   identification of proteins, 18.66  
   immunoprecipitation of cell lysate, 18.62–18.63  
   materials for, 18.67–18.68  
   method, 18.68  
   nonspecific interactions, reducing, 18.65–18.66  
   procedure, outline of, 18.61–18.62
- Coincidence circuit, scintillation counter, 17.46, A9.22
- colE1 replicon, 1.3–1.4  
   chloramphenicol amplification, 1.143  
   in cosmids, 4.5  
   DNA synthesis at, 1.5–1.7  
   *E. coli* strain and copy number, 1.15  
   *poB* gene and copy number suppression, 1.13  
   in pET vectors, 15.3  
   plasmid growth and replication, table of, 1.17
- Colicin B protein, epitope tagging of, 17.92
- Colicin E1 replicon. *See* colE1 replicon
- Colicin E3 in positive selection vectors, 1.12
- Collagenase, 15.8, 18.116
- Colloidal bags, 6.14–6.15
- Column-loading buffer for oligo(dT)-cellulose chromatography, 7.14–7.16
- Compactin, 11.6
- Competent cell preparation  
   chemical methods, 1.24–1.25  
   electrocompetent, 1.25–1.26, 1.119–1.121  
   frozen stocks, 1.109, 1.114–1.115  
   Hanahan method, 1.103–1.110  
   house method, 1.112–1.115  
   using calcium chloride, 1.116–1.118
- Competition assays, 17.17
- Competitive oligonucleotide priming (COP), 13.91, 13.96
- Complementation. *See*  $\alpha$ -complementation
- Complete minimal (CM) recipe, A2.9
- Compressions in DNA sequencing gels, 12.109–12.110
- Concentrating nucleic acids, A8.12–A8.18  
   butanol, extraction with, A8.18  
   by dialysis on bed of sucrose, 6.15  
   ethanol precipitation, A8.12–A8.16  
   aspiration of supernatants, A8.15  
   carriers, A8.13  
   dissolving precipitates, A8.13, A8.15–A8.16  
   history of, A8.14  
   protocol for, A8.14–A8.15  
   of RNA, A8.16  
   salt solutions used with, A8.12  
   high-molecular-weight DNA samples, 6.15  
   lithium chloride precipitation of large RNAs, A8.16  
   microconcentrators, A8.16–A8.17
- Condensing reagents, 1.24, 1.152
- Conditional mutations, A7.5
- Conditionally lethal genes, 1.12
- Conjugated antibodies, A9.33–A9.34
- Conjugation, *uidD36* mutation, 3.10
- Consensus program, A11.14
- Constant denaturant gel electrophoresis (CDGE), 13.92
- Contact printing arrayer, A10.7
- Contour-clamped homogeneous electric field (CHEF), 5.57, 5.79–5.82  
   conditions for, 5.79–5.80  
   electrode configuration, 5.57  
   high-capacity vector insert size determination, 4.18  
   method, 5.81–5.82  
   pulse times, 5.79–5.80  
   resolution, 5.79
- Coomassie Brilliant Blue staining solution, A1.26, A8.46–A8.47
- Copy number  
   BAC, 4.48  
   cosmids, 4.26  
   PI and PAC vectors, 4.41  
   plasmid, 1.39, 1.48, 1.56, 1.128, 1.131  
   amplification, 1.4, 1.143  
   chloramphenicol and, 1.4, 1.143  
   control by RNAI, 1.6–1.7  
   *E. coli* strains, related suppression of, 1.15  
   incompatibility of plasmids and, 1.7–1.8  
   low-copy-number vectors, 1.12–1.13  
   needs for low, 1.3  
   plasmid size and, 1.9  
   replicons and, 1.3–1.4  
   suppression by *penB*, 1.13
- Cordycepin, 9.55, 9.60–9.61, 12.73
- CorePromoter program, A11.12
- COS cells, 11.68, 11.75  
   COS-1, 11.114  
   COS-7 cells, 11.114  
   electroporation into, 11.85–11.86  
   mRNA harvesting from, 11.87–11.88  
   overview, 11.114  
   transfection, 16.27, 16.29, 16.32
- cos* sites  
   in BAC vectors, 4.3  
   cosmids, 4.11, 4.30, 4.33  
    $\lambda$ , 2.2–2.3, 2.12, 2.14–2.15, 2.68  
   in vitro packaging and, 2.111, 11.113
- Cosmids, 4.11–4.34, A3.5  
   chimeric clones, reducing, 4.15–4.16  
   choosing for genomic library construction, 4.7–4.10  
   cloning in  
   diagram of steps, 4.12  
   double *cos* site vectors, 4.11–4.14  
   ligation reactions, 4.15, 4.21–4.22  
   partial filling of 3' termini, 4.15  
   single *cos* site vectors, 4.11, 4.13  
   copy number, 4.26  
   DNA purification, 4.22–4.23  
   genomic libraries  
   amplification  
   on filters, 4.31–4.32  
   in liquid culture, 4.28–4.30  
   on plates, 4.34  
   by rescuing DNA in transducing particles, 4.30  
   arm isolation, 4.19–4.20  
   arrayed libraries, 4.31  
   dephosphorylation of genomic DNA, 4.20–4.21  
   digestion of genomic DNA, 4.20  
   isolation and analysis, 4.22  
   ligation, 4.21–4.22  
   linearization/dephosphorylation, vector, 4.18–4.19  
   protocol for construction, 4.17–4.23  
   restriction map construction, 4.33  
   screening unamplified by hybridization, 4.24–4.27  
   storage, 4.11, 4.30, 4.32  
   overview, 4.4–4.5  
   packaging, 4.21–4.22, 4.30  
   restriction mapping recombinants, 4.33  
   size, 4.11  
   stability of cloned sequences, 4.10, 4.28  
   subcloning YAC DNAs into, 4.64  
   transforming *E. coli*, 4.25  
   in vitro transcription from bacteriophage promoters, 9.31
- Cotransformation, 16.24, 16.47
- Cotton bollworm virus, 17.81
- Coulter Multimek (Beckman), A10.5
- CPD-Star, A9.44
- CpG sequences, 5.60, 5.68–5.69
- Cre, 4.4, 4.82–4.85. *See also* Cre-*loxP* recombination system
- CREB. *See* cAMP response element-binding protein
- Cre-*loxP* recombination system, 4.82–4.85  
   mechanism of action, 4.82–4.83  
   site-specific integration and excision of transgenes, 4.84–4.85  
   use in mammalian cells, 4.84–4.85  
   vectors containing Cre-*loxP* sites, 4.83–4.84  
    $\lambda$ ZipLox vector, 11.25–11.26  
   PI vectors, 4.4
- Cresol red, 1.53, A1.19
- cro* genes,  $\lambda$ , 2.6, 2.8–2.9, 14.14
- Cro protein, 2.6, 2.8, 2.10, 2.14, 2.18
- Cross-linking devices, 6.41, 6.46
- Crowding agents, 1.23–1.24, 1.152, 1.157–1.158, 3.49, 6.58
- crp* gene, 15.3
- CsCl. *See* Cesium chloride
- CSH18 *E. coli* strain  
   genotype, A3.6  
    $\lambda$  vector propagation, 2.29
- CSPD, A9.43–A9.44
- CspI* methylation, A4.7
- CTAB. *See* Cetyltrimethylammonium bromide
- CTAC for solubilization of inclusion bodies, 15.54
- Cul2, 18.60, 18.62, 18.64
- Cup horn sonicator, 12.16, A8.36
- CV-1 cell lines, 16.27
- CviBIII* methylase, A4.7
- CviI* restriction enzyme, 9.15, 12.11
- CviQI*, A4.9
- Cy3 dye, 18.69, 18.71–18.72, 18.78, 18.80, 18.82–18.83, 18.91, 18.93–18.95
- Cy5 dye, 18.80, 18.91
- cya*, *E. coli* gene, 2.7
- Cyalume Lightsticks, A9.17
- Cyanogen bromide, 15.6, 15.8, A9.26–A9.27
- Cycle DNA sequencing  
   advantages of, 12.51–12.52  
   with end-labeled primers, 12.51–12.55  
   with internal labeling, 12.60  
   reaction mixtures for, 12.53, 12.60  
   troubleshooting, 12.55
- Cycle-sequencing buffer, 12.53
- Cyclic coiled DNA  
   alkaline lysis plasmid DNA procedure, 1.40, 1.45, 1.49  
   boiling lysis plasmid DNA protocols, 1.45, 1.49
- Cyclophilin, normalizing RNA samples against, 7.22
- Cysteine  
   for affinity purification of fusion proteins, 15.6  
   codon usage, A7.3  
   nomenclature, A7.7  
   properties, table of, A7.8  
   in pulse-chase experiments, 15.18–15.19
- Cysteine-scanning mutagenesis, 13.3
- Cytochrome *c* for protein stability, 17.16
- CytoFectene Reagent, 16.5
- Cytomegalovirus (CMV) promoter, 11.68  
   for eukaryotic expression vectors, 11.72  
   in pTet-rTak, 17.57–17.58
- Cytosine, A6.7  
   bisulfite modification of, 13.78  
   codon usage and, A7.2  
   hydrazine cleavage of, 13.78  
   hydroxylamine modification of, 13.78, 13.95  
   methylation of, A4.3–A4.4  
   nitrous oxide modification of, 13.78  
   related compounds (Table A6-6), A6.7  
   structure, A6.7
- DabcyI, 8.95
- dam* methylase, 1.25, 13.87–13.88, A4.3, A4.7
- Database of transcribed sequences (DOTS), A10.15
- Database Similarity Search Software (Table A11-2), A11.18–A11.19
- Databases. *See also individual listings*  
   searching, 1.14  
   table of bioinformatics, A11.22–A11.24

- dbEST databank, A10.3
- DC-Cholesterol, 16.8, 16.11
- dom* methylase, 1.25, 12.113, A4.3–A4.4
- DDAB, 16.11
- DDBJ database, A11.20
- Dde*I
- 7-deaza-dGTP modified DNA, cleavage of, 8.60
  - in end-labeling, selective, 9.52
- ddNTPs. *See* Dideoxynucleoside triphosphates
- DD-PCR. *See* Differential display-PCR
- DD-PCR reverse transcriptase buffer, 8.101
- DE3 *E. coli* strain
- genotype, A3.6
- DE52, 2.102–2.104, 2.107–2.108. *See also* DEAE-cellulose
- DE-81 filters, A8.26
- DEAE, 1.19
- high-salt elution buffer, 5.19
  - low-salt elution buffer, 5.20
- DEAE-cellulose
- for DNA purification, 5.26–5.28
  - DNA recovery from agarose gels, 5.18–5.22
  - in  $\lambda$  DNA purification from plate lysates, 2.102
- DEAE Dextran Kit, 16.5
- DEAE-dextran-mediated transfection, 16.3, 16.27–16.32
- calcium phosphate method compared, 16.27
  - cell viability, increasing, 16.32
  - facilitators of, 16.28
  - kits, 16.30
  - materials for, 16.29–16.30
  - mechanism of action, 16.27
  - method, 16.30–16.31
  - mutation prevalence, 16.28, 16.53
  - variables, 16.27–16.28
- DEAE-Sepharcel, 5.26–5.28, A8.31
- deArray image analysis program, A10.13
- 7-Deaza-dGTP, 8.60, 12.52, 12.55, 12.58, 12.96
- in automated DNA sequencing protocols, 12.95
  - in DNA sequencing protocols, 12.109–12.110
  - overview of, 12.111
  - Sequenase, use of, 12.105
  - structure of, 12.111
- DeepVent* DNA polymerase, 8.11, 8.85, A4.23
- Degenerate oligonucleotides, pools of, 10.5–10.6, 11.31
- degP* mutation, 15.19
- Deletion mutants
- BAL 31 generation of bidirectional sets, 13.62–13.67
  - exonuclease III generation of nested sets, 13.57–13.61, 13.74–13.75
- Denaturation
- DNA
- for DNA sequencing protocols, 12.26–12.30
  - by formamide, 6.59–6.60
  - in PCRs, 8.8
  - probes, 7.43
  - RNA, 7.21–7.22
  - for dot and slot blotting, 7.46, 7.48–7.49
  - formaldehyde, 7.31–7.33
  - glyoxal, 7.27–7.29
  - by heat, 8.51
- Denaturation solution, 10.38
- in guanidinium lysis, 7.5
  - for neutral transfer, double-stranded DNA targets only, A1.12
  - in Southern hybridization, 6.41, 6.43, 6.47
- Denaturing buffer
- CHEF gel, 5.80
  - TAFE gel, 5.75
- Denaturing gradient gel electrophoresis (DGGE), 13.91–13.92
- mutation detection, 13.49
  - SYBR Gold stain as alternative to, 5.15
- Denhardt's solution
- BLOTTO and, 1.139
  - in hybridization solutions, 6.51–6.52, 10.35, 10.38
  - recipe, A1.15
  - in stripping solutions, 6.57
- Densitometric scanning, 7.47
- deo'* gene, 3.16
- Deoxycholate, 15.10, 15.50
- 2'-deoxycoformycin (dCF), 16.47
- Deoxynucleoside triphosphates (dNTPs), A1.26
- in PCRs, 8.5
  - radiolabeled, 9.5. *See also* Radiolabeled probes
  - removal by ultrafiltration, 8.27–8.29
  - stock solution preparation, 12.107, A1.26
  - storage of, 8.5
- Deoxyribonuclease I (DNase I), A4.40–A4.42
- cleavage preferences, A4.41–A4.42
  - ethidium bromide and, A4.41
  - limiting activity of, A4.41
  - RNase free, preparation of, A4.42
  - uses, list of, A4.41
- DEPC. *See* Diethylpyrocarbonate
- Dephosphorylation, 9.92
- in cosmid vector cloning, 4.15, 4.19, 4.20–4.21
  - of DNA fragments with alkaline phosphatase, 9.62–9.65
  - efficiency, analysis of reaction, 4.19
  - efficiency, monitoring, 2.70
  - of  $\lambda$  vector DNA, 2.68–2.70
  - of M13 vector DNA, 3.34, 3.36, 12.24
  - of plasmid DNA, 1.93–1.97
  - conditions for, 1.95
  - diagram of, 1.94
  - method, 1.95–1.97
  - when to use, 1.93–1.94
  - of RNA, 9.65
- Dephosphorylation buffer, 2.69
- for use with CIP, A1.10
  - for use with SAP, A1.10
- Depurination of DNA
- during DNA transfer from agarose gel to filter, 6.34
  - by piperidine, 12.61
  - in Southern hybridization, 6.41, 6.43, 6.47
- Detection systems, A9.1–A9.49. *See also specific chemicals; specific methods*
- AMPPD, A9.42–A9.44
  - antibodies, A9.25–A9.34
  - antipeptide, A9.30–A9.33
  - applications, A9.25
  - conjugated, A9.33–A9.34
  - biotinylated, A9.33
  - enzyme, A9.34
  - fluorochrome, A9.33
  - immunological assays, A9.27–A9.30
  - immunoprecipitation, A9.29
  - solid-phase RIA, A9.29–A9.30
  - western blotting, A9.28
  - purification of, A9.25–A9.27
  - radiolabeling, A9.30
  - autoradiography, A9.9–A9.15
  - fluorography, A9.12
  - imaging, A9.9–A9.10
  - intensifying screen, A9.11
  - isotopes used
    - decay data, A9.15
    - particle spectra, A9.9–A9.10
    - sensitivity of detection, A9.13  - phosphorimaging, A9.11–A9.14
  - phosphorimaging devices, A9.14
  - preflashing, A9.11–A9.12
  - setting up autoradiographs, A9.13–A9.14
- BCIP, A9.41–A9.42
- bioluminescence, A9.21–A9.24
- bacterial luciferase, A9.23–A9.24
- firefly luciferase, A9.21–A9.23
- assays for, A9.22–A9.23
- properties of, A9.21–A9.22
- as reporter molecule, A9.23
- GFP, A9.24
- biotin, A9.45. *See also* Biotin
- chemiluminescence, A8.55, A9.16–A9.20
- alkaline phosphatase, A8.55
  - AMPPD and, A9.42–A9.44
  - applications, table of, A9.18
  - assays for immunoassay and nucleic acid hybridization labels, table of, A9.17
  - digoxigenin and, A9.39–A9.40
  - enzyme assays, A9.19–A9.20
    - alkaline phosphatase, A9.19
    - $\beta$ -galactosidase, A9.19
    - glucose oxidase, A9.20
    - horseradish peroxidase, A9.19
    - xanthine oxidase, A9.19  - horseradish peroxidase, A8.55
  - horseradish peroxidase/luminol, A9.35–A9.37
  - labels, A9.17–A9.19
  - luminometers, A9.20
  - overview, A9.16–A9.17
  - reactions, A9.16
- chromogenic, A8.55
- alkaline phosphatase, A8.55
  - horseradish peroxidase, A8.55
  - digoxigenin, A9.39–A9.40
  - horseradish peroxidase, A9.35–A9.37
- immunoglobulin binding proteins
- protein A, A9.46–A9.48
  - protein G, A9.46–A9.48
  - protein L, A9.46, A9.47, A9.49
- staining nucleic acids, A9.3–A9.8
- ethidium bromide, A9.3–A9.4
- methylene blue, A9.4–A9.5
- silver staining, A9.5–A9.7
- SYBR dyes, A9.7–A9.8
- Dexamethasone, 18.11
- Dextran sulfate
- as crowding agent, 6.58
  - in hybridization solutions, 6.58
  - in northern hybridization, 7.45
  - in Southern hybridization, 6.56
- DGGE. *See* Denaturing gradient gel electrophoresis
- DH1 *E. coli* strain, 1.14–1.15, 1.25, 1.115
- genotype, A3.6
  - transformation by Hanahan method, 1.106
- DH5 *E. coli* strain, 1.25
- genotype, A3.6
  - transformation by Hanahan method, 1.106
- DH5 $\alpha$  *E. coli* strain, 1.115
- genotype, A3.7
  - for interaction trap library screening, 18.38, 18.43–18.44
  - transformation by Hanahan method, 1.106
- DH5 $\alpha$ F' *E. coli* strain for M13 growth, 12.21, 12.23
- DH5 $\alpha$ MCR *E. coli* strain
- for cosmid stability, 4.28
  - genotype, A3.7
- DH10B *E. coli* strain
- for BAC propagation, 4.49
  - genotype, A3.7
- DH10B(ZIP) *E. coli* strain, 11.25
- DH11S *E. coli* strain
- genotype, A3.7
  - M13 vectors and, 3.13, 3.16
  - phagemids and, 3.42, 3.44, 3.46–3.47
- DH12S(ZIP) *E. coli* strain, 11.25
- DIALIGN program, A11.8
- Dialysis
- buffers, 2.56–2.57, 6.4, 6.13
  - to concentrate DNA, 6.15
  - drop dialysis, 4.44, A8.11
  - electroelution into dialysis bags, 5.23–5.25
  - to purify DNA, 6.15
  - on sucrose bed, 6.15
  - tubing, preparation of, A8.4

- 3,3'-Diaminobenzidine (DAB), A9.35  
 Dichlorodimethylsilane, 12.75, 12.112, A8.3  
 3,4-Dichloroisocoumarin, A5.1  
 Dichlororhodamine dyes, 12.96–12.97  
 Dideoxy fingerprinting (ddf), 13.49, 13.91, 13.94  
 Dideoxynucleoside triphosphates (ddNTPs), 12.4–12.5. *See also* DNA sequencing  
   DideoxyATP, 9.55, 9.60–9.61  
   incorporation rate by thermostable DNA polymerases, 12.45  
   stock solutions of, preparing, 12.107  
   terminator dye linkage to, 12.96  
 Diethylpyrocarbonate (DEPC), 7.84  
   glassware/plasticware treatment with, 7.82, 7.84  
   as probe of secondary structure of DNA and RNA, 7.84  
   problems using, 7.84  
   for RNase inactivation, 7.82–7.84  
   storage, 7.84  
   structure of, 7.84  
   treated water, 7.81  
 Differential display-PCR, 8.96–8.106  
 Differential screening, 9.89–9.90  
 Differentially expressed genes, isolating, 9.89–9.91  
   plus/minus screening, 9.89–9.90  
   random sampling, 9.89  
   subtractive screening, 9.90–9.91  
 Difromazan, 9.78  
 Digital Optical Chemistry (DOC) system, A10.17  
*Digitalis purpurea*, 9.77  
 Digoxigenin, 9.5, A9.36  
   labeled RNA probes, 9.35  
   labeling nucleic acids with, A9.38–A9.39  
   overview, A9.38  
   specific antibodies coupled to reporter enzymes, A9.40  
 Dihydrofolate reductase (*dhfr*) gene, 16.47, 16.49  
 Dimethylformamide, 14.9–14.10, 14.20, 18.80, 18.82, A9.42  
 Dimethylsulfate, 12.5, 12.61–12.65, 12.67  
 Dimethylsulfoxide (DMSO), A1.26  
   in column-loading buffers, 7.16  
   DEAF transfection, facilitation of, 16.28  
   in DNA sequencing reactions, 12.38, 12.109  
   for  $\lambda$  cDNA storage, 11.64  
   for  $\lambda$  storage, long-term, 2.36  
   in PCRs, 8.9, 8.23  
   in transfection with polybrene, 16.43–16.45  
   in transformation buffers, 1.105–1.106  
 Dinitrophenol, 9.76  
 Dioleoylphosphatidylethanolamine (DOPE), 16.5, 16.7–16.8, 16.50  
 Direct selection of cDNAs, 11.98–11.106  
   amplification, 11.104–11.105  
   biotin labeling, 11.102  
   blocking repetitive sequences, 11.103, 11.105–11.106  
   linked pool preparations, 11.102  
   materials for, 11.100–11.101  
   overview, 11.98–11.100  
   primary selection, 11.105  
   secondary selection, 11.105  
   streptavidin bead preparation, 11.103  
   troubleshooting, 11.106  
 Directional cloning, 1.21–1.22, 1.84–1.87  
   in M13 vectors, 3.34  
   priming cDNAs with an oligo(dT) adaptor, 11.13  
 Discover:ARRAY Gene Display, A10.9  
 Display Phage System, 18.120  
 Dithiothreitol (DTT)  
   in binding buffer, 14.33  
   in *in vitro* transcription reactions, 7.71  
   in primer extension assay protocol, 7.79  
   in random priming buffer, 9.6  
   in transformation buffers, 1.105–1.106  
 dFTR. *See* Inosine  
 D-luciferin-O-phosphate, A9.42  
 DMRIE, 16.11  
 DMRIE-C, 16.11  
 DMS buffer, 12.63  
 DMS stop solution, 12.63  
 DMSO. *See* Dimethylsulfoxide  
 DNA. *See also* cDNA; Chromosomal DNA; Double-stranded DNA; Genomic DNA; Mammalian cells, DNA isolation; Plasmid DNA; Single-stranded DNA  
   concentrating. *See* Concentrating nucleic acids concentration measurement  
   by fluorometry, 6.12  
   high-molecular-weight DNA, 6.11, 6.15  
   phenol contamination and, 6.11, 6.15  
   by spectrophotometry, 6.11, 6.15  
   denaturation. *See* Denaturation, DNA detection  
   in agarose gels  
     ethidium bromide staining, 5.14–5.15  
     photography, 5.16–5.17  
     SYBR Gold staining, 5.15–5.16  
   in polyacrylamide gels  
     by autoradiography, 5.49–5.50  
     photography, 5.48  
     by staining, 5.47–5.48  
   drying DNA pellets, 1.34, 1.37, 1.41  
   electrophoresis of. *See* Agarose gel electrophoresis; Polyacrylamide gel electrophoresis  
   ethidium bromide interaction with. *See* Ethidium bromide  
   fingerprinting and mapping YAC genomic inserts, 4.63  
   footprinting DNA, 17.75–17.78, A4.41  
   fragmentation. *See* Fragmentation of DNA; Hydrodynamic shearing  
   gyrase, 1.4, 2.3  
   high-molecular-weight. *See* Chromosomal DNA; Genomic DNA; Large DNA molecules  
   ligase. *See* DNA ligase  
   microarrays. *See* DNA array technology  
   mismatch repair, A4.3  
   polymerases. *See* DNA polymerase  
   precipitation by  
     CPB, 10.22–10.24  
     CTAB, 6.62  
     ethanol, 3.28–3.29, 6.17–6.18, 6.61, 10.20–10.21, A8.12–A8.16  
     isopropanol, 6.25, 6.30  
     PEG, 1.152, 1.154  
     spermidine, 9.34, 9.36  
   probes. *See* DNA probes; Radiolabeled probe preparation  
   purification. *See also* Plasmid DNA, preparation  
     from agarose gels, 5.18  
     anion-exchange chromatography, 5.26–5.28  
     DEAE cellulose membranes, electrophoresis onto, 5.18–5.22  
     dialysis bags, electroelution into, 5.23–5.25  
     problems associated with, 5.18  
     from agarose gels, low-melting temperature agarose  
     agarase, 5.33–5.35  
     glass bead use, 5.32  
     organic extraction, 5.29–5.31  
   BAC  
     from large-scale cultures, 4.55–4.57  
     from small-scale cultures, 4.53–4.54  
   bacteriophage  $\lambda$ , 2.56–2.60  
   cosmid vectors, 4.22–4.23  
   CTAB use in, 6.62  
   high-molecular-weight  
     by chromatography on Qiagen resin, 4.45  
     by drop dialysis, 4.44  
    $\lambda$  bacteriophage  
     from liquid cultures, 2.106–2.108  
     from plate lysates, 2.101–2.104  
 M13, 12.21–12.24  
   double-stranded (replicative form), 3.23–3.25  
   large-scale, 3.30–3.33  
   single-stranded, 3.26–3.29  
   PI and PAC, 4.42–4.45  
   simultaneous preparation with RNA and protein, 7.9–7.12  
   spooling, 6.61  
   YACs, 4.67–4.71  
   quantitation. *See* Quantitation of nucleic acids replication. *See also* Origin of replication; Replicons  
   in  $\lambda$ , 2.11  
   in phagemids, 3.43  
   sequencing. *See* DNA sequencing  
   size markers. *See* Molecular-weight markers  
   synthesis of oligonucleotides, 10.1, 10.42–10.46  
   Ultraviolet (UV) radiation  
     damage to DNA by, 1.67, 1.151, 5.20, 5.24  
     fixation to membranes by, 1.135, 1.137, 2.94–2.95, 6.46, 7.36  
   vectors. *See* Vectors; *specific vectors*  
   vital statistics tables, A6.2–A6.10  
 DNA adenine methylase (*dam*). *See* *dam* methylase  
 DNA array technology, A10.1–A10.19  
   advantages/disadvantages of array systems, A10.10  
   applications, A10.2–A10.3  
   gene expression analysis, A10.2  
   genomic DNA changes, monitoring, A10.2–A10.3  
   choice of array system, A10.8, A10.10  
   coverslips for, A10.14  
   databases and analysis software, A10.14–A10.16  
   detection of hybridization signal, A10.11  
   emerging technologies, A10.16–10.19  
     barcode chip, A10.19  
     bioelectric chip, A10.19  
     bubble jet printing, A10.16  
     DOC system, A10.17  
     DNA-protein interactions, detection of, A10.18–A10.19  
     IBD mapping, A10.17–A10.18  
     piezoelectric printing, A10.16  
     primer extension, A10.17  
     protein microarrays, A10.18  
     resequencing, A10.17  
     tissue microarrays, A10.18  
   flowchart, experiment, A10.4  
   genomic resources for, A10.3–A10.6  
   guidelines for experiments, A10.13–A10.14  
   hybridization, A10.10  
   image analysis, A10.12–A10.13  
   process overview, A10.2  
   production of microarrays, A10.7–A10.8  
     commercial sources, 10.9, A10.7–A10.8  
     contact printing, A10.7  
     photolithography, A10.8  
     pin and ring, A10.8  
   robotics for high-throughput processing, 10.5  
   solid support substrates, 10.5–A10.7  
   steps, experimental, A10.3  
   surface chemistry, A10.5–A10.7  
 DNA-binding domains, 18.6–18.15  
 DNA-binding proteins  
   competition assays, 17.17  
   detection with one-and-a-half hybrid system, 18.125–18.126  
   gel retardation assays, 17.13–17.16, 17.78–17.80  
   materials for, 17.13  
   optimizing, 17.16

- poly(dI-dC) and, 17.14–17.15  
troubleshooting, 17.16
- identifying in bacteriophage  $\lambda$  expression libraries, 14.31–14.36
- mapping sites  
by DNase I footprinting, 17.4–17.11  
by hydroxyl radical footprinting, 17.12
- protection against *dam* methylation, 13.88
- supershift assays, 17.17
- DNA-dependent RNA polymerase, 1.4, 1.11
- DNA ligase. *See also* Ligation reactions  
bacteriophage T4, 1.157–1.158, 3.37, A4.31–A4.32  
activity of, A4.31  
blunt-end ligation, A4.32  
cohesive termini/nick ligation, A4.32  
linker/adaptor attachment to cDNA, 11.54  
uses, list of, A4.31
- E. coli*, 1.158–1.159, A4.33  
in cDNA second-strand synthesis, 11.43, 11.45–11.46
- $\lambda$ , 2.3  
overview, 1.157  
table of properties, 1.158  
thermostable, 1.158  
units of activity, 1.159
- DNA PAM (percent accepted mutation) program, A11.5
- DNA polymerase, A4.22–A4.23. *See also specific polymerases*  
for automated DNA sequencing, 12.96, 12.98  
bacteriophage T4, 11.43, 11.45, 11.54, 12.32, A4.18–A4.21, A4.22. *See also* Sequenase  
3'-5' exonuclease activity, 8.30, 8.34–8.35, A4.18, A4.20  
5'-3' exonuclease activity, A4.18, A4.20  
5'-3' polymerase activity, A4.20  
in blunt-end cloning of PCR products, 8.32–8.34  
cDNA second-strand synthesis, 11.16  
in end-labeling, 9.56–9.59  
exchange reaction, A4.21  
idling/turnover reaction, 9.57–9.58  
in oligonucleotide-directed mutagenesis of single-stranded DNA, 13.15–13.17  
polishing ends, 11.43, 11.45, 11.54, 12.17  
properties, table of compared, A4.11  
uses, list of, A4.18–A4.19
- bacteriophage T7, A4.22  
in oligonucleotide-directed mutagenesis of single-stranded DNA, 13.15–13.16  
overview of, 12.104  
properties, table of compared, A4.11
- comparison, table of, A4.11
- E. coli* DNA polymerase I, 1.4, 9.82–9.86, A4.12–A4.14. *See also* Klenow fragment  
3'-5' exonuclease activity, A4.12, A4.14  
5'-3' exonuclease activity, A4.12–A4.14  
5'-3' polymerase activity, A4.12–A4.13  
in cDNA second-strand synthesis, 11.14–11.16, 11.43–11.46  
digoxygenin labeling of nucleic acids, A9.38–A9.39
- DNase I contamination of, 9.13  
domains of, 9.82–9.83, 12.101  
end-labeling, A4.12  
error rate, 9.83  
exchange reaction, A4.14  
M13 replication, 3.5  
nick translation, 9.12–9.13, 9.85–9.86, A4.12  
proofreading, 9.82  
properties, table of compared, A4.11  
in random priming reactions, 9.5  
RNase H primer, 1.6  
RNase H activity, A4.12  
uses of, 9.85–9.86, A4.12
- Klenow fragment, 1.84–1.85, 4.15, A4.15–A4.17  
3'-5' exonuclease activity, A4.17  
5'-3' polymerase activity, A4.16  
end labeling, 4.33, A4.15–A4.16  
exchange reaction, A4.17  
uses, list of, A4.15–A4.16
- overview, A4.10  
properties, table of, A4.11, A4.23  
reverse transcriptase (RNA-dependent DNA polymerase), A4.24–A4.26  
5'-3' polymerase activity, A4.24  
RNase H activity, A4.24–A4.25  
uses, list of, A4.25–A4.26
- in RT-PCR, 8.46, 8.48, 8.51–8.52  
thermostable, 8.4, 8.6–8.8, 8.10–8.11, 8.18, A4.22–A4.23. *See also* PCR
- 3'-5' exonuclease activity, 8.30, 8.77  
antibodies, 8.110  
for cDNA second-strand synthesis, 11.14  
cocktail mixtures of, 8.7, 8.77  
digoxygenin labeling of nucleic acids, A9.38–A9.39  
in DNA sequencing, 12.45–12.50  
in hot start PCR, 8.110  
in mutagenesis procedures  
megaprimer PCR mutagenesis method, 13.33–13.34  
misincorporation mutagenesis, 13.80  
overlap extension method of mutagenesis, 13.37–13.39  
plasmid template mutagenesis, 13.20–13.21  
in SSCP protocol, 13.53  
terminal transferase activity, template-independent, 8.30
- DNA polymerase III, 1.4
- DNA probes, radiolabeled  
preparation  
cDNA probes  
subtracted, 9.41–9.50, 9.90–9.91  
using oligo(dT) primer, 9.41–9.45  
using random primers, 9.38–9.40  
end-labeling  
3' termini with cordycepin/dideoxy ATP, 9.60–9.61  
3' termini with Klenow, 9.51–9.56  
3' termini with T4 DNA polymerase, 9.57–9.59  
5' termini, 9.55, 9.66–9.75  
methods, table of, 9.55–9.56  
with T4 polynucleotide kinase, 9.55, 9.66–9.75  
with terminal transferase, 9.55–9.56, 9.60–9.61  
nick translation, 9.4, 9.12–9.13  
PCR, 9.14–9.18  
random priming, 9.4–9.11  
single-stranded probes from M13  
of defined length, 9.19–9.24  
of heterogeneous length, 9.25–9.28  
overview, 9.19–9.20  
premature termination, 9.24  
for SI nuclease mapping of RNA, 7.59
- DNA-protein interaction detection by array use, A10.18–A10.19
- DNA-RNA hybrid length, measurement by alkaline agarose gel electrophoresis, 5.36
- DNase. *See also* DNase I  
contamination  
alkaline lysis plasmid DNA preparation, 1.42  
TE as source, 1.42  
exonuclease VII, 7.86  
in RNA isolation protocols, 7.8, 7.12  
single-strand-specific, 7.86  
in washing solution for inclusion bodies, 15.10
- DNase I, A1.8  
in *E. coli* lysate preparation for affinity chromatography, 14.29
- footprinting, 14.32, 14.40, 17.4–17.11, A4.41  
concentration of DNase I, 17.11  
control reactions, 17.8  
materials for, 17.4–17.7  
nuclear extract preparation from cultured cells, 17.9  
small numbers of cultured cells, 17.9–17.10  
tissue, 17.8–17.9  
optimization, 17.11  
overview, 17.75–17.76  
specificity, 17.75  
steps, diagram of, 17.5  
troubleshooting, 17.11
- hypersensitivity mapping, 17.18–17.22  
controls for, 17.22  
limitations of, 17.22  
materials for, 17.19–17.20  
overview of, 17.18–17.19  
protocol, 17.20–17.21
- in  $\lambda$  DNA purification, 2.107  
in nick translation, 9.12–9.13  
in RNA probe construction, 9.31–9.34  
in shotgun library generation, 12.10–12.11  
titrating batches of, 9.13
- DNase I dilution buffer, 17.19, A1.9
- DNA sequencing, 12.1–12.114  
asymmetric labeling, methods for, 12.72  
automated, 12.94–12.100  
capillary vs. slab systems, 12.94  
current models available, 12.94  
dye-primer sequencing, 12.96  
dye-terminator systems, 12.96–12.97  
genome sequencing strategy, 12.99–12.100  
history, 12.94–12.95  
optimizing reactions, 12.98–12.99  
polymerases for, 12.98  
templates for, 12.98–12.99
- autoradiography  
reading, 12.113
- BAFLs (bands in all four lanes), 12.29
- chemical method, 12.4–12.6, 12.61–12.73  
advantages of, 12.63  
chemical modifications used, 12.61  
diagram of, 12.62  
end-labeling for, 12.73  
flow chart for, 12.65  
materials for, 12.63–12.64  
methods, 12.64–12.66, 12.70–12.73  
end labeling, 12.73  
examples, 12.72  
rapid, 12.70–12.71  
troubleshooting band aberrations, 12.67–12.69
- compression in gels, 12.109–12.111
- dideoxy-mediated chain termination, 12.3–12.4, 12.6–12.9  
cycle sequencing, 12.51–12.55, 12.60  
advantages of, 12.51–12.52  
with end-labeled primers, 12.51–12.55  
with internal labeling, 12.60  
reaction mixtures for, 12.53, 12.60  
troubleshooting, 12.55
- denaturation of DNA for, 12.26–12.30  
rapid protocol, 12.30
- double-stranded templates, 12.26–12.31  
amount needed, 12.27  
denaturation protocols, 12.28–12.30  
in DNA purification by PEG precipitation, 12.31  
PCR-amplified, 12.106  
troubleshooting, 12.29  
using cycle sequencing, 12.51, 12.54  
using Sequenase, 12.34  
using *Taq* polymerase, 12.49
- end-labeling, 12.8



- DNA sequencing (*continued*)  
 general principles, 12.6  
 internal radiolabeling, 12.8  
 kits, 12.9  
 primers, 12.6–12.7  
 problem sources, 12.8  
 single-stranded templates using  
 cycle sequencing, 12.51, 12.54  
 Klenow, 12.40–12.44  
 Sequenase, 12.32, 12.34  
*Taq* polymerase, 12.49  
 strategies, 12.7  
 templates, 12.7  
 preparing denatured, 12.26–12.31  
 troubleshooting problems with, 12.38–  
 12.39, 12.44, 12.56–12.58  
 troubleshooting, 12.56–12.59  
 using Klenow, 12.40–12.44, 12.102  
 materials for, 12.41–12.42  
 method, 12.42–12.43  
 reaction mixtures, table of, 12.41  
 troubleshooting, 12.44  
 using Sequenase, 12.32–12.39, 12.104–  
 12.105  
 annealing primer to template, 12.29  
 materials for, 12.33–12.35  
 protocol, 12.35–12.36  
 reaction mixtures, table of, 12.33  
 sequencing range, 12.37  
 steps involved, 12.32  
 troubleshooting, 12.38–12.39  
 using *Taq* DNA polymerase, 12.45–12.50  
 materials for, 12.48–12.49  
 method, 12.49–12.50  
 overview, 12.45–12.47  
 versions of *Taq* used, 12.46–12.47  
 dNTP ddNTP stock solutions, preparation of,  
 12.107  
 exonuclease III use in, 13.72, 13.75  
 fluorescent labeling and, 9.80  
 glycerol in sequencing reactions, 12.108–12.109  
 history of, 12.3–12.4  
 Maxam and Gilbert technique, 12.3–12.6, 12.61–  
 12.73  
 microtiter plate use, 12.100  
 nucleoside analogs used as chain terminators in  
 Table A6-11), A6.10  
 oligonucleotide primers, preparing stocks of,  
 12.103  
 PCR-amplified DNA, 12.106  
 plus and minus technique, 12.4  
 polyacrylamide gels, 12.66–12.69, 12.74–12.93  
 autoradiography, 12.90–12.93  
 compression of bands, troubleshooting,  
 12.83, 12.109–12.110  
 loading, 12.88  
 base order, 12.88  
 loading devices, 12.88  
 marker dye migration rate, 12.89  
 preparation of, 12.74–12.84  
 air bubbles, 12.79  
 electrolyte gradient gels, 12.83–12.84  
 formamide containing, 12.81–12.82  
 glass plates, 12.76–12.78  
 leaking gels, 12.80  
 materials for, 12.74–12.75  
 pouring gels, 12.78–12.80  
 reading, 12.90–12.93  
 resolution of, 12.85  
 running, 12.85–12.89  
 safety precautions, 12.86  
 temperature-monitoring strips, 12.86  
 troubleshooting band pattern aberrations,  
 12.67–12.69, 12.82  
 wedge gels, 12.83  
 purification of plasmid DNA for, 1.152  
 Sanger technique, 12.3–12.4, 12.6–12.9  
 shotgun sequencing, 12.10–12.25  
 diagram of strategy, 12.12  
 DNA purification, 12.21–12.24  
 DNA repair, phosphorylation, and size selec-  
 tion, 12.17–12.18  
 enzymatic cleavage, 12.10–12.11  
 fragmentation of target DNA, 12.10–12.11,  
 12.15–12.17  
 growth of recombinants in 96-tube format,  
 12.19–12.21  
 hydrodynamic shearing, 12.10  
 ligation to vector DNA, 12.18–12.19  
 materials for, 12.13  
 number of sequences needed for coverage, 12.20  
 self-ligation of target DNA, 12.15  
 test ligations, 12.18, 12.25  
 universal primers, 8.113–8.117  
 uses for, 12.3  
 DnD solution, 1.106, 1.109  
 dNTPs. *See* Deoxynucleoside triphosphates  
 Dodecyltrimethylammonium bromide (DTAB), 6.61  
 DOGS, 16.8–16.9, 16.11  
 DOPE. *See* Dioleoylphosphatidylethanolamine  
 DOSPA, 16.11  
 DOSPER, 16.11  
 Dot hybridization of purified RNA, 7.46–7.50  
 DOTAP, 16.5, 16.11  
 DOTMA, 16.11  
 Double interaction screen (DIS), 18.125  
 Double-stranded DNA  
 calculating amount of 5' ends in a sample, 9.63  
 chemical stability of, 6.3  
 concentration in solution (Table A6-4), A6.5  
 denaturing probes, 7.43  
 nomogram for, A6.13  
 probes, denaturing, 6.54  
 separation from single-stranded by hydroxyap-  
 atite chromatography, A8.32–A8.34  
 Dowex AG 50W-X8, A8.27  
 Dowex AG50 resin, 1.76, 1.151  
 Doxycycline, 17.52, 17.54–17.56, 17.59  
 DP50*supF* *E. coli* strain  
 genotype, A3.7  
 $\lambda$  vector propagation, 2.29  
*DpnI*, 13.19–13.25, 13.84, A4.5–A4.6  
*DnaI*, A4.9  
 fragment size created by, table of, A4.8  
 site frequency in human genome, 4.16, A6.3  
 dRhodamine, 12.96–12.98  
 Drop dialysis, 4.44, A8.11  
 Drop-out media recipe, A2.9  
*Drosophila melanogaster*  
 ecdysone, 17.71  
 genomic resources for microarrays, A10.6  
 Drying DNA pellets, 1.34, 1.37, 1.41, 1.46  
 Drying SDS-polyacrylamide gels, A8.50–A8.51  
 DTAB. *See* Dodecyltrimethylammonium bromide  
 DTT. *See* Dithiothreitol  
 Dual Luciferase Reporter Assay System, A9.22  
 Dulbecco's modified Eagle's medium (DMEM),  
 11.85, 16.32, 17.61  
*dur* gene, 13.11–13.15, 13.84, 13.85  
 dUTPase, 13.85  
 Dye-primer sequencing, 12.96  
 Dye-terminator systems, 12.96–12.97  
 DyNAzyme, 8.7  
 DYNOMILL, 15.49  
*EagI*  
 cleavage at end of DNA fragments, A6.4  
 fragment size created by, table of, A4.8  
 genomic DNA mapping, 5.60, 5.69  
 methylation, A4.7  
 site frequency in human genome, 4.16, A6.3  
 EBC lysis buffer, 18.67–18.68  
 EBI-European Bioinformatics Institute, EMBL  
 Outstation, A11.2  
 Ecdysone receptor (EcR), 17.71, 17.73  
 Ecdysone-inducible mammalian expression system,  
 17.72  
*EcoK*, A4.4  
*E. coli* C, 11.113  
*E. coli* K, 11.113  
*E. coli* strains. *See* *Escherichia coli* strains  
*EcoO109I*, 9.52  
*EcoRI*  
 7-deaza-dGTP modified DNA, cleavage of, 8.60  
 in cDNA construction, 11.21, 11.48–11.52, 11.64  
 cleavage at end of DNA fragments, A6.4  
 fragment size created by, table of, A4.8  
 $\lambda$  vector construction, 2.19  
 linker sequences, 1.99  
 methylation of restriction site, 1.12, 1.99, 11.48–  
 11.50, A4.4  
 in positive selection vectors, 1.12  
 site frequency in human genome, 4.16, A6.3  
*EcoRI* methylase, 1.12, 11.48–11.50, A4.5, A4.7  
*EcoRI* methylase buffer, A1.10  
*EcoRII* methylase, A4.7  
*EcoRV*, A4.9, A6.4  
 ED8654 *E. coli* strain  
 genotype, A3.7  
 $\lambda$  vector propagation, 2.28  
 ED8767 *E. coli* strain  
 genotype, A3.7  
 ED8767 *E. coli* strain, 2.29  
 EDC (*N*-ethyl-*N'*-[dimethylaminopropyl]-carbodi-  
 imide), 18.104–18.105  
 Edman degradation, 18.62, 18.66, 18.68  
 EDTA, A1.26  
 as anticoagulant, 6.8  
 inhibition of PCR by, 8.13  
 as protease inhibitor, 15.19  
 in washing solution for inclusion bodies, 15.10  
 Effectene, 16.5  
 EGAD database, A10.15  
 EGTA, A1.26  
 inhibition of BAL 31, 13.64  
 as protease inhibitor, 15.19  
 EGY48, 18.22–18.23, 18.29, 18.44  
 EGY191, 18.22  
 Elastinal, A5.1  
 Electrical mobility of DNA, 12.114  
 Electroendo-osmosis (EEO), 5.7  
 Electrolyte gradient gels, 12.83–12.84, 12.87  
 Electrophoresis. *See* Agarose gel electrophoresis;  
 Alkaline agarose gel electrophoresis;  
 Contour-clamped homogenous electric  
 field; Denaturing gradient gel electrophore-  
 sis; Polyacrylamide gel electrophore-  
 sis; Pulsed-field gel electrophoresis; SDS-  
 polyacrylamide gel electrophoresis of pro-  
 teins; Transverse alternating field electro-  
 phoresis  
 Electrophoresis buffers  
 agarose gel preparation, 5.10  
 alkaline agarose gel electrophoresis, 5.37  
 BPTE, 7.28–7.29  
 CHEF gel, 5.80  
 DNA migration rate in agarose gels, effect on,  
 5.7–5.8  
 ethidium bromide in, 5.15  
 MOPS, 7.32  
 for polyacrylamide gel electrophoresis, 12.75,  
 12.84, 12.87  
 recipes, 5.8, A1.17–A1.18  
 in SSCP protocol, 13.52  
 TAFE gel, 5.75  
 taurine-containing, 12.108, 13.90  
 Tris-glycine, A8.42, A8.44  
 types, 5.8

- Electrophoretic transfer of DNA to nylon membranes, 6.36
- Electroporation  
of BAC DNA, 4.3, 4.49, 4.52  
DEAE-dextran enhancement of, 16.28  
DNA size and, 1.26  
electrical conditions required for, 16.55–16.56  
of library into COS-7 cells, 11.85–11.86  
of mammalian cells, 16.3, 16.33–16.36, 16.54–16.57  
efficiency, factors influencing, 16.33–16.34, 16.57  
materials for, 16.34–16.35  
method, 16.35–16.36  
marker-dependent transformation efficiency, 1.26  
mechanism of, 16.54–16.55  
in oligonucleotide-directed mutagenesis protocol, 13.18  
optimizing, 16.57  
overview, 1.25–1.26, 1.162  
PI clones, 4.4, 4.46–4.47  
pulse parameters, 1.162  
transformation of *E. coli* by, 16.54  
cotransformants, 1.119, 1.122  
plasmid size and, 1.119  
protocol, 1.119–1.122  
pulse characteristics, 1.122
- Eliminator dye removal system, A8.28
- Elution buffer  
for oligo(dT)-cellulose chromatography, 7.14, 7.16  
Qiagen, A1.20
- EMBL, 2.20–2.22
- EMBL database, A11.20
- EMBL3A vector, 2.64–2.65
- emotif (Exploring the Motif Universe) program, A11.9
- En'Hance scintillant, A9.12
- End modifications  
by inverse PCR, 8.42  
by PCR, 8.42–8.45
- endA*. See Endonucleases, endonuclease A
- End-labeling  
3' termini with cordycepin or dideoxy ATP, 9.60–9.61  
3' termini with Klenow, 9.51–9.56, 9.83–9.85, 12.101  
materials for, 9.53  
overview of, 9.51–9.53  
protocol, 9.54  
uses for, 9.51  
3' termini with T4 DNA polymerase, 9.57–9.59  
5' termini with T4 polynucleotide kinase, 9.55, 9.66–9.75  
blunt/recessed 5' termini, 9.70–9.72  
by exchange reaction, 9.73–9.75  
protruding 5' termini, 9.66–9.69, 9.73–9.75  
for chemical sequencing, 12.73  
in cosmid vectors, 4.33  
by DNA polymerase I, A4.12  
in DNA sequencing, 12.8  
cycle DNA sequencing, 12.51–12.55  
with Klenow fragment, 9.51–9.56, 9.83–9.85, 12.101, A4.15–A4.16  
methods, table of, 9.55–9.56  
with poly(A) polymerase, 9.56, 9.61  
probes in S1 protection assays, 7.54  
RNA by RNA ligase, A4.30  
with RNA ligase, 9.56, 9.61  
with T4 DNA polymerase, 9.57–9.59, A4.18  
with terminal transferase, 9.55–9.56, 9.60–9.61
- Endoacetylmuramidase, bacteriophage T4, A4.51
- Endocytosis, internalization of DEAE-dextran/DNA complexes, 16.27
- Endolysin, bacteriophage  $\lambda$ , A4.51
- Endonucleases  
endonuclease A  
boiling lysis plasmid DNA protocols and, 1.18, 1.43, 1.46  
TE as contamination source, 1.42  
endonuclease IV, 12.3  
restriction endonuclease. See Restriction enzymes
- End-rescue subcloning, 4.63
- Enhanced cyan fluorescent protein (ECFP), 18.71–18.72, 18.76, 18.91
- Enhanced green fluorescent protein (EGFP), 18.72, 18.76, 18.90–18.94
- Enhanced yellow fluorescent protein (EYFP), 18.72, 18.76, 18.91
- Enlightning scintillant, A9.12
- Entensify scintillant, A9.12
- Enterokinase, 15.8, 15.39–15.40, 15.43, 18.49
- Entrez, 1.14
- Enzyme stabilization by glycerol, 13.90
- Enzyme-free cloning. See Ligation-independent cloning
- Enzymes, A4.1–A4.52. See also specific classes of enzymes; specific enzymes  
agarase, A4.51  
alkaline phosphatases, A4.37  
DNA polymerases, A4.10–A4.27  
bacteriophage T4, A4.18–A4.21  
3'-5' exonuclease activity, A4.18, A4.20  
5'-3' polymerase activity, A4.20  
exchange reaction, A4.21  
uses, list of, A4.18–A4.19  
bacteriophage T7, A4.22  
comparison, table of, A4.11  
DNA polymerase I, *E. coli*, A4.12–A4.14  
3'-5' exonuclease activity, A4.12, A4.14  
5'-3' exonuclease activity, A4.12, A4.14  
5'-3' polymerase activity, A4.12–A4.13  
end-labeling, A4.12  
exchange reaction, A4.14  
nick translation, A4.12  
uses, list of, A4.12  
Klenow fragment, A4.15–A4.17  
3'-5' exonuclease activity, A4.17  
5'-3' polymerase activity, A4.16  
end-labeling, A4.15, A4.16  
exchange reaction, A4.17  
uses, list of, A4.15–A4.16  
overview, A4.10  
properties, table of compared, A4.11  
reverse transcriptase (RNA-dependent DNA polymerase), A4.24–A4.26  
5'-3' polymerase activity, A4.24  
RNase H activity, A4.24–A4.25  
uses, list of, A4.25–A4.26  
terminal transferase, A4.27  
thermostable, A4.22–A4.23  
inhibitors, table of, A5.1  
kinase, bacteriophage T4 polynucleotide, A4.30, A4.35–A4.36  
exchange reaction, A4.30, A4.35–A4.36  
forward reaction, A4.30, A4.35–A4.36  
properties, table of, A4.30  
ligases, A4.30–A4.34  
bacteriophage T4 DNA ligase, A4.31–A4.32, A4.34  
activity of, A4.31  
blunt-end ligation, A4.32  
cohesive termini/nick ligation, A4.32  
uses, list of, A4.31  
*E. coli* DNA ligase, A4.33  
thermostable DNA ligases, A4.34  
lysozymes, A4.51  
methylating, A4.3–A4.9. See also Methylation  
*dam* methyltransferase, A4.3  
*dcm* methyltransferase, A4.3–A4.4  
nucleases, A4.38–A4.49  
bacteriophage  $\lambda$  exonuclease, A4.49  
BAL 31, A4.43–A4.45  
DNase I, A4.40–A4.42  
exonuclease III, A4.47–A4.48  
mung bean, A4.47  
RNase A, A4.39  
RNase H, A4.38  
RNase T1, A4.39  
S1, A4.46  
proteinase K, A4.50  
RNA polymerases, A4.28–A4.29  
topoisomerase I, A4.52  
UDG, A4.51
- EPD (eukaryotic promoter database), A11.20
- Episomes, 1.3, 11.69. See also Plasmids
- Epitope tagging, 17.32, 17.90–17.93  
applications, 17.91  
examples, table of, 17.92–17.93  
overview, 17.90  
practical considerations, 17.90–17.91
- Epitope-tagged proteins, 1.14
- Eppendorf 5 Prime, 1.64
- Equilibration buffer, 5.86
- Equilibrium centrifugation, 1.18–1.19. See also Cesium chloride density gradients
- Escherichia coli*  
chromosome size, 5.65  
genomic resources for microarrays, A10.6  
strains. See also specific strains  
for the amplification of cDNA libraries in bacteriophage  $\lambda$  vectors, 11.66  
choosing appropriate, 1.14–1.16  
for inverted repeat sequences, 1.15  
for methylated DNA propagation, 1.15–1.16  
recombination mutations, 1.15  
for toxic protein products, 1.15  
heat lysis and, 1.17–1.18, 1.43  
 $\lambda$  propagation, 2.28–2.29, 11.62  
for M13 vectors, 3.10–3.46  
receiving in the laboratory, 1.29  
table of, A3.6–A3.10  
for in vitro packaging, 2.111
- EtBr Green Bag, A8.28
- Ethanol  
NaCl/ethanol solution, 6.19–6.20  
for washing glass plates for polyacrylamide gel electrophoresis, 12.77
- Ethanolamine, 18.104–18.105
- Ethanol precipitation, A8.12–A8.16  
aspiration of supernatants, A8.15  
carriers, A8.13  
dissolving precipitates, A8.13, A8.15–A8.16  
of DNA, 6.61  
M13 RF DNA preparation, 3.25  
M13 single-stranded DNA preparation, 3.28–3.29  
in PCR product purification, 8.59  
radiolabeled oligonucleotides, 10.20–10.21  
for spooling of mammalian DNA, 6.17–6.18  
history of, A8.14  
protocol for, A8.14–A8.15  
of RNA, 9.34–9.35, A8.16  
salt solutions used with, A8.12
- Ethidium bromide, A1.26  
agarose gel electrophoresis, 5.5, 5.11–5.15  
binding to DNA, A9.3  
breaks in DNA, single-stranded, 5.20  
in CsCl gradients, 1.18, 1.151  
continuous, 1.65–1.68  
discontinuous, 1.69–1.71  
decontamination, A8.27–A8.28  
commercial kits for, A8.28  
of concentrated solutions, A8.27–A8.28  
of dilute solutions, A8.28  
disposal of ethidium bromide, A8.27

- Ithidium bromide (*continued*)  
 dissociation from DNA, 1.151  
 DNase I and, A4.41  
 fluorescence, A9.3  
 in formaldehyde-containing agarose gels, 7.31–7.32  
 glyoxylated RNA, staining of, 7.27–7.28  
 intercalation into DNA, 1.18, 1.151, 5.14  
 migration in agarose gel electrophoresis, 5.13  
 overview, 1.150–1.151  
 photography, 5.16  
 polyacrylamide gel staining, 5.15, 5.47–5.48  
 quantitation of DNA, A8.19, A8.23–A8.24, A9.4  
   agarose plate method, A8.24  
   minigel method, A8.24  
   spot test, A8.19, A8.24  
 rate of DNA migration in agarose, effect on, 1.53, 5.3, 5.15  
 in real time PCR, 8.94  
 removal from DNA, L68, 1.151, A8.27  
   extraction with organic solvents, 1.72–1.77, 1.151  
   ion-exchange chromatography, 1.75–1.77, 1.151  
 resolution and, 5.15  
 RNA staining, 7.31–7.32  
 sensitivity of, 5.12  
 staining DNA in gels, A9.3–A9.4  
 structure of, 1.150, A9.3  
 as trypanocidal agent, 5.14, A9.3  
 versions of, improved, A9.4
- Ithylacetate, 17.36, 17.38, 17.40  
 N-ethylmaleimide, 13.3
- Eukaryotic DNA. *See* Genomic DNA; Mammalian cells, DNA isolation
- Eukaryotic expression libraries. *See also* Expression libraries  
 construction, 11.68–11.73  
 screening, 11.74–11.78
- European Bioinformatics Institute, A11.23
- ExGen 500, 16.5
- Exon amplification, 11.35, 11.79–11.97  
 analysis of clones, 11.95–11.97  
 electroporation of library into COS-7 cells, 11.85–11.86  
 flow chart of steps, 11.80  
 library construction, 11.81  
 mRNA, harvesting, 11.87–11.88  
 overview, 11.79–11.97  
 RT-PCR, 11.89–11.94  
   materials, 11.90–11.91  
   overview, 11.89  
   protocol, 11.91–11.94
- Exonuclease II buffer, A1.10
- Exonuclease III, 11.121, 13.2, A4.47–A4.48  
 5' exonuclease activity, A4.48  
 3' phosphatase activity, A4.48  
 activities of, 13.73  
 in linker-scanning mutagenesis, 13.75  
 making templates for dideoxysequencing with, 13.75  
 nested deletion mutant sets, generation of, 13.57–13.61, 13.74–13.75  
 overview, 13.72–13.75, A4.47–A4.48  
 in site directed mutagenesis, A4.48  
 substrate specificity, 13.72  
 thionucleotide resistance to, 13.75  
 uses of, 13.74, A4.47–A4.48
- Exonuclease III buffer, 13.58
- Exonuclease V, 1.15, 2.11–2.13, 2.13
- Exonuclease VII, 7.86
- Exonuclease, *Z.*, A4.49
- Expand high-fidelity PCR system, 13.20
- Expand long-template PCR system, 8.7, 8.77
- EXPASy Molecular Biology Server-Expert Protein Analysis System, Swiss Institute of Bioinformatics, A11.2
- Export of proteins, 15.30, 15.34–15.35  
 maltose-binding fusion proteins, 15.40, 15.43
- Expressed sequence tags (ESTs), 9.89  
 GenBank, A10.3–A10.4  
 microarray technology and, A10.3–A10.4, A10.6
- Expression. *See also* Expression in *E. coli* of cloned genes; Expression in mammalian cells  
 analysis by microarray technology, A10.2  
 cloning  
   cDNA library construction, 11.68–11.73  
   controls for, 11.70  
   factors influencing success, 11.69–11.70  
   mammalian host/vector systems, 11.69  
   screening cDNA library, 11.74–11.78  
   vector systems for, 11.72  
   screening cDNA libraries by, 11.33–11.34  
 Expression array platform, A10.9  
 Expression in *E. coli* of cloned genes, 15.1–15.60  
 expression system choice, 15.2–15.3, 15.55–15.57  
 fusion proteins  
   cleavage, 15.6–15.8  
   chemical, 15.6–15.8  
   enzymatic, 15.7–15.8, 15.39–15.40, 15.43  
   purification  
     by affinity chromatography on amylose resin, 15.40–15.43  
     by affinity chromatography on glutathione agarose, 15.36–15.39  
     of histidine-tagged proteins, 15.44–15.48  
     from inclusion bodies, 15.49–15.54  
     of maltose-binding proteins, 15.40–15.43  
     by metal chelate affinity chromatography, 15.44–15.48  
     purification of, 15.4–15.5  
     solubility, 15.9–15.11, 15.39, 15.53–15.54  
     uses for, 15.4  
     vectors for creating, 15.5  
 inclusion bodies, 15.9–15.11, 15.49–15.54  
 optimization  
   codon usage, 15.12  
   of expression from inducible promoter, 15.16–15.19  
   growth conditions, 15.12, 15.16–15.17, 15.19, 15.23, 15.28  
   temperature effect on, 15.16–15.17, 15.25  
   translation initiation, 15.11–15.12  
 overview, 15.56–15.57  
 problem areas, 15.56–15.57  
 promoters, choosing, 15.3–15.4  
 solubility of proteins, 15.9–15.11, 15.39, 15.53–15.54  
 using alkaline phosphatase promoter (*phoA*), 15.30–15.35  
   large-scale expression, 15.34  
   materials for, 15.31–15.32  
   optimization, 15.33  
   overview, 15.30  
   protocol, 15.32–15.34  
   subcellular localization of fusion proteins, 15.35  
 using IPTG-inducible promoters, 15.3, 15.14–15.19  
   choices for, 15.3  
   large-scale expression, 15.17–15.18  
   materials for, 15.15  
   optimization, 15.16–15.19  
   overview, 15.14  
   protocol, 15.16–15.18  
   troubleshooting, 15.18–15.19  
 using  $\lambda$  *p<sub>1</sub>* promoter, 15.4, 15.25–15.29  
   large-scale expression, 15.29  
   materials for, 15.26–15.27  
   optimization, 15.28  
   overview, 15.25  
   protocol, 15.27–15.29  
 tryptophan-inducible expression, 15.26, 15.28–15.29  
 using T7 promoter, 15.3–15.4, 15.20–15.24  
   large-scale expression, 15.24  
   materials for, 15.22  
   optimization, 15.23–15.24  
   overview, 15.20–15.22  
   protocol, 15.23–15.24  
   regulation by lysozyme, 15.24  
 vectors, choosing, 15.3–15.5
- Expression in mammalian cells, 17.1–17.99  
 differential expression, 9.89  
 DNA-binding proteins  
   competition assays, 17.17  
   gel retardation assays  
     materials for, 17.13  
     optimizing, 17.16  
     poly(dI-dC) and, 17.14–17.15  
     troubleshooting, 17.16  
   gel retardation assays for, 17.13–17.16, 17.78–17.80  
   mapping sites by  
     DNase I footprinting, 17.4–17.11  
     hydroxyl radical footprinting, 17.12  
   supershift assays, 17.17  
 DNase I footprinting, 17.4–17.11  
 control reactions, 17.8  
 materials for, 17.4–17.7  
 nuclear extract preparation from  
   cultured cells, 17.9  
   small numbers of cultured cells, 17.9–17.10  
   tissue, 17.8–17.9  
 optimization, 17.11  
 steps, diagram of, 17.5  
 troubleshooting, 17.11  
 DNase-I-hypersensitivity sites, mapping, 17.18–17.22  
 controls for, 17.22  
 limitations of, 17.22  
 materials for, 17.19–17.20  
 overview of, 17.18–17.19  
 protocol, 17.20–17.21  
 hydroxyl radical footprinting protocol, 17.12  
 inducible systems  
   ecdysone, 17.71–17.74  
   tetracycline, 17.52–17.70  
 libraries, 11.68–11.69, 11.74–11.78. *See also* Expression libraries, screening  
 overview, 17.3  
 reporter assays, 17.30–17.51  
    $\beta$ -galactosidase, 17.48–17.51  
     endogenous mammalian  $\beta$ -galactosidase activity, 17.48  
     materials for, 17.50  
     method, 17.51  
     normalizing reporter enzyme activity to  $\beta$ -galactosidase activity, 17.48, 17.51  
     overview, 17.48–17.49  
   p $\beta$ -gal reporter vectors, 17.49  
   substrates for  $\beta$ -galactosidase, 17.51  
 chloramphenicol acetyltransferase, 17.30–17.41, 17.95  
 aberrant transcription, 17.34  
 controls, 17.34  
 measurement by diffusion of reaction products into scintillation fluid, 17.41  
 measurement by extraction with organic solvents, 17.40  
 measurement by thin-layer chromatography, 17.36–17.39  
 normalizing CAT activity to  $\beta$ -galactosidase activity, 17.48–17.49, 17.51  
 overview, 17.33–17.34  
 pCAT3 vectors, 17.35  
 quantitative assays, 17.95  
 genes used, 17.30–17.32

- GFP, 17.85–17.87  
 luciferase, 17.42–17.47, 17.96  
 advantages of, 17.42  
 luminometer measurements from 96-well plates, 17.47  
 materials for, 17.44  
 methods, 17.45–17.47  
 optimizing measurement, 17.45  
 pGL3 vectors, 17.43  
 scintillation counting protocol, 17.46  
 overview, 17.30–17.32  
 transfection controls, 17.32  
 transcriptional run-on assays, 17.23–17.29  
 materials for, 17.24–17.26  
 nuclei isolation, 17.26–17.27  
 from cultured cells, 17.26  
 from tissue, 17.27  
 overview of, 17.23–17.24  
 radiolabeling transcripts from cultured cell nuclei, 17.27  
 tissue nuclei, 17.27–17.28
- Expression libraries, screening, 14.1–14.51  
 antibody choice for, 14.50–14.51  
 antisera purification for, 14.51  
 complexity of library, 14.49  
 cross-reactive antibody removal  
 affinity chromatography, 14.28–14.30  
 incubation with *E. coli* lysate, 14.26–14.27  
 pseudoscreening, 14.23–14.25  
 DNA-binding protein identification, 14.31–14.36  
 filter preparation, 14.35–14.36  
 hybridization, 14.36  
 materials for, 14.32–14.34  
 overview, 14.31–14.32  
 probe preparation, 14.34–14.35  
 enzymatic vs. radiolabeled reagents, 14.3  
 by far western analysis, 18.48–18.50  
 genomic vs. cDNA libraries, 14.47–14.48  
 in  $\lambda$  vectors, 14.4–14.13, 14.47–14.49  
 bacteriophage recovery from stained filters, 14.11  
 chemiluminescent screening, 14.11–14.12  
 chromogenic screening, 14.9–14.11  
 detection of fusion protein-expressing plaques, 14.8–14.12  
 duplicate filter preparation, 14.8  
 expression induction on filters, 14.7–14.8  
 materials for, 14.4–14.6  
 plating bacteriophage, 14.7  
 radiochemical screening, 14.9  
 troubleshooting, 14.13  
 validation of clones, 14.12  
 lysate preparation from  $\lambda$  lysogens, 14.37–14.46  
 agar plate, 14.41–14.43  
 from colonies, 14.37–14.40  
 liquid culture, 14.44–14.46  
 overview, 14.37  
 in plasmid vectors, 14.14–14.22, 14.47–14.49  
 chemiluminescent screening, 14.21–14.22  
 chromogenic screening, 14.20–14.21  
 master plate/filter preparation, 14.17  
 materials for, 14.15–14.17  
 processing filters, 14.18  
 protein expressing clones, 14.19–14.22  
 radiochemical screening, 14.19  
 replica filter preparation, 14.17–14.18  
 validation of clones, 14.22  
 vector choice, 14.14  
 probability of recombinant existence, 14.48  
 probe types  
 antibody probes, 14.1–14.2  
 oligonucleotide probes, 14.2  
 specialized, 14.2  
 for protein interactions by two-hybrid system, 18.6  
 Expression systems, 15.55–15.57  
*Bacillus subtilis*, 15.55  
 bacteriophage T7, A4.28  
*E. coli*, 15.1–15.60. *See also* Expression in *E. coli*  
 of cloned genes  
 insect cells, culture, 15.55  
 mammalian cells. *See* Expression in mammalian cells  
 RNA polymerase use in, 9.88  
*Saccharomyces cerevisiae*, 15.55  
 system selection, 15.55  
 Expression vectors  
 $\lambda$ , 2.22–2.23, 4.83  
 luciferase, A9.23  
 overview, 1.13–1.14  
 phagemids, 3.43  
 ExSite PCR-based site-directed mutagenesis kit, 13.89  
 Extinction coefficients, 10.13–10.14, A8.20–A8.21  
 Extraclean, 18.104–18.106  
 Ex-Wax DNA extraction kit, 6.27
- f1 bacteriophage, 1.11  
 origin of replication, 11.22–11.24, 17.35, 17.49  
 sequences in  $\lambda$ ZAP vectors, 11.22  
 f88-4, 18.118  
 Factor X protease, 15.40, 15.43  
 Factor Xa, 15.7–15.8, 15.39  
 Far western analysis, 18.3  
 outline of, 18.49  
 protein-protein interactions, detecting, 18.48–18.54  
 Farnesylated enhanced GFP (EGFP-F), 16.10  
 Fast performance liquid chromatography (FPLC), 13.20  
 FASTA program, A11.3, A11.19  
 FASTS/TFASTS program, A11.19  
 FASTX/FASTY program, A11.4  
 fd bacteriophage, 3.2, 18.115, 18.117. *See also* M13 bacteriophage  
 FeCl<sub>3</sub> in  $\lambda$  stock preparation, 2.35, 2.37  
 Fe(II)-EDTA, 17.12, 17.76–17.77  
 Fetuin for protein stability, 17.16  
 F factors  
 BACs and, 4.2–4.3, 4.48  
 history of, 4.49  
*lacI<sup>h</sup>* allele on, 15.18  
 M13 and, 3.2, 3.8, 3.11, 3.17–3.18  
 maintaining, 3.17–3.18  
 overview, 4.49  
*par* genes, 4.3  
 positive selection strategies, 3.11–3.13  
 FGENES program, A11.11–A11.12  
 FI protein,  $\lambda$ , 2.14  
 Fibronectin, 18.60, 18.62, 18.64  
 Ficoll 400  
 in DNase I footprinting protocol, 17.10  
 in gel retardation assay, 17.15  
 FII gene,  $\lambda$ , 2.14  
 Filamentous bacteriophage, 18.115. *See also* f1 bacteriophage; M13 bacteriophage  
 biology overview, 3.2–3.7  
 discovery of, 3.2  
 phagemids, 3.42–3.49  
 Filamentous phage display, 18.3, 18.115–18.122  
 affinity selection and purification of bacteriophages, 18.121  
 commercial display systems, 18.120–18.121  
 of foreign proteins, 18.121–18.122  
 interaction rescue, 18.122  
 of peptides, 18.116–18.121  
 constrained libraries, 18.120–18.121  
 construction of libraries, 18.117–18.119  
 random peptide libraries, 18.116–18.117  
 vectors used for, 18.115–18.116, 18.118  
 Filling in, 1.84–4.85  
 double stranded cDNA, 11.20  
 with Klenow fragment, 9.83–9.84, 12.101, A4.5  
 with reverse transcriptase, A4.25  
 with T4 DNA polymerase, 9.57, A4.18  
 Film, autoradiography and, A9.9–A9.14  
 Filters. *See specific type of filter*  
 Firefly luciferase gene. *See* Luciferase  
 Fixative, cell, 16.13  
 FK506, 18.11  
 FKBP12, 18.11  
 FLAG  
 affinity purification of fusion proteins, 15.4–15.6  
 epitope tagging, 17.92–17.93  
 FlexiPrep, 1.64  
 FLIM. *See* Fluorescence lifetime imaging microscopy  
 FliTrx Random Peptide Display Library, 18.120  
 FLP recombinase, 4.85  
 Fluorescein, A9.33. *See also* Fluorescent labeling  
 Fluorescence lifetime imaging microscopy (FLIM)  
 FLIM-FRET analysis, 18.78–18.95  
 cell preparation for, 18.84–18.89  
 fixed cells, 18.87–18.88  
 microinjection of live cells, 18.88–18.89  
 transfection of plasmid DNA into live cells, 18.84–18.86  
 example experiments  
 on fixed cells, 18.94–18.95  
 on live cells, 18.93–18.94  
 flow diagram for, 18.79  
 image acquisition, 18.90–18.95  
 imaging protein phosphorylation with, 18.78  
 labeling proteins with fluorescent dyes for, 18.80–18.83  
 frequency domain, 18.74, 18.76–18.77  
 image processing, 18.75–18.78  
 single-frequency configuration, 18.76–18.77  
 time domain, 18.74  
 Fluorescence resonance energy transfer (FRET), 17.87, 18.4, 18.69–18.95  
 detection methods, 18.72–18.74  
 donor quenching, 18.73  
 fluorescence lifetime, 18.73–18.74  
 photobleaching, acceptor, 18.73  
 steady-state fluorescence intensity measurements, 18.72–18.73  
 efficiency, 8.71, 18.74  
 FLIM-FRET, 18.78–18.95  
 cell preparation for, 18.84–18.89  
 data acquisition, 18.90–18.95  
 flow diagram, 18.79  
 imaging protein phosphorylation with, 18.78  
 labeling proteins with fluorescent dyes for, 18.80–18.83  
 photophysical principles of, 18.70–18.72  
 Fluorescent labeling  
 of oligonucleotide probes in real time PCR, 8.94–8.95  
 probes, 9.77–9.80  
 in microarray hybridization, A10.2, A10.11–A10.13  
 in sequencing, 12.63  
 in automated DNA sequencing, 12.94–12.96  
 in cycle DNA sequencing, 12.52  
 Fluorochromes  
 excitation and emission wavelengths, A9.33  
 labeled antibodies, A9.33  
 Fluorography, A9.12  
 Fluorometers, 8.95  
 Fluorometric quantitation of nucleic acids, 6.12, A8.22–A8.24  
 ethidium bromide use, A8.19, A8.23–A8.24  
 agarose plate method, A8.24  
 minigel method, A8.24  
 spot test, A8.19, A8.24  
 with Hoechst 33258, A8.19, A8.22–A8.23  
 Fluorometry buffer, 6.12  
 Fnu4H in end-labeling, selective, 9.52

- Eco*1A methylase, A4.7
- Footprinting DNA, 17.75–17.78  
cleavage product selection, 17.77  
DNase I, 17.4–17.11, 17.75–17.76  
controls for, 17.8  
materials for, 17.4–17.7  
method, 17.8–17.10  
overview of, 17.75–17.76  
troubleshooting/optimizing, 17.11
- hydroxy radical, 17.12, 17.76  
in vivo, 17.77  
1.10 penanthroline-copper, 17.76–17.77
- Forced ligation. *See* Directional cloning
- Formaldehyde  
in agarose gels, 7.31–7.34  
in cell fixative, 16.13  
RNA denaturation, 7.31–7.33  
for dot/slot hybridization, 7.48  
in silver staining protocol, A9.5–A9.7
- Formaldehyde gel-loading buffer, A1.19
- Formamide, 1.138  
deionization of, A1.24  
for DNA isolation  
in  $\lambda$  DNA extraction, 2.59–2.60  
from mammalian cells, 6.13–6.15  
in DNA sequencing protocols, 12.109–12.110  
resolving compressions in sequencing gels, 6.59  
in gel-loading buffers, 7.7, 7.68, 10.12, 12.36, A1.19  
in northern hybridization, 7.45  
in PCR, 8.9  
in polyacrylamide sequencing gels, 12.81–12.82  
purity, assessing, 6.59  
in ribonuclease protection assay protocols, 7.67  
RNA denaturation, 6.59, 7.33  
RNA gel-loading buffer, 7.68  
RNA storage, 7.8  
in Southern hybridization, 6.56, 6.58–6.60  
stripping northern blots, 7.44  
stripping probes from filters, A9.38  
in tracking dye, 10.12
- Formamide denaturation buffer, 6.14
- Formamide dye mix, 17.6
- Formamide loading buffer, 7.77, 12.36, A1.19
- Formic acid, 12.70–12.71, A1.6  
cleavage of fusion proteins, 15.6, 15.8
- FPLC. *See* Fast performance liquid chromatography
- Fragmentation of DNA, A8.35–A8.38. *See also* Hydrodynamic shearing  
HPLC use for, A8.35  
methods, table of, A8.35  
nebulization, A8.37–A8.38  
sonication, A8.36–A8.37
- Fredd volume fluctuation, 16.55
- French press for cell lysis prior to affinity chromatography, 15.38, 15.46
- FRET. *See* Fluorescence resonance energy transfer
- Frozen storage buffer, 1.106, 1.108
- Fsp*I, 5.69
- FSSP. Fold classification based on Structure-Structure alignment of Proteins) database, A11.22
- fts* gene, 18.125
- FUSE vectors, 18.118
- Fusion proteins  
 $\beta$ -galactosidase, 17.97  
cleavage, 15.6–15.8  
chemical, 15.6–15.8  
enzymatic, 15.7–15.8, 15.39–15.40, 15.43  
epitope tagging, 17.90–17.93  
applications, 17.91  
examples, table of, 17.92–17.93  
overview, 17.90  
practical considerations, 17.90–17.91  
expression vectors, 1.13–1.14  
GFP, 17.87–17.89  
*lacZ* fusion, 15.57–15.59  
disadvantages, 15.58  
inclusion bodies, 15.58  
vectors for, 15.59  
lysate preparation from  $\lambda$  lysogens  
agar plates, 14.41–14.43  
from colonies, 14.37–14.40  
liquid culture, 14.44–14.46  
protein-protein interaction studies  
GST, 18.48–18.59  
two-hybrid system, 18.17–18.47  
purification, 15.4–15.5  
by affinity chromatography, 14.40  
on amylose resin, 15.40–15.43  
on glutathione agarose, 15.36–15.39  
metal chelate, 15.44–15.48  
of histidine-tagged proteins, 15.44–15.48  
from inclusion bodies, 15.49–15.54  
of maltose-binding proteins, 15.40–15.43  
screening expression libraries  
 $\lambda$  vectors, 14.31  
in  $\lambda$  vectors, 14.4–14.12  
in plasmid vectors, 14.14–14.15, 14.19–14.22  
solubility, 15.9–15.11, 15.39, 15.53–15.54  
subcellular localization of PhoA fusion proteins, 15.35  
uses for, 15.4  
vectors for creating, 15.5
- G418, 16.24, 16.48
- Gadolinium oxysulfide intensifying screens, A9.11
- GAL1, 18.24, 18.27, 18.30, 18.37
- GAL4, 18.14–18.15, 18.24
- Galactokinase in positive selection vectors, 1.12
- Galacto-Light, 17.50
- gal* gene,  $\lambda$  transduction of, 2.18
- gam*,  $\lambda$ , 2.11–2.13, 2.20, 2.22
- GATA-1 transcription factor in positive selection vectors, 1.12
- GC-Melt, 4.81, 8.9, 8.23
- GEF. *See* Guanyl nucleotide exchange factor
- Gel electrophoresis. *See* Agarose gel electrophoresis;  
Alkaline agarose gel electrophoresis;  
Contour-clamped homogeneous electric field; Denaturing gradient gel electrophoresis; Polyacrylamide gel electrophoresis; Pulsed-field gel electrophoresis; SDS-polyacrylamide gel electrophoresis of proteins; Transverse alternating field electrophoresis
- Gel equilibration buffer, 5.33
- Gel retardation assays, 11.68, 17.13–17.16, 17.78–17.80  
advantages of, 17.79  
carrier DNAs, 17.80  
competition assays, 17.17  
controls, 17.15  
materials for, 17.13  
measuring dissociation constants of protein-DNA complexes, 17.79  
mechanism of action, 17.80  
mobility of protein-DNA complex, 17.79–17.80  
optimizing, 17.16  
overview, 17.78–17.80  
poly(dI-dC) and, 17.14–17.15  
supershift assays, 17.17  
troubleshooting, 17.16
- Gel Slick, 12.75
- Gelatin, A1.27
- Gel-elution buffer, 7.55, 7.59–7.60
- Gel-fixing solution, 12.90
- Gel-loading buffers  
6x gel-loading buffers, 5.42, A1.18–A1.19  
agarose gel electrophoresis, 1.53, 5.9  
alkaline agarose gel electrophoresis, 5.37  
formaldehyde, 7.32, A1.19  
formamide, 7.7, 7.68, 10.12, 12.36, A1.19  
glycerol in, 13.90  
recipes, A1.18–A1.20  
RNA, 7.68, A1.19  
SDS, 15.15, 15.22, 15.26, 15.31, 15.35, 15.41, 15.50, 18.17, A1.20, A8.42
- GenBank, A10.3, A10.15, A11.20
- GenData AG image analysis program, A10.13
- Gene discovery and microarray technology, A10.3
- Gene expression. *See also* Expression in *E. coli* of cloned genes; Expression in mammalian cells; Expression libraries; screening; Expression systems; Northern hybridization  
analysis by microarray technology, A10.2  
differential display-PCR, 8.96–8.106  
measurement by reassociation kinetics, 7.65
- Gene gun. *See* Biolistics
- Gene Pulser II, 16.35
- GeneAmp 5700 System, 8.95
- Genecards database, A10.15
- GeneChip, A10.9
- Geneclean, 12.21
- GeneFilters microarrays, A10.9
- Genelight (GL) system, A9.22
- GeneMark program, A11.10
- GeneParser program, A11.11
- GenePix 4000, A10.11, A10.13
- GenePix image analysis software, A10.15
- GenePix Pro image analysis program, A10.13
- GENESCAN program, A11.11
- GeneSHUTTLE 20, 16.5
- GeneSHUTTLE 40, 16.5
- GENESIS sample processor (Tecan), A10.5
- GeneSpring, A10.15
- GeneTAC 1000, A10.11
- Genetic code table, A7.4
- Genetic engineering with PCR, 8.42–8.45
- Geneticin, A2.7
- Geneticin resistance in activation domain fusion plasmids, 18.20
- GeneTransfer HMG-1 Mixture, 16.5
- GeneTransfer HMG-2 Mixture, 16.5
- GeneView software, A10.9
- GenExplore image analysis program, A10.13
- GeniePrep, 1.64
- Genie program, A11.10
- Genome comparisons (Table A6-1), A6.2
- Genome sequencing strategy, 12.99–12.100
- GenomInspector program, A11.13
- Genomic DNA  
breakage, 6.3  
CHEF gels, 5.79–5.82  
cloning specific fragments of, 2.80  
digestion by restriction enzymes in agarose plugs, 5.68–5.70, 5.78  
direct selection of cDNAs with, 11.98–11.106  
exon trapping/amplification, 11.79–11.97  
expression library construction, 14.48–14.49  
inverse PCR, 8.81  
isolation  
CTAB use, 6.62  
hydrodynamic shearing forces and, 6.3  
lysis of cells  
blood cells, 6.8–6.9  
in monolayers, 6.6  
in suspension, 6.7, 6.17  
in tissue samples, 6.7–6.8, 6.17  
from microtiter plates, 6.19–6.22  
from mouse tails, 6.23–6.27  
one-tube isolation, 6.26–6.27  
from paraffin blocks, 6.27  
without extraction by organic solvents, 6.26  
from paraffin blocks, 6.27  
for PCR use, 6.18, 6.22

- rapid protocol  
   for mammalian DNA, 6.28–6.30  
   for yeast DNA, 6.31–6.32  
 by spooling, 6.16–6.18  
 using formamide, 6.13–6.15  
 using proteinase K and phenol, 6.4–6.11  
   100–150-kb DNA size, 6.10–6.11  
   150–200-kb DNA size, 6.10  
 for microarray analysis, A10.3–A10.6  
 microarray technology for monitoring changes in, A10.2–A10.3  
 partial digestion for cosmid library construction, 4.20  
 preparation for pulsed-field gel electrophoresis, 5.61–5.67  
 resolution by TAFE, 5.74–5.78  
 restriction digestion  
   completeness of, 6.40  
   for Southern analysis, 6.39–6.40, 6.42  
 Southern analysis. *See also* Southern hybridization  
   overview, 6.33  
   restriction digestion for, 6.39–6.40, 6.42  
   transfection of eukaryotic cells, calcium-phosphate-mediated, 16.21–16.24  
 Genomic footprinting, 12.63  
 Genomic libraries. *See also* Vectors, high-capacity BAC  
   construction, 4.49–4.50  
   screening, 4.50–4.51  
   chromosome walking, 4.8–4.10  
   clone analysis by PCR, 2.105  
   construction  
     arrayed libraries, 4.8  
     chromosome walking, 4.8–4.10  
     overview, 4.6–4.7  
     vector choice, factors influencing, 4.7–4.10  
   cosmids, 4.11–4.34  
     amplification, 4.28–4.34  
     arrayed libraries, 4.31  
     overview, 4.11–4.16  
     protocol for construction, 4.17–4.23  
     stability of recombinants, 4.28  
     storage, 4.30, 4.32  
   DNA for. *See* Genomic DNA  
   gaps in coverage, 4.6–4.7  
   human, table of, 4.9  
   insert size, 2.77  
   in  $\lambda$   
     amplification, 2.87–2.89  
     ligation of  $\lambda$  arms to genomic DNA fragments, 2.84–2.86  
     screening by hybridization  
       DNA transfer to filters, 2.90–2.95  
       protocol, 2.96–2.100  
   P1, 4.35–4.40  
   partial digestion of DNA for  
     pilot reactions, 2.76–2.79  
     preparative reactions, 2.80–2.83  
   probability calculations, 4.6  
   restriction site frequency in human genome, 4.16  
   vectorette PCR isolation of genomic ends, 4.74–4.81  
 YAC  
   characterization, 4.61  
   construction, 4.60  
   mapping inserts, 4.63  
   rescuing termini of genomic DNAs, 4.63  
   screening, 4.61, 4.62  
   subcloning from, 4.64  
 Genomic mismatch scanning (GMS), A10.17–A10.18  
 Genomics and mapping protein interactions, 18.123–18.124  
 GENSCAN program, A11.11  
 Gentamycin, A2.7  
 German Human Genome Project, A10.5  
 GFP. *See* Green fluorescent protein  
 GI724 *E. coli* strain, 15.26  
 Gibbs sampler (Gibbs Sampling Strategy for Multiple Alignment) program, A11.10  
 Giemsa stain, 16.13  
 Gigapack III Gold, 11.114  
 Glass beads  
   acid-washed, 6.31–6.32  
   recovery of DNA from agarose gels using, 5.32  
 Glass plates for sequencing gels, 12.76–12.78  
 Glass powder resins for DNA purification, 5.26  
 Glass slides for microarray applications, A10.5  
 Glass-Max, 1.64  
 Glassmilk, 8.27  
 Glassware, preparation of, A8.3  
 Glucocorticoid receptor (GR), 17.71  
 Glucose oxidase  
   chemiluminescent enzyme assay, A9.20  
   as digoxigenin reporter enzyme, 9.77  
 Glu-Glu, epitope tagging, 17.93  
 Glutamic acid  
   codon usage, A7.3  
   nomenclature, A7.7  
   properties, table of, A7.8  
 Glutamine  
   codon usage, A7.3  
   nomenclature, A7.7  
 Glutaraldehyde  
   in cell fixative, 16.13  
   coupling peptides to carriers, A9.32  
   for silver staining PFGE gels, 5.77  
 Glutathione-agarose resin, 15.36–15.39,  
   18.51–18.52, 18.58–18.59  
 Glutathione elution buffer, 15.36, 15.38  
 Glutathione S-transferase (GST) fusion proteins,  
   14.47, 15.26, 15.36–15.39, 17.83  
   affinity purification of fusion proteins, 15.4,  
     15.6  
   as probes for protein-protein interactions,  
     18.48–18.59  
   anti-GST antibodies, 18.54  
   biotin-labeled, 18.50  
   far western analysis, 18.48–18.54  
   pulldown technique, 18.55–18.59  
   protein-protein interactions, 18.3  
   pulldown technique, 18.3, 18.48, 18.55–18.59  
   materials for, 18.57–18.58  
   method, 18.58–18.59  
   outline of, 18.56  
   troubleshooting, 18.59  
   soluble fusion protein production, 15.9  
 Glyceraldehyde-3-phosphate dehydrogenase (GAPDH)  
   normalizing RNA samples against, 7.22  
   use as quality check on RNA gels, 7.30  
 Glycerol, 13.54, A1.27  
   in calcium-phosphate-mediated transfection,  
     16.14–16.15, 16.17, 16.52  
   DEAE transfection, facilitation of, 16.28  
   in DNA sequencing reactions, 12.38, 12.59,  
     12.108–12.109  
   in gel-loading buffers, 13.90  
   in PCRs, 8.9, 8.23, 8.78  
   in polyacrylamide gels, 13.90  
   for stabilization of enzymes, 13.90  
   for storage of bacterial cultures, 13.90, 17.24,  
     A8.5  
   structure of, 13.90  
   for transient expression and transformation of  
     mammalian cells, 13.90  
 Glycerol shock, 17.62–17.63  
 Glycerol step gradient for  $\lambda$  particle purification,  
   2.52–2.53, 13.90  
 Glycerol storage buffer, 17.24  
 Glycine  
   codon usage, A7.3  
   nomenclature, A7.7  
   properties, table of, A7.8  
 Glycogen as carrier in ethanol precipitation of  
   DNA, A8.13  
 Glyoxal  
   deionization of, A1.24  
   denaturation of RNA for electrophoresis,  
     7.27–7.29  
 GMS 418 Array Scanner, A10.11  
 Gobase for Mitochondrial Sequences database,  
   A11.21  
 Gold use in biolistics, 16.38–16.39  
 Good buffers, A1.3–A1.4  
 Gomori buffers, A1.5  
*gpt* gene, *E. coli*, 16.49  
 Gradient fractionating device, 2.81–2.82  
 Gradients. *See* Cesium chloride density gradients;  
   Glycerol step gradient; Sodium chloride,  
   density gradient for  $\lambda$  arm purification;  
   Sucrose gradients  
 Grai II (Gene Recognition and Analysis Internet  
   Link) program, A11.11  
 Green fluorescent protein (GFP), 17.84–17.89  
   antibodies, 17.89  
   cloning vectors, 18.84  
   fluorescence excitation and emission spectra,  
     17.86  
   FRET (fluorescence resonance energy transfer),  
     18.69–18.72, 18.76, 18.84–18.89  
   as fusion tag, 17.87–17.89  
   localization signals, fusion of organelle-specific,  
     18.69, 18.84  
   overview, A9.24  
   pd2EGFP vectors, 17.88  
   in protein interaction analysis, 18.69  
   as reporter, 17.31–17.32, 17.85–17.87  
   resources for use of, 17.89  
   source of, 17.84  
   structure and function, 17.84–17.85  
   as transfection positive control, 16.4, 16.10,  
     16.12  
   variants of, 18.71–18.72  
*groE* gene, 2.14  
 Growth hormone as reporter gene, 17.31  
 Grunstein-Hogness screening, 1.28, 1.127, 1.135  
 GST fusion proteins. *See* Glutathione-S-transferase  
   fusion proteins  
 Guanidine hydrochloride, 14.31–14.33  
   denaturing fusion proteins with, 15.7  
   inclusion body solubilization, 15.60  
   for solubilization of inclusion bodies, 15.54  
 Guanidine thiocyanate in denaturing agarose gels,  
   7.22  
 Guanidinium  
   chloride, 15.60  
   hydrochloride, structure of, 7.85  
   isothiocyanate, 7.85, 15.60  
   salts, overview of, 7.85  
   thiocyanate in RNA purification protocols, 7.4–7.8  
 Guanine, A6.8  
   carbodiimide modification, 13.95  
   nitrous oxide modification of, 13.78  
   related compounds (Table A6-7), A6.8  
   structure, A6.8  
 Guanyl nucleotide exchange factor (GEF), 18.126  
 Guessmers, 8.66–8.67, 10.6–10.9, 11.31  
   design, 10.7  
   hybridization conditions, 10.8  
   melting temperature, 10.8  
   mixtures of, 10.7–10.8  
   PCR compared, 10.9  
 Guide RNA (gRNA) database, A11.21  
 Gyrase. *See* DNA, gyrase  
 GYT medium, 1.120–1.121, A2.2

- H  
 decay data, A9.15  
 particle spectra, A9.10  
 sensitivity of autoradiographic methods for detection, A9.13
- HABA (2-(4-hydroxazobenzene) benzoic acid, 11.115)
- Hae*II methylase, A4.5
- Hae*III in rapid screen for interaction trap isolates, 18.47
- Hairpin structures  
 nuclease S1 digestion of, 11.4, 11.16, 11.46  
 self-primed synthesis of cDNA and, 11.4, 11.17, 11.46
- Hanahan method for preparation and transformation of competent *E. coli*, 1.105–1.110
- HAI medium, 16.48
- HB101 *E. coli* strain, 1.115  
 boiling lysis plasmid DNA protocols, 1.17–1.18, 1.43  
 cell-wall component shedding and DNA purification, 1.18, 1.115  
 endonuclease A contamination and DNA preparation, 1.18  
 in exon amplification protocols, 11.82–11.84  
 genotype, A3.7  
 $\lambda$  vector propagation, 2.29
- HB2151 *E. coli* strain, 18.116
- HCC. See Hexamminecobalt chloride
- HCl (hydrochloric acid), A1.12, A.6
- Heat shock genes, cellular, 15.25
- Heat-sealable bags. See Seal-A-Meal bags
- Helicase, 4.2
- Helicobacter pylori*, genomic resources for microarrays, A10.6
- Helper virus  
 phagemids and, 3.42–3.47  
 preparation of high-titer stock, 3.46  
 superinfection protocol, 3.47
- Hemocytometer counting, A8.6–A8.7
- Hemoglobin inhibition of PCR by, 8.13
- Heparin  
 inhibition of PCR by, 8.13  
 in Southern hybridization, 6.56
- HEPES  
 in BLAcore analysis solutions, 18.104–18.105, 18.108  
 in binding buffer, 14.33, 14.36  
 in cell resuspension buffer, 17.6  
 in DNase I dilution buffer, 17.19  
 in electrophoresis buffers, 13.56  
 in oligonucleotide labeling buffer, 9.10  
 in random primer buffer, 9.6, 9.47  
 in tissue homogenization buffer, 17.6, 17.25  
 in tissue resuspension buffer, 17.6
- HEPES-buffered DMEM, 16.32
- HEPES-buffered saline, 16.15–16.17, 16.22–16.23, 16.52
- Herpes simplex type-1 (HSV-1) TetR fusion to VP16 protein, 17.54–17.55
- HERV repetitive elements, 11.95
- Heteroduplex analysis (HA), 13.49, 13.51
- Hexadecyltrimethyl ammonium bromide. See also Cetyltrimethylammonium bromide  
 polysaccharide removal, 2.105  
 for solubilization of inclusion bodies, 15.54
- Hexamminecobalt chloride (HCC)  
 as condensing agent, 1.24, 1.152  
 in transformation buffers, 1.107–1.108
- hfi* gene, *E. coli*, 2.21, 2.28, 11.59, 11.111, 14.48
- Hha*I in site-directed mutagenesis protocol, 13.84
- Hha*I methylase, A4.4, A4.7
- Hha*II methylase, A4.7
- High-molecular-weight DNA. See Chromosomal DNA; Genomic DNA; Large DNA molecules
- High-performance liquid chromatography (HPLC)  
 hydrodynamic shearing of DNA, A8.35  
 oligonucleotide purification, 10.49
- hina*A gene, 2.16
- him*I gene, 2.16
- Hinc*II, 1.100, A4.9
- Hind*III  
 7-deaza-dGTP modified DNA, cleavage of, 8.60  
 cleavage at end of DNA fragments, A6.4  
 fragment size created by, table of, A4.8  
 linker sequences, 1.99  
 site frequency in human genome, 4.16, A6.3  
 terminal/subterminal site cleavage, inefficient, 8.38
- Hinf*I  
 7-deaza-dGTP modified DNA, cleavage of, 8.60  
 in end-labeling, selective, 9.52
- Hirudin, A5.1
- his*3, 4.59, 18.11, 18.19, 18.22
- His-6 epitope, 17.93. See also Histidine-tagged proteins
- His•Bond Resin, 15.46
- Histidine  
 for affinity purification of fusion proteins, 15.6  
 codon usage, A7.3  
 nomenclature, A7.7  
 properties, table of, A7.8
- Histidine-tagged proteins, 17.83  
 elution by decreasing pH, 15.44–15.48  
 purification by affinity chromatography, 15.6, 15.44–15.48  
 in SPR spectroscopy, 18.99
- Histochemical stain, 16.13
- $\beta$ -galactosidase and, 17.98–17.99
- Histone deacetylation, inhibition of, 16.17
- HisTrap, 15.46
- HIV. See Human immunodeficiency virus
- HMMER program, A11.7
- HMS174 *E. coli* strain, 15.23, A3.7
- HNPP (2-hydroxy-3-naphthoic acid 2'-phenylamidine phosphate), 9.79
- Hoechst 33258 fluorochrome, 6.12, A8.19, A8.22–A8.23
- Holliday structure, 2.16
- Homogenization of tissue, 6.7–6.8  
 for nuclear extract preparation, 17.8  
 for RNA isolation, 7.6–7.7  
 for transcriptional run-on assay, 17.27
- Homopolymeric tailing, 11.110–11.111
- Horseradish peroxidase (HRP)  
 antibody conjugates, A9.34  
 CARD (catalyzed reporter deposition) protocol and, A9.19  
 chemiluminescent assay, 9.79, A9.19  
 as digoxigenin reporter enzyme, 9.77  
 luminol probes and, A9.35–A9.37  
 overview, A9.35  
 as reporter enzyme, 9.77, 9.79  
 in screening expression libraries, 14.3, 14.20–14.21  
 chemiluminescent, 14.11, 14.21  
 chromogenic, 14.10–14.11  
 substrates, A9.35
- Hot start PCR, 8.89
- Hot tub DNA polymerase, 8.10  
 in megaprimer PCR mutagenesis method, 13.33  
 properties, table of, A4.23
- HotWax Beads, 8.110
- Housekeeping genes  
 as endogenous standards for quantitative PCR, 8.86–8.87  
 normalizing RNA samples against, 7.22
- Hpa*I, A4.9
- Hpa*II methylase, A4.7
- Hph*I  
*dam* methylation and, 13.87  
 for T vector creation, 8.35
- Hph*I methylase, A4.7
- Hph*II, *dam* methylation and, A4.3
- HPLC. See High-performance liquid chromatography
- HPOI, epitope tagging, 17.93
- HRP. See Horseradish peroxidase
- HSB buffer, 17.24
- hsd*M, 11.66, A4.4
- hsd*R, 2.28–2.29, 11.23–11.24, 11.66, A4.4
- hsd*R4, M13 vectors and, 3.10, 3.12
- hsd*R17, M13 vectors and, 3.10, 3.12
- hsd*S, 2.29, A4.4
- HSSP (homology-derived secondary structure of proteins) database, A11.22
- H-tetrazole, 10.42
- Human Genome Project, 12.99, 18.66, A10.5
- Human immunodeficiency virus (HIV)  
 GeneChip array, A10.9  
 Rev protein, 18.11
- Human PAC library, 4.9
- Hybond-C extra, 14.6, 14.24
- Hybridization. See also Nitrocellulose membranes; Nylon membranes; Probes; Southern hybridization  
 bacteriophage  $\lambda$  recombinants, screening  
 DNA transfer to filters, 2.90–2.95  
 probe purity, 2.98  
 in situ amplification, 2.95  
 blocking agents for, A1.14–A1.16  
 cDNA screening, 11.27–11.32  
 homologous probes, 11.27  
 similar sequence probes, 11.28–11.29  
 subtracted cDNA probes, 11.29–11.31  
 synthetic oligonucleotide probes, 11.31–11.32  
 total cDNA probes, 11.29  
 zoo blots, 11.28
- chemiluminescent labels in, A9.17–A9.18
- Church buffer, 4.26
- competitor DNA use, 4.26
- cross-hybridization, reducing, 4.27
- denaturation of DNA on filter, 2.94
- direct selection of cDNAs protocol, 11.98–11.106
- of DNA separated by CHEF, 5.82
- of DNA separated by TAFE, 5.78
- DNA transfer to filters, 2.90–2.95  
 rapid protocol, 2.95
- expression library screening, 14.36
- fixation of DNA to filter, 2.94–2.95
- in formamide-containing buffers, 6.60
- Grunstein-Hogness screening, 1.28
- identifying recombinant plasmids by, 1.27–1.28
- at low stringency, 6.58
- making filters, 2.93
- melting temperature and, 10.47–10.48
- microarrays, A10.10–A10.12, A10.14
- nonradioactive labeling and, 9.76–9.80
- northern hybridization  
 background, 7.45  
 cDNA library screening, 11.38  
 fixation of RNA to membranes, 7.35–7.36, 7.39–7.40  
 at low stringency, 6.58  
 low-stringency, 7.43  
 membranes used for, 6.37  
 nonradioactive labeling and, 9.76, 9.80  
 overview of, 7.21–7.26  
 protocol, 7.42–7.44  
 quantitating RNA by, 7.66  
 ribonuclease protection assay compared, 7.63–7.65
- RNA separation by size  
 electrophoresis of glyoxylated RNA, 7.27–7.30  
 equalizing RNA amounts in gels, 7.22–7.23  
 formaldehyde-agarose gels, 7.31–7.34

- markers used in gels, 7.23, 7.29  
 overview, 7.21–7.22  
 pseudomessages as standards, 7.23  
 RNA transfer to membranes, 7.25–7.26, 7.35–7.41  
   membranes used for, 7.23–7.25  
   protocols, 7.35–7.41  
   staining of RNA on membranes, 7.39  
   steps involved, list of, 7.21  
   stripping blots, 7.44  
   troubleshooting, 7.45  
 for nuclease S1 mapping of RNA, 7.59–7.60  
 oligonucleotide probes  
   degenerate pools, 10.5–10.6  
   hybridization temperature, 10.6  
   length of probes, 10.4–10.5  
   melting temperature, 10.2–10.4  
   reassociation kinetics, 7.65  
   repetitive elements in probes, 4.26–4.27  
 RNA  
   dot and slot, 7.46–7.50  
   intensity of signal, measuring, 7.47  
   normalization, 7.47  
   protocol, 7.48–7.50  
   sample application to membrane, 7.46  
   standards, 7.47  
   northern protocol, 7.42–7.44. *See also* Northern hybridization  
 screening  
   BAC libraries, 4.50–4.51  
   bacterial colonies  
     binding DNA to filters, 1.131, 1.135, 1.137  
     filter type, choosing, 1.126  
     intermediate numbers, 1.129–1.131  
     large numbers, 1.132–1.134  
     lysing colonies, 1.131, 1.135–1.137  
     with radiolabeled probe, 1.138–1.142  
     replica filters, 1.131, 1.134  
     small numbers, 1.126–1.128  
   M13 plaques by, 3.41  
   site-directed mutagenesis clones, 13.40–13.47  
   subtractive, 9.44–9.46, 9.49, 9.90–9.91  
   unamplified cosmid high-capacity, 4.24–4.27  
 in situ hybridization  
   nonradioactive labeling and, 9.76, 9.80  
   RNA probes for, 9.35  
   subtractive, 9.44–9.46, 9.49, 9.90–9.91  
   transcriptional run-on assays, 17.23–17.24, 17.28–17.29  
 Hybridization buffer, A1.12–A1.13  
   with formamide (for RNA), A1.13  
   without formamide (for RNA), A1.13  
   in nuclease S1 mapping of RNA, 7.56  
   rapid, 6.61–6.62  
   in ribonuclease protection assay protocols, 7.67  
 Hybridization chambers, 1.139–1.141, 2.97, A10.14  
 Hybridization solution, 6.51–6.52, 11.100, A1.13–A1.14  
 Hydra Work Station (Robbins), A10.5  
 Hydrazine  
   5-methylcytosine and, 12.68  
   in chemical sequencing protocols, 12.61–12.65  
   rapid methods, 12.71  
   mutagenesis from, 13.78  
   salt interference with, 12.73  
 Hydrazine stop solution, 12.63  
 Hydrochloric acid (HCl), A1.6, A1.12  
 Hydrodynamic shearing, 2.76, 6.10, 12.10–12.11.  
   *See also* Fragmentation of DNA  
 Hydrolink, 13.51, 13.53  
 Hydrophobicity scales, A9.31  
 HydroShear, A8.35  
 Hydroxy radical footprinting, 17.76  
 Hydroxyapatite chromatography, 7.65, 9.44, 9.90–9.91, 11.10, A8.32–A8.34  
 Hydroxylamine, 13.91, 13.95  
   for cleavage of fusion protein, 15.8  
   mutagenesis from, 13.78  
 2-hydroxy-3-naphthoic acid 2'-phenylamide phosphate (HNPP), 9.79  
 3-(*p*-hydroxyphenyl) propionic acid (HPPA), A9.35  
 Hydroxyquinoline, A8.9  
 Hygromycin, 16.49, 17.74, A2.7  
 Hygromycin-B phosphotransferase, 16.47, 16.49  
 Hypophosphorous acid, A8.27  
 Hypoxanthine, 8.68, 10.9, A6.10  
<sup>125</sup>I  
   decay data, A9.15  
   radiolabeling antibodies, A9.30  
   sensitivity of autoradiographic methods for detection, A9.13  
<sup>131</sup>I decay data, A9.15  
 Iasis, 18.96  
 IBIS Biosensor, 18.96  
 Identical-by-descent (IBD) mapping, A10.17–A10.18  
 IgG, radioiodination of, 14.5, 14.16  
 IGP (imidazoleglycerolphosphate), 4.59  
 ImaGene image analysis program, A10.13  
 Imidazole, 15.44–15.45, 15.47  
 Imidazole buffer, 9.74, 15.45, A4.35  
 Imidazoleglycerolphosphate (IGP), 4.59  
 Immunity vectors, 2.21  
 Immunoaffinity columns, 11.10. *See also* Affinity chromatography  
 Immunoassay. *See* Immunological screening  
 Immunoblotting, A8.52–A8.55  
   blocking agents, A8.54  
   membrane types, A8.53  
   probing and detection, A8.54–A8.55  
   staining proteins during, A8.54  
   transfer of proteins from gel to filter, A8.52–A8.53  
 Immunofluorescence and epitope tagging, 17.91  
 Immunoglobulin-binding proteins A, G, L, A9.46–A9.49  
 Immunoglobulins. *See* Antibodies  
 Immunohistochemical staining  
   for  $\beta$ -glucuronidase, 16.42  
   of cell monolayers for  $\beta$ -galactosidase, 16.13  
 Immunological screening. *See also* Expression libraries, screening  
   antibody choice, 14.50–14.51  
   antisera purification, 14.51  
   cDNA screening, 11.32–11.33  
   chemiluminescent labels in, A9.17–A9.18  
   cross-reactive antibody removal  
     affinity chromatography, 14.28–14.30  
     incubation with *E. coli* lysate, 14.26–14.27  
     pseudoscreening, 14.23–14.25  
   epitope tagging, 17.90–17.93  
   of expression libraries, 14.1–14.3  
   validation of clones isolated by, 14.12  
 Immunoprecipitation, A9.29  
   coimmunoprecipitation, 18.4  
   epitope tagging, 17.91  
   of polysomes, 11.10  
 Inclusion bodies, 15.9–15.11, 15.56, 15.58  
   isolation by centrifugation, 15.10  
   lysis of bacteria containing, 15.10  
   purification and washing, 15.51–15.52  
     Triton X-100 use, 15.51  
     urea use, 15.52  
   purification of proteins from, 15.49–15.54  
     cell lysis, 15.49  
     refolding of proteins, 15.53–15.54  
     refolding proteins from, 15.11  
   solubilization, 15.11, 15.52, 15.60  
   washing, 15.10  
 Inclusion-body solubilization buffer, 15.50  
 Incompatibility of plasmids, 1.7–1.8  
 India Ink, A8.54  
 Inducible expression systems  
   ecdysone, 17.71–17.74  
   tetracycline, 17.52–17.70  
 Induction medium, 15.12, 15.31  
 Influenza virus hemagglutinin, epitope tagging of, 17.92  
 Injection/transfection buffer, 5.86  
 Ink, radioactive, 1.140, 1.142, 2.97–2.98, A1.21  
 Inosinate (IMP) dehydrogenase, 16.49  
 Inosine, 8.68, 8.113, 10.9–10.10, 11.32  
   in DNA sequencing, 12.88, 12.95, 12.97, 12.109–12.110  
   Sequenase use of, 12.105  
   structure, A6–10  
 Inoue method for preparation and transformation of competent *E. coli*, 1.112–1.115  
 Insects  
   baculoviruses, 17.81–17.83  
   expression in cultured cells, 15.55  
 Insertion vectors,  $\lambda$ , 2.19, 2.21  
 Insertional inactivation, 1.10  
 In situ hybridization  
   nonradioactive labeling and, 9.76, 9.80  
   RNA probes for, 9.35  
 Integrase, 2.8, 2.16, 11.11  
 Integration host factor (IHF), 2.16  
 Integration of  $\lambda$ , 2.16  
 Intensifying screens, A9.11  
 Interacting sequence tags (ISTs), 18.124  
 Interaction rescue, 18.122  
 Interaction trap  
   genomic analysis, 18.123–18.124  
   library screening, 18.30–18.48  
      $\beta$ -galactosidase activity assay, 18.36–18.37  
     characterization of isolates, 18.45  
     confirmation of positive reactions, 18.38–18.45  
     flow chart for, 18.38  
     harvesting transformants, 18.33–18.34  
       by agitation, 18.34  
       by scraping, 18.34  
     interacting proteins, screening for, 18.35  
     materials for, 18.30–18.32  
     rapid screen of positive reactants, 18.46–18.48  
     transformation of library, 18.32–18.33  
     troubleshooting, 18.35, 18.37  
   related technologies, 18.125–18.127  
*int* gene, 2.3, 2.8, 2.21  
 Inverse PCR, 1.157, 4.74–4.75, 8.81–8.85  
   materials for, 8.82–8.83  
   method, 8.84–8.85  
   overview of, 8.81  
   restriction enzyme choice for, 8.81, 8.84–8.85  
   schematic representation of, 8.82  
   site-directed mutagenesis  
     deletion introduction, 8.42  
     end modification, 8.42  
   use of, 8.81  
 Inverted repeat sequences, lethality of, 1.15  
 Invitrogen, 1.84  
 In vitro mutagenesis, 12.102, 13.19–13.25. *See also* Mutagenesis, site-directed  
 In vitro packaging, 2.111, 11.113–11.114  
 In vitro transcription  
   capped RNAs, 9.88  
   of genomic fragments, 4.74  
   kits, 9.32  
   plasmid vectors for, 9.29–9.31  
   protruding 3' termini, 9.33–9.34, 9.36  
   RNA polymerases, 9.87–9.88  
   RNA probe synthesis, 9.29–9.37  
     materials for, 9.32–9.33  
     promoter addition by PCR, 9.36–9.37  
     protocol, 9.33–9.35  
   for RNase protection assay



- In vitro* transcription (*continued*)  
 DNA template production, 7.70  
 protocol, 7.71  
 for *in situ* hybridization, 9.35  
 troubleshooting, 9.36  
 RNA purification, 9.34–9.35  
 uses of, 9.88
- Iodine radiolabeling of, 14.5, 14.16  
 Iodoacetate, A4.42, A5.1  
 Iodogen (1,3,4,6-tetrachloro-3 $\alpha$ ,6 $\alpha$ -diphenylglycouracil), A9.30  
 Iodosobenzoic acid 2-(2-nitrophenyl)-3-methyl-3-bromoindole-nine, 15.8
- Ion-exchange chromatography for removal of ethidium bromide from DNA by, 1.75–1.77
- IPI ab MicroArray Suite for Macintosh, A10.15  
 IPTG (isopropylthio- $\beta$ -D-galactoside), 1.124–1.125, A1.27  
 amplification of P1 vectors, 4.36, 4.42  
 direct addition to plates, 1.125  
 fusion protein induction, 14.38, 14.40–14.42, 14.45–14.46  
 for M13 vectors recognition, 3.8, 3.19  
 in screening of expression libraries  
 $\lambda$  vectors, 14.4, 14.7–14.8  
 plasmid vectors, 14.14, 14.18  
 use with M13 vectors, 3.38  
 IPTG overlay solution, 14.41–14.42  
 IPTG inducible promoters  
 for expression of cloned genes in *E. coli*, 15.3, 15.14–15.19  
 choices for, 15.3  
 large-scale expression, 15.17–15.18  
 materials for, 15.15  
 optimization, 15.16–15.19  
 overview, 15.14  
 protocol, 15.16–15.18  
 troubleshooting, 15.18–15.19  
*lac* promoter, 15.3  
*trc* promoter, 15.3
- IR1, 3.42  
 Iron response element (IRE), 18.11  
 IRS, epitope tagging, 17.93  
 Isoamyl alcohol  
 ethidium bromide extraction from DNA, 1.73  
 in phenol:chloroform:isoamyl alcohol extractions, 6.25, 6.27, 17.28, A1.23, A8.10  
 Isoelectric focusing (IEF), 18.61  
 Isogen, 7.10  
 Isolation of DNA. *See* Genomic DNA, isolation; Mammalian cells, DNA isolation  
 Isoleucine  
 codon usage, A7.3  
 nomenclature, A7.7  
 properties, table of, A7.9  
 Isopropanol  
 DNA precipitation, 6.25, 6.30, A8.5  
 ethidium bromide extraction from DNA, 1.151, A8.27  
 RNA precipitation, 7.7, 7.12  
 Isopropylthio- $\beta$ -D-galactoside. *See* IPTG  
 Isopycnic centrifugation through CsCl gradients for  $\lambda$  particle purification, 2.47–2.51  
 Isothermal titration calorimetry, 18.96  
 IS1s interacting sequence tags, 18.124  
 Iterons, 1.8
- Jellyfish *Aequorea victoria*, 17.89. *See also* Green fluorescent protein  
*J* gene,  $\lambda$ , 2.4, 2.15  
 JM101 *E. coli* strain  
 genotype, A3.7  
 M13 vectors and, 3.12  
 JM105 *E. coli* strain, 1.115  
 JM105 *E. coli* strain  
 genotype, A3.7  
 M13 vectors and, 3.12  
 JM107 *E. coli* strain  
 genotype, A3.7  
 M13 vectors and, 3.12  
 JM108 *E. coli* strain, 1.115  
 transformation by Hanahan method, 1.106  
 JM109 *E. coli* strain, 1.115, 13.12–13.13  
 genotype, A3.7  
 M13 vectors and, 3.12  
 M13-100 vector use in, 3.10  
 phagemids and, 3.42  
 JM110 *E. coli* strain  
 genotype, A3.7  
 M13 vectors and, 3.12
- K802 *E. coli* strain  
 genotype, A3.8  
 $\lambda$  vector propagation, 2.28  
 Kanamycin, 1.9  
 in *dam* strains and, 13.88  
 mechanism of resistance to, 1.145  
 modes of action, 1.145, A2.7  
 properties, 1.145  
 stock/working solutions, A2.6  
 structures of, 1.145  
 Kanamycin resistance (Km<sup>R</sup>)(*kan*<sup>R</sup>), 1.9  
 in activation domain fusion plasmids, 18.20  
 in LexA fusion plasmids, 18.19  
 in P1 vectors, 4.4, 4.37  
 in two-hybrid system of reporter plasmids, 18.12  
*KatI* cleavage at end of DNA fragments, A6.4  
 KC8 *E. coli* strain, 18.27, 18.43, A3.8  
 KCl. *See* Potassium chloride  
 Keiselguhr, A9.32  
 Keyhole limpet hemocyanin, A9.32  
 Kid proteins, 17.56  
 Kinase. *See* Polynucleotide kinase, bacteriophage T4  
 Kinetic PCR. *See* Real time PCR  
 Kissing complex, 1.5, 1.7  
 Kits, plasmid purification, 1.62–1.64  
 KK2186 *E. coli* strain  
 genotype, A3.8  
 M13 vectors and, 3.13  
 Klenow buffer, 9.20, A1.10  
 Klenow fragment, 1.84–1.85, 9.82–9.86, 12.101–12.102, A4.15–A4.17  
 5'-3' exonuclease activity, A4.17  
 5'-3' polymerase activity, A4.16  
 activity, measurement of, 12.102  
 in BAL 31 mutagenesis protocol, 13.65  
 in cDNA probe production, 9.46, 9.49–9.50  
 in cDNA second-strand synthesis, 11.14  
 digoxigenin labeling of nucleic acids, A9.38–A9.39  
 in DNA sequencing, 12.40–12.44  
 asymmetric labeling, 12.72  
 materials for, 12.41–12.42  
 method, 12.42–12.43  
 reaction mixtures, table of, 12.41  
 secondary structure problems, 12.44  
 troubleshooting, 12.44  
 end labeling, A4.15–A4.16  
 for chemical sequencing of DNA, 12.73  
 in cosmid vectors, 4.33  
 modified nucleotide use in end-labeling, 9.53  
 error rate, 9.83, 12.102  
 exchange reaction, A4.17  
 in exonuclease III mutagenesis protocol, 13.57, 13.61  
 filling-in recessed 3' termini, 9.83–9.84, 12.101–12.102  
 inactivation of, 9.23  
 labeling 3' termini, 9.51–9.56, 9.83–9.85, 12.101  
 labeling of oligonucleotides, 10.30–10.34  
 diagram of scheme, 10.31  
 primers for, 10.31–10.33  
 protocol, 10.33–10.34  
 strand separation, 10.32  
 labeling single-stranded DNA by random priming, 9.85  
 in misincorporation mutagenesis, 13.80  
 model of DNA bound to, 9.84  
 modified nucleotide use in end-labeling, 9.53  
 in oligonucleotide-directed mutagenesis of single-stranded DNA, 13.15–13.17  
 partial filling of cosmid termini, 4.15  
 polishing ends, 12.17  
 in probe production for nuclease S1 mapping of RNA, 7.58  
 properties, table of compared, A4.11  
 in radiolabeling for gel retardation assays, 17.16  
 in random priming reactions, 9.5, 9.7, 9.11  
 replacement by other polymerases, 12.102  
 Sequenase compared, 12.32  
 single-stranded probe production, 9.19–9.23, 9.27  
 by primer extension, 9.85  
 uses, list of, A4.15–A4.16  
 in vitro mutagenesis and, 12.102
- Klentax, 8.77–8.78, 8.85  
 in circular mutagenesis, 13.20  
 in cycle sequencing reactions, 12.46–12.47  
 structure of, 12.47  
 Km<sup>R</sup>. *See* Kanamycin resistance  
 Knock-out, gene, 1.15  
 KOH/Methanol solution, A1.20  
 Kox1, 17.56  
 Kozak sequence, 17.96  
*KpnI*, A4.9  
 cleavage at end of DNA fragments, A6.4  
 KS promoter, primer sequence for, 8.117  
 Kunkel method, 13.84  
 KW251 *E. coli* strain  
 genotype, A3.8  
 $\lambda$  vector propagation, 2.28  
 Kyoto Encyclopedia of Genes and Genomes (KEGG) database, A10.15
- L40, 18.22  
 Labeled avidin-biotin (LAB) technique, A9.33  
 Labeling. *See* DNA probes; Nonradioactive labeling; Radiolabeled probe preparation; RNA, probes  
 Labeling buffer, 17.24  
*lac* operon in M13, 3.8–3.10  
*lac* promoter  
 for eukaryotic expression vectors, 11.72  
 for expression of cloned genes in *E. coli*, 15.3, 15.15–15.19  
 in pET expression vectors, 15.21  
 primer sequence for, 8.117  
*trp-lac* promoter, 15.3  
*lac* repressor, 15.18, 15.57. *See also lacI<sup>q</sup>*  
*lacI<sup>q</sup>*, 11.23–11.24, 11.66  
 in IPTG-inducible expression vectors, 15.15–15.16, 15.18  
 $\lambda$  propagation and, 2.28–2.29  
 in  $\lambda$ ZAP, 14.6  
 M13 vectors and, 3.10, 3.12–3.13  
 in plasmid expression vectors, 14.14  
 in pMAL vectors, 15.40  
*lac-proAB* in M13 vectors, 3.10, 3.12–3.13  
*lacZ*, 1.10, 1.27, 17.97. *See also*  $\beta$ -galactosidase  
 in BAC vectors, 4.3  
 $\alpha$ -complementation, 1.149–1.150  
 in expression vectors, 14.47–14.48  
 fusion proteins, 15.57–15.59  
 disadvantages, 15.58  
 inclusion bodies, 15.58  
 vectors for, 15.59  
 in  $\lambda$  vectors, 2.30, 11.22, 11.25  
 in  $\lambda$ gt11 vector, 11.111

- in M13, 3.8–3.10
- in pUC vectors, 3.9
- as screening marker in  $\lambda$  recombinants, 2.21
- Shine-Dalgarno sequence, 15.57
- in two-hybrid system of protein-protein interaction reporter plasmids, 18.17, 18.22, 18.24
- lacZ* $\Delta$ M15
  - $\lambda$  propagation and, 2.29
  - M13 vectors and, 3.10, 3.12–3.13
- Ladders. *See* Molecular-weight markers
- LALIGN program, A11.4
- LALIGN0 program, A11.4
- lamB* gene, 2.4, 11.62
  - glucose repression of, 2.35, 2.37
  - maltose induction of, 2.26
- lamB* receptor,  $\lambda$  adsorption to, 2.15
- $\lambda$ 2001, 2.20–2.22, A3.3
- $\lambda$  annealing buffer, A1.20
- $\lambda$  bacteriophage, 2.1–2.111. *See also* Cosmids;  $\lambda$  vectors
  - arm purification by sucrose density gradient, 2.71–2.75
    - ligation first method, 2.73
    - materials, 2.72
    - method, 2.73–2.75
  - concatemers, 2.68, 2.70
  - concentration of doubled-stranded DNA in solution, A6.5
  - DNA extraction
    - DNA concentration, calculating, 2.58
    - from large-scale cultures
      - using formamide, 2.59–2.60
      - using proteinase K and SDS, 2.56–2.58
    - particle purification for, 2.54–2.55
  - DNA purification, 5.71–5.73
    - from liquid cultures, 2.106–2.108
    - miscellaneous methods, 2.104
    - from plate lysates, 2.101–2.104
    - polysaccharide removal by precipitation with CTAB, 2.105
  - exonuclease, 11.121, A4.49
  - expression vectors, 4.83
  - genomic organization, 2.3–2.4, 2.5
  - infection phases
    - late lytic
      - DNA packaging, 2.14–2.15
      - DNA replication, 2.11
      - lysis, 2.15
      - particles, assembly of, 2.14–2.15
      - recombinant systems, 2.11–2.13
      - transcription, late, 2.14
    - lysis/lysogeny crossroads, 2.7–2.11
    - lysogeny, 2.15–2.18
      - integration, 2.16
      - transcription of prophage genes, 2.17–2.18
    - temperature and, 2.4, 2.18
    - uncommitted phase
      - adsorption, 2.4
      - transcription, delayed early, 2.6–2.7
      - transcription, immediate early, 2.6
  - in vitro packaging, 11.113–11.114
  - libraries, screening by PCR, 8.76
  - map, physical and genomic, 2.5
  - molecular-weight marker ladder, 5.59
  - overview of, 2.2–2.3
  - P2 prophage restriction of growth, 2.20
  - plaques
    - $\beta$ -galactosidase screening, 2.31
    - macroplaques, 2.31
    - number per dish, table of, 2.92
    - picking, 2.32–2.33
    - screening by PCR, 8.74–8.75
    - size, 2.30
    - smearing, 2.30
    - storage, 2.33
      - long-term, 2.36
  - plating, 2.23–2.31
    - $\beta$ -galactosidase plaque-assay, 2.30
    - macroplaque protocol, 2.31
    - protocol
      - bacteria preparation, 2.26–2.27
      - infection of plating bacteria, 2.27–2.30
      - materials, 2.25–2.26
    - promoters, 2.5–2.8, 2.14, 2.17, 15.4, 15.25–15.29
    - propagation, *E. coli* strains for, 2.28–2.29
    - purification, particle
      - centrifugation through glycerol step gradient, 2.52–2.53
      - isopycnic centrifugation through CsCl gradient, 2.47–2.51
      - pelletting/centrifugation, 2.54–2.55
    - repressor, 2.8, 2.10–2.11, 2.14, 2.17–2.18, 2.21, 2.23
      - inactivation, 14.7
      - in positive selection vectors, 1.12
      - temperature-sensitive, 1.13, 14.37–14.38, 14.40, 14.47, 15.4, 15.25, 15.27–15.28
    - shotgun sequencing protocol, 12.10–12.22
    - specialized transduction, 2.17
    - stock preparation
      - DNA content, assaying by gel electrophoresis, 2.45–2.46
    - large-scale
      - infection at high multiplicity, 2.42
      - infection at low multiplicity, 2.40–2.42
      - liquid culture, small-scale, 2.38–2.39
      - plate lysis and elution, 2.34–2.36
      - plate lysis and scraping, 2.37
      - precipitation of particles, 2.43–2.44
      - yield, factors influencing, 2.35, 2.37
    - structure of, 2.3
      - terminase, 2.15, 4.5, 4.30
  - $\lambda$ elI, 11.109
  - $\lambda$  DE3, 15.20–15.21
  - $\lambda$  EMBL vectors, A3.3
  - $\lambda$ DASH vector, 2.20–2.22, A3.3
  - $\lambda$ ExCell vector
    - in commercial kits for cDNA synthesis, 11.108
    - expression cloning, 11.72
  - $\lambda$ EXlox vector, 4.83
  - $\lambda$ FIX vector, 2.22, A3.3
  - $\lambda$ gt10 vector, 11.25, A3.3
    - amplification of libraries constructed in, 11.64–11.65
      - cDNA library construction in, 11.59–11.60
      - in commercial kits for cDNA synthesis, 11.108
      - overview, 11.111
      - plaque formation with, 11.62
      - primers for, 8.116
  - $\lambda$ gt11 vector, 2.22–2.23, 11.25, 11.27
    - amplification of libraries constructed in, 11.65–11.66
      - cDNA library construction in, 11.59
      - in commercial kits for cDNA synthesis, 11.108
      - E. coli* strain for amplification of cDNA libraries, 11.66
      - fusion protein expression in, 14.37, 14.39, 14.43, 14.45
      - immunological screening of libraries in, 14.2
      - overview, 11.111
      - plaque formation with, 11.62
      - primers for, 8.116
  - $\lambda$ gt11-23 vector, A3.3
  - $\lambda$ gt18-23 vector
    - cDNA library construction in, 11.59
    - E. coli* strain for amplification of cDNA libraries, 11.66
    - expression libraries and, 14.47–14.48
    - fusion protein expression in, 14.37
    - immunological screening of libraries in, 14.2
    - plaque formation with, 11.62
  - $\lambda$ gt18-23 vectors, 2.22–2.23
  - $\lambda$ gt20 vector, 11.66
  - $\lambda$ gt22 vector, 11.66
  - $\lambda$ ORF8 vector and expression libraries, 14.47–14.48
  - $\lambda$  p<sub>L</sub> promoter
    - for expression of cloned genes in *E. coli*, 15.4, 15.25–15.29
      - large-scale expression, 15.29
      - materials for, 15.26–15.27
      - optimization, 15.28
      - overview, 15.25
      - protocol, 15.27–15.29
      - tryptophan-inducible expression, 15.26, 15.28–15.29
    - vectors containing, 15.25
  - $\lambda$  p<sub>R</sub> promoter, 14.14
  - $\lambda$ TriplEx2 in commercial kits for cDNA synthesis, 11.108
  - $\lambda$  vectors. *See also specific vectors*
    - amber mutations, A7.5
    - amplification of libraries constructed in, 11.64–11.66
      - cDNA cloning, 11.17–11.18, 11.21–11.26
        - $\lambda$ gt10/ $\lambda$ gt11, 11.25, 11.27
        - $\lambda$ ZAP, 11.22
        - $\lambda$ ZAP Express, 11.22–11.25
        - $\lambda$ ZAPII, 11.22–11.23
        - $\lambda$ ZipLox, 11.25–11.26
      - library construction, 11.59–11.61
    - choosing, 2.20
    - cloning in, flow chart for, 2.24
    - Cre-loxP in, 4.83
    - dephosphorylation of arms, 11.59
    - DNA preparation
      - alkaline phosphatase treatment, 2.68–2.70
      - arm purification, 2.71–2.75
      - cleaved with single restriction enzyme, 2.61–2.63
      - cleaved with two restriction enzyme, 2.64–2.67
      - digestion efficiency, monitoring, 2.66–2.67
    - E. coli* strain preferences for plating, 11.62
    - expression vectors, 2.12–2.23
      - immunological screening of libraries in, 14.2
    - immunity vectors, 2.21
    - insertion vectors, 2.19, 2.21
    - libraries
      - amplification, 2.87–2.89
      - construction, 2.20, 11.51–11.61
      - expression libraries, screening, 14.4–14.13, 14.47–14.49
        - bacteriophage recovery from filters, 14.11
        - chemiluminescent screening, 14.11–14.12
        - chromogenic screening, 14.9–14.11
        - for DNA-binding proteins, 14.31–14.36
        - duplicate filter preparation, 14.8
        - eukaryotic, 11.72–11.73, 11.76–11.78
        - expression induction on filters, 14.7–14.8
        - fusion protein production, 14.37–14.46
        - materials for, 14.4–14.6
        - plating bacteriophage, 14.7
        - protein-expressing plaques, 14.8–14.12
        - radiochemical screening, 14.9
        - troubleshooting, 14.13
        - validation of clones, 14.12
      - ligation of  $\lambda$  arms to insert fragments, 2.84–2.86
      - partial digestion of DNA for, 2.76–2.83
      - screening by PCR, 2.33, 8.76
    - markers for selection or screening, table of, 2.21
    - overview, 2.18–2.23
    - packaging, 2.63, 2.65, 2.67, 2.84–2.86, 2.110–2.111
      - amplification of genomic libraries, 2.87–2.89
      - cosmids, 4.21–4.22
      - direct screening, 2.87
      - efficiency, 2.67–2.68, 2.110

- λ* vectors (continued)
- preparation methods, 2.111
  - partial digestion of DNA for
    - pilot reaction, 2.76–2.79
    - preparative reaction, 2.80–2.83
  - primers for cloning in, 8.116
  - propagation, *E. coli* strains for, 2.28–2.29
  - recombinants
    - DNA miniprep from liquid cultures, 2.106–2.107
    - DNA miniprep from plate lysates, 2.101–2.104
    - PCR analysis, 2.105
  - replacement vectors, 2.19–2.22, 2.64–2.65
    - ligation of arms to genomic DNA fragments, 2.84–2.86
  - screening by hybridization
    - DNA transfer to filters, 2.90–2.95
    - hybridization protocol, 2.96–2.100
    - size of DNA inserted, 2.85
  - subcloning YAC DNAs into, 4.64
  - table of, A3.3
  - templates for DNA sequencing, 12.29
- λ*YES vectors, 4.83
- λ*ZAP vector, 2.101, 11.22
- amplification of libraries constructed in, 11.65–11.66
  - cDNA library construction in, 11.59
  - E. coli* strain for amplification of cDNA libraries, 11.66
  - expression libraries, 14.47–14.48
  - fusion protein expression in, 14.37, 14.47
  - immunological screening of libraries in, 14.2
  - plaque formation with, 11.62
- λ*ZAP-CMV vector
- in commercial kits for cDNA synthesis, 11.108
  - expression cloning, 11.72
- λ*ZAP Express vector, 11.22–11.25, A3.3
- E. coli* strain for amplification of cDNA libraries, 11.66
  - expression cloning, 11.72
  - expression libraries, 14.47–14.48
  - immunological screening of libraries in, 14.2
- λ*ZAPII vector, 11.22, 11.23
- E. coli* strain for amplification of cDNA libraries, 11.66
  - expression libraries and, 14.47–14.48
  - immunological screening of libraries in, 14.2
  - plaque formation with, 11.62
- λ*ZipLox vector, 2.101, 4.83, 11.25–11.26, A3.3
- amplification of libraries constructed in, 11.65–11.66
  - cDNA library construction in, 11.59
  - in commercial kits for cDNA synthesis, 11.108
  - E. coli* strain for amplification of cDNA libraries, 11.66
  - expression cloning, 11.72
  - expression libraries, 14.47–14.48
  - fusion protein expression in, 14.37, 14.47
  - plaque formation with, 11.62
- Langmuir-binding model, 18.112–18.113
- Lanthanum oxybromide intensifying screens, A9.11
- Large DNA molecules. *See also* Chromosomal DNA;
- Genomic DNA
  - CHEF gels, 5.79–5.82
  - cloning products and services, 4.86
  - concentration by dialysis on sucrose bed, 6.15
  - concentration measurement of, 6.11, 6.15
  - fragmentation by hydrodynamic shearing, 2.76, 6.3
  - gel electrophoresis, difficulty entering the gel during, 6.15
  - isolation from mammalian cells
    - by spooling, 6.16–6.18
    - using formamide, 6.13–6.15
    - using proteinase K and phenol, 6.4–6.11
  - minimizing damage to, 2.110
  - partial digestion for genomic libraries
    - checking, 2.79
    - methods, 2.76
    - pilot reactions, 2.76–2.79
    - preparative reactions, 2.80–2.83
  - pulsed-field gel electrophoresis
    - recovery from gels, 5.83–5.88
    - separation by, 5.2, 5.55–5.56, 5.59–5.60
  - recovery
    - from low-melting point agarose, 5.33–5.35
    - from pulsed-field gel electrophoresis gels, 5.83–5.88
    - spermine/spermidine use, 5.86
  - sucrose gradients, size fractionation through, 2.82–2.83
  - transfection of eukaryotic cells, calcium-phosphate-mediated, 16.21–16.24
- N*-lauroylsarcosine
- for solubilization of glutathione *S*-transferase fusion proteins, 15.38–15.39
  - for solubilization of inclusion bodies, 15.54
- LB freezing buffer, A1.20, A2.6
- LB medium recipe, A2.2
- L buffer, 5.61, 5.64, 5.66–5.67
- Lck, 18.7
- LE392 *E. coli* strain, A7.5
- genotype, A3.8
  - λ* vector propagation, 2.28
- LEU2*, 18.35, 18.37
- Leucine
- codon usage, A7.3
  - nomenclature, A7.7
  - properties, table of, A7.9
- Leucine zipper, 11.33
- Leupeptin, 17.25, 18.67, A5.1
- Levan sucrose, 4.37
- LexA, 18.14
- bait-LexA fusion protein, 18.17–18.29
  - fusion plasmids, 18.18
- lexAop-lacA* reporter gene, 18.17
- lexAop-lacZ* reporter, 18.30, 18.32, 18.36
- lexAop-LEU2*, 18.17, 18.22, 18.36
- LFASTA program, A11.4
- LC190 *E. coli* strain genotype, A3.8
- L-histidinol, 17.61, 17.63–17.67, 17.69
- Libraries. *See also* cDNA libraries; Expression libraries, screening; Genomic libraries; *λ* vectors, libraries
- arrayed libraries, 4.8, 4.39, 4.50, 4.61, 9.90
  - screening for related genes using MOPAC, 8.68
- LiCl. *See* Lithium chloride
- LIC-PCR. *See* Ligation-independent cloning
- lig* gene, 1.159
- Ligase, DNA, A4.30–A4.34. *See also* Ligation reactions
- bacteriophage T4, 1.157–1.158, 3.37, A4.31–A4.32, A4.34
  - activity of, A4.31
  - blunt-end ligation, A4.32
  - cohesive termini/nick ligation, A4.32
  - linker/adaptor attachment to cDNA, 11.54
  - uses, list of, A4.31
- E. coli*, 1.158–1.159, A4.33
- in cDNA second strand synthesis, 11.43, 11.45–11.46
- λ*, 2.3
- overview, 1.157
  - table of properties, 1.158
  - thermostable, 1.158, A4.34
  - units of activity, 1.159
- Ligase, T4 RNA ligase, 1.157
- Ligase amplification reaction, 1.157, 1.159
- Ligation buffer with polyethylene glycol, 5.71
- Ligation reactions
- adaptor attachment to protruding termini, 1.89
  - in BAL 31 mutagenesis protocol, 13.66
- cDNA
- into *λ* vectors, 11.61
  - linker/adaptor attachment to, 11.51–11.55
  - into plasmid vectors, 11.63
- in circular mutagenesis protocol, 13.24
- condensing and crowding agents, 1.23–1.24, 1.152, 1.157–1.159
- in cosmid vectors, 4.15, 4.21–4.22
- dephosphorylation of plasmid DNA and, 1.93
- in directional cloning procedures, 1.84–1.85, 1.87
- DNA fragments with blunt ends, 1.22–1.24, 1.90–1.92
- DNA fragments with protruding ends, 1.20–1.21
- in exonuclease III mutagenesis protocol, 13.61
- fragment ratios, 1.21
- inhibition
  - by agarose, 5.18, 5.29
  - by dATP, 1.85
  - by TBE buffer, 5.30
- in inverse PCR protocol, 8.84
- λ* arms to insert genomic DNA, 2.84–2.86
- linker addition to blunt-ended DNA, 1.99–1.102
- in low-melting-temperature agarose, 1.103–1.104, 5.29
- M13 vectors, 3.36–3.37
- oligonucleotide ligation assay (OLA), 13.96
- PCR product cloning
  - blunt-end cloning, 8.33–8.34
  - controls, inclusion of, 8.41
  - directional cloning, 8.40
  - T vector cloning, 8.36
- ratio of components, 1.90–1.91
- restriction enzyme inclusion into, 1.100
- in shotgun sequencing protocol, 12.15, 12.18–12.19, 12.25
- in USE mutagenesis, 13.28
- Ligation-independent cloning, 11.121–11.124
- LightCycler, 8.95
- Lightning Plus intensifying screens, A9.11
- Line elements, 11.95
- LINE (long interspersed nuclear element) sequences, 4.75
- Linear amplification DNA sequencing. *See* Cycle DNA sequencing
- Linear polyacrylamide as carrier in ethanol precipitation of DNA, A8.13
- Linker kinase buffer, A1.11
- Linkers. *See also* Adaptors
- addition to blunt-ended DNA, 1.98–1.102
  - cDNA cloning, 11.20–11.21, 11.51–11.55
  - checking reaction products, 1.102
  - in direct selection of cDNAs protocol, 11.102
  - ligation, 1.99–1.102
  - phosphorylation of, 1.99, 1.101
  - sequences, table of, 1.99
- Linker-scanning mutagenesis, 13.75–13.77
- LipofectAce, 16.5, 16.11
- Lipofectamine, 16.5, 16.11
- Lipofectin [N[1-(2,3-dioleoyloxypropyl)]-*n,n,n*-trimethylammonium chloride [DOTMA]], 16.5, 16.7–16.8, 16.11–16.12
- Lipofection, 11.85, 16.3, 16.7–16.13
- chemistry of, 16.50
  - lipids used in, 16.8, 16.11, 16.51
  - materials for, 16.7–16.11
  - optimizing, 16.51
  - overview of, 16.50–16.51
  - protocol, 16.12–16.13
- Liposomes formation by sonication, 16.7
- LipoTaxi, 16.5
- Liquid chromatography-tandem MS (LC-MS/MS), 18.66
- Liquid Gold, 1.105
- Liquid media for *E. coli*, A2.2–A2.4

- Liquid nitrogen  
 for tissue preparation in RNA purification protocols, 7.10–7.11  
 in tissue sample homogenization, 6.7–6.8
- Lithium chloride (LiCl), 1.59, A1.27  
 in column loading buffers, 7.16  
 in ethanol precipitation of nucleic acids, A8.12  
 precipitation of contaminating nucleic acid fragments, 1.59, 1.82–1.83  
 precipitation of large RNAs with, A8.16  
 in transcriptional run-on assay protocol, 17.28
- LMIT elution buffer, 5.30
- Loading buffers. *See* Gel-loading buffers
- Locus Link database, A10.15
- lon*, 2.7, 11.66, 14.6, 14.39, 14.47–14.48, 15.19, 15.58
- Long PCR buffer, 8.78, 13.21
- Low-melting-temperature agarose. *See* Agarose, low-melting-temperature
- loxP*. *See also* Cre-*loxP* recombination system  
 in BAC vectors, 4.3  
 in  $\lambda$  vectors, 4.83  
 in P1 vectors, 4.4–4.5, 4.37, 4.82–4.83  
 sequence, 4.82–4.83
- luc* gene, 17.96
- Luciferase, 17.42–17.47, 17.96  
 bacterial, A9.23–A9.24  
 dual reporter assay system, 17.96  
 firefly, A9.21–A9.23  
 assays for, A9.22–A9.23  
 liquid scintillation spectroscopy, A9.22–A9.23  
 luminometry, A9.22  
 photographic/X-ray film, A9.23  
 properties of, A9.21–A9.22  
 as reporter molecule, A9.23  
 peroxisome targeting of, 17.96  
 reaction catalyzed by, 17.96  
 as reporter gene, 17.30–17.31, 17.42–17.47  
 advantages of, 17.42  
 luminometer measurements from 96-well plates, 17.47  
 materials for, 17.44  
 methods, 17.45–17.47  
 optimizing measurement, 17.45  
 pGL3 vectors, 17.43  
 scintillation counting protocol, 17.46  
 as transfection-positive control, 16.4
- Luciferase assay buffer, 17.44
- Lucigenin, structure of, A9.17
- Lumi-Gal, 17.50
- Lumigen-PPD, 9.79
- Luminol, 9.79, 14.11, 14.21  
 in enzyme assays, A9.19–A9.20  
 horseradish peroxidase and, A9.35–A9.37  
 as immunoassay label, A9.18  
 structure of, A9.16
- Luminometers, 17.42, 17.45–17.47  
 bioluminescence and, A9.21–A9.22  
 chemiluminescence and, A9.20
- luxA* gene, A9.23–A9.24
- luxB* gene, A9.23–A9.24
- UXI-Blue MRF *E. coli* strain,  $\lambda$  vector propagation in, 2.28
- Lysine  
 codon usage, A7.3  
 properties, table of, A7.9
- Lysis buffers  
 Alkaline lysis solutions I, II and III, 1.32–1.33, 1.35–1.36, 1.38, 1.40, 3.24, 12.31, A1.16  
 for DNA isolation from mammalian cells grown in microtiter plates, 6.19  
 for DNase I hypersensitivity mapping, 17.19  
 extraction/lysis buffers, A1.16  
 in genomic DNA isolation from mouse tails, 6.24–6.26  
 for mammalian DNA isolation, 6.4, 6.6–6.7, 6.9  
 PCR lysis solution, 6.22  
 for rapid isolation of mammalian DNA, 6.28–6.29  
 for rapid isolation of yeast DNA, 6.31–6.32  
 red blood cells, 6.28–6.29  
 in reporter assay protocols, 17.36, 17.38  
 in screening expression library protocol, 14.15–14.18  
 SNET, 6.24–6.25  
 in transcriptional run-on assay protocol, 17.24  
 yeast lysis buffer, 5.66
- Lysozyme extraction buffer, 14.38
- Lysogeny  
 induction, 2.9  
 in  $\lambda$ , 2.3, 2.9–2.11, 2.15–2.18
- Lysozyme, A1.8, A4.51  
 for cell lysis prior to affinity chromatography, 15.38, 15.46  
 discovery of, 1.153  
 in *E. coli* lysate preparation for affinity chromatography, 14.29  
 inhibition of T7 RNA polymerase, 9.88, 15.21, 15.24  
 in M13 RF DNA preparation, 3.24  
 overview, 1.153  
 in plasmid DNA preparation protocols  
 alkaline lysis with SDS, 1.33, 1.36  
 boiling lysis, 1.43–1.45, 1.49  
 lysis with SDS, 1.57  
 in washing solution for inclusion bodies, 15.10
- Lyticase, 5.66–5.67, A1.8
- yeast cell wall digestion, 4.60
- M9 medium recipe, A2.2
- M13 bacteriophage, 1.11, 3.1–3.49. *See also* M13 vectors  
 adsorption to sex pili, 3.5  
 DNA capacity of, 3.7  
 DNA preparation  
 double-stranded (replicative form), 3.23–3.25  
 large-scale, 3.30–3.33  
 single-stranded, 3.26–3.29  
 uracil-substituted DNA, 13.11–13.14  
 DNA purification, 12.21–12.23  
 blunt-ended, dephosphorylated DNA for shotgun cloning, 12.24  
 small numbers of single-stranded templates, 12.23  
 genetic map of, 3.3  
 growing in liquid culture, 3.20–3.22  
 morphogenesis, 3.5–3.6  
 phage display, 18.3  
 plaques  
 picking, 3.22, 12.21  
 type, 3.2, 3.17  
 plating, 3.17–3.19  
 precipitation with polyethylene glycol, 3.26–3.28  
 proteins encoded, 3.2–3.7  
 functions of, 3.4  
 replication, 3.2, 3.5–3.7  
 site-specific mutagenesis, 8.42  
 structural model of, 3.7  
 transcription, 3.5  
 uracil-substituted DNA, preparation of, 13.11–13.14
- M13 vectors, 3.8–3.16, A3.5  
 analysis of clones, 3.39–3.41  
 screening by hybridization, 3.41  
 size analysis by electrophoresis, 3.39–3.41  
 bacterial host for, 3.10–3.16  
 cloning problems, strain-dependent, 3.11, 3.16  
 F plasmid, maintaining, 3.11  
 markers, 3.10–3.11  
 strain, choosing and maintaining, 3.11–3.16  
 table of, 3.12–3.13
- cloning  
 locations  
 gene X, 3.9–3.10  
 large intergenic region, 3.9  
 multiple cloning sites, table of, 3.14  
 small intergenic region, 3.9  
 materials, 3.35–3.36  
 methods  
 dephosphorylation of vector DNA, 3.34  
 forced (directional cloning), 3.34  
 ligation of insert into linearized vector, 3.34  
 protocol, 3.36–3.38  
 transformation reactions, 3.37–3.38  
 deletions and rearrangements, limiting, 3.33–3.34, 3.49  
 growth times, 3.49  
 history of, 3.8  
 insert size, 3.33  
 nested deletion mutant set creating, 13.57, 13.59–13.61  
 oligonucleotide-directed mutagenesis protocol, 13.15–13.18  
 overview, 3.8–3.10  
 phagemids, 3.42–3.49  
 primers for cloning sites in, 8.115  
 screening clones for site-directed mutagenesis, 13.40–13.46  
 in shotgun sequencing protocol, 12.19–12.25  
 dephosphorylated, blunt-ended DNA preparation, 12.24  
 DNA purification, 12.21–12.24  
 growth in 96-tube format, 12.19–12.21  
 single numbers of templates, preparing, 12.23  
 test ligations, 12.25  
 subcloning YAC DNAs into, 4.64
- M13-100 vector, 3.9–3.10
- M13K07 vector, 3.42, 3.44–3.47, 18.116
- M13KE vector, 18.118, 18.120
- M13mp series vectors, 3.8–3.9, 3.14
- M5219 *E. coli* strain, 15.4, 15.25, 15.27, A3.8
- MACAW (Multiple Alignment construction and Analysis Workbench) program, A11.7
- Macroplaque,  $\lambda$ , 2.31
- MaeI* cleavage of 7-deaza-dGTP modified DNA, 8.60
- Magic Mini-preps, 12.27
- Magnesium chloride  
 MgCl<sub>2</sub>·6H<sub>2</sub>O solution, A1.27  
 MgCl<sub>2</sub>·CaCl<sub>2</sub> solution, A1.21  
 in Sequenase reaction buffer, 12.33
- Magnesium ions  
 DNase I and, 17.6, 17.10–17.11, 17.75, A4.40–A4.41  
 exonuclease III and, 13.73  
 inhibition of *EcoRI* methylase by, 11.48  
 in M13 growth media, 12.21, 12.23  
 in PCRs, 8.5–8.6, 8.21, 8.110  
 PEG stimulation of DNA ligation and, 1.152
- Magnesium sulfate (MgSO<sub>4</sub>), A1.27
- Magnetic beads  
 overview, 11.118–11.120  
 streptavidin-coated, 7.20  
 uses for, table of, 11.120
- MalE, 15.7, 15.40  
 affinity purification of fusion proteins, 15.4  
 soluble fusion protein production, 15.9
- Maltoporin,  $\lambda$  adsorption to, 2.4
- Maltose, A1.27, A2.8  
 induction of *lamB* gene, 11.62  
 for  $\lambda$  growth, 2.26  
 in  $\lambda$  media, 11.62
- Maltose-binding fusion proteins, 14.47, 15.26  
 affinity chromatography purification, 15.6, 15.40–15.43

- Mammalian cells. *See also* COS cells  
 codon usage, 10.7  
 Cre-loxP site-specific integration/excision of transgenes, 4.84–4.85  
 DNA isolation  
   concentration measurement  
     by fluorometry, 6.12  
     by spectrophotometry, 6.11, 6.15  
   from microtiter plate cultures, 6.19–6.22  
   from mouse tails  
     harvesting of tails, 6.24  
     one-tube isolation, 6.26–6.27  
     from paraffin blocks, 6.27  
     protocol, 6.23–6.25  
     sample storage, 6.24  
   without extraction by organic solvents, 6.26  
   from paraffin blocks, 6.27  
   for pulsed-field gel electrophoresis, 5.61–5.64  
   rapid isolation protocol, 6.28–6.30  
   by spooling, 6.16–6.18  
   using formamide, 6.13–6.15  
   using proteinase K and phenol, 6.4–6.11  
     100–150-kb DNA size, 6.10, 6.11  
     150–200-kb DNA size, 6.10–6.11  
     lysis of blood cells, 6.8–6.9  
     lysis of monolayer cells, 6.6  
     lysis of suspension cells, 6.7  
     lysis of tissue samples, 6.7–6.8  
 expression in. *See* Expression in mammalian cells  
 glycerol and efficiency of transient expression and transformation, 13.90  
 nuclear extract preparation from, 17.8–17.10, 17.26–17.27  
 RNA isolation from, 7.7, 7.11  
   poly(A)<sup>+</sup> selection by batch chromatography, 7.18–7.19  
   poly(A)<sup>+</sup> selection by oligo(dT) chromatography, 7.13–7.17  
 transfection, 16.1–16.57  
   biolistics, 16.3, 16.37–16.41  
     materials for, 16.38–16.39  
     method, 16.39–16.41  
     particle types, 16.37  
     variables, 16.37  
   calcium-phosphate-mediated, 16.3, 16.14–16.26, 16.52–16.53  
     of adherent cells, 16.25  
     of cells growing in suspension, 16.26  
     chloroquine treatment, 16.14, 16.17, 16.52  
     cotransformation, 16.24  
     efficiency, factors affecting, 16.52  
     with genomic DNA, 16.21–16.24  
     glycerol shock, 16.14, 16.17, 16.52  
     high efficiency, 16.19  
     mutation prevalence, 16.53  
     with plasmid DNA, 16.14–16.20  
     sodium butyrate, 16.14, 16.17–16.18  
   cell line variation, 16.57  
   controls, 16.4–16.5  
     for stable expression, 16.4–16.5  
     for transient expression, 16.4  
   cotransformation, 16.24, 16.47  
   by DEAE-dextran, 16.3, 16.27–16.32  
     calcium phosphate method compared, 16.27  
     cell viability, increasing, 16.32  
     facilitators of, 16.28  
     kits, 16.30  
     materials for, 16.29–16.30  
     mechanism of action, 16.27  
     method, 16.30–16.31  
     mutation prevalence, 16.28, 16.53  
     variables, 16.27–16.28  
   electroporation, 16.3, 16.33–16.36, 16.54–16.57  
     efficiency, factors influencing, 16.33–16.34, 16.57  
     materials for, 16.34–16.35  
     method, 16.35–16.36  
   by lipofection, 16.3, 16.7–16.13  
     chemistry of, 16.50  
     lipids used in, 16.8, 16.11, 16.51  
     materials for, 16.7–16.11  
     optimizing, 16.51  
     overview of, 16.50–16.51  
     protocol, 16.12–16.13  
   methods, summary of, 16.3  
   polybrene, 16.3, 16.43–16.46  
   stable, selective agents for, 16.48–16.49  
   tetracycline regulation of inducible gene expression and, 17.60–17.70  
   transient vs. stable, 16.2  
   transformation by YACs, 4.63–4.64  
   trypsinization, 16.12  
   vector systems for, 11.72  
 Mammalian Transfection Kit Primary ENHANCER Reagent, 16.5  
 Mammalian vectors, A3.3–A3.4  
 Manganese chloride (MnCl<sub>2</sub>) in Sequenase reaction buffer, 12.43  
 Manganese ions  
   DNase I and, A4.40–A4.41  
   exonuclease III and, 13.73  
 Mannose phosphotransferase, 2.4  
 Mapping  
   DNase I hypersensitivity sites, 17.18–17.22  
   identical-by-descent (IBD), A10.17–A10.18  
   influence of methylation on DNA mapping, A4.6–A4.9  
   mutations with RNase A, A4.39  
   protein-binding sites on DNA  
     by DNase I footprinting, 17.4–17.11  
     by hydroxyl radical footprinting, 17.12  
 MAR-Finder program, A11.13  
 Markers  
   chemiluminescent, 1.140, 2.98–2.99  
   migration rate of dyes through polyacrylamide gels, 12.89  
   molecular-weight. *See* Molecular-weight markers  
 Mass map, 18.66  
 Mass spectrometry, 18.3, 18.62, 18.66  
 MAST (Motif Alignment and Search Tool) program, A11.9–A11.10  
 MAT $\alpha$ , 18.22  
 Matrix-assisted laser desorption-time of flight (MALDI-TOF) mass spectrometry, 18.66  
 Maxam-Gilbert sequencing. *See* DNA sequencing, chemical method  
 MAXIscript, 9.32  
 MBM7014.5 *E. coli* strain  
   genotype, A3.8  
    $\lambda$  vector propagation, 2.28  
 Mbol  
   *dam* methylation and, 13.87, A4.3  
   genomic DNA digestion, 4.11, 4.15, 4.20  
 Mbol methylase, A4.7  
 MbolII, A4.9  
   *dam* methylation and, 13.87, A4.3  
   methylase, A4.7  
   for T vector creation, 8.35  
 MBS Mammalian transfection kit, 16.5  
 MC1061 *E. coli* strain, 1.118  
   genotype, A3.8  
    $\lambda$  vector propagation, 2.28  
   transformation by Hanahan method, 1.106  
*mcv* restriction system, 11.21, 11.48  
 in vitro  $\lambda$  packaging and, 2.111, 11.113  
*merA*, 1.15, A4.4–A4.5  
    $\lambda$  propagation and, 2.28  
   M13 vectors and, 3.11, 3.13  
*merB*, A4.4  
    $\lambda$  propagation and, 2.28–2.29  
 MDE (mutation detection enhancement), 13.51, 13.53, 13.56  
 Media, A2.1–A2.2. *See also specific media; specific protocols*  
   agar/agarose containing, A2.5  
   antibiotics, A2.6–A2.7  
   bacteriophage  $\lambda$ -related, A2.8  
   liquid media for *E. coli*, A2.2–A2.4  
   storage, A2.6  
   yeast propagation and selection, A2.9–A2.11  
 Medline, 1.14  
 Megaprimer method of mutagenesis, 13.8–13.10, 13.31–13.35  
 MEGAscript, 9.32  
 Melting temperature  
   calculating, 10.2–10.4, 10.47–10.48  
   guessers and, 10.8  
   inosine and, 10.9–10.10  
   of megaprimers in mutagenesis protocol, 13.31–13.32  
   in quaternary alkylammonium salts, 10.6  
 Membrane Expression arrays, A10.9  
 MEME (Multiple Expectation Maximization for Motif Elicitation) program, A11.8–A11.9  
 MERMAID, 10.49  
 MES (2-[*N*-morpholino]ethane-sulfonic acid), 1.105, 1.107  
 Metal chelate affinity chromatography, 15.44–15.48  
 Metallothionein promoter, 16.5  
 Methanol  
   methanol/KOH solution, A1.20  
   for polyacrylamide gel fixation, 12.90–12.92  
 Methionine  
   cleavage by cyanogen bromide, 15.6, 15.8  
   codon usage, A7.3  
   nomenclature, A7.7  
   properties, table of, A7.9  
   in pulse-chase experiments, 15.18–15.19  
 Methotrexate (MTX), 16.47, 16.49, A2.7  
 Methylated DNA, *E. coli* strains for propagation of, 1.15–1.16  
 Methylation, 11.21, A4.3–A4.9  
   of cDNA, 11.48–11.50  
     5' methyldeoxycytosine incorporation, 11.48  
     EcoRI, 11.48–11.50  
   in chemical sequencing protocol, 12.61–12.65  
   *dam* methyltransferase, A4.3  
   *dcm* methyltransferase, A4.3–A4.4  
   by dimethylsulfate, 12.5  
   DNA mapping, influence on, A4.6–A4.9  
   linker use and, 1.99  
   restriction site modification, A4.5–A4.9  
   restriction/modification systems, type I and type II, A4.4  
 Methylation interference assays, 12.63  
 Methylene blue, A9.4–A9.5  
   polyacrylamide gel staining, 5.47–5.48  
   staining of RNA on nylon membranes, 7.39  
 Methylmercuric hydroxide, 7.21–7.22, 11.9  
 4-Methylumbelliferyl- $\beta$ -D-galactoside (MUG), 17.50, 17.97–17.98  
 Met-MEME program, A11.9  
 5-Methylcytosine, 12.68, A4.4  
 MFOLD program, A11.14–A11.15  
 Mg<sup>2+</sup>. *See* Magnesium ions  
 Microarray, DNA. *See* DNA array technology  
 MicroArray Suite image analysis program, A10.13  
 Microconcentrator, 8.27–8.29, 8.58, 8.68, 12.106, A8.16–A8.17  
 Microcon concentrators, 8.27, 12.106, A8.16–A8.17  
 Microinjection of live cells, 18.88–18.89  
 MicroMax arrays, A10.9  
 Microscopy. *See* Fluorescence lifetime imaging microscopy  
 Microspheres. *See* Magnetic beads

- Microtiter plates  
 DNA isolation from mammalian cells grown in, 6.19–6.22  
 use in DNA sequencing protocols, 12.100
- Milk as blocking agent, A8.54
- Mineral oil  
 addition to PCRs, 8.22  
 removal from PCRs by chloroform extraction, 8.22
- Minigels, agarose, 5.13
- Minimal (M9) agar plates for M13 plating, 3.17–3.18
- Minimal medium for bacteria, 18.40
- MisMatch Detect II, 13.93
- Mismatch repair system, 13.88, 13.94
- Mitomycin C  
 induction of  $\lambda$  lysogen, 15.25  
 modes of action, A2.7
- Mixed oligonucleotide-primed amplification of cDNA (MOPAC), 8.66–8.71  
 analysis, 8.70–8.71  
 band-stab PCR and, 8.71  
 DNA template for, 8.68–8.70  
 materials for, 8.69  
 method, 8.70–8.71  
 primer design rules, 8.67–8.68  
 screening for related genes, 8.68  
 variations in protocol, 8.67
- MluI*  
 cleavage at end of DNA fragments, A6.4  
 genomic DNA mapping, 5.69  
 methylation, A4.7
- MLV (murine leukemia virus). *See* Moloney murine leukemia virus reverse transcriptase
- MM294 *E. coli* strain, 1.14–1.15, 1.25  
 genotype, A3.8  
 $\lambda$  vector propagation, 2.28  
 transformation by Hanahan method, 1.106
- $Mn^{2+}$  ions. *See* Manganese ions
- mob*, 1.146
- Mobility of DNA, electrical, 12.114
- Modeling, molecular, 18.3
- Modrich-Lehman unit of ligase activity, 1.159
- Molecular modeling, 18.3
- Molecular modeling database (MMDB), A11.22
- Molecular-weight markers, 5.10, 7.23, A6.4  
 $\lambda$  DNA concatamers, 5.59, 5.71–5.73  
 migration rate of dyes through polyacrylamide gels, 12.89  
 for pulsed-field gel electrophoresis, 5.59–5.60, 5.71–5.73  
 for RNA gels, 5.59–5.60, 5.71–5.73
- Moloney murine leukemia virus (Mo-MLV) reverse transcriptase, 11.109–11.110, A4.24–A4.25  
 in commercial kits for cDNA synthesis, 11.108  
 inhibition by sodium pyrophosphate, 11.46  
 RNA-dependent DNA polymerase, 8.48  
 RNase H, 11.38
- Mo-MLV. *See* Moloney murine leukemia virus reverse transcriptase
- Monoclonal antibodies in immunological probes, 11.33
- Monolayer cultures, lysis of cells growing in, 6.6
- Monophasic lysis reagents, 7.10–7.12
- MOPAC. *See* Mixed oligonucleotide-primed amplification of cDNA
- MOPS electrophoresis buffer, 7.32, A1.18
- MOPS salts, 15.31
- Mouse mammary tumor virus long terminal repeat promoter, 16.5
- Mouse tails, genomic DNA isolation from  
 harvesting of tails, 6.24  
 one-tube isolation, 6.26–6.27  
 from paraffin blocks, 6.27  
 protocol, 6.23–6.25  
 sample storage, 6.24  
 without extraction by organic solvents, 6.26
- Mouse-tail lysis buffer, 6.26
- Mowiol mounting medium, 18.87–18.88
- mp18/mp19, 8.115
- mRNA. *See also* Expression in mammalian cells; RNA  
 3'-RACE procedure and, 8.61  
 5'-RACE procedure and, 8.54–8.55, 8.58  
 cDNA cloning. *See* cDNA cloning  
 cDNA library construction  
 expression library, 11.70  
 from small numbers of cells, 11.112  
 cDNA preparation, 11.39–11.42  
 enrichment methods, 11.8–11.11  
 fractionation of cDNA, 11.9–11.10  
 fractionation of mRNA, 11.9  
 number of clones needed for library, 11.8  
 overview, 11.8–11.9  
 polysome purification, 11.10  
 subtractive cloning, 11.10–11.11  
 integrity of mRNA, 11.7–11.8, 11.39, 11.42  
 source of mRNA, 11.6–11.7  
 differential display-PCR, 8.96–8.106  
 differential expression, screening for, 9.89–9.91  
 eukaryotic  
 concentration, measurement  
 northern blots, 7.66  
 quantitative RT-PCR, 7.66  
 reassociation kinetics, 7.65–7.66  
 ribonuclease protection, 7.66  
 mapping  
 mung bean nuclease, 7.55  
 nuclease S1, 7.51–7.62  
 primer extension, 7.75–7.81  
 ribonuclease protection assays, 7.63–7.74  
 northern hybridization. *See* Northern hybridization  
 overview, 7.2  
 purification  
 acid phenol-guanidinium thiocyanate-chloroform extraction, 7.4–7.8  
 poly(A) selection by patch chromatography, 7.18–7.19  
 poly(A) selection by oligo(dT)-cellulose chromatography, 7.13–7.17  
 poly(A) selection by poly(U)-Sepharose chromatography, 7.15, 7.20  
 poly(A) selection by streptavidin-coated beads, 7.20  
 simultaneous preparation with DNA and protein, 7.9–7.12  
 RNases and, 7.2  
 isolation from COS-7 cells, 11.87–11.88  
 mapping  
 3'-RACE, 8.61–8.62  
 5'-RACE, 8.54–8.55  
 for microarray hybridization, A10.10, A10.13–A10.14  
 reverse transcription by RT-PCR, 8.46–8.53  
 screening with subtracted cDNA probes, 11.29–11.31  
 splicing, 18.123–18.124  
 stability and G+C content, A7.2
- mrr*, 1.15–1.16, A4.4  
 in vitro  $\lambda$  packaging and, 2.111, 11.113  
 M13 vectors and, 3.11, 3.13
- MS2 phage, 18.11
- MSA program, A11.6
- MseI*, A4.9
- MspI* in site-directed mutagenesis protocol, 13.84
- MspI* methylase, A4.5, A4.7
- MTX. *See* Methotrexate
- MultAlin program, A11.8
- Multichannel pipettor, 6.20
- Multiplex PCR, 8.5, 8.107  
 nonspecific amplification, 8.107  
 optimizing, 8.107
- MultiPROBE II (Packard), A10.5
- Mung bean nuclease, 7.55, 7.86, A4.47  
 in exonuclease III mutagenesis protocol, 13.57, 13.74–13.75  
 overview of, 7.87
- MunI* cleavage at end of DNA fragments, A6.4
- Munich 13. *See* M13
- Muristerone A, 17.71
- Muta-gene in vitro mutagenesis kit, 13.89
- Mutagenesis  
 alanine-scanning, 13.81  
 BAL 31 use, 13.62–13.67  
 bisulfite-mediated, A4.41  
 cassette, 13.79  
 chemical, 13.78–13.79  
 circular, 13.19–13.25  
 of coding sequences, 13.2–13.4  
 oligonucleotide-directed, 13.3–13.7  
 saturation mutagenesis, 13.2–13.3  
 scanning mutagenesis, 13.3  
 deletion mutants  
 bidirectional sets, 13.62–13.67  
 nested sets, 13.57–13.61, 13.74–13.75  
 exonuclease III use, 13.57–13.61  
 in vitro, 12.102, 13.19–13.25  
 kits for, 13.89  
 Kunkel method, 13.84  
 linker-scanning, 13.75–13.77  
 misincorporation, 13.80  
 oligonucleotide-directed  
 elimination of unique restriction site, 13.26–13.30  
 oligonucleotide design guidelines, 13.82  
 overview of, 13.3–13.7  
 design, 13.4  
 diagram of scheme, 13.5  
 history of, 13.4–13.7  
 methods of, 13.4  
 steps in, 13.6  
 random mutations using spiked primers, 13.80  
 selection of mutants with *DpnI*, 13.19–13.25, 13.84–13.85  
 of single-stranded DNA, 13.15–13.18  
 troubleshooting, 13.18  
 uracil-substituted DNA preparation, 13.11–13.14  
 USE mutagenesis, 13.26–13.30, 13.85  
 PCR-mediated, 13.7–13.10  
 random, 13.78–13.80  
 cassette mutagenesis, 13.79  
 chemical mutagenesis, 13.78–13.79  
 misincorporation mutagenesis, 13.80  
 with spiked oligonucleotide primers, 13.80  
 of regulatory regions, 13.2  
 screening by  
 conformational polymorphism and heteroduplex analysis, 13.49–13.56  
 hybridization to radiolabeled probe, 13.40–13.47  
 PCR, 13.48  
 site-directed  
 alanine-scanning mutagenesis, 13.81  
 codon usage, changing, 15.12  
 commercial kits for, 13.89  
 inverse PCR, deletion introduction by, 8.42  
 Kunkel method, 13.84  
 M13, 8.42  
 mutagenic oligonucleotide for, 13.82–13.83  
 oligonucleotide-directed, 13.3–13.7, 13.11–13.30, 13.84–13.85  
 PCR end modification protocol, 8.42–8.45  
 PCR-mediated

- Mutagenesis (*continued*)  
 megaprimer method, 13.8–13.10, 13.31–13.35  
 overlap extension, 13.8, 13.36–13.39  
 overview, 13.7–13.10  
 polymerase choice for, 13.20–13.21  
 restriction site creation/removal, 13.82–13.83, 13.85  
 screening  
   by conformational polymorphism and heteroduplex analysis, 13.49–13.56  
   by hybridization to radiolabeled probe, 13.40–13.46  
   by PCR, 13.48  
   phagemid-containing colonies by hybridization, 13.47  
 selection in vitro, 13.84–13.87  
   *DpnI* destruction of parentals, 13.19–13.25, 13.84  
   phosphorothioate analog incorporation, 13.86–13.87  
   unique restriction site elimination, 13.26–13.30, 13.85  
   uracil-DNA glycosylase destruction of parentals, 13.84–13.85  
   selection in vivo, 13.87  
 Mutagenesis buffer, 13.21  
 Mutan-Express Km Kit, 13.89  
 Mutation detection, 13.91–13.96  
   allele-specific oligonucleotides (ASO), 13.91, 13.95  
   amplification refractory mutation system (ARMS), 13.91, 13.96  
   arrays, mutation detection, A10.3  
   bidirectional dideoxy fingerprinting (Bi-ddF), 13.91, 13.94  
   CDI modification, 13.95  
   chemical cleavage of mismatched bases (CCM), 13.91, 13.95  
   competitive oligonucleotide priming (COP), 13.91, 13.96  
   denaturing gradient gel electrophoresis (DGGE), 13.91, 13.92  
   dideoxy fingerprinting (ddF), 13.91, 13.94  
   with DNA mismatch repair enzymes, 13.94  
   oligonucleotide ligation assay (OLA), 13.91, 13.96  
   primer extension, 13.91, 13.96  
   protein truncation test (PTT), 13.92  
   with resolvases, 13.94  
   restriction endonuclease fingerprinting (REF), 13.91, 13.94  
   RFLP/PCR, 13.91, 13.95  
   scanning vs. specific methods, 13.91  
   single-stranded conformational polymorphism (SSCP), 13.91, 13.93  
 Mutation detection enhancement. *See* MDE  
 Mutations  
   amber, A7.5  
   conditional, A7.5  
   temperature-sensitive, A7.5  
*mutS*, 13.29–13.30, 13.85, 13.87  
*mutY*, 13.94  
 MV1184 *E. coli* strain, 13.47  
   genotype, A3.8  
   M13 vectors and, 3.13  
   phagemids and, 3.42, 3.44, 3.46  
 MV1190 *E. coli* strain  
   genotype, A3.8  
   phagemids and, 3.46  
 MV1193 *E. coli* strain genotype, A3.8  
 MV1304 *E. coli* strain, phagemids and, 3.46  
*MvaI* methylase, A4.7  
 Mycophenolic acid, 16.49  
 MZ-1, *E. coli* strain genotype, A3.8  
 MZEF (Michael Zhang's exon finder) program, A11.12  
 NaCl. *See* Sodium chloride  
*NaeI*  
   fragment size created by, table of, A4.8  
   methylation, A4.7  
   site frequency in human genome, 4.16, A6.3  
 Nalidixic acid induction of  $\lambda$  lysogen, 15.25  
 Nanogenchips, A10.19  
 NaOH. *See* Sodium hydroxide  
*NarI*  
   fragment size created by, table of, A4.8  
   methylation, A4.7  
   site frequency in human genome, 4.16, A6.3  
 NA stop/storage buffer, 9.6, 9.9  
 National Center for Biotechnology Information (NCBI), A11.2, A11.22  
 NBT. *See* Nitroblue tetrazolium  
*NciI* in phosphorothioate incorporation mutagenesis, 13.86  
*NcoI*  
   cleavage at end of DNA fragments, A6.4  
   linker sequences, 1.99  
*NdeI*, 1.99, A4.9  
*NdeII*, A4.9  
 Nebulization of DNA, 12.11, 12.14, 12.16–12.17, A8.37–A8.38  
   calibration of nebulizer, A8.37–A8.38  
 NEN/Sorb, 10.49  
 Neomycin, 17.74, A2.7  
 Neomycin resistance marker in YACs, 4.64  
 Nested deletion mutant, generating with exonuclease III, 13.57–13.61, 13.74–13.75  
 NetGene program, A11.11  
 NETN, 18.67–18.68  
 Neutralization buffer/solution, 10.38  
   for alkaline agarose gels, 5.37  
   for alkaline transfer of DNA to nylon membranes, A1.13  
   for neutral transfer, double-stranded DNA targets only, A1.13  
   in Southern hybridization, 6.41, 6.43  
   for transfer of DNA to uncharged membranes, A1.13  
 NF-1 nuclear factor, 17.8, 17.11  
*nflA*, *E. coli* gene, 2.7  
*nflB*, *E. coli* gene, 2.7  
*N* gene,  $\lambda$ , 2.6–2.9, 15.25  
*NgmI* IV cleavage at end of DNA fragments, A6.4  
*NheI*  
   cleavage at end of DNA fragments, A6.4  
   fragment size created by, table of, A4.8  
   linker sequences, 1.99  
   site frequency in human genome, 4.16, A6.3  
 NHS (*N*-hydroxysuccinimide), 18.104–18.105  
 Ni<sup>2+</sup> absorption chromatography, 15.44–15.48  
   elution with imidazole, 15.47  
   generation of resin, 15.48  
*nic* site, 1.146  
 Nick translation  
   biotin labeling of genomic clones, 11.102  
   digoxigenin labeling of nucleic acids, A9.38–A9.39  
   DNA polymerase and, 9.85–9.86  
   history of, 9.12  
   kits, 9.13  
   optimizing reactions, 9.13  
   procedure, 9.12–9.13  
   random priming compared, 9.4  
   using *E. coli* DNA polymerase, A4.12  
 Nick translation buffer, 11.100  
 NIH-3T3 cells, 17.60–17.67  
*nin* (*N*-independent) mutants,  $\lambda$ , 2.7  
 Nitric acid, A1.6  
 Nitrilotriacetate (NTA)-Ni<sup>2+</sup>-agarose, 15.46  
 Nitroblue tetrazolium (NBT), 9.78, 14.9–14.10, 14.20, A9.39–A9.42  
 Nitrocellulose membranes, 1.28. *See also*  
   Hybridization  
   amplification of bacteriophages on, 2.95  
   amplification of cosmid libraries, 4.31–4.32  
   baking, 2.94, 6.46  
   colorimetric detection of nonradioactive probes on, 9.78  
   denaturing DNA on, 2.94  
   disadvantages of, 6.37–6.38  
   DNA transfer. *See also* Southern hybridization, DNA transfer methods  
     electrophoretic, 6.36  
     from plaques to filters, 2.91, 2.93–2.95  
     vacuum transfer, 6.37  
   fixing DNA to, 2.94–2.95  
   gluing to 3MM paper, 2.99  
   for immunological screening, 11.32, 14.6–14.13, 14.17–14.22, A8.53  
   in  $\lambda$  library screening by PCR protocol, 8.76  
   lysis of colonies and binding of DNA, 1.136  
   for microarray applications, A10.6–A10.7  
   in northern hybridization, 7.23–7.24  
   nylon filters compared, 2.91  
   probe removal from, in Southern hybridizations, 6.57  
   properties of, 6.38  
   reagents for detection of antibody-antigen complex, 14.3  
   RNA binding to, 6.37  
   screening  
   bacterial colonies by hybridization, 1.126–1.134  
   bacterial DNA with radiolabeled probe, 1.138–1.142  
   cosmid libraries by hybridization, 4.24–4.27  
   expression libraries by labeled probes, 14.31–14.36  
   storage of, 6.37–6.38  
   in transcriptional run-on assay hybridizations, 17.28–17.29  
   wetting, 6.44, 6.49  
   *p*-nitrophenyl phosphate, A9.41–A9.42  
   Nitrosomethylurea use in M13 vector creation, 3.8  
 Nitrous acid, mutagenesis from, 13.78  
 NM519 *E. coli* strain  
   genotype, A3.8  
    $\lambda$  vector propagation, 2.28  
 NM522 *E. coli* strain  
   genotype, A3.9  
    $\lambda$  vector propagation, 2.29  
   M13 vectors and, 3.13  
 NM531 *E. coli* strain  
   genotype, A3.9  
    $\lambda$  vector propagation, 2.28  
 NM538 *E. coli* strain  
   genotype, A3.9  
    $\lambda$  vector propagation, 2.28  
 NM539 *E. coli* strain  
   genotype, A3.9  
    $\lambda$  vector propagation, 2.29  
 NM554 *E. coli* strain  
   for cosmid stability, 4.28  
   genotype, A3.9  
*N*-methylimidazole (NMI), 10.42  
 NNPP (promoter prediction by neural network) program, A11.12  
 Nonidet P-40  
   in cell lysis buffers, 17.36  
   in coimmunoprecipitation solutions, 18.67  
   in DNA sequencing reactions, 12.38, 12.55  
   in homogenization buffer, 17.9, 17.26  
   in PCR lysis solution, 6.22  
   in supershift assays, 17.17  
 Nonisotopic RNase cleavage assay (NIRCA), 13.93  
 Nonradioactive labeling, 9.76–9.81  
   biotin, 9.76–9.79  
   detection after hybridization, 9.78–9.80

- chemiluminescence, 9.79–9.80  
 colorimetric assays, 9.78–9.79  
 fluorescent assays, 9.79  
 digoxigenin, 9.77  
 enzymatic methods, 9.77–9.78  
 fluorescein, 9.77  
 indirect detection systems, 9.76  
 photolabeling, 9.78  
 switching to, 9.80–9.81
- Northern hybridization**  
 background, 7.45  
 cDNA library screening, 11.38  
 at low stringency, 6.58  
 low-stringency, 7.43  
 membranes used for, 6.37  
 nonradioactive labeling and, 9.76, 9.80  
 overview of, 7.21–7.26  
 protocol, 7.42–7.44  
 quantitating RNA by, 7.66  
 ribonuclease protection assay compared, 7.63–7.65  
 RNA fixation to membranes, 7.35–7.36, 7.39–7.40  
 RNA separation by size  
 electrophoresis of glyoxylated RNA, 7.27–7.30  
 equalizing RNA amounts in gels, 7.22–7.23  
 formaldehyde-agarose gels, 7.31–7.34  
 markers used in gels, 7.23, 7.29  
 overview, 7.21–7.22  
 pseudomessages as standards, 7.23  
 RNA transfer to membranes, 7.25–7.26, 7.35–7.41  
 membranes used for, 7.23–7.25  
 protocols, 7.35–7.41  
 staining of RNA on membranes, 7.39  
 steps involved, list of, 7.21  
 stripping blots, 7.44  
 troubleshooting, 7.45
- NotI**  
 cDNA linkers and adaptors and, 11.20, 11.51, 11.64  
 in cDNA synthesis kits, 11.71  
 cleavage at end of DNA fragments, 8.38, A6.4  
 fragment size created by, table of, A4.8  
 genomic DNA mapping, 5.60, 5.68–5.69  
 linker sequences, 1.99  
 methylation, A4.7  
 site frequency in human genome, 4.16, A6.3
- Novobiocin**, A2.7
- NruI**  
 genomic DNA mapping, 5.69  
 methylation, A4.7
- NS3516 *E. coli* strain genotype**, A3.9  
**NS3529 *E. coli* strain genotype**, A3.9  
*NsiI* cleavage at end of DNA fragments, A6.4  
**NTA-Ni<sup>2+</sup>-agarose**, 15.46  
 regeneration of, 15.48  
*NsiI* gene,  $\lambda$ , 2.4, 2.15  
 NsiI protein,  $\lambda$ , 2.14
- Nuclear extracts**  
 preparation from cultured cells, 17.9–17.10  
 preparation from tissues, 17.8–17.9
- Nuclear polyhedrosis viruses (NPVs)**, 17.81
- Nuclear run-on assays**, 17.23. *See also* Transcriptional run-on assays
- Nuclease S1**, A4.46  
 digestion buffer, 7.56, 7.60, A1.11  
 digestion of hairpins, 11.46  
 in exonuclease III mutagenesis protocol, 13.57, 13.59–13.61, 13.74–13.75  
 exonuclease VII results compared, 7.86  
 hairpin digestion, 11.4, 11.16  
 inactivation, 13.61  
 mapping of RNA, 7.51–7.62  
 5' and 3' mRNA termini, 7.53  
 artifacts, 7.54–7.55  
 diagrams of, 7.52–7.53  
 digestion conditions, 7.61  
 probes, 7.51–7.55  
 protocol, 7.55–7.62  
 analysis by gel electrophoresis, 7.61–7.62  
 digestion of DNA-RNA hybrids, 7.60–7.61  
 dissolving nucleic acid pellets, 7.60  
 hybridization of probe and test RNA, 7.59, 7.60  
 materials for, 7.55–7.57  
 probe preparation, 7.58–7.59  
 probe purification by gel electrophoresis, 7.59–7.60  
 troubleshooting, 7.55  
 overview of, 7.86  
 ribonuclease protection assay compared, 7.65  
 source of, 7.86  
 stop mixture, 7.56, 13.58
- Nucleases**, A4.38–A4.49. *See also* BAL 31 nuclease; Exonuclease III; Nuclease S1  
 bacteriophage  $\lambda$  exonuclease, A4.49  
 BAL 31, A4.43–A4.45  
 DNase I, A4.40–A4.42  
 exonuclease III, A4.47–A4.48  
 mung bean, A4.47  
 RNase A, A4.39  
 RNase H, A4.38  
 RNase T1, A4.39  
 S1, A4.46
- Nuclei**  
 harvesting for DNase I hypersensitivity mapping, 17.20–17.21  
 isolation  
 from cultured cells, 17.26  
 from tissue, 17.27  
 radiolabeling transcription, 17.27–17.28  
 Nuclei wash buffer, 17.25  
 Nucleic acid database and structure resource, A11.21  
 Nucleic acid fragment removal  
 by centrifugation through NaCl, 1.78–1.79  
 by chromatography, 1.80–1.81  
 by precipitation with LiCl, 1.82–1.83  
 Nucleobond AX, 1.64  
 Nucleoside analogs used as chain terminators in DNA sequencing (Table A6-11), A6.10  
 Nucleosomes, DNase I hypersensitivity sites and, 17.18  
 NusA, 2.7, 2.14  
 NusB, 2.7  
 NusG, 2.7  
 nut site,  $\lambda$ , 2.7
- Nylon membranes**. *See also* Hybridization  
 advantages of, 6.38  
 amplification of cosmid libraries, 4.31–4.32  
 baking, 7.35–7.36, 7.39–7.40  
 biotinylated probe adherence to, 9.76  
 brand differences, 2.91  
 charged vs. neutral, 7.37, 7.39  
 chemiluminescent assays, 9.79, A9.19, A9.43–A9.44  
 colorimetric detection of nonradioactive probes on, 9.78  
 denaturing DNA on, 2.94  
 dot and slot blotting of RNA, 7.46–7.50  
 intensity of signal, measuring, 7.47  
 sample application, 7.46  
 fixing DNA to, 2.94–2.95, 6.46  
 fixing RNA to, 7.36, 7.39–7.40  
 gluing to 3MM paper, 2.99  
 history of, 7.24  
 hybridization at high temperatures, 1.141  
 for immunoblotting, A8.53  
 lysis of colonies and binding of DNA, 1.131, 1.136  
 neutral vs. charged, 6.38, 7.25, 7.35  
 nitrocellulose compared, 2.91  
 northern hybridization, 7.24–7.25, 7.35–7.41  
 fixation of RNA, 7.35–7.36, 7.39–7.40  
 transfer to charged membranes at alkaline pH, 7.35  
 transfer to neutral membranes, 7.35–7.36  
 properties of, 6.38, 7.25  
 screening bacterial colonies by hybridization, 1.126–1.134  
 screening cosmid libraries by hybridization, 4.24–4.27
- Southern hybridization**  
 fixation of DNA to membrane, 6.45–6.46  
 probe removal from, 6.57  
 transfer protocol, 6.43–6.45, 6.49  
 stripping, A9.38, A9.42  
 transfer of DNA to. *See also* Southern hybridization, DNA transfer methods  
 electrophoretic, 6.36  
 from plaques to filters, 2.91, 2.93–2.95  
 vacuum, 6.37  
 UV irradiation fixation of nucleic acids, 6.46, 7.36, 7.39–7.40  
 wetting, 7.38, 7.41
- NZCYM medium**, 11.62, A2.3  
**NZM medium recipe**, A2.3  
**NZYM medium recipe**, A2.3
- o-dianisidine**, 14.3, A9.34
- OFAGE (orthogonal field agarose gel electrophoresis)**, 5.55. *See also* Pulsed-field gel electrophoresis
- O gene,  $\lambda$** , 2.6, 2.8–2.9, 2.11
- Oligo(dT) primers**  
 in cDNA probe production, 9.42–9.43  
 for cDNA synthesis, 11.12–11.13, 11.15, 11.39  
 linked to plasmid, 11.12
- Oligo(dT)-cellulose**, 7.13–7.17, 7.19–7.20
- Oligonucleotide**  
 elution buffer, 10.12  
 hybridization solution, 10.35, 13.41  
 labeling buffer, 9.10  
 ligation assay (OLA), 13.91, 13.96  
 prehybridization solution, 10.35, 10.38, 13.41  
 purification cartridges (OPCs), 10.49
- Oligonucleotide-directed mutagenesis**  
 efficiency of, 13.83  
 elimination of unique restriction site, 13.26–13.30  
 oligonucleotide design, guidelines for, 13.82–13.83  
 overview of, 13.3–13.7  
 design, 13.4  
 diagram of scheme, 13.5  
 history of, 13.4–13.7  
 methods of, 13.4  
 steps in, 13.6  
 phosphorothioate incorporation, 13.86–13.87  
 random mutations using spiked primers, 13.80  
 selection of mutants with *Dpnl*, 13.19–13.25, 13.84–13.85  
 of single-stranded DNA, 13.15–13.18  
 troubleshooting, 13.18  
 uracil-substituted DNA preparation, 13.11–13.14  
 USE mutagenesis, 13.26–13.30, 13.85
- Oligonucleotide primers**. *See also* Oligonucleotide-directed mutagenesis  
 cDNA probe construction  
 oligo(dT) primer, 9.42–9.43, 9.47  
 random primers, 9.39–9.40, 9.48–9.49  
 for cDNA synthesis, 11.12–11.15, 11.39  
 oligo(dT), 11.12–11.13, 11.15  
 random, 11.12–11.15  
 second-strand, 11.17–11.20  
 commonly used (Table A6-12), A6.11  
 converting molarities to units of weight, 12.103



- Oligonucleotide primers (*continued*)  
 design, computer program for, 13.83  
 for DNA sequencing, 12.6–12.7, 12.27–12.28, 12.35, 12.41–12.42, 12.48–12.49, 12.52–12.55, 12.60  
 dvc primers, 12.96  
 energy transfer (ET) primers, 12.96  
 stock solution preparation, 12.103  
 in exon trapping/amplification protocol, 11.90–11.93, 11.96  
 gel purification, need for, 12.103  
 molecular-weight calculation, formula for, 8.20, 8.50  
 oligonucleotide-directed mutagenesis, 13.4, 13.6–13.10, 13.16–13.17, 13.19–13.20, 13.26–13.30  
 in PCR, 8.4–8.5, 8.18  
 3'-RACE, 8.61–8.65  
 5'-RACE, 8.54–8.60  
 annealing conditions, 8.8–8.9  
 concentration of, 8.5  
 degenerate pools, 8.66–8.71, 8.113  
 design, 8.13–8.16  
 differential display-PCR, 8.96, 8.99–8.101, 8.103, 8.105  
 extension of primers, 8.9  
 guessmers, 8.66–8.67  
 inosine use in degenerate pools, 8.113  
 inverse PCR, 8.81–8.85  
 ligation-independent cloning, 11.121–11.124  
 linker-scanning mutagenesis, 13.76–13.77  
 long PCR, 8.79  
 MOPAC, 8.66–8.71  
 multiplex PCR, 8.5, 8.107  
 purification of, 8.5, 8.18  
 quantitative PCR, 8.90–8.92  
 restriction site addition to 5' termini, 8.31, 8.37–8.39  
 universal, 8.113–8.117  
 PCR-mediated mutagenesis, 13.31–13.34, 13.36–13.39  
 in primer extension assays, 7.75–7.76, 7.78–7.79  
 promoters of RNA polymerases, adding to DNA fragments, 9.37  
 purification, 7.76  
 in radiolabeled probe production  
 PCR, 9.15–9.18  
 random priming, 9.5–9.7, 9.10  
 single-stranded probes from M13, 9.19–9.22, 9.26  
 removal by ultrafiltration, 8.27–8.29  
 for reverse transcriptase use, A4.25–A4.26  
 for RT-PCR, 8.46–8.48  
 oligo(dT), 8.46–8.48  
 random hexamers, 8.47–8.48  
 spiked, 13.80  
 universal primers, 8.113–8.117  
 for  $\lambda$ gt10/ $\lambda$ gt11, 8.116  
 for M13 vectors, 8.115  
 for pBR322, 8.114  
 for pUC vectors, 8.115  
 transcription promoter primers, 8.117
- Oligonucleotide probes, 10.1–10.49  
 biotin labeling, 11.117  
 cDNA screening with, 11.31–11.32  
 degenerate pools, 11.31  
 guessmers, 11.31  
 universal bases, 11.32  
 in competition assays, 17.17  
 degenerate pools, 10.5–10.6  
 extinction coefficient, calculating, 10.13–10.14  
 guessmers, 10.6–10.9  
 design, 10.7  
 hybridization conditions, 10.8  
 melting temperature, 10.8  
 mixtures of, 10.7–10.8  
 PCR compared, 10.9  
 labeling with Klenow fragment, 10.30–10.34  
 length of, 10.4–10.5  
 melting temperatures, 10.2–10.4, 10.6, 10.8, 10.47–10.48  
 empirical measurement, 10.38–10.41  
 double-stranded DNA, 10.40–10.41  
 single-stranded DNA, 10.40  
 in TMAcI buffers, 10.36  
 phosphorylation of 5' termini, 10.17–10.19  
 efficiency of transfer, measuring, 10.19  
 materials, 10.17–10.18  
 protocol, 10.18–10.19  
 purification  
 chromatography, 10.49  
 HPLC, 10.49  
 polyacrylamide gel electrophoresis, 10.11–10.16  
 detection in gels, 10.16  
 eluting DNA, 10.15  
 materials, 10.12–10.13  
 protocol, 10.13–10.16  
 Sep-Pak C<sub>18</sub>, 10.15–10.16  
 by polyacrylamide gel electrophoresis, 10.48–10.49  
 resolution, 10.14, 10.33, 10.49  
 precipitation with CPB, 10.22–10.24  
 precipitation with ethanol, 10.20–10.21  
 purification cartridges, 10.49  
 reversed-phase chromatography, 10.11, 10.15–10.16, 10.49  
 Sep-Pak C<sub>18</sub> chromatography, 10.28–10.29  
 size-exclusion chromatography, 10.25–10.27  
 of tritylated, 10.49  
 quantifying by OD, 10.13  
 quaternary alkylammonium salts, 10.6, 10.35–10.37  
 screening expression libraries, 14.2, 14.31–14.36  
 synthesis, 10.1, 10.42–10.46  
 monitoring, 10.42  
 phosphodiester method, 10.42  
 phosphoramidite chemistry, 10.42  
 protecting groups, table of, 10.43  
 steps involved, diagrams of, 10.44–10.45  
 yield estimates, table of, 10.46  
 universal bases, 10.9–10.10  
 uses for, 10.2
- Oligonucleotides. *See also* Adaptors; Linkers;  
 Oligonucleotide primers; Oligonucleotide probes; Oligonucleotide-directed mutagenesis  
 molecular conversions for (Table A6-13), A6.11  
 purification from polyacrylamide gels by crush and soak method, 5.51  
 spectrophotometry, A8.20, A8.21
- OMPF protein, 17.53  
*ompT* mutation, 15.19  
 1089 *E. coli* strain, fusion protein preparation in, 14.41
- ONPG (*o*-nitrophenyl- $\beta$ -D-galactopyranoside), 17.50–17.51, 17.97–17.98
- OOTFD (Object-Oriented Transcription Factor Database), A11.20
- O*-phenylenediamine dihydrochloride (OPD), A9.35
- Oregon Green, 8.94–18.95, 18.80, 18.90, A9.33
- oriC*, 13.88, A4.3
- Origin of replication, 1.3, 1.4. *See also* Replicons  
*dam* methylation and, 13.88  
*f1*, 17.35, 17.49  
 locating by linker-scanning mutagenesis, 13.75  
*oriC*, 13.88, A4.3  
 in p $\beta$ -gal vectors, 17.49  
 in pCAT3 vectors, 17.35  
 polyomavirus, 11.69  
 from single-stranded bacteriophages, 1.11  
 SV40, 11.69, 11.114, 17.49  
 yeast artificial chromosome, 4.2
- Origin of transfer (*oriT*), 1.146
- oriS* in BACs, 4.48
- Osmium tetroxide, 13.91, 13.95
- Osmotic shock for release of proteins from periplasmic space, 15.40, 15.43
- Ovens, hybridization, 6.51
- Overhangs, DNA. *See* Protruding termini
- Overlap extension mutagenesis, 13.8, 13.36–13.39
- <sup>32</sup>P  
 chemiluminescence compared, A9.16  
 decay data, A9.15  
 in far western screens, 18.48  
 particle spectra, A9.9–A9.10  
 sensitivity of autoradiographic methods for detection, A9.13
- <sup>33</sup>P  
 decay data, A9.15  
 particle spectra, A9.9–A9.10  
 sensitivity of autoradiographic methods for detection, A9.13
- P1 artificial chromosomes (PACs), 4.4  
 advantages/disadvantages, 4.40  
 choosing for genomic library construction, 4.7–4.10  
 DNA purification, 4.42–4.45  
 Human PAC Library, 4.9  
 overview, 4.40  
 vectors, A3.5
- P1 bacteriophage  
 Cre-*loxP* system, 4.82–4.83  
 history of, 4.35  
 life cycle of, 4.36
- P1 bacteriophage vectors, 4.35–4.47, A3.5  
 advantages/disadvantages, 4.40  
 amplification, 4.36, 4.42  
 arrayed libraries, 4.8  
 cloning into vectors, 4.37–4.39  
 design of vectors, 4.35–4.37  
 DNA preparation/purification, 4.42–4.45  
 by chromatography, 4.45  
 by drop dialysis, 4.44  
 protocol, 4.42–4.43  
 electroporation, 4.46–4.47  
 genomic libraries  
 arrayed, 4.39  
 choosing for construction of, 4.7–4.10  
 screening, 4.39–4.40  
 overview, 4.4  
 packaging, 4.7, 4.37, 4.82  
 transduction, 4.46
- P2 prophage, restriction of  $\lambda$  growth, 2.20
- P3 buffer (Qiagen), A1.21
- p15A replicon, 1.4
- p53 GeneChip array, 10.9
- P450 GeneChip array, A10.9
- PAC. *See* P1 artificial chromosomes (PACs)
- pacA* gene, 4.37
- PacI*  
 cleavage at end of DNA fragments, A6.4  
 fragment size created by, table of, A4.8  
 genomic DNA mapping, 5.68–5.69  
 site frequency in human genome, 4.16, A6.3
- Packaging  
 cosmids, 4.21–4.22, 4.30  
 in vitro packaging, 2.111, 11.113–11.114  
 $\lambda$  vectors, 2.63, 2.65, 2.67, 2.84–2.89, 2.110–2.111  
 P1 bacteriophage vectors, 4.7, 4.37, 4.82
- Packard MultiPROBE II, A10.5
- pACYC, 1.1.4, A3.2
- pAd10*sacBII*, 4.4, A3.5  
 concentration of doubled-stranded DNA in solution, A6.5  
 features of, 4.37–4.38  
 library generation in, 4.38

- PAC vector derived from, 4.40
- PAGE. See Polyacrylamide gel electrophoresis
- Pak1 kinase, 18.13
- Pam3, A7.5
- p*-aminophenyl- $\beta$ -D-thio-galactoside (APTG) (TPEG), 15.6, 15.58, 17.97
- pAMP1, 11.122–11.123
- pAMP10, 11.122
- Pancreatic DNase I. See DNase I
- Pancreatic RNase. See RNase
- Panning, 11.68–11.69
- Papain, 18.80–18.81
- par*, 1.8, 1.13, 1.146, 4.2, 4.37
- parA* in bacterial artificial chromosome, 4.2–4.3, 4.48
- Paraffin blocks, DNA extraction from, 6.27
- Paraformaldehyde (4%) fixative solution, 18.87
- Paramagnetic beads, 9.91, 11.98–11.99, 11.103
- parB* in bacterial artificial chromosome, 4.2–4.3, 4.48
- parC* in bacterial artificial chromosome, 4.2–4.3
- Partek Pro 2000 image analysis program, A10.13
- Partitioning. See also *par*  
in BACs, 4.48  
low-copy-number plasmids, 1.13
- pAS1, 15.4, 15.25
- pAT53, 1.9
- Pathways analysis software package, A10.9
- pAX vectors for LacZ fusion protein expression, 15.59
- pB6B15.23, 11.109
- pB42AD, 18.20, A3.4
- pBAcc, 15.5, 15.32
- pBACe3.6, 4.9
- pBC KS +/-, A3.2
- pBeloBACII, 4.3, A3.5, A6.5
- $\beta$ -gal vectors, 3.15, 17.49, A3.3
- pBK-CMV, 11.24, A3.3
- pBluescript vectors, 1.11, 11.92, 11.94, A3.2  
 $\beta$ -galactosidase gene, 1.27  
in commercial kits for cDNA synthesis, 11.108  
in exon trapping protocol, 11.89, 11.92, 11.94  
for fusion protein construction, 15.5  
KS (+/-), 3.15, 3.42, 3.44  
for LacZ fusion protein expression, 15.59  
in ribonuclease protection assay protocol, 7.69  
SK (+/-), 3.15, 3.42, 3.44  
SK (-) phagemid in  $\lambda$ ZAPIII, 11.23  
in USE mutagenesis, 13.30
- pBR313, 1.9, A3.2
- pBR322, 1.9–1.10, A3.2  
cDNA cloning, 11.19  
concentration of doubled-stranded DNA in solution, A6.5  
electroporation of, 1.26  
mobilization, 1.146  
overview, 1.146  
plasmid growth and replication, 1.17  
primers for cloning sites in, 8.114  
replicon in, 1.14
- pBR327, A3.2
- pBS. See pBluescript vectors
- pCANTAB 5, 18.120
- pCAT3 vectors, 17.35, A3.3
- pcDNA3.1, 11.25, 11.30, 11.63, 11.72, A3.3
- pcDNA4, 11.72
- pCGB42/p2GB42, 18.20
- pCGLex/p2GLex, 18.19
- pCI-Neo, 17.61, 17.66
- pCMV vectors, A3.3  
pCMV-Script, 11.25, 11.29, 11.63, 11.72, A3.3  
pCMV-SPORT in commercial kits for cDNA synthesis, 11.108  
pCMV-SPORT- $\beta$ -gal, 16.10, A3.4
- penB* gene, 1.13
- pCOMB3H, 18.118
- pCOMB8, 18.118
- pCQV2, 15.25
- PCR. See Polymerase chain reaction
- PCR lysis solution, 6.22
- PCR Primer Design program, 13.89
- pCR2.1, 3.15
- pCR1000, A3.2
- pCRII, 8.35
- pCR-ScriptSK(+), 1.100, 8.35
- pCYPAC1, 4.5, 4.9, A3.5  
concentration of doubled-stranded DNA in solution, A6.5  
human genomic library, 4.39
- pd2EGFP vectors, 17.88, A3.4
- PDB (Protein Data Bank), A11.23
- pDisplay, 18.120
- pDisplay Expression Vector, 18.120
- PE1 buffer, 13.15
- PE2 buffer, 13.15
- Pefabloc, 15.41, A5.1
- PEG. See Polyethylene glycol
- pEG202, 18.19, 18.24, A3.4
- pEG202I, 18.19
- pEGFP-F, 16.10
- pEMBI, 3.42–3.43  
1,10-Pentanethiol-copper, 17.76–17.77
- Penicillins, 1.148, A2.7
- Pepstatin, 15.19, 17.25, A5.1
- Peptide aptamers, 18.8
- Peptides  
antibodies against, A9.30–A9.33  
coupling to carriers, A9.32  
libraries, 18.116–18.121  
constrained, 18.120–18.121  
construction of, 18.117–18.119  
random, 18.116–18.117  
phage display of, 18.116–18.121
- Peptidoglycan, 1.148
- Peptostreptococcus magnus*, A9.49
- Perchloric acid, A1.6, A8.10
- Perfect Lipid Transfection Kit, 16.5, 16.7
- Perfect Match, 4.81, 8.9
- PerfectPrep, 1.64, 12.27
- Periodic Table of Elements, A1.29
- Periplasmic space  
export of foreign proteins to, 15.30, 15.34–15.35  
export of maltose-binding fusion proteins to, 15.40, 15.43  
release of fusion proteins by osmotic shock, 15.40, 15.43
- Peroxidase. See Horseradish peroxidase
- Peroxisome, 17.96
- pET vectors, 1.12, 15.3, 15.5, 15.20–15.24, A3.2
- pET-3 vector, 15.20–15.21
- pEX vectors  
expression libraries, 14.14  
for LacZ fusion protein expression, 15.59
- Pfam program, A11.16–A11.17
- PFGE. See Pulsed-field gel electrophoresis
- pFlitrx, 18.120
- PfScan (ProfileScan) program, A11.16
- Pfu* DNA polymerase, 8.7, 8.11, 8.30, 8.77–8.78, 8.85  
3'-5' exonuclease activity, 8.30, 8.35  
in circular mutagenesis, 13.20–13.23  
in overlap extension method of mutagenesis, 13.37  
polishing cDNA termini, 11.43  
properties, table of, A4.23
- pGEM vectors, 1.11, A3.2  
 $\beta$ -galactosidase gene, 1.27  
for fusion protein construction, 15.5
- pGEM-3Z, 15.14, A3.2
- pGEM-11Zf(-), A9.23
- pGEM\_luc, A9.23
- pGEM-T, 8.35, A3.2
- pGEMZ for LacZ fusion protein expression, 15.59
- pGEMZF, 3.42, 3.44, A3.2  
in ribonuclease protection assay protocol, 7.69
- P* gene,  $\lambda$ , 2.6, 2.8–2.9, 2.11
- pGEX vectors, 15.43, A3.2  
for fusion protein construction, 15.5
- pGEX-1, 15.15
- pGEX2T, 15.8
- pGEX3X, 15.8
- pGilda, 18.19–18.20, 18.27, A3.4
- pGL vectors, 17.96
- pGL2, 3.15
- pGL3, 17.43, A3.4
- pGNG1, 18.12
- Phage display, 18.3
- Phage Display System/Service, 18.120
- Phagefinder Immunoscreeing Kit, 14.25
- Phagemid display system, 18.115–18.116
- Phagemids, 1.11  
advantages of, 3.43  
DNA preparation, single-stranded, 3.42–3.49  
growth time and, 3.49  
materials, 3.45–3.46  
protocol method, 3.46–3.48  
yield estimation by gel electrophoresis, 3.48
- helper viruses, 3.42–3.47  
preparation of high-titer stock, 3.46  
protocol for superinfection, 3.47
- M13, 3.3, 3.5  
nested deletion mutant set creating, 13.57, 13.59–13.61  
oligonucleotide-directed mutagenesis, 13.18  
replication, 3.43  
screening for site-directed mutagenesis by hybridization to radiolabeled probes, 13.47  
table of, 3.42  
uracil-substituted single-stranded DNA, preparation of, 13.12–13.13  
uses for, 3.43
- Phagescript SK, A3.5
- Phase-Lock Gel, 3.28
- Ph.D. Phage Display Peptide Library Kits, 18.120
- Phenol, A1.23  
in DNA isolation from mammalian cells, 6.5, 6.9–6.10, 6.22  
equilibration of, A1.23  
inhibition of PCR by, 8.13  
pH, 6.5  
spectrophotometry of DNA contaminated with, 6.11, 6.15
- Phenol:chloroform extraction  
of agarase, 5.85  
in DEAE-cellulose membrane recovery of DNA, 5.22  
in dephosphorylation procedures, 1.96  
in DNA recovery from polyacrylamide gels, 5.53  
of DNase contaminants, 1.42  
in DNase I footprinting protocol, 17.10  
in DNase I hypersensitivity mapping protocol, 17.21  
ethidium bromide removal from DNA preps, 1.74, 1.77  
in hydroxyl radical footprinting protocol, 17.12  
in  $\lambda$  DNA preparation, 2.58, 2.70  
of ligated DNA, 1.102  
M13 RF DNA purification, 3.25  
of nuclease S1 digestion reactions, 7.61  
in oligonucleotide purification, 10.27  
overview of procedure, A8.9–A8.10  
in PCR products, purification protocol, 8.26  
plasmid DNA protocols  
alkaline lysis with SDS, 1.34, 1.37, 1.42  
boiling lysis, 1.46  
lysis with SDS, 1.57

- Phenol:chloroform extraction (*continued*)  
 in polyethylene glycol DNA purification procedure, 1.59, 1.61  
 in primer extension assay protocol, 7.80  
 in RNA purification, 7.4  
 for RNase removal, 9.33  
 in yeast DNA purification protocols, 4.68–4.69
- Phenol:chloroform:isoamyl alcohol extraction, A1.23, A8.10  
 in genomic DNA isolation from mouse tails, 6.25, 6.27  
 in transcriptional run-on assay protocol, 17.28
- Phenol extraction  
 in bacteriophage DNA isolation, 12.23  
 in  $\lambda$  DNA preparation, 2.58  
 in M13 DNA preparation, 3.28  
 silicone lubricant for phase separation, 3.28
- Phenylalanine  
 for affinity purification of fusion proteins, 15.6  
 codon usage, A7.3  
 nomenclature, A7.7  
 properties, table of, A7.9
- Phenylmethylsulfonyl fluoride (PMSF), 5.62, 5.78, 14.44, 14.46, 15.41–15.42, 15.52, A5.1  
 in cell/tissue homogenization buffer, 17.4, 17.25  
 in cell/tissue resuspension buffer, 17.6  
 as protease inhibitor, 15.19
- Phenyl-Superose, 15.6
- PHI-BLAST (Position Hit Initiated BLAST) program, A11.18
- $\phi$ X174 bacteriophage, 1.12, 3.8, A3.3  
 oligonucleotide-directed mutagenesis and, 13.6  
 sequencing of, 12.4  
 shotgun sequencing protocol, 12.10–12.22
- phoA*. See Alkaline phosphatase promoter
- phoR*, 15.32
- Phosphatase. See Alkaline phosphatase
- Phosphate buffers, A1.5
- Phosphate buffers, Gomori, A1.5
- Phosphate-buffered saline (PBS), A1.7
- Phosphate-SDS washing solution, 6.51–6.52
- Phosphatidylethanolamine (DOPE), 16.5, 16.7–16.8, 16.50
- Phosphoric acid, A1.6
- Phosphorothioate analogs, 13.86–13.87
- Phosphorylation. See also Polynucleotide kinase, bacteriophage T4  
 of 5' termini, 10.17–10.19  
 blunt/recessed, 9.70–9.72  
 protruding, 9.66–9.67, 9.73–9.75  
 of adaptors, 1.88–1.89, 11.55  
 by exchange reaction, 9.73–9.75  
 imaging protein phosphorylation with FLIM-FRET, 18.78  
 imidazole buffers and, 9.73–9.74  
 of linkers, 1.99, 1.101, 11.55  
 of oligonucleotide probes, 7.78  
 polyethylene glycol enhancement of, 9.70–9.71  
 radiolabeling oligonucleotides, 13.42–13.43  
 in shotgun sequencing protocol, 12.18  
 of Thr-250, 18.78, 18.80, 18.88, 18.93–18.94  
 of tyrosine, 14.2
- Phosphotyrosine residues, antibodies specific for, 14.2
- Photinus pyralis*, 17.96, A9.21
- Photobiotin, 9.78, 11.116
- Photobleaching, 18.73, 18.92
- Photography of DNA in gels, 5.16–5.17  
 CCD (charged couple device) imaging systems, 5.15–5.16  
 Polaroid, 5.15–5.17  
 polyacrylamide gels, 5.48
- Photolabeling, 9.78
- Photolithography, A10.8
- pHUB vectors, 15.4, 15.25
- pHybLex/Zeo, 18.19
- picoBlue Immunoscreening Kit, 14.25
- Piezoelectric printing of microarrays, A10.16
- Pili, F, 4.49
- PIMA (Pattern-induced Multiple Alignment) program, A11.6–A11.7
- pIND(SPI)/V5-His A, 17.72, A3.4
- Piperidine  
 in chemical sequencing protocols, 12.61–12.65, 12.67, 12.71  
 rapid methods, 12.71  
 removal of, 12.62, 12.66  
 cleavage of CDI-modified bases, 13.95
- PIPES (piperazine-1,4-bis[2-ethanesulfonic acid]), 7.28  
 in nuclease S1 mapping of RNA, 7.56  
 in ribonuclease protection assay protocols, 7.67
- Pipetting devices, automatic  
 in PCR protocols, 8.19  
 as RNase source, 7.82
- pJB8, 4.13, A3.5
- pJG-4, A3.4
- pJG4-5, 18.20, 18.30, 18.43
- pJG4-5I, 18.20
- pJK101, 18.12, 18.23, 18.25, A3.5
- pJK103, 18.12
- pJK202, 18.19, 18.27
- PK buffer, 18.51, 18.52
- pKC30, 15.4, 15.25
- pKK223-3, 15.3, 15.15
- pKN402 replicon, 1.4
- PLACE (plant *cis*-acting regulatory elements) database, A11.20
- Placental RNase inhibitor, 8.49
- PLALIGN program, A11.4
- PlantCARE (plant *cis*-acting regulatory elements) database, A11.20
- Plaques, viral  
 $\lambda$  bacteriophage  
 $\beta$ -galactosidase screening, 2.30  
 macroplaques, 2.31  
 plating protocols, 2.25–2.31  
 size, 2.30  
 smearing, 2.30  
 M13 bacteriophage, 3.17  
 picking, 3.22  
 type, 3.2, 3.17  
 overview of, 2.25  
 purification, 13.45
- Plasmid DNA  
 dephosphorylation, 1.93–1.97  
 electroporation of *E. coli* and, 1.119–1.122  
 ligation in low-melting-temperature agarose, 1.103–1.104  
 linker addition to blunt-ended DNA, 1.98–1.102
- preparation  
 alkaline lysis with SDS, 1.19  
 maxipreparation protocol, 1.38–1.41  
 midipreparation protocol, 1.35–1.37  
 minipreparation protocol, 1.32–1.34  
 overview, 1.31  
 troubleshooting, 1.41, 1.42  
 yield, 1.41
- boiling lysis  
 large-scale, 1.47–1.50  
 overview, 1.43  
 small-scale, 1.44–1.46  
 yield, 1.50
- for DNA sequencing templates, 12.26–12.31  
 denaturation, 12.26–12.30  
 PEG precipitation, 12.31
- purification, 1.18–1.19  
 chromatography, 1.62–1.64  
 commercial resins, table of, 1.64  
 Sephacryl S-1000 columns, 1.80–1.81  
 size limitations, 1.63  
 CsCl removal, 1.73–1.75
- CsCl-ethidium bromide gradients, 1.18  
 contamination by DNA/RNA fragments, 1.65  
 continuous gradients, 1.65–1.68  
 discontinuous gradients, 1.69–1.78  
 DNA collection from, 1.67–1.68, 1.71  
 rebanding, 1.68
- ethidium bromide removal  
 extraction with organic solvents, 1.72–1.74  
 ion-exchange chromatography, 1.75–1.77  
 kits, 1.19
- low-melting-temperature agarose, 5.7
- nucleic acid fragment removal  
 centrifugation through NaCl, 1.78–1.79  
 chromatography, 1.80–1.81  
 precipitation with LiCl, 1.82–1.83
- precipitation with PEG, 1.19, 1.59–1.61, 1.152, 12.31
- steps, 1.16–1.19  
 growth of bacterial culture, 1.16  
 harvesting and lysis of culture, 1.16–1.18  
 purification, 1.18–1.19
- receiving in the laboratory, 1.29
- transfection of eukaryotic cells, calcium-phosphate-mediated, 16.14–16.20  
 high efficiency, 16.20  
 materials for, 16.15–16.16  
 method, 16.16–16.19  
 variables affecting, 16.20
- transformation. See Transformation
- Plasmids. See also Plasmid DNA; Plasmid vectors  
 amplification, 1.4, 1.13, 1.39, 1.48, 1.56, 1.128, 1.131, 1.143  
 copy number, 1.3–1.4, 1.6–1.9  
 chloramphenicol amplification, 1.4, 1.39, 1.48, 1.56, 1.128, 1.131, 1.143  
*E. coli* strains-related suppression, 1.15  
 low-copy-number vectors, 1.12–1.13  
 suppression by *penB*, 1.13
- incompatibility, 1.7–1.8
- mobilization, 1.146
- overview, 1.2–1.3
- partitioning, 1.146
- replication, 1.4–1.7  
 diagram of, 1.5  
 incompatibility of plasmids, 1.7–1.8  
 initiation of DNA synthesis, 1.5–1.6  
 inverted repeat lethality, 1.15  
 regulation by RNAI, 1.6–1.7  
 relaxed, 1.4, 1.17  
 runaway, 1.13  
 stringent, 1.4, 1.17
- replicons, 1.3–1.4, 1.17. See also Replicons  
 size, 1.9
- stability regions, 1.146
- Plasmid vectors  
 adaptor attachment to protruding termini, 1.88–1.89  
 with bacteriophage origin of replication, 1.11  
 with bacteriophage promoters, 1.11–1.12  
 blunt-ended cloning, 1.90–1.92  
 cDNA library construction, 11.63  
 directional cloning, 1.84–1.87  
 eukaryotic expression libraries, 11.72–11.73, 11.76–11.77  
 expression libraries, screening, 14.14–14.22, 14.47–14.49  
 chemiluminescent screening, 14.21–14.22  
 chromogenic screening, 14.20–14.21  
 master plate/filter preparation, 14.17  
 materials for, 14.15–14.17  
 processing filters, 14.18  
 protein expressing clones, 14.19–14.22  
 radiochemical screening, 14.19  
 replica filter preparation, 14.17–14.18  
 validation of clones, 14.22

- vector choice, 14.14
- expression vectors, 1.13–1.14
- finding appropriate, 1.14–1.16
- history of
  - 1973–1978, 1.9
  - 1978–1983, 1.9–1.10
  - 1983–present, 1.11–1.14
- immunological screening of libraries in, 14.2
- in vitro mutagenesis, 13.19–13.25
- for in vitro transcription, 9.29–9.31
- low-copy-number, 1.12–1.13
- nested deletion mutant set creating, 13.57, 13.59–13.61
- positive selection, 1.12
- runaway replication, 1.13
- selectable markers, 1.8–1.9
- table of, A3.2–A3.3
- USE mutagenesis, 13.26–13.30
- Plasmoon, 18.96
- Plasticware, preparation of, A8.3
- Platinum *Taq* Polymerase, 8.110
- pLexAop-lucU, 18.12
- Plus and minus sequencing technique, 12.4
- Plus/minus screening, 9.89–9.90
- pLysE, 15.21, 15.24
- pLysS, 15.21, 15.24
- PM2, bacteriophage, 13.71–13.72
- pMAL vectors, 15.15, A3.2
  - for fusion protein construction, 15.5
  - pMAL2, 15.7
  - pMAL-c2, 15.8, 15.40
  - pMAL-p2, 15.8, 15.40
- pMB1, A3.2
  - plasmid growth and replication, table of, 1.17
  - replicon, 1.3–1.4
- pMC9, 11.62, 11.66, 14.6, 14.47
- pMC128, 1.15
- PmeI*
  - cleavage at end of DNA fragments, A6.4
  - fragment size created by, table of, A4.8
  - genomic DNA mapping, 5.68–5.69
  - site frequency in human genome, 4.16, A6.3
- pMEX, 15.15
- pMOB45, 1.14, A3.2
- pMRI00 for LacZ fusion protein expression, 15.59
- PMSF. *See* Phenylmethylsulfonyl fluoride
- pMW101–104, 18.19–18.20, 18.23–18.24
- pMW107–110, 18.12
- pMW111, 18.12, A3.5
- pMW112, 18.12, 18.23–18.25, 18.29, 18.44, A3.5
- pNB42 series, 18.20
- pNLexA, 18.19
- Point mutation detection by ligase amplification
  - reaction, 1.157, 1.159
- Point-sink system of shearing DNA, A8.35
- polA* gene, *E. coli*, 9.82
- Pol I. *See* DNA polymerase, *E. coli* DNA polymerase I
- Pol3scan program, A11.14
- Polishing ends
  - of amplified DNA, 8.30, 8.32–8.34
  - in DNA sequencing protocols, 12.17
  - with Klenow, 12.17
  - with T4 DNA polymerase, 12.17
- Poly(A) polymerase, 1.13, 9.56
- Poly(A) RNA
  - cDNA library construction, 11.39
  - cDNA probe generation from, 9.38–9.40, 9.43, 9.48
  - in hybridization solutions, 6.51–6.52
  - integrity, checking, 11.39, 11.42
  - in northern hybridization, 7.45
  - in primer extension assays, 7.76
  - selection
    - by batch chromatography, 7.18–7.19
    - by oligo(dT)-cellulose chromatography, 7.13–7.17
  - on poly(U)-coated filters, 7.20
  - by poly(U)-Sephacrose chromatography, 7.20
  - by streptavidin-coated beads, 7.20
  - in Southern hybridization, 6.56
- Polyacrylamide
  - chemical structure of, A8.41
  - cross-linking, 5.41–5.42
  - structure of, 5.41
- Polyacrylamide gel electrophoresis. *See also* SDS-polyacrylamide gel electrophoresis of proteins
  - agarose gels compared, 5.2, 5.40
  - analysis of protein expression in transfected cells, 17.69
  - band-stab PCR of samples from gel, 8.71
  - caging, 17.13
  - in coimmunoprecipitation protocol, 18.61, 18.65, 18.68
  - denaturing, 5.40
  - DGGE (denaturing gradient gel electrophoresis), 13.91–13.92
  - DNA detection
    - autoradiography, 5.49–5.50
    - silver staining, 5.77
    - staining, 5.47–5.48
  - DNA fragment size resolution, percentage gel for, 7.56
  - DNA recovery
    - by crush and soak method, 5.51–5.54
    - by electroelution into dialysis bags, 5.23–5.25
  - DNA sequencing, 12.66–12.69, 12.74–12.93
    - autoradiography, 12.90–12.93
    - compression of bands, troubleshooting, 12.83, 12.109–12.110
    - loading, 12.88
      - base order, 12.88
      - loading devices, 12.88
    - marker dye migration rate, 12.89
    - preparation of, 12.74–12.84
      - air bubbles, 12.79
      - electrolyte gradient gels, 12.83–12.84
      - formamide containing, 12.81–12.82
      - glass plates, 12.76–12.78
      - leaking gels, 12.80
      - materials for, 12.74–12.75
      - pouring gels, 12.78–12.80
      - reading, 12.90–12.93
      - resolution of, 12.85
      - running, 12.85–12.89
      - safety precautions, 12.86
      - temperature-monitoring strips, 12.86
      - troubleshooting band pattern aberrations, 12.67–12.69, 12.82
      - wedge gels, 12.83
    - in DNase I footprinting protocol, 17.5, 17.10
    - DNA size selection in shotgun sequencing protocol, 12.18
    - drying gels, 5.50, 12.92
    - far western analysis of protein-protein interactions, 18.49–18.50
    - fixing gels, 5.49–5.50, 12.90–12.92
    - formamide in sequencing gels, 6.59
    - gel retardation assays, 17.13–17.17, 17.80
    - gel-loading buffers, 5.42
    - glass plates for, 12.76
    - in GST fusion protein pulldown technique, 18.55, 18.56, 18.59
    - glycerol and, 13.90
    - IEF and, 18.61
    - markers
      - migration rate of dyes, 7.57, 12.89
      - radiolabeled size, 9.54
    - method, nondenaturing, 5.44, 5.46
    - apparatus assembly, 5.44
    - bubbles, removal of, 5.45
    - casting gel, 5.45
    - de-aeration of acrylamide solution, 5.44
    - loading samples, 5.46
    - storage of gels, 5.45
    - nondenaturing, 5.40–5.46
    - in nuclease S1 mapping of RNA, 7.56–7.59
    - oligonucleotide purification, 10.11–10.16, 10.48
      - detection in gels, 10.16
      - eluting DNA, 10.15
      - materials for, 10.12–10.13
      - protocol, 10.13–10.16
    - in primer extension assay protocol, 7.77, 7.80–7.81
    - for protein separation, 15.17, 15.24, 15.29, 15.33
    - resolution, 5.40, 5.42
    - in ribonuclease protection assay
      - analysis of RNase-resistant hybrids, 7.73–7.74
      - purification of riboprobes, 7.71–7.72
      - size standards, 7.73–7.74
    - RNA purification, 9.35
    - silver staining DNA, A9.6–A9.7
    - single-strand conformation polymorphism and, 13.51, 13.54–13.55
    - spacers for, 12.76
    - tape, gel-sealing, 12.76, 12.78
    - temperature-monitoring strips, 5.43, 5.46
    - western blotting and, A9.28
  - polyadq program, A11.14
  - Polybrene, DNA transfection using, 16.3, 16.43–16.46
  - Polycloning sites, 1.10
  - Poly(dI-dC), 17.14–17.15
  - Polyethylene glycol (PEG)
    - DNA purification, 12.31
    - $\lambda$  particles, precipitation of, 2.43–2.44
    - in ligation reactions, 1.152, 1.154
    - for M13 concentration, 3.26–3.28
    - PEG 8000, A1.28
      - as crowding agent, 1.23
      - phosphorylation reaction enhancement, 9.70–9.71
      - in shotgun sequencing protocol, 12.18
      - in virus particle precipitation, 12.23
    - PEG-MgCl<sub>2</sub> solution, A1.21
    - plasmid DNA purification by PEG precipitation, 1.19, 1.152, 1.159–1.161
    - in protoplast fusion, 1.154
    - structure of, 1.154, 3.49
    - uses of, overview, 1.154, 3.49
  - Polyethylene imine for facilitation of DEAE transfection, 16.28
  - Polyhedral inclusion bodies (PIBs), 17.81
  - Polyhistidine-tagged proteins. *See* Histidine-tagged proteins
  - Polylinkers in vectors. *See* Linkers; *specific vectors*
  - Poly-L-lysine, 18.85, A10.5
  - Polymerase, DNA. *See* DNA polymerase
  - Polymerase chain reaction (PCR)
    - amplification of specific alleles, 13.48
    - analysis of
      - $\lambda$  recombinants, 2.33, 2.105
      - products, 8.44, 8.52, 8.58, 8.60, 8.65, 8.70–8.71, 8.75, 8.80, 8.85, 8.92–8.93
      - yeast colonies, 4.72–4.73
  - Band-stab, 8.71
  - cDNA amplification
    - of 3' ends, 8.61–8.65
      - amplification, 8.64–8.65
      - materials for, 8.61–8.63
      - reverse transcription, 8.64
    - of 5' ends, 8.54–8.60
      - amplification, 8.59–8.60
      - full-length clones, yield of, 8.59
      - materials for, 8.56–8.57
      - reverse transcription, 8.57–8.58
      - tailing reaction, 8.58–8.59
    - mixed oligonucleotide-primed, 8.66–8.71

- Polymerase chain reaction (*continued*)  
 analysis, 8.70–8.71  
 band-stab PCR and, 8.71  
 DNA template, 8.68–8.70  
 guessmers, 8.66–8.67  
 materials for, 8.69  
 method, 8.70–8.71  
 primer design rules, 8.67–8.68  
 variations in protocol, 8.67  
 RT-PCR, 8.46–8.53  
 cDNA characterization, rapid, 8.72–8.76  
 screening individual colonies or plaques, 8.74–8.75  
 method, 8.74–8.75  
 troubleshooting, 8.75  
 yeast colonies, 8.75  
 screening  $\lambda$  libraries, 8.76  
 cloning products  
 blunt end, 8.30–8.34  
 difficulty of, 8.30  
 end modification, 8.42–8.45  
 genetic engineering with PCR, 8.42–8.45  
 overview, 8.30–8.31  
 polishing termini, 8.30, 8.32–8.34  
 restriction site addition and, 8.31, 8.37–8.41  
 clamp sequences and, 8.38–8.39  
 diagram of procedure, 8.38  
 primer design tips, 8.37–8.38  
 problems, 8.37  
 protocol, 8.39–8.41  
 troubleshooting, 8.41  
 into T vectors, 8.31, 8.35–8.36  
 codon usage, changing, 15.12  
 components of  
 essential, 8.4–8.6  
 optional, 8.9  
 contamination in, 8.16–8.17  
 cycles, number required, 8.9, 8.12  
 detection of defined mutants, 13.48  
 diagram of amplification sequence, 8.19  
 differential display, 8.96–8.106  
 advantages of, 8.96  
 kits, 8.102  
 materials for, 8.101–8.102  
 method, 8.102–8.105  
 primers, 8.96  
 anchored, 8.99–8.100  
 arbitrary, 8.100  
 problems with, 8.96–8.99  
 schematic representation of, 8.97  
 tips for success, 8.106  
 digoxigenin labeling of nucleic acids, A9.38–A9.39  
 in direct selection of cDNA protocol, 11.98–11.100  
 DNA polymerase, thermostable, 8.4, 8.6–8.8  
 3'-5' exonuclease activity, 8.30  
 cocktail mixtures of, 8.7, 8.77  
 inactivation, 8.25, 8.29  
 obstructions to, 8.7  
 properties and applications, table of, 8.10–8.11  
 terminal transferase activity, 8.30  
 DNA preparation for  
 mammalian, 6.3, 6.16, 6.19–6.23, 6.27–6.28  
 yeast, 6.31  
 in DNA sequencing  
 with end-labeled primers, 12.51–12.55  
 with internal labeling, 12.60  
 efficiency calculations, 8.12  
 in end-labeling for chemical sequencing of DNA, 12.73  
 GC-Melt, 4.81  
 history of, 8.2–8.4  
 hot start, 4.81, 8.110  
 inhibition of, 8.13  
 by SYBR Gold dye, A9.8  
 inosine use in, 8.113  
 interaction trap positives, rapid screen for, 18.46–18.47  
 inverse PCR, 1.157, 4.74–4.75, 8.81–8.85  
 materials for, 8.82–8.83  
 method, 8.84–8.85  
 overview of, 8.81  
 restriction enzyme choice for, 8.81, 8.84–8.85  
 schematic representation of, 8.82  
 use of, 8.81  
 Klenow use in, A4.16  
 $\lambda$  recombinant analysis, 2.33, 2.105  
 ligation-independent cloning (LIC-PCR), 11.121–11.124  
 locating by linker-scanning mutagenesis, 13.76–13.77  
 long PCR, 8.77–8.80  
 method, 8.79–8.80  
 overview of, 8.77  
 primers, 8.79  
 template DNA, 8.78–8.79  
 melting temperature calculation, 8.15–8.16  
 multiplex, 8.107  
 mutagenesis, random (misincorporation mutagenesis), 13.80  
 mutation detection techniques and, 13.91–13.96  
 Perfect-Match, adding, 4.81  
 primer elimination by exonuclease VII, 7.86  
 primers, 8.4–8.5. *See also specific applications*  
 base composition, 8.14  
 concentration of, 8.5  
 design for basic PCR, 8.13–8.16  
 computer assisted, 8.15  
 melting temperature, 8.14–8.16  
 restriction sites, adding, 8.14, 8.37–8.38  
 factors influencing efficiency, 8.14  
 length, 8.14, 8.18  
 nested, 4.81  
 purification of, 8.5  
 repetitive or random primer use, 4.75  
 selecting primers, 8.13–8.15  
 specificity, 8.13  
 universal primers, 8.113–8.117  
 for  $\lambda$ gt10/ $\lambda$ gt11, 8.116  
 for M13 vectors, 8.115  
 for pBR322, 8.114  
 for pUC vectors, 8.115  
 transcription promoter primers, 8.117  
 programming  
 annealing, 8.8–8.9  
 denaturation, 8.8  
 extension of primers, 8.9  
 number of cycles, 8.9  
 promoter for RNA polymerases, addition to DNA fragments, 9.36–9.37  
 amplification conditions, 9.36  
 primer design, 9.36  
 protocol, basic, 8.18–8.24  
 bystander DNA, 8.21  
 controls, 8.21  
 materials for, 8.18–8.21  
 method, 8.21–8.22  
 optimization, 8.23  
 troubleshooting, 8.23–8.24  
 purification of products  
 for cloning, 8.25–8.26  
 methods for, 8.27  
 ultrafiltration for oligonucleotide and dNTP removal, 8.27–8.29  
 quantitative PCR, 8.86–8.95  
 amplification, 8.92  
 cDNA preparation, 8.91  
 detection and quantification of products, 8.92–8.93  
 materials for, 8.90–8.91  
 overview of, 8.86–8.89  
 real time PCR, 8.89, 8.94–8.95  
 reference template preparation, 8.91  
 references, externally added, 8.87–8.89, 8.91–8.93  
 semiquantitative methods, 8.89  
 standards, endogenous, 8.86–8.87  
 radiolabeling of DNA probes, 9.14–9.18  
 advantages of, 9.14  
 asymmetric probe production, 9.14, 9.18  
 methods used, 9.14–9.15  
 protocol for, 9.15–9.17  
 real time PCR, 8.89, 8.94–8.95  
 rescuing termini of YAC genomic inserts, 4.63  
 restriction enzyme digestion efficiency, use in monitoring, 2.66  
 RT-PCR, 8.46–8.53  
 controls/standards, 8.48–8.49, 8.51–8.52  
 enzymes, reverse transcriptase  
 inactivation of, 8.52  
 types used, 8.48  
 materials for, 8.49–8.51  
 method, 8.51–8.53  
 primers for, 8.46–8.48  
 troubleshooting, 8.53, 8.60  
 sequencing of PCR-amplified DNA, 12.106  
 single-site, 4.76–4.80  
 single-stranded radiolabeled probe production, 7.54  
 site-directed mutagenesis, 8.42–8.45, 13.7–13.10  
 megaprimer method, 13.8–13.10, 13.31–13.35  
 overlap extension, 13.8, 13.36–13.39  
 synthetic oligonucleotide cassette use, 4.76. *See also* Vectorette PCR  
 TAIL, 4.75  
 temperature ramping protocol, 8.70  
 template DNA concentration, 8.6, 8.20  
 template production for in vitro transcription, 7.70  
 theory, 8.12  
 touchdown, 8.112  
 vectorette PCR, 4.74–4.81  
 in vitro mutagenesis, 13.23–13.24  
 Polymerase dilution buffer, A1.9  
 Polynucleotide kinase, bacteriophage T4, A4.30, A4.35–A4.36  
 3' phosphatase activity of, 9.55  
 5' termini, phosphorylation of blunt/recessed, 9.70–9.72  
 5' termini, phosphorylation of oligonucleotide probe, 10.17–10.19  
 5' termini, phosphorylation of protruding, 9.66–9.69, 9.73–9.75  
 adaptor phosphorylation, 1.88–1.89, 11.55  
 in circular mutagenesis protocol, 13.24  
 DNA purification for, A4.35  
 end concentration, A4.36  
 end labeling, 9.55  
 for DNA sequencing, 12.8, 12.73  
 exchange reaction, 9.67, 9.73–9.75  
 forward reaction, 9.67–9.72  
 inactivation, 10.19  
 inhibition by ammonium ions, 9.65, A4.35  
 linkers/adaptors for cDNA, phosphorylation of, 11.55  
 oligonucleotide probes, phosphorylation of, 7.78  
 oligonucleotide-directed mutagenesis of single-stranded DNA, phosphorylation of primers in, 13.15–13.16  
 in probe production for primer extension assay, 7.78  
 radiolabeling oligonucleotides, 13.42–13.43  
 in S1 mapping of RNA, 7.56, 7.58  
 Polyomavirus origin of replication, 11.68  
 Polysomes, immunological purification of, 11.10  
 Poly(U)-Sephadex, 7.15, 7.20

- Polyvinylbenzyl(benzyltrimethylammonium) chloride, A9.19
- Polyvinylidene fluoride (PVDF), 9.78, A8.53
- Ponasterone A, 17.71–17.74
- Ponceau S, A9.28
- Positive selection, 1.12, 1.26–1.27
- Positive-displacement pipette use in PCR protocols, 8.19
- Potassium acetate solution, 6.28–6.29, A1.28
- Potassium chloride (KCl), A1.27
  - in long PCR buffer, 8.78
  - in PCRs, 8.6, 8.21
- Potassium ferrocyanide ( $K_4[Fe(CN)_6]$ )
  - in histochemical stain, 16.13
  - in X-GlcA solution, 16.42
- Potassium glutamate in PCR, 8.9
- Potassium hydroxide (KOH), A1.6, A1.20
- Potassium phosphate buffer, A1.5
- PowerBLAST program, A11.16
- pPCR-Script Direct, A3.2
- pGKpuro, 17.66
- pLc vectors, 15.4, 15.25
- PPO (2,5-diphenyloxazole) scintillant, A9.12
- pPROEX-1, 15.8
- PPSEARCH program, A11.17
- pPUR, 17.66
- pRB1840, 18.12
- Preflashing films, A9.11–A9.12
- Prehybridization solution
  - for dot, slot, and northern hybridization, A1.13
  - for northern hybridization, 7.42–7.43
- Prehybridization/hybridization solution
  - for hybridization in aqueous buffer, A1.13
  - for hybridization in formamide buffers, A1.13
  - for hybridization in phosphate-SDS buffer, A1.14
  - for plaque/colony lifts, A1.13
  - for transcriptional run-on assay protocol, 17.25
- pRFHM1, 18.19, 18.23–18.25, 18.44, A3.4
- Prime Inhibitor, 7.68, 7.77, 7.83, 9.38
- Primer extension, 7.75–7.81
  - analysis of products, 7.80–7.81
  - hybridization and extension of primer, 7.79–7.80
  - mapping regulatory sequences, 17.33
  - markers for gel electrophoresis, 7.76
  - materials for, 7.76–7.78
  - on microarrays, A10.17
  - for mutant detection, 13.91, 13.96
  - optimizing reactions, 7.76
  - overview, 7.75
  - probe preparation, 7.78–7.79
  - purification of products, 7.80
  - sequencing, 7.79
- Primer extension mix, 7.77
- Primer Generator computer program, 13.83
- Primer-adaptors in cDNA synthesis, 11.12–11.13, 11.15, 11.17–11.19, 11.39
- Prism system, 8.95
- pRM1/pRM9, 15.25
- proAB*, 11.23–11.24
  - $\lambda$  propagation and, 2.28–2.29
  - M13 vectors and, 3.10, 3.12–3.13
- Probes. *See also* DNA probes; Nonradioactive labeling; Radiolabeled probe preparation; RNA probes
  - AMPPD detection, A9.43
  - for cDNA screening, 11.27–11.32
  - digoxigenin containing, A9.38–A9.40
  - for far western analysis of protein-protein interactions, 18.48–18.53
  - in GST fusion protein pulldown protocol, 18.55–18.58
  - horseradish peroxidase containing, A9.35–A9.36
  - immunoblotting, A8.54–A8.55
- Probe synthesis buffer, 9.25
- ProBond, 15.46
- Prodom database, A11.22
- Profection, 16.5, 16.30
- Proline
  - cleavage by formic acid, 15.6, 15.8
  - codon usage, A7.3
  - nomenclature, A7.7
  - properties, table of, A7.9
  - prototrophs, 3.10–3.11
- Promoter-bashing experiments, 17.30
- Promoters. *See also* Regulatory elements of genes; SP6 bacteriophage, promoter; SV40 promoter; T3 bacteriophage, promoter; T7 bacteriophage, promoter
  - bacteriophage promoters in plasmid vectors, 1.11–1.12
  - of baculoviruses, 17.82
  - for expression of cloned genes in *E. coli*
    - choosing a promoter, 15.3–15.4
    - IPTG-inducible, 15.3, 15.14–15.19
    - $\lambda p_1$ , 15.4, 15.25–15.29
    - phoA*, 15.30–15.35
    - T7, 15.3–15.4, 15.20–15.24
  - in vitro transcription, 9.29–9.37
  - $\lambda$ , 2.5–2.8, 2.14, 2.17, 15.4, 15.25–15.29
  - locating by linker-scanning mutagenesis, 13.75
  - in low-copy-number plasmid vectors, 1.12
  - mapping with primer extension, 17.33
  - in plasmid expression vectors, 1.13–1.14
  - reporter assays, 17.30–17.51
- Pronase, A4.50
- Prophage,  $\lambda$ 
  - integration, 2.16
  - transcription, 2.17–2.18
- PROSITE program, A11.17
- Protease inhibitors
  - for optimization of protein expression, 15.19
  - table of, A5.1
- Proteases
  - cellular heat shock genes, 15.25
  - for cleavage of fusion proteins, 15.7–15.8, 15.39–15.40, 15.43
  - cleavage site analysis using substrate phages, 18.116
- Protection assays
  - nuclease S1, 7.51–7.62
  - ribonuclease, 7.63–7.74
- Protein A, 18.81, A9.46–A9.47
  - affinity purification of fusion proteins, 15.4, 15.6
  - in antibody purification, 14.5, 14.16, 14.51, 18.81, A9.25–A9.26
  - applications of, A9.48
  - radiolabeled, 14.9, 14.19
- Protein A–Sepharose columns, 11.10, 14.5, 14.16, 14.51, 18.81
- Protein G, 18.81, A9.46–A9.48
- Protein inhibitors of RNases, 7.68, 7.71, 7.77, 7.79, 7.83
- Protein kinase A, 18.49, 18.51
- Protein kinase C $\alpha$  (PKC $\alpha$ ), 18.78, 18.88, 18.93–18.95
- Protein L, A9.46–A9.47, A9.49
- Protein microarrays, A10.18
- Protein Refolding Kit, 15.53
- Protein truncation test (PTT), 13.92
- Proteinase K, 5.78, A1.8
  - for alkaline phosphatase inactivation, 2.70, 9.64, 12.24
  - in cDNA first-strand synthesis protocol, 11.42
  - in DNA isolation from mammalian cells, 6.5, 6.9–6.10, 6.22, 6.28–6.29
  - in DNase I hypersensitivity mapping, 17.20–17.21
  - in genomic DNA isolation from mouse tails, 6.24–6.26
  - inactivation of, 8.26
  - inhibition of PCR by, 8.13
  - in  $\lambda$  DNA extraction, 2.56–2.58
  - for lysis of cells in agarose plugs, 5.62, 5.64, 5.67
  - overview of, A4.50
  - in PCR lysis solution, 6.22
  - in PCR product purification protocol, 8.26
  - for restriction enzyme inactivation, 12.24
  - in ribonuclease protection assay protocol, 7.73
  - for RNase removal, 9.33
  - stripping probes from filter and, A9.38
  - in transcriptional run-on assay protocol, 17.28
- Proteinase K buffer, A1.11
- Protein-protein interactions, 18.1–18.127
  - coimmunoprecipitation, 18.60–18.68
    - cell lysis, 18.62, 18.65
    - controls, 18.63–18.66
    - identification of proteins, 18.66
    - immunoprecipitation of cell lysate, 18.62–18.63
    - materials for, 18.67–18.68
    - method, 18.68
    - nonspecific interactions, reducing, 18.65–18.66
    - procedure, outline of, 18.61–18.62
  - far western analysis, 18.48–18.54
  - anti-GST antibodies, 18.54
  - materials for, 18.50–18.51
  - method, 18.52–18.53
  - refolding membrane-bound proteins, 18.53
  - troubleshooting, 18.53
- filamentous phage display, 18.115–18.122
  - affinity selection and purification of bacteriophages, 18.121
  - commercial display systems, 18.120–18.121
  - of foreign proteins, 18.121–18.122
  - interaction rescue, 18.122
  - of peptides, 18.116–18.121
    - constrained libraries, 18.120–18.121
    - construction of libraries, 18.117–18.119
    - random peptide libraries, 18.116–18.117
  - vectors used for, 18.115–18.116, 18.118
- FRET, 18.69–18.95
  - detection methods, 18.72–18.74
  - donor quenching, 18.73
  - photobleaching, acceptor, 18.73
  - steady-state fluorescence intensity measurements, 18.72–18.73
- FLIM-FRET, 18.78–18.95
  - cell preparation for, 18.84–18.89
  - data acquisition, 18.90–18.95
  - flow diagram, 18.79
  - imaging protein phosphorylation with, 18.78
  - labeling proteins with fluorescent dyes for, 18.80–18.83
  - fluorescence lifetime, 18.73–18.74
  - photophysical principles of, 18.70–18.72
- GST fusion proteins
  - far western analysis, 18.48–18.54
  - pulldown technique, 18.55–18.59
    - materials for, 18.57–18.58
    - method, 18.58–18.59
    - outline of, 18.56
    - troubleshooting, 18.59
  - mass spectrometry, 18.3
  - molecular modeling, 18.3
  - overview, 18.2–18.5
  - questions posed by, 18.2
  - Ras recruitment system (RRS), 18.127
  - Sos recruitment system (SRS), 18.126–18.127
  - strategies for studying, overview of, 18.3–18.4
  - surface plasmon resonance (SPR), 18.96–18.114
    - concentration measurement, 18.102
    - data collection, 18.100–18.101
    - instruments of, 18.96
    - kinetic measurements, 18.101–18.102
    - overview, 18.97–18.98

- Protein-protein interactions (*continued*)  
 protocol, 18.103–18.114  
   capture surface preparation, 18.105  
   data analysis, 18.112–18.114  
   design, 18.103  
   kinetic analysis, 18.108–18.114  
   test binding, 18.106–18.107  
 schematic of, 18.97  
 sensor chips, 18.98–18.100  
   regeneration of surface, 18.100  
 two-hybrid system, 18.3–18.4, 18.6–18.47  
   bait, dual, 18.11–18.13  
   bait and hook, 18.10–18.11  
   baits, modified, 18.6–18.8  
   baits, troubleshooting, 18.27  
   diagram of, 18.7  
   false positives, 18.14–18.15  
   flow chart, 18.16  
   genomic analysis, 18.123–18.124  
   interaction trap. *See* Interaction trap  
   modifications of, 18.14–18.15  
   non-yeast, 18.127  
   peptide-protein interactions, 18.8–18.9  
   protocol  
     baits, troubleshooting/modification of, 18.27  
     expression of bait protein, detecting, 18.26  
     flow chart, 18.16  
     rapid screen for interaction trap positives, 18.46–18.47  
     replica technique, 18.29  
     repression assay for DNA-binding, 18.23–18.25  
     Stage 1: Bait-LexA fusion protein characterization, 18.17–18.29  
     Stage 2: Interactor selection, 18.30–18.37  
     Stage 3: Second confirmation of positive interactions, 18.38–18.47  
   reverse two-hybrid system, 18.11–18.12  
   RNA polymerase-III-based, 18.15  
   swapped system, 18.15  
   ternary complexes, 18.9–18.10  
   vectors, 18.14, 18.19–18.20, 18.22  
     activation domain fusion plasmids, 18.20  
     LexA fusion plasmids, 18.19  
     reporter plasmids, 18.22  
   yeast CM selective media requirements, 18.21, 18.32, 18.40  
   yeast strains for selection, 18.22  
 ubiquitin-based split-protein sensor (USPS), 18.125–18.126
- Proteins. *See also* Fusion proteins; Protein-protein interactions  
 absorbance of, A8.21  
 biotinylation of, 11.115–11.117  
 chaotropic agent, denaturation of, 15.60  
 databases, bioinformatics, A11.22–A11.23  
 DNA interactions, 18.125  
 identification, 18.66  
 immunoblotting, A8.52–A8.55  
 mass maps, 18.66  
 molar conversion table, A7.7  
 refolding of membrane-bound, 18.53  
 refolding solubilized proteins from inclusion bodies, 15.53–15.54  
 software, bioinformatics, A11.16–A11.17  
 western blotting, A9.28  
 Proteolytic enzymes, A4.50  
 Protomap database, A11.22  
 Protoplast fusion, 1.154  
 Protruding termini  
   adaptor attachment to, 1.88–1.89  
   cloning DNA fragments with, 1.20–1.21  
   phosphorylation of, 9.66–9.69  
 PRPP progressive global alignment program, A11.8  
 pRS303, 304, 305, 306, A3.4  
 pRS313, 314, 315, 316, A3.5  
 pRS323, 324, 325, 326, A3.5  
 pRSA101, 3.42  
 PRSS program, A11.4  
 pRT601, 11.109  
 pSC101, A3.2  
   incompatibility locus, 1.8  
   plasmid growth and replication, table of, 1.17  
   replicon in, 1.1.4, 1.4  
 pSE280, A3.2  
 Pseudobase database, A11.21  
 Pseudoscreening protocol, 14.23–14.24  
 pSGR3, 13.73  
 pSH17-4, 18.19, 18.23–18.25, 18.28, A3.4  
 pSH18-34, 18.12, 18.24, A3.5  
 PSI-BLAST (position-specific BLAST) program, A11.18  
 pSK vectors for fusion protein construction, 15.5  
 pSKAN, 18.120  
 pSP18/19, A3.2  
 pSPL1, 11.79  
 pSPL3, 11.79, 11.81–11.85, 11.89, A3.4  
 pSPORT1, 11.25, 11.28, 11.63, A3.2  
   in commercial kits for cDNA synthesis, 11.108  
   expression cloning, 11.72  
 pSRI recombinase, 4.85  
*Pst*I  
   7-deaza-dGTP modified DNA, cleavage of, 8.60  
   cleavage at end of DNA fragments, A6.4  
   homopolymeric tailing reactions and, 11.110–11.111  
   linker sequences, 1.99  
 pSV2CAT, 17.95  
 pSV2-His, 17.61–17.63, 17.65  
 pSV2neo, 16.48  
 pSV3neo, 16.48  
 pSVOCAT, 17.95  
 pTA1529, 15.5, 15.32  
 PTEN phosphatase, 17.72  
 pTet-Splice, 17.57–17.58, 17.61, 17.66, 17.70, A3.4  
 pTet-tTak, 17.57–17.58, 17.60–17.62, 17.65, 17.70, A3.4  
 pTK-HYG, 17.61, 17.66  
 pTrc99A, 15.15  
 pTrx, 15.5, A3.2  
 pTrxFus, 15.4–15.5, 15.25, A3.2  
*ptsM* gene, 2.4  
 pTZ18, A3.2  
 PubMed, 1.14, A10.15  
 pUC vectors, 1.9–2.0, A3.2  
    $\alpha$ -complementation, 1.10, 3.9  
    $\beta$ -galactosidase gene, 1.10, 1.27  
   copy number, 1.6  
   expression libraries, 14.14  
   for fusion protein construction, 15.5  
   *lacZ* fragments in, 1.10, 3.9  
   for LacZ fusion protein expression, 15.59  
   M13 and, 3.9, 3.14  
   multiple cloning sites, table of, 3.14  
   plasmid growth and replication, 1.17  
   primers for cloning sites in, 8.115  
   replicon in, 1.4, 1.6  
 pUC17, A3.2  
 pUC18, 8.115, 11.111, A6.5  
 pUC19, 8.115, A3.3, A6.5  
 pUC118/119, 3.42, 13.18  
 pUHC13-3, 17.66, 17.70  
 pUK vectors for LacZ fusion protein expression, 15.59  
 Pulse-chase experiments, 15.18–15.19  
 Pulsed-field gel electrophoresis (PFGE)  
   apparatus types, 5.56–5.57  
   CHEF, 5.57, 5.79–5.82  
   conditions for, 5.79–5.80  
   electrode configuration, 5.57  
   method, 5.81–5.82  
   pulse times, 5.79–5.80  
   resolution, 5.79  
 DNA preparation for  
   from mammalian cells/tissues, 5.61–5.64  
   overview, 5.59  
   RE digestion in agarose plugs, 5.68–5.70  
   from yeast, 5.65–5.67  
 DNA recovery  
   direct retrieval, 5.83–5.85  
   following DNA concentration, 5.86–5.88  
 high-capacity vector insert size determination, 4.18  
 molecular-weight markers, 5.59–5.60, 5.71–5.73  
 overview, 5.2–5.3, 5.55–5.56  
 resolution, 5.3  
   factors affecting, 5.57–5.58  
   field angle, 5.59  
   pulse time, 5.58, 5.74–5.75, 5.79–5.80  
   temperature, 5.59  
   voltage, 5.58–5.59  
 restriction enzyme use with, 5.60, 5.68–5.70  
 TAFE, 5.56–5.57, 5.74–5.78  
   electrode configuration, 5.57  
   method, 5.76–5.78  
   pulse times, 5.74–5.75  
   resolution, 5.74  
   silver staining, 5.77  
   Southern blots, 5.77–5.78  
   theory overview, 5.55–5.56  
 pUR vectors for LacZ fusion protein expression, 15.59  
 Purification of plasmid DNA. *See* Plasmid DNA, purification  
 Purine molecules, numbering of atoms on, A6.5  
 Puromycin, 16.49, 17.65–17.67, 17.69, A2.7  
 Puromycin-*N*-acetyl transferase, 16.47, 16.49  
 Putrescine, 4.21  
 PVDF membranes  
   colorimetric detection of nonradioactive probes on, 9.78  
   for immunoblotting, A8.53  
 pVgRXR, 17.74, A3.4  
 pVHL protein, 18.60, 18.62, 18.64–18.65  
*Pvu*I methylation, 13.87, A4.3, A4.7  
*Pvu*II  
   in pSPL3, 11.84  
   in USE, 13.85  
*Pvu*II methylase, A4.7  
*Pwo* DNA polymerase, 8.11, 8.30  
   in circular mutagenesis, 13.20, 13.21  
   in overlap extension method of mutagenesis, 13.37  
   properties, table of, A4.23  
 pXF3, 1.9, A3.3  
 pYAC4, 4.59, 4.63, 4.76, A.65  
 pYD1, 18.120  
 pYD1 Yeast Display Vector Kit, 18.120  
 pYESTrp, 18.20  
 Pyridopyridazines, A9.18  
 Pyrimidine molecules, numbering of atoms on, A6.5  
 Pyrimidine tract analysis, 12.3  
 Pyrophosphatase, 9.88  
   in DNA sequencing protocols, 12.34–12.36, 12.39  
   dUTPase, 13.85  
 Pyrophosphate  
   in automated DNA sequencing protocols, 12.95  
   luciferase and, A9.22  
 Pyroxylin, 6.14  
 pZL1, 11.25, A3.3  
 Q358 and Q359 *E. coli* strain  
   genotype, A3.9  
    $\lambda$  vector propagation, 2.28–2.29  
 QAE (diethyl[2-hydroxy-propyl]aminoethyl), 1.19  
 QBT buffer (Qiagen), A1.21

- Q gene,  $\lambda$ , 2.8–2.9, 2.12, 2.14  
 Qiagen BioRobot, A10.5  
 Qiagen resins, DNA purification on, 4.45  
 QIAprep, 1.64, 8.27  
 QIAprep Turbo miniprep, 12.27  
 QIAquick, 8.26  
 Quantitation of nucleic acids, A8.19–A8.24  
   fluorometry, A8.22–A8.24  
     ethidium bromide use, A8.19, A8.23–A8.24  
     agarose plate method, A8.24  
     minigel method, A8.24  
     spot test, A8.19, A8.24  
     with Hoechst 33258, A8.19, A8.22–A8.23  
   methods, summary of (Table 8-4), A8.19  
   spectrophotometry, A8.20–A8.21  
 Quaternary alkylammonium salts, 10.6  
 Quaternary ammonium salts, 10.35–10.37  
 Quik Change site-directed mutagenesis kit, 13.21, 13.89  
*qut* site,  $\lambda$ , 2.14
- R1 replicon, 1.12–1.13  
 R6K, A3.3  
 R408, 3.42, 3.44  
 R594 *E. coli* strain  
   genotype, A3.9  
    $\lambda$  vector propagation, 2.28  
 3'-RACE and 5'-RACE. *See* Rapid amplification of cDNA ends (RACE)  
 Radioactive ink, 1.142, 2.97–2.98, A1.21  
 Radioactivity, measuring  
   adsorption to DE-81 filters, A8.26  
   precipitation of nucleic acids with TCA, A8.25–A8.26  
   specific activity, calculating, A8.26  
 Radioimmunoassay (RIA), A9.29  
 Radiolabeled probe preparation, 9.1–9.93  
   asymmetric probes, 9.14, 9.18  
   cDNA probes  
     subtracted, 9.90–9.91  
     by random extension, 9.46–9.50  
     using oligo(dT) primer, 9.41–9.45  
     using oligo(dT) primer, 9.41–9.45  
     using random oligonucleotide primers, 9.38–9.40  
   dephosphorylation of DNA fragments with alkaline phosphatase, 9.62–9.65  
   end-labeling  
     3' termini with cordycepin or dideoxyATP, 9.60–9.61  
     3' termini with Klenow, 9.51–9.56, 9.83–9.85  
       materials for, 9.53  
       overview of, 9.51–9.53  
       protocol, 9.54  
       uses for, 9.51  
     3' termini with T4 DNA polymerase, 9.57–9.59  
     5' termini with T4 polynucleotide kinase, 9.55, 9.66–9.75  
       blunt/recessed 5' termini, 9.70–9.72  
       by exchange reaction, 9.73–9.75  
       protruding 5' termini, 9.66–9.69, 9.73–9.75  
   methods, table of, 9.55–9.56  
   with poly(A) polymerase, 9.56, 9.61  
   with RNA ligase, 9.56, 9.61  
   with terminal transferase, 9.55–9.56, 9.60–9.61  
   with Klenow fragment, 10.30–10.34  
   methods of radiolabeling, table of, 9.3  
 PCR, 9.14–9.18  
   advantages of, 9.14  
   asymmetric probe production, 9.14, 9.18  
   methods used, 9.14–9.15  
   protocol, 9.15–9.17  
 random priming  
   components of reactions, 9.5–9.6  
   DNA polymerase, 9.5  
   primers, 9.5–9.6  
   radiolabel, 9.5  
   template DNA, 9.6  
   in melted agarose, 9.9–9.11  
   nick translation compared, 9.4  
   protocols, 9.6–9.11  
 RNA probes  
   in vitro transcription, 9.29–9.37  
   materials for, 9.32–9.33  
   PCR, promoter addition, 9.36–9.37  
   plasmid vectors, 9.29–9.31  
   protocol, 9.33–9.35  
   in situ hybridization, 9.35  
   troubleshooting, 9.36  
 single-stranded DNA from M13  
   defined length, 9.19–9.24  
   heterogeneous length, 9.25–9.28  
   premature termination, 9.24  
 Radiolabeled probes. *See also* Hybridization;  
 Radiolabeled probe preparation  
   calculation of the specific activity of, A8.26  
   denaturation of, 1.140–1.141  
   denaturing double-stranded, 2.98, 6.54  
   DNase I footprinting protocol, 17.5, 17.7  
   in DNase I hypersensitivity mapping protocol, 17.21  
   in dot/slot hybridization, 7.48, 7.50  
   end-labeled, 7.54  
   in gel retardation assays, 17.13–17.16  
   northern hybridization, 7.43–7.44  
     low stringency, 7.43  
     stripping probes, 7.44  
   oligonucleotide purification by  
     precipitation with CPB, 10.22–10.24  
     precipitation with ethanol, 10.20–10.21  
     Sep-Pak C<sub>18</sub> chromatography, 10.28–10.29  
     size-exclusion chromatography, 10.25–10.27  
   phosphorylation of 5' termini of oligonucleotides, 10.17–10.19  
   purification, 6.56, 7.45  
   purity, 2.98  
   reuse of, 1.141  
   RNA probes, 6.58, 7.54  
   ribonuclease protection assays, 7.63–7.74  
   S1 protection assays, 7.51–7.62  
   screening bacterial DNA on filters, 1.138–1.142  
   screening clones for site-directed mutagenesis, 13.40–13.47  
   screening expression libraries, 14.3, 14.31–14.36  
   screening M13 plaques with, 3.41  
   single-stranded DNA probes, 6.58  
 Southern hybridization  
   low-stringency hybridization, 6.58  
   nonradioactive probes, 6.50  
   overview, 6.50  
   protocol, 6.51–6.55  
     hybridization, 6.54  
     prehybridization, 6.53–6.54  
     washing, 6.54–6.55  
   sensitivity, 6.50  
   stripping from membranes, 6.57  
 Radiolabeling. *See also* Radiolabeled probe preparation  
   antibody, A9.30  
   IgG, radioiodination of, 14.5, 14.16  
   for screening expression libraries, 14.3, 14.5, 14.16  
   CAT reporter assay, 17.36, 17.38–17.41  
   in coimmunoprecipitation protocol, 18.62  
   for DNA sequencing, 12.36, 12.43, 12.49–12.54, 12.60  
   asymmetric labeling, 12.72  
   chemical, 12.64  
   end-labeling by PCR, 12.73  
   in DNase I footprinting protocol, 17.5, 17.7  
   end labeling, 4.33, 12.73  
   for far western analysis of protein-protein interactions, 18.49, 18.52  
   in gel retardation assays, 17.13–17.15  
   with Klenow fragment, 12.101–12.102, A4.15  
   of oligonucleotides by phosphorylation, 13.42–13.43  
   pulse-chase experiments, 15.18–15.19  
   in restriction enzyme digestion efficiency monitoring, 2.66  
   RNA by RNA ligase, A4.30  
   with T4 DNA polymerase, A4.18–A4.19  
   with T4 DNA polynucleotide kinase, A4.35  
   with terminal transferase, A4.27  
   for transcriptional run-on assays, 17.23–17.24, 17.27–17.28  
 RAG1/RAG2 (recombination activating genes), 17.56  
 RainX, 12.75  
 Random priming buffer, 9.6, 9.47  
 Random priming in digoxigenin labeling of nucleic acids, A9.38–A9.39  
 Rapid amplification of cDNA ends (RACE), 18.14  
   3'-RACE, 8.61–8.65  
   5'-RACE, 8.54–8.60  
 Ras recruitment system (RRS), 18.125–18.126  
 Rat, genomic resources for microarrays, A10.6  
 RB791 *E. coli* strain, A3.9  
*rBst* DNA polymerase, A4.23  
 Real time PCR, 8.89, 8.94–8.95  
   advantages/disadvantages, 8.95  
   fluorometric detection, 8.94  
   instruments for, 8.95  
   TaqMan method, 8.95  
 Reassociation kinetics, 7.65–7.66  
 REBASE (restriction enzyme database), 1.16, 13.88, A4.3–A4.4, A4.9  
*recA* gene, 1.15, 2.28–2.29  
 RecA protein  
   chi site and, 2.13  
    $\lambda$  CI protein cleavage, 2.8, 2.18  
*recA1*, M13 vectors and, 3.11–3.13  
*recB*, 1.15, 2.11, 2.13, 2.28  
*recC*, 2.11, 2.28  
*recD*, 2.11, 2.13, 2.28  
 RecF, 1.15  
 RecJ, 1.15  
 RecO, 1.15  
 Recombinant phage antibody system, 18.120  
 Recombination  
   chi sites and, 2.13  
   Cre-*loxP* recombination system, 4.82–4.85, 11.25–11.26  
   in  $\lambda$ -infected cells, 2.11–2.13  
   M13 vectors and, 3.11–3.13, 3.16  
 Recombination activating genes (RAG1/RAG2), 17.56  
 RecQ, 1.15  
*red*,  $\lambda$ , 2.11, 2.20, 2.22  
 Red blood cell lysis buffer, 5.62, 6.28–6.29  
 REF select program, 13.94  
 Regulatory elements of genes. *See also* Promoters  
   detection by transcriptional run-on assays, 17.23  
   gel retardation assays for DNA-binding proteins, 17.13–17.17  
   identification by linker-scanning mutagenesis, 13.75–13.77  
   mapping by DNase I footprinting, 17.18–17.22  
   mapping by DNase I hypersensitivity sites, 17.18–17.22  
   mapping by hydroxyl radical footprinting, 17.12  
   reporter assays, 17.30–17.51  
      $\beta$ -galactosidase, 17.48–17.51  
     CAT, 17.33–17.41  
     luciferase, 17.42–17.47  
     overview, 17.30–17.32



- Renilla reniformis*, 17.89, 17.96, A9.22  
 Renin, 15.8  
*repA* gene in runaway plasmid vectors, 1.13  
 RepA protein, 1.4, 1.8  
*repI* in bacterial artificial chromosome, 4.2, 4.48  
 Repelcote, 12.75  
 Repetitive DNA sequences, amplification of, 8.106  
 Replacement vectors, *λ*, 2.19, 2.22, 2.64–2.65  
 Replication, DNA  
   chromosomal, chloramphenicol blockage of, 1.143  
   plasmid, 1.4–1.7  
     diagram of, 1.5  
     incompatibility of plasmids, 1.7–1.8  
     initiation of DNA synthesis, 1.5–1.6  
     inverted repeat lethality, 1.15  
     regulation by RNAI, 1.6–1.7  
     relaxed, 1.4, 1.17  
     runaway, 1.13  
     stringent, 1.4, 1.17  
 Replication, M13, 3.2, 3.5–3.7  
 Replicative form (RF), M13, 3.2, 3.5–3.6, 3.23–3.25  
 Replicons  
   ARS, 4.2–4.3, 4.60  
   chloramphenicol amplification and, 1.143–1.144  
   colEI, 1.3–1.4, 1.13, 1.15, 1.17, 1.143, 4.2, 4.5, 11.22–11.24, 15.3  
   *E*, 4.2–4.3  
   *H1*, 11.22–11.24  
   in high-capacity vectors, 4.4  
   incompatibility of plasmids, 1.7–1.8  
   low-copy-number plasmid vectors, 1.12  
   P1, 4.4, 4.37  
   plasmid copy number and, 1.3–1.4, 1.12  
   SV40, 4.5  
   table of, 1.4  
 Reporter assays, 17.30–17.51  
    $\beta$ -galactosidase, 17.48–17.51  
   CAT, 17.33–17.41, 17.95  
   GFP, 17.85–17.87  
   luciferase, 17.42–17.47, 17.96, A9.21, A9.23  
   overview, 17.30–17.32  
 Reptation, 5.2, 5.56, 12.114  
 Rescue buffer, 18.39  
 Resequencing, A10.17  
 Resins, 1.62–1.64. *See also* Chromatography  
   for DNA purification, 1.63–1.64, 5.26  
   ion-exchange, formamide deionization, 6.59  
   oligonucleotide purification, 10.49  
   table of commercially available, 1.64  
 Resolvases, 13.91, 13.94  
 Resolver program, A10.15  
 Restriction digestion of DNA for Southern analysis, 6.39–6.40, 6.42  
 Restriction endonuclease fingerprinting (REF), 13.91, 13.94  
 Restriction enzymes. *See also* Restriction sites; *specific enzymes*  
   in adaptor use, 1.89  
   adenine methylation and, 13.87–13.88  
   agarose plugs, DNA digestion, 5.68–5.70, 5.78  
   boiling lysis plasmid DNA preparations and, 1.18, 1.43  
   cleavage near ends of DNA fragments, 1.86, 8.31, 8.37–8.38, A6.4  
   cyclic coiled DNA resistance to cleavage, 1.40, 1.45, 1.49  
   digestion efficiency, monitoring, 2.66–2.67  
   DNA resistance to cleavage  
     alkaline lysis preparations, 1.33, 1.36, 1.42  
     boiled lysis preparations, 1.45, 1.49  
   in exonuclease III mutagenesis protocol, 13.57–13.59  
   fragment size created by, table of, A4.8  
   genomic DNA mapping, 5.68–5.69  
   inhibition by agarose, 5.18, 5.29  
   inhibition by cell wall components, 1.33, 1.36, 1.42, 3.24  
   inverse PCR and, 8.81–8.83  
   ligation reactions, inclusion into, 1.100  
   linker sequences for, 1.99  
   partial digestion of eukaryotic DNA for genomic libraries, 2.76–2.83  
   pulsed-field gel electrophoresis, use with, 5.60, 5.68–5.70  
   use in BAL 31 mutagenesis protocol, 13.63, 13.66  
 Restriction enzyme buffers, effect on DNA migration in agarose, 5.10  
 Restriction mapping  
   BAL 31 nuclease use for, 13.68  
   of cosmid/genomic DNA recombinants, 4.33  
   YAC genomic inserts, 4.63  
 Restriction mutations, M13, 3.10–3.13  
 Restriction sites  
   addition to 5' termini of PCR primers, 8.31, 8.37–8.39  
   clamp sequences, 8.38–8.39  
   enzyme choice, 8.37–8.38  
   frequency in human genome, 4.16, A6.3  
   in linkers/adaptors, 1.98–1.100, 11.20–11.21, 11.48–11.52, 11.64  
   methylation of, A4.5–A4.9  
     *dam* methyltransferase, A4.3  
     isoschizomer pairs, table of, A4.6  
     mutagenesis to create/remove, 13.83  
     removal by USE mutagenesis, 13.26–13.30, 13.85  
 Restriction/modification systems, A4.4. *See also* Methylation  
 Retinoid X receptor (RXR), 17.71, 17.73  
 Rev response element (RRE), 18.11  
 Reverse transcriptase, 8.48, 8.51–8.52, A4.24–A4.26  
   in 3'-RACE protocol, 8.61–8.62, 8.64  
   5'-3' polymerase activity, A4.24  
   in 5'-RACE protocol, 8.54–8.58, 8.60  
   ALV, 11.11  
   AMV, 8.48, 11.38, 11.109  
   cDNA first strand synthesis, 11.38–11.42  
   in cDNA probe construction, 9.39–9.40, 9.42–9.43, 9.47–9.48  
   controls for activity variation, 9.40, 9.43, 9.48  
   in differential display-PCR, 8.97, 8.101, 8.103  
   digoxigenin labeling of nucleic acids, A9.39  
   in exon trapping/amplification protocol, 11.89–11.91  
   inactivation, 8.52, 8.103  
   Mo-MLV, 8.48, 9.39, 9.42, 9.47, 11.11, 11.38, 11.40–11.41, 11.109–11.110  
   in primer extension assays, 7.75, 7.77, 7.79  
   properties, table of compared, A4.11  
   in quantitative RT-PCR, 8.91  
   RNase activity, 11.11–11.12, A4.24–A4.25  
   *Tth* DNA polymerase, 8.48  
   types of, 11.11–11.12  
   uses, list of, A4.25–A4.26  
 Reverse transcriptase buffer, A1.11  
 Reverse transcriptase-PCR. *See* RT-PCR  
 Reversed-phase chromatography, 10.11, 10.15–10.16  
   for DNA purification, 5.26  
   oligonucleotide purification, 10.49  
*rexA* gene,  $\lambda$ , 2.3, 2.17  
*rexB* gene,  $\lambda$ , 2.3, 2.17  
 RF6333, *E. coli*, 15.19  
 RFY206, 18.22  
*R* gene,  $\lambda$ , 2.15–2.16  
 Rhodamine, 12.96–12.98, A9.33  
 Rhodium, 17.77  
 Ribonuclease. *See* RNase  
 Ribonuclease protection assays, 7.63–7.74  
   diagram of, 7.64  
   northern hybridization compared, 7.63–7.65  
   protocol  
   analysis by gel electrophoresis, 7.73–7.74  
   digestion of hybrids, 7.73  
   dissolving nucleic acid pellets, 7.72  
   hybridization, 7.72–7.73  
   materials for, 7.67–7.68  
   probe preparation, 7.70–7.72  
   quantification of RNA in samples, 7.63, 7.65–7.66  
   S1 protection assay compared, 7.65  
   sensitivity of, 7.63–7.65  
 Riboprobe Gemini Systems, 9.32  
 Ribosomal protein S10, 2.7  
 Ribosomal RNA mutation databases, A11.21  
 Ribosome-binding site, 15.11–15.12, 15.18  
 Rifampicin  
   inhibition of bacteriophage T7 RNA polymerase, 15.20  
   modes of action, A2.7  
 RNA  
   5' cap, 9.88  
   concentrating. *See* Concentrating nucleic acids  
   concentration determination by spectrophotometry, 7.8, 7.16  
   CsCl density gradients, 1.155  
   databases, bioinformatics, A11.21–A11.22  
   denaturation  
   with formamide, 6.59  
   by heat, 8.51  
   dephosphorylation, 9.65  
   electrophoresis, agarose gel, 7.21–7.23, 7.27–7.34  
   equalizing RNA amounts in, 7.22–7.23  
   formaldehyde-containing gels, 7.31–7.34  
   glyoxylated RNA, 7.27–7.30  
   integrity of RNA, checking methods, 7.30  
   markers for, 7.23, 7.29  
   end-labeling  
   3' termini, 9.56  
   5' termini, 9.55  
   hybridization  
   dot and slot, 7.46–7.50  
   northern hybridization protocol. *See* Northern hybridization  
   LiCl precipitation of, 1.59  
   mapping  
   mung bean nuclease, 7.55  
   nuclease S1, 7.51–7.62  
   primer extension, 7.75–7.81  
   ribonuclease protection assays, 7.63–7.74  
   polymerase (*see* RNA polymerase)  
   precipitation with LiCl, 1.59, 1.82–1.83  
   probes, 7.54  
   for in situ hybridization, 9.35  
   purification of, 7.54  
   ribonuclease protection assays, 7.63–7.74  
   screening expression libraries, 14.2  
   synthesis of single-stranded probes by in vitro transcription, 9.29–9.37  
   protein interaction, studying with bait and hook strategy, 18.10–18.11  
   purification  
   acid phenol-guanidinium thiocyanate-chloroform extraction, 7.4–7.8  
   DNA contamination, 7.8, 7.12  
   ethanol precipitation, 9.34–9.35  
   gel electrophoresis, 9.35  
   isopropanol precipitation, 7.7, 7.12  
   poly(A)<sup>+</sup> RNA selection by batch chromatography, 7.18–7.19  
   poly(A)<sup>+</sup> RNA selection by oligo(dT)-cellulose chromatography, 7.13–7.17  
   simultaneous preparation with DNA and protein, 7.9–7.12  
   spun-column chromatography, 9.35  
   quantitation. *See* Quantitation of nucleic acids  
   RNAI  
   decay due to *pcnB* gene, 1.13

- degradation, 1.7  
 regulation of replication, 1.6–1.8  
 Rom binding, 1.7
- RNAL1, 1.4–1.7  
 mutation in pUC plasmid family, 1.6  
 priming of DNA synthesis at *colE1* origins, 1.5–1.6  
 RNAI interaction, 1.6–1.7  
 RNase H transcript processing of, 1.6  
 Rom binding, 1.7
- software, bioinformatics, A11.14–A11.15
- staining  
 ethidium bromide binding, 1.151  
 of glyoxylated RNA, 7.27–7.28  
 with methylene blue, 7.39, A9.4  
 with SYBR dyes, A9.7–A9.8
- standards, 7.23  
 storage of, 7.8  
 types, 7.2  
 yeast carrier tRNA, 5.20
- RNA denaturation solution, 7.48  
 RNA gel-loading buffer, 7.68, A1.19  
 RNA ligase, bacteriophage T4, 1.157, 9.56, A4.34  
 RNA modification database, A11.21  
 RNA polymerase, A4.28–A4.29  
 bacteriophage T3, A4.28–A4.29  
 bacteriophage T7, A4.28–A4.29  
 inhibition by lysozyme, 15.21, 15.24  
 inhibition by rifampicin, 15.20  
 digoxigenin labeling of nucleic acids, A9.38–A9.39
- DNA-dependent, 1.4  
*E. coli*, 9.87  
 in  $\lambda$ , 2.10–2.11  
 M13 replication, 3.5  
 in vitro transcription, 9.30–9.32, 9.34, 9.36–9.37, 9.87–9.88  
 $\lambda$ , 2.6, 2.7, 2.8  
 nuclear run-on assays, 17.23  
 promoter addition to DNA fragment by PCR, 9.36–9.37  
 amplification conditions, 9.36  
 primer design, 9.36  
 promoter sequences recognized by bacteriophage-encoded, 7.87  
 in ribonuclease protection assay protocol, 7.68, 7.71  
 RNA polymerase III in two-hybrid system for protein-protein interaction study, 18.15  
 transcription terminator signal  
 overcoming, 9.36  
 recognition, 9.36
- RNA precipitation solution, 7.10  
 RNA secondary structures database, A11.21  
 RNA World database, A11.21
- RNase, 7.2, A1.8  
 in BLOTTO, 1.139  
 cleavage of mismatches in RNA:RNA heteroduplexes, 13.93  
 contamination  
 preventive measures, 7.82  
 sources of, 7.82  
 in vitro transcription, 9.36  
 in CsCl-ethidium bromide gradients, 1.67  
 formamide protection of RNA, 7.8  
 inactivation of, 7.4  
 inhibitors of  
 DEPC, 7.82–7.84  
 placental, 8.49  
 protein, 7.68, 7.71, 7.77, 7.79, 7.83, 11.39  
 RNasin, 17.25  
 vanadyl ribonucleoside complexes, 7.83  
 in lysis buffer, 6.4–6.5  
 nucleic acid contaminant removal, 1.79  
 removal by phenol:chloroform extraction, 9.33  
 removal by proteinase K, 9.33  
 in yeast DNA purification protocols, 4.69, 4.71  
 RNase A, 1.59, A4.39  
 in alkaline lysis with SDS protocols, 1.34–1.35, 1.38  
 cleavage of mismatches in RNA:RNA heteroduplexes, 13.93  
 cleavage preferences, 7.67  
 DNase free, preparation of, A4.39  
 in ribonuclease protection assays, 7.66–7.68  
 in transcriptional run-on assay protocol, 17.29  
 RNase digestion mixture, 7.68, 7.73  
 RNase E, 1.7  
 RNase H, 1.4, 7.77, 8.48, 11.43  
 activity of exonuclease III, 13.73  
 in AIV reverse transcriptase, 11.11  
 buffer, A1.11  
 in cDNA second-strand synthesis, 11.14–11.17, 11.43–11.46  
 in DNA polymerase I, A4.12  
 functions of, 8.111  
 overview of, A4.38  
 in reverse transcriptases, 11.11–11.12, 11.109–11.110, A4.24–A4.25  
 RNAIL transcript processing, 1.6  
 RNase I, 7.67, 13.93  
 RNase III, *E. coli*, 2.6  
 RNase ONE, 7.67  
 RNase P (polymerase III) promoter, 18.11  
 RNase T1, A4.39  
 cleavage of mismatches in RNA:RNA heteroduplexes, 13.93  
 cleavage preferences, 7.67  
 in ribonuclease protection assays, 7.66–7.68  
 in transcriptional run-on assay protocol, 17.29  
 RNase T2, 7.67  
 RNaseOUT, 9.38  
 RNasin, 7.68, 7.77, 7.83, 9.38, 17.25  
 RNA-Stat-60, 7.10  
 Robbins Hydra Work Station, A10.5  
 Robotics for high-throughput processing, A10.5  
 Roller bottle hybridization chamber, 6.51, 6.53–6.54  
 Rolling circle replication  
 $\lambda$ , 2.11–2.12  
 in phagemids, 3.43  
 Rom (RNAI modulator), 1.5, 1.7  
 Rop (repressor of primer), 1.5, 1.7  
 Rotors, table of commonly used, A8.39  
 RPCI-11 Human BAC Library, 4.9  
 R-phycoerythrin, A9.33  
 RRI *E. coli* strain, A3.9  
 rRNA database, A11.21  
*RsaI*, A4.9  
*RsrI* site frequency in human genome, 4.16, A6.3  
*RsrII*  
 fragment size created by, table of, A4.8  
 genomic DNA mapping, 5.69  
 methylation, A4.7
- RT-PCR (reverse transcriptase-PCR), 8.46–8.53  
 advantages/disadvantages, 11.15  
 controls/standards, 8.48–8.49, 8.51–8.52  
 differential display-PCR, 8.97  
 enzymes, reverse transcriptase  
 inactivation of, 8.52  
 types used, 8.48  
 in exon trapping/amplification protocol, 11.89–11.94  
 full-length clones, low-yield of, 8.60  
 materials for, 8.49–8.51  
 measuring multiple gene products by, 8.89  
 method, 8.51–8.53  
 primers for, 8.46–8.48  
 quantitating RNA by, 7.66  
 quantitative, 8.88–8.91  
 reference templates, 8.88–8.89  
 troubleshooting, 8.53, 8.60  
 rTth DNA polymerase  
 in circular mutagenesis, 13.20  
 in overlap extension method of mutagenesis, 13.37  
 properties, table of, A4.23  
 Runaway plasmid replication, 1.13  
*Rz* gene,  $\lambda$ , 2.15–2.16
- <sup>35</sup>S  
 decay data, A9.15  
 particle spectra, A9.9–A9.10  
 sensitivity of autoradiographic methods for detection, A9.13
- 5S rRNA data bank, A11.21  
 S1 nuclease. *See* Nuclease S1  
*sacB* gene, 4.4–4.5, 4.37  
*Saccharomyces cerevisiae*, 4.58–4.60. *See also* Yeast artificial chromosomes  
 chromosome separation by pulsed-field gel electrophoresis, 5.56  
 chromosome sizes, 5.60, 5.65  
 expression in, 15.55  
 FLP recombinase, 4.85  
 genome size, 4.64  
 protein interactions in, mapping, 18.123–18.124  
 protein-protein interactions, studying, 18.4, 18.6  
 Sos recruitment system (SRS), 18.125–18.126
- SacI*  
 cleavage at end of DNA fragments, A6.4  
 fragment size created by, table of, A4.8  
 linker sequences, 1.99  
 site frequency in human genome, 4.16, A6.3
- SacII*  
 fragment size created by, table of, A4.8  
 site frequency in human genome, 4.16, A6.3
- S-adenosylmethionine (SAM), 1.99, 11.48–11.49, A4.3
- SAGA (Sequence Alignment by Genetic Algorithm) program, A11.7–A11.8
- SalI*  
 7-deaza-dGTP modified DNA, cleavage of, 8.60  
 cDNA linkers and adaptors and, 11.20, 11.51, 11.64  
 in cDNA synthesis kits, 11.71  
 cleavage at end of DNA fragments, A6.4  
 fragment size created by, table of, A4.8  
 genomic DNA mapping, 5.69  
 in homopolymeric tailing protocols, 11.111  
 linker sequences, 1.99  
 methylation, A4.7  
 site frequency in human genome, 4.16, A6.3  
 terminal/subterminal site cleavage, inefficient, 8.38
- Salmon sperm DNA  
 in chemical sequencing protocols, 12.64  
 in hybridization/prehybridization solutions, 6.52–6.53, 6.56, 7.45, 10.35, 10.38  
 as transfection control, 16.4
- SAM. *See* S-adenosylmethionine (SAM)
- SAM (Sequence Alignment and Modeling System) program, A11.7
- SAP. *See* Shrimp alkaline phosphatase
- Sarkosyl for lysis of cells in agarose plugs, 5.62, 5.64, 5.67
- Satellite colonies, 1.110, 1.115, 1.118, 1.148
- Saturation mutagenesis, 13.2–13.3
- Sau3AI*  
 7-deaza-dGTP modified DNA, cleavage of, 8.60  
*dam* methylation and, 13.87, A4.3  
 genomic DNA digestion, 4.11, 4.36  
 in site-directed mutagenesis protocol, 13.84
- sbcA*, 2.13, 2.28  
*sbcB*, 1.15, 2.13  
*SbfI* site frequency in human genome, 4.16, A6.3  
 ScanAlyze image analysis program, A10.5, A10.13  
 ScanArray 5000, A10.11

- Scanning mutagenesis, 13.3  
 ScanProsite program, A11.17  
*SceI*, 17.83  
 Schiff bases and formaldehyde, 7.31  
*Schizosaccharomyces pombe*, chromosome sizes of, 5.60, 5.65  
 Schlieren line, 12.79  
 Scintillation counting, 7.47, A8.25  
   CAT reporter assay, 17.39–17.41  
   coincidence circuit, 17.46, A9.22  
   luciferase assay, 17.46, A9.22–A9.23  
 SCOP (Structural Classification of Proteins) database, A11.22  
 Screening. *See also* Expression libraries, screening;  
   Hybridization: Immunological screening  
   bacterial colonies  
      $\alpha$ -complementation, 1.123–1.125  
     by hybridization  
       filter types, choosing, 1.126  
       intermediate numbers, 1.129–1.131  
       large numbers, 1.132–1.134  
       small numbers, 1.126–1.128  
       using X-gal and IPTG, 1.123–1.125  
   cDNA libraries, 11.26–11.34, 11.74–11.78  
    $\lambda$  recombinants, 2.21  
   by PCR  
     bacterial colonies, 8.74–8.75  
      $\lambda$  libraries, 8.76  
      $\lambda$  plaques, 8.74–8.75  
     yeast colonies, 8.75  
   for recombinant plasmids, 1.26–1.28  
      $\alpha$ -complementation, 1.27, 1.150  
     by hybridization, 1.27–1.28  
     overview, 1.26–1.27  
   transformants by insertional inactivation, 1.10  
   YAC recombinants, 4.60  
 Screening buffer, 14.33  
 Sculptor IVM Mutagenesis kit, 13.89  
 SDS, A1.28  
   in acrylamide gel elution buffer, 5.52  
   alkaline phosphatase inactivation, 1.96  
   bovine serum albumin absorption of, 6.25  
   in dot/slot hybridization, 7.48, 7.50  
   in elution buffers, 7.14  
   for inactivation of alkaline phosphatase, 9.64  
   in  $\lambda$  DNA extraction, 2.58  
   in mouse-tail lysis buffers, 6.26  
   in northern hybridization protocols, 7.42–7.44  
   in phosphate-SDS washing solution, 6.51–6.52  
   plasmid DNA protocols  
     alkaline lysis, 1.31–1.42  
     gentle method, 1.55–1.58  
   in ribonuclease protection assay protocol, 7.73  
   in SSCP protocol, 13.56  
   in SNET lysis buffer, 6.24–6.25  
   for solubilization of GST fusion proteins, 15.38–15.39  
   for solubilization of inclusion bodies, 15.54  
   in Southern hybridization wash solutions, 6.55  
   in yeast DNA preparation protocols, 4.68–4.71  
 SDS buffer, 17.20  
 SDS gel-loading buffer, 15.15, 15.22, 15.26, 15.31, 15.35, 15.41, 15.50, 18.17, A1.20, A8.42  
 SDS-EDTA dye mix, A1.20  
 SDS-polyacrylamide gel electrophoresis of proteins, A8.40–A8.51. *See also* Polyacrylamide gel electrophoresis  
   discontinuous buffer system, A8.40  
   driving gels, A8.50–A8.51  
   overview, A8.40  
   protocol  
     materials, A8.42–A8.44  
     pouring gels, A8.44–A8.45  
     resolving gel components, table of, A8.43  
     running gels, A8.45  
     sample preparation, A8.45  
     stacking gel components, table of, A8.43  
     reagents, A8.41–A8.42  
     separation range, table of, A8.42  
     staining gels, A8.46–A8.49  
       with Coomassie Brilliant Blue, A8.46–A8.47  
       during immunoblotting, A8.54  
       with silver salts, A8.46–A8.49  
     transfer of proteins from gel to filters for immunoblotting, A8.52–A8.53  
 Seal-A-Meal bags, 1.139, 2.97, 6.51, 6.53–6.54  
 Searching databases, 1.14  
 Secreted foreign proteins, expression of, 15.30–15.35  
 Selectable markers  
   inactivation as screening tool, 1.10  
   for  $\lambda$  recombinants, 2.21  
   uses of, 1.8–1.9  
 Selection. *See also* Antibiotics; *specific protocols*  
   conditionally lethal genes, 1.12  
   direct selection of cDNAs, 11.98–11.106  
   of mutants in vitro  
     *DpnI* destruction of parentals, 13.19–13.25, 13.84  
     phosphorothioate analog incorporation, 13.86–13.87  
     unique restriction site elimination, 13.26–13.30, 13.85  
     uracil-DNA glycosylate destruction of parentals, 13.84–13.85  
   of mutants in vivo, 13.87  
   positive selection vectors, 1.12  
 Sephacryl equilibration buffer, A1.21  
 Sephacryl S-400 in DNA purification for DNA sequencing, 12.106  
 Sephacryl S-1000, nucleic acid fragment contaminants, removal of, 1.80–1.81  
 Sephadex  
   G-15 for oligonucleotide purification, 10.26  
   G-25 in IgG radioiodination protocol, 14.5, 14.16  
   G-50, A8.29–A8.30  
     in cDNA probe production, 9.44–9.45, 9.49–9.50  
     in cDNA synthesis protocols, 11.44, 11.47, 11.54  
     for radiolabeled probe purification, 9.69, 9.71, 9.75  
     RNA purification, 9.35  
   poly(U), 7.15, 7.20  
   preparation of, A8.29  
 Sepharose  
   4B for antisera purification, 14.30, 14.51  
   affinity purification of fusion proteins, 15.6  
   CL-4B, A8.31, A9.26  
     cDNA size fractionation, 11.55–11.58  
     in dephosphorylated DNA purification, 9.65  
   CL-6B for DNA purification for DNA sequencing, 12.106  
 Sep-Pak C<sub>18</sub> chromatography, 10.11, 10.13, 10.15–10.16, 10.28–10.29  
 Sequenase, 12.9  
   activity of, 12.104  
   DNA sequencing  
     annealing primers to templates, 12.29  
     automated, 12.98  
     dye-primer sequencing, 12.96  
     materials for, 12.33–12.35  
     protocol, 12.35–12.36  
     pyrophosphatase use with, 12.34–12.36, 12.39  
     reaction mixtures, table of, 12.33  
     sequencing range, modifying, 12.37  
     steps involved, 12.32  
     troubleshooting, 12.38–12.39  
   inosine and, 12.110  
   Klenow compared, 12.32  
   in oligonucleotide-directed mutagenesis of single-stranded DNA, 13.15–13.17  
   overview of, 12.104–12.105  
   properties, table of compared, A4.11  
   versions of, 9.5, 12.104  
 Sequenase dilution buffer, 12.33, A1.9  
 Sequenase reaction buffer, 12.33–12.34  
 Sequencing. *See* DNA sequencing  
 Sequencing by hybridization (SBH), A10.17  
 Sequencing gels, resolving compressions in, 6.59  
 Sequin program, A11.3  
 SequiTherm, 12.46  
 Serine  
   codon usage, A7.3  
   nomenclature, A7.7  
   properties, table of, A7.9  
 Serum separation tubes (SST) for isolation of DNA from mouse tails, 6.26  
 71/18 *E. coli* strain  
   genotype, A3.6  
   M13 vectors and, 3.13  
   phagemids and, 3.42  
 Sex pili, M13 adsorption to, 3.5  
*SfiI*  
   fragment size created by, table of, A4.8  
   genomic DNA mapping, 5.68–5.69  
   site frequency in human genome, 4.16, A6.3  
 S gene,  $\lambda$ , 2.15–2.16  
 SgrAI  
   fragment size created by, table of, A4.8  
   site frequency in human genome, 4.16, A6.3  
 Shine-Dalgarno sequence  
   fortuitous, formation of, 15.12  
   *lacZ*, 15.57  
   in plasmid expression vectors, 1.13  
   translation efficiency and, 15.11–15.12, 15.18  
 Shotgun sequencing, 12.10–12.25  
   diagram of strategy, 12.12  
   DNA purification, 12.21–12.24  
   DNA repair, phosphorylation, and size selection, 12.17–12.18  
   enzymatic cleavage, 12.10–12.11  
   fragmentation of target DNA, 12.10–12.11, 12.15–12.17  
   growth of recombinants in 96-tube format, 12.19–12.21  
   hydrodynamic shearing, 12.10  
   ligation to vector DNA, 12.18–12.19  
   materials for, 12.13  
   number of sequences needed for coverage, 12.20  
   self-ligation of target DNA, 12.15  
   test ligations, 12.18, 12.25  
 Shrimp alkaline phosphatase (SAP), 1.95–1.96, 9.62–9.65, 9.92–9.93, A4.37  
   inactivation of, 1.96, 9.62, 9.64, 9.93  
   properties of, 9.93  
   RNA dephosphorylation, 9.65  
 sib-selection, 11.68–11.69  
 Sigmacote, 5.44, 12.75  
 Signal peptidase, 15.30  
 Silanizing solution, 12.75, 12.77, 12.112  
 Silica resins for DNA purification, 1.63, 5.26  
 Siliconizing fluid, 5.44  
 Siliconizing glassware, plasticware, and glass wool, A8.3  
 Silver emulsions, A9.9  
 Silver nitrate, 5.77, A8.48–A8.49  
 Silver staining, A9.5–A9.7  
   PFGE gels, 5.77  
   SDS-polyacrylamide gels, A8.46–A8.48  
 SilverSequence DNA Sequencing Kit, A9.6  
 SIM program, A11.5  
 Single nucleotide polymorphisms (SNPs), A10.3, A10.17  
 Single-strand-binding proteins in automated DNA sequencing protocols, 12.95

- Single-stranded conformation polymorphism (SSCP), 13.49–13.56, 13.91, 13.93  
 advantages/disadvantages, 13.52  
 amplification, 13.51, 13.53–13.54  
 denaturation, 13.51, 13.54  
 detection of mutants, 13.52, 13.55, 13.91, 13.93  
 dideoxy fingerprinting compared, 13.94  
 electrophoresis, 13.51, 13.55  
 materials, 13.52–13.53  
 mutation detection, 13.49  
 protocol, 13.53–13.55  
 restriction enzyme digestion and, 13.54–13.55  
 schematic diagram, 13.50  
 SYBR Gold stain as alternative to, 5.15  
 troubleshooting, 13.56
- Single-stranded DNA. *See also* M13 bacteriophage  
 alkaline agarose gel electrophoresis, 5.36–5.37  
 binding to DEAE-cellulose membranes, 5.19  
 calculating amount of 5' ends in a sample, 9.63  
 chemical mutagenesis of, 13.79  
 denaturing polyacrylamide gels, 5.40  
 end-labeling, 9.55  
 ethidium bromide binding, 5.14–5.15  
 exonuclease VII digestion of, 7.86  
 M13 DNA, preparation of, 3.26–3.29  
 mung bean digestion of, 7.87  
 nomogram for, A6.12  
 nuclease S1 cleavage of, A4.46  
 oligonucleotide-directed mutagenesis, 13.15–13.18
- PCR  
 production of radiolabeled probes, 7.54  
 SSCP, 13.51, 13.53–13.54  
 phagemids, 3.42–3.49  
 precipitation of, 3.29  
 radiolabeled probe production from M13  
 of defined length, 9.19–9.24  
 of heterogeneous length, 9.25–9.28  
 premature termination, 9.24  
 separation from double-stranded by hydroxyapatite chromatography, A8.32–A8.34  
 sequencing using Klenow fragment, 12.40–12.44  
 SYBR Gold binding, 5.15  
 uracil-containing, preparation of, 13.11–13.14
- Single-stranded DNA-binding protein, 12.44
- Site-directed mutagenesis. *See* Mutagenesis, site-directed
- Size markers. *See* Molecular-weight markers
- Size-exclusion chromatography, oligonucleotide purification by, 10.25–10.27
- SK promoter, primer sequence for, 8.117
- Slot hybridization of purified RNA, 7.46–7.50
- SM, A1.21
- SM buffer recipe, A2.8
- SM plus gelatin, A1.21
- Sma*I  
 7-deaza-dGTP modified DNA, cleavage of, 8.60  
 fragment size created by, table of, A4.8  
 genomic DNA mapping, 5.69  
 linker use of, 1.99, 1.100  
 site frequency in human genome, 4.16, A6.3
- Small RNA database, A11.21
- SMR10 *E. coli* strain  
 genotype, A3.9  
 $\lambda$  vector propagation, 2.29
- SNET solution, 6.24
- snoRNA program, A11.15, A11.21
- SNPs. *See* Single nucleotide polymorphisms
- SVR6 promoter, 18.15
- Soaking solution in northern hybridization protocols, 7.36–7.37
- SOB medium recipe, A2.3
- SOC medium recipe, A2.3
- Sodium acetate, 6.26–6.27, A1.28  
 in ethanol precipitation of nucleic acids, A8.12  
 in RNA isolation protocols, 7.5, 7.10
- Sodium  
 azide, 14.4, 14.15, 14.23–14.27  
 bicarbonate, A1.6  
 butyrate, 16.14–16.15, 16.17–16.18  
 in electroporation protocol, 16.36  
 in transfection, using polybrene protocol, 16.44–16.45  
 carbonate, A1.6  
 chloride (NaCl), A1.27  
 in chemical sequencing protocols, 12.61–12.65  
 density gradient for  $\lambda$  arm purification, 2.71  
 in ethanol precipitation of nucleic acids, A8.12  
 ethanol/NaCl solution, 6.19–6.20  
 in mouse-tail lysis buffers, 6.26  
 nucleic acid contaminant fragment removal, 1.78–1.79  
 for protein expression optimization, 15.19  
 in SNET lysis buffer, 6.24–6.25  
 in transfection with polybrene, 16.43  
 in virus particle precipitation, 12.23  
 dodecyl sulfate (SDS). *See* SDS  
 hydroxide (NaOH), A1.6, A1.27  
 in chemical sequencing protocols, 12.61–12.65, 12.70–12.71  
 for DNA denaturation, 12.28, 12.30  
 iodide solution, 5.32  
 metabisulfite, 14.5, 14.16  
 molybdate for protein stability, 17.16  
 nitrite, A8.27  
 phosphate buffer, A1.5  
 pyrophosphate, 6.56, 7.45  
 inhibition of murine reverse transcriptase, 11.46  
 self priming, inhibition of, 11.46  
 salicylate scintillant, A9.12
- Software. *See also* Bioinformatics; *specific software programs*  
 microarray image analysis, A10.13  
 Solid-phase radioimmunoassay (RIA), A9.29  
 Solution D (denaturing solution), 7.5  
 Sonication, A8.36–A8.37  
 calibration of the sonicator, A8.36  
 for cell lysis prior to affinity chromatography, 15.38, 15.46  
 of DNA, 12.11, 12.14, 12.15–12.16  
 liposome formation by, 16.7  
 Sorbitol buffer, 4.70–4.71, A1.21  
 Sos recruitment system (SRS), 18.126–18.127  
 South African National Bioinformatics STACK database, A10.15
- Southern hybridization, 1.28  
 advances in, 6.33–6.34  
 alkaline agarose gel, 5.38  
 background, 6.56  
 cDNA library screening, 11.38  
 CHEF gels, 5.82  
 DNA fixation to membranes, 6.45–6.46  
 DNA transfer methods  
 capillary transfer  
 downward, 6.35  
 protocol for, 6.39–6.46  
 to two membranes, 6.35–6.36, 6.47–6.49  
 upward, 6.34–6.35  
 electrophoretic transfer, 6.36  
 fixation of DNA to membranes, 6.45–6.46  
 membranes used for, 6.37–6.38  
 vacuum transfer, 6.37  
 DNase I hypersensitivity mapping, 17.21–17.22  
 electrophoresis buffer choice for, 5.8  
 genomic DNA preparation for, 6.3, 6.16, 6.19–6.21, 6.23  
 hybridization chambers, 6.51, 6.53–6.54  
 at low stringency, 6.58  
 nonradioactive labeling and, 9.76–9.80  
 overview of, 6.33–6.38  
 radiolabeled probes, use of  
 low-stringency hybridization, 6.58  
 nonradioactive probes, 6.50  
 overview, 6.50  
 protocol, 6.51–6.55  
 hybridization, 6.54  
 prehybridization, 6.53–6.54  
 washing, 6.54–6.55  
 sensitivity, 6.50  
 stripping from membranes, 6.57  
 for restriction mapping of recombinant cosmids, 4.33  
 TAFE gels, 5.77–5.78  
 troubleshooting, 6.56  
 of YAC clones, 4.63
- Southwestern blotting, 14.32–14.33, 14.36
- Sp1 nuclear factor, 17.8, 17.11, 17.17
- SP6 bacteriophage promoter, 1.11  
 addition to DNA fragments by PCR, 9.37  
 for eukaryotic expression vectors, 11.72  
 in  $\lambda$ ZipLox vector, 11.25  
 in P1 vectors, 4.38  
 primer sequence for, 8.117  
 sequence, 7.87, 9.87  
 RNA polymerase, 9.87–9.88, A4.28–A4.29
- Spacers for sequencing gels, 12.76–12.78
- SPAD (Signaling pathway database), A10.15
- Specialized transducing bacteriophages, 2.18
- Spectrophotometry, A8.19, A8.20–A8.21  
 DNA concentration measurement, 6.11, 6.15  
 quantitative, A9.4  
 RNA concentration estimation by, 7.8, 7.16
- Spe*I, A4.9  
 cleavage at end of DNA fragments, A6.4  
 fragment size created by, table of, A4.8  
 linker sequences, 1.99  
 site frequency in human genome, 4.16, A6.3
- Spermidine, 5.86, A1.28  
 in biolistic transfection protocol, 16.38, 16.40  
 DNA precipitation by, 9.34, 9.36  
 inhibition of PCR by, 8.13  
 in tissue homogenization buffer, 17.6, 17.25  
 in transcription buffer, 7.68, 7.71, 9.32, 9.34
- Spermine, 5.86, 17.6, 17.25
- Sph*I, A4.9  
 cleavage at end of DNA fragments, A6.4  
 fragment size created by, table of, A4.8  
 in homopolymeric tailing protocols, 11.111  
 site frequency in human genome, 4.16, A6.3
- Spi* marker, 2.20–2.22
- Spin dialysis, 8.27
- Spliceosome, 18.123
- Splinkerettes, 4.10, 4.76
- Spooling DNA, 6.16–6.18, 6.61
- Spotfire Net image analysis program, A10.13
- Spreeta chip, 18.96
- Spun column chromatography, A8.30–A8.31. *See also* Chromatography; *specific protocols; specific resins*
- SRB, 1.15
- Srf*I  
 fragment size created by, table of, A4.8  
 linker sequences, 1.99  
 site frequency in human genome, 4.16, A6.3
- SSC  
 in dot/slot hybridization, 7.48–7.50  
 in northern hybridization protocols, 7.36, 7.42–7.44  
 recipe, A1.14  
 in Southern hybridization protocols, 6.41, 6.44–6.47, 6.49, 6.51–6.52, 6.55–6.58
- SSCP. *See* Single-stranded conformation polymorphism
- Sse*I fragment size created by, table of, A4.8

- S-Sepharose, 15.6  
 SSPI, A1.14  
 in hybridization/prehybridization solutions, 10.35, 10.38  
 in Southern hybridization protocols, 6.51, 6.57  
 Sspl, A4.9  
 fragment size created by, table of, A4.8  
 site frequency in human genome, 4.16, A6.3  
 SstII and genomic DNA mapping, 5.60, 5.69  
 Stability region (*scr*), 1.146  
 Staining  
 glyoxylated RNA, 7.27  
 nucleic acids, A9.3–A9.8  
 ethidium bromide, A9.3–A9.4  
 methylene blue, A9.4–A9.5  
 silver staining, A9.5–A9.7  
 SYBR dyes, A9.7–A9.8  
 SDS-polyacrylamide gels for proteins  
 with Coomassie Brilliant Blue, A8.46–A8.47  
 during immunoblotting, A8.54  
 with silver salts, A8.46–A8.49  
 viability staining, A8.7–A8.8  
 Standing wave acousto-optic modulator (SW-AOM), 18.76–18.77  
*Staphylococcus aureus*  
 genomic resources for microarrays, A10.6  
 protein A. See Protein A  
 Starburst dendrimers and facilitation of DEAE transfection, 16.28  
 STE, A1.22  
 Sterol regulatory element-binding proteins (SREBPs), 17.11  
 STES lysis solution, 6.31, 18.39  
 STET, A1.16  
 Sticky ends. See Protruding termini  
 Storage media, A2.6  
 Storage of bacterial cultures, A8.5  
 Storm system, A10.11  
 Strains of *E. coli*. See *Escherichia coli* strains  
 Strand-separation gel electrophoresis, 7.51–7.52  
 StrataScript, 7.77, 8.48, 9.39  
 StrataScript RT, 11.38  
 Streptavidin, 9.76, 9.78, A9.45  
 BLAcore chips, 18.99  
 in direct selection of cDNAs protocol, 11.98–11.99, 11.103  
 magnetic beads and, 7.20, 11.118–11.119  
 Streptavidin bead-binding buffer, 11.100  
*Streptomyces avidinii*, A9.45  
*Streptomyces hygroscopicus*, 16.49  
 Streptomycin  
 modes of action, A2.7  
 stock/working solutions, A2.6  
 Stripping solution, 6.57  
 Stromelysin, 18.116  
 Stuffer fragment,  $\lambda$ . See  $\lambda$  vectors, replacement vectors  
 Substance P, epitope tagging of, 17.92  
 Subtilisin, 9.82, 12.101, 15.8, A4.15  
 Subtracted cDNA probes, 11.29–11.31  
 Subtractive cloning, 11.10–11.11  
 Subtractive screening, 9.90–9.91  
 Sucrose  
 dialysis on bed of, 6.15  
 dye solution, 17.14  
 gel-loading buffer, 2.77–2.78, 2.81, 6.41–6.42  
 for protein expression optimization, 15.19  
 Sucrose gradients  
 cDNA fractionation, 11.9  
 $\lambda$  arm purification, 2.71–2.75  
 mRNA fractionation for cDNA preparation, 11.9  
 preparing, 2.81–2.82  
 size fractionation of genomic DNA, 2.81–2.82  
 Sulfoindocyanine (Cy) dyes, 18.80. See also Cy3 dye; Cy5 dye  
 Sulfosalicylic acid, A8.46  
 Sulfuric acid, A1.6  
 SUP4, 4.3, 4.59–4.60  
*supB*, A7.6  
*supC*, A7.6  
*supD*, A7.6  
*supE*, 11.23–11.24, A7.5, A7.6  
 $\lambda$  propagation and, 2.28–2.29  
 M13 vectors and, 3.11–3.13  
 SuperCos-1, 4.5, 4.12, 4.14, 4.18–4.19, A3.5  
 SuperFect, 16.5  
 Superinfection  
 frozen cultures, using, 3.47  
 phagemids/helper virus, 3.47  
 Supernatants, aspiration of, 1.33, 1.36, 1.45  
 SuperScript, 8.48, 11.12, 11.38  
 SuperScript II, 9.39, 11.38, 11.108  
*supF*, 2.23, 2.28–2.29, 11.23–11.24, 11.66, 14.37, 14.47, A7.5–A7.6  
 Supplemented minimal medium (SMM), A2.9–A2.10  
 Suppressor tRNA gene, 4.3  
 SURE *E. coli* strains, 1.15, 1.25  
 Surface plasmon resonance (SPR), 18.4, 18.96–18.114  
 concentration measurement, 18.102  
 data collection, 18.100–18.101  
 instruments of, 18.96  
 kinetic measurements, 18.101–18.102  
 overview, 18.97–18.98  
 protocol, 18.103–18.114  
 capture surface preparation, 18.105  
 data analysis, 18.112–18.114  
 design, 18.103  
 kinetic analysis, 18.108–18.114  
 test binding, 18.106–18.107  
 schematic of, 18.97  
 sensor chips, 18.98–18.100  
 regeneration of surface, 18.100  
 SurfZAP, A3.3  
 Suspension cultures, lysis of mammalian cells in, 637  
 SV40  
 COS cells and, 11.114  
 intron and polyadenylation signal in pTet vectors, 17.58  
 origin of replication, 11.68, 11.114, 17.49  
 T antigen, epitope tagging of, 17.92  
 SV40 promoter  
 in p $\beta$ -gal reporter vectors, 17.49  
 in pCAT3 vectors, 17.35  
 in pd2EGFP vectors, 17.88  
 in pGL3 vectors, 17.43  
 in pSPL3, 11.82, 11.85, 11.89  
 in pSV2CAT vector, 17.95  
 SwaI  
 fragment size created by, table of, A4.8  
 site frequency in human genome, 4.16, A6.3  
 Swiss Blue. See Methylene blue  
 SWISS\_PROT, A10.15  
 SYBR dyes, overview, A9.7–A9.8  
 SYBR Gold, 1.53, A9.7–A9.8  
 in agarose gel electrophoresis, 5.11, 5.15–5.16  
 photography, 5.16–5.17  
 polyacrylamide gel staining, 5.47–5.48  
 in quantitation of DNA, A8.24  
 removal from gels, 5.15  
 resolution of, 5.15  
 sensitivity of, 5.12  
 staining solution recipe, A1.29  
 SYBR Green, A9.7–A9.8  
 in real time PCR, 8.94, 8.95  
 Sybron SIL G/UV254 TLC plates, 17.38  
 Synthetic dextrose minimal medium (SD), A2.10  
 Synthetic minimal (SM) recipe, A2.9  
 SYSTEMS database, A11.22  
 T vectors  
 cloning PCR products into, 8.31, 8.35–8.36  
 creating, 8.35  
 stability of 3' unpaired residues, 8.36  
 T2 *dam* methylase, A4.7  
 T3 bacteriophage  
 promoter, 1.11, 1.13  
 addition to DNA fragments by PCR, 9.37  
 in cosmid vectors, 4.5, 4.33  
 for eukaryotic expression vectors, 11.72  
 in  $\lambda$ ZAP vectors, 11.22  
 in  $\lambda$ ZipLox vector, 11.25  
 primer sequence for, 8.117  
 in ribonuclease protection assay protocol, 7.69  
 sequence, 7.87, 9.37, 9.87  
 RNA polymerase, 9.87–9.88  
 T4 bacteriophage  
 DNA ligase, 1.157–1.158, 3.37, A4.31–A4.32, A4.34  
 activity of, A4.31  
 blunt end ligation, A4.32  
 cohesive termini/nick ligation, A4.32  
 inactivation, 1.102  
 inhibition by dATP, 1.85  
 linker/adaptor attachment to cDNA, 11.54  
 uses, list of, A4.31  
 DNA polymerase  
 3'-5' exonuclease activity, 11.121  
 polynucleotide kinase. See Polynucleotide kinase, bacteriophage T4  
 RNA ligase, 1.157  
 T4 *dam* methylase, A4.7  
 T5A3 gene, 2.21  
 T7 bacteriophage  
 DNA polymerase in DNA sequencing  
 automated, 12.98  
 dye-primer sequencing, 12.96  
 promoter, 1.11–1.13, A4.28  
 addition to DNA fragments by PCR, 9.37  
 in cosmid vectors, 4.5, 4.33  
 for eukaryotic expression vectors, 11.72  
 for expression of cloned genes in *E. coli*, 15.3–15.4, 15.20–15.24  
 large-scale expression, 15.24  
 materials for, 15.22  
 optimization, 15.23–15.24  
 overview, 15.20–15.22  
 protocol, 15.23–15.24  
 regulation by lysozyme, 15.24  
 in  $\lambda$ ZAP vectors, 11.22  
 in  $\lambda$ ZipLox vector, 11.25  
 in M13-100 vector, 3.10  
 in P1 vectors, 4.38  
 primer sequence for, 8.117  
 in ribonuclease protection assay protocol, 7.69  
 sequence, 7.87, 9.37, 9.87  
 protein interaction network in, 18.123  
 RNA polymerase, 9.87–9.88  
 in binary expression systems, 9.88  
 lysozyme inhibition of, 9.88  
 T7-Tag, epitope tagging, 17.93  
*tac* promoter, 15.3, 15.40  
 TAE. See Tris-acetate-EDTA electrophoresis buffer  
 TAFE. See Transverse alternating field electrophoresis  
 TAFE gel electrophoresis buffer, A1.18  
 TAIL PCR, 4.75  
 Tailing reaction  
 in 5'-RACE procedure, 8.58–8.59  
 in cDNA cloning, 11.3–11.4, 11.15  
 digoxigenin labeling of nucleic acids, A9.38–A9.39  
 homopolymeric, 11.110–11.111  
 terminal transferase and, 8.111  
 Talon, 15.46

- Tamra, 8.95
- TAP90 *E. coli* strain  
genotype, A3.9  
 $\lambda$  vector propagation, 2.28
- Tape, gel-sealing, 12.76, 12.78
- Taq dilution buffer, 12.48, A1.9
- Taq DNA polymerase, 8.4, 8.6–8.7, 8.10, A4.22–A4.23. *See also* AmpliTaq DNA polymerase; DNA polymerase, thermostable  
for cDNA second-strand synthesis, 11.14  
in differential display-PCR, 8.98  
digoxigenin labeling of nucleic acids, A9.38–A9.39  
in DNA sequencing, 12.45–12.50  
automated, 12.98  
dye-primer sequencing, 12.96  
materials for, 12.48–12.49  
method, 12.49–12.50  
overview, 12.45–12.47  
reaction mixtures, table of, 12.48  
steps involved, 12.47  
version of *Taq*, 12.46–12.47  
error rate, 8.108–8.109  
in exon trapping, 11.91–11.93  
heat tolerance of, 8.8  
incorrect base incorporation, 8.77  
inhibition by dyes, 1.53  
in-house preparation, 8.108–8.109  
inosine and, 12.109  
in megaprimer PCR mutagenesis method, 13.33  
in misincorporation mutagenesis, 13.80  
overview of, 8.108–8.109  
polymerization rate, 8.9  
properties of, 8.10, 8.108, A4.11, A4.23  
rapid screening of bacterial colonies or  $\lambda$  plaques by PCR, 8.74–8.75  
in RT-PCR, 8.49  
site-directed mutagenesis, oligonucleotide design for, 13.82  
stability of, 8.25, 8.30, 8.108  
Stoffel fragment, 8.109  
storage, 8.19  
temperature optimum, 8.9  
terminal transferase activity, template-independent, 8.30, 8.35  
variations in preparations of, 8.6
- Taq* gene, 8.108–8.109
- TaqEXPRESS, 12.46
- TaqI*, 13.87, A4.3, A4.9
- TaqI* methylase, A4.5, A4.7
- TaqMan* method of real time PCR, 8.95
- TaqPlus  
in circular mutagenesis, 13.20  
Long PCR System, 8.7, 8.77
- TaqStart, 8.110
- Taqenase  
in cycle sequencing reactions, 12.46–12.47  
structure of, 12.47
- tat* gene, HIV, 11.82
- Taurine in electrophoresis buffers, 12.108, 13.90
- TBE. *See* Tris-borate-EDTA electrophoresis buffer
- Tbr* DNA polymerase, 8.7, 8.10, A4.23
- TE (Tris EDTA) buffer, A1.7
- TEACl. *See* Tetraethylammonium chloride
- Tecan GENESIS sample processor, A10.5
- Telomeric repeat (*TEL*) sequences in YACs, 4.59
- TEMED (*N,N,N',N'*-tetramethylethylenediamine), 5.41, 5.43, 5.45, 12.75, 12.79, 12.82, 13.53–13.54, A8.42
- Temperate bacteriophages, 2.9. *See also*  $\lambda$ ; P1
- TEN buffer, A1.22
- Terminal deoxynucleotidyl transferase, A4.27  
activity in DNA polymerases, 8.30, 8.35  
in cDNA second-strand synthesis, 11.17  
digoxigenin labeling of nucleic acids, A9.38–A9.39  
in end-labeling, 9.55–9.56  
for chemical sequencing of DNA, 12.73  
homopolymeric tailing, 11.110  
inactivation of, 8.59  
in lymphocytes, 8.112  
overview of, 8.111–8.112  
5'-RACE protocol, 8.54–8.60  
requirements of, 8.111
- Terminal transferase. *See* Terminal deoxynucleotidyl transferase
- Terminal transferase buffer, A1.11
- Terminal transferase (tailing) buffer, A1.11–A1.12
- Terminase,  $\lambda$ , 2.15, 4.5, 4.30
- Terrific Broth recipe, A2.4
- TES, A1.22
- TESS (Transcription Element Search System) program, A11.13
- TetA, 17.53
- tetO*, 17.53–17.58
- tetP*, 17.57
- TetR, 17.53–17.56, 18.11
- Tetracycline, 1.9  
electroporation efficiency of *tet*-resistant transformants, 1.26  
entry into cells, 17.53  
mechanism of action, 17.53  
mechanism of resistance to, 1.147  
modes of action, A2.7  
for protein expression optimization, 15.19  
regulation of inducible gene expression, 17.52–17.70  
autoregulatory system, 17.56, 17.70  
reduced basal activity, 17.56–17.59  
repression system, 17.54  
reversed activator, 17.55–17.56  
schematic representation of repression system, 17.54  
Stage 1: Stable transfection of fibroblasts pTet-tAK, 17.60–17.64  
Stage 2: Stable transfection of inducible t-TA-expressing NIH-3T3 cells with tetracycline-regulated target genes, 17.65–17.69  
Stage 3: Analysis of protein expression in transfected cells, 17.68–17.69  
*trans*-activator, 17.54–17.55  
in transiently transfected cells using the autoregulatory tTA system, 17.70  
troubleshooting, 17.59  
resistance, 17.53  
selecting transformants, 1.110, 1.115, 1.118  
structure of, 1.146, 17.52–17.53
- Tetracycline repressor (TetR), 17.53–17.56, 18.11
- Tetracycline resistance (*tet<sup>r</sup>*), 1.9, 1.147  
in  $\lambda$ ZAP, 14.6  
mechanism of resistance, 1.147  
in positive selection vectors, 1.12
- Tetracycline-responsive element (TRE), 17.32
- Tetracycline stock/working solutions, A2.6
- Tetraethylammonium chloride (TEACl), 10.6, 10.35–10.37
- Tetrahymena*, 4.59
- Tetramethylammonium chloride (TMACl), 8.9, 10.6, 10.35–10.37
- 3,3',5,5'-tetramethylbenzidine (TMB), A9.35
- TEV (tobacco etch virus) protease, 15.8
- Texas Red, A9.33
- TFASTX/TFASTY program, A11.19
- TFBIND program, A11.13
- Tfi* DNA polymerase, 8.10, A4.23
- Tfx, 16.5, 16.7, 16.11
- TG1 *E. coli* strain, 13.12–13.13  
cell-wall component shedding and DNA purification, 1.18  
genotype, A3.9  
M13 vectors and, 3.12, 3.16
- TG2 *E. coli* strain  
genotype, A3.9  
M13 vectors and, 3.12
- M13 vectors and, 3.12  
phagemids and, 3.44
- Thermal asymmetric interlaced (TAIL) PCR, 4.75
- Thermal cycle DNA sequencing. *See* Cycle DNA sequencing
- Thermal cycler, 8.19–8.22, 8.112. *See also* Polymerase Chain Reaction
- ThermoSequenase  
in DNA sequencing  
automated, 12.98  
cycle sequencing reactions, 12.46–12.47  
dye-primer sequencing, 12.96  
inosine and, 12.110  
structure of, 12.47
- Thermostable DNA polymerases. *See* DNA polymerase, thermostable; *specific polymerases*
- Thermus aquaticus*, 8.4, 8.6–8.7, A4.22. *See also* *Taq* DNA polymerase
- $\theta$  (Theta) structures, 1.6, 2.11–2.12, 3.2
- Thin-layer Chromatography (TLC) for CAT measurement in extracts from mammalian cells, 17.36–17.39
- Thionucleotides, resistance to exonuclease III, 13.75
- Thiopropyl-Sepharose, 13.6
- Thioredoxin, 14.47, 15.9, 15.26
- Thiourea, 17.12
- 3B3, epitope tagging, 17.93
- 3D-Ali database, A11.22
- Threonine  
codon usage, A7.3  
nomenclature, A7.7  
properties, table of, A7.9
- Thrombin, 15.39–15.40, 15.43
- Thymidine, hydrazine cleavage of, 13.78
- Thymidine glycosylase, 13.94
- Thymidine kinase gene, 1.15, 16.47–16.48, 17.33
- Thymine, A6.9  
carbodiimide modification, 13.95  
osmium tetroxide modification of, 13.95  
related compounds (Table A6-8), A6.9  
structure, A6.9
- Thyroglobulin for protein stability, 17.16
- Thyroid receptor resource database, A11.21
- Thyroid-stimulating hormone (TSH), 18.104–18.114
- TIGR Gene Indices, A10.15
- TIGR Spotfinder image analysis program, A10.13
- TIMP-2, A5.1
- Tissue homogenization buffer, 17.6, 17.25
- Tissue microarrays, A10.18
- Tissue plasminogen activators, 18.116
- Tissue resuspension buffer, 17.6
- Tissues  
DNA isolation  
hemoglobin contamination, 6.7–6.8, 6.17–6.18  
from mouse tails, 6.23–6.27  
for pulsed-field gel electrophoresis, 5.61–5.64  
homogenization of, 6.7–6.8  
lysis of, 6.7–6.8, 6.17  
nuclear extract preparation from, 17.8–17.9  
RNA, DNA, and protein simultaneous preparation, 7.9–7.12  
RNA isolation by acid phenol-guanidinium thiocyanate-chloroform extraction, 7.4–7.8
- TKM buffer, 11.87
- TLCK, A5.1
- Tli* DNA polymerase, A4.23
- TliVent* DNA polymerase, 8.11
- TM buffer recipe, A2.8
- TMACl. *See* Tetramethylammonium chloride
- TMB. *See* 3,3',5,5'-tetramethylbenzidine
- tmRNA database, A11.22
- TM-TPS, 16.11
- Tn9 transposon, 13.88

- FN1 buffer, 14.5, 14.8–14.9, 14.15, 14.18–14.19  
 IolA/IolR/IolQ proteins, 3.6  
 Iolde and Oligonucleotide Calculator program, 13.89  
 Iontec Quadra, A10.5  
 Iotopick minipreparations of plasmid DNA, 1.51–1.54  
 Topoisomerase I (Topo I), 1.4, 2.16, A4.52  
 Iosyl lysine-chloromethyl ketone as protease inhibitor, 15.19  
 Touchdown PCR, 8.112  
   in MOPAC protocol, 8.70  
   multiplex PCR, 8.107  
   quantitative PCR, 8.89  
 toxic proteins  
   choosing appropriate strain of *E. coli*, 1.15  
   low-copy-number plasmid vectors, 1.12  
 TPCK, A5.1  
 TPE. See Tris-phosphate-EDTA electrophoresis buffer  
*trxA* gene, 4.49  
 Tracking dyes  
   in denaturing agarose gels, 7.23  
   in polyacrylamide gels, 7.57  
*trdD*, 6.3.10, 3.12–3.13  
 Tran<sup>35</sup>S-label, 15.18  
 Transcription buffer, 7.68, 7.71, 9.32  
 Transcription factor E2F1, 18.11  
 Transcription factor GATA-1 in positive selection vectors, 1.12  
 Transcription factors, screening cDNA libraries for, 11.33  
 Transcriptional activation domain  
   activation domain fusion plasmids, 18.20  
   two-hybrid system and, 18.6, 18.14, 18.20, 18.36  
 Transcriptional run-on assays, 17.23–17.29  
   materials for, 17.24–17.26  
   nuclei isolation, 17.26–17.27  
   from cultured cells, 17.26  
   from tissue, 17.27  
   overview of, 17.23–17.24  
   radiolabeling transcripts  
     from cultured cell nuclei, 17.27  
     from tissue nuclei, 17.27–17.28  
 Transcriptional silencers (TS), 17.56  
 Transduction of the PI recombinant plasmid, 4.46  
 Transac program, A11.12  
 Transact transfection, 16.5  
 Transactam, 16.5, 16.8–16.9, 16.11  
 Transfection, 16.1–16.57  
   biolistics, 16.3, 16.37–16.41  
     materials for, 16.38–16.39  
     method, 16.39–16.41  
     particle types, 16.37  
     variables, 16.37  
   calcium-phosphate-mediated, 16.3, 16.14–16.26, 16.52–16.53  
     of adherent, 16.25  
     of cells growing in suspension, 16.25  
     chloroquine treatment, 16.14, 16.17, 16.52  
     cotransformation, 16.24  
     efficiency, factors affecting, 16.52  
     with genomic DNA, 16.21–16.24  
     glycerol shock, 16.14, 16.17, 16.52  
     high efficiency, 16.19  
     mutation prevalence, 16.53  
     with plasmid DNA, 16.14–16.20  
     sodium butyrate, 16.14, 16.17–16.18  
   cell line variation, 16.57  
   controls, 16.4–16.5  
     for stable expression, 16.4–16.5  
     for transient expression, 16.4  
   cotransformation, 16.24, 16.47  
   by DEAE-dextran, 16.3, 16.27–16.32  
     calcium phosphate method compared, 16.27  
     cell viability, increasing, 16.32  
     facilitators of, 16.28  
     kits, 16.30  
     materials for, 16.29–16.30  
     mechanism of action, 16.27  
     method, 16.30–16.31  
     mutation prevalence, 16.28, 16.53  
     variables, 16.27–16.28  
   electroporation  
     efficiency, factors influencing, 16.33–16.34, 16.57  
     of mammalian cells, 16.3, 16.33–16.36, 16.54–16.57  
     materials for, 16.34–16.35  
     method, 16.35–16.36  
   for FLIM-FRET analysis, 18.84–18.86  
   by lipofection, 16.3, 16.7–16.13  
     chemistry of, 16.50  
     lipids used in, 16.8, 16.11, 16.51  
     materials for, 16.7–16.11  
     optimizing, 16.51  
     overview of, 16.50–16.51  
     protocol, 16.12–16.13  
   methods, summary of, 16.3  
   polybrene, 16.3, 16.43–16.46  
   stable, selective agents for, 16.48–16.49  
   tetracycline regulation of inducible gene expression and, 17.60–17.70  
   transient vs. stable, 16.2  
 Transfection Reagent Optimization System, 16.7  
 Transfection Reagent Selector Kit, 16.5  
 Transfer buffers  
   for alkaline transfer of RNA to charged membranes, 7.36, 7.38  
   in Southern hybridization, 6.40–6.41, 6.44, 6.46–6.47, 6.49  
 Transformation. See also Transfection  
   of blunt-ended fragment ligations, 1.92  
   cell density and, 1.108, 1.112, 1.114, 1.117, 1.120–1.121  
   cell preparation, 1.107–1.109, 1.113–1.114, 1.117–1.118  
   controls, 1.111  
   in directional cloning procedures, 1.87  
   DnD solution, 1.106, 1.109  
   by electroporation, 1.25–1.26, 1.119–1.122  
   freezing of competent cells, 1.114–1.115  
   frozen storage buffer, 1.106, 1.108  
   glassware cleanliness and efficiency of, 1.105–1.106  
   Hanahan method, 1.105–1.110  
   Inoue method, 1.112–1.115  
   in M13 cloning, 3.37–3.38  
   of mammalian cells by YACs, 4.63–4.64  
   overview, 1.24–1.26  
   plasmid size and efficiency, 1.9  
   of plasmids with inverted repeats, 1.15  
   strain of *E. coli*, choosing appropriate, 1.14–1.15  
   using calcium chloride, 1.116–1.118  
   yeast spheroplasts, 4.60  
 Transformation buffer, 1.106–1.107  
 Transformer kit, 13.27  
 Transformer site-directed mutagenesis kit, 13.89  
 Transition mutations, 13.78  
 Translation initiation, optimization of, 15.11–15.12  
 Translational coupling, 15.12  
 Transposons and kanamycin resistance, 1.145  
 Transverse alternating field electrophoresis (TAFE), 5.56–5.57, 5.74–5.78  
   electrode configuration, 5.57  
   high-capacity vector insert size determination, 4.18  
   method, 5.76–5.78  
   pulse times, 5.74–5.75  
   resolution, 5.74  
   silver staining, 5.77  
   Southern blots, 5.77–5.78  
*trc* promoter, 15.3  
 TreeView program, A10.15  
 TRI reagent, 7.10  
 Triazol reagent, 7.10  
 Trichloroacetic acid (TCA), A1.29  
   in oligonucleotide synthesis, 10.12, 10.49  
   polyacrylamide gel fixation, 7.56, 7.61–7.62, 7.68  
   precipitation of nucleic acids with, A8.25–A8.26  
 Trifluoroacetic acid, A9.32  
 Tris buffers  
   deficiencies of, A1.3  
   general, A1.2  
   preparation with various pH values, table of, A1.2  
 Tris-Cl, A1.7  
 Tris EDTA (TE) buffer, A1.7  
 Tris magnesium buffer (TM), A1.8  
 Tris-acetate-EDTA (TAE) electrophoresis buffer, 5.8, 5.76, A1.17  
 Tris-borate-EDTA (TBE) electrophoresis buffer, 5.8, 12.75, 12.84, 12.87  
   ligation reaction inhibition, 5.30  
   polyacrylamide gel electrophoresis, 5.43  
   for pulsed-field gel electrophoresis, 5.60  
   recipe, A1.17  
   in SSCP protocol, 13.52  
   for TAFE, 5.76  
 Tris-buffered saline (TBS), A1.8  
 Tris-buffered saline with dextrose (TBS-D), 16.29–16.31  
 Tris-glycine, A1.17  
 Tris-glycine electrophoresis buffer, A8.42–A8.43  
 Tris-phosphate-EDTA (TPE) electrophoresis buffer, 5.8, A1.17  
 Tris-SDS chromatography buffer, 10.25–10.26  
 Tris-sucrose, A1.22  
 Triton X-100  
   in cell lysis buffers, 17.36, 17.44–17.45  
   inclusion bodies recovery using, 15.51  
   luciferase and, A9.22  
   in preparation of fixed cells for FLIM-FRET analysis, 18.87  
   for solubilization of GST fusion proteins, 15.38–15.39  
   in supershift assays, 17.17  
   in washing solution for inclusion bodies, 15.10  
 Triton/SDS solution, 4.68, A1.22  
 tRNA carrier RNA, 7.69  
 tRNA genes, higher-plant mitochondria database, A11.21  
 tRNA suppressor, A7.5  
 tRNAscan-SE program, A11.15  
*trp* promoter, 15.3  
*TRP1*, 4.3, 4.60, 18.20, 18.22, 18.43  
*trpC* mutation, 18.43  
*trpE* gene, 11.109  
 TRRD (Transcriptional Regulatory Region Database), A11.20  
*trx* gene, *E. coli*, 12.104  
 Trypan blue dye, 17.20  
 Trypanosomes, 1.150, A9.3  
 Trypsin, 15.8, 16.12, 18.66–18.68, A1.8  
 Tryptophan  
   auxotrophy and YAC vectors, 4.60, 4.65  
   codon usage, A7.3  
   nomenclature, A7.7  
   properties, table of, A7.9  
 Tryptophan-inducible expression systems, 15.25–15.26, 15.28–15.29  
 TSSG program, A11.13  
 TSSW program, A11.13, A11.20  
 tTA (trans-Transcriptional Activator), 17.54–17.60, 17.64–17.65, 17.70  
*Tth* DNA polymerase, 8.10, 8.48  
   for cDNA second-strand synthesis, 11.14  
   in circular mutagenesis, 13.20

- in overlap extension method of mutagenesis, 13.37  
 properties, table of, A4.23  
*Tth*Hfl, A4.9  
*rTth*Start, 8.110  
*Tth* polymerase, 8.10  
 Tungsten in biolistics, 16.38–16.39  
 Tween-20  
   in blocking buffer, 14.4, 14.15, 14.23, 14.26  
   in DNA sequencing protocols, 12.55  
   in PCR lysis solution, 6.22  
   for solubilization of GST fusion proteins, 15.38–15.39  
   in supershift assays, 17.17  
   in TNT buffer, 14.5, 14.13  
 Two-hybrid system. *See* Protein-protein interactions, two-hybrid system  
 Tyrosine  
   codon usage, A7.3  
   Ick tyrosine kinase, 18.7  
   nomenclature, A7.7  
   phosphorylation, 14.2  
   properties, table of, A7.9  
 Tyrosine kinase, 18.7  
 Ubiquitin-based split-protein sensor (USPS)  
   method, 18.125–18.126  
 UDG system, 11.105  
 U' gene,  $\lambda$ , 2.15  
*UfmA* DNA polymerase, 8.10, A4.23  
 Ultraspiracle protein (USP), 17.71  
 Ultraviolet (UV) radiation  
   damage to DNA, 1.67, 1.151, 5.20, 5.24  
   DNA fixation to membranes by, 1.135, 1.137, 2.94–2.95, 6.46, 7.36  
   ethidium bromide fluorescence, 1.151  
   inactivation of contaminating DNA in PCRs, 8.16–8.17  
   oligonucleotide visualization in polyacrylamide gels, 10.16  
   photography of DNA in gels, 5.16–5.17  
   RNA fixation to nylon membranes by, 7.40  
*umuC* gene, 1.15  
*ung*, 13.11–13.15, 13.77, 13.84–13.85  
 UniGene, 10.15, A10.4  
 Unique restriction site elimination (USE). *See* USE mutagenesis  
 Universal bases, 10.9–10.10, 11.32  
 Universal KGB (restriction endonuclease buffer), 8.32, A1.12  
 Universal primers, 8.113–8.117  
   for  $\lambda$ gt10/ $\lambda$ gt11, 8.116  
   for M13 vectors, 8.115  
   for pBR322, 8.114  
   for pUC vectors, 8.115  
   transcription promoter primers, 8.117  
 Uni-ZAP in commercial kits for cDNA synthesis, 11.108  
*URA3*, 4.3, 4.60, 18.11–18.12, 18.22  
 Uracil, A6.9  
   auxotrophy and YAC vectors, 4.60, 4.65  
   related compounds (Table A6-9), A6.9  
   structure, A6.9  
 Uracil DNA glycosylase (UDG), 8.17, 11.121–11.123, 13.79, 13.84, A4.51  
 Uracil tryptophan drop-out medium, 4.65  
 Uracil-substituted DNA, preparation of M13, 13.11–13.14  
 Ureanyl salts, 17.77  
 Urea  
   denaturing fusion proteins with, 15.7  
   in denaturing polyacrylamide gels, 7.58, 12.74, 12.78  
   inclusion bodies recovery using, 15.52  
   solubilization of, 12.78  
   for solubilization of inclusion bodies, 15.54  
 Urease antibody conjugates, A9.34  
 uRNA database, A11.22  
 USE mutagenesis, 13.26–13.30, 13.85, 13.89  
 UTP, digoxigenin coupled, A9.38  
 UV light. *See* Ultraviolet (UV) radiation  
*uvrC* gene, 1.15  
 V protein,  $\lambda$ , 2.15  
 V8 protease, 18.64  
 Vacuum aspiration, 6.10  
 Vacuum transfer of DNA to membranes, 6.37  
 Valine  
   codon usage, A7.3  
   nomenclature, A7.7  
   properties, table of, A7.9  
 Vanadyl ribonucleoside complexes, 7.83  
 VCSM13, 3.44, 18.116  
 Vector alignment search tool (VAST), A11.22  
 Vectors. *See also* Cosmids; Expression vectors;  $\lambda$  vectors; M13 vectors; Plasmid vectors; Vectors, high-capacity; *specific vectors*  
   phagemids, 3.42–3.49  
   positive selection, 1.12  
   table of, A3.2–A3.5  
    $\lambda$ , A3.3  
   mammalian, A3.3–A3.4  
   plasmid/phagemid, A3.2–A3.3  
   shuttle vectors, A3.4–A3.5  
   yeast, A3.4  
 Vectors, high-capacity, 4.1–4.86. *See also specific vectors*  
   BACs, 4.2, 4.58–4.73  
   bacterial P1, 4.4, 4.35–4.47  
   cosmids, 4.4–4.5, 4.11–4.34  
   genomic library construction  
     arrayed libraries, 4.8  
     chromosome walking, 4.8–4.10  
     overview, 4.6–4.7  
     vector choice, factors influencing, 4.7–4.10  
   insert size measurement by pulsed-field gel electrophoresis, 4.18  
   large DNA fragment cloning products and services, 4.86  
   P1 artificial chromosomes, 4.4, 4.40–4.44  
   table of, 4.2  
   vectors PCR isolation of genomic ends, 4.74–4.81  
   YACs, 4.2, 4.58–4.73  
*Vent* DNA polymerase, 8.85  
*VentR* DNA polymerase, 13.37  
 Vesicular stomatitis virus (VSV) G protein, epitope tagging, 17.93  
 Viability staining, A8.7–A8.8  
*Vibrio harveyi*, A9.21, A9.23  
 Vienna RNA package program, A11.15  
 Viroid and viroid-like RNA sequence database, A11.22  
 Virus. *See* Bacteriophages  
 Vitamin H. *See* Biotin  
 von Hippel-Lindau tumor suppressor protein (pVHL), 18.60, 18.62  
 Wallace Rule, 10.3  
 Wash buffer (Qiagen), A1.22  
 Wash solutions. *See specific protocols; specific solutions*  
 wconsensus program, A11.14  
 Webin program, A11.3  
 Wedge gels, 12.83  
 Weiss unit of ligase activity, 1.159  
 Western blotting, A9.28  
   in coimmunoprecipitation protocol, 18.63  
 epitope tagging, 17.91  
 ubiquitin-based split-protein sensor (USPS)  
   method, 18.125  
 Whatman 3MM CHR paper for polyacrylamide gel drying, 12.92  
 Whatman 541 filter papers for screening bacterial colonies by hybridization, 1.126  
 White blood cells, DNA isolation from, 5.63–5.64  
 WIT database, A10.15  
 Wizard, 1.64  
 Wizard PCR Preps Purification System, 8.26–8.27  
 WU-BLAST (Washington University BLAST) program, A11.19  
 Xanthine, structure of, A6–10  
 Xanthine monophosphate (XMP), 16.49  
 Xanthine oxidase  
   chemiluminescent enzyme assay, A9.19  
   as digoxigenin reporter enzyme, 9.77  
 Xanthine-guanine phosphoribosyltransferase, 16.47  
*Xba*I  
   7-deaza-dGTP modified DNA, cleavage of, 8.60  
   cleavage at end of DNA fragments, A6.4  
   *dam* methylation and, 13.87, A4.3  
   fragment size created by, table of, A4.8  
   linker sequences, 1.99  
   site frequency in human genome, 4.16, A6.3  
   terminal/subterminal site cleavage, inefficient, 8.38  
*Xcm*I for T vector creation, 8.35  
*Xenopus* oocytes, 11.68, 11.75–11.76, 11.78  
   controls, experimental, 11.70  
   vector systems for, 11.72  
 X-gal, 1.27, 17.97, 17.99  
    $\alpha$ -complementation and, 1.150  
   direct addition to plates, 1.125  
   in histochemical stain, 16.13  
   history of, 1.150  
   in  $\lambda$  vector plaque-assay, 2.30  
   protocol for use in screening colonies, 1.123–1.125, 1.150  
   recipe, A1.29  
   in two-hybrid system of protein-protein interaction study, 18.24–18.25, 18.36–18.37  
   use in pUC vectors, 1.10  
   use with M13 vectors, 3.8, 3.19, 3.38  
   in yeast selective X-gal medium, 18.18, 18.31, 18.40  
 X-gal indicator plates for yeast, A2.10–A2.11  
 X-gal plates for lysed yeast cells on filters, A2.11  
 X-GlcA (5-bromo-4-chloro-3-indolyl- $\beta$ -D-glucuronide), 16.42  
*Xho*I  
   cDNA adaptors and, 11.51  
   cDNA protection against, 11.40  
   cleavage at end of DNA fragments, A6.4  
   fragment size created by, table of, A4.8  
   genomic DNA mapping, 5.69  
   linker sequences, 1.99  
   methylation, A4.7  
   regeneration of site, 1.100  
   site frequency in human genome, 4.16, A6.3  
   terminal/subterminal site cleavage, inefficient, 8.38  
*Xho*II, *dam* methylation and, 13.87, A4.3  
 XL1-Blue *E. coli* strain, 11.23–11.25, 11.61–11.62, 11.66, 14.6  
   genotype, A3.9–A3.10  
    $\lambda$  vector propagation, 2.29  
   for M13, 12.21, 12.23  
   M13 vectors and, 3.12, 3.16, 3.18  
   phagemids and, 3.42, 3.46  
 XL1-Blue MRF' *E. coli* strain, 11.25  
   in circular mutagenesis protocol, 13.25  
   genotype, A3.10  
   M13 vectors and, 3.13



- phagemids and, 3.42, 3.46
- M11-Blue MRF<sup>+</sup> Kan strain, 3.18
- NamI*, A4.7, A6.4
- NamL*, A4.9
- NorI*, A4.7
- NS101 *E. coli* strain
  - M13 vectors and, 3.13
  - phagemids and, 3.42
- NS127 *E. coli* strain
  - genotype, A3.10
  - M13 vectors and, 3.12
  - phagemids and, 3.42
- ascA* gene, 7.86
- ascB* gene, 7.86
- wh* gene of *E. coli*, 13.73
- Xylene cyanol FF
  - in agarose gel electrophoresis gel-loading buffers, 1.53, 5.9
  - in denaturing agarose gels, 7.23
  - in formaldehyde gel-loading buffer, 7.32
  - in formamide dye mix, 7.77, 17.6
  - inhibition of PCR by, 8.13
  - migration rate through polyacrylamide gels, 12.89
  - oligonucleotide size and comigration in polyacrylamide, 10.15
  - polyacrylamide gel electrophoresis, 5.42, 7.57
  - in RNA gel-loading buffer, 7.68
  - in sucrose dye solution, 17.14
  - Taq* polymerase inhibition by, 1.53
- Y1089 *E. coli* strain, 15.19
  - for fusion protein expression, 14.39, 14.48
  - genotype, A3.10
- Y1090 *E. coli* strain, 15.19
- Y1090*ΔsIR* *E. coli* strain, 11.59–11.60, 11.62, 11.66, 14.6, 14.27
  - for fusion protein expression, 14.37, 14.39, 14.42, 14.45, 14.47–14.48
  - genotype, A3.10
  - $\lambda$  vector propagation, 2.28
- Y1090(Z1) *E. coli* strain, 11.61–11.62, 11.66
- YAC. See Yeast artificial chromosomes (YACs)
- YCp (yeast centromere plasmid), A3.5
- Yeast. See also *Saccharomyces cerevisiae*; Yeast artificial chromosomes
  - carrier tRNA, 5.20
  - DNA
    - isolation, rapid protocol, 6.31–6.32
    - preparation for pulsed-field gel electrophoresis, 5.65–5.67
  - gene expression patterns and microarray technology, A10.2
  - genomic resources for microarrays, A10.6
  - lysis buffer, 5.66
  - media, 4.65
  - media for the propagation and selection of, A2.9–A2.11
  - resuspension buffer, A1.22
  - screening colonies by PCR, 8.75
  - selective X-gal medium, 18.18, 18.31, 18.40
  - splice sites database, A11.20
  - tRNA as carrier in ethanol precipitation of DNA, A8.13
  - vectors, A3.4
- Yeast artificial chromosomes (YACs), 4.58–4.73, A3.4
  - arrayed libraries, 4.8
  - CEPH Mega YAC Library, 4.9
  - chimeric clones, 4.10, 4.62
    - detection of, 4.61
    - frequency of, 4.62
  - choosing for genomic library construction, 4.7–4.10
  - DNA preparation, 4.67–4.71
    - small-scale, 4.70–4.71
  - features of, 4.58–4.60
  - genomic libraries
    - characterization, 4.61
    - construction, 4.60
    - mapping inserts, 4.63
    - rescuing termini of genomic DNAs, 4.63
    - screening, 4.61–4.62
    - subcloning from, 4.64
  - growth of cultures from, 4.64–4.66
  - insert size, 4.61
  - instability and rearrangement, 4.61–4.62
  - overview, 4.2, 4.58
  - PCR analysis of yeast colonies, 4.72–4.73
  - preparation for pulsed-field gel electrophoresis, 5.65–5.67
  - problems with, 4.61–4.63
  - purification, 4.62–4.63
  - retrofitting with selectable marker, 4.63–4.64
  - screening recombinants, 4.60
  - stability of cloned sequences, 4.10
  - storage of yeast cultures, 4.66
  - subcloning inserts from, 4.64
  - transformation, 4.60, 4.63–4.64
- YEp (yeast episomal plasmid), A3.5
- Yip (yeast integrating plasmid), A3.5
- YK537 *E. coli* strain, 15.37, A3.10
- YPD medium, 4.65, 18.18, A2.11
- YRp (yeast replicating plasmid), A3.5
- YT medium recipe, A2.4
- Z gene,  $\lambda$ , 2.15
- ZAP Express vector, 2.23
- Zeo<sup>R</sup> (Zeocin), 17.74, 18.14, 18.19
- Zygosaccharomyces*, 4.85
- Zymolyase, 4.60, 5.66–5.67, 18.39, 18.41, A1.8

*When I look at the flight of the leaves*

*When I look at the flight of the leaves in  
their floating down on to the paving of cobbles  
and see them swept up as if by an  
artist who has finished his picture at last*

*I think how (already nobody likes either  
the way I stand, or my thoughtful face)  
a manifestly yellow, decidedly  
rusty leaf – has been left behind on the tree.*

MARINA TSVETAeva